



## Main

Range of product	OsiSense XU
Series name	General purpose multimode
Electronic sensor type	Photo-electric sensor
Sensor name	XUK
Sensor design	Compact 50 x 50
Detection system	Multimode
Material	Plastic
Type of output signal	Discrete
Supply circuit type	DC
Wiring technique	3-wire
Discrete output type	PNP or NPN
Discrete output function	1 NO or 1 NC programmable
Electrical connection	Cable
Cable length	16.4 ft (5 m)
Product specific application	-
Emission	Infrared diffuse Infrared diffuse with background suppression Infrared thru beam Red polarised reflex
[Sn] nominal sensing distance	0.92 ft (0.28 m) diffuse with background suppression 2.62 ft (0.8 m) diffuse 13.12 ft (4 m) polarised reflex need reflector XUZC50 98.43 ft (30 m) thru beam need a transmitter XUK0AKSAL5T

## Complementary

Enclosure material	PBT
Lens material	PMMA
Maximum sensing distance	114.83 ft (35 m) thru beam 0.92 ft (0.28 m) diffuse with background suppression 3.94 ft (1.2 m) diffuse 18.7 ft (5.7 m) polarised reflex
Output type	Solid state
Add on output	With alarm output, <= 50 mA with overload and short-circuit protection
Wire insulation material	PvR
Status LED	1 LED (green) supply 1 LED (red) instability 1 LED (yellow) output state
[Us] rated supply voltage	12...24 V DC with reverse polarity protection
Supply voltage limits	10...36 V DC
Switching capacity in mA	<= 100 mA (overload and short-circuit protection)
Switching frequency	<= 250 Hz
Voltage drop	<= 1.5 V (closed state)
Current consumption	<= 35 mA (no-load)
Delay first up	< 200 ms
Delay response	< 2 ms
Delay recovery	< 2 ms
Setting-up	Self-teaching
Depth	1.97 in (50 mm)
Height	1.97 in (50 mm)

The information provided in this documentation contains general descriptions and/or technical characteristics of the performance of the products contained herein. This documentation is not intended as a substitute for and is not to be used for determining suitability or reliability of these products for specific user applications. It is the duty of any such user or integrator to perform the appropriate and complete risk analysis, evaluation and testing of the products with respect to the relevant specific application or use thereof. Neither Schneider Electric Industries SAS nor any of its affiliates or subsidiaries shall be responsible or liable for misuse of the information contained herein.

Width	0.71 in (18 mm)
Product weight	0.39 lb(US) (0.175 kg)

## Environment

product certifications	CE CSA UL
ambient air temperature for operation	-13...131 °F (-25...55 °C)
ambient air temperature for storage	-40...158 °F (-40...70 °C)
vibration resistance	7 gn, amplitude = +/- 1.5 mm (f = 10...55 Hz) conforming to IEC 60068-2-6
shock resistance	30 gn (duration = 11 ms) conforming to IEC 60068-2-27
IP degree of protection	IP65 double insulation conforming to IEC 60529

## Offer Sustainability

Not Green Premium product	Not Green Premium product
Compliant - since 0903 - Schneider Electric declaration of conformity	Compliant - since 0903 - Schneider Electric declaration of conformity
Available	Available
Available	Available
WARNING: This product can expose you to chemicals including:	WARNING: This product can expose you to chemicals including:
Diisononyl phthalate (DINP), which is known to the State of California to cause cancer, and	Diisononyl phthalate (DINP), which is known to the State of California to cause cancer, and
Di-isodecyl phthalate (DIDP), which is known to the State of California to cause birth defects or other reproductive harm.	Di-isodecyl phthalate (DIDP), which is known to the State of California to cause birth defects or other reproductive harm.
For more information go to <a href="http://www.p65warnings.ca.gov">www.p65warnings.ca.gov</a>	For more information go to <a href="http://www.p65warnings.ca.gov">www.p65warnings.ca.gov</a>

## Contractual warranty

Warranty period	18 months
-----------------	-----------

## Dimensions

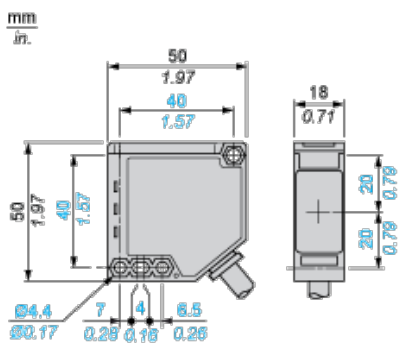

## Wiring Schemes

### PNP Output

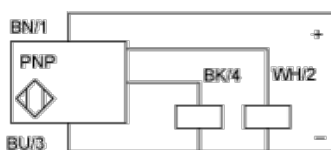

(+) Brown

BN :

(-) Blue

BU :

(OUT/Output)Black

BK :

(Alarm)White

WH :

### NPN Output

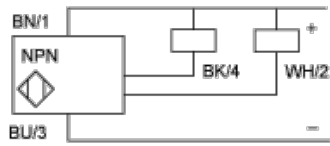

(+) Brown

BN :

(-) Blue

BU :

(OUT/Output)Black

BK :

(Alarm)White

WH :

## Detection Curves

### With Thru-beam Accessory (Thru-beam)

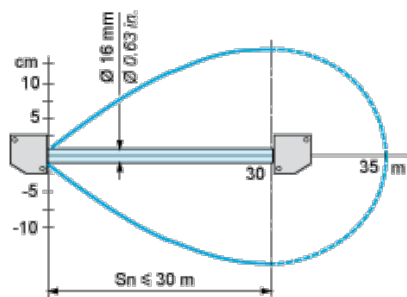

### Without Accessory (Diffuse)

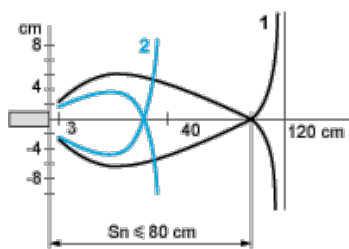

1 : White 90%

2 : Grey 18%

Object 10 x 10 cm

### Without Accessory (Diffuse with background suppression)

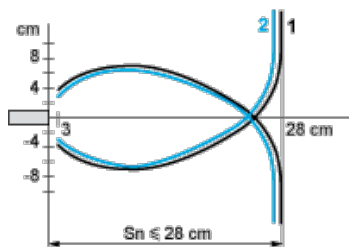

1 : White 90%

2 : Grey 18%

Object 10 x 10 cm

### With reflector (Polarised reflex)

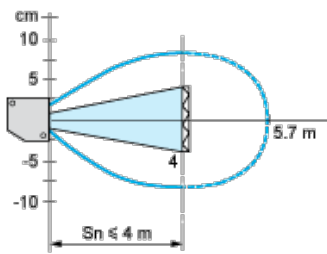

With reflector XUZC50

**Variation of Usable Sensing Distance  $S_u$  (Without accessory, with adjustable background suppression)**

**Teach Mode at Minimum**

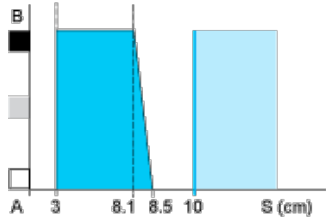

**Teach Mode at Maximum**

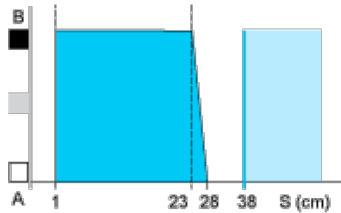

- (1) Black
- (2) Grey
- (3) White
- (4) Sensing range
- (5) Non sensing zone (matt surfaces)

A-B :Object reflection coefficient

- (1) Black 6%
- (2) Grey 18%
- (3) White 90%
- (4) Sensing range
- (5) Non sensing zone (matt surfaces)

## Данный компонент на территории Российской Федерации

### Вы можете приобрести в компании MosChip.

Для оперативного оформления запроса Вам необходимо перейти по данной ссылке:

<http://moschip.ru/get-element>

Вы можете разместить у нас заказ для любого Вашего проекта, будь то серийное производство или разработка единичного прибора.

В нашем ассортименте представлены ведущие мировые производители активных и пассивных электронных компонентов.

Нашей специализацией является поставка электронной компонентной базы двойного назначения, продукции таких производителей как XILINX, Intel (ex.ALTERA), Vicor, Microchip, Texas Instruments, Analog Devices, Mini-Circuits, Amphenol, Glenair.

Сотрудничество с глобальными дистрибьюторами электронных компонентов, предоставляет возможность заказывать и получать с международных складов практически любой перечень компонентов в оптимальные для Вас сроки.

На всех этапах разработки и производства наши партнеры могут получить квалифицированную поддержку опытных инженеров.

Система менеджмента качества компании отвечает требованиям в соответствии с ГОСТ Р ИСО 9001, ГОСТ РВ 0015-002 и ЭС РД 009

### Офис по работе с юридическими лицами:

105318, г.Москва, ул.Щербаковская д.3, офис 1107, 1118, ДЦ «Щербаковский»

Телефон: +7 495 668-12-70 (многоканальный)

Факс: +7 495 668-12-70 (доб.304)

E-mail: [info@moschip.ru](mailto:info@moschip.ru)

Skype отдела продаж:

moschip.ru

moschip.ru\_4

moschip.ru\_6

moschip.ru\_9