



Expertise Applied | Answers Delivered



POWR-GARD® PRODUCTS CATALOG



POWR-GARD PRODUCTS

Indicating Fuses • Blocks & Holders • Relays & Controls • MOVs • Medium Voltage Fuses

Littelfuse® POWR-GARD® — Protecting People and Equipment

As the global leader in circuit protection, Littelfuse has extensive experience in helping customers improve their electrical systems and the safety of their installations. Offering more than well-designed products, our technical expertise brings years of experience and product design support to your application.

Littelfuse can provide immediate access to specialized technical resources, online references or application support in the field. This catalog outlines the Littelfuse POWR-GARD industrial circuit protection products and the technical capabilities we offer for your application.

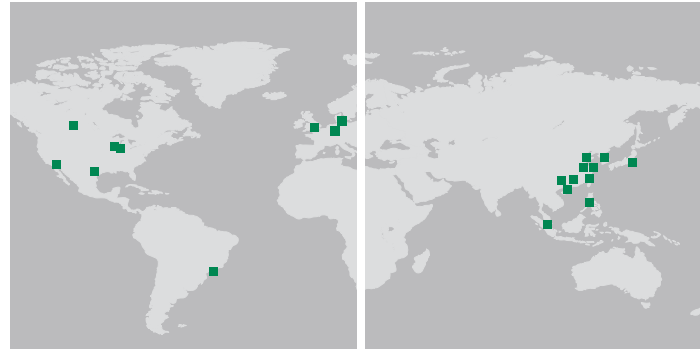

Littelfuse App!

Download our free Littelfuse Catalogs and Literature App to keep our products and technical resources at your finger tips!



A Broad Portfolio of Circuit Protection Products, Relays and Controls

Fuses & Holders

- Fuses and Fuse Holders
- Medium Voltage Fuses
- Indicating Products
- Up-LINK™ Remote Indication
- OEM Custom Products

Relays & Controls

- Ground Fault Protection
- Trailing Cable Protection
- Resistance Grounding
- Motor & Pump Protection
- Arc-Flash Protection
- Generator Control
- Engine Control & Diagnosis
- Custom Products

Safety Resources

- Datasheets
- White Papers
- Online Library
- Training Videos
- Technical Articles
- High Power Test Lab

| | |
|--|---|
| <p>1 Fuses</p> <ul style="list-style-type: none"> Class L Fuses 9 Class RK1 Fuses 14 Class RK5 Fuses 17 Class K/H Fuses 21 Class J Fuses 23 Class T Fuses 26 Class G Fuses 28 Class CC/CD Fuses 29 UL Supplemental/10 x 38 Fuses 32 <p>2 Automotive Blade & Electronic Fuses</p> <ul style="list-style-type: none"> Glass/Electronic Fuses 35 Automotive/Blade Fuses 38 <p>3 Medium Voltage Fuses</p> <ul style="list-style-type: none"> Medium Voltage Fuses Overview 41 R-Rated Medium Voltage Fuses 43 E-Rated Medium Voltage Fuses 44 <p>4 Telecommunication Fuses</p> <ul style="list-style-type: none"> Telecommunications Power Fuses 52 Telecommunications Disconnect Switch 56 <p>5 Special Purpose Fuses</p> <ul style="list-style-type: none"> Solar Products Overview 58 Solar Rated Fuses 60 Forklift/Stud Mounted Fuses 62 Plug Fuses 63 MEGA® Bolt-Down Fuses 63 In-Line Fuses & Holders 64 Cable Limiters 65 L Series (Traditional) Semiconductor Fuses 66 LA Series (Alternate Dimension) Semiconductor Fuses 68 Square Body Semiconductor Fuses 74 OEM Custom Products 79 <p>6 Fuse Blocks & Holders</p> <ul style="list-style-type: none"> LF Series Fuse Blocks Overview 81 Class J Fuse Blocks 83 Class H/K5 & R Fuse Blocks 86 Class T Fuse Blocks 92 Class G Fuse Blocks 97 Class CC/CD & Midget Fuse Blocks 99 LF Series Fuse Block Covers 103 LFJ Solar Rated Fuse Block 104 Dead Front Fuse Holders 107 Miscellaneous Fuse Blocks & Holders 114 Semiconductor Fuse Blocks 120 Distribution & Splicer Blocks 122 In-Line Fuse Holders 131 | <p>7 Pre-Engineered Solutions</p> <ul style="list-style-type: none"> LCP Fused Selective Coordination Panel 140 LPS Series POWR-Switch (Shunt Trip Disconnect) 142 LPMP Series POWR-Switch Panel 144 Specifier Tool for LCP Coordination Panel 146 <p>8 Protection Relays & Controls</p> <ul style="list-style-type: none"> Relay & Control Products Overview 148 Feature Comparisons 150 Ground-Fault Protection 152 Trailing Cable Protection 155 Resistance Grounding & NGR Monitoring 156 Motor Protection 158 Pump & Feeder Protection 160 Arc-Flash Protection & GFCI 161 Generator & Single-Function Protection 162 Generator Control 167 Engine Control & Diagnosis 171 Alarm Monitoring 172 Custom Products 174 Relay & Control Accessories 175 <p>9 Suppression Products</p> <ul style="list-style-type: none"> Industrial Varistor Products 177 Surge Suppression Fuses 179 <p>10 International Products</p> <ul style="list-style-type: none"> NH Fuse Links 181 Cylindrical Fuses 183 <p>11 Miscellaneous Accessories</p> <ul style="list-style-type: none"> Fuse Reducers 185 Box Cover Units 186 Fuse Display & Cabinet 187 <p>12 Technical Application Guide</p> <ul style="list-style-type: none"> Fuseology Fundamentals 189 Selection Considerations 191 Time-current Curves & Peak Let-through Charts 195 Selective Coordination 198 UL/CSA Fuse Classes & Applications 200 Electrical Safety Guide 202 Terms & Definitions 204 Motor Protection Tables 211 Alphanumeric Index of Catalog Numbers 214 Condensed Fuse Cross Reference 216 |
|--|---|



UL FUSE CLASSES AND SELECTION CHART

| UL CLASS | LITTELFUSE SERIES | OVERLOAD CHARACTERISTICS | AC RATINGS | | | DC RATINGS | | | RECOMMENDED FUSE BLOCKS AND FUSE HOLDERS | FUSE SERIES PAGE NUMBERS |
|-------------------------------|----------------------|---------------------------------|-----------------|----------------------|------------------------|---------------------------------|---|--|---|--------------------------|
| | | | VOLTAGE (VOLTS) | CURRENT (AMPERES) | INTERRUPTING (AMPERES) | VOLTAGE (VOLTS) | CURRENT (AMPERES) | INTERRUPTING (AMPERES) | | |
| L | KLPC | Time-Delay | 600 | 200 - 6000 | 200K / 300K* | 480 | 200 - 6000 | 20,000 | - | 9 |
| | KLLU | | | 601 - 4000 | 200,000 | - | - | - | | 10 |
| | LDC | | | 150 - 2000 | 200,000 | 600 | 150 - 2000 | 50,000 | | 11 |
| RK1 | LLNRK | Time-Delay | 250 | 0.1 - 600 | 200K / 300K* | 125 | 0.1 - 600 | 20,000 | LFR25 | 14 |
| | L LSRK_ID | Time-Delay | 600 | 0.1 - 600 | | 300 | 0.1 - 600 | | LFR60 | 14 |
| | LLSRK | Time-Delay | 600 | 0.1 - 600 | | 300 | 0.1 - 600 | | LFR60 | 14 |
| | KLNR | Fast-Acting | 250 | 1 - 600 | 125 | 1 - 600 | LFR25 | | 15 | |
| | KLSR | Fast-Acting | 600 | 1 - 600 | 200,000 | 250 300 | 1 - 30 35 - 600 | | LFR60 | 15 |
| RK5 | FLNR_ID | Time-Delay | 250 | 35 - 600 | 200K / 300K* | 125 | 35 - 600 | 20,000 | LFR25 | 18 |
| | FLNR | | 250 | 0.1 - 600 | | 125 | 0.1 - 30 | | LFR25 | 18 |
| | FLSR_ID | | 600 | 0.1 - 600 | | 300 | 0.1 - 600 | | LFR60 | 18 |
| | FLSR | | 600 | 0.1 - 600 | | 300 | 0.1 - 600 | | LFR60 | 18 |
| | IDSR | | 600 | 0.1 - 600 | | 600 | 0.1 - 600 | | LFR60 | 17 |
| J | JTD_ID | Time-Delay | 600 | 0.8 - 600 | 200K / 300K* | 300 | 0.8 - 100 | 20,000 | LFJ60 • LFPSJ | 23 |
| | JTD | Time-Delay | 600 | 0.8 - 600 | | 500 | 110 - 600 | | | 23 |
| | JLS | Fast-Acting | 600 | 1 - 600 | | 200,000 | - | | | - |
| T | JLLN | Fast-Acting | 300 | 1 - 1200 | 200,000 | 125 160 125 | 1 - 30 35 - 60 110 - 1200 | 20,000 | LFT30 • LSCR002 (700-800A) | 26 |
| | JLLS | | 600 | 1 - 1200 | | 300 | 1 - 1200 | | LFT60 • LSCR002 (700-800A) | 26 |
| CC | CCMR | Time-Delay | 600 | 0.2 - 30 | 200K / 300K* | 250 250 300 500 | 0.2 - 2 4.5 - 10 2.25 - 4 12 - 30 | 20,000 | L60030C • LPSC • LINK00_C • 571 • 572 • LEC • LEY | 29 |
| | KLDR | Time-Delay | 600 | 0.1 - 30 | 200,000 | 300 | 0.1 - 30 | | 30 | |
| | KLKR | Fast-Acting | 600 | 0.1 - 30 | 200,000 | 300 | 0.1 - 30 | | 30 | |
| CD | CCMR | Time-Delay | 600 | 35 - 60 | 200K / 300K* | 250 | 35 - 60 | 20,000 | LFC60060 | 29 |
| G | SLC | Time Lag | 600 | 0.2 - 20 | 100,000 | - | - | - | LFG480 (1 - 20A) | 28 |
| | | | 480 | 25 - 60 | | | | | LFG480 (25 - 60A) | |
| H | NLKP | Non-Renewable | 250 | 15 - 60 | 10,000 | - | - | - | LFH25 | 21 |
| | RLN | Renewable | 250 | 1 - 600 | | | | | LFH60 | 22 |
| | RLS | Renewable | 600 | 1 - 600 | | | | | LPHV • LFPHV | 60 |
| Solar | SPF | Solar | - | - | - | 1000 | 1 - 30 | 20,000 | LPHV • LFPHV | 60 |
| | SPFJ | Solar | - | - | - | 1000 | 125 - 450 | 20K (125 - 200A) 10K (250 - 400A) 20K (400A) | LFJ1000 | 61 |
| K5 | NLN | Fast-Acting | 250 | 1 - 600 | 50,000 | 250 | 1 - 600 | 20K (125 - 200A) 10K (250 - 400A) 20K (400A) | LPHV • LFPHV | 60 |
| | NLS | | 600 | 1 - 600 | | 600 500 400 600 500 | 1 - 7 8 - 30 35 - 60 70 - 200 225 - 600 | 20K (1 - 60A) 50K (70 - 600A) | LFH25 | 21 |
| Semiconductor | L15S | Fast-Acting | 150 | 1 - 1000 | 200,000 | 150 100 | 1 - 60 70 - 1000 | 20,000 | LSCR • ILS (except L70S) | 66 |
| | L25S | | 250 | 1 - 800 | | 250 400 | 1 - 200 225 - 800 | | | 66 |
| | L50S | | 500 | 10 - 800 | | 450 | 10 - 800 | | | 66 |
| | L60S | | 600 | 1 - 800 | | - | - | | | 66 |
| | L70S | | 700 | 10 - 800 | | 650 | 6 - 800 | | | 66 |
| Midget (Supplementary) | BLF | Fast-Acting | 250 125 | 0.5 - 15 20 - 30 | 10,000 | - | - | - | L60030M • LPSM • LINK00_M • 571 • 572 • LEB • LEX | 32 |
| | BLN | Fast-Acting | 250 | 1 - 30 | 10,000 | - | - | - | | 32 |
| | BLS | Fast-Acting | 600 250 | 0.2 - 5 6 - 10 | 10,000 | - | - | - | | 33 |
| | FLA | Time-Delay | 125 | 0.1 - 30 | 10,000 | - | - | - | | 33 |
| | FLM | Time-Delay | 250 | 0.1 - 30 | 10,000 | 125 | 0.1 - 30 | 10,000 | | 32 |
| | FLQ | Time-Delay | 500 | 0.1 - 30 | 10,000 | 300 | 0.1 - 30 | 10,000 | | 32 |
| | KLK | Fast-Acting | 600 | 0.1 - 30 | 100K / 200K* | 500 | 0.1 - 30 | - | | 32 |
| | KLKD | Fast-Acting | 600 | 0.1 - 30 | 100,000 | 600 | 0.1 - 30 | 50,000 | | 32 |
| KLQ | Time-Delay | 600 | 1 - 6 | 10,000 | - | - | - | 33 | | |
| Plug | FLU | Fast-Acting | 1000 | 0.44 11 | 10,000 20,000 | 1000 | 0.44 11 | 10,000 20,000 | LPHV • LFPHV | 33 |
| | S00, T00 SLO, TLO | Time-Delay Medium Time-Delay | 125 | 0.25 - 30 15 - 30 | 10,000 10,000 | - | - | - | SAO (S00 & SLO) | 63 |
| Telecom | L17T | Fast-Acting | - | - | - | 170 | 70 - 1200 | 100,000 | LTFD6001 • LTFD1200 | 52 |
| | TLN | | - | - | - | | 1 - 600 | | LFR25 | 53 |
| | TLS | | - | - | - | | 1 - 125 | | LTFD • LFT30060 (cartridge) | 54 |

* Series are UL Listed with I.R. of 200,000A and Littelfuse® self-certified with 300,000A I.R.

Littelfuse POWR-GARD® – Advanced Protection and Facility Savings



POWR-PRO®

Increase safety with POWR-PRO® Fuses

- Superior current-limitation from 1/10 – 6000 amperes
- Type 2 “No Damage” coordination with NEMA and IEC motor circuits
- Blown fuse indication (LLSRK_ID and JTD_ID Series)
- Compact motor protection (JTD/JTD_ID, CCMR Series)
- 300,000 AIR to meet trends toward higher SCCR

POWR-PRO® Look for the POWR-PRO® logo for superior protection

| UL FUSE CLASS | POWR-PRO® | PAGE NUMBERS |
|---------------|----------------|--------------|
| Class L | KLPC & LDC | 9, 11 |
| Class RK1 | LLNRK/LLSRK_ID | 14 |
| Class J | JTD/JTD_ID | 23 |
| Class CC / CD | CCMR (2/10–60) | 29 |

MRO™ PLUS

Material Reduction Opportunity Program

Increase safety and reduce inventory with MROplus

Your detailed reports will include:

- A streamlined current-limiting fuse inventory recommendation
- A guide to reducing electrical hazards within your facility
- An annual cost savings estimate
- A detailed cross reference

All you need to do is e-mail an Excel file of your fuse inventory to techline@littelfuse.com or to your local sales representative. We will do the rest!

Solar Circuit Protection for Today's Evolving Technologies



POWR-GARD® SOLAR RATED PRODUCTS

This catalog incorporates our line of products designed specifically for the growing solar industry. As global standards are constantly changing, Littelfuse continues to develop circuit protection products that meet the requirements of the evolving photovoltaic market.

High-voltage solar products

| | |
|--------------------------------------|-----|
| SPF Series 1000 VDC Solar Fuse | 60 |
| SPFJ Series 1000 VDC Solar Fuse..... | 61 |
| LFJ Fuse Holder | 104 |
| LFPHV Fuse Holder..... | 112 |

Other circuit protection products used in solar applications

| | |
|----------------------------------|-----|
| LDC Series Class L Fuse..... | 11 |
| IDSR Class RK5 Fuse | 17 |
| KLKD 10 x 38 Midget Fuse | 32 |
| Up-LINK™ Fuse Holder..... | 107 |
| POWR-Bar Bus Bar System..... | 110 |
| SE-601 DC Protection Relay | 152 |



Look for this logo to indicate products that are used in solar applications. Visit our website www.littelfuse.com/solar for the latest updates on approvals, certifications, and new products.

A Full Range of Protection Relays & Controls for the Harshest Environments



PROTECTION RELAYS & CONTROLS

Now Offering a Complete Portfolio of Generator Controls, Alarm Panels and Protection Relays

Littelfuse has been protecting electrical systems for 85 years. Our protection relays and controls are used in the world's leading oil-sands operations, offshore platforms, refineries, processing plants and other industrial facilities. Our tested and proven products are only part of the value we provide. What truly sets us apart are our experienced professional engineers who understand the unique requirements and conditions of your application.

For more information on how our deep technical expertise, broad portfolio of products and global resources can help you with your unique application needs, please contact us

www.littelfuse.com/relayscontrols
800-832-3873.

| | |
|--|-----|
| Ground-Fault Protection | 148 |
| Trailing Cable Protection..... | 151 |
| Resistance Grounding and NGR Monitoring | 152 |
| Motor Protection | 154 |
| Feeder and Pump Protection | 156 |
| Arc-Flash Protection and GFCI | 157 |
| Generator and Single-Function Protection | 158 |
| Generator Control..... | 163 |
| Engine Control and Diagnosis | 167 |
| Alarm Monitoring | 168 |
| Custom Products..... | 170 |
| Accessories | 160 |

Meet NEC® Requirements and Save Time with Littelfuse Pre-Engineered Solutions



LCP Series Coordination Panel

Ideal for circuits that require selective coordination such as emergency lighting circuits or essential electrical systems.

See page 140

LPS Series POWR-Switch

Individual fusible shunt trip disconnect switch easily coordinates with system's overcurrent protection. Typical applications include elevator circuits.

See page 142

LPMP Series POWR-Switch Panel

Fusible panel board with shunt trip capabilities for the control of power to a bank of equipment. Typical applications include elevator circuits.

See page 144

www.littelfuse.com

All the Information You Need in One Convenient Place



Comprehensive Product Literature

- Datasheets, product catalogs, and brochures for the full Littelfuse line
- Comparison chart and cross reference
- Space-savings calculator
- Agency certifications
- Product dimensions
- Application notes and white papers

In-Depth Technical Information

- Detailed specifications
- CAD drawings
- Downloadable 2-D .dxf and 3-D .igs files
- Comparison chart and cross reference
- Line drawings
- Time current and peak let-through curves

Sales, Distribution and Customer Support

- Distributor listings
- Online inventory
- **800-TEC-FUSE** technical support hotline

Look on each catalog page for specific product web links to access additional technical information.

Section Overview

For over 85 years Littelfuse® has been providing fuses to the electrical market. You can continue to count on our manufacturing and supply chain processes to deliver high quality fuses when you need them. At Littelfuse we leverage our global reach to stay on top of the latest applications and standards. Whether your circuit protection needs are focused on OEM, MRO, or construction, we are committed to being your circuit protection partner and appreciate your business.

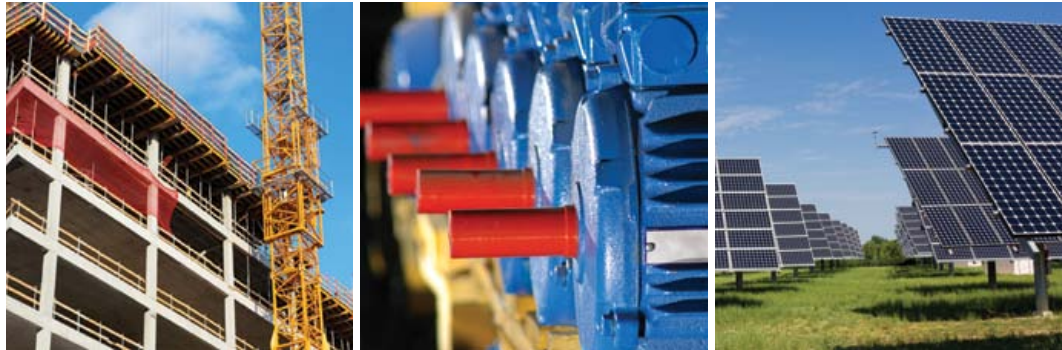

FUSES

Table of Contents

| | |
|------------------------|----|
| Class L | 9 |
| Class RK1 | 14 |
| Class RK5 | 17 |
| Class K/H | 21 |
| Class J | 23 |
| Class T | 26 |
| Class G | 28 |
| Class CC/CD | 29 |
| Midget (10x38mm) | 32 |

KLPC SERIES POWR-PRO® FUSES

POWR-PRO® 600 VAC • Time-Delay • 200-6000 A



1 Class L Fuses

Description

KLPC series POWR-PRO® fuses meet or exceed the most stringent project specifications, including silver links, silver-plated copper end bells, glass-reinforced melamine bodies, O-ring seals between body and end bells, and granular quartz fillers.

Applications

- Switchboard mains and feeders
- Motor control center mains
- Large motor branch circuits
- Protection of power circuit breakers

Features/Benefits

- POWR-PRO® Performance
- Best-in-class time-delay withstand
- Current-Limiting
- Easily coordinated with other system components
- 300 kA AC Interrupting Rating (self-certified)

Specifications

| | |
|-------------------------------|---|
| Voltage Ratings | AC: 600 V DC: 480 V |
| Interrupting Ratings | AC: 200 kA rms symmetrical 300 kA rms symmetrical (Littelfuse self-certified) DC: 20,000 A 200 – 6000 A |
| Ampere Range Approvals | AC: Standard 248-10, Class L UL Listed 601–6000 A (File No. E81895) UL Recognized 200–600 A (File No. E71611) CSA Certified 200–6000 A (File No. LR29862) Federal Specifications 700–6000 A (QPL-W-F-1814) DC: Littelfuse self-certified |

Ordering Information

| AMPERE RATINGS | | | | | |
|----------------|-----|------|------|------|------|
| 200 | 500 | 800 | 1350 | 2000 | 3000 |
| 250 | 600 | 900 | 1400 | 2100 | 3500 |
| 300 | 601 | 1000 | 1500 | 2200 | 4000 |
| 350 | 650 | 1100 | 1600 | 2300 | 4500 |
| 400 | 700 | 1200 | 1800 | 2400 | 5000 |
| 450 | 750 | 1300 | 1900 | 2500 | 6000 |

| SERIES | AMPERAGE | CATALOG NUMBER | ORDERING NUMBER |
|--------|----------|----------------|-----------------|
| KLPC | 800 | KLPC800 | KLPC800.X |

Web Resources

TC Curves, downloadable CAD drawings and other technical information: www.littelfuse.com/klpc

Dimensions

Please refer to Class L dimensions 13

Peak Let-Thru Curve

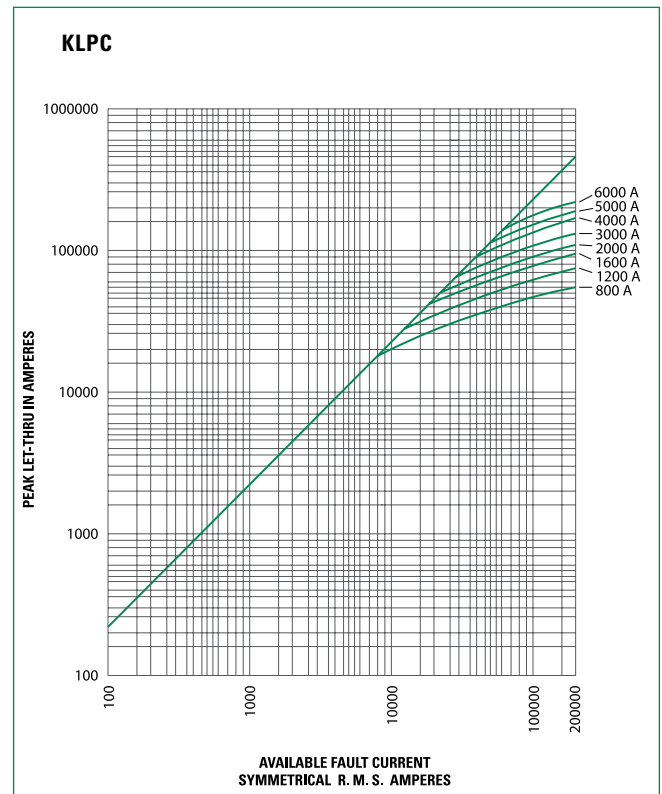

Note: For more information, see Peak Let-Thru Table on pg. 12

KLLU SERIES FUSES

600 VAC • Time-Delay • 601-4000 A



Class L Fuses 1



Description

KLLU series fuses meet or exceed UL requirements for UL Class L fuses. The KLLU series offers an economical alternative to KLPC POWR-PRO® fuse with a slightly higher peak let through current.

Applications

- Service switches
- Switchboard mains and feeders
- Motor control center mains
- Large motor branch circuits
- Circuit breaker protection

Features/Benefits

- Current-Limiting
- Easily coordinated with other system components
- 200 kA AC Interrupting Rating

Specifications

| | |
|-----------------------------|--|
| Voltage Ratings | AC: 600 V DC: 300 V |
| Interrupting Ratings | AC: 200 kA DC: 20 kA |
| Ampere Range | 601–4000 A |
| Approvals | Standard 248-10, Class L UL Listed (File No. E81895) CSA Certified (File No. LR29862) DC: Littelfuse self-certified |

Ordering Information

| AMPERE RATINGS | | | | | |
|----------------|-----|------|------|------|------|
| 601 | 750 | 1000 | 1400 | 1800 | 3000 |
| 650 | 800 | 1200 | 1500 | 2000 | 3500 |
| 700 | 900 | 1350 | 1600 | 2500 | 4000 |

| SERIES | AMPERAGE | CATALOG NUMBER | ORDERING NUMBER |
|--------|----------|----------------|-----------------|
| KLLU | 601 | KLLU601 | KLLU601.X |

Web Resources

TC Curves, downloadable CAD drawings and other technical information: www.littelfuse.com/kllu

Dimensions

Please refer to the Class L dimensions 13

Peak Let-Thru Curve

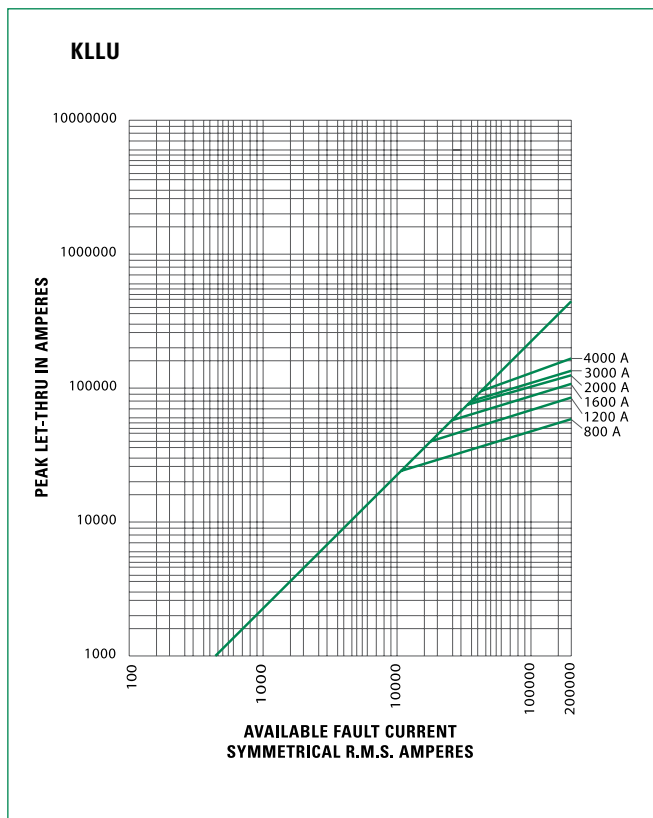

Note: For more information, see Peak Let-Thru Table on pg. 12

LDC SERIES POWR-PRO® FUSES

POWR-PRO® 600 V AC/DC • Time-Delay • 150-2000 A



1 Class L Fuses



Description

High DC voltage and interrupting ratings make the POWR-PRO® LDC ideal for DC applications. The DC interrupting performance exceeds UL listing requirements.

Applications

- Solar inverter and array protection
- UPS protection especially for large battery circuits
- DC distribution and variable speed drives
- Mass transit systems

Features/Benefits

- POWR-PRO® Performance
- Extremely Current-Limiting
- 600 V AC/DC rated
- 200 kA AC Interrupting Rating
- 50 kA DC Interrupting Rating

Specifications

| | |
|-----------------------------|--|
| Voltage Ratings | AC: 600 V DC: 600 V |
| Interrupting Ratings | AC: 200 kA rms symmetrical DC: 50 kA (16 millisecond time-constant) |
| Ampere Range | 150–2000 A |
| Approvals | Standard 248-10, Class L UL Listed 601–2000 A (File No. E81895) UL Recognized 150–600 A (File No. E71611) CSA Certified 150–2000 A (File No. LR29862) |

Ordering Information

| AMPERE RATINGS | | | | |
|----------------|-----|------|------|------|
| 150 | 450 | 750 | 1201 | 1601 |
| 200 | 500 | 800 | 1300 | 1800 |
| 250 | 600 | 900 | 1350 | 1900 |
| 300 | 601 | 1000 | 1400 | 2000 |
| 350 | 650 | 1100 | 1500 | |
| 400 | 700 | 1200 | 1600 | |

| SERIES | AMPERAGE | CATALOG NUMBER | ORDERING NUMBER |
|--------|----------|----------------|-----------------|
| LDC | 700 | LDC700 | 0LDC700.X |

Web Resources

TC Curves, downloadable CAD drawings and other technical information: www.littelfuse.com/ldc

Dimensions

Please refer to the Class L dimensions 13

Peak Let-Thru Curve

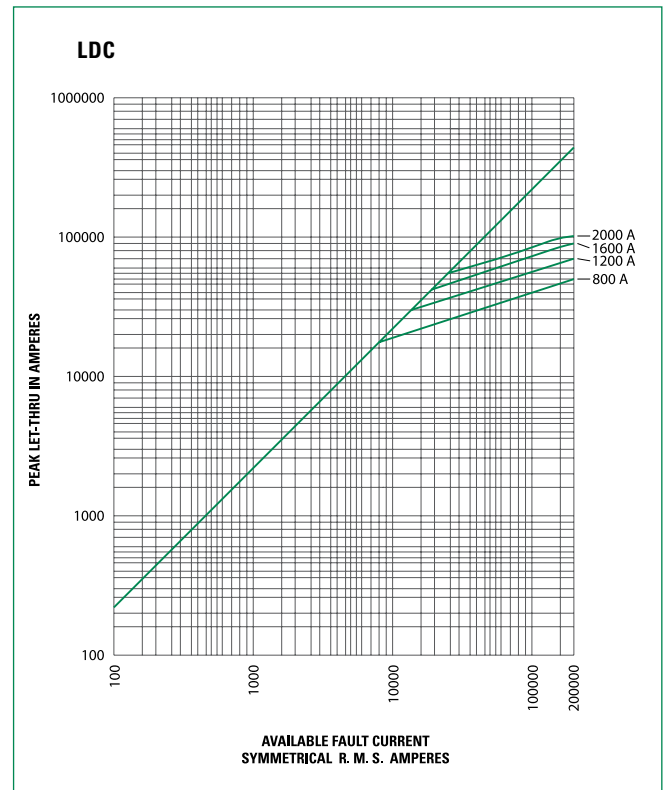

Note: For more information, see Peak Let-Thru Table on pg. 12

CLASS L CURRENT-LIMITING EFFECTS

Class L Fuses 1

Current-Limiting Effects of KLPC (600 V) Fuses

| SHORT CIRCUIT CURRENT* | APPARENT RMS SYMMETRICAL CURRENT FOR VARIOUS FUSE RATINGS | | | | | | | |
|------------------------|---|--------|--------|--------|--------|--------|--------|--------|
| | 800 A | 1200 A | 1600 A | 2000 A | 3000 A | 4000 A | 5000 A | 6000 A |
| 5,000 | 5,000 | 5,000 | 5,000 | 5,000 | 5,000 | 5,000 | 5,000 | 5,000 |
| 10,000 | 8,800 | 10,000 | 10,000 | 10,000 | 10,000 | 10,000 | 10,000 | 10,000 |
| 15,000 | 10,500 | 13,500 | 15,000 | 15,000 | 15,000 | 15,000 | 15,000 | 15,000 |
| 20,000 | 12,000 | 15,000 | 19,000 | 20,000 | 20,000 | 20,000 | 20,000 | 20,000 |
| 25,000 | 13,000 | 16,000 | 21,000 | 24,000 | 25,000 | 25,000 | 25,000 | 25,000 |
| 30,000 | 14,000 | 18,000 | 23,000 | 26,000 | 30,000 | 30,000 | 30,000 | 30,000 |
| 35,000 | 15,000 | 19,000 | 24,000 | 27,000 | 32,000 | 35,000 | 35,000 | 35,000 |
| 40,000 | 16,000 | 20,000 | 25,000 | 28,000 | 34,000 | 40,000 | 40,000 | 40,000 |
| 50,000 | 17,000 | 22,000 | 27,000 | 31,000 | 37,000 | 42,500 | 50,000 | 50,000 |
| 60,000 | 18,000 | 24,000 | 29,000 | 34,000 | 40,000 | 46,000 | 52,000 | 60,000 |
| 80,000 | 20,000 | 26,000 | 32,000 | 37,000 | 44,000 | 51,000 | 57,000 | 70,000 |
| 100,000 | 21,000 | 27,000 | 34,000 | 40,000 | 46,000 | 57,000 | 65,000 | 75,000 |
| 150,000 | 23,000 | 31,000 | 38,000 | 44,000 | 54,000 | 67,000 | 75,000 | 87,000 |
| 200,000 | 24,000 | 34,000 | 42,000 | 46,000 | 57,000 | 70,000 | 80,000 | 95,000 |

Current-Limiting Effects of KLLU (600 V) Fuses

| SHORT-CIRCUIT CURRENT* | APPARENT RMS SYMMETRICAL CURRENT FOR VARIOUS FUSE RATINGS | | | | | |
|------------------------|---|--------|--------|--------|--------|--------|
| | 800 A | 1200 A | 1600 A | 2000 A | 3000 A | 4000 A |
| 5,000 | 5,000 | 5,000 | 5,000 | 5,000 | 5,000 | 5,000 |
| 10,000 | 10,000 | 10,000 | 10,000 | 10,000 | 10,000 | 10,000 |
| 15,000 | 11,900 | 15,000 | 15,000 | 15,000 | 15,000 | 15,000 |
| 20,000 | 13,000 | 18,500 | 20,000 | 20,000 | 20,000 | 20,000 |
| 25,000 | 14,000 | 20,000 | 25,000 | 25,000 | 25,000 | 25,000 |
| 30,000 | 14,500 | 21,000 | 26,500 | 30,000 | 30,000 | 30,000 |
| 35,000 | 15,000 | 22,000 | 28,500 | 34,000 | 35,000 | 35,000 |
| 40,000 | 16,000 | 23,000 | 30,000 | 35,000 | 37,000 | 40,000 |
| 50,000 | 17,000 | 24,000 | 32,000 | 38,000 | 39,000 | 44,000 |
| 60,000 | 18,000 | 26,000 | 34,000 | 42,000 | 43,000 | 50,000 |
| 80,000 | 19,000 | 28,000 | 36,000 | 44,000 | 46,000 | 54,500 |
| 100,000 | 21,000 | 30,000 | 38,000 | 46,000 | 48,000 | 57,500 |
| 150,000 | 24,000 | 35,000 | 44,000 | 50,000 | 51,000 | 68,000 |
| 200,000 | 26,000 | 38,000 | 48,000 | 53,000 | 60,000 | 74,000 |

Current-Limiting Effects of LDC (600 V) Fuses

| SHORT CIRCUIT CURRENT* | APPARENT RMS SYMMETRICAL CURRENT FOR VARIOUS FUSE RATINGS | | | |
|------------------------|---|--------|--------|--------|
| | 800 A | 1200 A | 1600 A | 2000 A |
| 5,000 | 5,000 | 5,000 | 5,000 | 5,000 |
| 10,000 | 8,500 | 10,000 | 10,000 | 10,000 |
| 15,000 | 9,750 | 14,000 | 15,000 | 15,000 |
| 20,000 | 10,500 | 15,000 | 19,000 | 20,000 |
| 25,000 | 11,500 | 16,000 | 21,000 | 25,000 |
| 30,000 | 12,000 | 17,000 | 22,000 | 26,000 |
| 35,000 | 12,500 | 18,000 | 23,000 | 28,000 |
| 40,000 | 13,500 | 19,000 | 24,000 | 30,000 |
| 50,000 | 14,000 | 21,000 | 26,000 | 32,000 |
| 60,000 | 15,000 | 22,000 | 28,000 | 34,000 |
| 80,000 | 16,000 | 24,000 | 30,000 | 36,000 |
| 100,000 | 18,000 | 25,000 | 33,000 | 40,000 |
| 150,000 | 20,000 | 30,000 | 38,000 | 44,000 |
| 200,000 | 23,000 | 32,000 | 41,000 | 46,000 |

*Prospective RMS Symmetrical Amperes Short-Circuit Current
 Note: Data derived from Peak Let-Thru Curves

CLASS L SERIES DIMENSIONS

Dimensions

| AMPERES | FIG. NO. | DIMENSIONS INCHES (mm) | | | | | | | | | | | | | |
|-----------|----------|---|--|--|--|--|---|---|---|--|--|--|--|--|--|
| | | A | B | C | D | E | F | G | H | J | K | L | M | N | |
| 200-800 | 1 | 3 ³ / ₄ (95.3) | 5 ³ / ₄ (146.1) | 6 ³ / ₄ (171.5) | — | — | 8 ⁵ / ₈ (219.1) | — | — | 2 (50.8) | 2 ¹ / ₂ (63.5) | 3 ³ / ₈ (9.5) | 5 ⁵ / ₈ x 1 ¹ / ₈ (15.9) x (28.6) | — | |
| 900-1200 | 2 | 3 ³ / ₄ (95.3) | 5 ³ / ₄ (146.1) | 6 ³ / ₄ (171.5) | 9 ¹ / ₄ (235.0) | 9 ¹ / ₂ (241.3) | 10 ³ / ₄ (273.1) | — | — | 2 (50.8) | 2 ¹ / ₂ (63.5) | 3 ³ / ₈ (9.5) | 5 ⁵ / ₈ x 3 ³ / ₄ (15.9) x (19.1) | 5 ⁵ / ₈ x 1 ¹ / ₈ (15.9) x (28.6) | |
| 1300-1600 | 2 | 3 ³ / ₄ (95.3) | 5 ³ / ₄ (146.1) | 6 ³ / ₄ (171.5) | 9 ¹ / ₄ (235.0) | 9 ¹ / ₂ (241.3) | 10 ³ / ₄ (273.1) | — | — | 2 ³ / ₈ (60.3) | 3 (76.2) | 7 ¹ / ₁₆ (11.1) | 5 ⁵ / ₈ x 3 ³ / ₄ (15.9) x (19.1) | 5 ⁵ / ₈ x 1 ¹ / ₈ (15.9) x (28.6) | |
| 1800-2000 | 2 | 3 ³ / ₄ (95.3) | 5 ³ / ₄ (146.1) | 6 ³ / ₄ (171.5) | 9 ¹ / ₄ (235.0) | 9 ¹ / ₂ (241.3) | 10 ³ / ₄ (273.1) | — | — | 2 ³ / ₄ (69.9) | 3 ¹ / ₂ (88.9) | 1 ¹ / ₂ (12.7) | 5 ⁵ / ₈ x 3 ³ / ₄ (15.9) x (19.1) | 5 ⁵ / ₈ x 1 ¹ / ₈ (15.9) x (28.6) | |
| 2100-2500 | 3 | 4 (101.6) | 5 ³ / ₄ (146.1) | 6 ³ / ₄ (171.5) | 9 ¹ / ₄ (235.0) | 9 ¹ / ₂ (241.3) | 10 ³ / ₄ (273.1) | 1 ¹ / ₈ (41.3) | 1 ³ / ₄ (44.5) | 3 ¹ / ₂ (88.9) | 5 (127.0) | 3 ³ / ₄ (19.1) | 5 ⁵ / ₈ x 3 ³ / ₄ (15.9) x (19.1) | 5 ⁵ / ₈ x 1 ¹ / ₈ (15.9) x (28.6) | |
| 2501-3000 | 3 | 4 (101.6) | 5 ³ / ₄ (146.1) | 6 ³ / ₄ (171.5) | 9 ¹ / ₄ (235.0) | 9 ¹ / ₂ (241.3) | 10 ³ / ₄ (273.1) | 1 ¹ / ₈ (41.3) | 1 ³ / ₄ (44.5) | 4 (101.6) | 5 (127.0) | 3 ³ / ₄ (19.1) | 5 ⁵ / ₈ x 3 ³ / ₄ (15.9) x (19.1) | 5 ⁵ / ₈ x 1 ¹ / ₈ (15.9) x (28.6) | |
| 3500-4000 | 4 | 4 (101.6) | 5 ³ / ₄ (146.1) | 6 ³ / ₄ (171.5) | 9 ¹ / ₄ (235.0) | 9 ¹ / ₂ (241.3) | 10 ³ / ₄ (273.1) | 1 ³ / ₄ (44.5) | 3 ³ / ₄ (82.6) | 4 ³ / ₄ (120.7) | 5 ³ / ₄ (146.1) | 3 ³ / ₄ (19.1) | 5 ⁵ / ₈ x 1 ³ / ₈ (15.9) x (34.9) | 5 ⁵ / ₈ x 1 ³ / ₈ (15.9) x (34.9) | |
| 4500-5000 | 5 | 4 (101.6) | 5 ³ / ₄ (146.1) | — | 9 ¹ / ₄ (235.0) | — | 10 ³ / ₄ (273.1) | 1 ¹ / ₈ (41.3) | 3 ³ / ₄ (82.6) | 5 ¹ / ₄ (133.4) | 7 ¹ / ₈ (181.0) | 1 (25.4) | 5 ⁵ / ₈ DIA. (15.9) | — | |
| 6000 | 5 | 4 (101.6) | 5 ³ / ₄ (146.1) | — | 9 ¹ / ₄ (235.0) | — | 10 ³ / ₄ (273.1) | 1 ¹ / ₈ (41.3) | 3 ³ / ₄ (82.6) | 5 ¹ / ₄ (133.4) | 7 ¹ / ₈ (181.0) | 1 (25.4) | 5 ⁵ / ₈ DIA. (15.9) | — | |

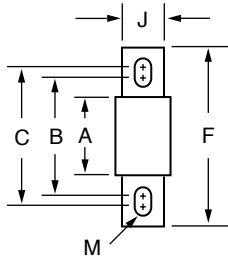

FIG. 1

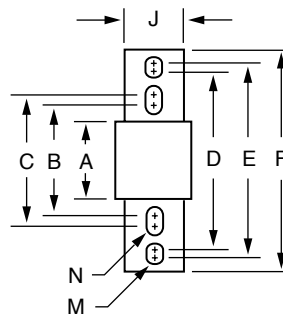

FIG. 2

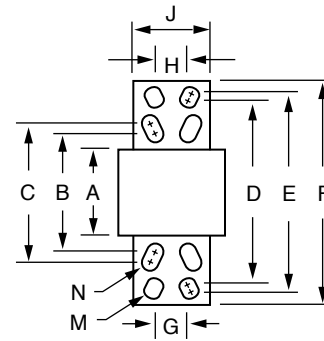

FIG. 3

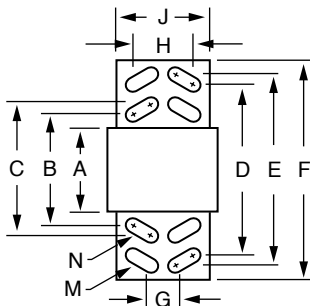

FIG. 4

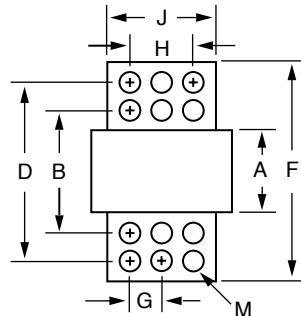
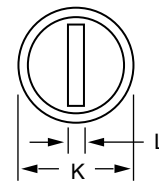

FIG. 5



LLNRK/LLSRK/LLSRK_ID SERIES INDICATOR® POWR-PRO® FUSES

POWR-PRO® 250/600 VAC • Dual Element • Time-Delay • 1/10-600 A



Description

RK1 fuses are extremely current-limiting fuses meaning they greatly reduce or eliminate damage to circuits and equipment under short-circuit conditions. Replacing existing Class H, K and RK5 fuses with RK1 fuses is one of the easiest ways to immediately improve the protection of plant workers and equipment.

Applications

- All general purpose circuits
- Motors
- Transformers
- Safety upgrades

Features/Benefits

- POWR-PRO Performance
- Indication available
- Dual-element design
- Extremely Current-Limiting
- IEC Type 2 “No Damage” protection to IEC and NEMA type motor starters
- Indicating and DIN mount fuse holders available

Specifications

Voltage Ratings 600 VAC/300 VDC (LLSRK/LLSRK_ID)
250 VAC/125 VDC (LLNRK)

Interrupting Ratings AC: 200 kA rms symmetrical
300 kA rms symmetrical
(Littelfuse self-certified)
DC: 20 kA

Ampere Range 1/10 – 600 A

Approvals AC: Standard 248-12, Class RK1
UL Listed (File No. E81895)
CSA Certified (File No. LR29862)
DC: Littelfuse self-certified
Federal Specification WF-1814
(QPL- W-F-1814)

Recommended Fuse Holders

| | |
|--------------------|----|
| LFR60 Series | 86 |
| LFR25 Series | 86 |

Ordering Information

| AMPERE RATINGS | | | | | | |
|----------------|--------|--------|--------|-----|-----|-----|
| 1/10 | 1 | 2 8/10 | 6 1/4 | 25 | 80 | 250 |
| 15/100 | 1 1/8 | 3 | 7 | 30 | 90 | 300 |
| 2/10 | 1 1/4 | 3 2/10 | 8 | 35 | 100 | 350 |
| 1/4 | 1 4/10 | 3 1/2 | 9 | 40 | 110 | 400 |
| 3/10 | 1 6/10 | 4 | 10 | 45 | 125 | 450 |
| 4/10 | 1 8/10 | 4 1/2 | 12 | 50 | 150 | 500 |
| 1/2 | 2 | 5 | 15 | 60 | 175 | 600 |
| 6/10 | 2 1/4 | 5 6/10 | 17 1/2 | 70 | 200 | |
| 8/10 | 2 1/2 | 6 | 20 | 75* | 225 | |

Note: All LLSRK_ID fuses rated 1 amp and above are Indicator® fuses.
*75 A is only available for the 600 V.

600 V

| TYPE | SERIES | AMPERAGE | CATALOG NUMBER | ORDERING NUMBER |
|----------------|----------|----------|----------------|-----------------|
| INDICATING | LLSRK_ID | 60 | LLSRK060ID | LSRK060.TXID |
| NON-INDICATING | LLSRK | 60 | LLSRK060 | LSRK060.T |

250 V

| TYPE | SERIES | AMPERAGE | CATALOG NUMBER | ORDERING NUMBER |
|----------------|--------|----------|----------------|-----------------|
| NON-INDICATING | LLNRK | 80 | LLNRK080 | LNRK080.V |

Web Resources

TC Curves, downloadable CAD drawings and other technical information: www.littelfuse.com/llsrk
www.littelfuse.com/llnrk

Dimensions

Please refer to the Class R dimensions..... 20

Peak Let-Thru Curve (600 V)

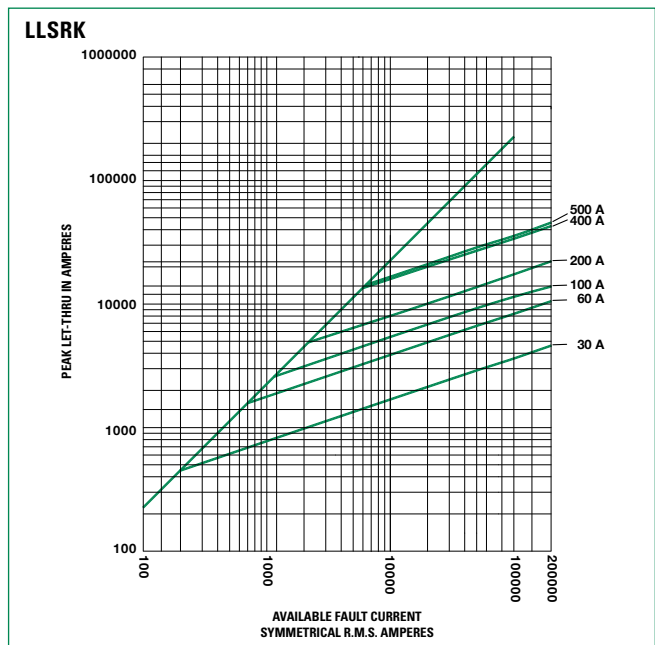

Note: For more information, see Peak Let-Thru Table on pg. 16

KLNR/KLSR SERIES FUSES

250/600 VAC • Fast-Acting • 1-600 A



Description

KLSR/KLNR fuses are an economical single element design providing the safety of an RK1 fuse.

Applications

- Resistance heaters
- Lighting circuits
- Non-inductive loads

Features/Benefits

- Extremely Current-Limiting
- Indicating and DIN mount fuse holders available

Specifications

| | |
|-----------------------------|--|
| Voltage Ratings | AC: 250 V (KLNR); 600 V (KLSR) DC: 125 V (1 – 600 A KLNR); 250 V (1 – 30 A KLSR); 300 V (35 – 600 A KLSR). |
| Interrupting Ratings | AC: 200 kA rms symmetrical DC: 20 kA |
| Ampere Range | 1 – 600 A |
| Approvals | AC: Standard 248-12, Class RK1 UL Listed (File No. E81895) CSA Certified (File No. LR29862) DC: Littelfuse self-certified |

Recommended Fuse Holders

| | |
|--------------------|----|
| LFR60 Series | 86 |
| LFR25 Series | 86 |

Dimensions

Please refer to the Class R dimensions..... 20

Ordering Information

| AMPERE RATINGS | | | | | |
|----------------|----|----|-----|-----|--|
| 1 | 10 | 40 | 100 | 250 | |
| 2 | 12 | 45 | 110 | 300 | |
| 3 | 15 | 50 | 125 | 350 | |
| 4 | 20 | 60 | 150 | 400 | |
| 5 | 25 | 70 | 175 | 450 | |
| 6 | 30 | 80 | 200 | 500 | |
| 8 | 35 | 90 | 225 | 600 | |

600 V

| SERIES | AMPERAGE | CATALOG NUMBER | ORDERING NUMBER |
|--------|----------|----------------|-----------------|
| KLSR | 90 | KLSR090 | KLSR090.V |

250 V

| SERIES | AMPERAGE | CATALOG NUMBER | ORDERING NUMBER |
|--------|----------|----------------|-----------------|
| KLNR | 90 | KLNR090 | KLNR090.V |

Web Resources

TC Curves, downloadable CAD drawings and other technical information: www.littelfuse.com/klsr
www.littelfuse.com/klnr

Peak Let-Thru Curve (600 V)

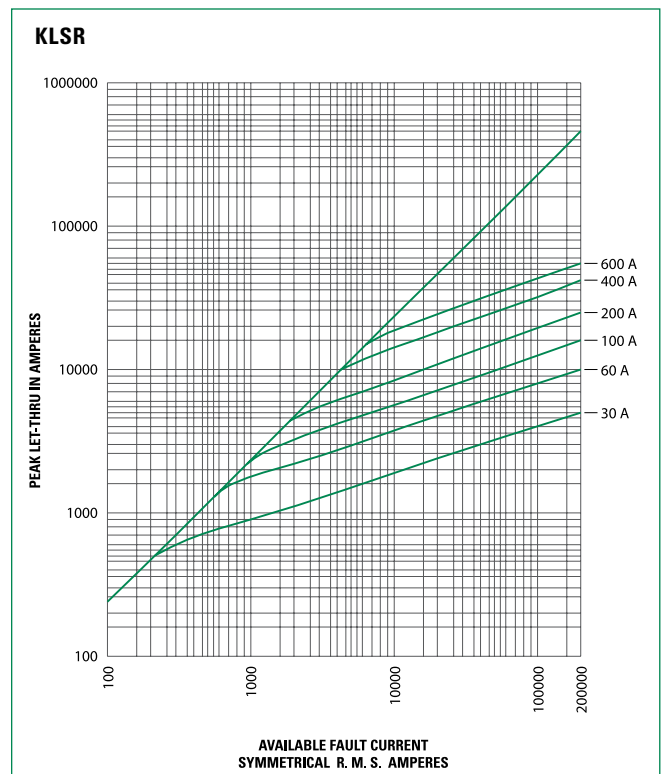

Note: For more information, see Peak Let-Thru Table on pg. 16

CLASS RK1 CURRENT LIMITING EFFECTS

Class RK1 Fuses 1

Current-Limiting Effects of LLSRK and LLSRK_ID (600 V) Fuses

| SHORT CIRCUIT CURRENT* | APPARENT RMS SYMMETRICAL CURRENT FOR VARIOUS FUSE RATINGS | | | | | |
|------------------------|---|-------|-------|--------|--------|--------|
| | 30 A | 60 A | 100 A | 200 A | 400 A | 600 A |
| 5,000 | 1,060 | 1,600 | 2,100 | 2,600 | 4,100 | -- |
| 10,000 | 1,350 | 2,000 | 2,800 | 3,400 | 5,250 | 8,000 |
| 15,000 | 1,600 | 2,300 | 3,200 | 3,900 | 6,000 | 9,000 |
| 20,000 | 1,700 | 2,600 | 3,600 | 4,500 | 6,700 | 10,000 |
| 25,000 | 1,900 | 2,800 | 3,800 | 4,800 | 7,500 | 11,000 |
| 30,000 | 2,000 | 3,000 | 4,100 | 5,200 | 8,000 | 12,000 |
| 35,000 | 2,100 | 3,100 | 4,400 | 5,700 | 8,500 | 12,500 |
| 40,000 | 2,200 | 3,300 | 4,600 | 6,000 | 9,000 | 13,000 |
| 50,000 | 2,400 | 3,500 | 4,900 | 6,500 | 9,500 | 14,000 |
| 60,000 | 2,500 | 3,800 | 5,200 | 7,000 | 10,000 | 15,000 |
| 80,000 | 2,700 | 4,000 | 5,700 | 7,750 | 11,000 | 17,000 |
| 100,000 | 2,900 | 4,200 | 6,200 | 8,500 | 12,000 | 18,000 |
| 150,000 | 3,200 | 4,600 | 7,300 | 10,000 | 14,000 | 21,000 |
| 200,000 | 3,300 | 4,700 | 8,000 | 11,000 | 16,000 | 23,000 |

Visit www.littelfuse.com/llsrk for 600 V Current-Limiting effects

Current-Limiting Effects of LLNRK (250 V) Fuses

| SHORT CIRCUIT CURRENT* | APPARENT RMS SYMMETRICAL CURRENT FOR VARIOUS FUSE RATINGS | | | | | |
|------------------------|---|-------|-------|-------|--------|--------|
| | 30 A | 60 A | 100 A | 200 A | 400 A | 600 A |
| 5,000 | 900 | 1,400 | 2,000 | 2,700 | 4,800 | 5,000 |
| 10,000 | 1,100 | 1,900 | 2,700 | 3,500 | 6,200 | 8,500 |
| 15,000 | 1,250 | 2,100 | 3,100 | 4,200 | 7,000 | 9,500 |
| 20,000 | 1,400 | 2,400 | 3,500 | 4,600 | 8,000 | 10,800 |
| 25,000 | 1,500 | 2,600 | 3,900 | 5,000 | 8,300 | 11,500 |
| 30,000 | 1,600 | 2,800 | 4,000 | 5,250 | 9,000 | 12,000 |
| 35,000 | 1,700 | 2,850 | 4,300 | 5,500 | 9,500 | 12,500 |
| 40,000 | 1,800 | 3,000 | 4,600 | 5,800 | 9,800 | 13,500 |
| 50,000 | 1,900 | 3,200 | 4,800 | 6,300 | 10,200 | 14,000 |
| 60,000 | 2,000 | 3,500 | 5,200 | 6,700 | 11,000 | 15,000 |
| 80,000 | 2,200 | 3,900 | 5,700 | 7,200 | 12,200 | 16,000 |
| 100,000 | 2,300 | 4,000 | 6,000 | 8,100 | 12,700 | 17,000 |
| 150,000 | 2,500 | 4,500 | 6,700 | 9,100 | 14,000 | 19,000 |
| 200,000 | 2,600 | 4,800 | 7,000 | 9,700 | 15,000 | 20,000 |

*Prospective RMS Symmetrical Amperes Short-Circuit Current
Note: Data derived from Peak Let-Thru Curves

Visit www.littelfuse.com/llnrk for 250 V Current-Limiting effects

LLSRK_ID Fuses — Quality Construction for performance you can rely on...

Littelfuse **LLSRK_ID** Fuses feature true dual-element construction. This robust design withstands repeated surges within rated time delay without opening needlessly, eliminating downtime caused by power surges or equipment demands.

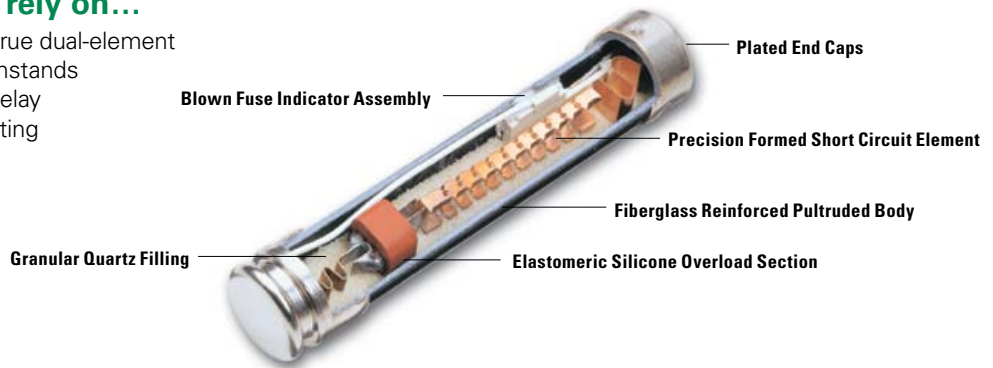

IDSR SERIES INDICATOR® POWR-PRO® FUSES

POWR-PRO® 600 V AC/DC • Dual Element • Time-Delay • 1/10-600 A



Description

The IDSR combines a 600 VDC capability with indication to provide an ideal solution for many DC applications.

Applications

- DC circuits
- Solar inverters
- Motors
- Transformers
- Solenoids
- Fluorescent lighting

Features/Benefits

- POWR-PRO® Performance
- Indication

Specifications

Voltage Ratings AC: 600 V
DC: 600 V

Interrupting Ratings AC: 200 kA rms symmetrical
300 kA rms symmetrical
(Littelfuse self-certified)
DC: 20 kA

Ampere Range 1/10 — 600 A

Approvals Standard 248-12 and UL 198M, Class RK5
UL Listed (File No. E81895)
CSA Certified (File No. LR29862)

Ordering Information

| AMPERE RATINGS | | | | | | | |
|----------------|--------|--------|--------|--------|----|-----|-----|
| 1/10 | 6/10 | 1 8/10 | 4 | 8 | 30 | 80 | 225 |
| 1/8 | 8/10 | 2 | 4 1/2 | 9 | 35 | 90 | 250 |
| 15/100 | 1 | 2 1/4 | 5 | 10 | 40 | 100 | 300 |
| 2/10 | 1 1/8 | 2 1/2 | 5 5/10 | 12 | 45 | 110 | 350 |
| 1/4 | 1 1/4 | 2 3/10 | 6 | 15 | 50 | 125 | 400 |
| 3/10 | 1 4/10 | 3 | 6 1/4 | 17 1/2 | 60 | 150 | 450 |
| 4/10 | 1 1/2 | 3 2/10 | 7 | 20 | 70 | 175 | 500 |
| 1/2 | 1 6/10 | 3 1/2 | 7 1/2 | 25 | 75 | 200 | 600 |

Note: All fuses rated 1A and above are Indicator® fuses.

| SERIES | AMPERAGE | CATALOG NUMBER | ORDERING NUMBER |
|--------|----------|----------------|-----------------|
| IDSR | 30 | IDSR30 | IDSR030.T |

Web Resources

TC Curves, downloadable CAD drawings and other technical information: www.littelfuse.com/idsr

Recommended Fuse Holders

LFR60 Series 86

Dimensions

Please refer to the Class R dimensions 20

Peak Let-Thru Curve

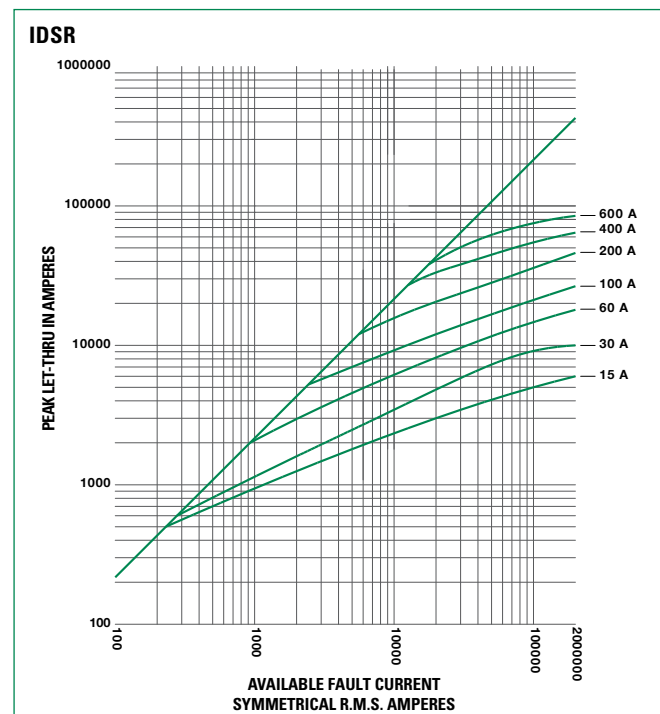

Note: For more information, see Peak Let-Thru Table on pg. 19

FLNR_ID/FLSR_ID SERIES INDICATOR® FUSES

250/600 VAC • Dual Element • Time Delay • 1/10-600 A



Description

Available in both Indicating and Non-Indicating versions, the FLNR/FLSR series of fuses set the standard for general purpose fuses. The dual-element design provides advanced short circuit and overload protection. FLSR series fuses provide excellent protection for all types of circuits especially those containing motors.

Applications

- Service entrance switches
- Switchboard mains and feeders
- Motor control central mains and motor branch circuits
- All general purpose circuits

Features/Benefits

- Indication
- Dual-element design
- Available without indication
- Current limiting

Specifications

Voltage Ratings AC: 250 V (FLNR_ID); 600 V (FLSR_ID)
DC: 125 V (FLNR 1/10 – 30 A);
125 V (FLNR_ID 35 – 600 A);
300 V (FLSR_ID)

Interrupting Ratings AC: 200 kA rms symmetrical
300 kA rms symmetrical
(Littelfuse self-certified)
DC: 20 kA

Ampere Range 1/10 – 600 A

Approvals Standard 248-12, Class RK5
UL Listed (File No. E81895)
CSA Certified (File No. LR29862)
Federal Specification WF-1814
(QPL- W-F-1814)

Dimensions

Please refer to the Class R dimensions..... 20
Refer to the FLNR Series dimensions for FLNR_ID,
and the FLSR dimensions for FLSR_ID.

Ordering Information

| AMPERE RATINGS | | | | | | | |
|----------------|--------|--------|--------|--------|------|-----|-----|
| 1/10 | 6/10 | 1 8/10 | 4 | 8 | 30 | 80 | 225 |
| 1/8* | 8/10 | 2 | 4 1/2 | 9 | 35 | 90 | 250 |
| 15/100 | 1 | 2 1/4 | 5 | 10 | 40 | 100 | 300 |
| 2/10 | 1 1/8 | 2 1/2 | 5 8/10 | 12 | 45 | 110 | 350 |
| 1/4 | 1 1/4 | 2 9/10 | 6 | 15 | 50 | 125 | 400 |
| 3/10† | 1 4/10 | 3 | 6 1/4 | 17 1/2 | 60 | 150 | 450 |
| 4/10 | 1 1/2 | 3 2/10 | 7 | 20 | 70 | 175 | 500 |
| 1/2 | 1 9/10 | 3 1/2 | 7 1/2 | 25 | 75** | 200 | 600 |

*FLNR only. †FLNR, FLSR, FLSR_ID only. **FLNR, FLSR, FLSR_ID only
Note: For 1/10 – 30A 250 volt fuses, order non-indicating FLNR series fuses.

| TYPE | VOLTAGE | SERIES | AMP | CATALOG NUMBER | ORDERING NUMBER |
|----------------|---------|---------|-----|----------------|-----------------|
| NON-INDICATING | 600 V | FLSR | 15 | FLSR015 | FLSR015.T |
| INDICATING | 600 V | FLSR_ID | 15 | FLSR015ID | FLSR015.TXID |
| NON-INDICATING | 250 V | FLNR | 60 | FLNR060 | FLNR060.T |
| INDICATING | 250 V | FLNR_ID | 60 | FLNR060ID | FLNR060.TXID |

Web Resources

TC Curves, downloadable CAD drawings and other technical information: www.littelfuse.com/flsr
www.littelfuse.com/flnr

Recommended Fuse Holders

| | |
|--------------------|----|
| LFR60 Series | 86 |
| LFR25 Series | 86 |

Peak Let-Thru Curve (600 V)

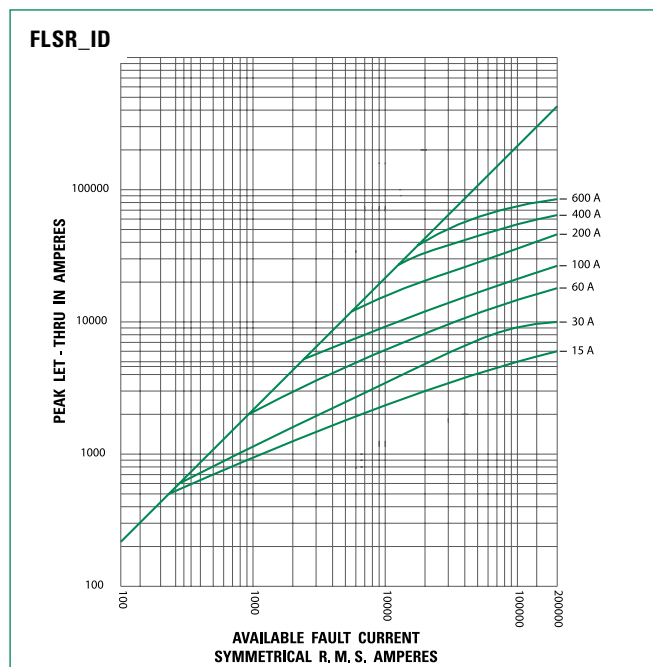

Note: For more information, see Peak Let-Thru Table on pg. 19

CLASS RK5 CURRENT-LIMITING EFFECTS

Current-Limiting Effects of IDSR (600 V) Fuses

| SHORT CIRCUIT CURRENT* | APPARENT RMS SYMMETRICAL CURRENT FOR VARIOUS FUSE RATINGS | | | | | | |
|------------------------|---|-------|-------|--------|--------|--------|--------|
| | 15 A | 30 A | 60 A | 100 A | 200 A | 400 A | 600 A |
| 5,000 | 800 | 1,100 | 2,100 | 3,200 | 5,000 | 5,000 | 5,000 |
| 10,000 | 1,100 | 1,600 | 2,900 | 4,300 | 7,300 | 10,000 | 10,000 |
| 15,000 | 1,300 | 1,900 | 3,400 | 5,000 | 8,600 | 13,700 | 15,000 |
| 20,000 | 1,400 | 2,200 | 3,800 | 5,600 | 9,500 | 15,500 | 19,000 |
| 25,000 | 1,500 | 2,500 | 4,100 | 6,100 | 10,300 | 16,700 | 21,500 |
| 30,000 | 1,600 | 2,700 | 4,500 | 6,500 | 11,000 | 17,700 | 23,500 |
| 35,000 | 1,700 | 2,900 | 4,700 | 6,800 | 11,600 | 18,600 | 25,200 |
| 40,000 | 1,800 | 3,100 | 5,000 | 7,200 | 12,100 | 19,400 | 26,600 |
| 50,000 | 1,900 | 3,400 | 5,400 | 7,800 | 13,100 | 20,800 | 29,500 |
| 60,000 | 2,000 | 3,600 | 5,800 | 8,300 | 13,900 | 22,000 | 30,600 |
| 80,000 | 2,200 | 4,000 | 6,300 | 9,100 | 15,400 | 24,000 | 33,200 |
| 100,000 | 2,300 | 4,200 | 6,800 | 9,800 | 16,700 | 25,500 | 35,100 |
| 150,000 | 2,600 | 4,500 | 7,700 | 11,200 | 19,300 | 28,100 | 38,000 |
| 200,000 | 2,800 | 4,600 | 8,400 | 12,400 | 21,400 | 30,000 | 39,600 |

Current-Limiting Effects of FLNR and FLNR_ID (600 V) Fuses

| SHORT-CIRCUIT CURRENT* | APPARENT RMS SYMMETRICAL CURRENT FOR VARIOUS FUSE RATINGS | | | | | |
|------------------------|---|-------|--------|--------|--------|--------|
| | 30 A | 60 A | 100 A | 200 A | 400 A | 600 A |
| 5,000 | 1,250 | 2,100 | 3,200 | 5,000 | 5,000 | 5,000 |
| 10,000 | 1,600 | 2,850 | 4,300 | 7,250 | 10,000 | 10,000 |
| 15,000 | 1,800 | 3,400 | 5,000 | 8,500 | 13,500 | 15,000 |
| 20,000 | 2,250 | 3,800 | 5,500 | 9,500 | 15,750 | 19,000 |
| 25,000 | 2,450 | 4,100 | 5,700 | 10,250 | 17,000 | 21,000 |
| 30,000 | 2,700 | 4,500 | 6,400 | 10,750 | 18,000 | 23,000 |
| 35,000 | 2,900 | 4,800 | 6,700 | 11,500 | 19,000 | 24,250 |
| 40,000 | 3,000 | 5,000 | 7,250 | 12,000 | 19,500 | 27,000 |
| 50,000 | 3,400 | 5,250 | 7,750 | 13,000 | 21,000 | 29,000 |
| 60,000 | 3,600 | 5,750 | 8,100 | 14,000 | 22,000 | 30,500 |
| 80,000 | 3,900 | 6,250 | 9,000 | 15,000 | 24,000 | 33,000 |
| 100,000 | 4,300 | 6,750 | 9,750 | 16,500 | 26,000 | 35,000 |
| 150,000 | 4,500 | 7,600 | 11,100 | 19,000 | 28,000 | 38,000 |
| 200,000 | 4,600 | 8,400 | 12,250 | 21,500 | 30,000 | 40,000 |

Current-Limiting Effects of FLNR and FLNR_ID (250V) Fuses

| SHORT-CIRCUIT CURRENT* | APPARENT RMS SYMMETRICAL CURRENT FOR VARIOUS FUSE RATINGS | | | | | |
|------------------------|---|-------|-------|--------|--------|--------|
| | 30 A | 60 A | 100 A | 200 A | 400 A | 600 A |
| 5,000 | 1,400 | 2,100 | 3,100 | 5,000 | 5,000 | 5,000 |
| 10,000 | 1,550 | 2,500 | 3,900 | 6,500 | 9,500 | 10,000 |
| 15,000 | 2,000 | 3,150 | 4,400 | 7,250 | 10,500 | 14,000 |
| 20,000 | 2,250 | 3,400 | 5,000 | 8,250 | 12,000 | 16,000 |
| 25,000 | 2,400 | 3,750 | 5,250 | 9,000 | 12,500 | 16,500 |
| 30,000 | 2,550 | 4,100 | 5,600 | 9,500 | 13,500 | 18,000 |
| 35,000 | 2,650 | 4,300 | 5,800 | 9,750 | 14,000 | 19,000 |
| 40,000 | 2,800 | 4,400 | 6,250 | 10,250 | 15,000 | 20,000 |
| 50,000 | 3,000 | 5,000 | 6,500 | 10,500 | 16,000 | 21,000 |
| 60,000 | 3,200 | 5,250 | 7,000 | 11,500 | 17,000 | 23,000 |
| 80,000 | 3,400 | 5,750 | 7,500 | 12,500 | 19,000 | 25,500 |
| 100,000 | 3,850 | 6,000 | 8,000 | 13,500 | 21,000 | 27,500 |
| 150,000 | 4,100 | 7,000 | 9,000 | 15,200 | 24,000 | 31,500 |
| 200,000 | 4,300 | 7,500 | 9,750 | 16,500 | 26,000 | 34,000 |

*Prospective RMS Symmetrical Amperes Short-Circuit Current
 Note: Data Derived from Peak Let-Thru Curves

CLASS R SERIES DIMENSIONS

Class RK1/RK5 Fuses

Dimensions

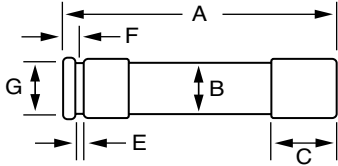

FIG. 1

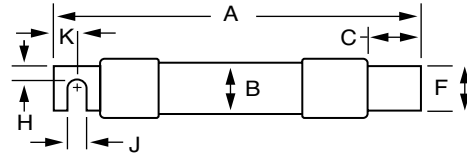
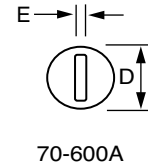

FIG. 2



| AMPS | FIGURE NUMBER | SERIES | DIMENSIONS INCHES (mm) | | | | | | | | | |
|---------|---------------|----------------------|------------------------|--------------|----------------|----------------|------------|--------------|------------|-------------|---------------|---------------|
| | | | A | B | C | D | E | F | G | H | J | K |
| 1/10-30 | 1 | LLNRK/KLNR/FLNR | 2 (50.8) | 1/2 (12.7) | 1/2 (12.7) | 9/16 (14.3) | 5/64 (2.0) | 5/32 (4.0) | 3/8 (9.5) | — | — | — |
| | | LLSRK/KLSR/FLSR/IDSR | 5 (127.0) | 3/4 (19.1) | 5/8 (15.9) | 13/16 (20.6) | 3/32 (2.4) | 3/16 (4.8) | 5/8 (15.9) | — | — | — |
| 35-60 | 1 | LLNRK/KLNR/FLNR | 3 (76.2) | 3/4 (19.1) | 5/8 (15.9) | 13/16 (20.6) | 3/32 (2.4) | 3/16 (4.8) | 5/8 (15.9) | — | — | — |
| | | LLSRK/KLSR/FLSR/IDSR | 5 1/2 (139.7) | 1 (25.4) | 5/8 (15.9) | 1 1/16 (27.0) | 3/32 (2.4) | 1/4 (6.4) | 7/8 (22.2) | — | — | — |
| 70-100 | 2 | LLNRK/KLNR/FLNR | 5 7/8 (149.2) | 1 (25.4) | 1 1/16 (27.0) | 1 1/16 (27.0) | 1/8 (3.2) | 3/4 (19.1) | — | 1/4 (6.4) | 9/32 (7.1) | 1/2 (12.7) |
| | | LLSRK/KLSR/FLSR/IDSR | 7 7/8 (200.0) | 1 1/4 (31.8) | 1 1/16 (27.0) | 1 5/16 (33.3) | 1/8 (3.2) | 3/4 (19.1) | — | 1/4 (6.4) | 9/32 (7.1) | 1/2 (12.7) |
| 110-200 | 2 | LLNRK/KLNR/FLNR | 7 1/8 (181.0) | 1 1/2 (38.1) | 1 5/32 (37.3) | 1 19/32 (40.5) | 3/16 (4.8) | 1 1/8 (28.6) | — | 7/16 (11.1) | 9/32 (7.1) | 1 1/16 (17.5) |
| | | LLSRK/KLSR/FLSR/IDSR | 9 5/8 (244.5) | 1 3/4 (44.5) | 1 5/32 (37.3) | 1 27/32 (46.8) | 3/16 (4.8) | 1 1/8 (28.6) | — | 7/16 (11.1) | 9/32 (7.1) | 1 1/16 (17.5) |
| 225-400 | 2 | LLNRK/KLNR/FLNR | 8 5/8 (219.1) | 2 (50.8) | 1 5/16 (49.2) | 2 3/32 (53.2) | 1/4 (6.4) | 1 5/8 (41.3) | — | 5/8 (15.9) | 13/32 (10.3) | 1 5/16 (23.8) |
| | | LLSRK/KLSR/FLSR/IDSR | 11 5/8 (295.3) | 2 1/2 (63.5) | 2 (50.8) | 2 19/32 (65.9) | 1/4 (6.4) | 1 5/8 (41.3) | — | 5/8 (15.9) | 13/32 (10.3) | 1 5/16 (23.8) |
| 450-600 | 2 | LLNRK/KLNR/FLNR | 10 3/8 (263.5) | 2 1/2 (63.5) | 2 3/8 (60.3) | 2 19/32 (65.9) | 1/4 (6.4) | 2 (50.8) | — | 3/4 (19.1) | 1 7/32 (13.5) | 1 1/8 (28.6) |
| | | LLSRK/KLSR/FLSR/IDSR | 13 3/8 (339.7) | 3 (76.2) | 2 13/32 (61.1) | 3 3/32 (78.6) | 1/4 (6.4) | 2 (50.8) | — | 3/4 (19.1) | 1 7/32 (13.5) | 1 1/8 (28.6) |

NLN/NLS SERIES (ONE-TIME) FUSES

250/600 VAC • "One-Time" • 1-600 A



Description

NLN/NLS fuses provide low cost protection for general purpose feeder and branch circuits when available short circuit currents are less than 50 kA.

Canadian Electrical Code NLKP Type P fuse available. See Web Resources links for more information.

Applications

- General purpose residential and commercial circuits with little or no motor load.

Features/Benefits

- Economical
- 50 kA interrupting rating
- Indicating and DIN mount holders available

Specifications

| | |
|-----------------------------|--|
| Voltage Ratings | AC: 250 V (NLN) 600 V (NLS) DC: 250 V (NLN) 400 V (NLS 35 – 60 A) 500 V (NLS 8 – 30 A) (NLS 225 – 600 A) 600 V (NLS 1 – 7 A) (NLS 70 – 200 A) |
| Interrupting Ratings | AC: 50 kA rms symmetrical (NLN/NLS) DC: 20 kA (NLN/NLS 1 – 60 A) 50 kA (NLN/NLS 70 – 600 A) |
| Ampere Range | 1 – 600 A (NLN/NLS) |
| Approvals | NLN/NLS: Standard 248-9, Class K5 UL Listed (File No. E81895) CSA Certified (File No. LR29862) |

Ordering Information

| AMPERE RATINGS | | | | | |
|----------------|-----|-----|-----|-----|-----|
| 1 | 7 | *25 | *60 | 125 | 300 |
| 2 | 8 | *30 | 70 | 150 | 350 |
| 3 | 10 | *35 | 80 | 175 | 400 |
| 4 | 12 | *40 | 90 | 200 | 450 |
| 5 | *15 | *45 | 100 | 225 | 500 |
| 6 | *20 | *50 | 110 | 250 | 600 |

*NLKP series available only in those amperages preceded by an asterisk.

| SERIES | AMPERAGE | CATALOG NUMBER | ORDERING NUMBER |
|--------|----------|----------------|-----------------|
| NLS | 20 | NLS020 | ONLS020.T |
| NLN | 15 | NLN015 | ONLN015.T |

Web Resources

TC Curves, downloadable CAD drawings and other technical information: www.littelfuse.com/nln
www.littelfuse.com/nls
www.littelfuse.com/nlkp

Recommended Fuse Holders

| | |
|---------------------|----|
| L FH60 Series | 86 |
| L FH25 Series | 86 |

Dimensions

Please refer to the Class K/H dimensions 22

RLN/RLS SERIES RENEWABLE FUSES AND LKN/LKS LINKS

250/600 VAC • Renewable • 1-600 A



Class K/H Fuses 1



Description

Littelfuse RLN and RLS series renewable fuses have traditionally been used to provide low cost protection. However, generally increased levels of available fault current and the distinct possibility that renewable fuses may be improperly renewed, have rendered them unsafe. The use of these fuses in new applications is prohibited by law.

Specifications

- Voltage Ratings** AC: 250 V (RLN); 600 V (RLS)
- Interrupting Ratings** AC: 10 kA rms symmetrical
- Ampere Range** 1–600 A
- Approvals** Standard 248-6, Class H
UL Listed (File No. E81895)
CSA Certified (File No. LR29862)
- Fuse Links** To order, specify LKN (250V) or LKS (600V) plus ampere rating.

Guide For Proper Renewable Fuse Usage

Renewable fuses should only be used where short-circuit currents are known to be less than 10,000 amperes, and where correct replacement of open links is assured. Renewable fuses and links are not recommended for new applications.

Still Using Class H Fuses?

Littelfuse offers several fuse and fuse block combinations that can greatly improve electrical safety.

- LLNRK/LLSRK..... 14
- FLNR/FLSR fuses 18
- LFR fuse holders 86

Ordering Information

| AMPERE RATINGS | | | | | | |
|----------------|-----|----|----|-----|------|------|
| 1 | 6 | 20 | 45 | 90 | 175 | 350† |
| 2 | 8* | 25 | 50 | 100 | 200 | 400† |
| 3 | 10 | 30 | 60 | 110 | 225† | 450† |
| 4 | 12* | 35 | 70 | 125 | 250† | 500† |
| 5 | 15 | 40 | 80 | 150 | 300† | 600† |

*RLS only.
†These ampere ratings require two links per fuse.

| TYPE | VOLTAGE | CATALOG NUMBER | ORDERING NUMBER |
|------|---------|----------------|-----------------|
| FUSE | 600 | RLS020 | ORLS020.T |
| FUSE | 250 | RLN020 | ORLN020.T |
| LINK | 600 | LKS025 | OLKS025.S |
| LINK | 250 | LKN030 | OLKN030.S |

Class K/H Dimensions

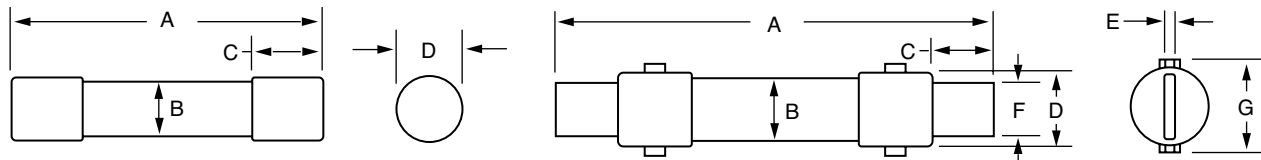

FIG. 1

FIG. 2

| AMPERES | REFER TO FIG. NO. | SERIES | DIMENSIONS INCHES (mm) | | | | | | |
|-----------|-------------------|---------|------------------------|-----------|-----------|---------------|---------|-----------|-----------|
| | | | A | B | C | D | E | F | G |
| 1 – 30 | 1 | NLN/RLN | 2 (50.8) | ½ (12.7) | ½ (12.7) | ⅜ (14.3) | — | — | — |
| | | NLS/RLS | 5 (127.0) | ¾ (19.1) | ⅝ (15.9) | 13/16 (20.6) | — | — | — |
| 35 – 60 | 1 | NLN/RLN | 3 (76.2) | ¾ (19.1) | ⅝ (15.9) | 13/16 (20.6) | — | — | — |
| | | NLS/RLS | 5½ (139.7) | 1 (25.4) | ⅝ (15.9) | 1½ (27.0) | — | — | — |
| 70 – 100 | 2 | NLN/RLN | 5½ (149.2) | 1 (25.4) | 1 (25.4) | 1½ (27.0) | ⅝ (3.2) | ¾ (19.1) | 1½ (33.3) |
| | | NLS/RLS | 7½ (200.0) | 1¼ (31.8) | 1 (25.4) | 1½ (33.3) | ⅝ (3.2) | ¾ (19.1) | 1½ (39.7) |
| 110 – 200 | 2 | NLN/RLN | 7½ (181.0) | 1½ (38.1) | 1¾ (34.9) | 1¾ (39.7) | ¾ (4.8) | 1½ (28.6) | 1¾ (47.6) |
| | | NLS/RLS | 9⅝ (244.5) | 1¾ (44.5) | 1¾ (34.9) | 127/32 (46.8) | ¾ (4.8) | 1½ (28.6) | 2½ (53.2) |
| 225 – 400 | 2 | NLN/RLN | 8⅝ (219.1) | 2 (50.8) | 1¾ (47.6) | 2¾ (53.2) | ¾ (6.4) | 1½ (41.3) | 2½ (61.1) |
| | | NLS/RLS | 11⅝ (295.3) | 2½ (63.5) | 1¾ (47.6) | 2½ (65.9) | ¾ (6.4) | 1½ (41.3) | 2¾ (73.0) |
| 450 – 600 | 2 | NLN/RLN | 10¾ (263.5) | 2½ (63.5) | 2¼ (57.2) | 2½ (65.9) | ¾ (6.4) | 2 (50.8) | 2¾ (73.0) |
| | | NLS/RLS | 13¾ (339.7) | 3 (76.2) | 2¼ (57.2) | 3¾ (78.6) | ¾ (6.4) | 2 (50.8) | 3¼ (87.3) |

JTD_ID SERIES INDICATOR® POWR-PRO® FUSES

POWR-PRO® 600 VAC • Time Delay • $\frac{8}{10}$ -600 A



Description

The Littelfuse POWR-PRO® JTD_ID Indicator Class J fuse provides visual blown fuse indication and maximum protection in a compact package. The current-limiting time delay JTD_ID offers a patented design which reduces nuisance fuse openings.

Applications

- Fused combination motor controllers and motor control centers
- Transformer protection
- Protection for series rated molded case circuit-breaker panels
- General purpose circuits

Features

- Current-Limiting
- IEC Type 2 Protection
- Indication and non-indication version available
- POWR-PRO® Performance
- Indicating and DIN mount holders available

Specifications

| | |
|----------------------------|---|
| Voltage Ratings | AC: 600 V DC: 300 V ($\frac{8}{10}$ -100 A); 500 V (110-600 A) |
| Interrupting Rating | AC: 200 kA rms symmetrical 300 kA rms symmetrical DC: 20 kA $\frac{8}{10}$ -600 A |
| Ampere Range | $\frac{8}{10}$ -600 A |
| Approvals | AC: Standard 248-8, Class J UL Listed (File No. E81895) CSA Certified (File No. LR29862) DC: Littelfuse self-certified |

Ordering Information

| AMPERE RATINGS | | | | | | | |
|----------------|----|----|-----|----|-----|-----|-----|
| $\frac{8}{10}$ | 2¼ | 4½ | 10 | 35 | 90 | 225 | 600 |
| 1 | 2½ | 5 | 12 | 40 | 100 | 250 | |
| 1¼ | 2¾ | 5¾ | 15 | 45 | 110 | 300 | |
| 1½ | 3 | 6 | 17½ | 50 | 125 | 350 | |
| 1⅞ | 3⅞ | 7 | 20 | 60 | 150 | 400 | |
| 1⅞ | 3½ | 8 | 25 | 70 | 175 | 450 | |
| 2 | 4 | 9 | 30 | 80 | 200 | 500 | |

| TYPE | SERIES | AMPERAGE | CATALOG NUMBER | ORDERING NUMBER |
|----------------|--------|----------|----------------|-----------------|
| INDICATING | JTD_ID | 60 | JTD60ID | OJTD060.TXID |
| NON-INDICATING | JTD | 60 | JTD60 | OJTD060.T |

Web Resources

Time-current curves, data sheets and additional technical information: www.littelfuse.com/jtd

Recommended Fuse Holders

| | |
|---|-----|
| LFJ60 Series | 83 |
| LFPSJ Series ($\frac{8}{10}$ -60 A)..... | 113 |

Dimensions

Please refer to the Class J dimensions 25

Peak Let-Thru Curve

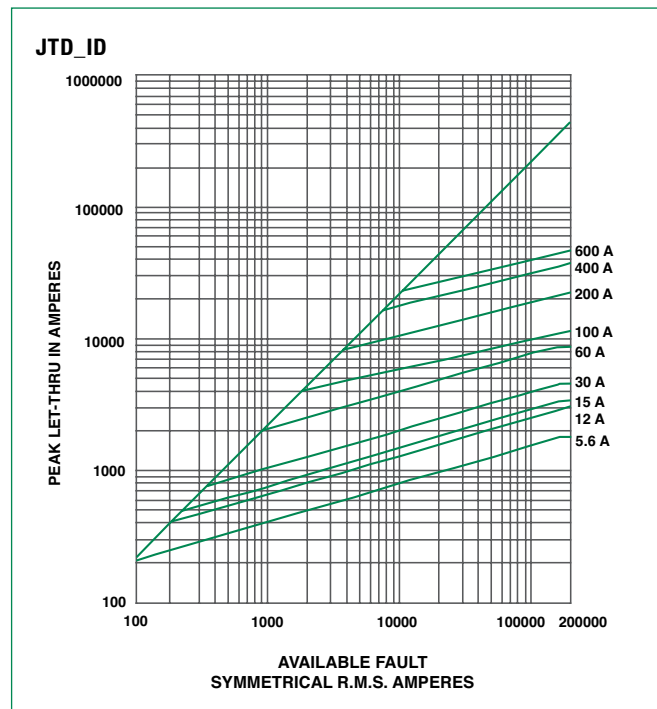

Note: For more information, see Peak Let-Thru Table on pg. 25

JLS SERIES FUSES

600 VAC • Fast-Acting • 1-600 A



Class J Fuses 1

Description

JLS series fuses provide space saving, fast-acting overload and short-circuit protection for non-inductive loads. For applications where short-duration surges and spikes may cause nuisance fuse opening, consider the use of Littelfuse POWR-PRO® JTD or JTD_ID series time-delay fuses.

Applications

- General purpose circuits with little or no motor load.
- Resistive loads, such as resistance electric heat.
- Loads requiring fast-acting overload protection, such as equipment containing solid-state devices.

Specifications

| | |
|-----------------------------|---|
| Voltage Ratings | 600 VAC |
| Interrupting Ratings | 200 kA rms symmetrical |
| Ampere Range | 1–600 A |
| Approvals | Standard 248-8, Class J UL Listed (File No. E81895) CSA Certified (File No. LR29862) Federal Specification WF-1814 (QPL-W-F-1814) |

Dimensions

Please refer to the Class J dimensions 25

Ordering Information

| AMPERE RATINGS | | | | | |
|----------------|----|----|-----|-----|-----|
| 1 | 20 | 45 | 90 | 175 | 350 |
| 3 | 25 | 50 | 100 | 200 | 400 |
| 6 | 30 | 60 | 110 | 225 | 450 |
| 10 | 35 | 70 | 125 | 250 | 500 |
| 15 | 40 | 80 | 150 | 300 | 600 |

| TYPE | SERIES | AMPERAGE | CATALOG NUMBER | ORDERING NUMBER |
|----------------|--------|----------|----------------|-----------------|
| NON-INDICATING | JLS | 110 | JLS110 | OJLS110.X |

Web Resources

TC curves, downloadable CAD drawings and other technical information: www.littelfuse.com/jls

Recommended Fuse Holders

| | |
|---|-----|
| LFJ60 Series | 83 |
| LFPSJ Series (% ₁₀ -60 A)..... | 113 |

Peak Let-Thru Curve

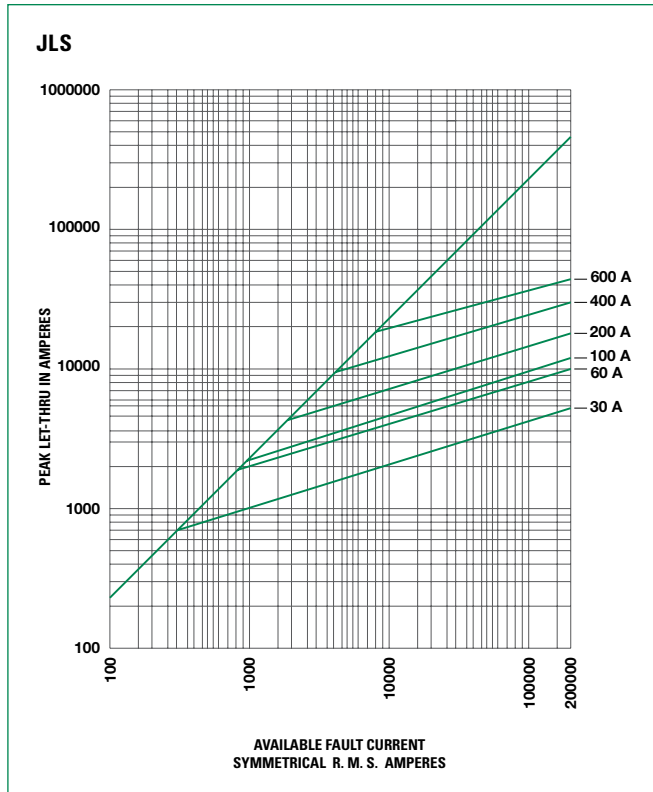

CLASS J DIMENSIONS AND CURRENT-LIMITING EFFECTS

Dimensions Inches (mm)

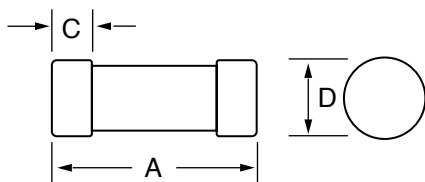

Fig. 1

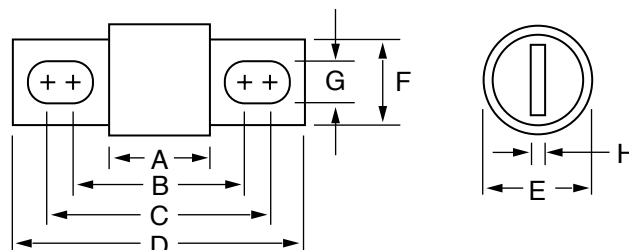

Fig. 2

Dimensions of JTD_ID, JTD and JLS

| AMPERES | REFER TO FIG. NO. | DIMENSIONS INCHES (mm) | | | | | | | |
|-----------|-------------------|--------------------------------------|---|---|---------------------------------------|------------|--------------------------------------|---------------------------------------|------------|
| | | A | B | C | D | E | F | G | H |
| 1 – 30 | 1 | 2¼ (57.2) | — | ½ (12.7) | 13/16 (20.6) | — | — | — | — |
| 35 – 60 | 1 | 2¾ (60.3) | — | 5/8 (15.9) | 1½ (27.0) | — | — | — | — |
| 70 – 100 | 2 | 2½ (66.7) | 3 ¹⁷ / ₃₂ (89.7) | 3 ²³ / ₃₂ (94.5) | 4 ⁵ / ₈ (117.5) | 1½ (28.6)* | ¾ (19.1) | 9/32 (7.1) | 1/8 (3.2) |
| 110 – 200 | 2 | 3 (76.2) | 4 ⁹ / ₃₂ (108.7) | 4 ¹⁵ / ₃₂ (113.5) | 5 ³ / ₄ (146.1) | 1½ (38.1) | 1½ (28.6) | 9/32 (7.1) | 3/16 (4.8) |
| 225 – 400 | 2 | 3 ³ / ₈ (85.7) | 5/8 (130.2) | 5 ⁵ / ₈ (136.5) | 7/8 (181.0) | 2 (50.8) | 1 ⁵ / ₈ (41.3) | 1 ³ / ₃₂ (10.3) | ¼ (6.4) |
| 450 – 600 | 2 | 3 ³ / ₄ (95.3) | 5 ²⁷ / ₃₂ (148.4) | 6 ⁵ / ₃₂ (156.4) | 8 (203.2) | 2½ (63.5) | 2 (50.8) | 1 ⁷ / ₃₂ (13.5) | 3/8 (9.5) |

*70-100 A JLS dimension = 1 (25.4)

Current-Limiting Effects of JTD_ID (600 V) Fuses

| SHORT CIRCUIT CURRENT† | APPARENT RMS SYMMETRICAL CURRENT FOR VARIOUS FUSE RATINGS | | | | | | |
|------------------------|---|-------|-------|-------|--------|--------|--------|
| | 15 A | 30 A | 60 A | 100 A | 200 A | 400 A | 600 A |
| 5,000 | 565 | 750 | 1,500 | 1,800 | 2,800 | 4,800 | 5,000 |
| 10,000 | 675 | 925 | 1,900 | 2,450 | 3,600 | 5,700 | 7,750 |
| 15,000 | 775 | 1,050 | 2,100 | 2,800 | 4,100 | 6,500 | 9,000 |
| 20,000 | 825 | 1,125 | 2,300 | 3,000 | 4,400 | 7,250 | 9,700 |
| 25,000 | 900 | 1,200 | 2,500 | 3,300 | 5,000 | 8,000 | 10,500 |
| 30,000 | 950 | 1,300 | 2,600 | 3,500 | 5,100 | 8,400 | 11,000 |
| 35,000 | 1,000 | 1,350 | 2,700 | 3,700 | 5,400 | 9,000 | 12,000 |
| 40,000 | 1,050 | 1,400 | 2,800 | 3,900 | 5,600 | 9,200 | 12,500 |
| 50,000 | 1,100 | 1,500 | 3,000 | 4,200 | 6,000 | 10,000 | 13,000 |
| 60,000 | 1,200 | 1,600 | 3,200 | 4,500 | 6,400 | 10,500 | 14,000 |
| 80,000 | 1,300 | 1,700 | 3,400 | 4,900 | 7,200 | 11,200 | 15,500 |
| 100,000 | 1,375 | 1,800 | 3,600 | 5,200 | 7,800 | 12,200 | 16,500 |
| 150,000 | 1,500 | 2,000 | 3,950 | 6,000 | 9,000 | 14,500 | 19,000 |
| 200,000 | 1,600 | 2,175 | 4,000 | 6,500 | 10,000 | 16,000 | 20,500 |

†Prospective RMS Symmetrical Amperes Short-Circuit Current
Note: Data derived from Peak Let-Thru Curves

JLLN/JLLS CLASS T FUSES

300/600 VAC • Fast-Acting • 1-1200 A



Class T Fuses 1

Description

JLLN/JLLS fuses are less than 1/3 the size of comparable Class R fuses and are typically used for short circuit protection of drives and surge sensitive components. When rated in accordance with the NEC®, JLLN/JLLS fuses provide fast-acting overload and short circuit protection for non-inductive circuits and equipment.

Applications

- Variable speed drive protection
- Compact mains switches

Features/Benefits

- Extremely current-limiting
- Compact design
- 200 kA Interrupting Rating

Specifications

| | |
|-----------------------------|---|
| Voltage Ratings | AC: 300 V (JLLN); 600 V (JLLS) DC: 160 V (JLLN 1 – 30 A) 160 V (JLLN 35 – 60 A) 125 V (JLLN 70 – 100 A) 125 V (JLLN 110 – 1200 A) 300 V (JLLS) |
| Interrupting Ratings | AC: 200 kA rms symmetrical DC: 20 kA (JLLN 70 – 1200 A) (JLLS 1 – 1200 A) |
| Ampere Range | 1 – 1200 A |
| Approvals | AC: Standard 248-15, Class T UL Listed (File No. E81895): JLLN (1 – 1200 A) JLLS (1 – 800 A) UL Recognized (File No. E71611) JLLS (900 – 1200 A) CSA Certified (File No. LR29862) JLLN/JLLS (1 – 600 A) DC: UL Listed (File No. E81895): JLLN (35 – 1200 A) Littelfuse self-certified: JLLN (1 – 30 A) JLLS (1 – 1200 A) |
| Environmental | RoHS Compliant |

Ordering Information

| AMPERE RATINGS | | | | |
|----------------|----|-----|-----|------|
| 1 | 30 | 90 | 250 | 800 |
| 2 | 35 | 100 | 300 | 900* |
| 3 | 40 | 110 | 350 | 1000 |
| 6 | 45 | 125 | 400 | 1100 |
| 10 | 50 | 150 | 450 | 1200 |
| 15 | 60 | 175 | 500 | |
| 20 | 70 | 200 | 600 | |
| 25 | 80 | 225 | 700 | |

*JLLS only
Note: Contact the factory for RoHS compliant Class T fuses.

| SERIES | VOLTAGE | AMPERAGE | CATALOG NUMBER | ORDERING NUMBER |
|--------|---------|----------|----------------|-----------------|
| JLLS | 600 V | 6 | JLLS006 | JLLS006.T |
| JLLN | 300 V | 10 | JLLN010 | JLLN010.T |

Web Resources

TC Curves, downloadable CAD drawings and other technical information: www.littelfuse.com/jlln
www.littelfuse.com/jlls

Recommended Fuse Holders

| | |
|--------------------------------|-----|
| LFT30 Series..... | 92 |
| LFT60 Series..... | 92 |
| LSCR Series for 700-800 A..... | 120 |

Dimensions

Please refer to the Class T dimensions..... 27

Peak Let-Thru Curve

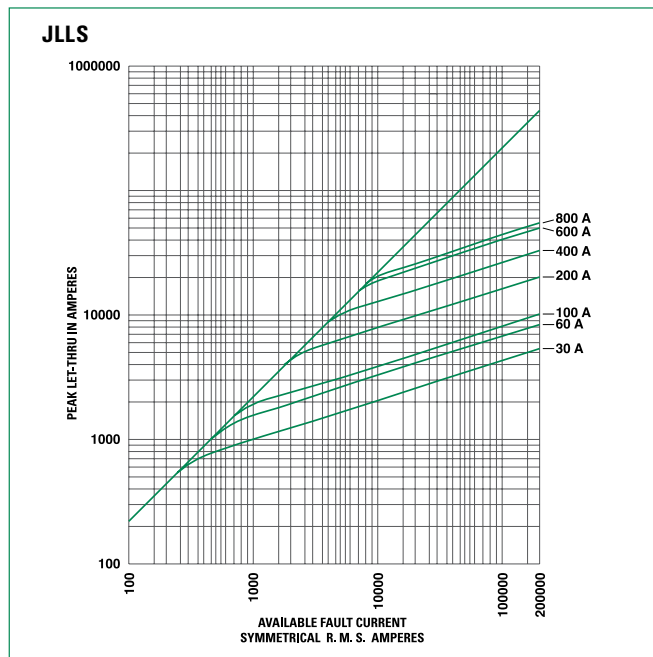

Note: For more information, see Peak Let-Thru Table on pg. 27

CLASS T DIMENSIONS AND CURRENT-LIMITING EFFECTS

Dimensions Inches (mm)

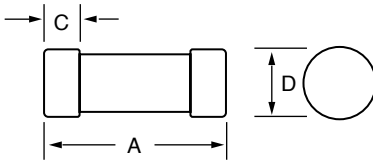

Fig. 1

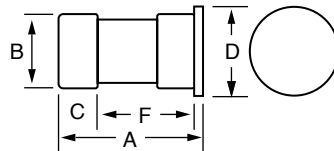

Fig. 2

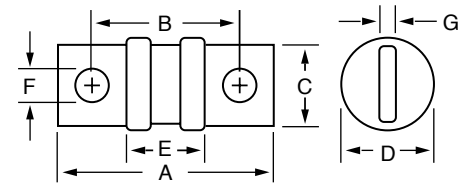

Fig. 3

| AMPERES | REFER TO FIG. NO. | SERIES | DIMENSIONS INCHES (mm) | | | | | | |
|------------|-------------------|--------|------------------------|----------------|--------------|----------------|----------------|---------------|-------------|
| | | | A | B | C | D | E | F | G |
| 1 – 30 | 1 | JLLN | 7/8 (22.2) | — | 9/32 (7.1) | 13/32 (10.3) | — | — | — |
| | | JLLS | 1/2 (38.1) | — | 9/32 (7.1) | 9/16 (14.3) | — | — | — |
| 35 – 60 | 1 | JLLN | 7/8 (22.2) | — | 9/32 (7.1) | 9/16 (14.3) | — | — | — |
| | | JLLS | 1 1/16 (39.7) | 13/16 (20.6) | 13/32 (10.3) | 1 (25.4) | 1/16 (1.6) | 1 3/32 (27.8) | — |
| 70 – 100 | 3 | JLLN | 2 5/32 (54.8) | 1 9/16 (39.7) | 3/4 (19.1) | 13/16 (20.6) | 27/32 (21.4) | 9/32 (7.1) | 1/8 (3.2) |
| | | JLLS | 2 61/64 (75.0) | 2 23/64 (59.9) | 3/4 (19.1) | 13/16 (20.6) | 1 41/64 (41.7) | 9/32 (7.1) | 1/8 (3.2) |
| 110 – 200 | 3 | JLLN | 2 7/16 (61.9) | 1 11/16 (42.9) | 7/8 (22.2) | 1 1/16 (27.0) | 27/32 (21.4) | 11/32 (8.7) | 3/16 (4.8) |
| | | JLLS | 3 1/4 (82.6) | 2 1/2 (63.5) | 7/8 (22.2) | 1 1/16 (27.0) | 1 21/32 (42.1) | 11/32 (8.7) | 3/16 (4.8) |
| 225 – 400 | 3 | JLLN | 2 3/4 (69.9) | 1 27/32 (46.8) | 1 (25.4) | 1 5/16 (33.3) | 53/64 (21.0) | 13/32 (10.3) | 1/4 (6.4) |
| | | JLLS | 3 5/8 (92.1) | 2 23/32 (69.1) | 1 (25.4) | 1 19/32 (40.5) | 1 23/32 (43.7) | 13/32 (10.3) | 1/4 (6.4) |
| 450 – 600 | 3 | JLLN | 3 1/16 (77.8) | 2 1/32 (51.6) | 1 1/4 (31.8) | 1 19/32 (40.5) | 7/8 (22.2) | 31/64 (12.3) | 5/16 (7.9) |
| | | JLLS | 3 63/64 (101.2) | 2 61/64 (75.0) | 1 1/4 (31.8) | 2 1/16 (52.4) | 1 49/64 (44.8) | 31/64 (12.3) | 5/16 (7.9) |
| 700 – 800 | 3 | JLLN | 3 3/8 (85.7) | 2 7/32 (64.3) | 1 3/4 (44.5) | 2 1/16 (52.4) | 7/8 (22.2) | 35/64 (13.9) | 3/8 (9.5) |
| | | JLLS | 4 21/64 (109.9) | 3 11/64 (80.6) | 1 3/4 (44.5) | 2 1/2 (63.5) | 1 55/64 (47.2) | 35/64 (13.9) | 3/8 (9.5) |
| 900 – 1200 | 3 | JLLN | 4 (101.6) | 2 17/32 (64.3) | 2 (50.8) | 2 1/2 (63.5) | 1 1/32 (26.2) | 39/64 (15.5) | 7/16 (11.1) |
| | | JLLS | 5.27 (133.9) | 3.80 (96.5) | 2 (50.8) | 2.63 (66.8) | 2.30 (58.4) | 0.67 (15.5) | 0.44 (11.2) |

Current-Limiting Effects of JLLN (300 V) fuses

| SHORT CIRCUIT CURRENT* | APPARENT RMS SYMMETRICAL CURRENT FOR VARIOUS FUSE RATINGS | | | | | | | |
|------------------------|---|-------|-------|-------|--------|--------|--------|--------|
| | 30 A | 60 A | 100 A | 200 A | 400 A | 600 A | 800 A | 1200 A |
| 5,000 | 700 | 775 | 1,100 | 1,650 | 3,500 | 4,000 | 5,000 | 5,000 |
| 10,000 | 900 | 1,000 | 1,400 | 2,100 | 4,400 | 5,100 | 6,750 | 8,250 |
| 15,000 | 1,000 | 1,100 | 1,600 | 2,400 | 5,000 | 5,900 | 7,750 | 10,000 |
| 20,000 | 1,100 | 1,250 | 1,800 | 2,700 | 5,500 | 6,500 | 8,750 | 11,000 |
| 25,000 | 1,230 | 1,300 | 1,950 | 2,900 | 6,000 | 7,000 | 9,500 | 12,000 |
| 30,000 | 1,300 | 1,475 | 2,050 | 3,100 | 6,400 | 7,500 | 10,000 | 12,500 |
| 35,000 | 1,330 | 1,575 | 2,150 | 3,300 | 6,750 | 7,750 | 10,500 | 13,500 |
| 40,000 | 1,430 | 1,600 | 2,300 | 3,500 | 7,000 | 8,000 | 11,000 | 14,000 |
| 50,000 | 1,500 | 1,750 | 2,400 | 3,700 | 7,500 | 8,750 | 12,000 | 15,000 |
| 60,000 | 1,700 | 1,900 | 2,700 | 4,000 | 8,000 | 9,500 | 12,500 | 16,000 |
| 80,000 | 1,850 | 2,100 | 2,800 | 4,400 | 9,000 | 10,500 | 14,000 | 17,500 |
| 100,000 | 2,000 | 2,250 | 3,150 | 4,800 | 9,750 | 11,500 | 15,000 | 18,500 |
| 150,000 | 2,300 | 2,600 | 3,600 | 5,500 | 11,000 | 13,000 | 17,500 | 22,000 |
| 200,000 | 2,600 | 2,800 | 3,900 | 6,000 | 12,000 | 14,500 | 19,500 | 24,000 |

*Prospective RMS Symmetrical Amperes Short-Circuit Current
Note: Data Derived from Peak Let-Thru Curves

Current-Limiting Effects of JLLS (600 V) fuses

| SHORT CIRCUIT CURRENT* | APPARENT RMS SYMMETRICAL CURRENT FOR VARIOUS FUSE RATINGS | | | | | | | |
|------------------------|---|-------|-------|-------|--------|--------|--------|--------|
| | 30 A | 60 A | 100 A | 200 A | 400 A | 600 A | 800 A | 1200 A |
| 5,000 | 750 | 1,225 | 1,400 | 2,850 | 4,600 | 5,000 | 5,000 | 5,000 |
| 10,000 | 945 | 1,525 | 1,700 | 3,600 | 6,000 | 8,500 | 9,400 | 10,000 |
| 15,000 | 1,050 | 1,700 | 2,000 | 4,050 | 6,600 | 9,750 | 10,500 | 13,000 |
| 20,000 | 1,150 | 1,900 | 2,200 | 4,450 | 7,250 | 10,500 | 11,000 | 14,750 |
| 25,000 | 1,300 | 2,050 | 2,400 | 4,800 | 8,000 | 11,500 | 12,500 | 15,500 |
| 30,000 | 1,375 | 2,150 | 2,450 | 5,000 | 8,250 | 12,000 | 13,750 | 16,500 |
| 35,000 | 1,400 | 2,250 | 2,600 | 5,100 | 8,500 | 13,000 | 14,000 | 17,000 |
| 40,000 | 1,425 | 2,400 | 2,800 | 5,200 | 8,700 | 14,000 | 14,750 | 18,000 |
| 50,000 | 1,600 | 2,450 | 2,900 | 6,000 | 9,500 | 14,500 | 16,000 | 20,000 |
| 60,000 | 1,650 | 2,625 | 3,100 | 6,250 | 10,000 | 15,500 | 17,300 | 21,000 |
| 80,000 | 1,825 | 2,800 | 3,400 | 7,000 | 11,000 | 17,000 | 18,750 | 23,000 |
| 100,000 | 2,000 | 3,100 | 3,700 | 7,250 | 12,000 | 18,000 | 20,000 | 25,000 |
| 150,000 | 2,250 | 3,400 | 4,300 | 8,500 | 13,000 | 21,000 | 23,000 | 28,500 |
| 200,000 | 2,450 | 3,800 | 4,600 | 9,000 | 15,000 | 23,000 | 25,000 | 31,000 |

*Prospective RMS Symmetrical Amperes Short-Circuit Current
Note: Data Derived from Peak Let-Thru Curves

SLC CLASS G FUSES

480/600 VAC • Time-Delay • 1/2-60 A



Class G Fuses 1

Description

Littelfuse SLC fuses provide cost effective branch circuit protection. Fuse length varies to prevent over-fusing. Compact Class G fuses were the first fuse series to approach midget fuse dimensions and meet NEC® requirements for branch-circuit protection.

Applications

- Branch circuit protection

Features/Benefits

- Branch circuit rated
- Current-limiting
- 100 kA interrupting rating
- 600 VAC rated 1/2-20 A

Specifications

| | |
|-----------------------------|---|
| Voltage Ratings | 600 VAC (1/2 – 20 A) 480 VAC (25 – 60 A) 170 VDC (1/2 – 60 A) (Littelfuse self-certified) |
| Interrupting Ratings | AC: 100 kA rms symmetrical DC: 10 kA |
| Ampere Range | 1/2 – 60 A |
| Approvals | Standard 248-5, Class G UL Listed (File No. E81895) CSA Certified (File No. LR29862) Federal Specification WF-1814 (QPL-W-F-1814) |
| Environmental | RoHS Compliant |

Ordering Information

| AMPERE RATINGS | | | | | | |
|----------------|---|----|----|----|----|----|
| 1/2 | 3 | 6 | 12 | 25 | 40 | 60 |
| 1 | 4 | 8 | 15 | 30 | 45 | |
| 2 | 5 | 10 | 20 | 35 | 50 | |

| SERIES | AMPERAGE | CATALOG NUMBER | ORDERING NUMBER |
|--------|----------|----------------|-----------------|
| SLC | 10 | SLC010 | OSLC010.T |

Web Resources

TC Curves, downloadable CAD drawings and other technical information: www.littelfuse.com/slc

Recommended Fuse Holders

| | |
|------------------------|----|
| LFG60 Series (1-20 A) | 97 |
| LFG48 Series (25-60 A) | 97 |

Dimensions

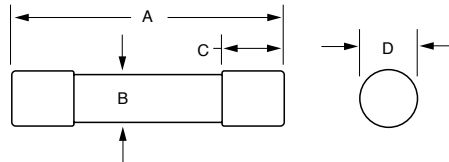

| AMPERES | REFER TO FIG. NO. | DIMENSIONS INCHES (mm) | | | |
|----------|-------------------|------------------------|-----------|------------|--------------|
| | | A | B | C | D |
| 1/2 – 15 | 1 | 1 5/16 (33.3) | 3/8 (9.5) | 9/32 (7.1) | 13/32 (10.3) |
| 20 | 1 | 1 13/32 (35.7) | 3/8 (9.5) | 9/32 (7.1) | 13/32 (10.3) |
| 25, 30 | 1 | 1 5/8 (41.3) | 3/8 (9.5) | 9/32 (7.1) | 13/32 (10.3) |
| 35 – 60 | 1 | 2 1/4 (57.2) | 3/8 (9.5) | 1/2 (12.7) | 13/32 (10.3) |

CCMR SERIES POWR-PRO® FUSES

POWR-PRO® 600 VAC • Dual Element • Time-Delay • $2/_{10}$ -60 A



Description

The CCMR series is ideal for space saving protection of motors up to 40 hp*. It was designed specifically to withstand sustained starting currents of small motors. The CCMR 60 fuse is the smallest 60 A fuse available rated at 600 V. Compared to other UL Listed fuses, Class CC fuses are the most current-limiting, rating for rating.

Applications

- Motor and motor branch circuit protection

Features/Benefits

- POWR-PRO® Performance
- Extremely current-limiting
- Ratings up to 60 Amps
- 300 kA Interrupting Rating (self-certified)

Specifications

| | |
|-------------------------------|--|
| Voltage Ratings | AC: 600 V DC: 250 V (CCMR $2/_{10}$ – 2 A) (CCMR $4 1/2$ – 10 A) (CCMR 35– 60 A) 300 V (CCMR $2 1/4$ – 4 A) 500 V (CCMR 12– 30 A) |
| Interrupting Ratings | AC: 200 kA rms symmetrical 300 kA Littelfuse self-certified DC: 20 kA $2/_{10}$ – 60 A |
| Ampere Range Approvals | AC: Standard 248-4, Class CC UL Listed $1/_{10}$ -30 A (File No. E81895) Standard 248, Class CD UL Listed 35-60 A (File No. E81895) CSA Certified $1/_{10}$ -30 A (File No. LR29862) DC: Littelfuse self-certified |

*Consult Motor Protection Tables on page 211 in the Technical Application Guide section for specific motor sizing information.

Ordering Information

| AMPERE RATINGS | | | | | | |
|----------------|-------------|-------------|-------------|---------|----------|----|
| $2/_{10}$ | 1 | 2 | $3 1/2$ | $6 1/4$ | 12 | 35 |
| $1/4$ | $1 1/4$ | $2 1/4$ | 4 | 7 | 15 | 40 |
| $3/_{10}$ | $1 4/_{10}$ | $2 1/2$ | $4 1/2$ | $7 1/2$ | $17 1/2$ | 45 |
| $1/2$ | $1 1/2$ | $2 8/_{10}$ | 5 | 8 | 20 | 50 |
| $6/_{10}$ | $1 6/_{10}$ | 3 | $5 6/_{10}$ | 9 | 25 | 60 |
| $8/_{10}$ | $1 8/_{10}$ | $3 2/_{10}$ | 6 | 10 | 30 | |

| SERIES | AMPERAGE | CATALOG NUMBER | ORDERING NUMBER |
|--------|----------|----------------|-----------------|
| CCMR | 45 | CCMR045 | CCMR045.T |

Web Resources

TC Curves, downloadable CAD drawings and other technical information: www.littelfuse.com/ccmr

Recommended Fuse Holders

| | |
|----------------------|-----|
| LFC600 Series | 99 |
| L60030C Series | 99 |
| LPSC Series..... | 108 |

Dimensions

Please refer to the Class CC/CD dimensions 31

Peak Let-Thru Curve

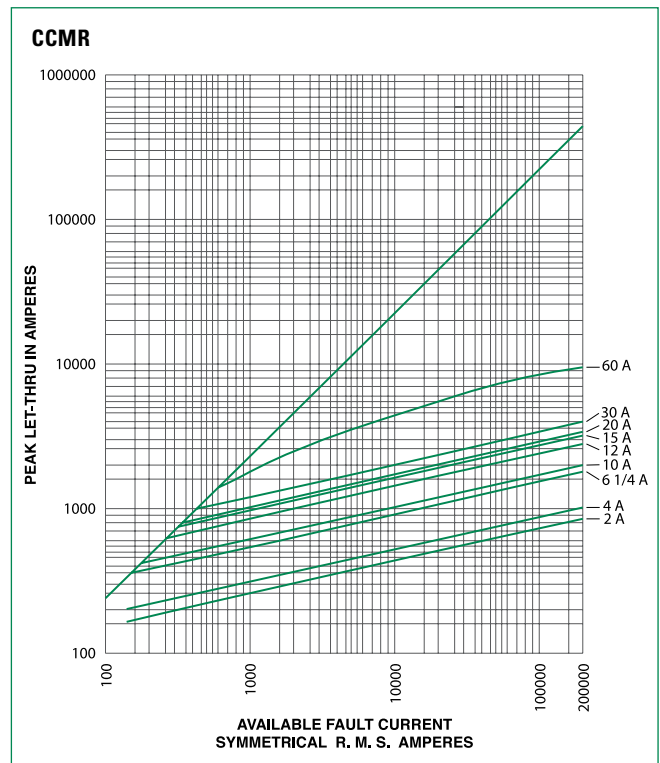

Note: For more information, see Peak Let-Thru Table on pg. 31

CLASS CC FUSES



Class CC/CD Fuses 1

KLDR Series
600 VAC/300 VDC • Time-Delay • 1/10-30 A



Description

KLDR fuses are time-delay fuses designed to protect control transformers, solenoids and similar inductive components with high magnetizing currents during the first half-cycle. They provide excellent protection of motor branch circuits containing IEC or NEMA rated motor controllers or contactors.

Specifications

| | |
|-----------------------------|---|
| Voltage Ratings | AC: 600 V DC: 300 V |
| Interrupting Ratings | AC: 200 kA rms symmetrical DC: 20 kA |
| Ampere Range | 1/10 – 30 A |
| Approvals | AC: Standard 248-4, Class CC UL Listed 1/10-30 A (File No. E81895) CSA Certified 1/10-30 A (File No. LR29862) |
| Environmental | DC: Littelfuse self-certified RoHS Compliant (Except 8-20 A) |

Ordering Information

| AMPERE RATINGS | | | | |
|----------------|--------|--------|--------|--------|
| 1/10 | 6/10 | 1 8/10 | 4 1/2 | 10 |
| 1/8 | 3/4 | 2 | 5 | 12 |
| 15/100 | 8/10 | 2 1/4 | 5 6/10 | 15 |
| 3/16 | 1 | 2 1/2 | 6 | 17 1/2 |
| 2/10 | 1 1/8 | 2 8/10 | 6 1/4 | 20 |
| 1/4 | 1 1/4 | 3 | 7 | 25 |
| 3/10 | 1 4/10 | 3 2/10 | 7 1/2 | 30 |
| 4/10 | 1 1/2 | 3 1/2 | 8 | — |
| 1/2 | 1 6/10 | 4 | 9 | — |

| SERIES | AMPERAGE | CATALOG NUMBER | ORDERING NUMBER |
|--------|----------|----------------|-----------------|
| KLDR | 10 | KLDR010 | KLDR010.T |

Web Resources

For additional information, visit:
www.littelfuse.com/klDR

Recommended Fuse Holders

| | |
|----------------------|-----|
| L60030C Series | 99 |
| LPSC Series | 108 |

Dimensions

Please refer to the Class CC/CD dimensions..... 31

KLKR Series
600 VAC/300 VDC • Fast-Acting • 1/10-30 A



Description

KLKR Series Class CC fuses are fast-acting fuses intended for general purpose branch circuit protection. Their compact size, fast-acting overload response, and highly current-limiting design make them ideal for use in OEM equipment and control panels.

Specifications

| | |
|-----------------------------|---|
| Voltage Ratings | AC: 600 V DC: 300 V |
| Interrupting Ratings | AC: 200 kA rms symmetrical DC: 20 kA |
| Ampere Range | 1/10 – 30 A |
| Approvals | AC: Standard 248-4, Class CC UL Listed 1/10-30 A (File No. E81895) CSA Certified 1/10-30 A (File No. LR29862) |
| Environmental | DC: Littelfuse self-certified RoHS Compliant |

Ordering Information

| AMPERE RATINGS | | | | |
|----------------|-------|-------|----|----|
| 1/10 | 1/2 | 2 1/2 | 6 | 12 |
| 1/8 | 3/4 | 3 | 7 | 15 |
| 2/10 | 1 | 3 1/2 | 8 | 20 |
| 1/4 | 1 1/2 | 4 | 9 | 25 |
| 3/10 | 2 | 5 | 10 | 30 |

| SERIES | AMPERAGE | CATALOG NUMBER | ORDERING NUMBER |
|--------|----------|----------------|-----------------|
| KLKR | 12 | KLKR012 | KLKR012.T |

Web Resources

For additional information, visit:
www.littelfuse.com/klkr

Recommended Fuse Holders

| | |
|----------------------|-----|
| L60030C Series | 99 |
| LPSC Series | 108 |

Dimensions

Please refer to the Class CC/CD dimensions..... 31

CLASS CC/CD DIMENSIONS AND CURRENT-LIMITING EFFECTS

Dimensions Inches (mm)

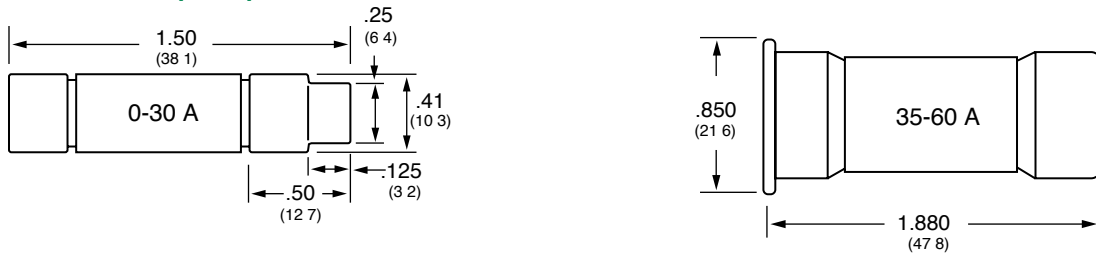

Current-Limiting Effects of CCMR (600 V) fuses

| SHORT CIRCUIT CURRENT* | APPARENT RMS SYMMETRICAL CURRENT FOR VARIOUS FUSE RATINGS | | | | | | | |
|------------------------|---|-----|------|------|-------|-------|-------|-------|
| | 2 A | 4 A | 6¼ A | 10 A | 12 A | 15 A | 20 A | 30 A |
| 5,000 | 160 | 190 | 330 | 370 | 525 | 600 | 625 | 750 |
| 10,000 | 180 | 220 | 400 | 440 | 600 | 700 | 725 | 875 |
| 15,000 | 200 | 250 | 430 | 480 | 675 | 775 | 800 | 950 |
| 20,000 | 220 | 260 | 460 | 520 | 720 | 825 | 850 | 1,000 |
| 25,000 | 230 | 280 | 480 | 550 | 750 | 850 | 900 | 1,050 |
| 30,000 | 240 | 290 | 500 | 570 | 800 | 900 | 950 | 1,125 |
| 35,000 | 245 | 300 | 520 | 590 | 825 | 925 | 975 | 1,175 |
| 40,000 | 255 | 310 | 550 | 600 | 850 | 975 | 1,000 | 1,200 |
| 50,000 | 260 | 330 | 570 | 640 | 875 | 1,000 | 1,100 | 1,300 |
| 60,000 | 280 | 340 | 600 | 670 | 900 | 1,050 | 1,125 | 1,350 |
| 80,000 | 300 | 360 | 625 | 700 | 1,000 | 1,125 | 1,200 | 1,400 |
| 100,000 | 310 | 380 | 650 | 750 | 1,050 | 1,200 | 1,250 | 1,500 |
| 150,000 | 340 | 420 | 700 | 800 | 1,150 | 1,300 | 1,400 | 1,600 |
| 200,000 | 350 | 440 | 750 | 850 | 1,200 | 1,400 | 1,450 | 1,750 |

*Prospective RMS Symmetrical Amperes Short-Circuit Current
Note: Data Derived from Peak Let-Thru Curves

Peak Let-Thru Curve KLDR

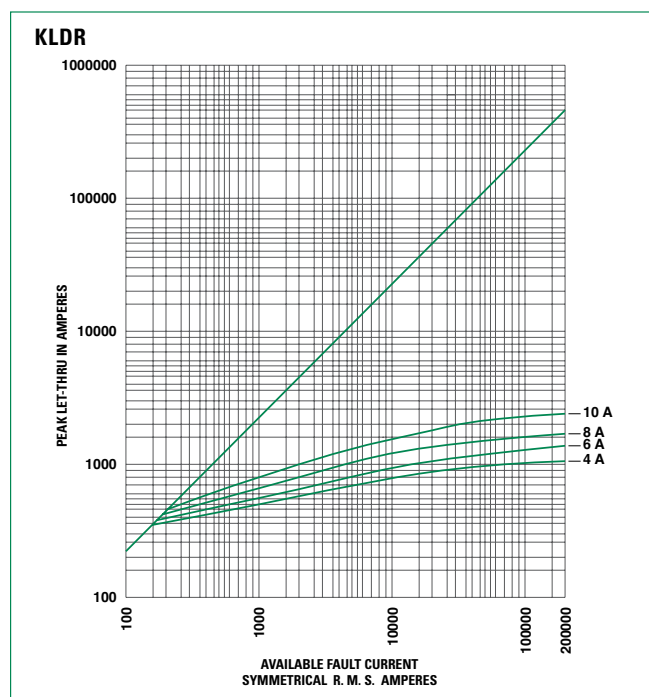

Peak Let-Thru Curve KLKR

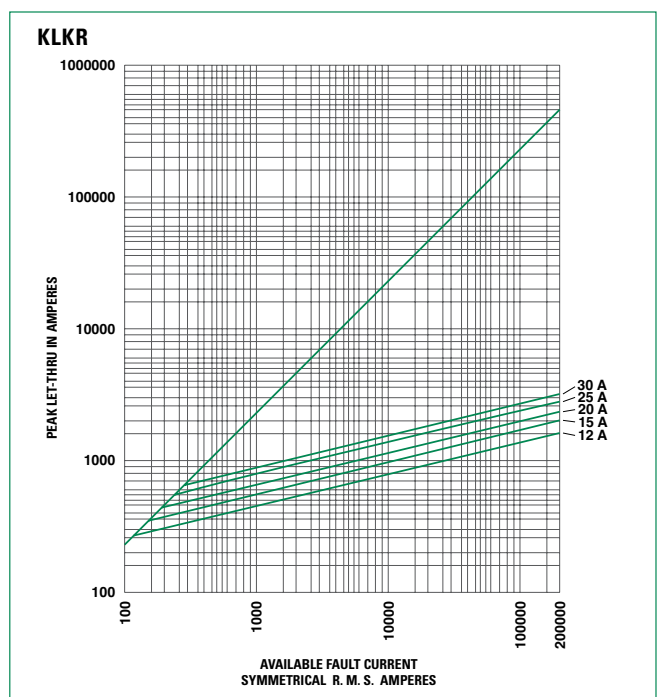

10 X 38 MIDGET FUSES

UL Supplemental Fuses 1

KLK Series
Fast-Acting Fuse 600 VAC

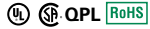

| AMPERE RATINGS | | | |
|----------------|-------|----|----|
| 1/10 | 1 | 5 | 15 |
| 1/8 | 1 1/2 | 6 | 20 |
| 2/10 | 2 | 7 | 25 |
| 1/4 | 2 1/2 | 8 | 30 |
| 3/10 | 3 | 9 | — |
| 1/2 | 3 1/2 | 10 | — |
| 3/4 | 4 | 12 | — |

Specifications

Fast-acting, high-interrupting capacity fuse designed for control circuits, HID lighting, street-lighting, meter circuits.

- Voltage Ratings** 600 VAC
500 VDC
- Interrupting Ratings** 100 kA @ 600 VAC
50 kA @ 500 VDC
(capable of 200 kA)
- Dimensions** L 38.1mm (1 1/2")
D 10.31mm (13/32")

www.littelfuse.com/klk

KLKD Series
Fast-Acting Fuse
600 VAC/600 VDC



| AMPERE RATINGS | | | |
|----------------|-------|----|----|
| 1/10 | 1 | 5 | 15 |
| 1/8 | 1 1/2 | 6 | 20 |
| 2/10 | 2 | 7 | 25 |
| 1/4 | 2 1/2 | 8 | 30 |
| 3/10 | 3 | 9 | — |
| 1/2 | 3 1/2 | 10 | — |
| 3/4 | 4 | 12 | — |

Specifications



Fast-acting, high DC rated fuse used in solar combiner boxes, DC control circuits, UPS protection. Available in standard and board mount configurations (PCB).

- Voltage Ratings** 600 VAC/DC
- Interrupting Ratings** 100 kA @ 600 VAC
10 kA @ 600 VDC (UL2579)
50 kA @ 600 VDC (UL248-14)
(capable of 200 kA)
- Dimensions** L 38.1mm (1 1/2")
D 10.31mm (13/32")

www.littelfuse.com/klkd

FLM Series
Time-Delay Fuse 250 VAC



| AMPERE RATINGS | | | |
|----------------|--------|--------|----|
| 1/10 | 1 1/8 | 3 | 8 |
| 15/100 | 1 1/4 | 3 2/10 | 9 |
| 2/10 | 1 4/10 | 3 1/2 | 10 |
| 1/4 | 1 1/2 | 4 | 12 |
| 3/10 | 1 6/10 | 4 1/2 | 15 |
| 4/10 | 1 8/10 | 5 | 20 |
| 1/2 | 2 | 5 6/10 | 25 |
| 6/10 | 2 1/4 | 6 | 30 |
| 8/10 | 2 1/2 | 6 1/4 | — |
| 1 | 2 8/10 | 7 | — |

Specifications

250V time-delay fuses used to protect circuits with high in-rush. Especially suited for supplemental protection of small motors.

- Voltage Ratings** 250 VAC
125 VDC self-certified @ 10 kA
- Interrupting Ratings** 10 kA @ 250 VAC
- Dimensions** L 38.1mm (1 1/2")
D 10.31mm (13/32")

www.littelfuse.com/flm

FLQ Series
Time-Delay Fuse 500 VAC



| AMPERE RATINGS | | | |
|----------------|--------|--------|----|
| 1/10 | 8/10 | 3 2/10 | 9 |
| 1/8 | 1 | 3 1/2 | 10 |
| 15/100 | 1 1/8 | 4 | 12 |
| 3/16 | 1 1/4 | 4 1/2 | 14 |
| 2/10 | 1 1/2 | 5 | 15 |
| 1/4 | 1 6/10 | 5 6/10 | 20 |
| 3/10 | 2 | 6 | 25 |
| 4/10 | 2 1/4 | 6 1/4 | 30 |
| 1/2 | 2 1/2 | 7 | — |
| 6/10 | 3 | 8 | — |

Specifications

500V time-delay fuses for supplemental protection of control power transformers, solenoids, and circuits with high in-rush. Ideal for 480 V systems.

- Voltage Ratings** 500 VAC
300 VDC self-certified @ 10 kA
- Interrupting Ratings** 10 kA @ 500V AC
- Dimensions** L 38.1mm (1 1/2")
D 10.31mm (13/32")

www.littelfuse.com/flq

BLN Series
Fiber Body Fast-Acting Fuse
250 VAC

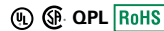

| AMPERE RATINGS | | | | |
|----------------|---|----|----|----|
| 1 | 4 | 8 | 15 | 30 |
| 2 | 5 | 10 | 20 | — |
| 3 | 6 | 12 | 25 | — |

Specifications

Fiber tube, 250 volt BLN fuses provide low-cost protection for military applications and control circuits.

- Voltage Ratings** 250 VAC
- Interrupting Ratings** 10 kA @ 250 VAC
- Dimensions** L 38.1mm (1 1/2")
D 10.31mm (13/32")

www.littelfuse.com/bln

BLF Series
Laminated Fast-Acting Fuse
125/250 VAC



| AMPERE RATINGS | | | |
|----------------|-------|----|----|
| 1/2 | 3 | 7 | 15 |
| 1 | 4 | 8 | 20 |
| 1 1/2 | 5 | 9 | 25 |
| 2 | 6 | 10 | 30 |
| 2 1/2 | 6 1/4 | 12 | — |

Specifications

Laminated tube BLF fuses are the lowest price midget fuse. They are suitable for control circuit and instrument protection in dry locations.

- Voltage Ratings** 250 VAC 1/2 - 15 A;
125 VAC 20 - 30 A
- Interrupting Ratings** 10 kA @ rated VAC
- Dimensions** L 38.1mm (1 1/2")
D 10.31mm (13/32")

www.littelfuse.com/blf

10 X 38 MIDGET FUSES

BLS Series Fast-Acting Fuse 600 VAC/250 VAC



| AMPERE RATINGS | | | |
|----------------|--------|---|----|
| 2/10 | 1 | 3 | 8 |
| 4/10 | 1 1/2 | 4 | 10 |
| 1/2 | 1 6/10 | 5 | — |
| 3/4 | 1 8/10 | 6 | — |
| 8/10 | 2 | 7 | — |

Specifications

Slightly shorter than a traditional 10 x 38, BLS fuses provide space saving protection for low amperage applications.

Voltage Ratings 600 VAC 2/10 - 5 A;
250 VAC 6 - 10 A

Interrupting Ratings 10 kA @ rated VAC

Dimensions L 34.9 mm (1 3/8")
D 10.31 mm (13/32")

www.littelfuse.com/bls

KLQ Series Increased Time-Delay 600 VAC



| AMPERE RATINGS | | |
|----------------|---|---|
| 1 | 2 | 5 |
| 1 6/10 | 3 | 6 |

Specifications

Same physical size as the BLS fuse with more time delay. Designed to protect gaseous vapor fixtures, HID ballasts and other electronic lighting circuits.

Voltage Ratings 600 VAC

Interrupting Ratings 10 kA @ rated VAC

Dimensions L 34.9 mm (1 3/8")
D 10.31 mm (13/32")

www.littelfuse.com/klq

FLA Series Time-Delay Pin Indicating Fuse 125 VAC



| AMPERE RATINGS | | | |
|----------------|--------|--------|-----|
| 1/10 | 1 1/8 | 3 | 8 |
| 15/100 | 1 1/4 | 3 2/10 | 10 |
| 2/10 | 1 4/10 | 3 1/2 | 12* |
| 1/4 | 1 1/2 | 4 | 15* |
| 3/10 | 1 6/10 | 4 1/2 | 20* |
| 4/10 | 1 8/10 | 5 | 25* |
| 1/2 | 2 | 5 6/10 | 30* |
| 6/10 | 2 1/4 | 6 | — |
| 8/10 | 2 1/2 | 6 1/4 | — |
| 1 | 2 8/10 | 7 | — |

*12-30 A are dual tube design

Specifications

Pin indicating time-delay fuses. Use in conjunction with special fuse blocks to operate mechanical signal switches or energize alarm circuits.

Voltage Ratings 125 VAC

Interrupting Ratings 10 kA @ rated VAC

Dimensions L 38.1 mm (1 1/2")
D 10.31 mm (13/32")

www.littelfuse.com/fla

FLU Series Multimeter Protection 1000 VAC/VDC



Specifications

Multimeter protection fuses.

Voltage Rating 1000 VAC/VDC

Interrupting Rating 44/100 A: 10 kA
11 A: 20 kA







Ampere Ratings 44/100 & 11 A

Approvals UL Recognized (File No. E10480)
CSA Certified (File No. LR29862)

Dimensions 44/100 A: 13/32" x 1 3/8"
11 A: 13/32" x 1 1/2"

www.littelfuse.com/flu

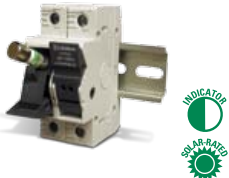
10 x 38 Midget Holder Configurations

| STANDARD | TOUCH SAFE QUICK CONNECT | BOARD MOUNT |
|---|--|---|
|  |  |  |
| L60030M pg. 99 | LPSM QC pg.111 | L60030MPCB pg. 101 |
| TOUCH SAFE | | |
|  |  |  |
| LPSM pg. 108 | LFPHV pg. 112 | UP-LINK™ pg. 107 |

Section Overview

Diverse application needs require a broad range of fuses. Littelfuse offers a full line of fuses for various applications. As the market leader in Automotive and Electronics fuses, we are able to deliver innovative circuit protection solutions to our customers. Visit www.littelfuse.com for our full line of Automotive and Electronics solutions.



ELECTRONIC FUSES AND BLADE FUSES



Table of Contents

| | |
|------------------------------|-------|
| Glass/Electronic Fuses | 35-37 |
| Automotive/Blade Fuses | 38-39 |

HIGH DC VOLTAGE AND PC BOARD MOUNT FUSES

505 Series Lead-Free 3AB, Fast-Acting

UL CE



| AMPERE RATINGS | | |
|----------------|----|----|
| 10 | 16 | 25 |
| 12 | 20 | 30 |

Specifications

A 500 VAC/VDC rated ceramic fuse with remarkable interrupting rating in a compact 6.3 x 32 mm package, well suited for circuit protection in high energy applications.

Voltage Rating 450 VAC/DC (10 – 12 A)
250 VDC (10 – 12 A)
500 VAC/DC (16 – 30 A)

Sample Part 0505010.MXP*

Axial Lead 505_XEP Series

www.littelfuse.com/505

*Bulk configurations only

477 Series 5 x 20 mm Slo-Blo® Fuse

UL



| AMPERE RATINGS | | | |
|----------------|------|-----|----|
| .5 | 2 | 5 | 10 |
| .8 | 3.15 | 6.3 | 12 |
| 1 | 4 | 8 | 16 |

Specifications

500 VAC/400 VDC rated, 5 x 20 mm, time-lag, surge withstand ceramic body fuse.

Voltage Rating 500 VAC
400 VDC

Sample Part 0477002.MXP*

Axial Lead 477_XEP Series

www.littelfuse.com/477

*Bulk configurations only

Dimensions mm (inches)

3AG/3AB

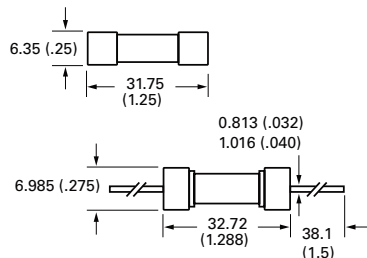

2AG

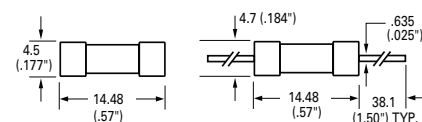

5 x 20 mm

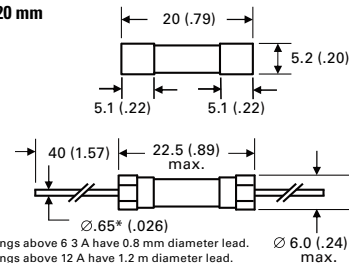

273 Series Fast-Acting Microfuse

UL SF RoHS



| AMPERE RATINGS | | | | | |
|----------------|------|------|------|-------|---|
| 1/500 | 1/32 | 1/8 | 4/10 | 3/4 | 2 |
| 1/200 | 1/20 | 2/10 | 1/2 | 8/10 | 3 |
| 1/100 | 1/16 | 1/4 | 6/10 | 1 | 4 |
| 1/64 | 1/10 | 3/10 | 7/10 | 1 1/2 | 5 |

Specifications

Similar to 272 and 278 series, except has transparent cap for visual indication of fuse status.

*See web for approvals by part.

Voltage Rating 125 VAC/DC

Sample Part 0273002.V

www.littelfuse.com/273

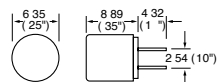

251 Series Fast-Acting Pico® II Fuse

UL SF RoHS



| AMPERE RATINGS | | | | | |
|----------------|-----|-------|-------|---|----|
| 1/16 | 3/8 | 1 | 2 1/2 | 4 | 10 |
| 1/8 | 1/2 | 1 1/2 | 3 | 5 | 12 |
| 1/4 | 3/4 | 2 | 3 1/2 | 7 | 15 |

Specifications

Subminiature fuse for soldered mounting on printed circuit boards. Available on tape and reel for automatic insertion.

*See web for approvals by part.

Voltage Ratings 125 V 1/16 – 10 A
32 V 12 – 15 A

Sample Part 0251001.NAT1L

www.littelfuse.com/251

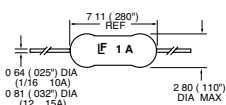

451 Series NANO²® Very Fast-Acting

UL SF RoHS



Add "L" suffix when ordering RoHS compliant 451 series

| AMPERE RATINGS | | | | | |
|----------------|-------|------|------|----|----|
| 0.01 | 0.187 | .075 | 2 | 7 | 30 |
| 0.031 | 0.2 | 1 | 2.25 | 8 | 35 |
| 0.062 | 0.25 | 1.25 | 2.5 | 10 | — |
| 0.1 | 0.3 | 1.5 | 3 | 12 | — |
| 0.125 | 0.375 | 1.6 | 4 | 15 | — |
| 0.15 | 0.5 | 1.75 | 5 | 20 | — |
| 0.175 | 0.6 | 1.8 | 6 | 25 | — |

Specifications

The Nano² SMF Fuse is a very small, Wire-in-Air (WIA) square shape surface mount fuse which is very suitable for the secondary side circuit over-current protection applications and is designed for PCB using surface mount technology

*See web for approvals by part.

Voltage Rating 65 – 125 V

Sample Part 0451.125MP

www.littelfuse.com/451

LEADED AND CARTRIDGE FUSES

Glass / Electronic Fuses 2

**312/318 Series
3AG Fast-Acting**



| AMPERE RATINGS | | | | | |
|----------------|------|--------|--------|----|----|
| 1/16 | 2/10 | 3/4 | 1 8/10 | 5 | 15 |
| 1/10 | 1/4 | 1 | 2 | 6 | 20 |
| 1/8 | 3/10 | 1 1/4 | 2 1/4 | 7 | 25 |
| 15/100 | 3/8 | 1 1/2 | 2 1/2 | 8 | 30 |
| 17.5/100 | 1/2 | 1 6/10 | 3 | 10 | 35 |
| 3/16 | 6/10 | 1 3/4 | 4 | 12 | — |

Specifications

Designed for fast-acting protection of electronic equipment and appliances. The "standard" fast-acting, glass tube fuse.

Voltage Ratings 250 VAC 1/100 – 10 A
32 VAC 12 – 35 A

Sample Part 0312005.VXP
www.littelfuse.com/312

For fuses with axial leads, request 318 Series.

**313/315 Series
3AG Slo-Blo®**



| AMPERE RATINGS | | | | | | |
|----------------|----------|--------|--------|--------|----|----|
| 1/100 | 17.5/100 | 1/2 | 1 1/4 | 2 8/10 | 7 | 30 |
| 1/32 | 3/16 | 6/10 | 1 1/2 | 3 | 8 | — |
| 4/100 | 2/10 | 7/10 | 1 6/10 | 3 2/10 | 10 | — |
| 1/16 | 1/4 | 3/4 | 1 8/10 | 4 | 12 | — |
| 1/10 | 3/10 | 8/10 | 2 | 5 | 15 | — |
| 1/8 | 3/8 | 1 | 2 1/4 | 6 1/4 | 20 | — |
| 15/100 | 4/10 | 1 2/10 | 2 1/2 | 6 3/10 | 25 | — |

Specifications

313 and 315 series fuses have time-delay in the overload range, which provides superior protection for inductive loads such as motors, transformers, and solenoids.

Voltage Ratings 250 VAC 1/100 – 8 A
32 VAC 10 – 30 A

Sample Part 0313005.VXP
www.littelfuse.com/313

For fuses with axial leads, request 315 Series.

**314/324 Series
3AB Fast-Acting**



| AMPERE RATINGS | | | | |
|----------------|---|----|----|----|
| 3/8 | 2 | 6 | 12 | 30 |
| 1/2 | 3 | 7 | 15 | 40 |
| 3/4 | 4 | 8 | 20 | — |
| 1 | 5 | 10 | 25 | — |

Specifications

Similar to 312 series, but ceramic tube permits higher interrupting ratings and voltage ratings: 250 volt ratings to 40 amps.

Voltage Rating 250 VAC 1/8 – 40 A
125 VDC 3/8 – 30 A
150 VDC 40 A

Sample Part 03145005.VXP

www.littelfuse.com/314

For fuses with axial leads, request 324 Series.

**326/325 Series
3AB Slo-Blo®**



| AMPERE RATINGS | | | | | |
|----------------|------|--------|--------|-------|----|
| 1/100 | 3/16 | 6/10 | 1 1/2 | 4 | 15 |
| 1/32 | 2/10 | 7/10 | 1 6/10 | 5 | 20 |
| 1/16 | 1/4 | 3/4 | 2 | 6 1/4 | 25 |
| 1/10 | 3/10 | 8/10 | 2 1/2 | 7 | 30 |
| 1/8 | 3/8 | 1 | 2 8/10 | 8 | — |
| 15/100 | 4/10 | 1 2/10 | 3 | 10 | — |
| 17.5/100 | 1/2 | 1 1/4 | 3 2/10 | 12 | — |

Specifications

The 326 series fuse has time-delay similar to the 313 series, but the ceramic body permits higher voltage ratings for the 8 – 30 ampere sizes and faster opening of short-circuits.

Voltage Ratings 250 VAC 1/100 – 30 A
125 VDC 1/4 – 3 A
125 VDC 12 – 30 A

Sample Part 0326.100VXP
www.littelfuse.com/326

For fuses with axial leads, request 325 Series.

**229/230 Series
2AG Slo-Blo®**



| AMPERE RATINGS | | | |
|----------------|-------|-------|---|
| 1/4 | 3/4 | 2 | 4 |
| .350 | 8/10 | 2 1/4 | 5 |
| 3/8 | 1 | 2 1/2 | 6 |
| 1/2 | 1 1/4 | 3 | 7 |
| 6/10 | 1 1/2 | 3 1/2 | — |

Specifications

2AG indicating fuses instantly identify themselves upon opening by showing a discoloration of their glass bodies, eliminating guesswork. This unique design offers the same quality performance characteristics as the standard 2AG fuse design.*

Voltage Ratings 250 VAC 1/4 – 3 1/2 A
125 VAC 4 – 7 A
125 VDC 1/4 – 7 A

Sample Part 02291.25VXP
www.littelfuse.com/229

For fuses with axial leads, request 230 Series.
*Must add "S" suffix when ordering indicating fuse

**225/224 Series
2AG Fast-Acting**



| AMPERE RATINGS | | | | |
|----------------|-------|-------|---|----|
| 3/8 | 1 | 2 1/2 | 4 | 7 |
| 1/2 | 1 1/2 | 3 | 5 | 8 |
| 3/4 | 2 | 3 1/2 | 6 | 10 |

Specifications

Fast-acting performance of the 312, 3AG fuses in less than one-third the space. For protection of electronic equipment and appliances.

Voltage Ratings 250 VAC 1/10 – 3 1/2 A
125 VAC 4 – 10 A
125 VDC 3/8 – 3 1/2 A

Sample Part 0225003.VXP

www.littelfuse.com/225

For fuses with axial leads, request 224 Series.

Note: All fuses on this page are available in packaged and bulk configurations

5 X 20 mm IEC LEADED AND CARTRIDGE FUSES

215 Series 5 x 20 mm IEC Slo-Blo®



| AMPERE RATINGS | | | | | | | |
|----------------|------|------|------|-----|----|----|--|
| .125 | .315 | .800 | 2 | 5 | 12 | 25 | |
| .160 | .400 | 1 | 2.5 | 6.3 | 15 | — | |
| .200 | .500 | 1.25 | 3.15 | 8 | 16 | — | |
| .250 | .630 | 1.6 | 4 | 10 | 20 | — | |

Specifications

Time-delay protection of electronic equipment and appliances when fuses to International Standards are required. Replacement fuse for foreign equipment.

Voltage Rating 250 VAC
Sample Part 0215005.VXP

www.littelfuse.com/215

For fuses with axial leads, request 215_XEP series.

216 Series 5 x 20 mm IEC Fast-Acting



| AMPERE RATINGS | | | | | | | |
|----------------|------|------|------|------|-----|------|--|
| .050 | .125 | .315 | .800 | 2 | 5 | 12.5 | |
| .063 | .160 | .400 | 1 | 2.5 | 6.3 | 16 | |
| .080 | .200 | .500 | 1.25 | 3.15 | 8 | — | |
| .100 | .250 | .630 | 1.6 | 4 | 10 | — | |

Specifications

Fast-acting protection of electronic equipment and appliances when fuses to International Standards are required. Replacement fuse for foreign equipment.

Voltage Rating 250 VAC
Sample Part 0216005.VXP

www.littelfuse.com/216

For fuses with axial leads, request 216_XEP series.

217 Series 5 x 20 mm IEC Fast-Acting



| AMPERE RATINGS | | | | | | | |
|----------------|------|------|------|------|------|----|--|
| .032 | .080 | .200 | .500 | 1.25 | 3.15 | 8 | |
| .040 | .100 | .250 | .630 | 1.6 | 4 | 10 | |
| .050 | .125 | .315 | .800 | 2 | 5 | 15 | |
| .063 | .160 | .400 | 1 | 2.5 | 6.3 | — | |

Specifications

Fast-acting protection of electronic equipment and appliances when fuses to International Standards are required. Replacement fuse for foreign equipment.

Voltage Rating 250 VAC
Sample Part 0217005.VXP

www.littelfuse.com/217

For fuses with axial leads, request 217_XEP series.

218 Series 5 x 20 mm IEC Slo-Blo®



| AMPERE RATINGS | | | | | | | |
|----------------|------|------|------|------|------|----|--|
| .032 | .080 | .200 | .500 | 1.25 | 3.15 | 8 | |
| .040 | .100 | .250 | .630 | 1.6 | 4 | 10 | |
| .050 | .125 | .315 | .800 | 2 | 5 | 15 | |
| .063 | .160 | .400 | 1 | 2.5 | 6.3 | 16 | |

Specifications

Time-delay protection of electronic equipment and appliances when fuses to International Standards are required. Replacement fuse for foreign equipment.

Voltage Rating 250 VAC
Sample Part 0218005.VXP

www.littelfuse.com/218

For fuses with axial leads, request 218_XEP series.

235 Series 5 x 20 mm UL/CSA Fast-Acting



| AMPERE RATINGS | | | | | | |
|----------------|------|-------|--------|-------|---|--|
| 1/10 | 3/10 | 7/10 | 1 6/10 | 3 1/2 | 7 | |
| 1/8 | 4/10 | 8/10 | 2 | 4 | — | |
| 2/10 | 1/2 | 1 | 2 1/2 | 5 | — | |
| 1/4 | 6/10 | 1 1/4 | 3 | 6 | — | |

Specifications

5 x 20 mm fuses designed to UL and CSA standards. Fast-acting protection of electronic equipment and appliances.

Voltage Ratings 250 VAC 1/10 – 3 1/2 A
125 VAC 4 – 7 A

Sample Part 0235005.VXP

www.littelfuse.com/235

For fuses with axial leads, request 235_XEP series.

239 Series 5 x 20 mm UL/CSA Slo-Blo®



| AMPERE RATINGS | | | | | | |
|----------------|------|------|--------|----------|--------|---|
| 8/100 | 2/10 | 1/2 | 8/10 | 2 | 3 2/10 | 7 |
| 1/10 | 1/4 | 6/10 | 1 | 2 1/2 | 3 1/2 | — |
| 1/8 | 3/10 | 7/10 | 1 1/4 | 3 | 4 | — |
| 15/100 | 4/10 | 3/4 | 1 6/10 | 3 15/100 | 5 | — |

Specifications

5 x 20 mm fuses designed to UL and CSA standards. Time-delay protection of electronic equipment and appliances.

Voltage Ratings 250 VAC 2/10 – 3 1/2 A
125 VAC 4 – 7 A

Sample Part 0239005.VXP

www.littelfuse.com/239

For fuses with axial leads, request 239_XEP series.

Note: All fuses on this page are available in packaged and bulk configurations

BLADE FUSES

Automotive / Blade Fuses 2

**MINI®
Smart Glow**

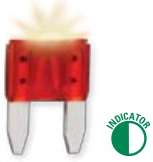

Specifications

Smart Glow fuses are innovative automotive style fuses (ATO, MINI, and MAXI) that feature an indicator light that glows when the fuse is blown, saving time to troubleshoot an open circuit.

Sample part # 0MIN010.VPGLO

Voltage Rating 14 VDC

www.littelfuse.com/smartglow

MINI Fuses are available in packaged and bulk configurations. See 297 series on web.

MINI® Fast-Acting



Specifications

The MINI® Fuse, with its miniature design patented by Littelfuse, meets the need for more circuits to be protected while utilizing less space.

Sample part # 0MIN020.V

Voltage Rating 32 VDC

www.littelfuse.com/mini

**Fuses Rated 58 V
Low Profile MINI®**



Specifications

The low profile MINI has similar performance as the standard mini fuse. The lower overall height allows for more space and weight savings.

Sample part # LMIN010.V

Voltage Rating 58 VDC

www.littelfuse.com/lmini

MINI dimensions in mm

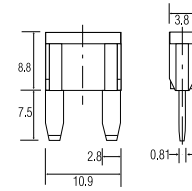

Low Profile MINI dimensions in mm (inches)

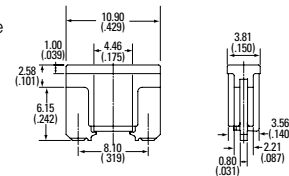

**ATO®
Smart Glow**



Specifications

Smart Glow fuses are innovative automotive style fuses (ATO, MINI, and MAXI) that feature indicator light that glows when the fuse is blown, saving time to troubleshoot an open circuit.

Sample part # 0ATO010.VPGLO

Voltage Rating 14 VDC

www.littelfuse.com/smartglow

ATO Fuses are available in packaged and bulk configurations. See 257 series on web.

ATO® Fast-Acting



Specifications

The ATO® Fuse was designed and patented by Littelfuse in 1976 and set the standard for automotive circuit protection. It features industry standard color coding to indicate amperage rating.

Sample part # 0ATO020.V

Voltage Rating 32 VAC/DC

www.littelfuse.com/ato

ATO dimensions in mm (inches)

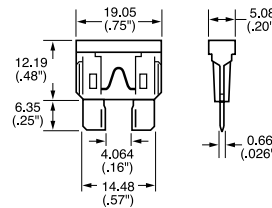

**ATO® / MINI®
Color Key**

| CURRENT RATING | HOUSING COLOR |
|----------------|---------------|
| 1 A | Black |
| 2 A | Grey |
| 3 A | Purple |
| 4 A | Pink |
| 5 A | Brown |
| 7.5 A | Dark Brown |
| 10 A | Red |
| 15 A | Blue |
| 20 A | Yellow |
| 25 A | White |
| 30 A | Green |
| 40 A | Orange |

Note: MINI not available in 1 A or 40 A.

**MAXI™
Smart Glow**



Specifications

Smart Glow fuses are innovative automotive style fuses (ATO, MINI, and MAXI) that feature an indicator light that glows when the fuse is blown, saving time to troubleshoot an open circuit.

Sample part # 0MAX030.XPGLO

Voltage Rating 14 VDC

www.littelfuse.com/smartglow

MAXI Fuses are available in packaged and bulk configurations. See 299 series on web.

MAXI™ Slo-Blo



Specifications

Designed and patented by Littelfuse, the MAXI™ Fuse is ideal for motor powered applications which have large inrush currents.

Sample part # 0MAX030.X

Voltage Rating 32 VDC

www.littelfuse.com/maxi

MAXI dimensions in mm (inches)

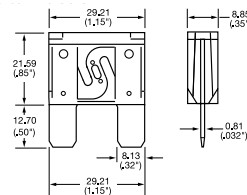

**MAXI™
Color Key**

| CURRENT RATING | HOUSING COLOR |
|----------------|---------------|
| 20 A | Yellow |
| 25 A | Grey |
| 30 A | Green |
| 35 A | Brown |
| 40 A | Orange |
| 50 A | Red |
| 60 A | Blue |
| 70 A | Dark Brown |
| 80 A | White |

BLADE FUSES

FHA Blade Fuse Holders—In-Line Fuse Holder for ATO® Style Blade Fuse

RoHS



Dimensions in mm

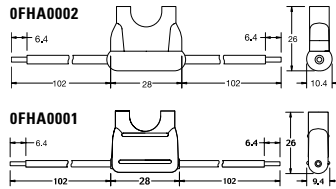

Used with ATO Fuse 1 to 20 A or 25 A and 30 A. Supplied with two 4" (102 mm) wire leads.

www.littelfuse.com/fha

| PART NUMBER | DESCRIPTION | FUSE RATING |
|-------------|---|-------------|
| OFHA0001_ | 16AWG/1.3mm ² STRANDED BLACK WIRE | 20 A |
| OFHA0002_ | 12AWG/3.3mm ² STRANDED ORANGE WIRE | 30 A |

Wire length, color and diameter can be customized upon request.

FHAC Blade Fuse Holders—In-Line Splash-Waterproof Fuse Holder for ATO® Style Blade Fuse

RoHS



Dimensions in mm

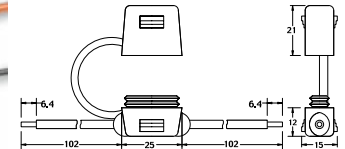

Used with ATO Fuse 1 to 20 A or 25 A and 30 A. Supplied with two 4" (102 mm) wire leads. Includes protective cover for harsh environment.

www.littelfuse.com/fha

| PART NUMBER | DESCRIPTION | FUSE RATING |
|-------------|---|-------------|
| FHAC0001_ | 16AWG/1.3mm ² STRANDED BLACK WIRE | 20 A |
| FHAC0002_ | 12AWG/3.3mm ² STRANDED ORANGE WIRE | 30 A |

Wire length, color and diameter can be customized upon request.

FHM Blade Fuse Holders—In-Line Splash-Waterproof Fuse Holder for MINI® Style Blade Fuse

RoHS

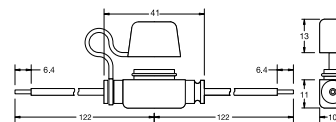

Used with MINI Fuse 1 to 20 A or 25 A and 30 A. Supplied with two 4.78" (122 mm) wire leads. Includes protective cover for harsh environment.

www.littelfuse.com/fhm

| PART NUMBER | DESCRIPTION | FUSE RATING |
|-------------|---|-------------|
| OFHM0001_ | 14AWG/2.1mm ² STRANDED BLACK WIRE | 20 A |
| OFHM0002_ | 12AWG/3.3mm ² STRANDED ORANGE WIRE | 30 A |

Wire length, color and diameter can be customized upon request.

MAH Blade Fuse Holders—In-Line Fuse Holder for MAXI™ Style Blade Fuse



Dimensions in mm

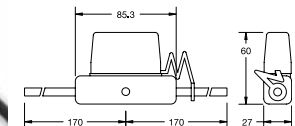

Supplied with two 6", 6-gauge wire leads for up to 60 A MAXI Fuse applications, this In-Line Fuse holder also provides a protective cover for harsh under-the-hood environments. Mounting hole permits easy bulkhead installation.

www.littelfuse.com/mah

| PART NUMBER | DESCRIPTION | FUSE RATING |
|-------------|------------------|-------------|
| 0MAH0001Z | WIRE COLOR BLACK | 60 A |

JCASE® Cartridge Fuse Rated 32 V

RoHS Pb



Specifications

The JCASE is a cartridge style fuse with female terminal design. JCASE provides both increased time delay and low voltage drop to protect high current circuits. JCASE has the ability to handle in-rush currents. The JCASE was designed and patented by Littelfuse.

www.littelfuse.com/jcase

Low Profile JCASE® Fuse Rated 58 V

RoHS Pb



Specifications

The Low Profile JCASE fuse has similar performance characteristics as the standard JCASE fuse. The lower overall height reduction allows for more space and weight savings and also allows for a shorter male blade terminal, saving additional weight and material savings in fuse box designs.

www.littelfuse.com/ljcase

JCASE® 32 V Dimensions in mm

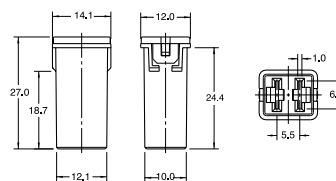

Low Profile JCASE® 58 V Dimensions in mm

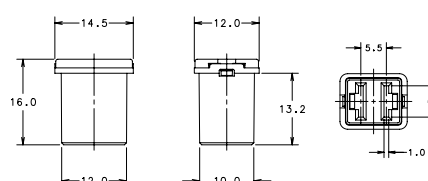

JCASE® Color Key

| CURRENT RATING | HOUSING COLOR |
|----------------|---------------|
| 20 A | Blue |
| 25 A | White |
| 30 A | Pink |
| 40 A | Green |
| 50 A | Red |
| 60 A | Yellow |

Section Overview

Littelfuse is your source for a fast replacement of E- and R-rated medium voltage fuses. Our emergency service gets you the fuses you need quickly to minimize downtime of your critical operations.



MEDIUM VOLTAGE FUSES

Table of Contents

| | |
|-------------------------------------|----|
| Medium Voltage Fuses Overview | 41 |
| R-Rated Medium Voltage Fuses | 42 |
| E-Rated Medium Voltage Fuses | 44 |

MEDIUM VOLTAGE FUSES

2,400-38,000 VAC • Current-Limiting



Description

Littelfuse® offers a selection of E- and R-rated medium voltage fuses for the protection of transformers, potential transformers, feeders, and motor circuits. Single, double, and triple barrel designs are available to cover a wide range of current, voltage, and interrupting ratings. Conventional ferrule type, clip lock, and bolt-in mounting configurations are available for virtually any application. Hermetically sealed fuses for use in hazardous environments are also offered.

Contact the factory or your local Littelfuse representative for additional fuse ratings or custom mounting configurations.

24-Hour Emergency Service - Call 800-227-0029, Option 6.

Applications

- Power Transformer Protection
- Potential Transformer Protection
- Motor Controller Back-up Protection
- Fused Switches
- Feeder Circuits



Current-limiting E- and R-rated fuses are equipped with a mechanical indicator or striker pin that protrudes through the fuse cap upon operation of the fuse. This provides visual identification of a blown fuse and can be used as a trigger for external devices.

Note: Extension distance 1/2" minimum; extension force 2 lb. minimum.

General Information

The terms "Medium Voltage" and "High Voltage" have been used interchangeably by many people to describe fuses operating above 600 volts. Technically speaking, medium voltage fuses are those intended for the voltage range from 2,400 to 38,000 VAC. High voltage fuses are for circuits carrying voltages greater than 38,000 VAC.

E-rated fuses are considered to be general purpose fuses and can be used to protect against low and high values of fault current. R-rated fuses are designed for back-up protection. They must be used in series with other devices such as motor overload relays in order to achieve both overload and short-circuit protection.

Medium voltage fuses are not intended to provide overload protection in the same sense as fuses rated 600 volts or less. Medium voltage fuse current ratings do not have the same meanings as the ampere ratings of low voltage fuses.

All medium voltage fuses are limited in their ability to interrupt low value overcurrents, especially those between 100% and 200% of the fuse's continuous current rating. They are designed to carry their rated current without exceeding the temperature rise permitted by NEMA and ANSI standards.



Bolt-in Mount Fuses

R-RATED MEDIUM VOLTAGE FUSES

Current-Limiting

Description

R-rated fuses provide required short-circuit protection for medium voltage motors, motor controllers and associated circuitry. These components have limited ability to absorb the energy of large short-circuit currents. Medium voltage motor controllers contain overload relays which provide both overload protection and locked rotor protection to the motor. The controllers are also intended to interrupt low value short-circuits within the capability of the motor controller. This protects the medium voltage fuse from sustained overcurrents which are less than their minimum interrupting rating.

NEMA Standards for R-rated medium voltage power fuses require they operate within 15-35 seconds when subjected to an rms current 100 times the R rating. For example, a fuse with a 2R rating will open within 15 to 35 seconds on an applied current of $2 \times 100 = 200$ amperes.

Characteristics

Voltage Ratings 2,750 V – 8,250 V
Current Range 2R – 36R

Options

- Hermetically sealed for use in hazardous locations (add "S" suffix to part number)
- Bolt-in mounting configurations



Hookeye Feature*

For hookeye attachment; add "W" suffix to part number

*See web for Bolt Mount, Inverted Bolt Mount, and Bolt-W dimensions

Ordering Number

130-4R-1C-5.5

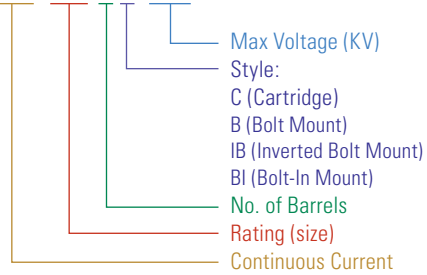

Dimensions

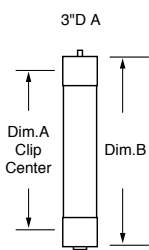

Figure 1

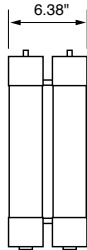

Figure 2

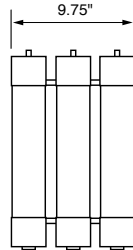
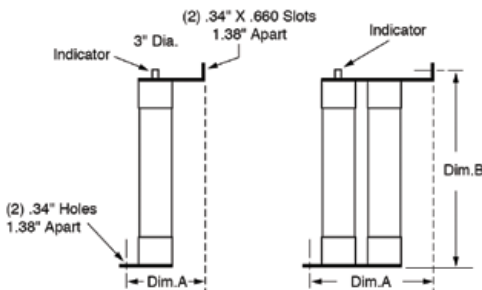

Figure 3

Cartridge "C"



Bolt Mount "B"

Sample Part #: 130-4R-1B-5.5

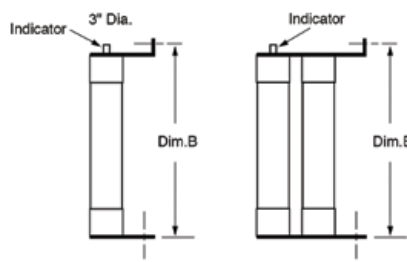

Inverted-Bolt "IB"

Sample Part #: 130-4R-1IB-5.5

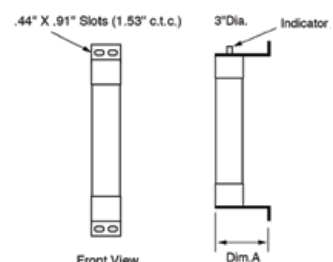

Bolt-In Mount "BI"

Sample Part #: 130-4R-1BI-5.5

Medium Voltage Fuse Protection

POWR-GARD® medium voltage fuses provide short-circuit protection for motors and transformers rated 2,400 to 38,000 volts AC.

Visit www.littelfuse.com/technicalcenter for additional protection tables, sizing recommendations, and applications.



R-RATED MEDIUM VOLTAGE FUSES

Current-Limiting

| R RATED | ORDERING/ CATALOG NUMBER | SIZE | MAXIMUM CONTINUOUS CURRENT @ 40 DEGREES C° | DIM. A (INCHES) | DIM. B (INCHES) | MINIMUM INTERRUPTING RATING RMS AMPS | MAXIMUM INTERRUPTING RATING RMS (ASYM)* | FIGURE NUMBER |
|----------------------------|--------------------------------|------|---|--------------------|--------------------|---|--|------------------|
| 2.75 KV | 702R1C2.75 | 2R | 70 | 7" | 10.875" | 170 | 80,000 | 1 |
| | 1003R1C2.75 | 3R | 100 | 7" | 10.875" | 250 | 80,000 | 1 |
| | 1304R1C2.75 | 4R | 130 | 7" | 10.875" | 340 | 80,000 | 1 |
| | 1505R1C2.75 | 5R | 150 | 7" | 10.875" | 390 | 80,000 | 1 |
| | 1706R1C2.75 | 6R | 170 | 7" | 10.875" | 500 | 80,000 | 1 |
| | 2009R1C2.75 | 9R | 200 | 7" | 10.875" | 760 | 80,000 | 1 |
| | 23012R1C2.75 | 12R | 230 | 7" | 10.875" | 1000 | 80,000 | 1 |
| | 39018R2C2.75 | 18R | 390 | 7" | 10.875" | 1500 | 80,000 | 2 |
| 45024R2C2.75 | 24R | 450 | 7" | 10.875" | 1950 | 80,000 | 2 | |
| R RATED | ORDERING/ CATALOG NUMBER | SIZE | MAXIMUM CONTINUOUS CURRENT @ 40 DEGREES C° | DIM. A (INCHES) | DIM. B (INCHES) | MINIMUM INTERRUPTING RATING RMS AMPS | MAXIMUM INTERRUPTING RATING RMS (ASYM)* | FIGURE NUMBER |
| 5.5 KV | 702R1C5.5 | 2R | 70 | 12" | 15.875" | 170 | 80,000 | 1 |
| | 1003R1C5.5 | 3R | 100 | 12" | 15.875" | 250 | 80,000 | 1 |
| | 1304R1C5.5 | 4R | 130 | 12" | 15.875" | 340 | 80,000 | 1 |
| | 1505R1C5.5 | 5R | 150 | 12" | 15.875" | 390 | 80,000 | 1 |
| | 1706R1C5.5 | 6R | 170 | 12" | 15.875" | 500 | 80,000 | 1 |
| | 2009R1C5.5 | 9R | 200 | 12" | 15.875" | 760 | 80,000 | 1 |
| | 23012R1C5.5 | 12R | 230 | 12" | 15.875" | 1000 | 80,000 | 1 |
| | 39018R2C5.5 | 18R | 390 | 12" | 15.875" | 1500 | 80,000 | 2 |
| | 45024R2C5.5 | 24R | 450 | 12" | 15.875" | 1950 | 80,000 | 2 |
| | 48026R2C5.5 | 26R | 480 | 12" | 15.875" | 2100 | 80,000 | 2 |
| | 55030R2C5.5 | 30R | 550 | 12" | 15.875" | 2400 | 80,000 | 2 |
| | 60032R2C5.5 | 32R | 600 | 12" | 15.875" | 2600 | 80,000 | 2 |
| | 65036R2C5.5 | 36R | 650 | 12" | 15.875" | 2900 | 80,000 | 2 |
| | 55030R3C5.5 | 30R | 550 | 12" | 15.875" | 2400 | 80,000 | 3 |
| 60032R3C5.5 | 32R | 600 | 12" | 15.875" | 2600 | 80,000 | 3 | |
| 65036R3C5.5 | 36R | 650 | 12" | 15.875" | 2900 | 80,000 | 3 | |
| R RATED | ORDERING/ CATALOG NUMBER | SIZE | MAXIMUM CONTINUOUS CURRENT @ 40 DEGREES C° | DIM. A (INCHES) | DIM. B (INCHES) | MINIMUM INTERRUPTING RATING RMS AMPS | MAXIMUM INTERRUPTING RATING RMS (ASYM)* | FIGURE NUMBER |
| 5.5 KV 14" CLIP CENTERS | 702R1C5.5X | 2R | 70 | 14" | 17.875" | 170 | 80,000 | 1 |
| | 1003R1C5.5X | 3R | 100 | 14" | 17.875" | 250 | 80,000 | 1 |
| | 1304R1C5.5X | 4R | 130 | 14" | 17.875" | 340 | 80,000 | 1 |
| | 1505R1C5.5X | 5R | 150 | 14" | 17.875" | 390 | 80,000 | 1 |
| | 1706R1C5.5X | 6R | 170 | 14" | 17.875" | 500 | 80,000 | 1 |
| | 2009R1C5.5X | 9R | 200 | 14" | 17.875" | 760 | 80,000 | 1 |
| | 23012R1C5.5X | 12R | 230 | 14" | 17.875" | 1000 | 80,000 | 1 |
| | 39018R2C5.5X | 18R | 390 | 14" | 17.875" | 1500 | 80,000 | 2 |
| | 45024R2C5.5X | 24R | 450 | 14" | 17.875" | 1950 | 80,000 | 2 |
| 55030R2C5.5X | 30R | 550 | 14" | 17.875" | 2400 | 80,000 | 2 | |
| R RATED | ORDERING/ CATALOG NUMBER | SIZE | MAXIMUM CONTINUOUS CURRENT @ 40 DEGREES C° | DIM. A (INCHES) | DIM. B (INCHES) | MINIMUM INTERRUPTING RATING RMS AMPS | MAXIMUM INTERRUPTING RATING RMS (ASYM)* | FIGURE NUMBER |
| 8.25 KV | 702R1C8.25 | 2R | 70 | 12" | 15.875" | 190 | 80,000 | 1 |
| | 1003R1C8.25 | 3R | 100 | 12" | 15.875" | 225 | 80,000 | 1 |
| | 1304R1C8.25 | 4R | 130 | 12" | 15.875" | 330 | 80,000 | 1 |
| | 1505R1C8.25 | 5R | 150 | 12" | 15.875" | 440 | 80,000 | 1 |
| | 1706R1C8.25 | 6R | 170 | 12" | 15.875" | 500 | 80,000 | 1 |
| | 2009R1C8.25 | 9R | 200 | 12" | 15.875" | 740 | 80,000 | 1 |
| | 23012R1C8.25 | 12R | 230 | 12" | 15.875" | 955 | 80,000 | 1 |
| | 39018R2C8.25 | 18R | 390 | 12" | 15.875" | 1440 | 80,000 | 2 |
| 45024R2C8.25 | 24R | 450 | 12" | 15.875" | 1910 | 80,000 | 2 | |

* RMS Asymmetrical amperes = RMS Symmetrical amperes x 1.6

For hookey attachment add "W" suffix to part number

E-RATED MEDIUM VOLTAGE FUSES

Current-Limiting

Description

E-rated fuses have time current characteristics designed to provide current-limiting protection for power transformers, potential transformers, power centers, feeder centers, and unit sub stations. When properly applied, they can protect against high and low fault currents.

NEMA Standards for E-rated medium voltage fuses require that fuses rated 100E or less open within 300 seconds (5 minutes) when subjected to an RMS value of 200-240% of the fuse continuous current rating; and fuses with an E rating larger than 100E must open within 600 seconds (10 minutes) when subjected to an RMS current of 220-240% of the fuse's continuous current rating. These values establish one point on the time-current curve.

Application Note

Since these fuses are used for the protection of general purpose circuits which may contain transformers, motors, and other equipment producing in-rush and/or overload currents, fuses should generally be rated at 140% of the normal full load current, and circuits should be analyzed to ensure that system load currents will not exceed the current rating of the fuse.

Characteristics

Voltage Ratings 2,750 V – 38,000 V
Current Range 10E – 600E

Options

- Hermetically sealed for use in hazardous locations (add "S" suffix to part number)
- Clip-lock (CL) and bolt-in styles available.

Dimensions

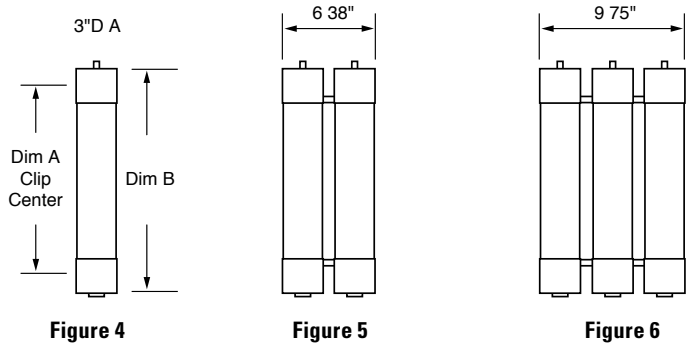

| E-RATED | ORDERING/CATALOG NUMBER | SIZE | DIM. A (INCHES) | DIM. B (INCHES) | MAX INTERRUPTING RATING RMS (ASYM)* | FIGURE NUMBER |
|--------------|-------------------------|------|-----------------|-----------------|-------------------------------------|---------------|
| 2.75 MAX. KV | 10E1C2.75 | 10E | 7" | 10.875" | 80,000 | 4 |
| | 15E1C2.75 | 15E | 7" | 10.875" | 80,000 | 4 |
| | 20E1C2.75 | 20E | 7" | 10.875" | 80,000 | 4 |
| | 25E1C2.75 | 25E | 7" | 10.875" | 80,000 | 4 |
| | 30E1C2.75 | 30E | 7" | 10.875" | 80,000 | 4 |
| | 40E1C2.75 | 40E | 7" | 10.875" | 80,000 | 4 |
| | 50E1C2.75 | 50E | 7" | 10.875" | 80,000 | 4 |
| | 65E1C2.75 | 65E | 7" | 10.875" | 80,000 | 4 |
| | 80E1C2.75 | 80E | 7" | 10.875" | 80,000 | 4 |
| | 100E-1C2.75 | 100E | 7" | 10.875" | 80,000 | 4 |
| | 125E1C2.75 | 125E | 7" | 10.875" | 80,000 | 4 |
| | 150E1C2.75 | 150E | 7" | 10.875" | 80,000 | 4 |
| | 200E1C2.75 | 200E | 7" | 10.875" | 80,000 | 4 |
| | 125E2C2.75 | 125E | 7" | 10.875" | 80,000 | 5 |
| | 150E2C2.75 | 150E | 7" | 10.875" | 80,000 | 5 |
| | 200E2C2.75 | 200E | 7" | 10.875" | 80,000 | 5 |
| | 225E2C2.75 | 225E | 7" | 10.875" | 80,000 | 5 |
| | 250E2C2.75 | 250E | 7" | 10.875" | 80,000 | 5 |
| | 300E2C2.75 | 300E | 7" | 10.875" | 80,000 | 5 |
| | 350E2C2.75 | 350E | 7" | 10.875" | 80,000 | 5 |
| 400E2C2.75 | 400E | 7" | 10.875" | 80,000 | 5 | |
| 450E2C2.75 | 450E | 7" | 10.875" | 80,000 | 5 | |

* RMS Asymmetrical amperes = RMS Symmetrical amperes x 1.6

E-RATED MEDIUM VOLTAGE FUSES

Current-Limiting

| E-RATED | ORDERING/CATALOG NUMBER | SIZE | DIM. A (INCHES) | DIM. B (INCHES) | MAX INTERRUPTING RATING RMS (ASYM)* | FIGURE NUMBER |
|-------------|-------------------------|------|-----------------|-----------------|-------------------------------------|---------------|
| 5.5 MAX. KV | 10E1C5.5 | 10E | 12" | 15.875" | 80,000 | 4 |
| | 15E1C5.5 | 15E | 12" | 15.875" | 80,000 | 4 |
| | 20E1C5.5 | 20E | 12" | 15.875" | 80,000 | 4 |
| | 25E1C5.5 | 25E | 12" | 15.875" | 80,000 | 4 |
| | 30E1C5.5 | 30E | 12" | 15.875" | 80,000 | 4 |
| | 40E1C5.5 | 40E | 12" | 15.875" | 80,000 | 4 |
| | 50E1C5.5 | 50E | 12" | 15.875" | 80,000 | 4 |
| | 65E1C5.5 | 65E | 12" | 15.875" | 80,000 | 4 |
| | 80E1C5.5 | 80E | 12" | 15.875" | 80,000 | 4 |
| | 100E1C5.5 | 100E | 12" | 15.875" | 80,000 | 4 |
| | 125E1C5.5 | 125E | 12" | 15.875" | 80,000 | 4 |
| | 150E1C5.5 | 150E | 12" | 15.875" | 80,000 | 4 |
| | 175E1C5.5 | 175E | 12" | 15.875" | 80,000 | 4 |
| | 200E1C5.5 | 200E | 12" | 15.875" | 80,000 | 4 |
| | 125E2C5.5 | 125E | 12" | 15.875" | 80,000 | 5 |
| | 150E2C5.5 | 150E | 12" | 15.875" | 80,000 | 5 |
| | 175E2C5.5 | 175E | 12" | 15.875" | 80,000 | 5 |
| | 200E2C5.5 | 200E | 12" | 15.875" | 80,000 | 5 |
| | 250E2C5.5 | 250E | 12" | 15.875" | 80,000 | 5 |
| | 300E2C5.5 | 300E | 12" | 15.875" | 80,000 | 5 |
| | 350E2C5.5 | 350E | 12" | 15.875" | 80,000 | 5 |
| | 400E2C5.5 | 400E | 12" | 15.875" | 80,000 | 5 |
| | 450E2C5.5 | 450E | 12" | 15.875" | 80,000 | 5 |
| | 500E3C5.5 | 500E | 12" | 15.875" | 80,000 | 6 |
| 550E3C5.5 | 550E | 12" | 15.875" | 80,000 | 6 | |
| 600E3C5.5 | 600E | 12" | 15.875" | 80,000 | 6 | |

| E-RATED | ORDERING/CATALOG NUMBER | SIZE | DIM. A (INCHES) | DIM. B (INCHES) | MAX INTERRUPTING RATING RMS (ASYM)* | FIGURE NUMBER |
|-------------|-------------------------|------|-----------------|--------------------|-------------------------------------|---------------|
| 5.5 MAX. KV | 5NLE10E | 10E | 14" | 17 $\frac{7}{8}$ " | 80,000 | 4 |
| | 5NLE15E | 15E | 14" | 17 $\frac{7}{8}$ " | 80,000 | 4 |
| | 5NLE20E | 20E | 14" | 17 $\frac{7}{8}$ " | 80,000 | 4 |
| | 5NLE25E | 25E | 14" | 17 $\frac{7}{8}$ " | 80,000 | 4 |
| | 5NLE30E | 30E | 14" | 17 $\frac{7}{8}$ " | 80,000 | 4 |
| | 5NLE40E | 40E | 14" | 17 $\frac{7}{8}$ " | 80,000 | 4 |
| | 5NLE50E | 50E | 14" | 17 $\frac{7}{8}$ " | 80,000 | 4 |
| | 5NLE65E | 65E | 14" | 17 $\frac{7}{8}$ " | 80,000 | 4 |
| | 5NLE80E | 80E | 14" | 17 $\frac{7}{8}$ " | 80,000 | 4 |
| | 5NLE100E | 100E | 14" | 17 $\frac{7}{8}$ " | 80,000 | 4 |
| | 5NLE125E | 125E | 14" | 17 $\frac{7}{8}$ " | 80,000 | 4 |
| | 5NLE150E | 150E | 14" | 17 $\frac{7}{8}$ " | 80,000 | 4 |
| | 5NLE175E | 175E | 14" | 17 $\frac{7}{8}$ " | 80,000 | 4 |
| | 5NLE200E | 200E | 14" | 17 $\frac{7}{8}$ " | 80,000 | 4 |
| | 5NLE2225E | 225E | 14" | 17 $\frac{7}{8}$ " | 80,000 | 5 |
| | 5NLE2250E | 250E | 14" | 17 $\frac{7}{8}$ " | 80,000 | 5 |
| | 5NLE2300E | 300E | 14" | 17 $\frac{7}{8}$ " | 80,000 | 5 |
| | 5NLE2350E | 350E | 14" | 17 $\frac{7}{8}$ " | 80,000 | 5 |
| | 5NLE2400E | 400E | 14" | 17 $\frac{7}{8}$ " | 80,000 | 5 |
| | 5NLE2450E | 450E | 14" | 17 $\frac{7}{8}$ " | 80,000 | 5 |

* RMS Asymmetrical amperes = RMS Symmetrical amperes x 1.6

E-RATED MEDIUM VOLTAGE FUSES

Current-Limiting

| E-RATED | ORDERING/CATALOG NUMBER | SIZE | DIM. A (INCHES) | DIM. B (INCHES) | MAX INTERRUPTING RATING RMS (ASYM)* | FIGURE NUMBER |
|--------------|-------------------------|------|-----------------|----------------------------------|-------------------------------------|---------------|
| 8.25 MAX. KV | 10E1C8.25 | 10E | 12" | 15 ⁷ / ₈ " | 80,000 | 4 |
| | 15E1C8.25 | 15E | 12" | 15 ⁷ / ₈ " | 80,000 | 4 |
| | 20E1C8.25 | 20E | 12" | 15 ⁷ / ₈ " | 80,000 | 4 |
| | 25E1C8.25 | 25E | 12" | 15 ⁷ / ₈ " | 80,000 | 4 |
| | 30E1C8.25 | 30E | 12" | 15 ⁷ / ₈ " | 80,000 | 4 |
| | 40E1C8.25 | 40E | 12" | 15 ⁷ / ₈ " | 80,000 | 4 |
| | 50E1C8.25 | 50E | 12" | 15 ⁷ / ₈ " | 80,000 | 4 |
| | 65E1C8.25 | 65E | 12" | 15 ⁷ / ₈ " | 80,000 | 4 |
| | 80E1C8.25 | 80E | 12" | 15 ⁷ / ₈ " | 80,000 | 4 |
| | 100E1C8.25 | 100E | 12" | 15 ⁷ / ₈ " | 80,000 | 4 |
| | 125E1C8.25 | 125E | 12" | 15 ⁷ / ₈ " | 80,000 | 4 |
| | 150E1C8.25 | 150E | 12" | 15 ⁷ / ₈ " | 80,000 | 4 |
| | 125E2C8.25 | 125E | 12" | 15 ⁷ / ₈ " | 80,000 | 5 |
| | 150E2C8.25 | 150E | 12" | 15 ⁷ / ₈ " | 80,000 | 5 |
| | 200E2C8.25 | 200E | 12" | 15 ⁷ / ₈ " | 80,000 | 5 |
| | 250E2C8.25 | 250E | 12" | 15 ⁷ / ₈ " | 80,000 | 5 |
| | 300E2C8.25 | 300E | 12" | 15 ⁷ / ₈ " | 80,000 | 5 |
| | 350E3C8.25 | 350E | 12" | 15 ⁷ / ₈ " | 80,000 | 6 |
| | 400E3C8.25 | 400E | 12" | 15 ⁷ / ₈ " | 80,000 | 6 |

| E-RATED | ORDERING/CATALOG NUMBER | SIZE | DIM. A (INCHES) | DIM. B (INCHES) | MAX INTERRUPTING RATING RMS (ASYM)* | FIGURE NUMBER |
|--------------|-------------------------|------|-----------------|----------------------------------|-------------------------------------|---------------|
| 8.25 MAX. KV | 8NLE10E | 10E | 14" | 17 ⁷ / ₈ " | 80,000 | 4 |
| | 8NLE15E | 15E | 14" | 17 ⁷ / ₈ " | 80,000 | 4 |
| | 8NLE20E | 20E | 14" | 17 ⁷ / ₈ " | 80,000 | 4 |
| | 8NLE25E | 25E | 14" | 17 ⁷ / ₈ " | 80,000 | 4 |
| | 8NLE30E | 30E | 14" | 17 ⁷ / ₈ " | 80,000 | 4 |
| | 8NLE40E | 40E | 14" | 17 ⁷ / ₈ " | 80,000 | 4 |
| | 8NLE50E | 50E | 14" | 17 ⁷ / ₈ " | 80,000 | 4 |
| | 8NLE65E | 65E | 14" | 17 ⁷ / ₈ " | 80,000 | 4 |
| | 8NLE80E | 80E | 14" | 17 ⁷ / ₈ " | 80,000 | 4 |
| | 8NLE100E | 100E | 14" | 17 ⁷ / ₈ " | 80,000 | 4 |
| | 8NLE2100E | 100E | 14" | 17 ⁷ / ₈ " | 80,000 | 5 |
| | 8NLE2125E | 125E | 14" | 17 ⁷ / ₈ " | 80,000 | 5 |
| | 8NLE2150E | 150E | 14" | 17 ⁷ / ₈ " | 80,000 | 5 |
| | 8NLE2200E | 200E | 14" | 17 ⁷ / ₈ " | 80,000 | 5 |
| | 8NLE2250E | 250E | 14" | 17 ⁷ / ₈ " | 80,000 | 5 |

| E-RATED | ORDERING/CATALOG NUMBER | SIZE | DIM. A (INCHES) | DIM. B (INCHES) | MAX INTERRUPTING RATING RMS (ASYM)* | FIGURE NUMBER |
|--------------|-------------------------|------|-----------------|-----------------|-------------------------------------|---------------|
| 15.5 MAX. KV | 10E1C15.5 | 10E | 15" | 18.875" | 80,000 | 4 |
| | 15E1C15.5 | 15E | 15" | 18.875" | 80,000 | 4 |
| | 20E1C15.5 | 20E | 15" | 18.875" | 80,000 | 4 |
| | 25E1C15.5 | 25E | 15" | 18.875" | 80,000 | 4 |
| | 30E1C15.5 | 30E | 15" | 18.875" | 80,000 | 4 |
| | 40E1C15.5 | 40E | 15" | 18.875" | 80,000 | 4 |
| | 50E1C15.5 | 50E | 15" | 18.875" | 80,000 | 4 |
| | 65E1C15.5 | 65E | 15" | 18.875" | 80,000 | 4 |
| | 80E1C15.5 | 80E | 15" | 18.875" | 80,000 | 4 |
| | 100E1C15.5 | 100E | 15" | 18.875" | 80,000 | 4 |
| | 65E2C15.5 | 65E | 15" | 18.875" | 80,000 | 5 |
| | 80E2C15.5 | 80E | 15" | 18.875" | 80,000 | 5 |
| | 100E2C15.5 | 100E | 15" | 18.875" | 80,000 | 5 |
| | 125E2C15.5 | 125E | 15" | 18.875" | 80,000 | 5 |
| | 150E2C15.5 | 150E | 15" | 18.875" | 80,000 | 5 |
| | 175E2C15.5 | 175E | 15" | 18.875" | 80,000 | 5 |
| | 200E2C15.5 | 200E | 15" | 18.875" | 80,000 | 5 |
| | 200E3C15.5 | 200E | 15" | 18.875" | 80,000 | 6 |
| | 250E3C15.5 | 250E | 15" | 18.875" | 80,000 | 6 |
| | 300E3C15.5 | 300E | 15" | 18.875" | 80,000 | 6 |

* RMS Asymmetrical amperes = RMS Symmetrical amperes x 1.6

E-RATED MEDIUM VOLTAGE FUSES

Current-Limiting

| E-RATED | ORDERING/CATALOG NUMBER | SIZE | DIM. A (INCHES) | DIM. B (INCHES) | MAX INTERRUPTING RATING RMS (ASYM)* | FIGURE NUMBER |
|--------------|-------------------------|------|-----------------|-----------------|-------------------------------------|---------------|
| 15.5 MAX. KV | 15GSE65E | 65E | 18" | 21 7/8" | 60,000 | 4 |
| | 15GSE80E | 80E | 18" | 21 7/8" | 60,000 | 4 |
| | 15GSE100E | 100E | 18" | 21 7/8" | 60,000 | 4 |
| | 15GSE2125E | 125E | 18" | 21 7/8" | 60,000 | 5 |
| | 15GSE2150E | 150E | 18" | 21 7/8" | 60,000 | 5 |
| | 15GSE2175E | 175E | 18" | 21 7/8" | 60,000 | 5 |
| | 15GSE2200E | 200E | 18" | 21 7/8" | 60,000 | 5 |

| E-RATED | ORDERING/CATALOG NUMBER | SIZE | DIM. A (INCHES) | DIM. B (INCHES) | MAX INTERRUPTING RATING RMS (ASYM)* | FIGURE NUMBER |
|--------------|-------------------------|------|-----------------|-----------------|-------------------------------------|---------------|
| 15.5 MAX. KV | 15NLE10E | 10E | 20" | 23 7/8" | 60,000 | 4 |
| | 15NLE15E | 15E | 20" | 23 7/8" | 60,000 | 4 |
| | 15NLE20E | 20E | 20" | 23 7/8" | 60,000 | 4 |
| | 15NLE25E | 25E | 20" | 23 7/8" | 60,000 | 4 |
| | 15NLE30E | 30E | 20" | 23 7/8" | 60,000 | 4 |
| | 15NLE40E | 40E | 20" | 23 7/8" | 60,000 | 4 |
| | 15NLE50E | 50E | 20" | 23 7/8" | 60,000 | 4 |
| | 15NLE65E | 65E | 20" | 23 7/8" | 60,000 | 4 |
| | 15NLE80E | 80E | 20" | 23 7/8" | 60,000 | 4 |
| | 15NLE100E | 100E | 20" | 23 7/8" | 60,000 | 4 |
| | 15NLE280E | 80E | 20" | 23 7/8" | 60,000 | 5 |
| | 15NLE2100E | 100E | 20" | 23 7/8" | 60,000 | 5 |
| | 15NLE2125E | 125E | 20" | 23 7/8" | 60,000 | 5 |
| | 15NLE2150E | 150E | 20" | 23 7/8" | 60,000 | 5 |
| | 15NLE2175E | 175E | 20" | 23 7/8" | 60,000 | 5 |
| | 15NLE2200E | 200E | 20" | 23 7/8" | 60,000 | 5 |
| | 15NLE3150E | 150E | 20" | 23 7/8" | 60,000 | 6 |
| | 15NLE3175E | 175E | 20" | 23 7/8" | 60,000 | 6 |
| 15NLE3250E | 250E | 20" | 23 7/8" | 60,000 | 6 | |
| 15NLE3300E | 300E | 20" | 23 7/8" | 60,000 | 6 | |

| E-RATED | ORDERING/CATALOG NUMBER | SIZE | DIM. A (INCHES) | DIM. B (INCHES) | MAX INTERRUPTING RATING RMS (ASYM)* | FIGURE NUMBER |
|--------------|-------------------------|------|-----------------|-----------------|-------------------------------------|---------------|
| 25.8 MAX. KV | 15E1C25.8 | 15E | 21" | 24 5/8" | 40,000 | 4 |
| | 20E1C25.8 | 20E | 21" | 24 5/8" | 40,000 | 4 |
| | 25E1C25.8 | 25E | 21" | 24 5/8" | 40,000 | 4 |
| | 30E1C25.8 | 30E | 21" | 24 5/8" | 40,000 | 4 |
| | 40E1C25.8 | 40E | 21" | 24 5/8" | 40,000 | 4 |
| | 50E1C25.8 | 50E | 21" | 24 5/8" | 40,000 | 4 |
| | 65E2C25.8 | 65E | 21" | 24 5/8" | 40,000 | 5 |
| | 80E2C25.8 | 80E | 21" | 24 5/8" | 40,000 | 5 |
| 100E2C25.8 | 100E | 21" | 24 5/8" | 40,000 | 5 | |

| E-RATED | ORDERING/CATALOG NUMBER | SIZE | DIM. A (INCHES) | DIM. B (INCHES) | MAX INTERRUPTING RATING RMS (ASYM)* | FIGURE NUMBER |
|------------|-------------------------|------|-----------------|-----------------|-------------------------------------|---------------|
| 38 MAX. KV | 3E1C38.0 | 3E | 27" | 30 5/8" | 20,000 | 4 |
| | 7E1C38.0 | 7E | 27" | 30 5/8" | 20,000 | 4 |
| | 10E1C38.0 | 10E | 27" | 30 5/8" | 20,000 | 4 |
| | 15E1C38.0 | 15E | 27" | 30 5/8" | 20,000 | 4 |
| | 20E1C38.0 | 20E | 27" | 30 5/8" | 20,000 | 4 |
| | 25E1C38.0 | 25E | 27" | 30 5/8" | 20,000 | 4 |
| | 30E1C38.0 | 30E | 27" | 30 5/8" | 20,000 | 4 |
| | 40E1C38.0 | 40E | 27" | 30 5/8" | 20,000 | 4 |
| | 50E2C38.0 | 50E | 27" | 30 5/8" | 20,000 | 5 |
| | 65E2C38.0 | 65E | 27" | 30 5/8" | 20,000 | 5 |
| 80E2C38.0 | 80E | 27" | 30 5/8" | 20,000 | 5 | |

* RMS Asymmetrical amperes = RMS Symmetrical amperes x 1.6

E-RATED MEDIUM VOLTAGE FUSES

Current-Limiting

Clip Lock Design

The clip lock type designs ensures a positive contact between the fuse and the connection cam. The fuse's clip lock tab slides in between the clip casting and the cam to prevent the fuse from slipping or blowing out of the holder. This positive contact improves heat dissipation and allows fuses to run cooler.

Dimensions in inches

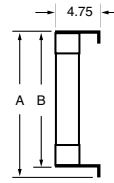

Figure 7

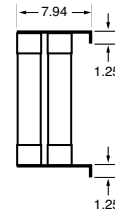

Figure 8

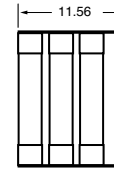
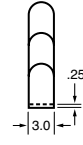

Figure 9



Medium Voltage Fuses 3

| E-RATED | ORDERING/CATALOG NUMBER | SIZE | DIM. A (INCHES) | DIM. B (INCHES) | MAX INTERRUPTING RATING RMS (ASYM)* | FIGURE NUMBER |
|--------------------------|-------------------------|--------|-----------------|-----------------|-------------------------------------|---------------|
| 5.5 MAX. KV CLIP LOCK | 10E1CL5.5 | 10E | 16.38" | 15.13" | 80,000 | 7 |
| | 15E1CL5.5 | 15E | 16.38" | 15.13" | 80,000 | 7 |
| | 20E1CL5.5 | 20E | 16.38" | 15.13" | 80,000 | 7 |
| | 25E1CL5.5 | 25E | 16.38" | 15.13" | 80,000 | 7 |
| | 30E1CL5.5 | 30E | 16.38" | 15.13" | 80,000 | 7 |
| | 40E1CL5.5 | 40E | 16.38" | 15.13" | 80,000 | 7 |
| | 50E1CL5.5 | 50E | 16.38" | 15.13" | 80,000 | 7 |
| | 65E1CL5.5 | 65E | 16.38" | 15.13" | 80,000 | 7 |
| | 80E1CL5.5 | 80E | 16.38" | 15.13" | 80,000 | 7 |
| | 100E1CL5.5 | 100E | 16.38" | 15.13" | 80,000 | 7 |
| | 125E1CL5.5 | 125E | 16.38" | 15.13" | 80,000 | 7 |
| | 150E1CL5.5 | 150E | 16.38" | 15.13" | 80,000 | 7 |
| | 225E2CL5.5 | 225E | 17.38" | 16.13" | 80,000 | 8 |
| | 250E2CL5.5 | 250E | 17.38" | 16.13" | 80,000 | 8 |
| | 300E2CL5.5 | 300E | 17.38" | 16.13" | 80,000 | 8 |
| | 350E2CL5.5 | 350E | 17.38" | 16.13" | 80,000 | 8 |
| | 400E2CL5.5 | 400E | 17.38" | 16.13" | 80,000 | 8 |
| | 450E2CL5.5 | 450E | 17.38" | 16.13" | 80,000 | 8 |
| 500E3CL5.5 | 500E | 17.38" | 16.13" | 80,000 | 9 | |
| 550E3CL5.5 | 550E | 17.38" | 16.13" | 80,000 | 9 | |
| 600E3CL5.5 | 600E | 17.38" | 16.13" | 80,000 | 9 | |

| E-RATED | ORDERING/CATALOG NUMBER | SIZE | DIM. A (INCHES) | DIM. B (INCHES) | MAX INTERRUPTING RATING RMS (ASYM)* | FIGURE NUMBER |
|---------------------------|-------------------------|------|-----------------|-----------------|-------------------------------------|---------------|
| 8.25 MAX. KV CLIP LOCK | 10E1CL8.25 | 10E | 17.38" | 16.13" | 80,000 | 7 |
| | 15E1CL8.25 | 15E | 17.38" | 16.13" | 80,000 | 7 |
| | 20E1CL8.25 | 20E | 17.38" | 16.13" | 80,000 | 7 |
| | 25E1CL8.25 | 25E | 17.38" | 16.13" | 80,000 | 7 |
| | 30E1CL8.25 | 30E | 17.38" | 16.13" | 80,000 | 7 |
| | 40E1CL8.25 | 40E | 17.38" | 16.13" | 80,000 | 7 |
| | 50E1CL8.25 | 50E | 17.38" | 16.13" | 80,000 | 7 |
| | 65E1CL8.25 | 65E | 17.38" | 16.13" | 80,000 | 7 |
| | 80E1CL8.25 | 80E | 17.38" | 16.13" | 80,000 | 7 |
| | 100E1CL8.25 | 100E | 17.38" | 16.13" | 80,000 | 7 |
| | 125E2CL8.25 | 125E | 17.38" | 16.13" | 80,000 | 8 |
| | 150E2CL8.25 | 150E | 17.38" | 16.13" | 80,000 | 8 |
| | 175E2CL8.25 | 175E | 17.38" | 16.13" | 80,000 | 8 |
| | 200E2CL8.25 | 200E | 17.38" | 16.13" | 80,000 | 8 |
| | 225E2CL8.25 | 225E | 17.38" | 16.13" | 80,000 | 8 |
| | 250E2CL8.25 | 250E | 17.38" | 16.13" | 80,000 | 8 |
| | 300E2CL8.25 | 300E | 17.38" | 16.13" | 80,000 | 8 |
| | 350E3CL8.25 | 350E | 17.38" | 16.13" | 80,000 | 9 |

| E-RATED | ORDERING/CATALOG NUMBER | SIZE | DIM. A (INCHES) | DIM. B (INCHES) | MAX INTERRUPTING RATING RMS (ASYM)* | FIGURE NUMBER |
|---------------------------|-------------------------|------|-----------------|-----------------|-------------------------------------|---------------|
| 15.5 MAX. KV CLIP LOCK | 10E1CL15.5 | 10E | 19.8" | 18.1" | 60,000 | 7 |
| | 15E1CL15.5 | 15E | 19.8" | 18.1" | 60,000 | 7 |
| | 20E1CL15.5 | 20E | 19.8" | 18.1" | 60,000 | 7 |
| | 25E1CL15.5 | 25E | 19.8" | 18.1" | 60,000 | 7 |
| | 30E1CL15.5 | 30E | 19.8" | 18.1" | 60,000 | 7 |
| | 40E1CL15.5 | 40E | 19.8" | 18.1" | 60,000 | 7 |
| | 50E1CL15.5 | 50E | 19.8" | 18.1" | 60,000 | 7 |
| | 65E1CL15.5 | 65E | 22.81" | 21.13" | 60,000 | 7 |
| | 80E1CL15.5 | 80E | 22.81" | 21.13" | 60,000 | 7 |
| | 100E1CL15.5 | 100E | 22.81" | 21.13" | 60,000 | 7 |
| | 125E2CL15.5 | 125E | 22.81" | 19.1" | 60,000 | 8 |
| | 150E2CL15.5 | 150E | 22.81" | 19.1" | 60,000 | 8 |
| | 175E2CL15.5 | 175E | 22.81" | 19.1" | 60,000 | 8 |
| | 200E2CL15.5 | 200E | 22.81" | 19.1" | 60,000 | 8 |
| | 150E3CL15.5 | 150E | 22.81" | 19.1" | 60,000 | 9 |
| | 200E3CL15.5 | 200E | 22.81" | 19.1" | 60,000 | 9 |
| | 250E3CL15.5 | 250E | 22.81" | 19.1" | 60,000 | 9 |
| | 300E3CL15.5 | 300E | 22.81" | 19.1" | 60,000 | 9 |

* RMS Asymmetrical amperes = RMS Symmetrical amperes x 1.6

E-RATED POTENTIAL TRANSFORMER FUSES

Current-Limiting

Description

Potential Transformer (PT) fuses are current-limiting fuses with high interrupting ratings designed for the protection of potential transformers.

Application Note

When applying fuses for the protection of transformers, the magnetizing current in-rush must be considered. The characteristics of the in-rush, which can be matched with a fuse time-current curve, should be available from the transformer manufacturer.

Characteristics

Voltage Ratings 625 VAC – 25,800 VAC
Current Range 1/2E – 10E

Dimensions

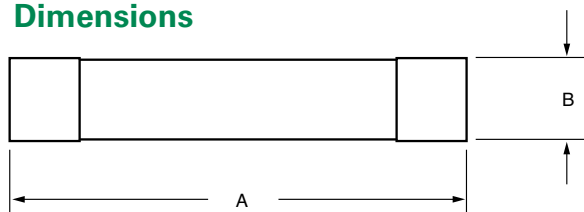

| E-RATED | ORDERING/CATALOG NUMBER | SIZE | LENGTH DIM. A (INCHES) | DIAMETER DIM. B (INCHES) | MAX INTERRUPTING RATING RMS (ASYM)* |
|--------------|-------------------------|------|------------------------|--------------------------|-------------------------------------|
| 625 VOLT | 3E4PT.6 | 3E | 4.6" | 0.8125" | 37,500 |
| | 5E4PT.6 | 5E | 4.6" | 0.8125" | 37,500 |
| | 7E4PT.6 | 7E | 4.6" | 0.8125" | 37,500 |
| | 10E4PT.6 | 10E | 4.6" | 0.8125" | 37,500 |
| 2.75 MAX. KV | 500E4PT2.4 | 1/2E | 4.6" | 0.8125" | 37,500 |
| | 1E4PT2.4 | 1E | 4.6" | 0.8125" | 37,500 |
| | 2E4PT2.4 | 2E | 4.6" | 0.8125" | 37,500 |
| 2.75 MAX. KV | 1E6PT2.75 | 1E | 7.4" | 1.5625" | 37,500 |
| | 2E6PT2.75 | 2E | 7.4" | 1.5625" | 37,500 |
| | 3E6PT2.75 | 3E | 7.4" | 1.5625" | 37,500 |
| | 1E8PT2.75 | 1E | 9.5" | 1.5625" | 37,500 |
| | 2E8PT2.75 | 2E | 9.5" | 1.5625" | 37,500 |
| | 3E8PT2.75 | 3E | 9.5" | 1.5625" | 37,500 |
| 4.8 MAX. KV | 1E5PT4.8 | 1E | 5.6" | 0.8125" | 50,000 |
| | 2E5PT4.8 | 2E | 5.6" | 0.8125" | 50,000 |
| 5.5 MAX. KV | 500E6PT5.5 | 1/2E | 7.4" | 1.5625" | 50,000 |
| | 1E6PT5.5 | 1E | 7.4" | 1.5625" | 50,000 |
| | 2E6PT5.5 | 2E | 7.4" | 1.5625" | 50,000 |
| | 3E6PT5.5 | 3E | 7.4" | 1.5625" | 50,000 |
| | 5E6PT5.5 | 5E | 7.4" | 1.5625" | 50,000 |
| | 500E8PT5.5 | 1/2E | 9.5" | 1.5625" | 50,000 |
| | 1E8PT5.5 | 1E | 9.5" | 1.5625" | 50,000 |
| | 2E8PT5.5 | 2E | 9.5" | 1.5625" | 50,000 |
| | 3E8PT5.5 | 3E | 9.5" | 1.5625" | 50,000 |
| | 5E8PT5.5 | 5E | 9.5" | 1.5625" | 50,000 |
| 8.25 MAX. KV | 10E8PT5.5 | 10E | 9.5" | 1.5625" | 50,000 |
| | 500E8PT8.25 | 1/2E | 9.5" | 1.5625" | 50,000 |
| | 1E8PT8.25 | 1E | 9.5" | 1.5625" | 50,000 |
| 15.5 MAX. KV | 2E8PT8.25 | 2E | 9.5" | 1.5625" | 50,000 |
| | 3E8PT8.25 | 3 | 9.5" | 1.5625" | 50,000 |
| | 500E11PT15.5 | 1/2E | 12.8" | 1.5625" | 35,000 |
| | 1E11PT15.5 | 1E | 12.8" | 1.5625" | 35,000 |
| | 2E11PT15.5 | 2E | 12.8" | 1.5625" | 35,000 |
| | 3E11PT15.5 | 3E | 12.8" | 1.5625" | 35,000 |
| 25.8 MAX. KV | 3E16PT15.5 | 3E | 17.5" | 1.5625" | 35,000 |
| | 5E16PT15.5 | 5E | 17.5" | 1.5625" | 35,000 |
| | 500E16PT25.5 | 1/2E | 17.5" | 1.5625" | 32,000 |
| | 1E16PT25.5 | 1E | 17.5" | 1.5625" | 32,000 |

* RMS Asymmetrical amperes = RMS Symmetrical amperes x 1.6

LIVE PARTS



Description

Live parts are available for mounting E, R, and PT single, double, and triple barrel fuses. Mounting clips are available for ferrule type and clip lock style fuses. All clips are sold in pairs.

Medium Voltage Fuses 3

Part Number 700-156

Ordering Number 0700156.Z

For use with 1⁹/₁₆" to 1⁵/₈" (1.625") diameter PT fuses.

Dimensions in inches

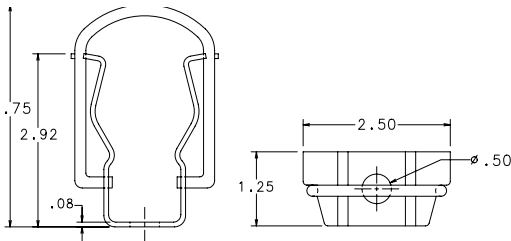

Part Number 700-300

Ordering Number 0700300.Z

For use with 3" diameter fuses.

Dimensions in inches

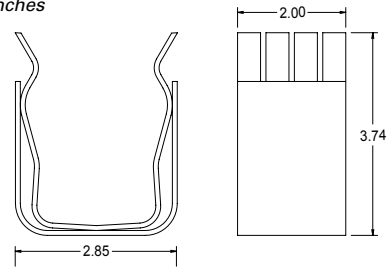

Part Number 700-500

Ordering Number 0700500.Z

For use with all 1³/₁₆" (.8125") diameter PT fuses

Dimensions in inches

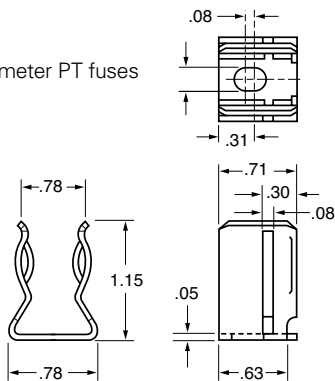

Part Number 700-530

Ordering Number 0700530.Z

For use with all 3" diameter fuses.

Dimensions in inches

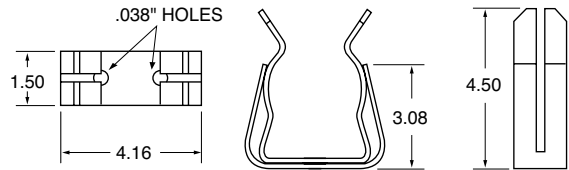

Part Number 700-520-CL

Ordering Number 0700520.ZXCL

Clip Lock Design

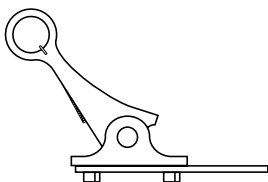

Dimensions for reference only.

Mounting Details for Clip Lock Dimensions in inches

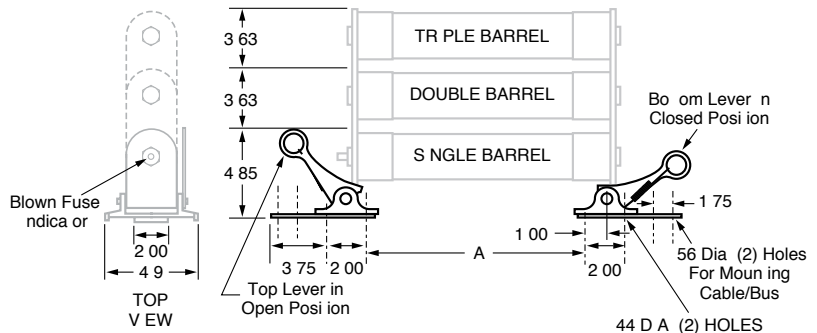

Section Overview

Rely on Littelfuse for short circuit protection of telecommunications circuits and sensitive DC power distribution circuits.



TELECOM PRODUCTS

Table of Contents

| | |
|--|----|
| L17T Series Telecommunications Power Fuse..... | 52 |
| TLN Series Telecommunications Power Fuse..... | 53 |
| TLS Series Telecommunications Power Fuse | 54 |
| Alarm Indicating Fuses..... | 55 |
| LTFD 101 Series Telecommunications Disconnect Switch | 56 |

L17T SERIES TELCOM POWER FUSE

170 VDC • Current-Limiting • 70-1200 A



Ordering Information

| AMPERE RATINGS | | | | | | |
|----------------|-----|-----|-----|-----|------|------|
| 70 | 125 | 200 | 300 | 450 | 800 | 1100 |
| 90 | 150 | 225 | 350 | 500 | 900 | 1200 |
| 100 | 175 | 250 | 400 | 600 | 1000 | — |

| SERIES | VOLTAGE | AMPERAGE | CATALOG NUMBER | ORDERING NUMBER |
|--------|---------|----------|----------------|-----------------|
| L17T | 170 | 1200 | L17T 1200 | L17T1200V |

Dimensions in inches (mm)

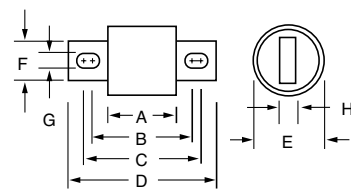

| AMPERE RATING | DIMENSIONS INCHES (mm) | | | | | | | |
|---------------|---|---|--|---|---|---|--|---|
| | A | B | C | D | E | F | G | H |
| 70 – 250 | 1 ⁵ / ₃₂ (29.4) | 1 ⁷ / ₈ (47.6) | 2 ³ / ₁₆ (55.6) | 2 ²¹ / ₃₂ (67.5) | 1 (25.4) | 7 ⁷ / ₈ (22.2) | 5 ⁵ / ₁₆ (7.9) | 3 ³ / ₁₆ (4.8) |
| 300 – 800 | 1 ¹ / ₄ (31.8) | 1 ¹⁵ / ₁₆ (49.2) | 2 ⁹ / ₁₆ (65.1) | 3 ¹ / ₂ (88.9) | 1 ¹ / ₂ (38.1) | 1 (25.4) | 1 ³ / ₃₂ (10.3) | 1 ¹ / ₄ (6.35) |
| 900–1200 | 1 ¹¹ / ₃₂ (34.0) | — | — | 4 ¹ / ₁₆ (103.1) | — | 1 ¹ / ₂ (38.1) | — | 1 ¹ / ₄ (6.35) |

Description

Specifically designed for short-circuit protection of telecommunications circuits, the Littelfuse L17T series fuses provide reliable protection of sensitive DC power distribution systems. Constructed with silver plated elements for low I²t and peak let-through, these advanced fuses virtually eliminate equipment damage due to surges and spikes. The L17T series fuse unique element geometry also provides cooler running temperatures, helping to minimize heat within enclosures.

Features

- Low I²t
- Extremely current-limiting
- Low operating temperature
- 170 VDC rating

Specifications

| | |
|----------------------------|--|
| Voltage Rating | 170 VDC |
| Interrupting Rating | 100 kA |
| Ampere Range | 70 – 1200 A |
| Approvals | UL Recognized (File No. E71611) CSA Recognized (File No. LR29862) |

Web Resources

For additional information, visit:
www.littelfuse.com/l17t

Recommended Fuse Holders

LTFD 6001 and LTFD 1200 series, visit:
www.littelfuse.com/ltfd

TLN SERIES TELCOM POWER FUSE

170 VDC • Current-Limiting • 1-600 A



Description

The TLN Series fuses are specifically designed for the protection of telecommunications DC power distribution circuits.

Features

- 170 VDC rating
- Fast-acting and current-limiting
- 1 to 600 amperes rating
- Dimensionally similar to 250 V Class R fuses

Dimensions Inches (mm)

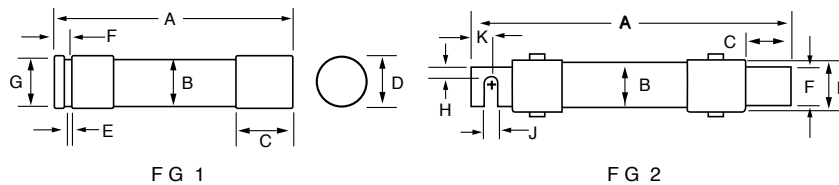

Figure 1

| AMPERE RATING | DIMENSIONS INCHES (mm) | | | | | | | | | |
|---------------|------------------------|----------|------------|--------------|------------|------------|------------|---|---|---|
| | A | B | C | D | E | F | G | H | J | K |
| 1 – 30 | 2 (50.8) | ½ (12.7) | ½ (12.7) | 9/16 (14.3) | 5/64 (2.0) | 5/32 (4.0) | 3/8 (9.5) | — | — | — |
| 35 – 60 | 3 (76.2) | ¾ (19.1) | 5/8 (15.9) | 13/16 (20.6) | 3/32 (2.4) | 3/16 (4.8) | 5/8 (15.9) | — | — | — |

Figure 2

| AMPERE RATING | DIMENSIONS INCHES (mm) | | | | | | | | | |
|---------------|------------------------|--------------|----------------|----------------|------------|--------------|----------------|-------------|---------------|---------------|
| | A | B | C | D | E | F | G | H | J | K |
| 70 – 100 | 5 7/8 (149.2) | 1 (25.4) | 1 1/16 (27.0) | 1 1/16 (27.0) | 1/8 (3.2) | 3/4 (19.1) | 1 1/4 (31.6) | 1/4 (6.4) | 9/32 (7.1) | 1/2 (12.7) |
| 110 – 200 | 7 1/8 (181.0) | 1 1/2 (38.1) | 1 15/32 (37.3) | 1 19/32 (40.5) | 3/16 (4.8) | 1 1/8 (28.6) | 2 27/32 (46.8) | 7/16 (11.1) | 9/32 (7.1) | 1 1/16 (17.5) |
| 225 – 400 | 8 5/8 (219.1) | 2 (50.8) | 1 15/16 (49.2) | 2 3/32 (53.2) | 1/4 (6.4) | 1 5/8 (41.3) | 2 11/32 (59.5) | 5/8 (15.9) | 13/32 (10.3) | 1 5/16 (23.8) |
| 450 – 600 | 10 3/8 (263.5) | 2 1/2 (63.5) | 2 3/8 (60.3) | 2 19/32 (65.9) | 1/4 (6.4) | 2 (50.8) | 2 27/32 (72.2) | 3/4 (19.1) | 1 7/32 (13.5) | 1 1/8 (28.6) |

Specifications

| | |
|----------------------------|---------------------------------|
| Voltage Rating | 170 VDC |
| Interrupting Rating | 100 kA |
| Ampere Range | 1 – 600 A |
| Approvals | UL Recognized (File No. E71611) |

Ordering Information

| AMPERE RATINGS | | | | | | |
|----------------|----|----|-----|-----|-----|-----|
| 1 | 15 | 40 | 80 | 150 | 300 | 600 |
| 3 | 20 | 45 | 90 | 175 | 350 | — |
| 5 | 25 | 50 | 100 | 200 | 400 | — |
| 6 | 30 | 60 | 110 | 225 | 450 | — |
| 10 | 35 | 70 | 125 | 250 | 500 | — |

| SERIES | VOLTAGE | AMPERAGE | CATALOG NUMBER | ORDERING NUMBER |
|--------|---------|----------|----------------|-----------------|
| TLN | 170VDC | 6 | TLN006 | OTLN006.T |

Replaces competitors' TPN and TGN Series.

Web Resources

For additional information, visit:
www.littelfuse.com/tln

Recommended Fuse Holders

LFR25 Series 86

TLS SERIES TELCOM POWER FUSE

170 VDC • Current-Limiting • 1-125 A



Specifications

| | |
|----------------------------|---|
| Voltage Rating | 170 VDC |
| Interrupting Rating | 100 kA |
| Ampere Range | 1 – 125 A |
| Approvals | UL Recognized (File No. E71611) |
| Construction | Body: Glass melamine Caps: Silver-plated brass |
| Environmental | RoHS Compliant, Lead (Pb) Free |

Ordering Information

| AMPERE RATINGS | | | | |
|----------------|----|----|----|------|
| 1 | 6 | 25 | 50 | 90 |
| 2 | 10 | 30 | 60 | 100 |
| 3 | 15 | 35 | 70 | 110* |
| 5 | 20 | 40 | 80 | 125* |

*Available in cartridge only.

Note: To order leaded versions of TLS fuses, add suffix V, L, LB, or LS to part number.

| SERIES | VOLTAGE | AMPERAGE | CATALOG NUMBER | ORDERING NUMBER |
|--------|---------|----------|----------------|-----------------|
| TLS | 170VDC | 6 | TLS006V | OTLS006.TXV |

Replaces competitors' TPS and TGS Series.

Description

Littelfuse TLS Series fuses are designed specifically for the protection of telecommunications equipment. TLS fuses have been engineered to operate up to 170 VDC to provide current-limiting short-circuit protection for cables and components found in the DC power distribution circuits of telecommunications systems. The compact design and multiple mounting configurations of the TLS series allow it to be used in a variety of applications.

Features

- 170 VDC rating
- Current-limiting
- 1 to 125 amperes rating
- Multiple mounting configurations
- RoHS Compliant

Web Resources

For additional information, visit:

www.littelfuse.com/tls

Recommended Fuse Holders

- LTFD series disconnect switches56
 - LFT30060 for TLS series cartridge style fuse92
- Contact factory for more information.

Contact Littelfuse for characteristic curves.

Dimensions for reference only.

Dimensions Inches (mm)

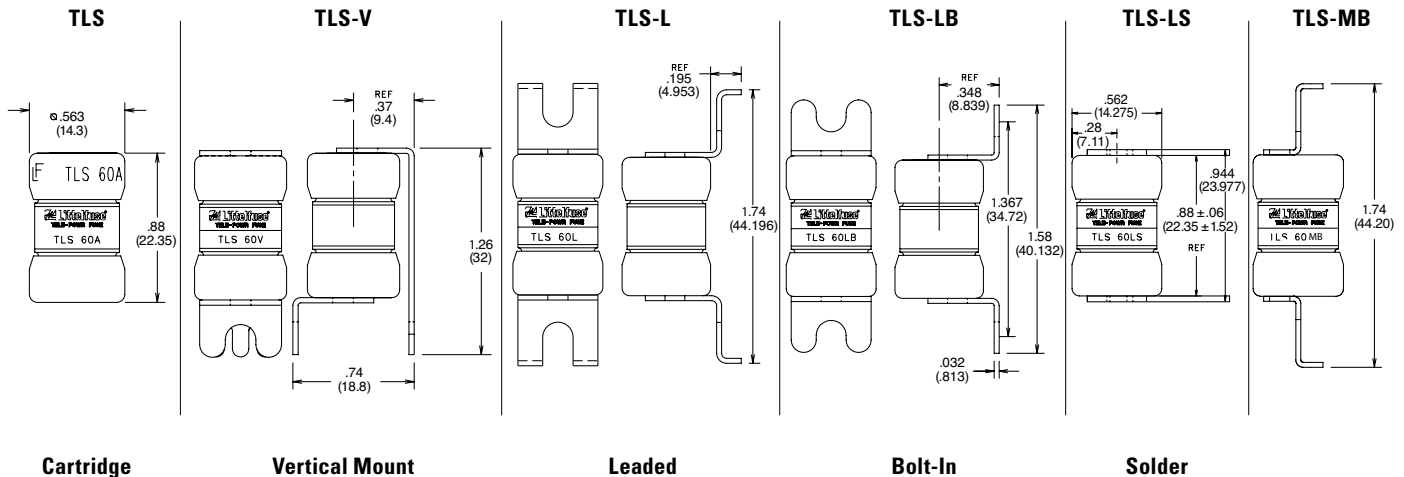

Telecom Products 4

TELCOM POWER FUSES

Alarm Indicating Fuses



70 Series Alarm Indicating Fuses

Description

The 70 Series alarm indicating fuses are designed for use in telecommunications equipment. A color coded tip provides visual identification of the ampere rating and the fuse status.

Features

- Color coded tip
- Rated 125 VAC, 300 VDC

Specifications

| | |
|-----------------------------|--|
| Voltage Ratings | 125 VAC 300 VDC |
| Interrupting Ratings | 1,000 A @ 125 VAC 1,000 A @ 300 VDC |

Ordering Information

| AMPERE RATINGS | | | | |
|----------------|--------|--------|-----|----|
| 100 mA | 200 mA | 500 mA | 2 | 5 |
| 150 mA | 250 mA | 750 mA | 3 | 8 |
| 180 mA | 350 mA | 1.33 | 3.5 | 10 |

| 10 MINUTE RATING | CATALOG NUMBER | ORDERING NUMBER | COLOR CODE |
|------------------|----------------|-----------------|---------------|
| 100 mA | 70P | 70P00000Z | GREY/WHITE |
| 150 mA | 70R | 70R00000Z | RED/WHITE |
| 180 mA | 70E | 70E00000Z | YELLOW |
| 200 mA | 70X | 70X00000Z | BLACK |
| 250 mA | 70F | 70F00000Z | VIOLET |
| 250 mA | 70K | 70K00000Z | VIOLET/WHITE |
| 350 mA | 70S | 70S00000Z | GRAY |
| 500 mA | 70G | 70G00000Z | RED |
| 750 mA | 70H | 70H00000Z | BROWN |
| 1.33 A | 70A | 70A00000Z | WHITE |
| 2 A | 70B | 70B00000Z | ORANGE |
| 3 A | 70C | 70C00000Z | BLUE |
| 3.5 A | 70J | 70J00000Z | BLACK/WHITE |
| 5 A | 70D | 70D00000Z | GREEN/BLACK |
| 8 A | 70M | 70M00000Z | TAN/WHITE |
| 10 A | 70N | 70N00000Z | YELLOW/PURPLE |

Web Resources

For additional information, visit:
www.littelfuse.com/70



481 Series Alarm Indicating Fuses

Description

For telecommunications equipment and similar applications. Color coded indicator flags indicate ampere rating. Body is constructed of black polyphenylene sulfide with UL94-V0 flammability rating, contacts are of bright alloy-plated beryllium copper. Available with or without protective lens.

Specifications

| | |
|-----------------------|---------------------------------|
| Voltage Rating | 125 VAC/DC |
| Approvals | UL Recognized CSA Recognized |

Ordering Information



| AMPERE RATINGS | | | | | | |
|----------------|--------|-----|-------|-------|-------|----|
| 18/100 | 3/8 | 3/4 | 1 1/2 | 3 | 5 | 12 |
| 1/5 | 1/2 | 1 | 2 | 3 1/2 | 7 1/2 | 15 |
| 1/4 | 65/100 | 1/3 | 1/2 | 4 | 10 | 20 |

| SERIES | VOLTAGE | AMPERAGE | CATALOG NUMBER | ORDERING NUMBER |
|--------|-----------|----------|----------------|-----------------|
| 481 | 125 AC/DC | 2 | 481002L | 0481002.VXL |

Note: For 481 Dummy fuse, order 481000.

Recommended Fuse Holders

482 Series, see website: www.littelfuse.com/482
Available 1-20 pole with PCB or panel mounting.
To order with protective lens add suffix XL.

Web Resources

For additional information, visit:
www.littelfuse.com/481

LTFD 101 SERIES TELCOM DISCONNECT SWITCH

80 VDC • 1-125 A



Specifications

| | |
|-----------------------|----------------------------------|
| Voltage Rating | 80 VDC |
| Ampere Range | 1–125 A |
| Approvals | UL Recognized (File No. E122674) |

Recommended Fuses

Littelfuse TLS Series fuses 54

Ordering Information

| SERIES | AMPERAGE | CATALOG NUMBER | ORDERING NUMBER | TERMINAL TYPE |
|--------|-----------|----------------|-----------------|---------------|
| LTFD | 125 A MAX | LTFD101-1 | LTFD0101ZX1 | BULLET |
| LTFD | 125 A MAX | LTFD101-2 | LTFD0101ZX2 | SCREW |
| LTFD | 125 A MAX | LTFD101-3 | LTFD0101ZX3 | STUD |
| LTFD | 70 A MAX | LTFD101-4 | LTFD0101ZX4 | CLIP |

Web Resources

For additional information, visit:
www.littelfuse.com/lbfd101

Description

Littelfuse compact LTFD 101 fuse holders for TLS fuses are designed for quick installation into telecom equipment panels. Their modular design fits into spaces originally designed for circuit breakers and can be front panel mounted or rear mounted using bullet connectors. The innovative new pull-out design eliminates the need for tools to replace fuses and includes an alarm signaling circuit to identify the blown fuse.

Features

- Extremely compact
- Quick mounting
- Replaces circuit breakers
- Includes alarm signaling circuit

Dimensions Inches (mm)

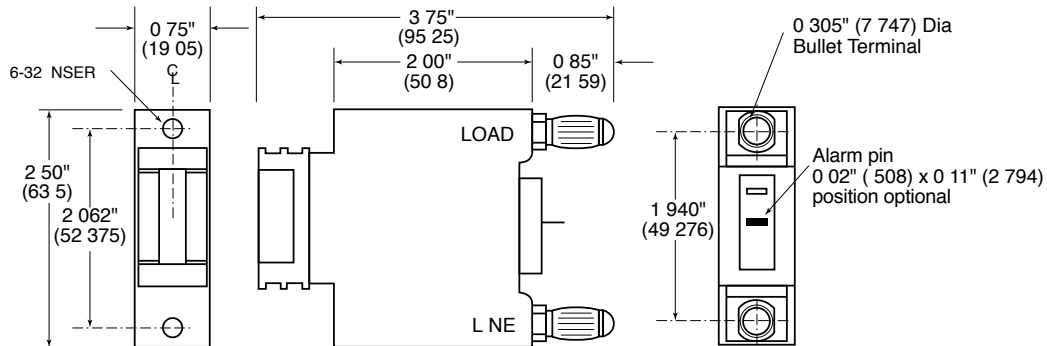

Dimensions for reference only. For additional options and dimensions, contact the factory.

Section Overview

Whether you are protecting solar equipment or finding a replacement fuse for an aging HVAC unit, Littelfuse carries the breadth of fuses to meet your needs. Our “special purpose” fuse section includes application-specific products to meet all of your application needs.



SPECIAL PURPOSE FUSES

Table of Contents

| | |
|---|----|
| Solar Rated Products Overview..... | 58 |
| Solar Rated Fuses | 60 |
| Forklift / Stud Mounted Fuses | 62 |
| Plug Fuses..... | 63 |
| MEGA® Bolt-Down Fuses..... | 63 |
| In-Line Fuses And Holder | 64 |
| Cable Limiters | 65 |
| L Series (Traditional) Semiconductor Fuses | 66 |
| LA Series (Alternate Dimension) Semiconductor Fuses | 68 |
| Square Body Semiconductor Fuses..... | 74 |
| OEM Custom Products..... | 79 |

Circuit-Protection Products for Photovoltaic Applications

With over 14 million devices installed in photovoltaic power systems, Littelfuse understands the technical challenges of the solar market. Littelfuse offers numerous circuit-protection products that are uniquely suited to protect the equipment and systems subject to the harsh environments of photovoltaic installations. Items listed within this catalog, and even newer products and information available online, represent over 80 years of Littelfuse technical expertise and manufacturing excellence.



Download our full-line Solar Products Catalog



For more information on our complete line of Solar-Rated Protection Products or to download our solar catalog, contact us at:

www.littelfuse.com/solar

800-TEC-FUSE

- 1500 VDC HIGH POWER LAB
- COMPREHENSIVE TEST DATA
- GLOBAL MARKET CAPABILITIES
- EXPERIENCED SOLAR ENGINEERING TEAM
- PARTNERED WITH MARKET LEADERS

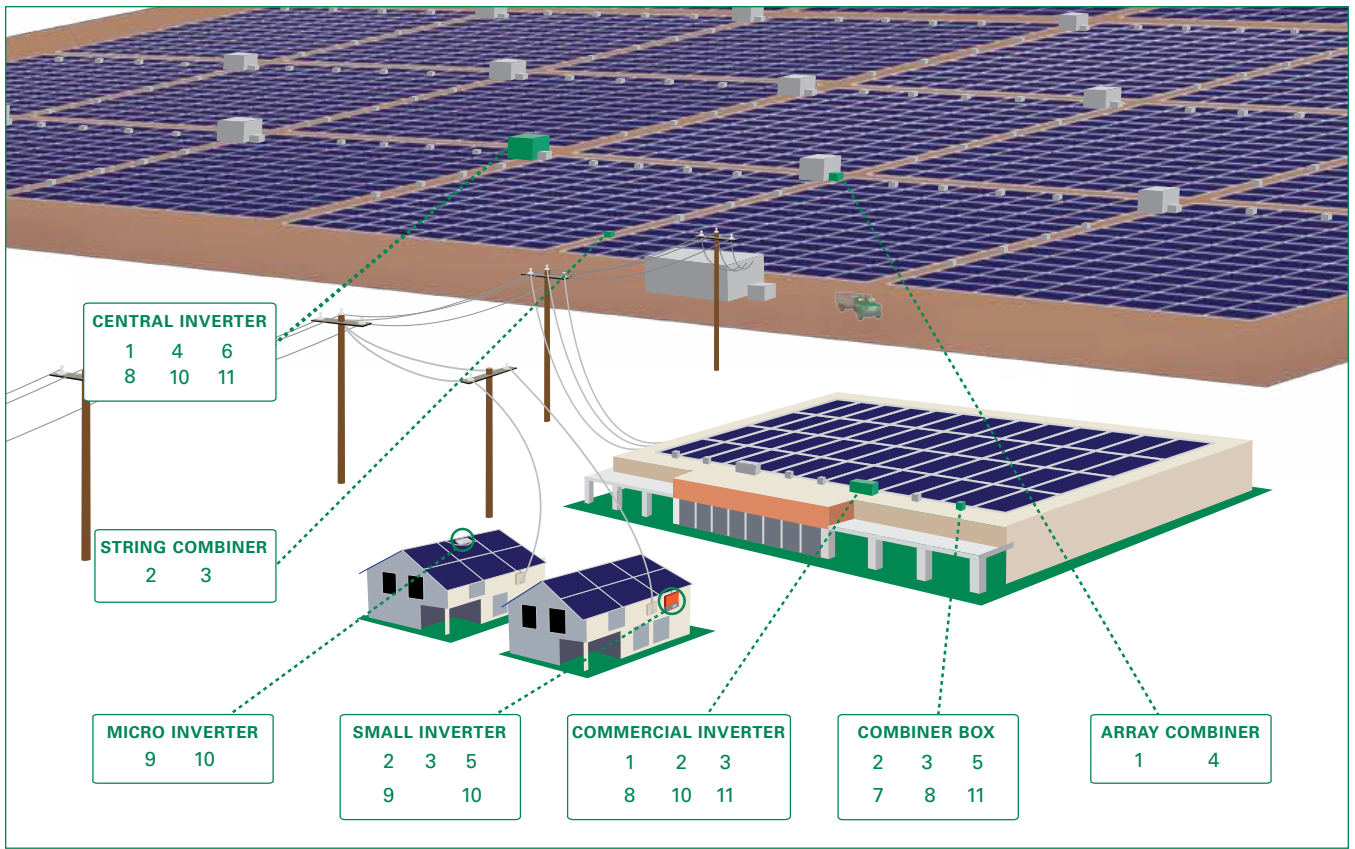

INNOVATIVE SOLAR SOLUTIONS



1. SPJ Solar Fuses..... 61
- 1000 VDC
 - 125-450 A
 - UL Class J Size



2. SPF Solar Fuses 60
- 1000 VDC
 - Up to 30 A
 - 10x38mm



3. LPSM & LPHV Fuse Holders..... 108
- 600 & 1000 VDC
 - Accepts 10x38mm fuses up to 30 A
 - DIN-rail mountable



4. LDC & IDSR Fuses..... 11, 17
- LDC - Up to 2000 A
 - IDSR - Up to 600 A



5. KLKD Solar Fuses 32
- 600 VDC
 - Up to 30 A
 - 10x38mm



6. SE-601 Ground-Fault Relay..... 152
- For ungrounded systems
 - Trip settings from 1-20 mA
 - 5 mS - 2.52 S trip delay

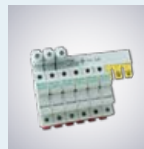

7. LPSM Busbar..... 110
- 600 VDC
 - Accepts 10x38mm fuses up to 30 A
 - 200 A cross section current



8. Up-LINK™ Fuse Holder..... 107
- 600 VDC
 - Accepts 10x38mm fuses up to 30 A
 - DIN-rail mountable

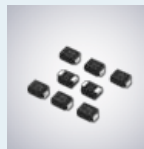

9. TVS Diodes 177
- Up to 3,500 VDC
 - 10,000 A maximum energy



10. Varistor Products 177
- Up to 9,000 A maximum energy
 - -55° C to +85° C



11. Power Distribution Blocks..... 122
- Multiple-wire rated terminals
 - Connectors in copper or aluminum

SPF SERIES SOLAR FUSES

1000 VDC • 1-30 A



Description

The SPF Solar Protection Fuse series has been specifically designed for the protection of photovoltaic (PV) systems. This family of Midget style fuses (10 x 38 mm) can safely protect PV modules and conductors from reverse-overcurrent conditions.

As PV systems have grown in size, so have the corresponding voltage requirements. This increase in system voltage has typically been intended to minimize power loss associated with long conductor runs. Standard circuit protection devices are not designed to completely protect photovoltaic panels. However, the SPF series is UL Listed to safely interrupt faulted circuits up to this demanding voltage level.

Littelfuse offers 13 ampere ratings to match specific requirements in a variety of applications.

Features/Benefits

- Meets UL, IEC and VDE photovoltaic standards
- UL 2579 Listed 1000 VDC maximum
- 1-30 A ratings available
- 20,000 A Interrupting Rating
- Both PCB mount and dead-front holder options available

Applications

- Combiner boxes
- Inverters
- Battery charge controllers

Recommended Fuse Holders

| | |
|-------------------------------|-----|
| LPHV Series..... | 109 |
| LFPHV Indication Series | 112 |

Specifications

| | |
|---------------------------------|---|
| Voltage Rating | 1000 VDC |
| Amperage Rating | 1, 2, 3, 4, 5, 6, 8, 10, 12, 15, 20, 25, 30 |
| Max. Interrupting Rating | 20 kA; Time Constant less than 2ms |
| Min. Interrupting Rating | 1.35x Current Rating |
| Material | Body: Melamine Caps: Copper Alloy |
| Operating Temperature | See Rerating Curve |
| Approvals | UL 2579 Listed (File: E339112) IEC 60269-6 (1-25 A) VDE Approved (No. 40033098) |
| Environmental | RoHS Compliant |
| Country of Origin | Mexico |

Ordering Information

| AMPERAGE | CATALOG NUMBER | ORDERING NUMBER |
|--------------------|----------------|-----------------|
| 2 | SPF002 | SPF002.T |
| 8 | SPF008 | SPF008.T |
| 30 | SPF030 | SPF030.T |
| 30 (WITH PCB TABS) | SPF030R | SPF030.HXR |

Web Resources

Downloadable CAD drawings and other technical information: www.littelfuse.com/spf

Dimensions Inches (mm)

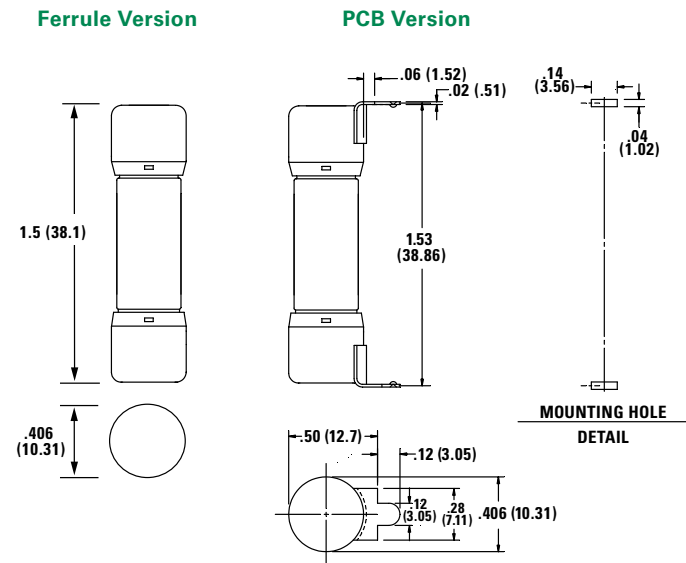

Look for this logo to indicate products that are used in solar applications. Visit our website www.littelfuse.com/solar for the latest updates on approvals, certifications, and new products.

SPFJ SERIES SOLAR FUSES

1000 VDC • 125-450 A



Description

The SPFJ series is the smallest 1000 VDC 125-450 A photovoltaic fuse available in the market. The SPFJ series is manufactured in Class J case sizes that allows for both fuse holder and busbar mounting configuration. The SPFJ meets both UL and IEC requirements.

Features/Benefits

- Meets UL, IEC and VDE photovoltaic standards
- Small footprint reduces panel size
- Full-range PV time-current characteristic
- Flexibility of fuse holder or busbar mounting
- Higher amperage solar fuses in standard sizes
- UL Listed Class J branch and feeder circuit rated

Applications

- Inverters
- Re-combiner boxes

Recommended Fuse Holders

LFJ 1000VDC.....104

Web Resources

Downloadable CAD drawings and other technical information: www.littelfuse.com/spfj

Specifications

| | |
|----------------------------|---|
| Voltage Ratings | 1000 VDC 600 VAC |
| Interrupting Rating | AC: 200 kAIC DC: 125-200 A: 20 kAIC 250-400 A: 10 kAIC 450 A: 20 kAIC |
| Amperage Approvals | 125, 160, 200, 250, 300, 350, 400, 450 UL 2579 Listed (File: E339112) UL 248-8, Class J (except 125, 160, 200 A) C UL (except 125, 160, 200 A) IEC 60269-6 VDE Approved (No. 40033659, 40033630, 40033661) |
| Material | Body: Melamine End Bells: Copper Alloy |
| Environmental | RoHS Compliant |
| Country of Origin | Mexico |

Ordering Information

| CATALOG NUMBER | ORDERING NUMBER | AMPERAGE |
|----------------|-----------------|----------|
| SPFJ 125 | SPFJ125.X | 125 |
| SPFJ 160 | SPFJ160.X | 160 |
| SPFJ 200 | SPFJ200.X | 200 |
| SPFJ 250 | SPFJ250.X | 250 |
| SPFJ 300 | SPFJ300.X | 300 |
| SPFJ 350 | SPFJ350.X | 350 |
| SPFJ 400 | SPFJ400.X | 400 |
| SPFJ 450 | SPFJ450.X | 450 |

* 70-100 Amp models in 200 Amp Case size soon to be released. Visit www.littelfuse.com/spfj for details

Dimensions

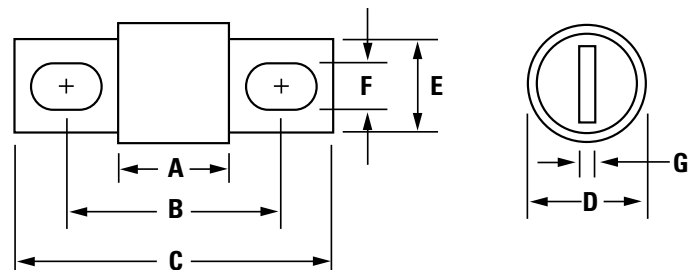

| AMPERAGE | DIMENSIONS INCHES (MM) | | | | | | |
|----------|------------------------|------------------|------------------|--------------|--------------|--------------|------------|
| | A | B | C | D | E | F | G |
| 125-200 | 3 (76.2) | 4 11/32 (110.19) | 5 21/32 (144.02) | 1 1/2 (38.1) | 1 1/8 (28.6) | 9/32 (7.1) | 3/16 (4.8) |
| 250-400 | 3 3/8 (85.7) | 5 1/4 (133.35) | 7 1/8 (181.0) | 2 (50.8) | 1 5/8 (41.3) | 13/32 (10.3) | 1/4 (6.4) |
| 450 | 3 3/4 (95.3) | 5.98 (151.99) | 8 (203.2) | 2 1/2 (63.5) | 2 (50.8) | 17/32 (13.5) | 3/8 (9.5) |



Look for this logo to indicate products that are used in solar applications. Visit our website www.littelfuse.com/solar for the latest updates on approvals, certifications, and new products.

FORK-LIFT STUD-MOUNTED FUSES

48/80 VDC • Fast-Acting and Very Fast-Acting • 35-800 A



CNN, CNN_E & CNL Limiter Fuses



Description

CNN_E fuses are rated for applications up to 80 VDC. As fork lift trucks and electrical vehicle system voltages increase, circuit protection needs to be rated higher than the standard CNN products to handle the increased voltage. The CNN_E is considered very fast-acting for quicker reaction time.

Specifications

| | |
|---------------------------------|---------------------------------|
| Voltage Ratings | 48-80 VDC |
| Max. Interrupting Rating | 2,500 A |
| Ampere Ratings | 35 – 800 A |
| Approval | UL Recognized (File No. E71611) |

Features/Benefits

- 80 VDC Protection
- Window shows fuse status
- 2,500 A interrupting rating
- Compact size saves space
- RoHS compliant and lead free

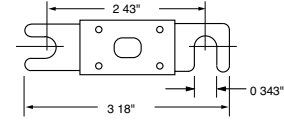

Ordering Information

| AMPERE RATINGS CNN/E | | | | | |
|----------------------|-----|-----|-----|-----|------|
| 35 | 80 | 150 | 250 | 350 | 700* |
| 40 | 90 | 175 | 275 | 400 | 800* |
| 50 | 100 | 200 | 300 | 500 | — |
| 60 | 125 | 225 | 325 | 600 | — |

*Contact factory for availability

| SERIES | AMP | VOLT DC | CATALOG NUMBER | ORDERING NUMBER | TYPE |
|--------|-----|---------|----------------|-----------------|------------------|
| CNN_E | 200 | 80 | CNN200E | 0CNN200E.V | FAST-ACTING |
| CNN | 200 | 48 | CNN200 | 0CNN200.V | VERY FAST-ACTING |
| CNL | 200 | 32 | CNL200 | 0CNL200.V | FAST-ACTING |

48 VDC products are available in fast-acting. See Web for details.

Recommended Fuse Holders

LFFB0003Z 116

Web Resources

80 V: www.littelfuse.com/cnne

48 V: www.littelfuse.com/cnn



HAZGARD™ Forklift Fuses

Description

HAZGARD fuses are designed to provide overcurrent protection for low voltage equipment used in hazardous operations. It is UL 248 recognized and has been evaluated for the use in UL 583 type EE and ES applications. Unique design does not require an additional enclosure as is needed with a standard forklift fuse, saving assembly time and costs.

Ordering Information

| SERIES | AMPERAGE | CATALOG NUMBER | ORDERING NUMBER |
|--------|----------|----------------|-----------------|
| 581 | 200 | 581200 | 0581200.X |

Applications

Lift trucks, scissor lifts, pallet movers, and other low voltage battery operated equipment used to move hazardous materials.

Features/Benefits

- Evaluated for use in UL 583 hazardous applications
- Easily upgrade Type E and ES equipment to Type EE
- Does not require an external enclosure

Specifications

| | |
|----------------------------|---------------------------------|
| Voltage Ratings | 48 VAC/DC |
| Interrupting Rating | 2,500 A |
| Ampere Rating | 10 – 800 A |
| Approval | UL Recognized (File No. E71611) |
| Fuse Holder | LFFB003 |

| AMPERE RATINGS | | |
|----------------|-----|------|
| 10 | 135 | 400 |
| 35 | 150 | 425 |
| 50 | 160 | 500 |
| 90 | 200 | 675 |
| 100 | 225 | 750* |
| 125 | 250 | 800* |
| 130 | 300 | — |

*Contact factory for availability

PLUG FUSES AND BOLT-DOWN FUSES

125 VAC • 2-30 A



Edison-base plug fuses

Description

Littelfuse Plug Fuses provide overcurrent protection to general purpose circuits and small motor loads. Edison-base Plug fuses (TOO and TLO series) feature metal threads similar to incandescent lamp bases.

Specifications

| | |
|----------------------------|--|
| Voltage Rating | 125 VAC |
| Interrupting Rating | 10 kA rms symmetrical |
| Approvals | UL Listed Plug Fuses, Standard UL 248-11 |

TOO Fuses are dual-element time-delay Edison-base fuses designed for motor and motor branch circuit protection; also suitable for all general purpose circuits. Use for replacement purposes only.

| TOO Fuses | | Sample Part # OT00020.Z | |
|----------------|-------|-------------------------|----|
| AMPERE RATINGS | | | |
| 2 | 6 1/4 | 12 | 25 |
| 4 | 8 | 15 | 30 |
| 5 | 10 | 20 | — |

TLO Fuses are medium time-delay Edison-base fuses designed for general purpose branch circuit protection.

| TLO Fuses | | Sample Part # OTL0020.Z | |
|----------------|----|-------------------------|----|
| AMPERE RATINGS | | | |
| 15 | 20 | 25 | 30 |

32 VAC/DC • 100-300 A

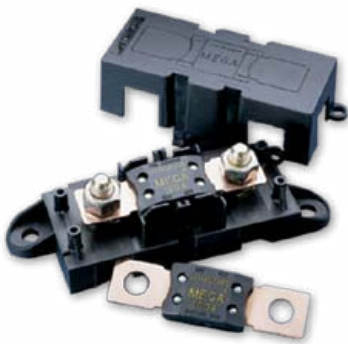

MEGA® SLO-BLO® bolt-on fuse

Description

The MEGA Fuse is designed for the protection of high current applications. Designed and patented by Littelfuse, it is ideal for battery and alternator protection and other heavy gauge cable applications.

Specifications

| | |
|----------------------------|-----------------|
| Voltage Rating | 32 VAC/DC |
| Interrupting Rating | 2000 A @ 32 VDC |

Ordering Information

| CATALOG NUMBER | ORDERING NUMBER | AMPERAGE RATING | VOLTAGE RATING | COLOR CODE |
|----------------|-----------------|-----------------|----------------|------------|
| MEG100 | 0MEG100.X | 100 | 32 | Yellow |
| MEG125 | 0MEG125.X | 125 | 32 | Green |
| MEG150 | 0MEG150.X | 150 | 32 | Orange |
| MEG175 | 0MEG175.X | 175 | 32 | White |
| MEG200 | 0MEG200.X | 200 | 32 | Blue |
| MEG225 | 0MEG225.X | 225 | 32 | Brown |
| MEG250 | 0MEG250.X | 250 | 32 | Pink |
| MEG300 | 0MEG300.X | 300 | 32 | Grey |

Recommended Fuse Holders

298900, see website: www.littelfuse.com/mega

Web Resources

TC Curves, downloadable CAD drawings and other technical information: www.littelfuse.com/mega

LGR/LMF IN-LINE FUSES AND LHR HOLDER

LGR Fuses

Fast-Acting • 300 VAC

Used as in-line protection for fluorescent fixtures, this fast-acting fuse is ideal for increasing the safety and reliability of lighting fixtures.

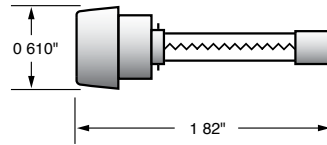

Specifications

Voltage Rating 300 VAC
Maximum Interrupting Rating 10 kA
Approvals Standard 248-14
 UL Listed (File No. E10480)
 CSA Certified (File No. LR29862)



Ordering Information

| AMPERE RATINGS | | | | | |
|----------------|--------|---|---|----|----|
| 1/2 | 1 6/10 | 3 | 6 | 9 | 15 |
| 1 | 2 | 4 | 7 | 10 | — |
| 1 1/2 | 2 1/2 | 5 | 8 | 12 | — |

| SERIES | AMPERAGE | CATALOG NUMBER | ORDERING NUMBER |
|--------|----------|----------------|-----------------|
| LGR | 5 | LGR005 | OLGR005V |

LMF Fuses

Time-Delay • 300 VAC

Perfect for use in lighting systems, this 300 VAC time-delay fuse is designed to handle ballast transformer in-rush currents.

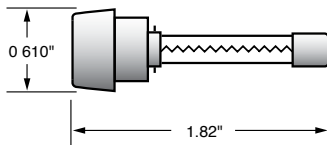

Specifications

Voltage Rating 300 VAC
Maximum Interrupting Rating 10 kA
Approvals Standard 248-14
 UL Listed (File No. E10480)
 CSA Certified (File No. LR29862)



Ordering Information

| AMPERE RATINGS | | | | | |
|----------------|-------|--------|--------|-------|----|
| 3/10 | 8/10 | 1 6/10 | 2 8/10 | 4 | 7 |
| 1/2 | 1 | 2 | 3 | 5 | 8 |
| 6/10 | 1 1/4 | 2 1/2 | 3 2/10 | 6 1/4 | 10 |

| SERIES | AMPERAGE | CATALOG NUMBER | ORDERING NUMBER |
|--------|----------|----------------|-----------------|
| LMF | 5 | LMF005 | OLMF005V |

LHR Fuse Holder

Used as in-line protection for fluorescent fixtures, the Littelfuse LGR and LMF series fuses and LHR holder offer increased safety and reliability to lighting systems.

By individually fusing fixtures, electrical problems are isolated from the rest of the circuit. The added benefits of this is the ability to quickly identify the problem fixture and reduce the repair time.

Fuse holders are rated up to 10 amperes at 300 volts and are equipped with 7" 18 AWG leads. Order part number LHR000 for two leads, and part number LHR001 for one lead; with the other terminal used for insertion of 18 AWG ballast lead.



Specifications

Voltage Rating 300 VAC
Ampere Rating LHR000 10 A
 LHR001 10 A
Approvals UL Recognized
 CSA Certified (File No. 73160)
Flammability Rating UL94 V-0
Example part number LHR001
Ordering number OLHR001T

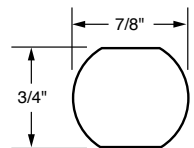

Knock-out Hole

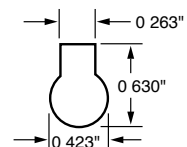

Keyhole Punch

Mounting Information

LHR001/LHR000 will fit keyhole punch or 0.875" knock-out hole. Anti-rotation feature is provided when used with keyhole punch.

A "U-shaped" clip is available for panel mounting (packaged 10 clips per bag): Order part number LHROCA.

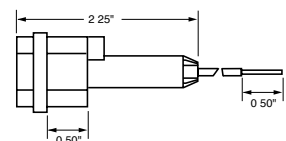

CABLE LIMITERS

600 VAC



Description

Cable limiters are fusible devices that provide very fast short-circuit protection, primarily to faulted cables, but also to other conductors such as busway. Cable limiters do not have an ampere rating, and cannot be used to provide overload protection. They are instead selected by cable size; for example, a 500 kcmil cable requires a 500 kcmil cable limiter. Their main use is to isolate faulted cables in circuits containing three or more parallel conductors per phase. They may be installed on the line side of the main service to provide short-circuit protection to the service conductors. This is especially important when service conductors are tapped from large low voltage networks or from large low impedance transformers.

Cable limiters have terminals which permit them to be installed in a variety of equipment. The most common configuration is the offset blade on one end and the crimp terminal on the other end. This permits the limiter to replace a cable terminal (lug).

Applications

- Service entrance conductors
- Between transformer or network bus and busway terminal boxes
- Large feeders with three or more conductors per phase

Features





- Current-limiting characteristics provide protection to conductor insulation and reduce damage when faults occur.
- Properly applied cable limiters may permit the use of equipment with reduced withstand ratings
- Wide variety of terminations and cable ratings permit use in almost every situation.

Specifications

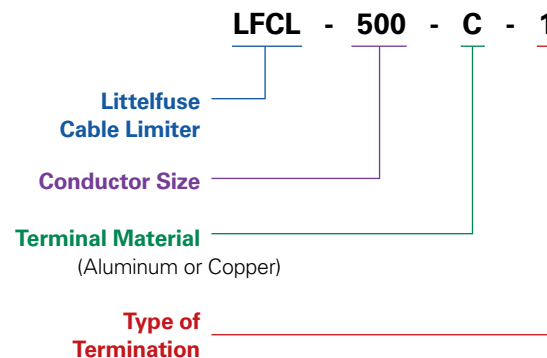
Voltage Ratings 600 VAC
Interrupting Rating 200 kA
Cable Size Range 4/0 – 75MCM Copper or Aluminum
Note: For Type 5 and Type 8 Aluminum cable limiters, use the Copper Type C5 and C8.

Ordering Information



| DESCRIPTION | | | CATALOG NUMBER | |
|-------------|---|------------|----------------|-----------|
| TYPE | TERMINATION | CABLE SIZE | CABLE TYPE | |
| | | | COPPER | ALUMINUM |
| 1 |  | 4/0 | LFCL4/0C1 | LFCL4/0A1 |
| | | 250MCM | LFCL250C1 | LFCL250A1 |
| | | 350MCM | LFCL350C1 | LFCL350A1 |
| | | 500MCM | LFCL500C1 | LFCL500A1 |
| | CABLE TO CABLE | 750MCM | LFCL750C1 | LFCL750A1 |
| 3 |  | 4/0 | LFCL4/0C3 | LFCL4/0A3 |
| | | 250MCM | LFCL250C3 | LFCL250A3 |
| | | 350MCM | LFCL350C3 | LFCL350A3 |
| | | 500MCM | LFCL500C3 | LFCL500A3 |
| | CABLE TO OFFSET BUS | 750MCM | LFCL750C3 | LFCL750A3 |
| 5 |  | 4/0 | LFCL4/0C5 | — |
| | | 250MCM | LFCL250C5 | — |
| | | 350MCM | LFCL350C5 | — |
| | | 500MCM | LFCL500C5 | — |
| | STRAIGHT BUS TO OFFSET BUS | 750MCM | LFCL750C5 | — |
| 6 |  | 4/0 | LFCL4/0C6 | LFCL4/0A6 |
| | | 250MCM | LFCL250C6 | LFCL250A6 |
| | | 350MCM | LFCL350C6 | LFCL350A6 |
| | | 500MCM | LFCL500C6 | LFCL500A6 |
| | MOLE TO CABLE | 750MCM | LFCL750C6 | LFCL750A6 |
| 8 |  | 4/0 | LFCL4/0C8 | — |
| | | 250MCM | LFCL250C8 | — |
| | | 350MCM | LFCL350C8 | — |
| | | 500MCM | LFCL500C8 | — |
| | MOLE TO OFFSET BUS | 750MCM | LFCL750C8 | — |

Note: For Type 5 and Type 8 Aluminum cable limiters, use the Copper Type C5 and C8.

Web Resources

For additional information, see website:
www.littelfuse.com/lfcl

TRADITIONAL SEMICONDUCTOR FUSES

150/250/500/600/700 VAC • Very Fast-Acting • 1-1200 A



| AMPERE RATINGS | SERIES & VOLTAGE RATINGS | | | | | |
|----------------|--|---|----------------------------|-----------------|-----------------|----------------------------|
| | L15S 150 VAC 150 VDC (1 – 60 A) 100 VDC (70 – 1000 A) | L25S 250 VAC 250 VDC (1 – 200 A) 200 VDC (225 – 800 A) | L50S 500 VAC 450 VDC | L60S 600 VAC | KLC‡ 600 VAC | L70S 700 VAC 650 VDC |
| 1 | L15S 1 | L25S 1 | – | L60S 1 | KLC 1 | – |
| 2 | L15S 2 | L25S 2 | – | L60S 2 | KLC 2 | – |
| 3 | L15S 3 | L25S 3 | – | L60S 3 | KLC 3 | – |
| 4 | L15S 4 | L25S 4 | – | L60S 4 | KLC 4 | – |
| 5 | L15S 5 | L25S 5 | – | L60S 5 | KLC 5 | – |
| 6 | L15S 6 | L25S 6 | – | L60S 6 | KLC 6 | – |
| 7 | L15S 7 | – | – | – | KLC 7 | – |
| 8 | L15S 8 | L25S 8 | – | L60S 8 | KLC 8 | – |
| 9 | L15S 9 | – | – | – | – | – |
| 10 | L15S 10 | L25S 10 | L50S 10 | L60S 10 | KLC 10 | L70S 10 |
| 12 | L15S 12 | L25S 12 | L50S 12 | L60S 12 | KLC 12 | – |
| 15 | L15S 15 | L25S 15 | L50S 15 | L60S 15 | KLC 15 | L70S 15 |
| 17½ | – | – | – | L60S 17½ | KLC 17½ | – |
| 20 | L15S 20 | L25S 20 | L50S 20 | L60S 20 | KLC 20 | L70S 20 |
| 25 | L15S 25 | L25S 25 | L50S 25 | L60S 25 | KLC 25 | L70S 25 |
| 30 | L15S 30 | L25S 30 | L50S 30 | L60S 30 | KLC 30 | L70S 30 |
| 35 | L15S 35 | L25S 35 | L50S 35 | L60S 35 | KLC 35 | L70S 35 |
| 40 | L15S 40 | L25S 40 | L50S 40 | L60S 40 | KLC 40 | L70S 40 |
| 45 | L15S 45 | L25S 45 | – | L60S 45 | KLC 45 | – |
| 50 | L15S 50 | L25S 50 | L50S 50 | L60S 50 | KLC 50 | L70S 50 |
| 60 | L15S 60 | L25S 60 | L50S 60 | L60S 60 | KLC 60 | L70S 60 |
| 70 | L15S 70 | L25S 70 | L50S 70 | L60S 70 | KLC 70 | L70S 70 |
| 80 | L15S 80 | L25S 80 | L50S 80 | L60S 80 | KLC 80 | L70S 80 |
| 90 | L15S 90 | L25S 90 | L50S 90 | L60S 90 | KLC 90 | L70S 90 |
| 100 | L15S 100 | L25S 100 | L50S 100 | L60S 100 | KLC 100 | L70S 100 |
| 110 | – | – | – | – | KLC 110 | – |
| 125 | L15S 125 | L25S 125 | L50S 125 | L60S 125 | KLC 125 | L70S 125 |
| 150 | L15S 150 | L25S 150 | L50S 150 | L60S 150 | KLC 150 | L70S 150 |
| 175 | – | L25S 175 | L50S 175 | L60S 175 | KLC 175 | L70S 175 |
| 200 | L15S 200 | L25S 200 | L50S 200 | L60S 200 | KLC 200 | L70S 200 |
| 225 | – | L25S 225 | L50S 225 | L60S 225 | KLC 225 | L70S 225 |
| 250 | L15S 250 | L25S 250 | L50S 250 | L60S 250 | KLC 250 | L70S 250 |
| 275 | – | L25S 275 | L50S 275 | – | – | – |
| 300 | L15S 300 | L25S 300 | L50S 300 | L60S 300 | KLC 300 | L70S 300 |
| 350 | L15S 350 | L25S 350 | L50S 350 | L60S 350 | KLC 350 | L70S 350 |
| 400 | L15S 400 | L25S 400 | L50S 400 | L60S 400 | KLC 400 | L70S 400 |
| 450 | L15S 450 | L25S 450 | L50S 450 | L60S 450 | KLC 450 | L70S 450 |
| 500 | L15S 500 | L25S 500 | L50S 500 | L60S 500 | KLC 500 | L70S 500 |
| 550 | – | – | L50S 550 | – | – | – |
| 600 | L15S 600 | L25S 600 | L50S 600 | L60S 600 | KLC 600 | L70S 600 |
| 700 | – | L25S 700 | L50S 700 | L60S 700 | KLC 700 | L70S 700 |
| 800 | L15S 800 | L25S 800 | L50S 800 | L60S 800 | KLC 800 | L70S 800 |
| 900 | – | – | LA50P9004 | – | – | LA70P9004 |
| 1000 | L15S 1000 | – | LA50P10004 | – | – | LA70P10004 |
| 1200 | – | – | LA50P12004 | – | – | LA70P12004 |

‡ KLC series fuses are recommended for replacement use only.

Specifications

Voltage Ratings

- L15S: 150 VAC/DC (1 – 60 A)
150 VAC (70 – 1000 A)
100 VDC (70 – 1000 A)
- L25S: 250 VAC/DC (1 – 200 A)
250 VAC (225 – 800 A)
200 VDC (225 – 800 A)
- L50S: 500 VAC/450 VDC
- L60S: 600 VAC
- KLC: 600 VAC
- L70S: 700 VAC/650 VDC

L25S series fuses are Littelfuse Certified for DC ratings shown in Rating Table.

Interrupting Rating

- AC: 200 kA rms
(L15S series 100 kA)
- DC: 20 kA

Ampere Range 1 – 1200 A See Rating Table for ratings available in each series.

Approvals UL Recognized (File No. E71611)
CSA Recognized (File No. LR29862)

Recommended Fuse Holders

- 1LFS101/1LFS102 121
- LSCR001/LSCR002 120

Web Resources

For additional information, visit:
www.littelfuse.com/semi

TRADITIONAL SEMICONDUCTOR FUSES

Dimensions



| AMPERE RATING | FIG. NO. | DIMENSIONS INCHES (mm) | | | | | | | |
|---------------|----------|------------------------|---|---|---|---|---|---|---|
| | | A | B | C | D | E | F | G | H |

L15S Series, 150 VAC

| | | | | | | | | | |
|------------|---|--------------|--------------|--------------|---------------|-----------|--------------|--------------|------------|
| 1 - 30 | 1 | 1½ (38.1) | — | ¾ (9.5) | 13/32 (10.3) | — | — | — | — |
| 31 - 60 | 1 | 2 (50.8) | — | 5/8 (15.9) | 13/16 (20.6) | — | — | — | — |
| 61 - 450 | 3 | 1½3/2 (29.4) | 1⅞ (47.6) | 2¾ (55.6) | 221/32 (67.5) | 1 (25.4) | 43/64 (17.1) | 5/16 (7.9) | 3/16 (4.8) |
| 451 - 1000 | 3 | 1¼ (31.8) | 15/16 (49.2) | 29/16 (65.1) | 3½ (88.9) | 1½ (38.1) | 1 (25.4) | 13/32 (10.3) | ¼ (6.4) |

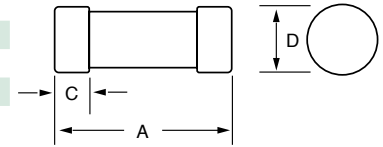

Fig 1

L25S Series, 250 VAC

| | | | | | | | | | |
|-----------|---|---------------|--------------|---------------|---------------|--------------|--------------|--------------|------------|
| 1 - 30 | 1 | 2 (50.8) | — | ½ (12.7) | 9/16 (14.3) | — | — | — | — |
| 31 - 60 | 2 | 1⅞ (41.3) | 2¼ (57.2) | 2½ (63.5) | 33/16 (81.0) | 13/16 (20.6) | 23/32 (18.3) | 11/32 (8.7) | 1/8 (3.2) |
| 61 - 200 | 3 | 1⅞ (41.3) | 25/16 (58.7) | 27/16 (61.9) | 35/8 (79.4) | 17/32 (31.0) | 1 (25.4) | 5/16 (7.9) | 3/16 (4.8) |
| 201 - 700 | 3 | 119/32 (40.5) | 29/32 (57.9) | 229/32 (73.8) | 327/32 (97.6) | 1½ (38.1) | 1 (25.4) | 13/32 (10.3) | ¼ (6.4) |
| 701 - 800 | 3 | 119/32 (40.5) | 29/32 (57.9) | 229/32 (73.8) | 327/32 (97.6) | 2 (50.8) | 1½ (38.1) | 13/32 (10.3) | ¼ (6.4) |

L50S Series, 500 VAC / 450 VDC

| | | | | | | | | | |
|-----------|---|--------------|---------------|---------------|----------------|--------------|--------------|--------------|------------|
| 10 - 30 | 1 | 2 (50.8) | — | ½ (12.7) | 9/16 (14.3) | — | — | — | — |
| 31 - 60 | 2 | 1⅞ (41.3) | 2¼ (57.2) | 2½ (63.5) | 33/16 (81.0) | 13/16 (20.6) | 23/32 (18.3) | 11/32 (8.7) | 1/8 (3.2) |
| 61 - 100 | 3 | 2⅞ (54.0) | 211/16 (68.3) | 3 (76.2) | 35/8 (92.1) | 1 (25.4) | 3/4 (19.1) | 11/32 (8.7) | 1/8 (3.2) |
| 101 - 200 | 3 | 2⅞ (54.0) | 211/16 (71.4) | 215/16 (74.6) | 35/8 (92.1) | 17/32 (31.0) | 1 (25.4) | 5/16 (7.9) | 3/16 (4.8) |
| 201 - 400 | 3 | 23/32 (53.2) | 225/32 (70.6) | 313/32 (86.5) | 411/32 (110.3) | 1½ (38.1) | 1 (25.4) | 13/32 (10.3) | ¼ (6.4) |
| 401 - 600 | 3 | 27/32 (56.4) | 229/32 (73.8) | 317/32 (89.7) | 415/32 (113.5) | 2 (50.8) | 1½ (38.1) | 13/32 (10.3) | ¼ (6.4) |
| 601 - 800 | 3 | 27/32 (56.4) | 49/32 (108.7) | 45/8 (117.5) | 615/32 (164.3) | 2½ (63.5) | 2 (50.8) | 17/32 (13.5) | 3/8 (9.5) |

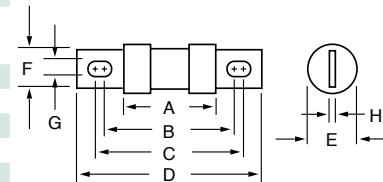

Fig 2

L60S Series, 600 VAC

| | | | | | | | | | |
|-----------|---|---------------|----------------|----------------|----------------|---------------|--------------|--------------|------------|
| 1 - 30 | 1 | 5 (127.0) | — | 5/8 (15.9) | 13/16 (20.6) | — | — | — | — |
| 31 - 60 | 2 | 225/32 (70.6) | 37/16 (87.3) | 311/16 (93.7) | 43/8 (111.1) | 13/16 (20.6) | 23/32 (18.3) | 11/32 (8.7) | 1/8 (3.2) |
| 61 - 100 | 2 | 229/32 (73.8) | 317/32 (89.7) | 325/32 (96.0) | 415/32 (113.5) | 11/16 (27.0) | 23/32 (18.3) | 11/32 (8.7) | 1/8 (3.2) |
| 101 - 200 | 2 | 229/32 (73.8) | 39/16 (90.5) | 3¾ (95.3) | 413/32 (111.9) | 15/16 (33.3) | 1 (25.4) | 5/16 (7.9) | 3/16 (4.8) |
| 201 - 400 | 2 | 229/32 (73.8) | 331/32 (100.8) | 45/32 (105.6) | 5½ (130.2) | 137/64 (40.1) | 1 (25.4) | 13/32 (10.3) | ¼ (6.4) |
| 401 - 600 | 2 | 27/8 (73.0) | 331/32 (100.8) | 49/64 (105.2) | 5½ (130.2) | 21/16 (52.8) | 1½ (38.1) | 13/32 (10.3) | ¼ (6.4) |
| 601 - 800 | 2 | 33/32 (77.0) | 55/32 (133.4) | 513/32 (135.7) | 7¼ (184.2) | 2½ (63.5) | 2 (50.8) | 17/32 (13.5) | 3/8 (9.5) |

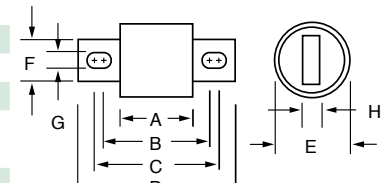

Fig 3

L70S Series, 700 VAC / 600 VDC

| | | | | | | | | | |
|-----------|---|---------------|----------------|----------------|---------------|--------------|--------------|--------------|-------------------------------|
| 10 - 30 | 1 | 2 (50.8) | — | ½ (12.7) | 9/16 (14.3) | — | — | — | — |
| 31 - 60 | 3 | 27/8 (73.0) | 37/16 (87.3) | 325/32 (96.0) | 43/8 (111.1) | 1 (25.4) | 43/64 (17.1) | 11/32 (8.7) | 1/8 (3.2) |
| 61 - 100 | 3 | 27/8 (73.0) | 39/16 (90.5) | 311/16 (93.7) | 43/8 (111.1) | 17/32 (31.0) | 29/32 (22.9) | 5/16 (7.9) | 3/16 (4.8) |
| 101 - 200 | 3 | 227/32 (72.2) | 317/32 (89.7) | 45/32 (105.6) | 53/32 (129.4) | 1½ (38.1) | 1 (25.4) | 13/32 (10.3) | ¼ (6.4) |
| 201 - 400 | 3 | 227/32 (72.2) | 317/32 (89.7) | 45/32 (105.6) | 53/32 (129.4) | 2 (50.8) | 1½ (38.1) | 13/32 (10.3) | ¼ (6.4) |
| 401 - 600 | 3 | 227/32 (72.2) | 429/32 (124.6) | 5¼ (133.4) | 73/32 (180.2) | 2½ (63.5) | 2 (50.8) | 17/32 (13.5) | 3/8 (9.5) |
| 601 - 800 | 4 | 35/16 (84.1) | 55/16 (134.9) | 613/16 (173.0) | — | 27/8 (73.0) | 2 (50.8) | 5/8 (15.9) | H: 3/8 (9.5) J: 9/16 (7.9) |

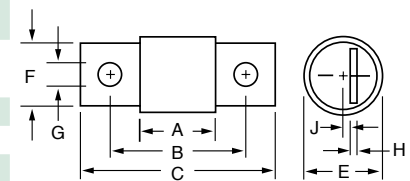

Fig 4

KLC Series, 600 VAC

| | | | | | | | | | |
|-----------|---|---------------|----------------|----------------|---------------|--------------|--------------|--------------|------------|
| 1 - 30 | 2 | 1⅞ (47.6) | 2½ (63.5) | — | 27/8 (73.0) | 9/16 (14.3) | 13/32 (10.3) | ¼ (6.4) | 3/64 (1.2) |
| 31 - 60 | 2 | 23/4 (69.9) | 33/8 (85.7) | 35/8 (92.1) | 45/16 (109.5) | 13/16 (20.6) | 23/32 (18.3) | 11/32 (8.7) | 1/8 (3.2) |
| 61 - 100 | 3 | 27/8 (73.0) | 321/32 (92.9) | 41/16 (103.2) | 5 (127.0) | 1 (25.4) | 3/4 (19.1) | 13/32 (10.3) | 1/8 (3.2) |
| 101 - 200 | 3 | 227/32 (72.2) | 317/32 (89.7) | 43/8 (111.1) | 53/32 (129.4) | 1½ (38.1) | 1 (25.4) | 13/32 (10.3) | ¼ (6.4) |
| 201 - 400 | 3 | 227/32 (72.2) | 421/32 (118.3) | 427/32 (123.0) | 6¼ (158.8) | 2 (50.8) | 15/8 (41.3) | 9/16 (14.3) | ¼ (6.4) |
| 401 - 800 | 3 | 227/32 (72.2) | 421/32 (118.3) | 511/32 (135.7) | 6¼ (158.8) | 2½ (63.5) | 2 (50.8) | 9/16 (14.3) | 3/8 (9.5) |

ALTERNATE DIMENSION SEMICONDUCTOR FUSES

150 VAC • Very Fast-Acting • 1-6000 A



LA15QS Series

| AMPERE RATING | CATALOG NUMBER | MOUNTING TYPE | MAXIMUM CLEARING I ² t @150 VAC (A ² S x 10 ³) | WATTS LOSS @ RATED CURRENT (W) |
|---------------|----------------|---------------|--|--------------------------------|
| 1 | LA15QS1-2 | 2 | 0.002 | 0.68 |
| 2 | LA15QS2-2 | 2 | 0.001 | 1.3 |
| 3 | LA15QS3-2 | 2 | 0.003 | 1.7 |
| 4 | LA15QS4-2 | 2 | 0.007 | 2.1 |
| 5 | LA15QS5-2 | 2 | 0.012 | 2.8 |
| 6 | LA15QS6-2 | 2 | 0.022 | 3.1 |
| 7 | LA15QS7-2 | 2 | 0.011 | 2.2 |
| 8 | LA15QS8-2 | 2 | 0.015 | 2.5 |
| 10 | LA15QS10-2 | 2 | 0.019 | 2.6 |
| 12 | LA15QS12-2 | 2 | 0.030 | 3 |
| 15 | LA15QS15-2 | 2 | 0.042 | 3 |
| 20 | LA15QS20-2 | 2 | 0.072 | 4 |
| 25 | LA15QS25-2 | 2 | 0.14 | 5.2 |
| 30 | LA15QS30-2 | 2 | 0.25 | 5.6 |
| 35 | LA15QS35-1 | 1 | 0.21 | 9 |
| 40 | LA15QS40-1 | 1 | 0.28 | 10 |
| 40 | LA15QS40-4TI | 4TI | 0.39 | 3.1 |
| 45 | LA15QS45-1 | 1 | 0.34 | 12 |
| 50 | LA15QS50-1 | 1 | 0.47 | 13 |
| 50 | LA15QS50-4 | 4 | 0.64 | 4 |
| 55 | LA15QS55-1 | 1 | Contact Factory | Contact Factory |
| 60 | LA15QS60-1 | 1 | 0.94 | 14 |
| 70 | LA15QS70-4 | 4 | 2 | 5.6 |
| 70 | LA15QS70-4TI | 4TI | 2 | 5.6 |
| 80 | LA15QS80-4 | 4 | 2.5 | 8 |
| 80 | LA15QS80-4TI | 4TI | 2.5 | 8 |
| 90 | LA15QS90-4 | 4 | 3.1 | 9 |
| 100 | LA15QS100-4 | 4 | 3.6 | 10 |
| 100 | LA15QS100-4TI | 4TI | 3.6 | 10 |
| 130 | LA15QS130-4 | 4 | 5.3 | 14 |
| 130 | LA15QS130-4TI | 4TI | 5.3 | 14 |
| 150 | LA15QS150-4 | 4 | 6.8 | 16 |
| 150 | LA15QS150-4IL | 4IL | 6.8 | 16 |
| 150 | LA15QS150-4TI | 4TI | 6.8 | 16 |
| 200 | LA15QS200-4 | 4 | 9 | 22 |
| 200 | LA15QS200-4IL | 4IL | 9 | 22 |

| AMPERE RATING | CATALOG NUMBER | MOUNTING TYPE | MAXIMUM CLEARING I ² t @150 VAC (A ² S x 10 ³) | WATTS LOSS @ RATED CURRENT (W) |
|---------------|------------------|---------------|--|--------------------------------|
| 250 | LA15QS250-4 | 4 | 15 | 22 |
| 250 | LA15QS250-4TI | 4TI | 15 | 27 |
| 300 | LA15QS300-4 | 4 | 22 | 33 |
| 300 | LA15QS300-4IL | 4IL | 22 | 33 |
| 300 | LA15QS300-4TL | 4TI | 22 | 33 |
| 350 | LA15QS350-4 | 4 | 32 | 40 |
| 350 | LA15QS350-4TI | 4TI | 32 | 40 |
| 400 | LA15QS400-4 | 4 | 40 | 45 |
| 400 | LA15QS400-4IL | 4IL | 40 | 45 |
| 400 | LA15QS400-4TI | 4TI | 40 | 45 |
| 450 | LA15QS450-4 | 4 | 50 | 50 |
| 450 | LA15QS450-4IL | 4IL | 50 | 50 |
| 500 | LA15QS500-4 | 4 | 90 | 30 |
| 500 | LA15QS500-4IL | 4IL | 90 | 30 |
| 600 | LA15QS600-4 | 4 | 130 | 35 |
| 600 | LA15QS600-4IL | 4IL | 130 | 35 |
| 800 | LA15QS800-4 | 4 | 290 | 57 |
| 1000 | LA15QS1000-4 | 4 | 520 | 75 |
| 1000 | LA15QS1000-4IL | 4IL | 520 | 75 |
| 1000 | LA15QS1000-4TI | 4TI | 520 | 75 |
| 1000 | LA15QS1000-128 | 128 | 540 | 88 |
| 1000 | LA15QS1000-128IL | 128IL | 540 | 88 |
| 1200 | LA15QS1200-128 | 128 | 680 | 100 |
| 1200 | LA15QS1200-128IL | 128IL | 680 | 100 |
| 1500 | LA15QS1500-128 | 128 | 1200 | 130 |
| 1500 | LA15QS1500-128IL | 128IL | 1200 | 130 |
| 2000 | LA15QS2000-128 | 128 | 1900 | 165 |
| 2000 | LA15QS2000-128IL | 128IL | 1900 | 165 |
| 2500 | LA15QS2500-128 | 128 | 3200 | 195 |
| 2500 | LA15QS2500-128IL | 128IL | 3200 | 195 |
| 3000 | LA15QS3000-128 | 128 | 4800 | 240 |
| 3000 | LA15QS3000-128IL | 128IL | 4800 | 240 |
| 3500 | LA15QS3500-128 | 128 | 6500 | 260 |
| 4000 | LA15QS4000-128 | 128 | 8500 | 270 |
| 4000 | LA15QS4000-128IL | 128IL | 8500 | 270 |
| 5000 | LA15QS5000-128 | 128 | Contact Factory | Contact Factory |
| 6000 | LA15QS6000-128 | 128 | Contact Factory | Contact Factory |

Semiconductor Fuses 5

Specifications

| | |
|----------------------------|------------------------|
| Voltage Rating | AC: 150 V DC: 150 V |
| Interrupting Rating | 100 kA |
| Ampere Range | 1 – 6000 A |
| Approvals | UL Recognized |

Web Resources

TC Curves, downloadable CAD drawings and other technical information: www.littelfuse.com/la15qs

Dimensions

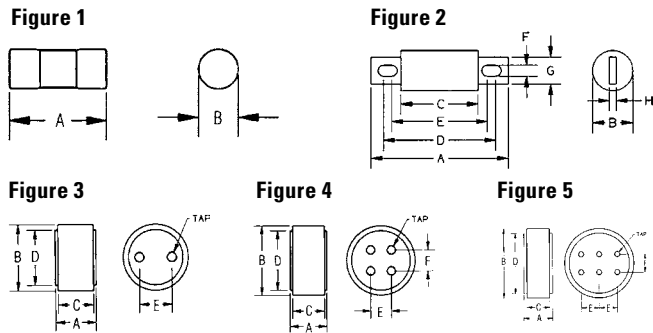

Dimensions for reference only.

| AMPERE RATINGS | MOUNTING TYPE | FIGURE NO. | DIMENSIONS INCHES (mm) | | | | | | | | | TAP |
|----------------|---------------|------------|------------------------|-------------|-------------|-------------|-------------|-------------|-------------|------------|---|-----------------|
| | | | A | B | C | D | E | F | G | H | | |
| 1 – 30 | 2 | 1 | 1.50 (38.1) | 0.41 (10.4) | – | – | – | – | – | – | – | – |
| 35 – 60 | 1 | 1 | 2.00 (50.8) | 0.81 (20.6) | – | – | – | – | – | – | – | – |
| 40 – 450 | 4, 4TI*, 4IL* | 2 | 2.66 (67.6) | 1.00 (25.4) | 1.16 (29.5) | 2.19 (55.6) | 1.91 (48.5) | 0.31 (7.9) | 0.88 (22.4) | 0.19 (4.8) | – | – |
| 500 – 1000 | 4, 4TI*, 4IL* | 2 | 3.50 (88.9) | 1.50 (38.1) | 1.25 (31.8) | 2.56 (65.0) | 1.94 (49.3) | 0.41 (10.4) | 1.00 (25.4) | 0.25 (6.4) | – | – |
| 750 – 2000 | 128, 128IL* | 3 | 1.88 (47.9) | 2.00 (50.8) | 1.63 (41.4) | 1.75 (44.5) | 1.00 (25.4) | – | – | – | – | 3/8-24-1/2 deep |
| 2500 – 3000 | 128, 128IL* | 3 | 1.88 (47.9) | 3.00 (76.2) | 1.63 (41.4) | 2.50 (63.5) | 1.50 (38.1) | – | – | – | – | 1/2-20-1/2 deep |
| 3500 – 4000 | 128, 128IL* | 4 | 1.88 (47.9) | 3.50 (88.9) | 1.63 (41.4) | 3.00 (76.2) | 1.06 (27.0) | 1.06 (27.0) | – | – | – | 1/2-20-1/2 deep |
| 5000 – 6000 | 128 | 5 | 2.38 (60.5) | 5.75 (146) | 1.88 (47.7) | 5.00 (127) | 1.50 (38.1) | 1.50 (38.1) | – | – | – | 1/2-20-1/2 deep |

*Optional Trigger Actuator (IL). Optional Trigger Indicator (TI) see web for dimensions.

ALTERNATE DIMENSION SEMICONDUCTOR FUSES

300 VAC • Very Fast-Acting • 35-4500 A



LA30QS Series

| AMPERE RATING | CATALOG NUMBER | MOUNTING TYPE | MAXIMUM CLEARING I ² T @300 VAC (A ² S X 10 ³) | WATTS LOSS @ RATED CURRENT (W) |
|---------------|----------------|---------------|--|--------------------------------|
| 35 | LA30QS35-4 | 4 | 0.9 | 6.4 |
| 40 | LA30QS40-4 | 4 | 1.2 | 7 |
| 50 | LA30QS50-4 | 4 | 2 | 9.9 |
| 60 | LA30QS60-4 | 4 | 2.7 | 11.6 |
| 70 | LA30QS70-4 | 4 | 1.6 | 11 |
| 80 | LA30QS80-4 | 4 | 2.6 | 11 |
| 90 | LA30QS90-4 | 4 | 3.2 | 13 |
| 100 | LA30QS100-4 | 4 | 4.1 | 13 |
| 100 | LA30QS100-4TI | 4TI | 4.1 | 13 |
| 125 | LA30QS125-4 | 4 | 6.3 | 16 |
| 130 | LA30QS130-4 | 4 | 6.3 | 16 |
| 150 | LA30QS150-4 | 4 | 9.3 | 19 |
| 150 | LA30QS150-4TI | 4TI | 9.3 | 19 |
| 175 | LA30QS175-4 | 4 | 10 | 27 |
| 200 | LA30QS200-4 | 4 | 15 | 30 |
| 200 | LA30QS200-4TI | 4TI | 15 | 30 |
| 225 | LA30QS225-4 | 4 | 22 | 33 |
| 250 | LA30QS250-4 | 4 | 25 | 41 |
| 250 | LA30QS250-4TI | 4TI | 25 | 41 |
| 300 | LA30QS300-4 | 4 | 37 | 47 |
| 300 | LA30QS300-4TI | 4TI | 37 | 47 |
| 350 | LA30QS350-4 | 4 | 62 | 49 |
| 400 | LA30QS400-4 | 4 | 83 | 56 |
| 400 | LA30QS400-4IL | 4IL | 83 | 56 |
| 400 | LA30QS400-4TI | 4TI | 83 | 56 |
| 450 | LA30QS450-4 | 4 | 130 | 53 |

| AMPERE RATING | CATALOG NUMBER | MOUNTING TYPE | MAXIMUM CLEARING I ² T @300 VAC (A ² S X 10 ³) | WATTS LOSS @ RATED CURRENT (W) |
|---------------|------------------|---------------|--|--------------------------------|
| 500 | LA30QS500-4 | 4 | 160 | 59 |
| 550 | LA30QS550-4 | 4 | 190 | 65 |
| 600 | LA30QS600-4 | 4 | 230 | 69 |
| 600 | LA30QS600-4TI | 4TI | 230 | 69 |
| 600 | LA30QS600-4IL | 4IL | 230 | 69 |
| 700 | LA30QS700-4 | 4 | 260 | 90 |
| 700 | LA30QS700-128 | 128 | 260 | 73 |
| 800 | LA30QS800-4 | 4 | 330 | 108 |
| 800 | LA30QS800-4IL | 4IL | 330 | 108 |
| 800 | LA30QS800-128 | 128 | 330 | 84 |
| 1000 | LA30QS1000-128 | 128 | 460 | 105 |
| 1000 | LA30QS1000-128IL | 128IL | 460 | 105 |
| 1200 | LA30QS1200-128 | 128 | 880 | 110 |
| 1500 | LA30QS1500-128 | 128 | 1400 | 140 |
| 1500 | LA30QS1500-128IL | 128IL | 1400 | 140 |
| 1600 | LA30QS1600-128 | 128 | 1690 | 150 |
| 2000 | LA30QS2000-128 | 128 | 2600 | 190 |
| 2000 | LA30QS2000-128IL | 128IL | 2600 | 190 |
| 2500 | LA30QS2500-128 | 128 | 4000 | 230 |
| 2500 | LA30QS2500-128IL | 128IL | 4000 | 230 |
| 3000 | LA30QS3000-128 | 128 | 4700 | 340 |
| 3500 | LA30QS3500-128 | 128 | 6500 | 380 |
| 3500 | LA30QS3500-128IL | 128IL | 6500 | 380 |
| 4000 | LA30QS4000-128 | 128 | 8600 | 450 |
| 4500 | LA30QS4500-128 | 128 | 11000 | 500 |

Specifications

| | |
|----------------------------|------------------------|
| Voltage Rating | AC: 300 V DC: 300 V |
| Interrupting Rating | 200 kA |
| Ampere Range | 35 – 4500 A |
| Approvals | UL Recognized |

Web Resources

TC Curves, downloadable CAD drawings and other technical information: www.littelfuse.com/la30qs

Dimensions

Dimensions for reference only.

| AMPERE RATING | MOUNTING TYPE | FIGURE NO. | DIMENSIONS INCHES (mm) | | | | | | | | TAP |
|---------------|---------------|------------|------------------------|-------------|-------------|-------------|-------------|-------------|-------------|------------|-----------------|
| | | | A | B | C | D | E | F | G | H | |
| 35 – 60 | 4 | 1 | 3.19 (81.0) | 0.81 (20.6) | 1.63 (41.4) | 2.50 (63.5) | 2.25 (57.5) | 0.34 (8.6) | 0.72 (18.3) | 0.13 (3.3) | – |
| 70 – 200 | 4 | 2 | 3.13 (79.5) | 1.22 (31.0) | 1.63 (41.4) | 2.44 (62.0) | 2.31 (58.7) | 0.31 (7.9) | 1.00 (25.4) | 0.19 (4.8) | – |
| 225 – 800 | 4, 4IL* | 2 | 3.84 (97.5) | 1.50 (38.1) | 1.59 (40.1) | 2.91 (73.9) | 2.28 (57.9) | 0.41 (10.4) | 1.00 (25.4) | 0.25 (6.4) | – |
| 800 – 1200 | 128 | 3 | 2.59 (65.8) | 3.00 (76.2) | 2.34 (59.4) | 2.50 (63.5) | 1.50 (38.1) | – | – | – | 3/8-24-1/2 deep |
| 1500 – 2500 | 128, 128IL* | 4 | 2.59 (65.8) | 3.50 (88.9) | 2.34 (59.4) | 3.00 (76.2) | 1.50 (38.1) | 1.50 (38.1) | – | – | 3/8-24-1/2 deep |
| 3000 – 4500 | 128, 128IL* | 4 | 2.59 (65.8) | 4.50 (114) | 2.34 (59.4) | 3.75 (95.3) | 1.50 (38.1) | 1.50 (38.1) | – | – | 1/2-20-1/2 deep |

*Optional Trigger Actuator (IL). Optional Trigger Indicator (TI) see web for dimensions.

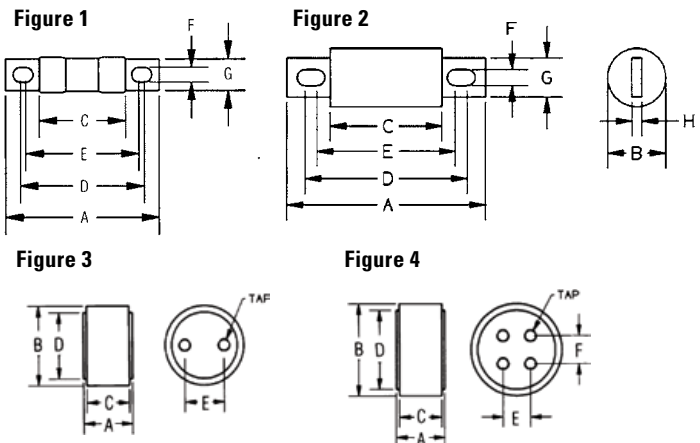

ALTERNATE DIMENSION SEMICONDUCTOR FUSES

500 VAC • Very Fast-Acting • 35-1200 A



LA50QS Series

| AMPERE RATING | CATALOG NUMBER | MOUNTING TYPE | MAXIMUM CLEARING I ² T @500 VAC (A ² S X 10 ³) | WATTS LOSS @ RATED CURRENT (W) |
|---------------|----------------|---------------|--|--------------------------------|
| 35 | LA50QS35-4 | 4 | 0.56 | 6 |
| 40 | LA50QS40-4 | 4 | 0.69 | 7 |
| 50 | LA50QS50-4 | 4 | 1.1 | 8 |
| 60 | LA50QS60-4 | 4 | 1.8 | 10 |
| 70 | LA50QS70-4 | 4 | 1.9 | 12 |
| 80 | LA50QS80-4 | 4 | 2.6 | 14 |
| 90 | LA50QS90-4 | 4 | 3.6 | 15 |
| 100 | LA50QS100-4 | 4 | 4.4 | 17 |
| 125 | LA50QS125-4 | 4 | 5.6 | 21 |
| 150 | LA50QS150-4 | 4 | 9 | 25 |
| 175 | LA50QS175-4 | 4 | 15 | 29 |
| 200 | LA50QS200-4 | 4 | 20 | 33 |
| 225 | LA50QS225-4 | 4 | 25 | 37 |

| AMPERE RATING | CATALOG NUMBER | MOUNTING TYPE | MAXIMUM CLEARING I ² T @500 VAC (A ² S X 10 ³) | WATTS LOSS @ RATED CURRENT (W) |
|---------------|----------------|---------------|--|--------------------------------|
| 250 | LA50QS250-4 | 4 | 29 | 41 |
| 300 | LA50QS300-4 | 4 | 55 | 49 |
| 350 | LA50QS350-4 | 4 | 88 | 57 |
| 400 | LA50QS400-4 | 4 | 98 | 65 |
| 450 | LA50QS450-4 | 4 | 130 | 69 |
| 500 | LA50QS500-4 | 4 | 160 | 77 |
| 600 | LA50QS600-4 | 4 | 220 | 92 |
| 700 | LA50QS700-4 | 4 | 270 | 110 |
| 800 | LA50QS800-4 | 4 | 360 | 130 |
| 900 | LA50QS900-4 | 4 | 500 | 140 |
| 1000 | LA50QS1000-4 | 4 | 560 | 160 |
| 1200 | LA50QS1200-4 | 4 | 930 | 175 |

Specifications

| | |
|----------------------------|--------------------------------|
| Voltage Rating | AC: 500 V DC: 500 V |
| Interrupting Rating | AC: 200 kA DC: 100 kA |
| Ampere Range | 35 – 1200 A |
| Approvals | UL Recognized CSA Certified |

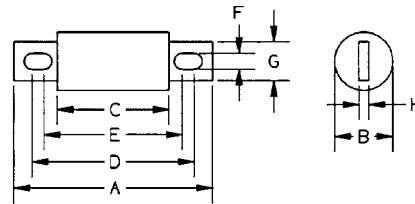

Web Resources

TC Curves, downloadable CAD drawings and other technical information: www.littelfuse.com/la50qs

Dimensions

Dimensions for reference only.

| AMPERE RATING | MOUNTING TYPE | DIMENSIONS INCHES (mm) | | | | | | | |
|---------------|---------------|------------------------|----------------|----------------|-----------------|-----------------|----------------|----------------|----------------|
| | | A | B | C | D | E | F | G | H |
| 35 – 100 | 4 | 3.63 (92.2) | 1.00 (25.4) | 2.13 (54.1) | 2.94 (74.7) | 2.75 (69.9) | 0.31 (7.9) | 0.75 (19.1) | 0.13 (3.3) |
| 125 – 200 | 4 | 3.63 (92.2) | 1.22 (31.0) | 2.13 (54.1) | 2.94 (74.7) | 2.81 (71.4) | 0.31 (7.9) | 1.00 (25.4) | 0.19 (4.8) |
| 225 – 400 | 4 | 4.34 (110) | 1.50 (38.1) | 2.09 (53.1) | 3.41 (86.6) | 2.78 (70.6) | 0.41 (10.4) | 1.00 (25.4) | 0.25 (6.4) |
| 450 – 600 | 4 | 4.47 (114) | 2.00 (50.8) | 2.22 (56.4) | 3.53 (89.7) | 2.91 (73.9) | 0.41 (10.4) | 1.50 (38.1) | 0.25 (6.4) |
| 700 – 800 | 4 | 6.47 (164.3) | 2.50 (63.5) | 2.22 (56.4) | 5.00 (127.0) | 3.44 (87.3) | 0.53 (13.5) | 1.50 (38.1) | 0.25 (6.4) |
| 900 – 1200 | 4 | 6.97 (177.0) | 3.00 (76.2) | 3.22 (81.8) | 5.47 (138.9) | 4.47 (113.5) | 0.63 (15.9) | 2.38 (60.3) | 0.44 (11.1) |

Contact Littelfuse for characteristic curves.

ALTERNATE DIMENSION SEMICONDUCTOR FUSES

600 VAC/DC • Very Fast-Acting • 5-40 A



LA60Q Series Semiconductor Fuses

| AMPERE RATING | CATALOG NUMBER | MOUNTING TYPE | MAXIMUM CLEARING I ² T @600 VAC (A ² S) | WATTS LOSS @ RATED CURRENT (W) |
|---------------|----------------|---------------|---|--------------------------------|
| 5 | LA60Q5-2 | 2 | 60 | 0.7 |
| 8 | LA60Q8-2 | 2 | 70 | 1.1 |
| 10 | LA60Q10-2 | 2 | 110 | 1.6 |
| 12 | LA60Q12-2 | 2 | 150 | 2 |
| 15 | LA60Q15-2 | 2 | 180 | 3 |
| 20 | LA60Q20-2 | 2 | 330 | 4.4 |
| 25 | LA60Q25-2 | 2 | 440 | 5.5 |
| 30 | LA60Q30-2 | 2 | 860 | 5.6 |
| 35 | LA60Q35-2 | 2 | 1300 | 6.4 |
| 40 | LA60Q40-2 | 2 | 1800 | 7 |

Specifications

| | |
|----------------------------|--------------------------|
| Voltage Rating | AC: 600 V DC: 600 V |
| Interrupting Rating | AC: 200 kA DC: 100 kA |
| Ampere Range | 5 – 40 A |
| Approvals | UL Recognized |

Contact Littelfuse for characteristic curves.

Description

Littelfuse LA60Q semiconductor protection fuses feature a 600 volt AC/DC rating in a compact size (1 1/2" x 13/32"). LA60Q also has the lowest I²t of all similar fuses and excellent cycling ability. Applications include inverters and small equipment requiring extremely fast response to faults, without the need to carry sustained heavy overloads.

Dimensions Inches

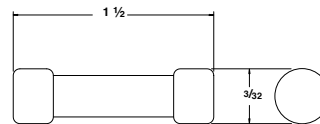

Web Resources

TC Curves, downloadable CAD drawings and other technical information: www.littelfuse.com/la60q

690 VAC/700 VDC • Very Fast-Acting • 10-100 A



LA70QS Series French Cylindrical Fuses

| AMPERE RATING | CATALOG NUMBER (NO STRIKER) | CATALOG NUMBER (WITH STRIKER) | BODY SIZE | MAXIMUM CLEARING I ² T @700 VAC (A ² S X 10 ³) | WATTS LOSS @ RATED CURRENT (W) |
|---------------|-----------------------------|-------------------------------|-----------|--|--------------------------------|
| 10 | LA70QS10-14F | LA70QS10-14FI | 14 x 51 | 0.04 | 3.5 |
| 12 | LA70QS12-14F | LA70QS12-14FI | 14 x 51 | 0.06 | 4.4 |
| 16 | LA70QS16-14F | LA70QS16-14FI | 14 x 51 | 0.10 | 4.8 |
| 20 | LA70QS20-14F | LA70QS20-14FI | 14 x 51 | 0.16 | 5.2 |
| 25 | LA70QS25-14F | LA70QS25-14FI | 14 x 51 | 0.27 | 5.8 |
| 32 | LA70QS32-14F | LA70QS32-14FI | 14 x 51 | 1.50 | 7.0 |
| 40 | LA70QS40-14F | LA70QS40-14FI | 14 x 51 | 0.70 | 10.7 |
| 50 | LA70QS50-14F | LA70QS50-14FI | 14 x 51 | 1.50 | 11.6 |
| 20 | LA70QS20-22F | LA70QS20-22FI | 22 x 58 | 0.076 | 8.0 |
| 25 | LA70QS25-22F | LA70QS25-22FI | 22 x 58 | 0.125 | 10.0 |
| 32 | LA70QS32-22F | LA70QS32-22FI | 22 x 58 | 0.27 | 11.0 |
| 40 | LA70QS40-22F | LA70QS40-22FI | 22 x 58 | 0.48 | 13.0 |
| 50 | LA70QS50-22F | LA70QS50-22FI | 22 x 58 | 0.80 | 14.9 |
| 63 | LA70QS63-22F | LA70QS63-22FI | 22 x 58 | 1.85 | 16.0 |
| 80 | LA70QS80-22F | LA70QS80-22FI | 22 x 58 | 3.80 | 17.8 |
| 100 | LA70QS100-22F | LA70QS100-22FI | 22 x 58 | 8.00 | 19.0 |

Recommended Fuse Holders

| | |
|---|-----|
| CYH series for non-striker fuses LA70QS(amp)22F | 183 |
| CYH1451 series for LA70QS(amp)14F | 183 |

Description

Littelfuse LA70QS semiconductor fuses were developed to provide improved performance required by today's new equipment. The LA70QS features lower I²t, improved cycling, and lower watts loss. It is the best choice for the protection of dynamic solid-state equipment.

Dimensions

Please see website for dimensions: www.littelfuse.com/la70qs

Specifications

| | |
|----------------------------|--------------------------------|
| Voltage Rating | AC: 690 V DC: 700 V |
| Interrupting Rating | AC: 200 kA DC: 100 kA |
| Ampere Range | 10 – 100 A |
| Approvals | UL Recognized CSA Certified |

Web Resources

TC Curves, downloadable CAD drawings and other technical information: www.littelfuse.com/la70qs

ALTERNATE DIMENSION SEMICONDUCTOR FUSES

700 VAC/VDC • Very Fast-Acting • 35-800 A



LA70QS Series Semiconductor Fuses

| AMPERE RATING | CATALOG NUMBER | MOUNTING TYPE | MAXIMUM CLEARING I ² T @700 VAC (A ² S X 10 ³) | WATTS LOSS @ RATED CURRENT (W) |
|---------------|----------------|---------------|--|--------------------------------|
| 35 | LA70QS35-4 | 4 | 0.47 | 6.2 |
| 40 | LA70QS40-4 | 4 | 0.58 | 7.5 |
| 50 | LA70QS50-4 | 4 | 0.88 | 9.8 |
| 60 | LA70QS60-4 | 4 | 1.2 | 12 |
| 70 | LA70QS70-4 | 4 | 1.8 | 15 |
| 80 | LA70QS80-4 | 4 | 2.3 | 16 |
| 90 | LA70QS90-4 | 4 | 3 | 20 |
| 100 | LA70QS100-4 | 4 | 3.6 | 24 |
| 125 | LA70QS125-4 | 4 | 6.9 | 22 |
| 125 | LA70QS125-4K | 4K | 6.9 | 22 |
| 150 | LA70QS150-4 | 4 | 11 | 28 |
| 150 | LA70QS150-4K | 4K | 11 | 29 |
| 175 | LA70QS175-4 | 4 | 14 | 35 |
| 175 | LA70QS175-4K | 4K | 14 | 35 |

| AMPERE RATING | CATALOG NUMBER | MOUNTING TYPE | MAXIMUM CLEARING I ² T @700 VAC (A ² S X 10 ³) | WATTS LOSS @ RATED CURRENT (W) |
|---------------|----------------|---------------|--|--------------------------------|
| 200 | LA70QS200-4 | 4 | 19 | 41 |
| 200 | LA70QS200-4K | 4 | 19 | 41 |
| 250 | LA70QS250-4 | 4 | 42 | 42 |
| 300 | LA70QS300-4 | 4 | 55 | 53 |
| 350 | LA70QS350-4 | 4 | 72 | 64 |
| 400 | LA70QS400-4 | 4 | 99 | 75 |
| 450 | LA70QS450-4 | 4 | 125 | 75 |
| 450 | LA70QS450-4K | 4K | 125 | 75 |
| 500 | LA70QS500-4 | 4 | 150 | 92 |
| 500 | LA70QS500-4K | 4K | 160 | 92 |
| 600 | LA70QS600-4 | 4 | 222 | 116 |
| 600 | LA70QS600-4K | 4K | 222 | 116 |
| 700 | LA70QS700-4 | 4 | 332 | 125 |
| 800 | LA70QS800-4 | 4 | 433 | 143 |

Specifications

| | |
|----------------------------|--------------------------------|
| Voltage Rating | AC: 700 V DC: 700 V |
| Interrupting Rating | AC: 200 kA DC: 100 kA |
| Ampere Range | 35 – 800 A |
| Approvals | UL Recognized CSA Certified |

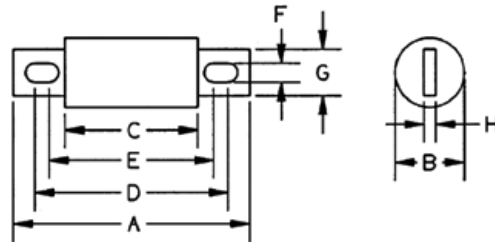

Web Resources

TC Curves, downloadable CAD drawings and other technical information: www.littelfuse.com/la70qs

Dimensions

Dimensions for reference only.

| AMPERES | MOUNTING TYPE | DIMENSIONS INCHES (mm) | | | | | | | |
|-----------|---------------|------------------------|----------------|----------------|----------------|----------------|----------------|----------------|---------------|
| | | A | B | C | D | E | F | G | H |
| 35 – 100 | 4 | 4.38 (111) | 1.00 (25.4) | 2.88 (73) | 3.69 (93.6) | 3.50 (88.9) | 0.31 (7.9) | 0.75 (19.0) | 0.13 (3.2) |
| 125 – 200 | 4 | 4.38 (111) | 1.22 (31.0) | 2.88 (73) | 3.69 (93.6) | 3.56 (90.5) | 0.31 (7.9) | 1.00 (25.4) | 0.19 (4.8) |
| 125 – 200 | 4K | 5.09 (129) | 1.22 (31.0) | 2.88 (73) | 4.19 (106) | 3.50 (88) | 0.41 (10.3) | 1.00 (25.4) | 0.19 (4.8) |
| 225 – 400 | 4 | 5.09 (129) | 1.50 (38.1) | 2.84 (72.2) | 4.16 (106) | 3.53 (89.7) | 0.40 (10.3) | 1.50 (38.1) | 0.25 (6.4) |
| 450 – 600 | 4 | 5.09 (129) | 2.00 (50.8) | 2.84 (72.2) | 4.16 (106) | 3.53 (89.7) | 0.41 (10.3) | 1.50 (38.1) | 0.25 (6.4) |
| 450 – 600 | 4K | 7.09 (180) | 2.00 (50.8) | 2.84 (72.2) | 6.16 (156) | 3.53 (89.7) | 0.53 (13.5) | 1.50 (38.1) | 0.25 (6.4) |
| 700 – 800 | 4 | 7.09 (180) | 2.50 (63.5) | 2.84 (72.2) | 5.28 (134) | 4.91 (125) | 0.53 (13.5) | 2.00 (50.8) | 0.38 (9.5) |

Contact Littelfuse for characteristic curves.

ALTERNATE DIMENSION SEMICONDUCTOR FUSES

1000 VAC • Very Fast-Acting • 15-1000 A



LA100P Series Semiconductor Fuses

| AMPERE RATING | CATALOG NUMBER | MOUNTING TYPE | MAXIMUM CLEARING I ² T @1000 VAC (A ² S X 10 ³) | WATTS LOSS @ RATED CURRENT (W) |
|---------------|----------------|---------------|---|--------------------------------|
| 15 | LA100P15-1 | 1 | 0.6 | 3.4 |
| 20 | LA100P20-1 | 1 | 0.8 | 5.9 |
| 25 | LA100P25-1 | 1 | 1.3 | 9 |
| 30 | LA100P30-1 | 1 | 1.5 | 12.8 |
| 35 | LA100P35-4 | 4 | 2.2 | 7.3 |
| 40 | LA100P40-4 | 4 | 2.9 | 8.3 |
| 50 | LA100P50-4 | 4 | 4.5 | 11 |
| 60 | LA100P60-4 | 4 | 6.5 | 13 |
| 80 | LA100P80-4 | 4 | 12 | 14 |
| 100 | LA100P100-4 | 4 | 18 | 18 |
| 125 | LA100P125-4 | 4 | 28 | 23 |
| 150 | LA100P150-4 | 4 | 41 | 28 |
| 200 | LA100P200-4 | 4 | 72 | 36 |
| 225 | LA100P225-4 | 4 | 91 | 40 |
| 250 | LA100P250-4 | 4 | 110 | 46 |
| 300 | LA100P300-4 | 4 | 160 | 55 |
| 350 | LA100P350-4 | 4 | 220 | 65 |
| 400 | LA100P400-4 | 4 | 290 | 70 |
| 500 | LA100P500-4 | 4 | 450 | 90 |
| 600 | LA100P600-4 | 4 | 650 | 110 |
| 650 | LA100P650-4 | 4 | 780 | 120 |
| 700 | LA100P700-4 | 4 | 880 | 125 |
| 800 | LA100P800-4 | 4 | 1200 | 140 |
| 1000 | LA100P1000-4 | 4 | 1900 | 190 |

Figure 1

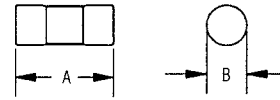

Figure 2

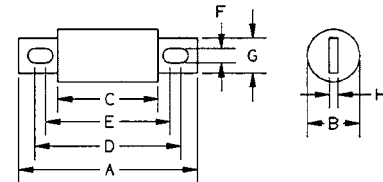

Figure 3

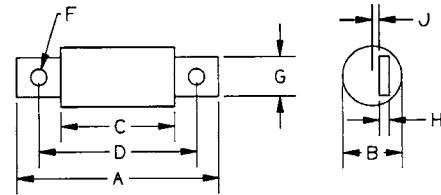
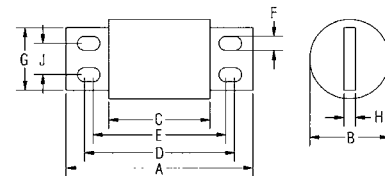

Figure 4



Web Resources

TC Curves, downloadable CAD drawings and other technical information: www.littelfuse.com/la100p

Specifications

| | |
|----------------------------|-------------------------|
| Voltage Rating | AC: 1000 V DC: 750 V |
| Interrupting Rating | 100 kA |
| Ampere Range | 15 – 1000 A |
| Approvals | UL Recognized |

Dimensions

Dimensions for reference only.

| AMPERES | MOUNTING TYPE | FIGURE NO. | DIMENSIONS INCHES (mm) | | | | | | | | |
|-----------|---------------|------------|------------------------|----------------|----------------|---------------|---------------|----------------|----------------|----------------|----------------|
| | | | A | B | C | D | E | F | G | H | J |
| 15 – 30 | 1 | 1 | 2.53 (66.8) | 0.56 (14.2) | - | - | - | - | - | - | - |
| 35 – 60 | 4 | 2 | 5.00 (127) | 1.00 (25.4) | 3.50 (88.9) | 4.31 (109) | 4.19 (106) | 0.31 (7.9) | 0.75 (19.1) | 0.13 (3.3) | - |
| 65 – 100 | 4 | 2 | 5.00 (127) | 1.22 (31) | 3.50 (88.9) | 4.31 (109) | 4.19 (106) | 0.31 (7.9) | 1.00 (25.4) | 0.19 (4.8) | - |
| 125 – 200 | 4 | 2 | 5.72 (145) | 1.50 (38.1) | 3.47 (88.1) | 4.78 (121) | 4.16 (106) | 0.41 (10.4) | 1.00 (25.4) | 0.25 (6.4) | - |
| 225 – 400 | 4 | 2 | 5.72 (145) | 2.00 (50.8) | 3.47 (88.1) | 4.78 (121) | 4.16 (106) | 0.41 (10.4) | 1.50 (25.4) | 0.25 (6.4) | - |
| 500 – 600 | 4 | 2 | 7.72 (196) | 2.50 (63.5) | 3.47 (88.1) | 5.88 (149) | 5.56 (147) | 0.53 (13.5) | 2.00 (50.8) | 0.38 (9.7) | - |
| 650 – 800 | 4 | 3 | 7.44 (189) | 2.88 (73.2) | 3.94 (100) | 5.94 (151) | - | 0.63 (16) | 2.00 (50.8) | 0.38 (9.7) | 0.31 (7.9) |
| 1000 | 4 | 4 | 8.22 (209) | 3.50 (88.9) | 4.47 (114) | 6.59 (167) | 5.84 (148) | 0.63 (16) | 2.75 (69.9) | 0.50 (12.7) | 1.38 (35.1) |

Optional Trigger Indicator (TI) for 50 A - 1000 A available
Contact Littelfuse for characteristic curves.

SQUARE BODY SEMICONDUCTOR FUSES

700/1300 VAC • Very Fast-Acting • 63-2500 A



Description

Littelfuse North American style square body semiconductor fuses provide maximum flexibility in equipment design and ultimate protection for today's power conversion equipment. Available in different body sizes and multiple mounting styles, the broad range of ampere ratings allows great flexibility in equipment design.

Engineered to provide state-of-the-art protection for SCRs, diodes, thyristors, GTOs, and IGBT devices, Littelfuse square body fuses have pure die-cut elements embedded in solidified sand to control arcing and lower I²t. All fuses are also equipped with a blown fuse trip indicator.

Features

- Choice of mounting styles provides a wide choice for equipment design.
- Broad range of ampere ratings in a given body size for design flexibility.
- Very low I²t minimizes damage to protected components.
- Superior cycling ability for long, reliable life on high cyclic loading.
- Extremely fast-acting and current-limiting for improved protection to equipment.

Applications

Protection of rectifiers, inverters, DC drives, UPS systems, reduced voltage motor starters, and other equipment in globally accepted applications.

Specifications

| | |
|----------------------------|--------------------------------------|
| Voltage Rating | AC: 700 V (LA070) 1300 V (LA130) |
| | DC: Contact factory |
| Interrupting Rating | AC: 200 kA (LA070) 100 kA (LA130) |
| | DC: Contact factory |
| Ampere Range | 63 – 2500 A |
| Approvals | UL Recognized Component |

Dimensions

Please refer to the Square Body dimensions 76-78

Web Resources

For additional information, visit:
www.littelfuse.com/la070

Ordering Information

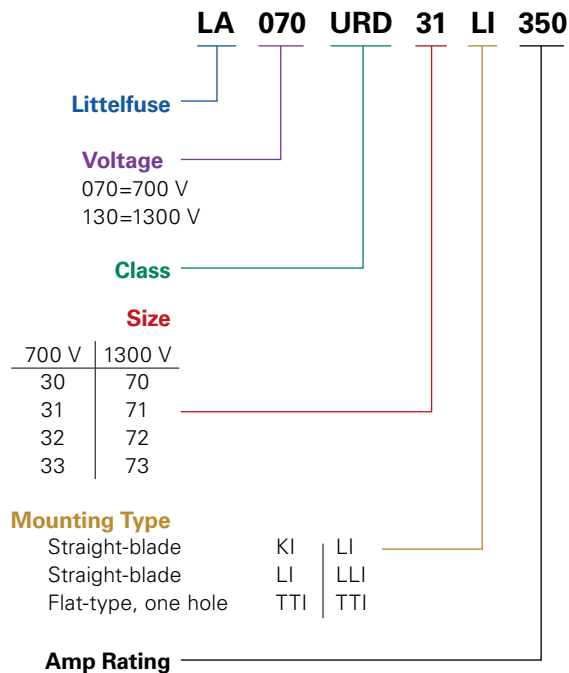

SQUARE BODY SEMICONDUCTOR FUSES

700/1300 VAC • Very Fast-Acting • 63-2500 A

| BODY SIZE | AMPERE RATING | RATED VOLTAGE | MELTING I ² T (A ² S X 10 ³) | TOTAL I ² T @ RATED VOLTAGE (A ² S X 10 ³) | *WATTS LOSS @ RATED CURRENT (W) | LONG BLADE CATALOG NUMBER TYPE LI | SHORT BLADE CATALOG NUMBER TYPE KI | TAPPED TERMINAL CATALOG NUMBER TYPE TTI |
|-----------|---------------|---------------|--|--|---------------------------------|-----------------------------------|------------------------------------|---|
| 30 | 63 | 700 | 0.2 | 1.2 | 14 | LA070URD30LI0063 | LA070URD30KI0063 | LA070URD30TTI0063 |
| | 80 | 700 | 0.33 | 1.9 | 19 | LA070URD30LI0080 | LA070URD30KI0080 | LA070URD30TTI0080 |
| | 100 | 700 | 0.47 | 2.7 | 26 | LA070URD30LI0100 | LA070URD30KI0100 | LA070URD30TTI0100 |
| | 125 | 700 | 0.85 | 4.9 | 30 | LA070URD30LI0125 | LA070URD30KI0125 | LA070URD30TTI0125 |
| | 160 | 700 | 1.6 | 9.2 | 37 | — | LA070URD30KI0160 | LA070URD30TTI0160 |
| | 200 | 700 | 3 | 16.7 | 42/43 | LA070URD30LI0200 | LA070URD30KI0200 | LA070URD30TTI0200 |
| | 250 | 700 | 5.8 | 32.4 | 48/50 | LA070URD30LI0250 | LA070URD30KI0250 | LA070URD30TTI0250 |
| | 315 | 700 | 12 | 67 | 53/55 | LA070URD30LI0315 | LA070URD30KI0315 | LA070URD30TTI0315 |
| | 350 | 700 | 15.5 | 86 | 57/60 | LA070URD30LI0350 | LA070URD30KI0350 | LA070URD30TTI0350 |
| | 400 | 700 | 23 | 130 | 60/65 | LA070URD30LI0400 | LA070URD30KI0400 | LA070URD30TTI0400 |
| | 450 | 700 | 26 | 165 | 80/88 | LA070URD30LI0450 | LA070URD30KI0450 | LA070URD30TTI0450 |
| | 500 | 700 | 41 | 264 | 80/88 | LA070URD30LI0500 | LA070URD30KI0500 | LA070URD30TTI0500 |
| 550 | 700 | 52 | 330 | 80/90 | LA070URD30LI0550 | LA070URD30KI0550 | LA070URD30TTI0550 | |
| 31 | 200 | 700 | 2.5 | 14.6 | 45 | LA070URD31LI0200 | LA070URD31KI0200 | LA070URD31TTI0200 |
| | 250 | 700 | 4.7 | 27 | 52 | LA070URD31LI0250 | LA070URD31KI0250 | LA070URD31TTI0250 |
| | 315 | 700 | 7.5 | 43 | 65 | LA070URD31LI0315 | LA070URD31KI0315 | LA070URD31TTI0315 |
| | 350 | 700 | 10.5 | 59 | 67 | LA070URD31LI0350 | LA070URD31KI0350 | LA070URD31TTI0350 |
| | 400 | 700 | 19 | 110 | 68 | LA070URD31LI0400 | LA070URD31KI0400 | LA070URD31TTI0400 |
| | 450 | 700 | 26.5 | 150 | 70 | LA070URD31LI0450 | LA070URD31KI0450 | LA070URD31TTI0450 |
| | 500 | 700 | 37 | 210 | 70/72 | LA070URD31LI0500 | LA070URD31KI0500 | LA070URD31TTI0500 |
| | 550 | 700 | 52 | 300 | 70/75 | LA070URD31LI0550 | LA070URD31KI0550 | LA070URD31TTI0550 |
| | 630 | 700 | 75 | 421 | 75/85 | LA070URD31LI0630 | LA070URD31KI0630 | LA070URD31TTI0630 |
| 700 | 700 | 95 | 530 | 85/95 | LA070URD31LI0700 | LA070URD31KI0700 | LA070URD31TTI0700 | |
| 800 | 700 | 140 | 880 | 105/120 | LA070URD31LI0800 | LA070URD31KI0800 | LA070URD31TTI0800 | |
| 32 | 400 | 700 | 15 | 86 | 72/75 | LA070URD32LI0400 | LA070URD32KI0400 | LA070URD32TTI0400 |
| | 450 | 700 | 22 | 124 | 77/80 | LA070URD32LI0450 | LA070URD32KI0450 | LA070URD32TTI0450 |
| | 500 | 700 | 28 | 157 | 85/90 | LA070URD32LI0500 | LA070URD32KI0500 | LA070URD32TTI0500 |
| | 550 | 700 | 37 | 211 | 90/95 | LA070URD32LI0550 | LA070URD32KI0550 | LA070URD32TTI0550 |
| | 630 | 700 | 54 | 302 | 95/105 | LA070URD32LI0630 | LA070URD32KI0630 | LA070URD32TTI0630 |
| | 700 | 700 | 76 | 432 | 100/110 | LA070URD32LI0700 | LA070URD32KI0700 | LA070URD32TTI0700 |
| | 800 | 700 | 115 | 648 | 110/120 | LA070URD32LI0800 | LA070URD32KI0800 | LA070URD32TTI0800 |
| | 900 | 700 | 170 | 972 | 110/125 | LA070URD32LI0900 | LA070URD32KI0900 | LA070URD32TTI0900 |
| | 1000 | 700 | 240 | 1350 | 115/135 | LA070URD32LI1000 | LA070URD32KI1000 | LA070URD32TTI1000 |
| | 1100 | 650 | 270 | 1620 | 140/165 | LA065URD32LI1100 | — | LA065URD32TTI1100 |
| | 1250 | 600 | 410 | 2100 | 150/180 | LA060URD32LI1250 | — | LA060URD32TTI1250 |
| | 1400 | 550 | 555 | 2600 | 160/190 | LA055URD32LI1400 | — | LA055URD32TTI1400 |
| 1600 | 550 | 870 | 4000 | 165/195 | LA055URD32LI1600 | — | LA055URD32TTI1600 | |
| 1800 | 500 | 1050 | 4400 | 195/330 | LA050URD32LI1800 | — | LA050URD32TTI1800 | |
| 33 | 500 | 700 | 19 | 108 | 105 | LA070URD33LI0500 | LA070URD33KI0500 | LA070URD33TTI0500 |
| | 550 | 700 | 27 | 151 | 105/110 | LA070URD33LI0550 | LA070URD33KI0550 | LA070URD33TTI0550 |
| | 630 | 700 | 40 | 227 | 110/120 | LA070URD33LI0630 | LA070URD33KI0630 | LA070URD33TTI0630 |
| | 700 | 700 | 55 | 324 | 115/125 | LA070URD33LI0700 | LA070URD33KI0700 | LA070URD33TTI0700 |
| | 800 | 700 | 95 | 529 | 120/130 | LA070URD33LI0800 | LA070URD33KI0800 | LA070URD33TTI0800 |
| | 900 | 700 | 135 | 760 | 120/135 | LA070URD33LI0900 | LA070URD33KI0900 | LA070URD33TTI0900 |
| | 1000 | 700 | 170 | 970 | 135/155 | LA070URD33LI1000 | LA070URD33KI1000 | LA070URD33TTI1000 |
| | 1100 | 700 | 240 | 1360 | 135/160 | LA070URD33LI1100 | LA070URD33KI1100 | LA070URD33TTI1100 |
| | 1250 | 700 | 350 | 2000 | 150/180 | LA070URD33LI1250 | LA070URD33KI1250 | LA070URD33TTI1250 |
| | 1400 | 700 | 480 | 2700 | 160/200 | LA070URD33LI1400 | LA070URD33KI1400 | LA070URD33TTI1400 |
| | 1600 | 650 | 555 | 3250 | 210/240 | LA065URD33LI1600 | — | LA065URD33TTI1600 |
| | 1800 | 650 | 720 | 4330 | 225/260 | LA065URD33LI1800 | — | LA065URD33TTI1800 |
| | 2000 | 600 | 950 | 5000 | 250/290 | LA060URD33LI2000 | — | LA060URD33TTI2000 |
| | 2250 | 550 | 1250 | 5900 | 280/330 | LA055URD33LI2250 | — | LA055URD33TTI2250 |
| | 2500 | 500 | 1870 | 7600 | 280/330 | LA050URD33LI2500 | — | LA050URD33TTI2500 |

*Watts loss data is published for both blade and tapped style mounting configurations. When two watts loss values are shown, this represents tapped/blade values respectively. Contact Littelfuse for characteristic curves.

SQUARE BODY SEMICONDUCTOR FUSES

700/1300 VAC • Very Fast-Acting • 63-2500 A

TYPES KI AND LI

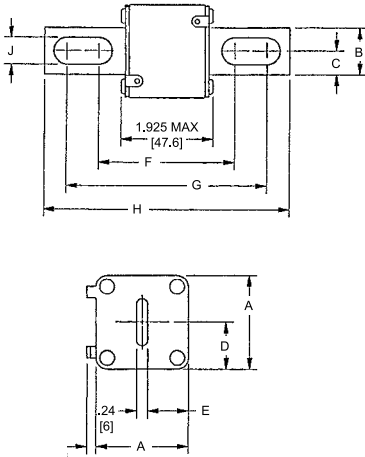

North American Straight Blade, Type KI

Dimensions

Dimensions for reference only.

| CATALOG NUMBER | DIMENSIONS INCHES (mm) | | | | | | | | |
|-------------------------|------------------------|--------------|----------------|----------------|----------------|----------------|-----------------|-----------------|----------------|
| | A | B | C | D | E | F | G | H | J |
| LA070URD30KI (63-550) | 1.57 (40) | 0.98 (25) | 0.49 (12.5) | 0.83 (21) | 0.71 (18) | 2.68 (68) | 4.21 (107) | 5.08 (129) | 0.41 (10.5) |
| LA070URD31KI (200-800) | 2.01 (51) | 0.98 (25) | 0.49 (12.5) | 1.0 (25.5) | 0.89 (22.5) | 2.66 (67.6) | 4.22 (107.1) | 5.07 (128.8) | 0.56 (14.3) |
| LA070URD32KI (400-1000) | 2.36 (60) | 1.26 (32) | 0.63 (16) | 1.18 (30) | 1.06 (27) | 2.92 (74.2) | 4.29 (109) | 5.28 (134) | 0.57 (14.6) |
| LA070URD33KI (500-1400) | 2.93 (74.5) | 1.57 (40) | 0.79 (20) | 1.46 (37.2) | 1.35 (34.2) | 2.97 (75.4) | 4.24 (107.6) | 5.28 (134) | 0.63 (15.9) |

North American Straight Blade, Type LI

Dimensions

Dimensions for reference only.

| CATALOG NUMBER | DIMENSIONS INCHES (mm) | | | | | | | | |
|--------------------------|------------------------|--------------|----------------|----------------|----------------|----------------|-----------------|-----------------|----------------|
| | A | B | C | D | E | F | G | H | J |
| LA070URD30LI (63-550) | 1.57 (40) | 0.98 (25) | 0.49 (12.5) | 0.83 (21) | 0.71 (18) | 3.45 (87.6) | 4.98 (126.6) | 5.85 (148.6) | 0.41 (10.5) |
| LA070URD31LI (200-800) | 2.01 (51) | 0.98 (25) | 0.49 (12.5) | 1.0 (25.5) | 0.89 (22.5) | 3.61 (91.6) | 4.82 (122.4) | 5.85 (148.6) | 0.57 (14.6) |
| LA070URD32LI (400-1000) | 2.36 (60) | 1.26 (32) | 0.63 (16) | 1.18 (30) | 1.06 (27) | 3.71 (94.2) | 5.08 (129) | 6.02 (153) | 0.57 (14.6) |
| LA065URD32LI (1250) | | | | | | | | | |
| LA055URD32LI (1400-1600) | | | | | | | | | |
| LA050URD32LI (1800) | | | | | | | | | |
| LA070URD33LI (500-1400) | 2.93 (74.5) | 1.57 (40) | 0.79 (20) | 1.46 (37.2) | 1.35 (34.2) | 3.72 (94.4) | 4.98 (126.6) | 6.02 (153) | 0.63 (15.9) |
| LA065URD33LI (1600-1800) | | | | | | | | | |
| LA060URD33LI (2000) | | | | | | | | | |
| LA055URD33LI (2250) | | | | | | | | | |
| LA050URD33LI (2500) | | | | | | | | | |

TYPE TTI

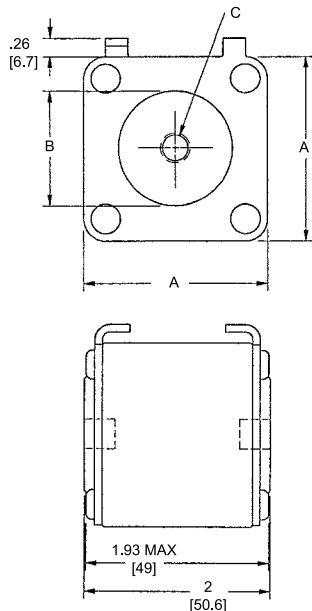

North American Flat Single Hole, Type TTI

Dimensions

Dimensions for reference only.

| CATALOG NUMBER | DIMENSIONS INCHES (mm) | | |
|---------------------------|------------------------|----------------|----------------|
| | A | B | C |
| LA070URD30TTI (100-550) | 1.57 (40) | 1.00 (25) | 5/16-18 x 0.35 |
| LA070URD31TTI (200-800) | 2.00 (50.8) | 1.19 (30.2) | 5/16-18 x 0.35 |
| LA070URD32TTI (400-1000) | 2.37 (60.3) | 1.50 (38.1) | 3/8-16 x 0.35 |
| LA065URD32TTI (1100) | | | |
| LA060URD32TTI (1250) | | | |
| LA055URD32TTI (1400-1600) | | | |
| LA060URD33TTI (1800) | | | |
| LA070URD33TTI (500-1400) | 2.94 (74.5) | 1.81 (46) | 1/2-18 x 0.35 |
| LA065URD33TTI (1600) | | | |
| LA060URD33TTI (2000) | | | |
| LA055URD33TTI (2250) | | | |
| LA050URD33TTI (2500) | | | |

SQUARE BODY SEMICONDUCTOR FUSES

700/1300 VAC • Very Fast-Acting • 63-2500 A

| BODY SIZE | AMPERE RATING | RATED VOLTAGE | MELTING I ² T (A ² S X 10 ³) | TOTAL I ² T @ RATED VOLTAGE (A ² S X 10 ³) | *WATTS LOSS @ RATED CURRENT (W) | LONG BLADE CATALOG NUMBER TYPE LI/LLI | TAPPED TERMINAL CATALOG NUMBER TYPE TTI |
|-----------|---------------|---------------|--|--|---------------------------------|---------------------------------------|---|
| 70 | 63 | 1300 | 0.21 | 1.8 | 26 | LA130URD70LI0063 | LA130URD70TTI0063 |
| | 80 | 1300 | 0.47 | 4 | 27 | LA130URD70LI0080 | LA130URD70TTI0080 |
| | 100 | 1300 | 0.83 | 7.2 | 30 | LA130URD70LI0100 | LA130URD70TTI0100 |
| | 125 | 1300 | 1.3 | 11 | 38 | LA130URD70LI0125 | LA130URD70TTI0125 |
| | 160 | 1300 | 2.5 | 22 | 45 | LA130URD70LI0160 | LA130URD70TTI0160 |
| | 200 | 1300 | 4.7 | 40 | 54/56 | LA130URD70LI0200 | LA130URD70TTI0200 |
| | 250 | 1300 | 9.6 | 82 | 58/61 | LA130URD70LI0250 | LA130URD70TTI0250 |
| | 315 | 1300 | 20 | 172 | 66/72 | LA130URD70LI0315 | LA130URD70TTI0315 |
| | 350 | 1200 | 28 | 205 | 68/75 | LA120URD70LI0350 | LA120URD70TTI0350 |
| 71 | 160 | 1300 | 2.6 | 22 | 46 | LA130URD71LLI0160 | LA130URD71TTI0160 |
| | 200 | 1300 | 4.7 | 40 | 54 | LA130URD71LLI0200 | LA130URD71TTI0200 |
| | 250 | 1300 | 8.9 | 76 | 61 | LA130URD71LLI0250 | LA130URD71TTI0250 |
| | 280 | 1300 | 12 | 102 | 68/70 | LA130URD71LI0280 | LA130URD71TTI0280 |
| | 315 | 1300 | 16 | 138 | 73/76 | LA130URD71LLI0315 | LA130URD71TTI0315 |
| | 350 | 1300 | 22 | 190 | 76/80 | LA130URD71LLI0350 | LA130URD71TTI0350 |
| | 400 | 1300 | 38 | 330 | 76/80 | LA130URD71LLI0400 | LA130URD71TTI0400 |
| | 450 | 1300 | 47 | 405 | 87/95 | LA130URD71LLI0450 | LA130URD71TTI0450 |
| | 500 | 1200 | 68 | 500 | 90/100 | LA120URD71LLI0500 | LA120URD71TTI0500 |
| | 550 | 1200 | 84 | 620 | 98/112 | LA120URD71LLI0550 | LA120URD71TTI0550 |
| | 630 | 1100 | 125 | 930 | 105 | LA110URD71LLI0630 | - |
| 630 | 1200 | 125 | 930 | 120 | - | LA120URD71TTI0630 | |
| 72 | 280 | 1300 | 10 | 90 | 72 | LA130URD72LI0280 | LA130URD72TTI0280 |
| | 315 | 1300 | 15 | 130 | 76 | LA130URD72LI0315 | LA130URD72TTI0315 |
| | 350 | 1300 | 21 | 180 | 77 | LA130URD72LI0350 | LA130URD72TTI0350 |
| | 400 | 1300 | 32 | 285 | 80 | LA130URD72LI0400 | LA130URD72TTI0400 |
| | 450 | 1300 | 44 | 380 | 87/89 | LA130URD72LI0450 | LA130URD72TTI0450 |
| | 500 | 1300 | 57 | 500 | 94/98 | LA130URD72LI0500 | LA130URD72TTI0500 |
| | 550 | 1300 | 68 | 590 | 110/120 | LA130URD72LI0550 | LA130URD72TTI0550 |
| | 630 | 1200 | 105 | 920 | 113 | LA120URD72LI0630 | - |
| | 630 | 1300 | 105 | 920 | 125 | - | LA130URD72TTI0630 |
| | 700 | 1100 | 145 | 1040 | 122 | LA110URD72LI0700 | - |
| | 700 | 1200 | 145 | 1040 | 140 | - | LA120URD72TTI0700 |
| | 800 | 1100 | 215 | 1590 | 125 | LA110URD72LI0800 | - |
| | 800 | 1200 | 215 | 1590 | 146 | - | LA120URD72TTI0800 |
| 73 | 315 | 1300 | 12 | 102 | 84 | LA130URD73LI0315 | LA130URD73TTI0315 |
| | 350 | 1300 | 17 | 150 | 86 | LA130URD73LI0350 | LA130URD73TTI0350 |
| | 400 | 1300 | 25 | 220 | 93 | LA130URD73LI0400 | LA130URD73TTI0400 |
| | 450 | 1300 | 35 | 310 | 99/100 | LA130URD73LI0450 | LA130URD73TTI0450 |
| | 500 | 1300 | 44 | 390 | 110/112 | LA130URD73LI0500 | LA130URD73TTI0500 |
| | 550 | 1300 | 57 | 500 | 116/120 | LA130URD73LI0550 | LA130URD73TTI0550 |
| | 630 | 1300 | 84 | 730 | 125/132 | LA130URD73LI0630 | LA130URD73TTI0630 |
| | 700 | 1300 | 110 | 960 | 135/146 | LA130URD73LI0700 | LA130URD73TTI0700 |
| | 800 | 1200 | 190 | 1630 | 136 | LA120URD73LI0800 | - |
| | 800 | 1300 | 190 | 1630 | 148 | - | LA130URD73TTI0800 |
| | 900 | 1100 | 250 | 2160 | 150 | LA110URD73LI0900 | - |
| | 900 | 1000 | 250 | 2160 | 170 | - | LA100URD73TTI0900 |
| | 1000 | 1000 | 370 | 2430 | 152/174 | LA100URD73LI1000 | LA100URD73TTI1000 |
| | 1100 | 1000 | 445 | 2580 | 168/208 | LA100URD73LI1100 | LA100URD73TTI1100 |
| | 1250 | 1000 | 585 | 3480 | 186/200 | LA100URD73LI1250 | LA100URD73TTI1250 |
| | 1400 | 900 | 755 | 3880 | 210/228 | LA090URD73LI1400 | LA090URD73TTI1400 |
| 1600 | 700 | 1430 | 5630 | 203 | LA070URD73LI1600 | LA070URD73TTI1600 | |
| 1800 | 660 | 2040 | 7600 | 206 | LA065URD73LI1800 | LA065URD73TTI1800 | |

*Watts loss data is published for both blade and tapped style mounting configurations. When two watts loss values are shown, this represents tapped/blade values respectively. Contact Littelfuse for characteristic curves.

SQUARE BODY SEMICONDUCTOR FUSES

700/1300 VAC • Very Fast-Acting • 63-2500 A

TYPES LI AND LLI

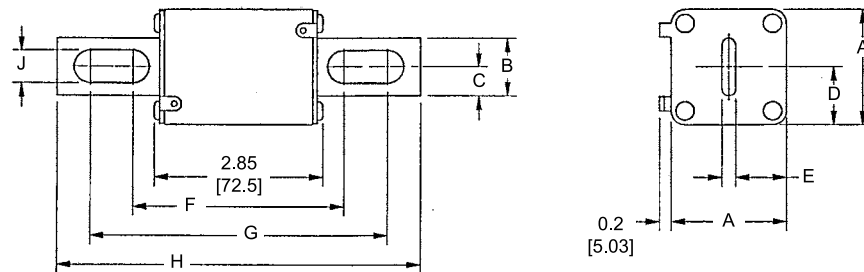

North American Straight Blade, Types LI and LLI

Dimensions

Dimensions for reference only.

| CATALOG NUMBER | DIMENSIONS INCHES (mm) | | | | | | | | |
|--|------------------------|--------------|----------------|----------------|----------------|----------------|-----------------|-----------------|----------------|
| | A | B | C | D | E | F | G | H | J |
| LA130URD70LI (63-315) LA120URD70LI (350) | 1.57 (40) | 0.98 (25) | 0.49 (12.5) | 0.83 (21) | 0.71 (18) | 3.60 (91.4) | 5.13 (130.4) | 6.00 (152.4) | 0.41 (10.5) |
| LA130URD71LLI (160-450) LA120URD71LLI (500-550) LA110URD71LLI (630) | 2.01 (51) | 0.98 (25) | 0.49 (12.5) | 1.0 (26.5) | 0.89 (22.5) | 3.60 (91.4) | 5.13 (130.4) | 6.00 (152.4) | 0.57 (14.6) |
| LA130URD72LI (280-550) LA120URD72LI (800) LA110URD72LI (700-800) | 2.36 (60) | 1.26 (32) | 0.63 (16) | 1.18 (30) | 1.06 (27) | 3.84 (97.6) | 5.2 (132.4) | 6.20 (157.4) | 0.57 (14.6) |
| LA130URD73LI (315-700) LA120URD73LI (800) LA110URD73LI (900-1000) LA090URD73LI (1400) LA070URD73LI (1600) LA065URD73LI (1800) | 2.93 (74.5) | 1.57 (40) | 0.79 (20) | 1.46 (37.2) | 1.35 (34.2) | 3.89 (98.8) | 5.21 (132.4) | 6.20 (157.4) | 0.63 (15.9) |

Semiconductor Fuses 5

North American Flat Single Hole, Type TTI

Dimensions

TYPE TTI

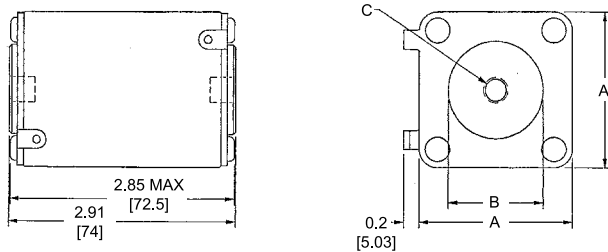

| CATALOG NUMBER | DIMENSIONS INCHES (mm) | | |
|---|------------------------|----------------|-------------------|
| | A | B | C |
| LA130URD70TTI (63-315) LA120URD70TTI (350) | 1.57 (40) | 1.00 (26.4) | 5/16-18 x 0.23 DP |
| LA130URD71TTI (160-450) LA120URD71TTI (550-630) | 2.01 (51) | 1.19 (30.2) | 5/16-18 x 0.36 DP |
| LA130URD72TTI (280-630) LA120URD72TTI (700-800) | 2.36 (60) | 1.50 (38.1) | 3/8-18 x 0.36 DP |
| LA130URD73TTI (315-900) LA120URD73TTI (1000) LA110URD73TTI (1250) LA090URD73TTI (1400) LA070URD73TTI (1600) LA065URD73TTI (1800) | 2.93 (74.5) | 1.81 (46) | 1/2-18 x 0.36 DP |

Dimensions for reference only.

OEM CUSTOM PRODUCTS

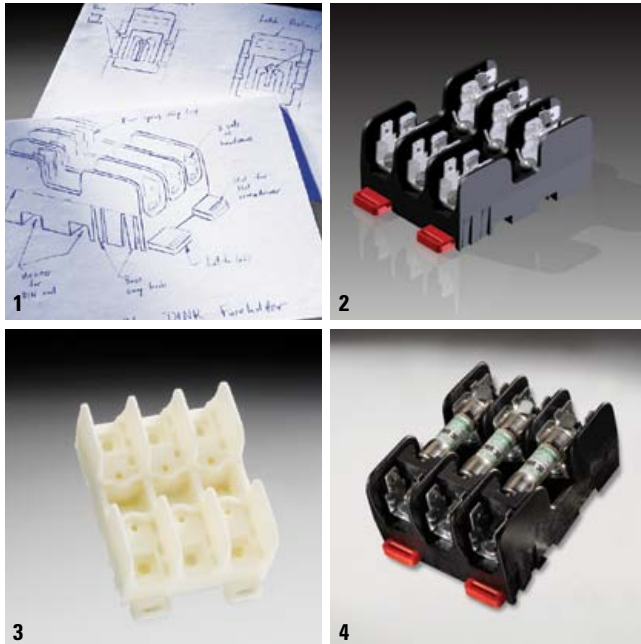

To speak with a sales associate regarding your application needs, call 800-TEC-FUSE (800-382-3873) or email techline@littelfuse.com.

Examples



Two-Pole Combination Block

Save space and money by combining multiple components in one unit. Littelfuse collaborated with the customer to develop a cost effective UL listed component that combined a 600 Volt 100A two-pole Class T fuse block with a two-openings-per-pole splicer block.

Description

We understand that existing solutions don't always solve your current problems. Building on more than 80 years of circuit protection experience, the Littelfuse engineering team collaborates with customers to develop customized solutions for applications such as solar panels, HVAC systems, lift trucks, lighting fixtures, industrial restaurant equipment and power converters.

Process

The custom product design process begins with a situation analysis from our experienced engineers followed by our 4-step collaborative product development process.

1. Initial concept sketch created
2. CAD drawings to formalize the product description
3. 3D solid prototype to verify design
4. Final production parts that meet your design needs and specifications

Additional Customized Products

HAZGARD Fork Lift Fuse 62

Web Resources

To view examples of Littelfuse's custom solutions, visit: www.littelfuse.com/industrialoem and to see additional examples of Littelfuse's products solutions, visit: www.littelfuse.com/custom



Custom-Leaded Fuse

Save space and reduce cost by eliminating the fuse block component. Littelfuse designed a series of custom through-hole PC-board mountable KLKD Midget fuses for a consumer application where reduced cost was more important than replaceability.

Section Overview

Littelfuse® offers a wide variety of dead-front and open-face fuse blocks, in addition to a variety of accessories, distribution/splicer blocks and in-line holders.



BLOCKS AND HOLDERS

Table of Contents

| | |
|---|-----|
| LF Series Fuse Blocks Overview | 81 |
| Class J Fuse Blocks..... | 83 |
| Class H/K5 and R Fuse Blocks | 86 |
| Class T Fuse Blocks | 92 |
| Class G Fuse Blocks..... | 97 |
| Class CC/CD and Midget Fuse Blocks | 99 |
| LF Series Fuse Block Covers | 103 |
| LFJ Solar Rated Fuse Block..... | 104 |
| Dead Front Fuse Holders | 107 |
| Miscellaneous Fuse Blocks and Holders | 114 |
| Semiconductor Fuse Blocks..... | 120 |
| Distribution and Splicer Blocks | 122 |
| In-Line Fuse Holders | 131 |

FUSE BLOCKS OVERVIEW



Description

Littelfuse offers a comprehensive line of fuse blocks that incorporate many benefits such as indication, snap to-release, DIN-Rail mounting and universal mounting holes.

New Options Available

- Reduced Footprint—Save space with designs up to 35% smaller in width
- Indication—Increase safety and reduce downtime with built-in local neon indication
- Universal Mounting Holes—Simplify replacement with universal mounting options
- DIN Rail Mountable—Ease installation with a 35 mm hat DIN Rail mounting option
- One-Hand Release—Save time by using only one hand for a simple release from DIN Rail

Fuse Block Selection

The following guidelines should help simplify the selection of proper fuse blocks:

- 1. Determine the system voltage**—Since fuses are selected on the basis of system voltage, fuse blocks are selected to match the voltage rating of the fuse.
- 2. Determine the design short-circuit current**—If available short-circuit current cannot be determined, or if it will vary with equipment location, select fuses with a 200,000 ampere interrupting rating (A.I.R.) and mating fuse blocks with a withstand rating of 200,000 amperes for maximum safety.
- 3. Determine the type and ampere rating of the fuse to be used**—The fuse ampere rating, opening characteristics (fast acting or time-delay) and size are important considerations in fuse selection. Fuse blocks may be used with a fuse rated at the corresponding ampere rating or below. For example, a fuse block rated at 30 amperes may be used with a fuse rated from 0 to 30 amperes.
- 4. Determine if NEC®, CSA, UL, or other requirements are applicable**—Any of these requirements should be obtained from the approving agency in advance of fuse and fuse block selection.

5. Select the type of wire termination

Three types of wire termination are available:

- Screw*—for use with spade lugs or ring terminals
- Screw with Pressure Plate*—for use with solid or stranded wire without terminal. Recommended where vibration will be a factor
- Box Lug—for use with all types of solid wire and Class B and Class C stranded wire. The most durable, but not for use with welding cable or other rope-stranded conductors.

*1/4" Quick Connect terminals rated for up to 20 amperes are available on the Midget and Class CC fuse blocks.

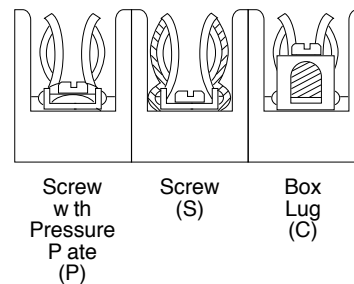

6. Decide on the number of poles in each block—The number of poles for each set of fuses is determined by the characteristics of the circuit.

7. Determine if block should be DIN Rail mounted—Many of the new Littelfuse fuse blocks are DIN Rail mountable. Be sure to look to corresponding ordering tables to match the correct part number on the following product pages.

8. Determine if fuse clips need to be reinforced
Fuse clips may have a tendency to lose some of their tension over a period of time. This may be prevented by specifying reinforced fuse clips.

Ordering Information

The Littelfuse fuse block part number consists of the below skeleton. Please refer to UL Class Tables for specific information.

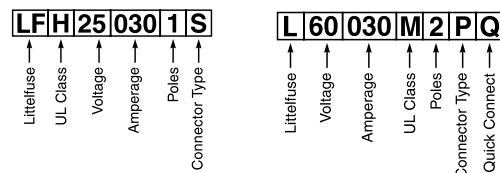

†For all Class R, H, J, and T Fuse blocks

For all Class CC, G, and Midget-Style

†These new fuse blocks replace previous Littelfuse fuse blocks that had very similar part numbers for customer convenience. The only change is an "F" has been added as the second character in the new block part numbers.

Caution: Littelfuse indicating fuse holders are intended to quickly identify open fuses while power is still applied. Only qualified electrically trained technicians should replace fuses and follow standard OSHA and NFPA 70E safe work practices, such as Lock-Out and Tag-Out procedures and verification before replacing any fuses in indicating fuse holders.

LF SERIES INDICATING FUSE BLOCKS

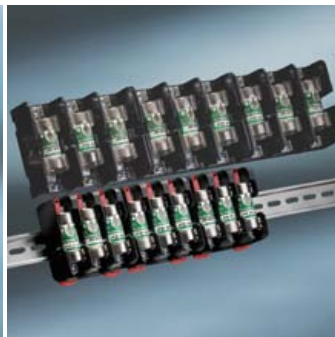

**Smaller Footprint
Provides Space Savings**



**DIN-Rail Mounting
Eases Installation**



**Indication Improves
Functionality**

An Indication of Value

The Littelfuse LF Series Fuse Blocks and Covers offer generous space savings and a greater value over previous generations. View the different series classes for available indication, snap-to-release DIN rail mounting, universal mounting holes and touch-safe covers.

LF SERIES CLASS J FUSE BLOCKS

600 V



Description

The Littelfuse 600 V Class J blocks offer generous space savings and enhanced value over previous generations, such as indication, snap-to-release DIN rail mounting and universal mounting holes.

Features/Benefits

- Space-saving design—up to 45% smaller than existing blocks
- Universal mounting holes for easy replacement
- Indication offered on all versions except 200–600 A
- One hand release from DIN rail for ferrule style fuses
- Reinforced fuse clips are standard on all Class J blocks
- Covers available for 100 A and lower to enhance safety

Specifications

| | |
|----------------------------|--|
| Voltage Ratings | 600 V |
| Ampere Ratings | 0 – 600 A |
| Leakage Current | <0.6 mA at 600 V |
| Flammability Rating | UL94 V-0 |
| Approvals | UL Listed: File No. E14721 CSA Certified: File No. LR7316 RoHS Compliant, Lead (Pb) Free |
| Environmental | |

Recommended Fuses

| | |
|-------------------|----|
| Time Delay | |
| Series: JTD_ID | 23 |
| Series: JTD | 23 |

| | |
|--------------------|----|
| Fast Acting | |
| Series: JLS | 24 |

For information about Touch-Safe Class J fuse holders:
www.littelfuse.com/lpsj

Web Resources

Sample requests, downloadable CAD drawings, fuse block cover datasheet and other technical information:
www.littelfuse.com/fuseblocks
www.littelfuse.com/lfj

Ordering Information (Class J 600 V)

| AMP RATING | POLES | ORDERING NUMBER | | | | TORQUE | TERMINAL | WIRE RANGE | WIRE TYPE | BASE TEMP RATING | DIN RAIL MOUNT | INDICATION | COVER ORDERING NUMBER* |
|------------|-------|------------------|---------|----------------|-------|-----------------------|-------------------|------------|-----------|------------------|----------------|------------|------------------------|
| | | BASE PART NUMBER | SUFFIX | | | | | | | | | | |
| | | | BOX LUG | PRESSURE PLATE | SCREW | | | | | | | | |
| 30 | 1 | LFJ600301 | CID | PID | SID | 2.8 N-m (25 in-lbs) | C | 6-14 AWG | CU Only | 125°C | • | • | LFJ60030FBC |
| | 2 | LFJ600302 | CID | PID | SID | | P | 10-14 AWG | | | | | |
| | 3 | LFJ600303 | CID | PID | SID | | S | 10-22 AWG | | | | | |
| 60 | 1 | LFJ600601 | CID | — | — | 5.6 N-m (50 in-lbs) | 2-4 AWG | | CU-AL | 125°C | • | • | LFJ60060FBC |
| | 2 | LFJ600602 | CID | — | — | 2.8 N-m (25 in-lbs) | 6-14 AWG | | | | | | |
| | 3 | LFJ600603 | CID | — | — | | | | | | | | |
| 100 | 1 | LFJ601001 | CID | — | — | 13.6 N-m (120 in-lbs) | 2/0-6 AWG | | CU-AL | 130°C | — | • | LFJ60100FBC |
| | 3 | LFJ601003 | CID | — | — | 4.5 N-m (40 in-lbs) | 8 AWG | | | | | | |
| | | | | | | 4.0 N-m (35 in-lbs) | 10-14 AWG | | | | | | |
| 200 | 1 | LFJ602001 | C | — | — | 31.1 N-m (275 in-lbs) | 250 kcmil-6 | | CU-AL | 130°C | — | — | — |
| | 3 | LFJ602003 | C | — | — | | | | | | | | |
| 400 | 1 | LFJ604001 | C | — | — | 31.1 N-m (275 in-lbs) | (2) 350 kcmil-1/0 | | CU-AL | 130°C | — | — | — |
| | 3 | LFJ604003 | C | — | — | | | | | | | | |
| 600 | 1 | LFJ606001 | C | — | — | 42.4 N-m (375 in-lbs) | (2) 500 kcmil-4 | | CU-AL | 130°C | — | — | — |
| | 3 | LFJ606003 | C | — | — | | | | | | | | |

Note: Reinforcing springs standard on all Class J fuse blocks.
*Covers sold individually. One cover needed for each pole.

CLASS J FUSE BLOCK DIMENSIONS

Dimensions mm (inches)

600 V 30 A

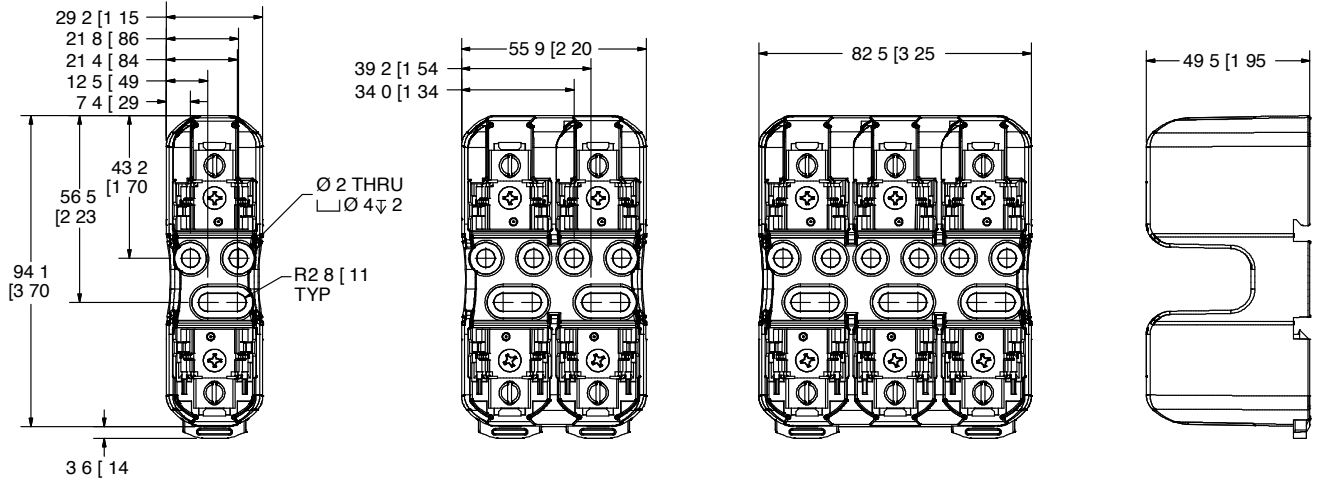

600 V 60 A

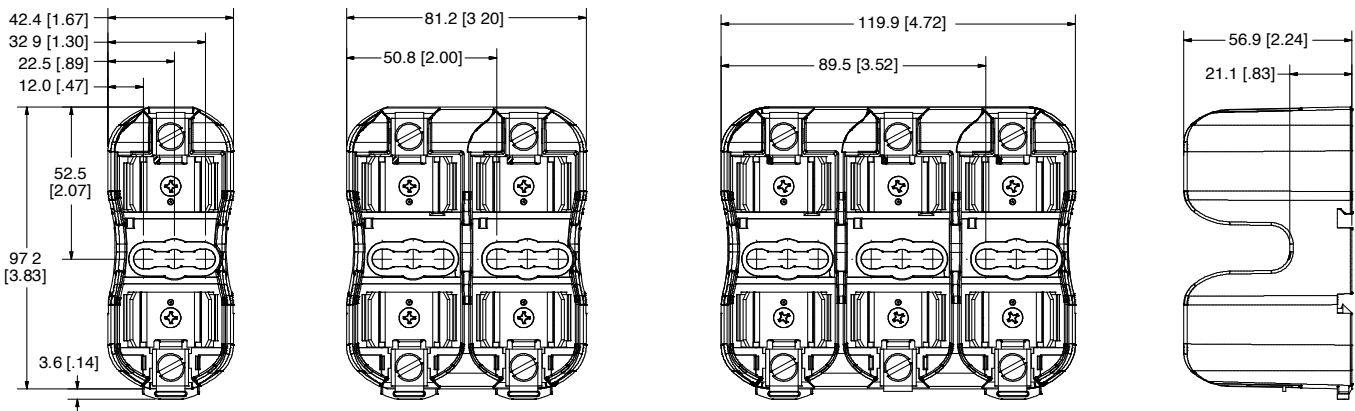

600 V 100 A

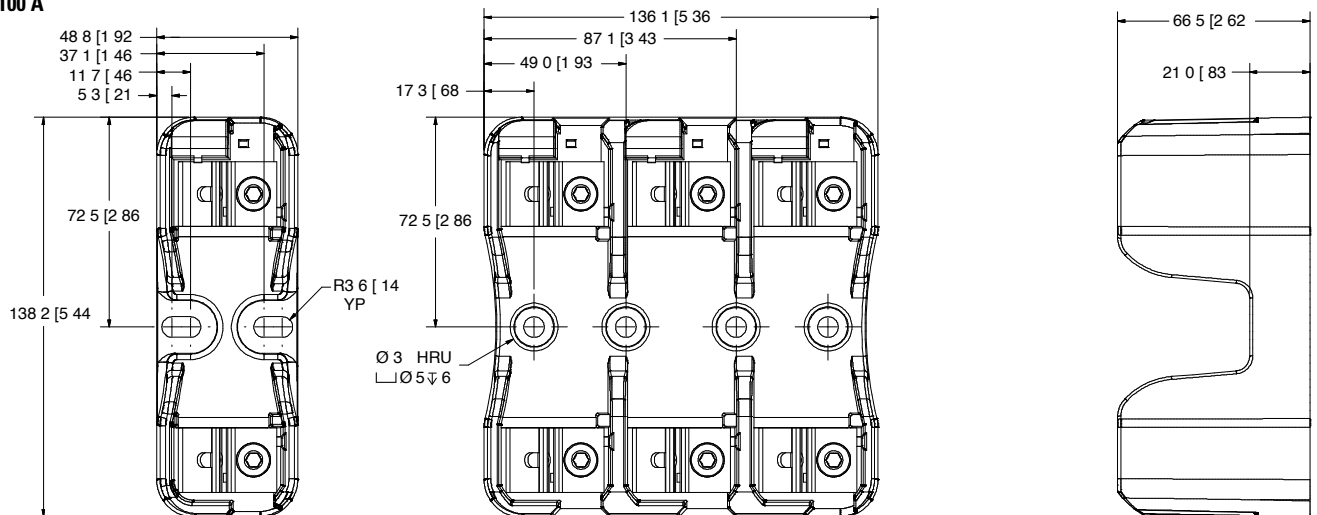

CLASS J FUSE BLOCK DIMENSIONS

Dimensions mm (inches)

600 V 200 A

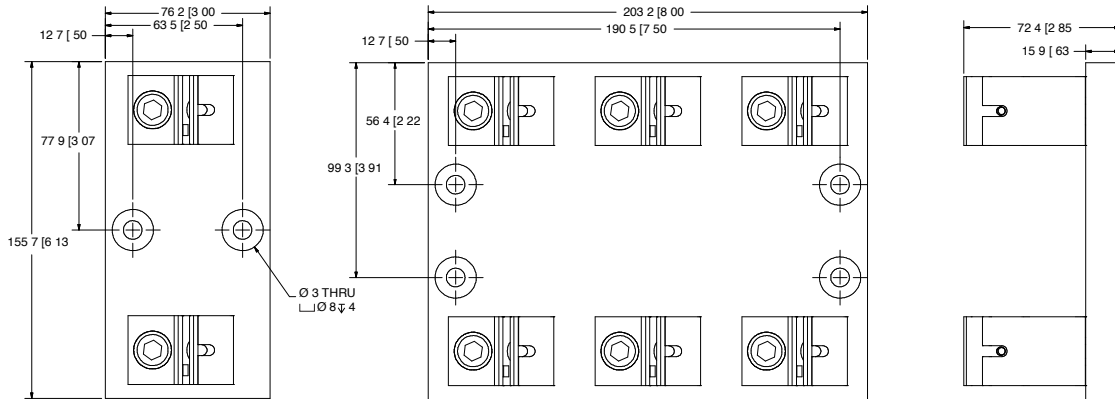

600 V 400 A

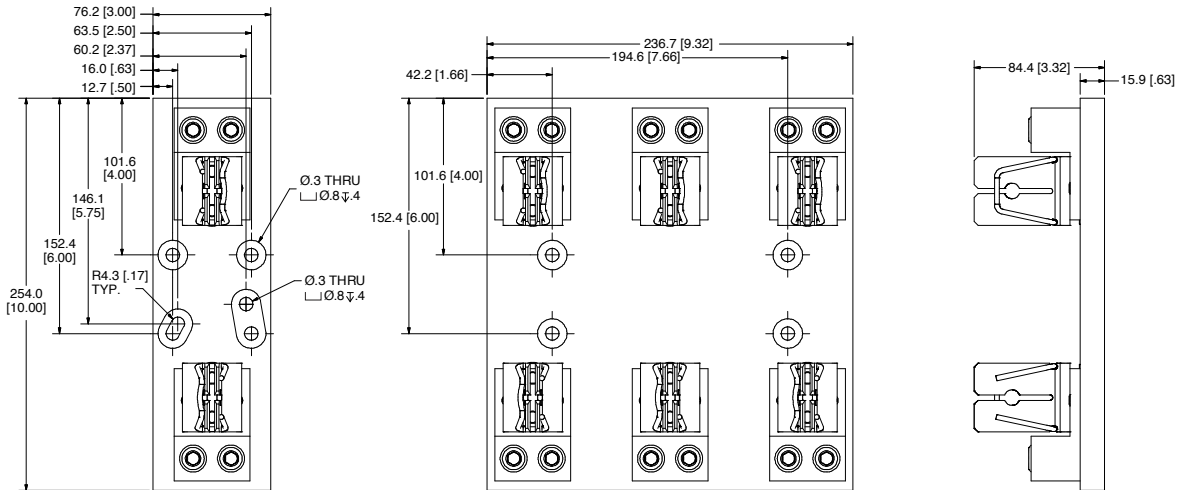

600 V 600 A

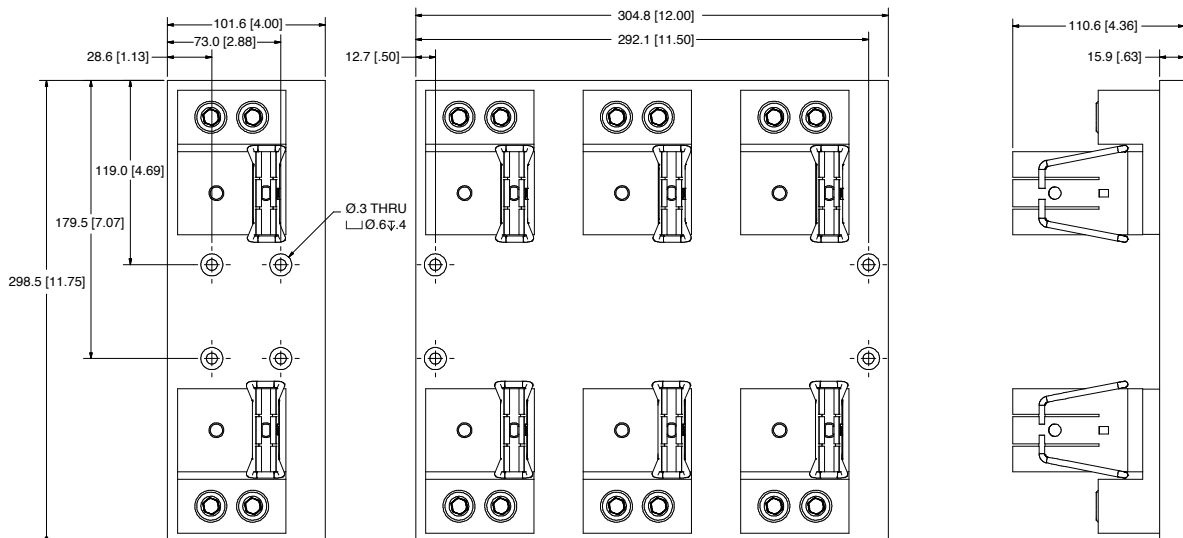

LF SERIES CLASS H/K5 AND R FUSE BLOCKS

250 V • 600 V



Description

The Littelfuse Class H/K5 and R blocks offer many benefits such as indication, snap-to-release DIN rail mounting and universal mounting holes. Class H and Class R fuse blocks are dimensionally the same, but Class R blocks incorporate a rejection feature, which only allows Class R fuses to be inserted.

Features/Benefits

- Universal mounting holes for easy replacement
- Indication offered on most 250 V and 600 V versions
- One hand release from DIN rail for ferrule style fuses
- Reinforced fuse clips are standard on all Class H and Class R fuse blocks
- Covers available for 100 A and lower to enhance safety

Web Resources

Sample requests, downloadable CAD drawings and other technical information: www.littelfuse.com/lfh
www.littelfuse.com/lfr
www.littelfuse.com/fuseblocks

Specifications

| | |
|----------------------------|--|
| Voltage Rating | 250 V, 600 V |
| Ampere Ratings | 0-600 A |
| Leakage Current | <0.6 mA at 600 V |
| Withstand Rating | Class H: 10 kA RMS SYM Class R: 200 kA RMS SYM |
| Flammability Rating | UL94 V-0 |
| Approvals | UL Listed (File No. E14721) CSA Certified (File No. LR7316) |
| Environmental | RoHS Compliant, Lead (Pb) Free |

Recommended Fuses

Class H/K5 Blocks – 250 V

| | |
|-----------|----|
| NLN | 21 |
| RLN | 22 |

Class R Blocks – 250 V

| | |
|--------------------|----|
| FLNR/FLNR_ID | 18 |
| KLNR | 15 |
| LLNRK | 14 |

Class H/K5 Blocks – 600 V

| | |
|-----------|----|
| NLS | 21 |
| RLS | 22 |

Class R Blocks – 600 V

| | |
|----------------------|----|
| FLSR/FLSR_ID | 18 |
| KLSR | 15 |
| LLSRK/LLSRK_ID | 14 |
| IDSR | 17 |

Ordering Information (Class H 250 V)

| AMP RATING | POLES | ORDERING NUMBER | | | TORQUE | TERMINAL | WIRE RANGE | WIRE TYPE | BASE TEMP RATING | DIN RAIL | INDICATION | COVER ORDERING NUMBER* |
|------------|-------|------------------|---------|----------------|--------|---|-------------------|-----------|------------------|----------|-------------|------------------------|
| | | BASE PART NUMBER | BOX LUG | PRESSURE PLATE | | | | | | | | |
| 30 | 1 | LFH250301 | C | P | S | 2.8 N-m (25 in-lbs) | C | 6-14 AWG | CU Only | • | — | LFH25030FBC |
| | 2 | LFH250302 | C | P | S | | P | 10-14 AWG | | | | |
| | 3 | LFH250303 | C | P | S | | S | 10-22 AWG | | | | |
| 60 | 1 | LFH250601 | CID | — | — | 5.6 N-m (50 in-lbs) 2.8 N-m (25 in-lbs) | 2-4 AWG | CU-AL | • | • | LFH25060FBC | |
| | 2 | LFH250602 | CID | — | — | | 6-14 AWG | | | | | |
| | 3 | LFH250603 | CID | — | — | | | | | | | |
| 100 | 1 | LFH251001 | CID | — | — | 13.6 N-m (120 in-lbs) 4.5 N-m (40 in-lbs) 4.0 N-m (35 in-lbs) | 2/0-6 AWG | CU-AL | — | • | LFH25100FBC | |
| | 3 | LFH251003 | CID | — | — | | 8 AWG | | | | | |
| | | | | | | | 10-14 AWG | | | | | |
| 200 | 1 | LFH252001 | C | — | — | 31.1 N-m (275 in-lbs) | 250 kcmil-6 | CU-AL | — | — | — | |
| | 3 | LFH252003 | C | — | — | | | | | | | |
| 400 | 1 | LFH254001 | C | — | — | 31.1 N-m (275 in-lbs) | (2) 350 kcmil-1/0 | CU-AL | — | — | — | |
| | 3 | LFH254003 | C | — | — | | | | | | | |
| 600 | 1 | LFH256001 | C | — | — | 42.4 N-m (375 in-lbs) | (2) 500 kcmil-4 | CU-AL | — | — | — | |
| | 3 | LFH256003 | C | — | — | | | | | | | |

Note: Reinforcing springs standard on all Class H fuse blocks. *Covers sold individually. One cover needed for each pole.

LF SERIES CLASS H/K5 AND R FUSE BLOCKS

Ordering Information (Class H 600 V)

| AMP RATING | POLES | ORDERING NUMBER | | | TORQUE | TERMINAL | WIRE RANGE | WIRE TYPE | BASE TEMP RATING | SNAP TO RELEASE | INDICATION | COVER ORDERING NUMBER* |
|------------|-------|----------------------|---------|-----------------------|--------|---|-------------------|-----------|------------------|-----------------|------------|------------------------|
| | | BASE ORDERING NUMBER | BOX LUG | SUFFIX PRESSURE PLATE | | | | | | | | |
| 30 | 1 | LFH600301 | CID | PID | SID | 2.8 N-m (25 in-lbs) | C | 6-14 AWG | CU Only | 130°C | • | • |
| | 2 | LFH600302 | CID | PID | SID | | P | 10-14 AWG | | | | |
| | 3 | LFH600303 | CID | PID | SID | | S | 10-22 AWG | | | | |
| 60 | 1 | LFH600601 | CID | — | — | 5.6 N-m (50 in-lbs) 2.8 N-m (25 in-lbs) | 2-4 AWG | | CU-AL | 130°C | • | • |
| | 2 | LFH600602 | CID | — | — | | 6-14AWG | | | | | |
| | 3 | LFH600603 | CID | — | — | | | | | | | |
| 100 | 1 | LFH601001 | CID | — | — | 13.6 N-m (120 in-lbs) 4.5 N-m (40 in-lbs) 4.0 N-m (35 in-lbs) | 2/0-6AWG | | CU-AL | 130°C | — | • |
| | 3 | LFH601003 | CID | — | — | | 8 AWG | | | | | |
| | | | | | | | 10-14 AWG | | | | | |
| 200 | 1 | LFH602001 | C | — | — | 31.1 N-m (275 in-lbs) | 250 kcmil-6 | | CU-AL | 130°C | — | — |
| | 3 | LFH602003 | C | — | — | | | | | | | |
| 400 | 1 | LFH604001 | C | — | — | 31.1 N-m (275 in-lbs) | (2) 350 kcmil-1/0 | | CU-AL | 130°C | — | — |
| | 3 | LFH604003 | C | — | — | | | | | | | |
| 600 | 1 | LFH606001 | C | — | — | 42.4 N-m (375 in-lbs) | (2) 500 kcmil-4 | | CU-AL | 130°C | — | — |
| | 3 | LFH606003 | C | — | — | | | | | | | |

Note: Reinforcing springs standard on all Class H fuse blocks.

Ordering Information (Class R 250 V)

| AMP RATING | POLES | ORDERING NUMBER | | | TORQUE | TERMINAL | WIRE RANGE | WIRE TYPE | BASE TEMP RATING | SNAP TO RELEASE | INDICATION | COVER ORDERING NUMBER* |
|------------|-------|----------------------|---------|-----------------------|--------|---|-------------------|-----------|------------------|-----------------|------------|------------------------|
| | | BASE ORDERING NUMBER | BOX LUG | SUFFIX PRESSURE PLATE | | | | | | | | |
| 30 | 1 | LFR250301 | C | P | S | 2.8 N-m (25 in-lbs) | C | 6-14 AWG | CU Only | 125°C | • | — |
| | 2 | LFR250302 | C | P | S | | P | 10-14 AWG | | | | |
| | 3 | LFR250303 | C | P | S | | S | 10-22 AWG | | | | |
| 60 | 1 | LFR250601 | CID | — | — | 5.6 N-m (50 in-lbs) 2.8 N-m (25 in-lbs) | 2-4 AWG | | CU-AL | 125°C | • | • |
| | 2 | LFR250602 | CID | — | — | | 6-14 AWG | | | | | |
| | 3 | LFR250603 | CID | — | — | | | | | | | |
| 100 | 1 | LFR251001 | CID | — | — | 13.6 N-m (120 in-lbs) 4.5 N-m (40 in-lbs) 4.0 N-m (35 in-lbs) | 2/0-6 AWG | | CU-AL | 130°C | — | • |
| | 3 | LFR251003 | CID | — | — | | 8 AWG | | | | | |
| | | | | | | | 10-14 AWG | | | | | |
| 200 | 1 | LFR252001 | C | — | — | 31.1 N-m (275 in-lbs) | 250 kcmil-6 | | CU-AL | 130°C | — | — |
| | 3 | LFR252003 | C | — | — | | | | | | | |
| 400 | 1 | LFR254001 | C | — | — | 31.1 N-m (275 in-lbs) | (2) 350 kcmil-1/0 | | CU-AL | 130°C | — | — |
| | 3 | LFR254003 | C | — | — | | | | | | | |
| 600 | 1 | LFR256001 | C | — | — | 42.4 N-m (375 in-lbs) | (2) 500 kcmil-4 | | CU-AL | 130°C | — | — |
| | 3 | LFR256003 | C | — | — | | | | | | | |

Note: Reinforcing springs standard on all Class R fuse blocks.

Ordering Information (Class R 600 V)

| AMP RATING | POLES | ORDERING NUMBER | | | TORQUE | TERMINAL | WIRE RANGE | WIRE TYPE | BASE TEMP RATING | SNAP TO RELEASE | INDICATION | COVER ORDERING NUMBER* |
|------------|-------|----------------------|---------|-----------------------|--------|---|-------------------|-----------|------------------|-----------------|------------|------------------------|
| | | BASE ORDERING NUMBER | BOX LUG | SUFFIX PRESSURE PLATE | | | | | | | | |
| 30 | 1 | LFR600301 | CID | PID | SID | 2.8 N-m (25 in-lbs) | C | 6-14 AWG | CU Only | 130°C | • | • |
| | 2 | LFR600302 | CID | PID | SID | | P | 10-14 AWG | | | | |
| | 3 | LFR600303 | CID | PID | SID | | S | 10-22 AWG | | | | |
| 60 | 1 | LFR600601 | CID | — | — | 5.6 N-m (50 in-lbs) 2.8 N-m (25 in-lbs) | 2-4 AWG | | CU-AL | 130°C | • | • |
| | 2 | LFR600602 | CID | — | — | | 6-14 AWG | | | | | |
| | 3 | LFR600603 | CID | — | — | | | | | | | |
| 100 | 1 | LFR601001 | CID | — | — | 13.6 N-m (120 in-lbs) 4.5 N-m (40 in-lbs) 4.0 N-m (35 in-lbs) | 2/0-6 AWG | | CU-AL | 130°C | — | • |
| | 3 | LFR601003 | CID | — | — | | 8 AWG | | | | | |
| | | | | | | | 10-14 AWG | | | | | |
| 200 | 1 | LFR602001 | C | — | — | 31.1 N-m (275 in-lbs) | 250 kcmil-6 | | CU-AL | 130°C | — | — |
| | 3 | LFR602003 | C | — | — | | | | | | | |
| 400 | 1 | LFR604001 | C | — | — | 31.1 N-m (275 in-lbs) | (2) 350 kcmil-1/0 | | CU-AL | 130°C | — | — |
| | 3 | LFR604003 | C | — | — | | | | | | | |
| 600 | 1 | LFR606001 | C | — | — | 42.4 N-m (375 in-lbs) | (2) 500 kcmil-4 | | CU-AL | 130°C | — | — |
| | 3 | LFR606003 | C | — | — | | | | | | | |

Note: Reinforcing springs standard on all Class R fuse blocks.

*Covers sold individually. One cover needed for each pole.

CLASS H/K5 AND R FUSE BLOCKS

Dimensions mm (inches)

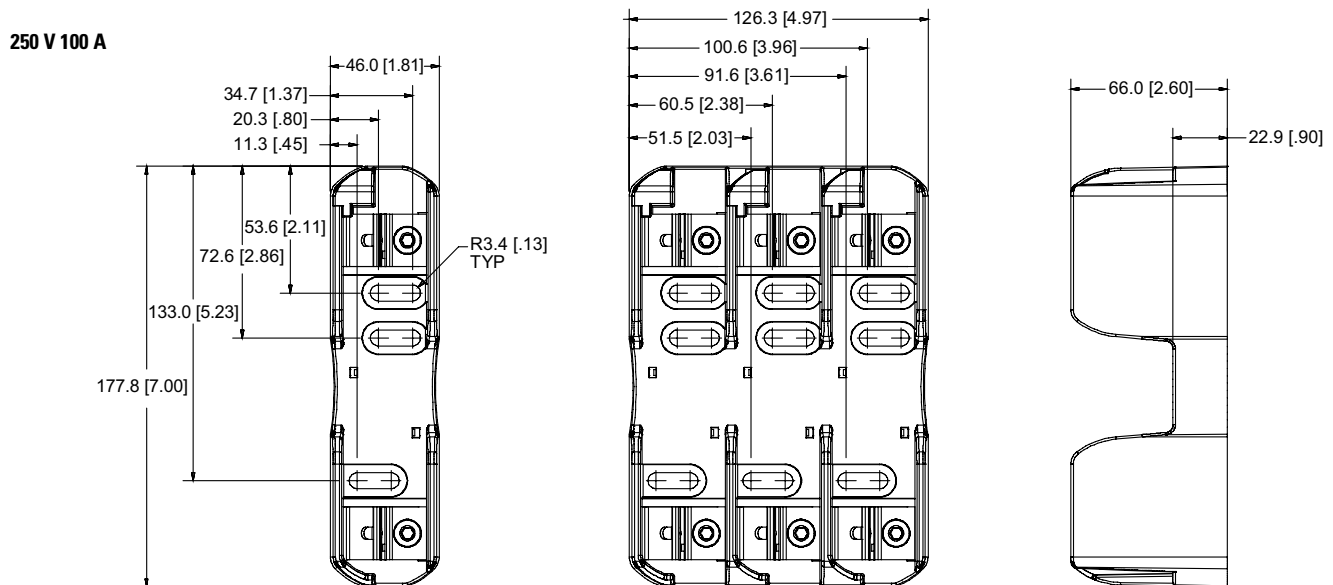
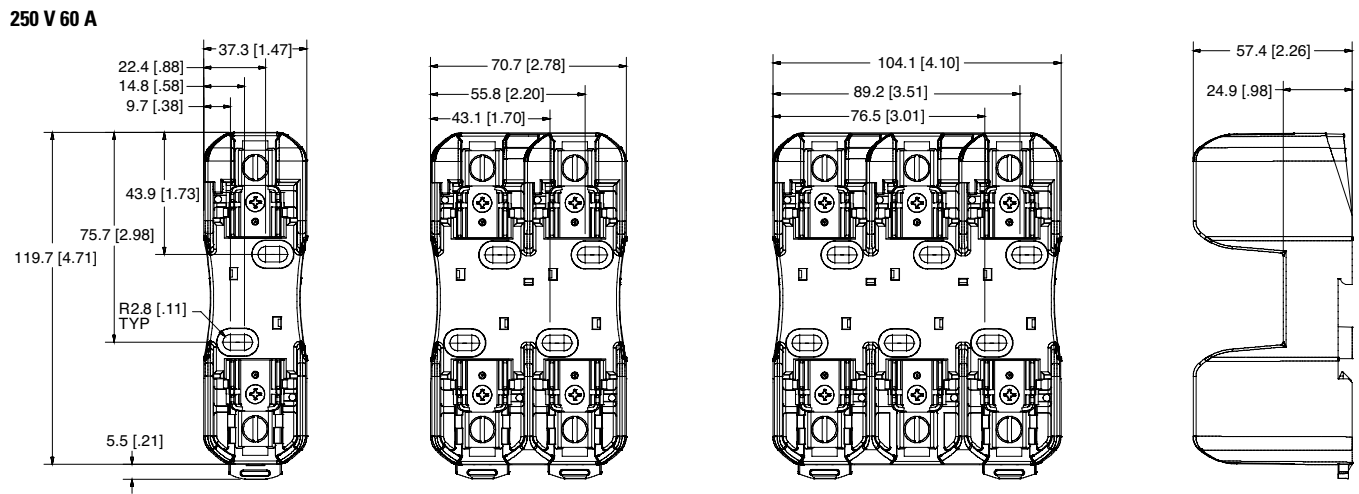
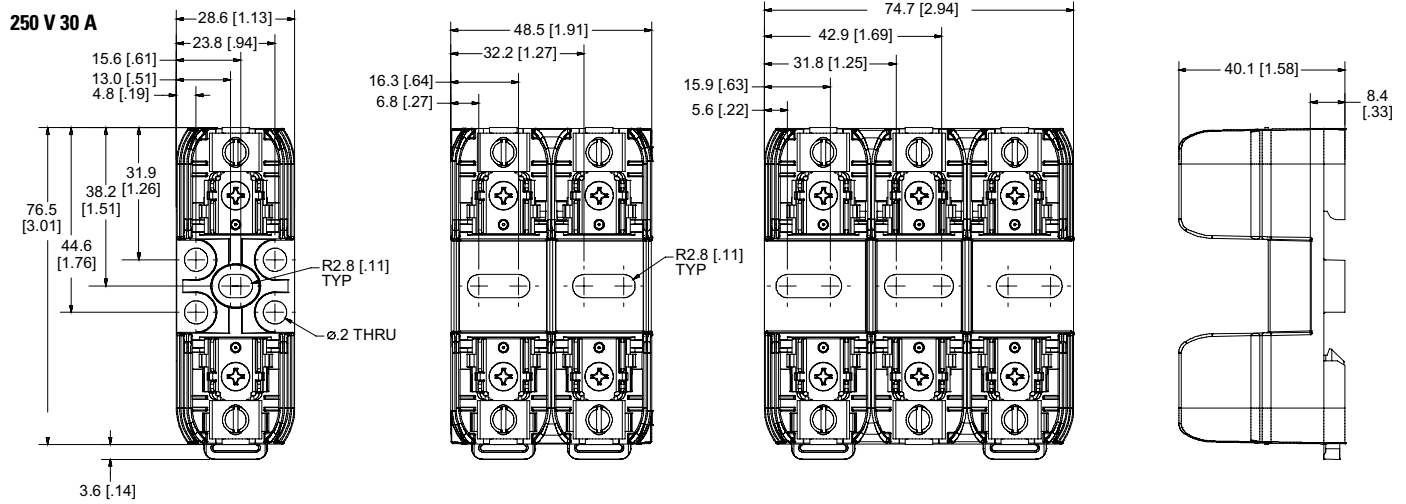

CLASS H/K5 AND R FUSE BLOCKS

Dimensions mm (inches)

250 V 200 A

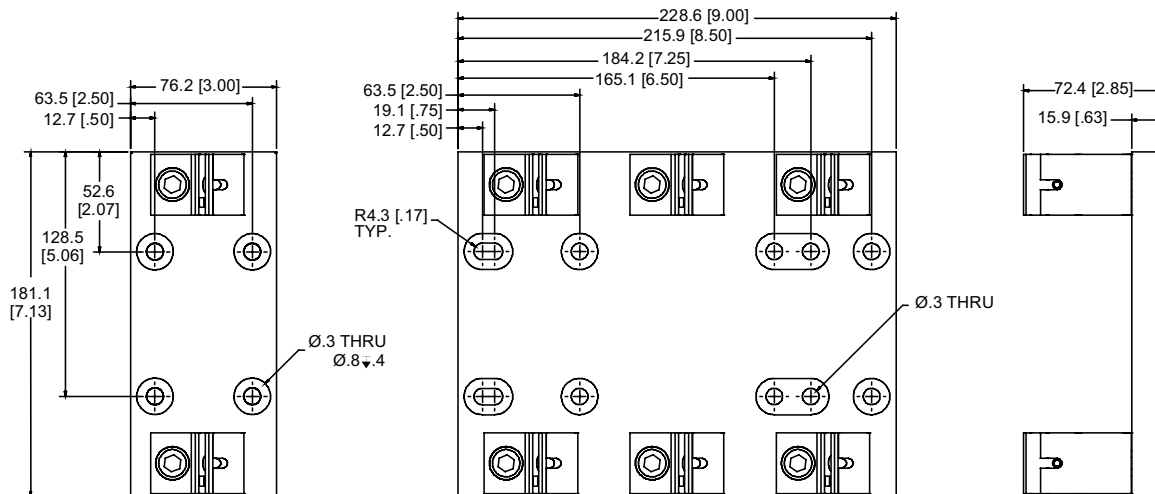

250 V 400 A

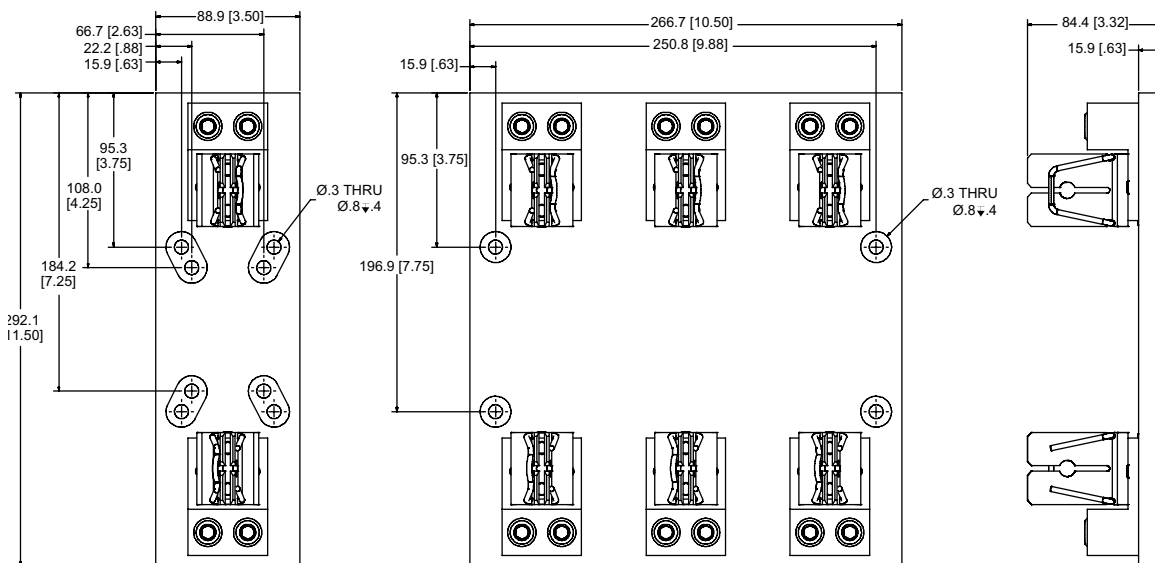

250 V 600 A

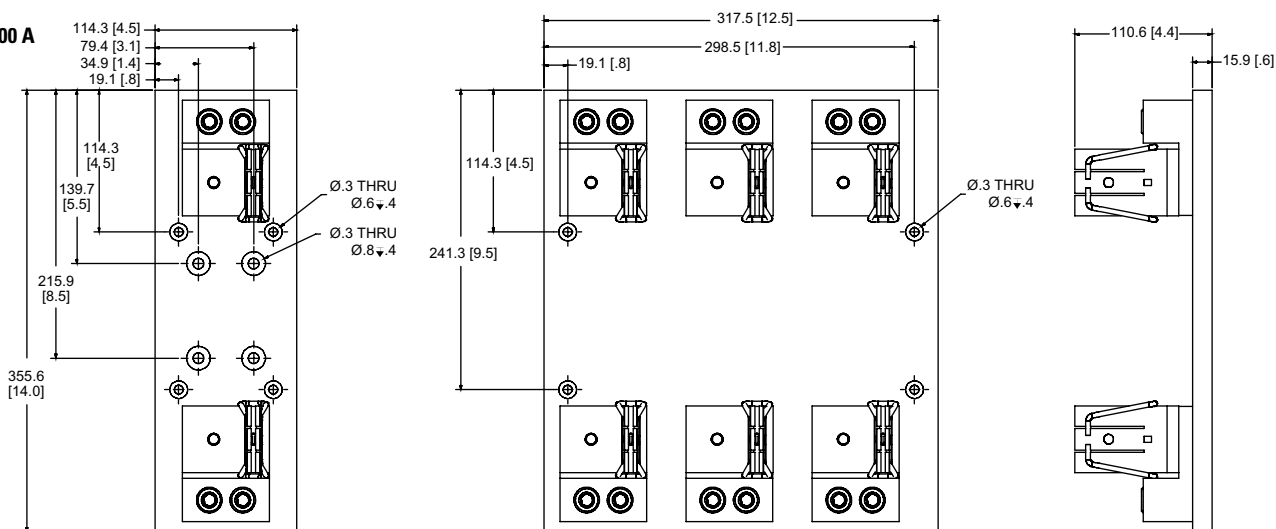

CLASS H/K5 AND R FUSE BLOCKS

Dimensions mm (inches)

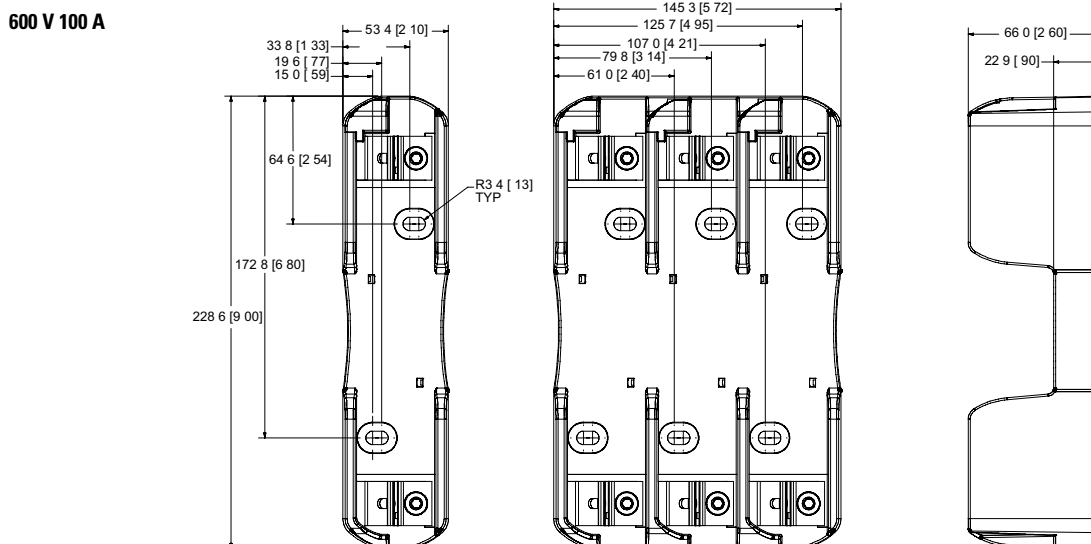
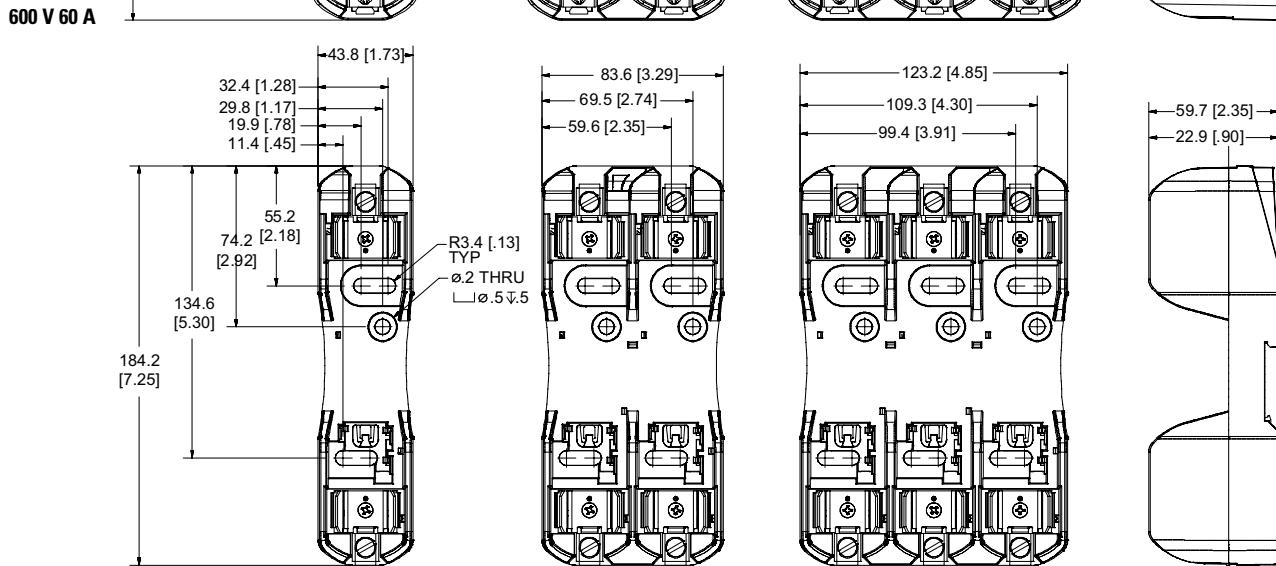
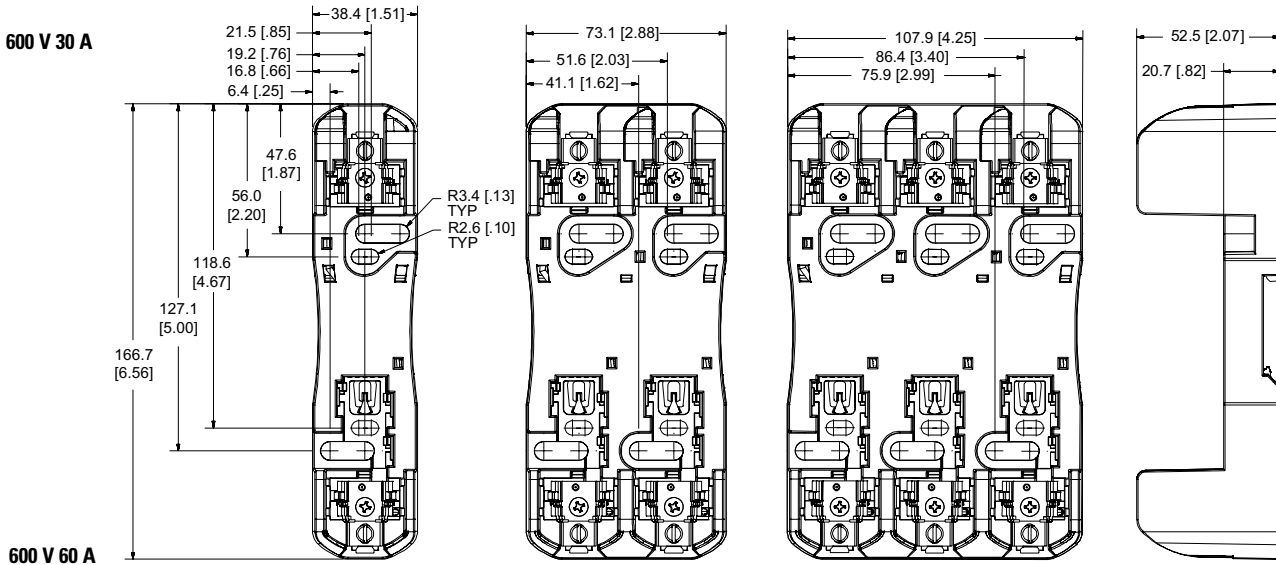

LF SERIES CLASS T FUSE BLOCKS

300 V • 600 V



Description

The Littelfuse Class T fuse blocks offer many advantages such as space saving design, universal mounting holes, snap-to-release DIN rail mounts and available covers.

Features/Benefits

- Space-saving design
- Universal mounting holes for easy replacement
- One hand release from DIN rail for 30–60 A fuses
- Reinforced fuse clips are standard
- Covers available for most amperages to enhance safety

Specifications

| | |
|----------------------------|--|
| Voltage Ratings | 300 VAC/600 VAC |
| Ampere Ratings | 0 – 600 A |
| Leakage Current | <0.6 mA at 600 V |
| Withstand Rating | 200 kA RMS SYM |
| Flammability Rating | UL94 V-0 |
| Approvals | UL Listed (File No. E14721) CSA Certified (File No. LR7316) |
| Environmental | RoHS Compliant, Lead (Pb) Free |

Recommended Fuses

| | |
|------------------------|----|
| 300V JLLN | 26 |
| 600V JLLS | 26 |

Web Resources

Sample requests, downloadable CAD drawings and other technical information: www.littelfuse.com/lft
www.littelfuse.com/fuseblocks

Ordering Information (Class T 300 V)

| AMP RATING | ORDERING NUMBER | | | | | | | TORQUE | WIRE RANGE | WIRE TYPE | BASE TEMP RATING | DIN RAIL MOUNT | COVER ORDERING NUMBER* |
|------------|----------------------|-------|---|---|-----------------|----------------|-------|---|---------------------------------|-------------------------|------------------|----------------|------------------------|
| | BASE ORDERING NUMBER | POLES | | | TERMINAL SUFFIX | | | | | | | | |
| | | 1 | 2 | 3 | BOX LUG | PRESSURE PLATE | SCREW | | | | | | |
| 30 | LFT30030 | 1 | 2 | 3 | C | — | — | 5.6 N-m (50 in-lbs) 2.8 N-m (25 in-lbs) | 2-4 AWG 6-14 AWG | CU-AL Solid/Stranded | 125°C | • | LFT30030FBC |
| 60 | LFT30060 | 1 | 2 | 3 | C | — | — | 5.6 N-m (50 in-lbs) 2.8 N-m (25 in-lbs) | 2-4 AWG 6-14 AWG | | | | LFT30060FBC |
| 100 | LFT30100 | 1 | — | 3 | CS | — | — | 13.6 N-m (120 in-lbs) 4.5 N-m (40 in-lbs) 4.0 N-m (35 in-lbs) | 2/0-6 AWG 8 AWG 10-14 AWG | CU-AL Solid/Stranded | 130°C | — | LFT30100FBC |
| 200 | LFT30200 | 1 | — | 3 | CS | — | — | 31.1 N-m (275 in-lbs) | 250 kcmil-6 | | | | — |
| 400 | LFT30400 | 1 | — | 3 | CS | — | — | (2) 31.1 N-m (275 in-lbs) | 250 kcmil-6 | | | | — |
| 600 | LFT30600 | 1 | — | 3 | CS | — | — | (2) 42.4 N-m (375 in-lbs) | 500 kcmil-6 | | | | — |

Ordering Information (Class T 600 V)

| AMP RATING | ORDERING NUMBER | | | | | | | TORQUE | WIRE RANGE | WIRE TYPE | BASE TEMP RATING | DIN RAIL MOUNT | COVER ORDERING NUMBER* |
|------------|----------------------|-------|---|---|-----------------|----------------|-------|---|---------------------------------|--|------------------|----------------|------------------------|
| | BASE ORDERING NUMBER | POLES | | | TERMINAL SUFFIX | | | | | | | | |
| | | 1 | 2 | 3 | BOX LUG | PRESSURE PLATE | SCREW | | | | | | |
| 30 | LFT60030 | 1 | 2 | 3 | C | P | S | 5.6 N-m (50 in-lbs) 2.8 N-m (25 in-lbs) | 2-4 AWG 6-14 AWG | ** see note CU-AL Solid/Stranded | 125°C | • | LFT60030FBC |
| 60 | LFT60060 | 1 | 2 | 3 | C | — | — | 5.6 N-m (50 in-lbs) 2.8 N-m (25 in-lbs) | 2-4 AWG 6-14 AWG | | | | LFT60060FBC |
| 100 | LFT60100 | 1 | — | 3 | CS | — | — | 13.6 N-m (120 in-lbs) 4.5 N-m (40 in-lbs) 4.0 N-m (35 in-lbs) | 2/0-6 AWG 8 AWG 10-14 AWG | CU-AL Solid/Stranded | 130°C | — | LT60100FBC |
| 200 | LFT60200 | 1 | — | 3 | CS | — | — | 31.1 N-m (275 in-lbs) | 250 kcmil-6 | | | | LT60200FBC |
| 400 | LFT60400 | 1 | — | 3 | CS | — | — | (2) 31.1 N-m (275 in-lbs) | 250 kcmil-6 | | | | LT60400FBC |
| 600 | LFT60600 | 1 | — | 3 | CS | — | — | (2) 42.4 N-m (375 in-lbs) | 500 kcmil-6 | | | | LT60600FBC |

*Covers sold individually. One cover needed for each pole.
**Wire Type for Pressure Plate and Screw Terminal is CU only

LF SERIES CLASS T FUSE BLOCKS

Dimensions mm (inches)

300 V 30 A

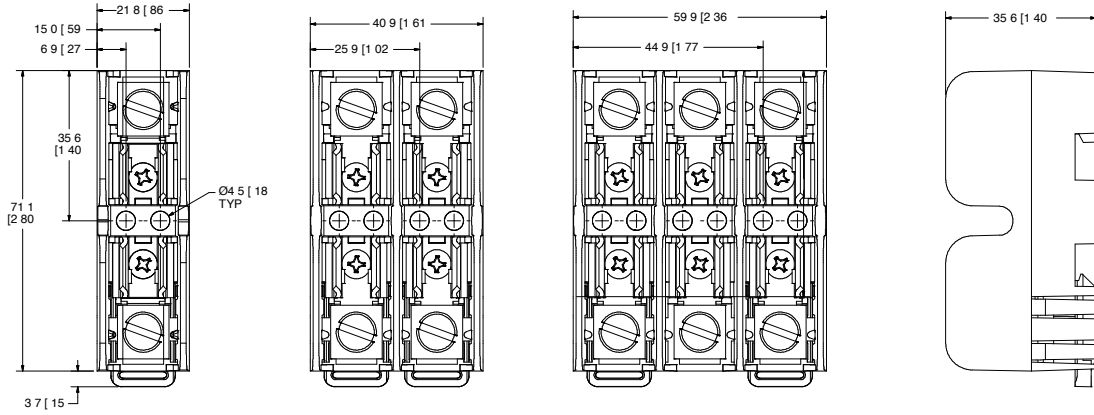

300 V 60 A

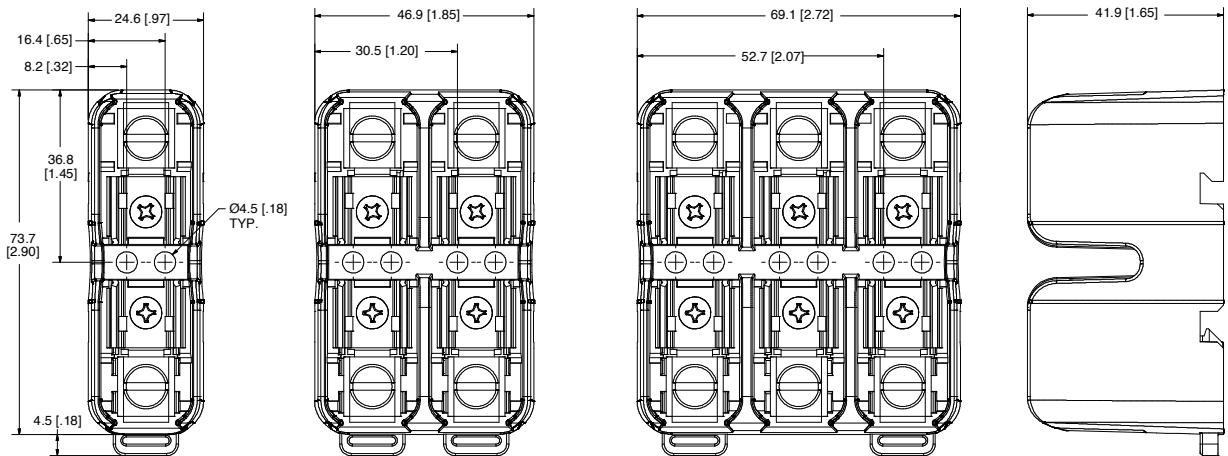

300 V 100 A

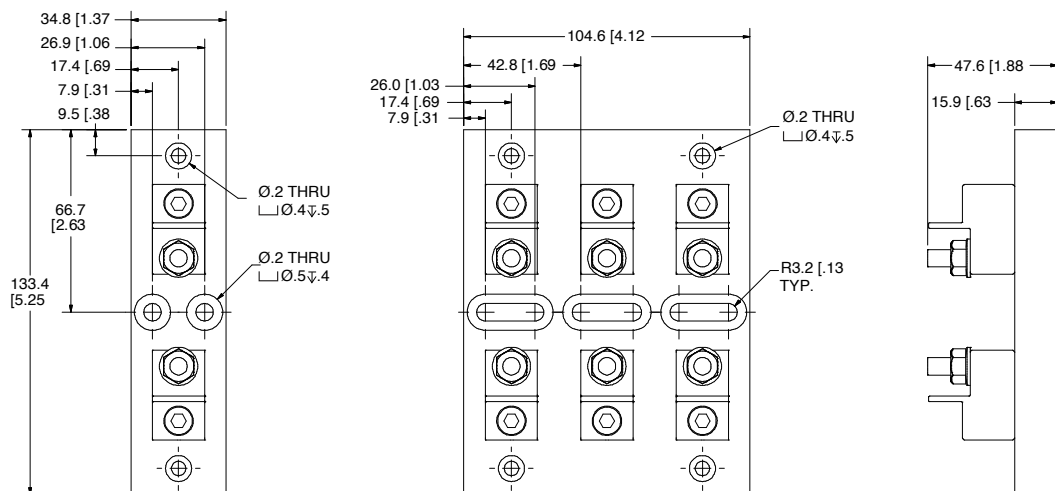

LF SERIES CLASS T FUSE BLOCKS

Dimensions mm (inches)

300 V 200 A

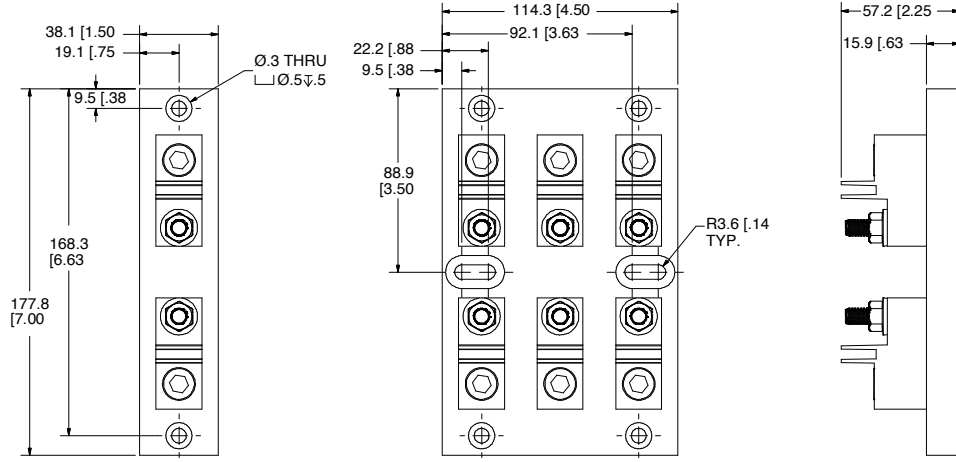

300 V 400 A

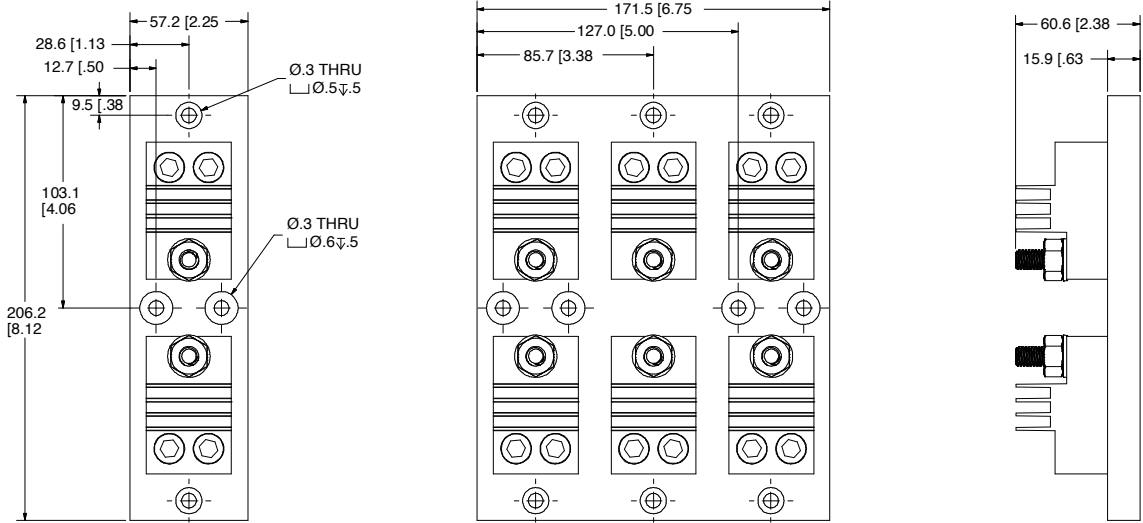

300 V 600 A

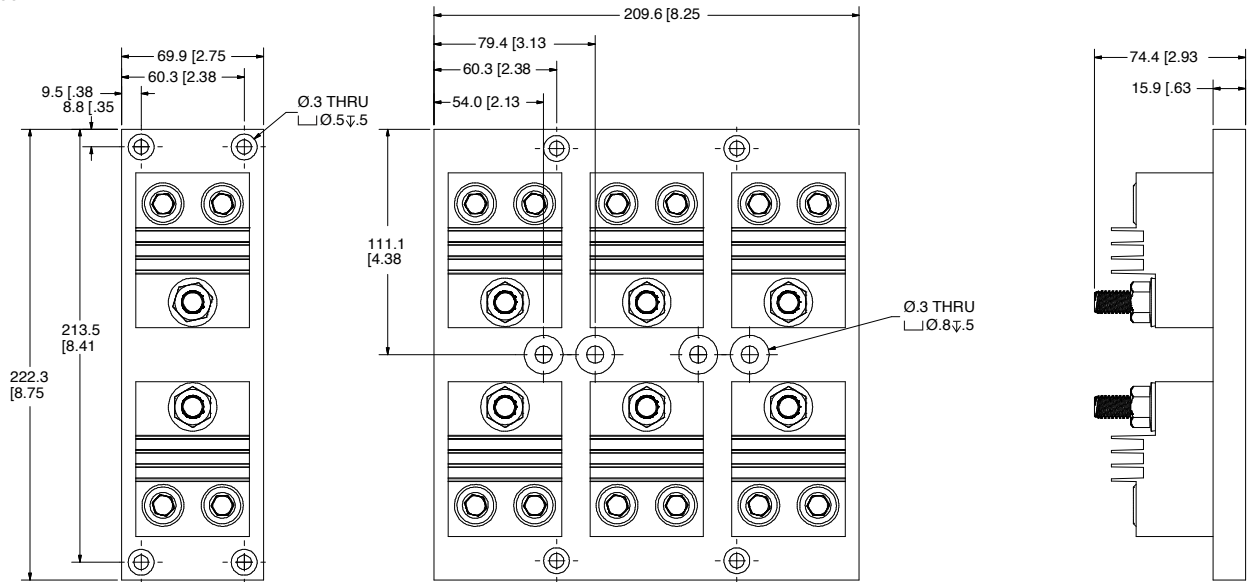

LF Series Fuse Blocks 6

LF SERIES CLASS T FUSE BLOCKS

Dimensions mm (inches)

600 V 30 A

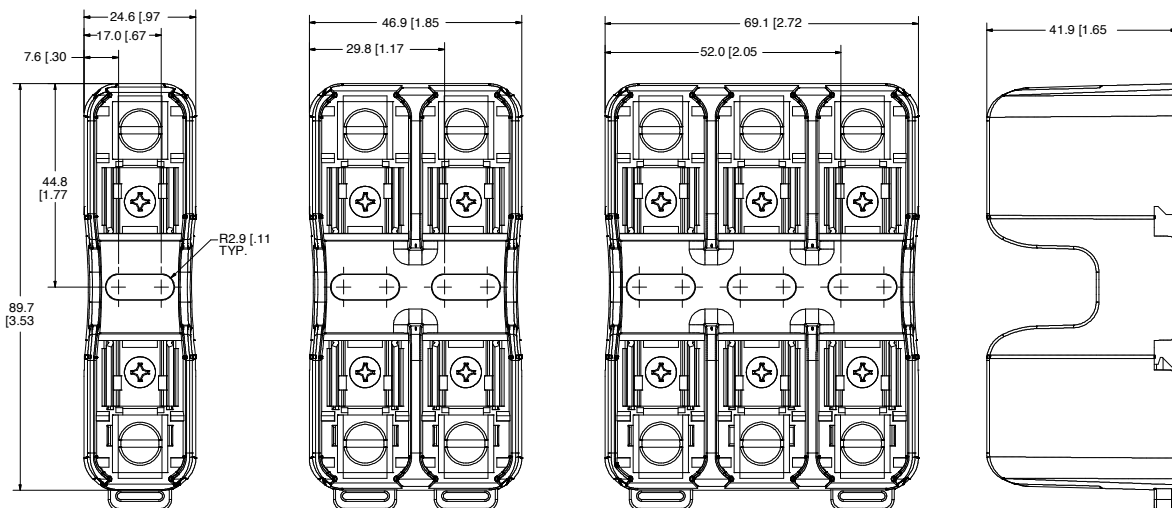

600 V 60 A

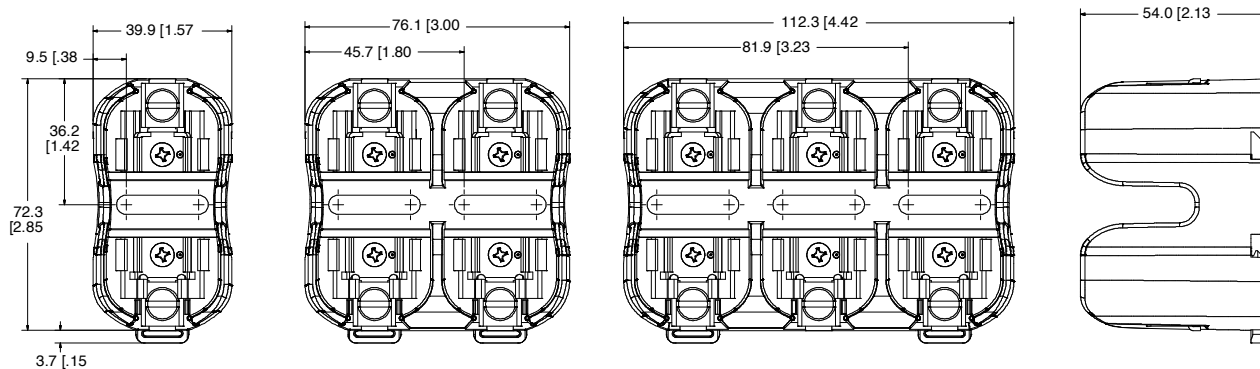

600 V 100 A

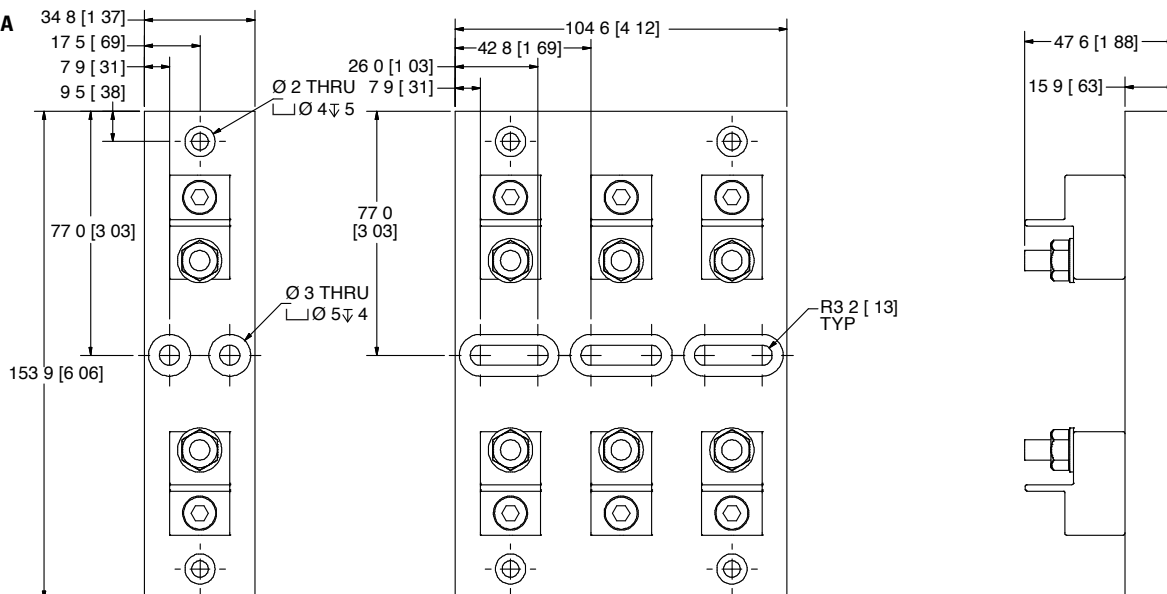

LF SERIES CLASS T FUSE BLOCKS

Dimensions mm (inches)

600 V 200 A

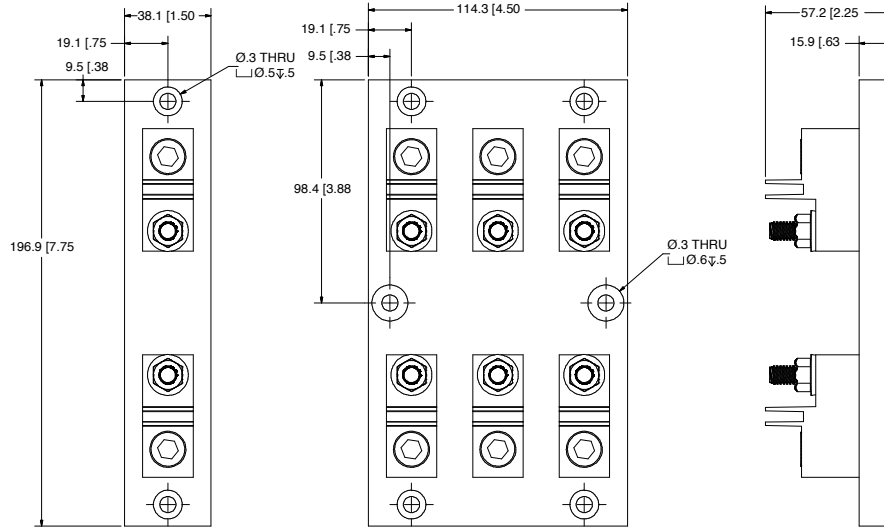

600 V 400 A

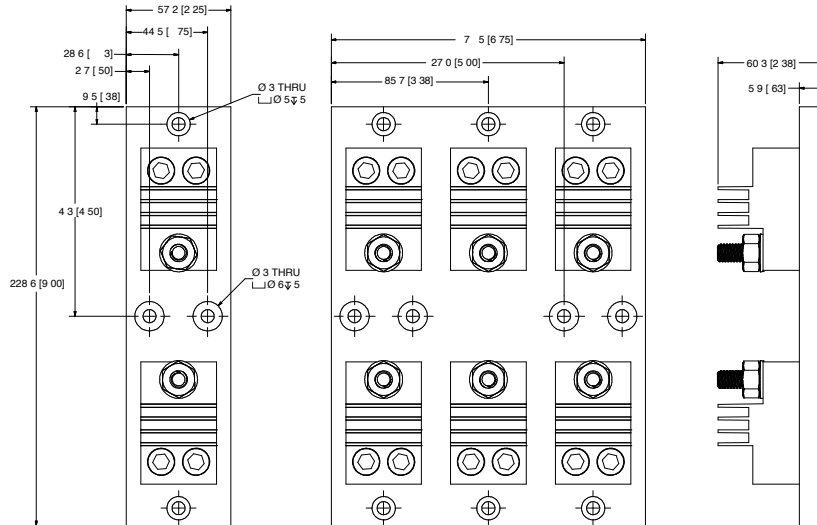

600 V 600 A

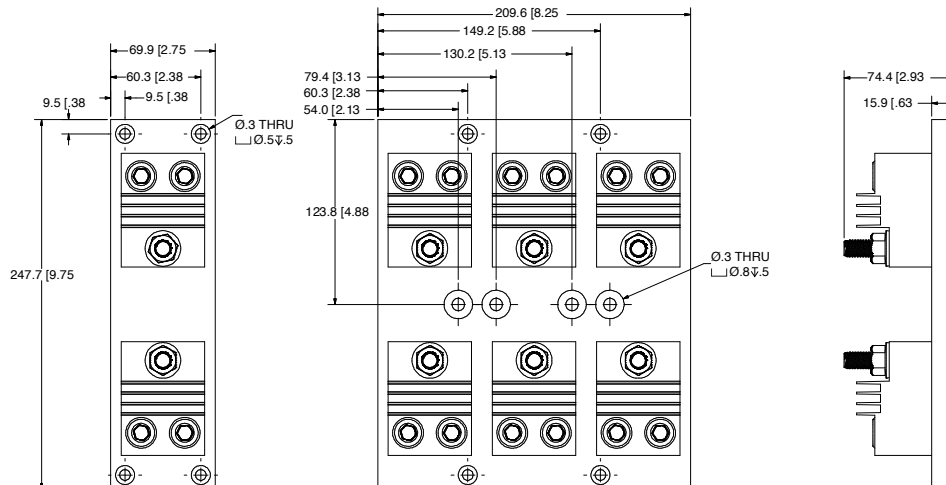

LF SERIES CLASS G FUSE BLOCKS

480 V • 600 V



Description

All Littelfuse Class G fuse blocks offer snap-to-release DIN rail mounting and universal mounting holes. Class G fuse blocks are designed for use with time-delay current limiting Class G fuses.

Features/Benefits

- Universal mounting holes for easy replacement
- One hand release from DIN rail for most amperages
- Meet requirements for branch circuit protection

Specifications

| | |
|----------------------------|--|
| Voltage Ratings | 600 VAC (0–20 A) 480 VAC (25–60 A) |
| Ampere Ratings | 0–60 A |
| Flammability Rating | UL94 V-0 |
| Approvals | UL Listed (File No. E14721) CSA Certified (File No. LR7091) |

Recommended Fuses

| | |
|-------------------|---------------------|
| Time Delay | Series: SLC..... 28 |
|-------------------|---------------------|

Web Resources

For additional technical information visit:
www.littelfuse.com/lfg
www.littelfuse.com/fuseblocks

Ordering Information (Class G 600 V)

| AMP RATING | POLES | ORDERING NUMBER | | | WIRE TYPE | BASE TEMP RATING | DIN RAIL MOUNT | TERMINAL INFORMATION | | | | |
|------------|-------|------------------|---------|----------------|-----------|------------------|----------------|----------------------|----------|----------------|-----------|---------------------|
| | | BASE PART NUMBER | BOX LUG | PRESSURE PLATE | | | | SCREW | TERMINAL | WIRE RANGE | TORQUE | |
| 15 | 1 | LFG600151 | CDINR | PQDINR | SQDINR | CU Only | Solid/Stranded | 150° C | • | Box Lug | 6-14 AWG | 4.0 N-m (35 in-lbs) |
| | 2 | LFG600152 | CDINR | PQDINR | SQDINR | | | | | Pressure Plate | 10-14 AWG | 2.3 N-m (20 in-lbs) |
| | 3 | LFG600153 | CDINR | PQDINR | SQDINR | | | | | Screw | 10-14 AWG | 2.3 N-m (20 in-lbs) |
| 20 | 1 | LFG600201 | CDINR | PQDINR | SQDINR | CU Only | Solid/Stranded | 150° C | • | Box Lug | 6-14 AWG | 4.0 N-m (35 in-lbs) |
| | 2 | LFG600202 | CDINR | PQDINR | SQDINR | | | | | Pressure Plate | 10-14 AWG | 2.3 N-m (20 in-lbs) |
| | 3 | LFG600203 | CDINR | PQDINR | SQDINR | | | | | Screw | 10-14 AWG | 2.3 N-m (20 in-lbs) |

Ordering Information (Class G 480 V)

| AMP RATING | POLES | ORDERING NUMBER | | | WIRE TYPE | BASE TEMP RATING | DIN RAIL MOUNT | TERMINAL INFORMATION | | | | |
|------------|-------|------------------|---------|----------------|-----------|------------------|----------------|----------------------|----------|----------------|-----------|---------------------|
| | | BASE PART NUMBER | BOX LUG | PRESSURE PLATE | | | | SCREW | TERMINAL | WIRE RANGE | TORQUE | |
| 30 | 1 | LFG480301 | CDINR | PQDINR | SQDINR | CU Only | Solid/Stranded | 150° C | • | Box Lug | 6-14 AWG | 4.0 N-m (35 in-lbs) |
| | 2 | LFG480302 | CDINR | PQDINR | SQDINR | | | | | Pressure Plate | 10-14 AWG | 2.3 N-m (20 in-lbs) |
| | 3 | LFG480303 | CDINR | PQDINR | SQDINR | | | | | Screw | 10-14 AWG | 2.3 N-m (20 in-lbs) |
| 60 | 1 | LFG480601 | CDINR | — | — | CU/AI | Solid/Stranded | 125° C | • | Box Lug | 2-4 AWG | 5.6 N-m (50 in-lbs) |
| | 2 | LFG480602 | CDINR | — | — | | | | | Box Lug | 6-14 AWG | 2.8 N-m (25 in-lbs) |
| | 3 | LFG480603 | CDINR | — | — | | | | | | | |

LF SERIES CLASS G FUSE BLOCKS

Dimensions mm (inches)

600 V 15 & 20 A
480 V 30 A

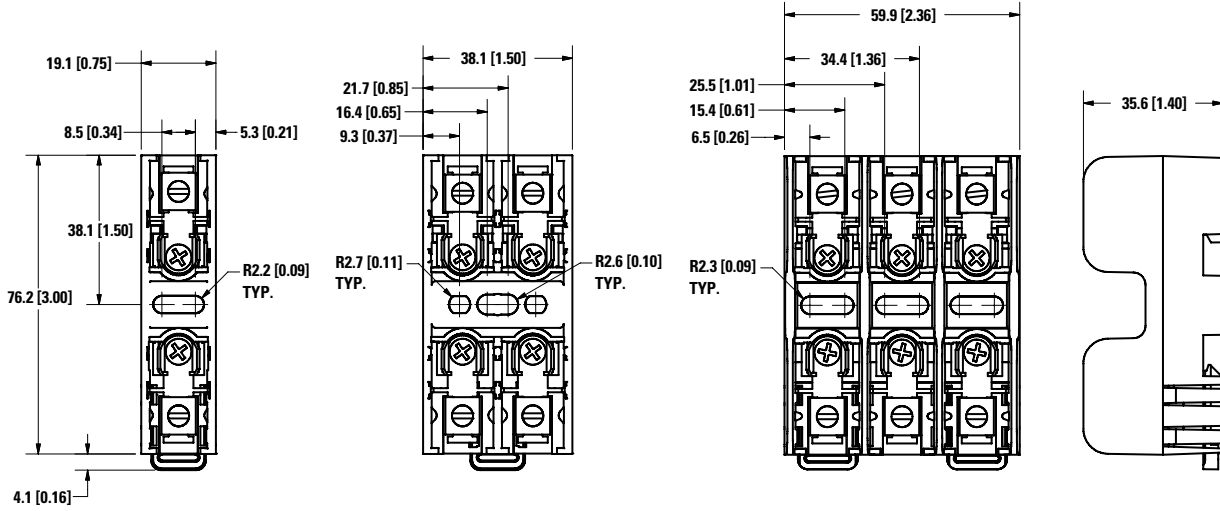

480 V 60 A

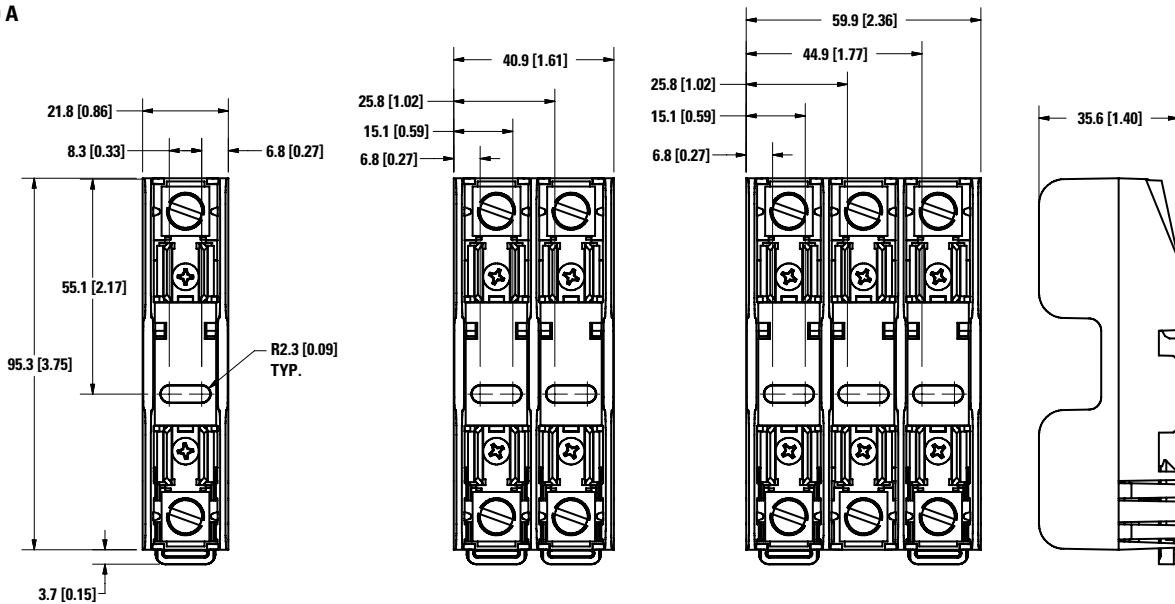

LF SERIES CLASS CC/CD AND MIDGET (10X38 mm) FUSE BLOCKS

600 V



Description

The Littelfuse Class CC, CD and midget blocks offer generous space savings and enhanced value. DIN rail mounting and universal mounting holes are all available. Indication feature on all Class CD fuse blocks.

Features/Benefits

- Space-saving design
- Universal mounting holes for easy replacement
- Indication offered on CD blocks
- One hand release from DIN rail optional
- Rejection feature that prevents the insertion of fuses with lower interrupting rating or voltage ratings
- Clip design reduces resistance and heat
- Non DIN Rail fuse blocks have interlocking feature allowing ganging for any number of poles
- Covers available for all amperages to enhance safety

Specifications

| | |
|--|--|
| Voltage Rating | 600 VAC/600 VDC |
| Ampere Ratings | Class CC: 30 A Class CD: 60 A |
| Dielectric strength | 1200 V minimum |
| Clip/terminals | Tin-plated copper alloy |
| Box lug | Copper |
| Screw and captive pressure plate Base | Zinc-plated steel Thermoplastic UL94 V-0 flammability rating |
| Approvals | Class CC/CD: UL Listed (File No. E14721) Class CD: CSA Certified (File No. LR73091) Class CC: CSA Certified (File No. LR7316) Midget: UL Recognized (File No. E14721) |
| Environmental | RoHS Compliant, Lead (Pb) Free |

Recommended Fuses

| | |
|--|----|
| Class CC Blocks: | |
| CCMR | 29 |
| KLDR, KLKR..... | 30 |
| Class CD Blocks: | |
| CCMR | 29 |
| Midget Blocks: | |
| BLF, BLN, BLS, FLA, FLM, FLO, FLU, KKK, KLKD, KLO | 32 |

Web Resources

Sample requests, downloadable CAD drawings, fuse block cover datasheet and other technical information:
www.littelfuse.com/fuseblocks

Ordering Information (Class CC and Midget 30 A)

| AMP RATING | POLES | CLASS CC ORDERING NUMBER | | MIDGET ORDERING NUMBER | | CONNECTOR TYPE | TORQUE | WIRE RANGE | WIRE TYPE | BASE TEMP | COVER ORDERING NUMBER** |
|------------|-------|--------------------------|----------------|------------------------|----------------|--------------------------------|---------------------|------------|------------------------|-----------|-------------------------|
| | | NON-DIN* | DINR | NON-DIN* | DINR | | | | | | |
| 30 | 1 | L60030C1C | L60030C1CDINR | L60030M1C | L60030M1CDINR | Box Lug | 5.6 N-m (50 in-lbs) | 2-4 AWG | CU-AL Solid / Stranded | 125°C | SPL001 |
| | 2 | L60030C2C | L60030C2CDINR | L60030M2C | L60030M2CDINR | | 2.8 N-m (25 in-lbs) | 6-14 AWG | | | |
| | 3 | L60030C3C | L60030C3CDINR | L60030M3C | L60030M3CDINR | | | | | | |
| 30 | 1 | L60030C1PQ | L60030C1PQDINR | L60030M1PQ | L60030M1PQDINR | Pressure Plate w/Q.C. Terminal | 5.6 N-m (50 in-lbs) | 2-4 AWG | CU-AL Solid / Stranded | 125°C | SPL001 |
| | 2 | L60030C2PQ | L60030C2PQDINR | L60030M2PQ | L60030M2PQDINR | | 2.8 N-m (25 in-lbs) | 6-14 AWG | | | |
| | 3 | L60030C3PQ | L60030C3PQDINR | L60030M3PQ | L60030M3PQDINR | | | | | | |
| 30 | 1 | L60030C1SQ | L60030C1SQDINR | L60030M1SQ | L60030M1SQDINR | Screw w/Q.C. Terminal | 5.6 N-m (50 in-lbs) | 2-4 AWG | CU-AL Solid / Stranded | 125°C | SPL001 |
| | 2 | L60030C2SQ | L60030C2SQDINR | L60030M2SQ | L60030M2SQDINR | | 2.8 N-m (25 in-lbs) | 6-14 AWG | | | |
| | 3 | L60030C3SQ | L60030C3SQDINR | L60030M3SQ | L60030M3SQDINR | | | | | | |

Ordering Information (Class CD 60 A)

| AMP RATING | POLES | ORDERING NUMBER | CONNECTOR TYPE | TORQUE | WIRE RANGE | WIRE TYPE | BASE TEMP RATING | DIN RAIL MOUNT | INDICATION | COVER ORDERING NUMBER** |
|------------|-------|-----------------|----------------|---------------------|------------|------------------------|------------------|----------------|------------|-------------------------|
| 60 | 1 | LFC600601CID | Box Lug | 5.6 N-m (50 in-lbs) | 2-4 AWG | CU-AL Solid / Stranded | 125°C | • | • | LFC60060FBC |
| | 2 | LFC600602CID | | | 6-14 AWG | | | | | |
| | 3 | LFC600603CID | | | | | | | | |

* Gangable

**Covers sold individually. One cover needed for each pole.
Note: Quick Connect Terminals are rated at 20 A

LF SERIES CLASS CC/CD AND MIDGET (10X38 mm) FUSE BLOCKS

Dimensions mm (inches)

CLASS CC / MIDGET DIN RAIL 600 V 30 A

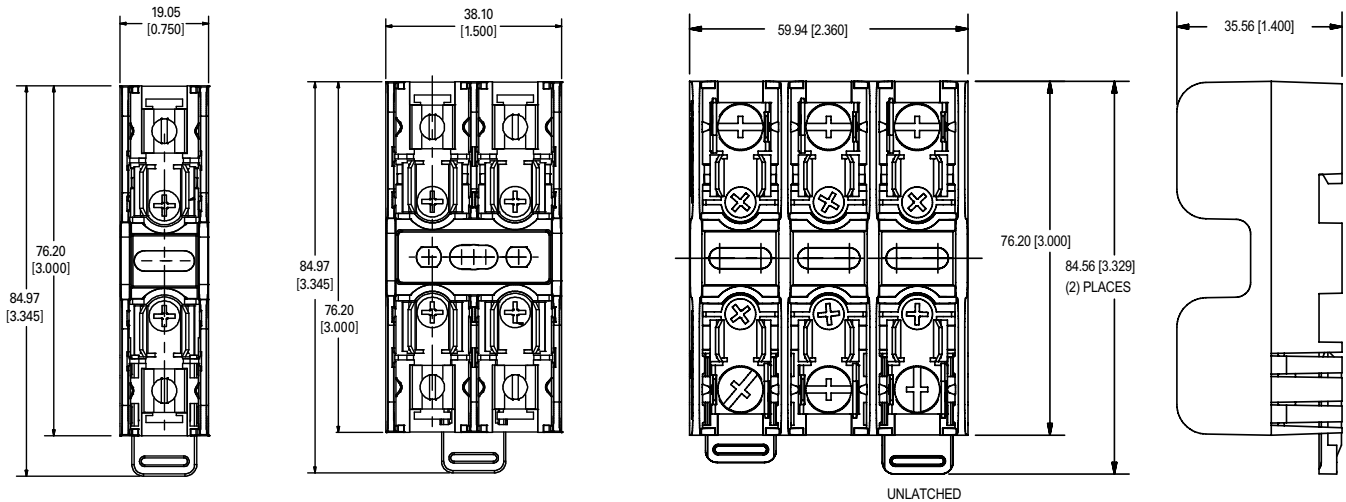

CLASS CC / MIDGET NON-DIN RAIL 600 V 30 A

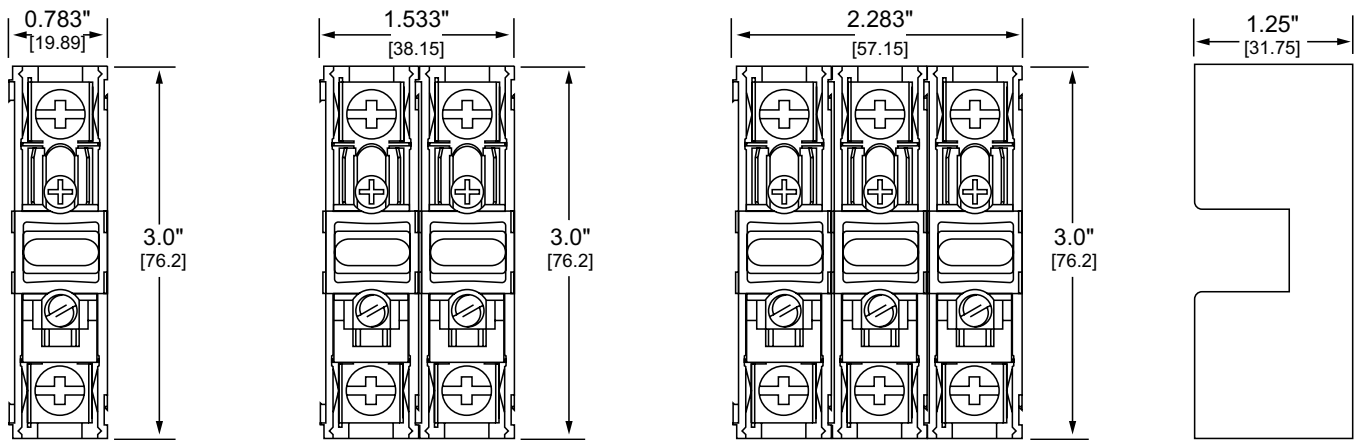

CLASS CD DIN RAIL 600 V 60 A

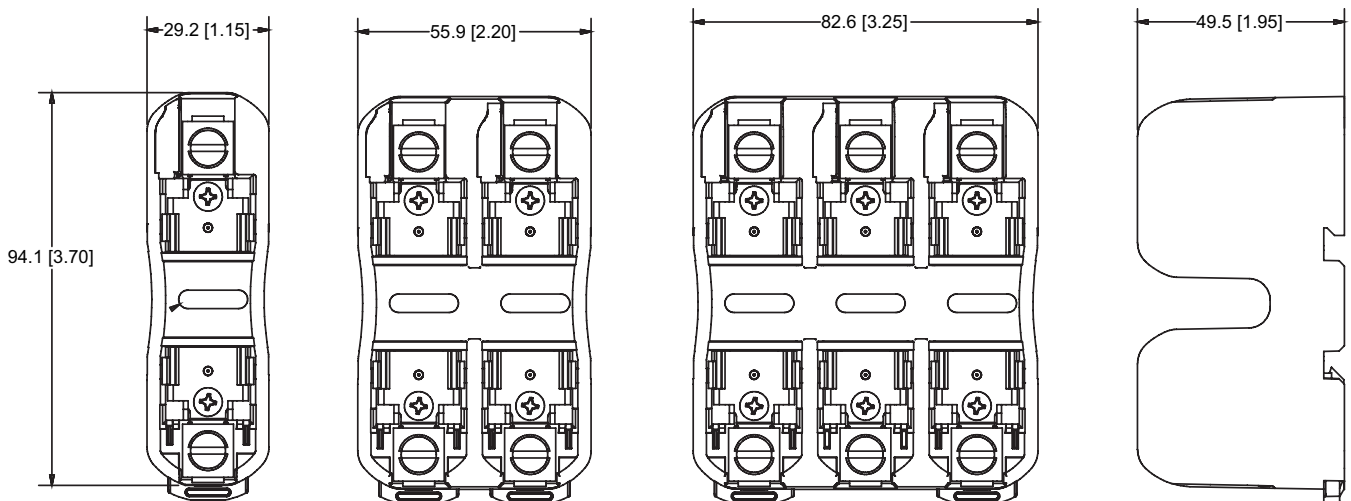

BOARD MOUNT MIDGET (10X38 mm) FUSE HOLDER

600 V



Description

The PC board-mounted midget fuse holder is a one-piece holder designed to provide a more robust and secure solution. It offers a smaller footprint and flexible mounting options.

For use with Midget-style fuses and fuse covers, it is UL Recognized and can be covered for additional protection.

Features/Benefits

- Through hole PCB mounting
- Robust and secure block design
- All-in-one package offers easy installation
- Space saving footprint
- Touch Safe cover/puller available
- 3-pole configurations

Applications

- HVAC market
- Industrial manufacturing
- Mass production facilities

SPL001PCB Cover

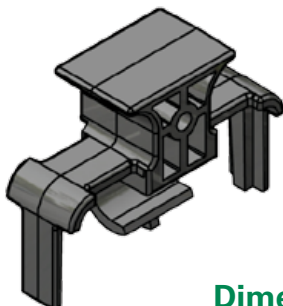

Dimensions mm (inches)

Specifications

| | |
|------------------------|---------------------------------|
| Voltage Rating | 600 VAC/600 VDC |
| Amperage Rating | 30 A |
| Approval | UL Recognized (File No. E14721) |
| Mounting Method | Through hole solder/PCB |

Ordering Information

| | CATALOG NUMBER | ORDERING NUMBER |
|--------|----------------|-----------------|
| Block | L60030M3PCB | L60030M3PCB |
| Cover* | SPL001PCB | SPL0001PCBT |

*Covers are single pole—need to order a quantity of 3 for each block.

Recommended Fuses

Midget (10 x 38 mm) series32

Web Resources

For additional technical information visit:
www.littelfuse.com/fuseblocks

Dimensions mm (inches)

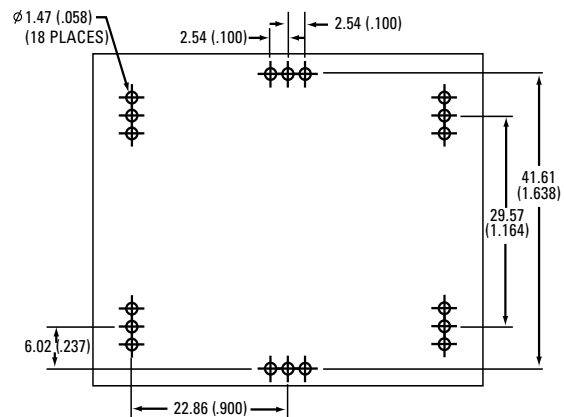
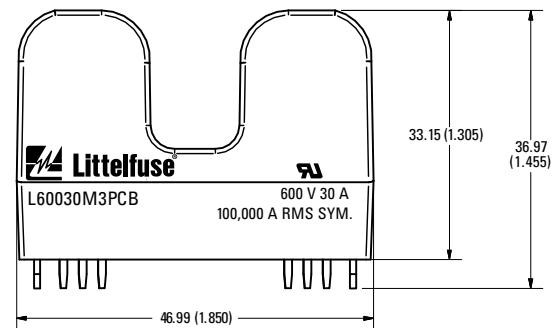

CLASS CC AND MIDGET FUSE BLOCK ACCESSORIES

FBDIN1 Rail Adapter



Features/Benefits

- DIN Rail adaptor for 30 A Midget, Class CC and Class G fuse blocks
- Patented design with no tools necessary for installation
- Permits snap-mounting of Class CC, Class G and Midget 30 A fuse blocks to standard and low profile 35 mm symmetrical DIN rails and 32 mm asymmetrical DIN rails
- Easy removal via disconnect tab

Web Resources

For additional technical information visit:
www.littelfuse.com/fbdin1

Dimensions Inches

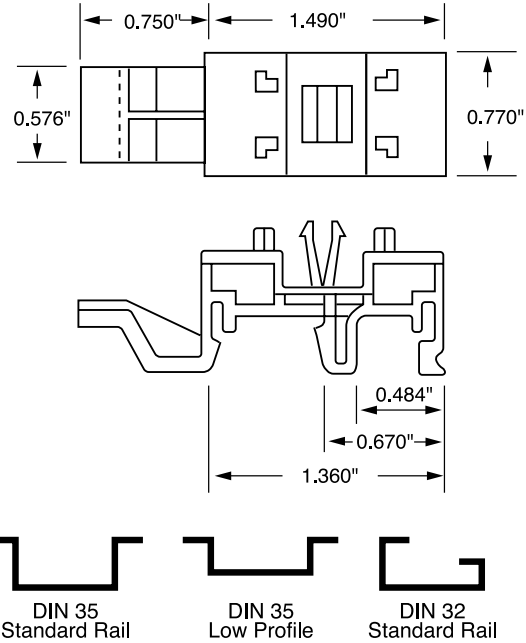

Recommended Fuse Blocks

| | |
|---------------------------------|----|
| Midget-Style and Class CC | 32 |
| Class G | 28 |

New DIN rail mountable fuse holders available on page 99

SPL001 Cover Puller

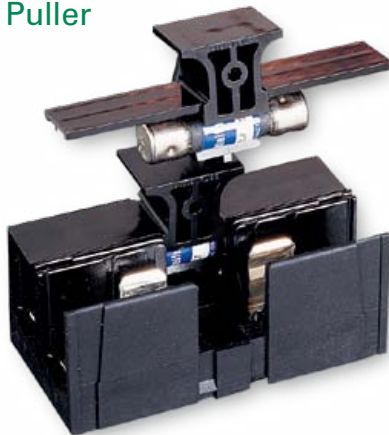

Features/Benefits

- 600 V 1/10-30 A Class CC and Midget fuse cover puller that offers increased protection when removing fuses
- Simple removal without the need for a separate puller
- Meets Dead Front requirements
- Easily gangable with 5/16" diameter wire
- For use with all 600 V Class CC and Midget 1/10-30 A fuses
- Label provided for easy fuse identification

Dimensions Inches

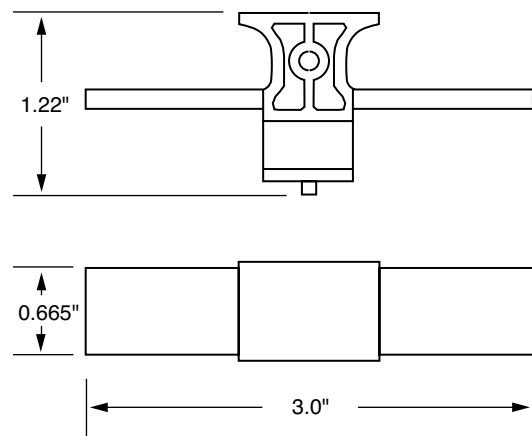

Recommended Fuse Blocks

| | |
|---------------|----|
| L60030C | 99 |
| L60030M | 99 |

Web Resources

For additional technical information visit:
www.littelfuse.com/spl001

LF SERIES FUSE BLOCK COVERS



Specifications

| | |
|----------------------------|--|
| Connection | Snap to fuse body |
| Molded Base | Black thermoplastic |
| Flammability Rating | UL94 V-0 |
| Approvals | UL Listed (File No. E184929) |
| CSA Certified | (File No. 007316_0_000 Class 6225-01) |

Features/Benefits

- Added safety to personnel
- Ventilated to avoid fuse derating
- Reusable
- UL listed and CSA certified
- Available for Class H/R, Class J, Class T and Class CD
- Convenient snap-on feature
- Allows visibility of indicator fuse block light

Web Resources

Downloadable CAD drawings, dimensions and other technical information, visit www.littelfuse.com/fuseblocks

Description

Littelfuse fuse block covers protect personnel from accidentally coming into contact with energized parts. Covers are for use with various UL class fuse blocks. Please, review the ordering information for available covers.

Ordering Information

| UL CLASS | FUSE BLOCK BASE PART NUMBER* | VOLTAGE | AMPERAGE | COVER ORDERING NUMBER |
|-----------|------------------------------|---------|----------|-----------------------|
| Class H/R | LFH25030 / LFR25030 | 250 | 30 | LFH25030FBC |
| Class H/R | LFH25060 / LFR25030 | 250 | 60 | LFH25060FBC |
| Class H/R | LFH25100 / LFR25100 | 250 | 100 | LFH25100FBC |
| Class H/R | LFH60030 / LFR60030 | 600 | 30 | LFH60030FBC |
| Class H/R | LFH60060 / LFR60060 | 600 | 60 | LFH60060FBC |
| Class H/R | LFH60100 / LFR60100 | 600 | 100 | LFH60100FBC |
| Class J | LFJ60030 | 600 | 30 | LFJ60030FBC |
| Class J | LFJ60060 | 600 | 60 | LFJ60060FBC |
| Class J | LFJ60100 | 600 | 100 | LFJ60100FBC |
| Class T | LFT30030 | 300 | 30 | LFT30030FBC |
| Class T | LFT30060 | 300 | 60 | LFT30060FBC |
| Class T | LFT30100 | 300 | 100 | LFT30100FBC |
| Class T | LFT60030 | 600 | 30 | LFT60030FBC |
| Class T | LFT60060 | 600 | 60 | LFT60060FBC |
| Class T | LFT60100 | 600 | 100 | LT60100FBC |
| Class T | LFT60200 | 600 | 200 | LT60200FBC |
| Class T | LFT60400 | 600 | 400 | LT60400FBC |
| Class T | LFT60600 | 600 | 600 | LT60600FBC |
| Class CD | LFC60060 | 600 | 60 | LFC60060FBC |
| Class CC | L60030C | 600 | 30 | SPL001 |

* Part number shown excludes reference to number of poles and terminal type

LF SERIES SOLAR FUSE BLOCK

1000 VDC



Description

The LFJ 1000 V fuse block is specifically designed for the Littelfuse SPFJ 1000 V Solar Fuse. It meets UL electrical characteristic requirements and is available in multiple amperages.

Features/Benefits

- Narrow width increases space savings
- Range of amperages to match all SPFJ fuse options
- Box Lug termination style accommodates a wide range of cable sizes
- Stud-mounted option increases convenience
- Approval for use with copper or aluminum lugs allowing for design flexibility

Ordering Information (1000 V)

| AMPERAGE | ORDERING NUMBER | DC INTERRUPT RATING | WIRE RANGE STANDARD (METRIC) | WIRE TYPE | | RECOMMENDED TORQUE |
|----------|-----------------|---------------------|--|-----------|----------------|----------------------|
| | | | | | | |
| 200 | LFJ102001C | 20 kA | 250 kcmil - #6 (127mm ² - 16mm ²) | Cu/Al | Solid/Stranded | 31.1 N-m (275 in-lb) |
| 400 | LFJ104001C | 10 kA | 350 kcmil - 1/0 (177mm ² - 55mm ²) | Cu/Al | Solid/Stranded | 31.1 N-m (275 in-lb) |
| 450 | LFJ104501C | 20 kA | 500 kcmil - #4 (253mm ² - 25mm ²) | Cu/Al | Solid/Stranded | 42.4 N-m (375 in-lb) |

Ordering Information (Stud-Mounted 1000 V)

| AMPERAGE | ORDERING NUMBER | SCCR RATING | RECOMMENDED TORQUE | | MAX. BUSBAR THICKNESS | BASE TORQUE | |
|----------|-----------------|-------------|-------------------------|-------------------------|-----------------------|---------------|----------------------------|
| | | | FUSE | TERMINAL | | BOLT SIZE | TORQUE |
| 100 | LFJ101001STST | 10 kA | 7.3 N-m (65 in-lb) | 22.6 N-m (200 in-lb) | 19.66 mm (.774") | 1/4" 5/16" | 30-40 lb-in 40-50 lb-in |
| 200 | LFJ102001STST | 20 kA | 7.3 N-m (65 in-lb) | 22.6 N-m (200 in-lb) | 19.66 mm (.774") | | |
| 400 | LFJ104001STST | 10 kA | 19.2 N-m (170 in-lb) | 22.6 N-m (200 in-lb) | 14.10 mm (.555") | | |
| 450 | LFJ104501STST | 20 kA | 33.9 N-m (300 in-lb) | 33.9 N-m (300 in-lb) | 14.48 mm (.570") | | |

Specifications

| | |
|----------------------------|--|
| Voltage Ratings | 1000 VDC |
| Ampere Ratings | 100 A, 200 A, 400 A, 450 A |
| Flammability Rating | UL94 V-0 |
| Termination Type | Box Lug |
| Base Temp Rating | 130° C |
| Approvals | UL 4248-18 Listed File No. E345481 Vol. 1 RoHS Compliant |
| Environmental | |

Recommended Fuses

| | |
|-------------------------|----|
| SPFJ Solar Series | 61 |
|-------------------------|----|

Web Resources

Sample requests, downloadable CAD drawings, dimensions and other technical information:

www.littelfuse.com/fuseblocks

For a comprehensive overview of solar market solutions, visit: www.littelfuse.com/solar



Look for this logo to indicate products that are used in solar applications. Visit our website www.littelfuse.com/solar for the latest updates on approvals, certifications, and new products.

LF SERIES SOLAR FUSE BLOCK

1000 VDC

Dimensions mm (inches)

1000 V 200 A

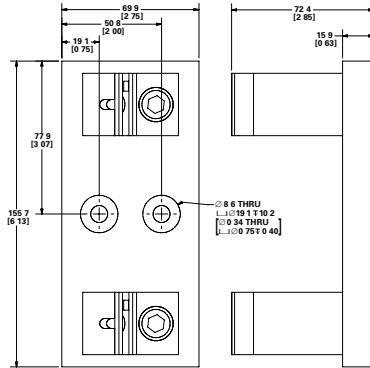

1000 V 400 A

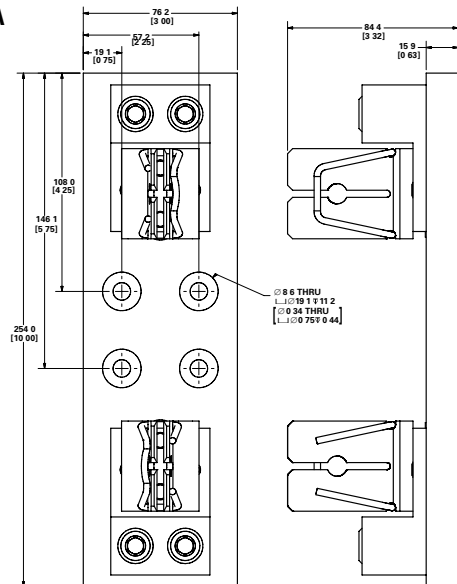

1000 V 450 A

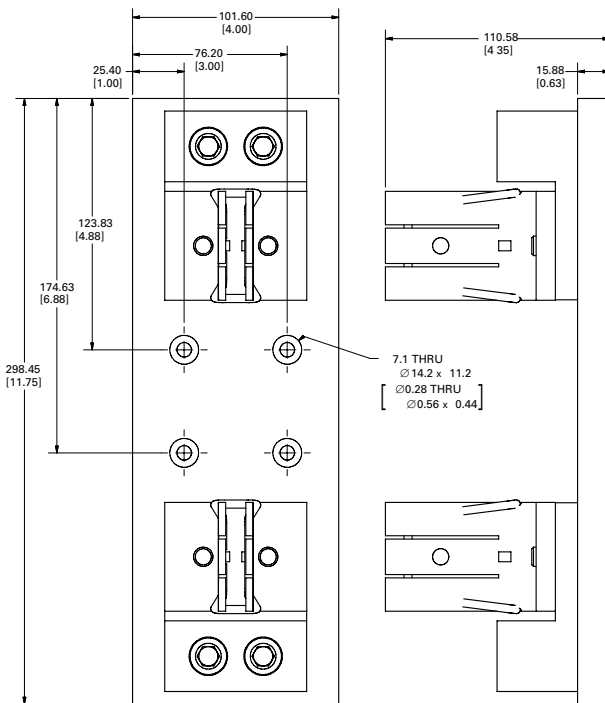

Look for this logo to indicate products that are used in solar applications. Visit our website www.littelfuse.com/solar for the latest updates on approvals, certifications, and new products.

LF SERIES SOLAR FUSE BLOCK

1000 VDC

Dimensions mm (inches)

Stud-Mounted 1000 V 100 A

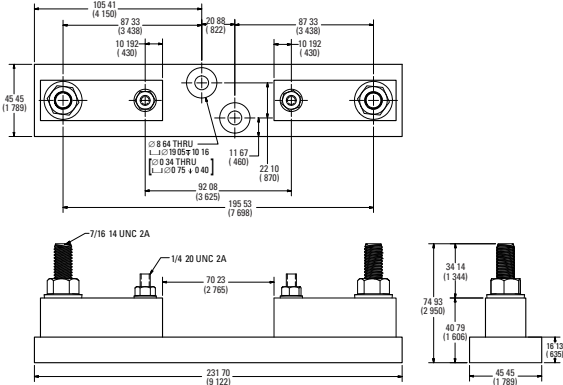

Stud-Mounted 1000 V 200 A

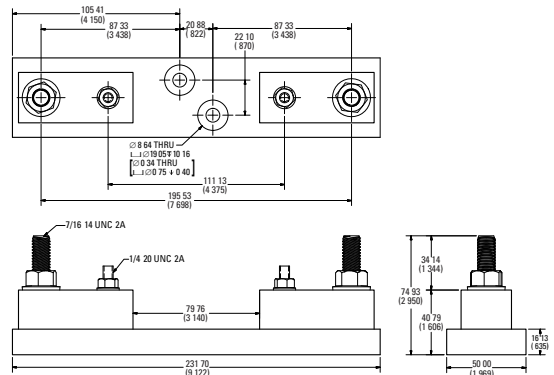

Stud-Mounted 1000 V 400 A

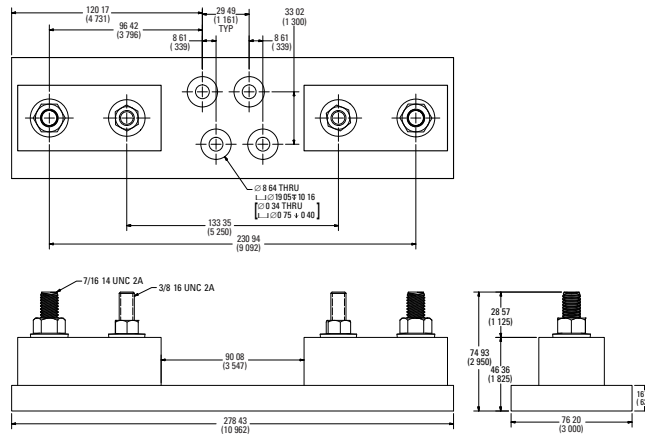

Stud-Mounted 1000 V 450 A

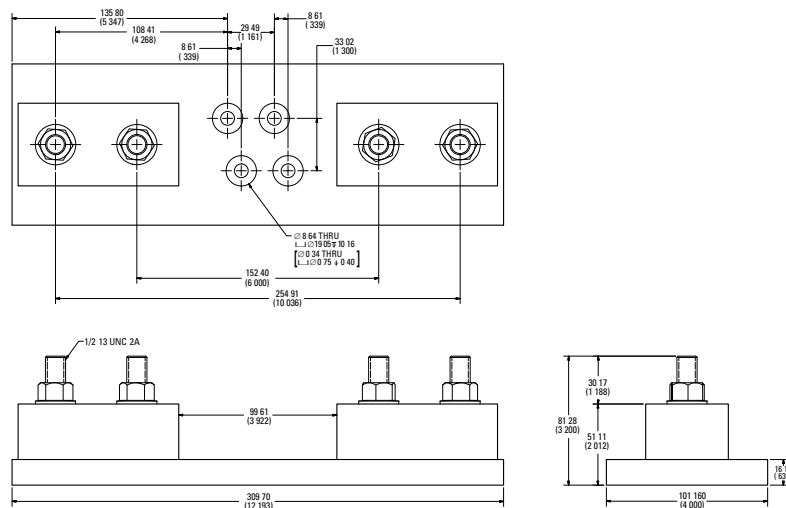

Look for this logo to indicate products that are used in solar applications. Visit our website www.littelfuse.com/solar for the latest updates on approvals, certifications, and new products.

UP-LINK™ REMOTE INDICATION FUSE HOLDER

600 V



Description

The Littelfuse Up-LINK remote indicating fuse holder can be easily integrated with a PLC to offer remote notification when a fuse has opened. Accompanied with local LED indication, this reduces downtime by allowing instant communication and helping plant and maintenance personnel to quickly fix the problem.

Features/Benefits

- Cost effective solution for remote blown-fuse indication
- Easily integrates with an existing PLC or system
- Utilizes reliable solid state circuitry
- Meets stringent IEC and UL Touch-Safe Standards to improve worker safety

Web Resources

Training videos, downloadable CAD drawings, industry downtime reports and other technical information:

www.littelfuse.com/up-link

Recommended Fuses

| | |
|---------------------------------|----|
| Class CC | 29 |
| Midget-Style (10 x 38 mm) | 32 |

Dimensions mm (inches)

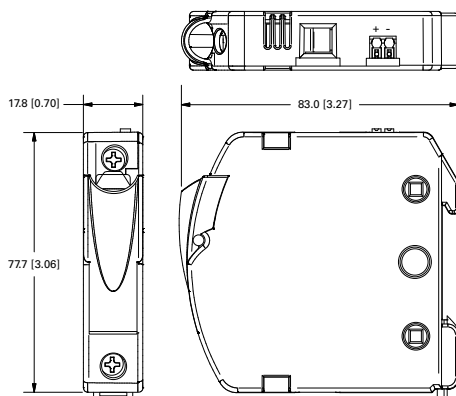

Specifications

| | |
|----------------------------|--|
| Voltage Rating | 600 VAC/DC |
| Amperage | 30 A max |
| SCCR | 200 kA AC (Class CC) 20 kA DC 100 kA (KLK Midget) |
| Terminal Type | Pressure Plate |
| Terminal Torque | 17.7 in-lbs |
| Wire Range | #8–#14 CU Stranded #10–#14 CU Solid |
| Flammability Rating | UL94 V-0 |
| Approvals | Class CC: UL Listed (File No. E14721) Midget: UL Recognized (File No. E14721) CSA Certified (File No. LR 7316) |

Remote Indicating Circuit

| | |
|--|---------------------------|
| Output (open fuse) | Open Collector |
| Max Current Sink | 25 mA (28 VDC Max) |
| Terminals | Push In |
| Wire Range | #16–#24 CU Solid/Stranded |
| Suggested Insulation Strip Length | 8 mm (0.31 in) |

Ordering Information

| POLES | PART NUMBER | ORDERING NUMBER |
|-------------------|-------------|-----------------|
| CLASS CC | | |
| 1 | LINK001C | LINK001C.Z |
| 2 | LINK002C | LINK002C.Z |
| 3 | LINK003C | LINK003C.Z |
| MIDGET 10 X 38 mm | | |
| 1 | LINK001M | LINK001M.Z |
| 2 | LINK002M | LINK002M.Z |
| 3 | LINK003M | LINK003M.Z |

Quick-Link Daisy Chain Connector

Littelfuse Quick-LINK daisy chain connectors provide optimal utilization of multiple Up-LINK remote indicating fuse holders when integrated with a PLC. These products are used to daisy chain multiple Up-LINK units together and reduce the number of PLC I/O ports required.

Ordering Information

| POLES | TYPE | ORDERING NUMBER |
|-------|----------|-----------------|
| 3 | Base | QLINK3B.Z |
| 9 | Extender | QLINK9E.Z |



LPSC / LPSM POWR-SAFE FUSE HOLDERS

600 V



Description

Littelfuse POWR-SAFE Dead Front holders provide optimum protection to personnel for Class CC and Midget-Style fuses.

Dimensions Inches (mm)

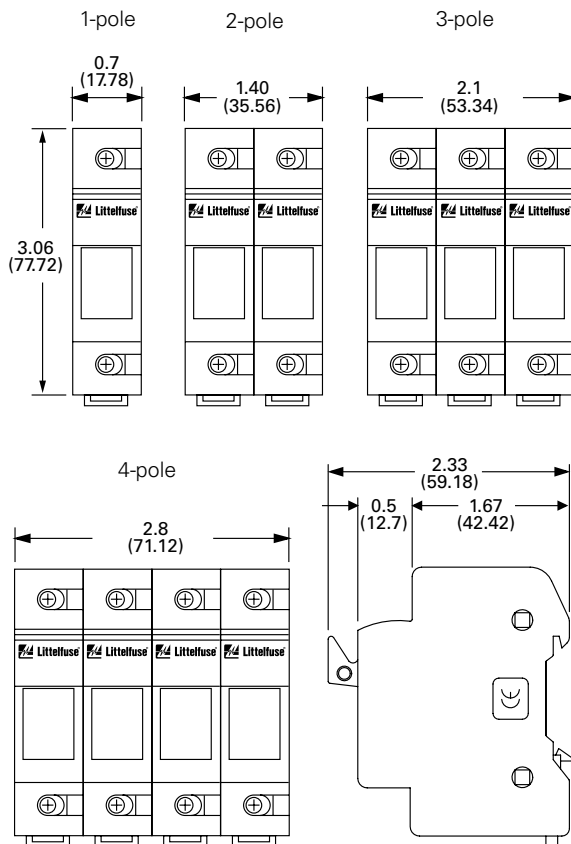

Features/Benefits

- Indicating and non-indicating options available
- 1-, 2-, 3- and 4-pole configurations
- Easy installation and fuse removal with no additional pullers or tools required
- 35 mm DIN Rail Mountable
- Ventilated design for cooler operation

Specifications

| | |
|----------------------------|---|
| Voltage Rating | 600 VAC/DC |
| Ampere Rating | 30 A |
| Interrupting Rating | 200 kA (Class CC) 100 kA (Midget) |
| Terminal Type | Pressure plate |
| Suggested Torque | 17.7 in-lbs |
| Wire Range | #8–#14 CU |
| Material | Thermoplastic |
| Flammability Rating | UL94 V-0 |
| Approvals | UL Listed (LPSC File No. E14721) UL Recognized (LPSM File No. E14721) CSA Certified (LPSC/LPSM File No. LR7316) |
| Environmental | RoHS compliant |

Ordering Information

| INDICATING CATALOG/ORDERING# | NON-INDICATING CATALOG/ORDERING# | FUSE TYPE | POLES | | |
|------------------------------|----------------------------------|-----------|-----------|----------|---|
| LPSC001ID | LPSC0001ZXID | LPSC001 | LPSC0001Z | Class CC | 1 |
| LPSC002ID | LPSC0002ZXID | LPSC002 | LPSC0002Z | Class CC | 2 |
| LPSC003ID | LPSC0003ZXID | LPSC003 | LPSC0003Z | Class CC | 3 |
| LPSC004ID | LPSC0004ZXID | LPSC004 | LPSC0004Z | Class CC | 4 |
| LPSM001ID | LPSM0001ZXID | LPSM001 | LPSM0001Z | Midget | 1 |
| LPSM002ID | LPSM0002ZXID | LPSM002 | LPSM0002Z | Midget | 2 |
| LPSM003ID | LPSM0003ZXID | LPSM003 | LPSM0003Z | Midget | 3 |
| LPSM004ID | LPSM0004ZXID | LPSM004 | LPSM0004Z | Midget | 4 |

Multi-pole Assembly Kit Ordering No. CYHP001
(Kit contains 20 connector pincers & 10 handle pins.)
Pincer: CYHP002
Pin: CYHP003

Web Resources

Sample requests, downloadable CAD drawings and other technical information: www.littelfuse.com/lpsc
www.littelfuse.com/lpsm

Recommended Fuses

| | |
|---------------------------------|----|
| Class CC | 29 |
| Midget-Style (10 x 38 mm) | 32 |

LPHV POWR-SAFE FUSE HOLDERS

1000 V



Description

The Littelfuse LPHV fuse holder is designed to house 1000 V SPF solar and FLU fuses. It is not designed for load break but is ideal for isolating photovoltaic module strings for maintenance and meets UL requirements for 1000 V solar fuse protection.

Dimensions Inches (mm)

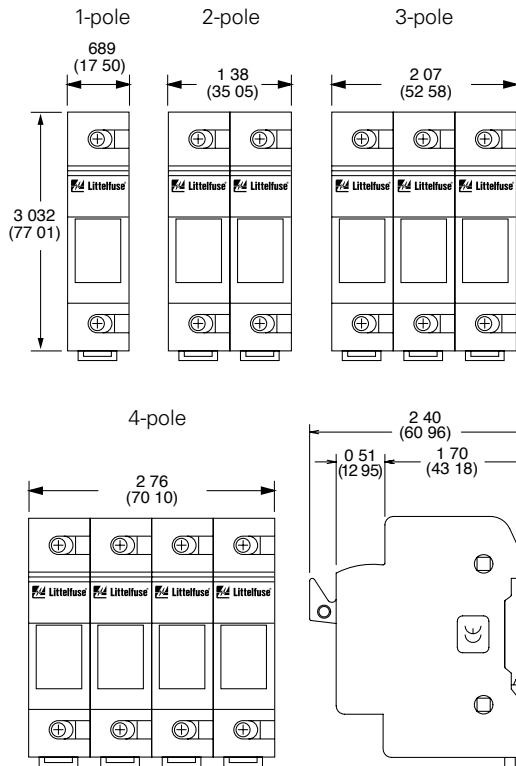

Features/Benefits

- Touch-safe design offers protection when replacing fuses
- Compact design
- 35 mm DIN Rail Mountable
- Available in 1-, 2-, 3- and 4-pole configurations
- No fuse pullers or tools required for fuse removal

Specifications

| | |
|----------------------------|---------------------------------------|
| Voltage Ratings | 1000 VDC |
| Amperage Rating | 30 A |
| SCCR Rating | 20 kA |
| Terminal Type | Pressure Plate |
| Wire Range | #8 - 14 CU 75 C |
| Terminal Torque | 17.7 in-lbs |
| Power Dissipation | 4 W Maximum |
| Fuse Type | SPF and FLU midget (10 X 38 mm) |
| Material | Thermoplastic |
| Flammability Rating | UL94 V-0 |
| Approval | Self-certified with SPF and FLU fuses |
| Environmental | RoHS compliant, Lead (Pb) Free |

Ordering Information

| LPHV (1000 VDC) | | |
|-----------------|----------------|-----------------|
| POLES | CATALOG NUMBER | ORDERING NUMBER |
| 1 | LPHV001 | LPHV0001Z |
| 2 | LPHV002 | LPHV0002Z |
| 3 | LPHV003 | LPHV0003Z |
| 4 | LPHV004 | LPHV0004Z |

Multi-pole assembly kit Ordering No. CYHP001
(Kit contains 20 connector pincers & 10 handle pins.)
Pincer: CYHP002
Pin: CYHP003

Web Resources

Sample requests, downloadable CAD drawings and other technical information: www.littelfuse.com/lphv

More information about solar applications and fuse holder details: www.littelfuse.com/solar

Recommended Fuses

| | |
|------------------------|----|
| 1000 VDC SPF Fuses | 60 |
| 1000 VAC/VDC FLU Fuses | 33 |



Look for this logo to indicate products that are used in solar applications. Visit our website www.littelfuse.com/solar for the latest updates on approvals, certifications, and new products.

BUS BAR SYSTEM

POWR-BAR Distribution



Description

A key objective for panel designers is safe distribution of power to multiple fuse holders in a compact design. The Littelfuse UL508 bus bar system eliminates most wire terminations in a timesaving package. A power distribution block and associated conductors are no longer needed to feed multiple POWR-SAFE fuse holders.

Features/Benefits

- Touch-safe design offers protection when replacing fuses
- Compact design
- 35 mm DIN Rail Mountable
- Available in one and three phase configurations
- No fuse pullers or tools required for fuse removal
- Can be cut down to optimal size

Recommended Fuse Holders

| | |
|--------------------|-----|
| LPSM (600 V)..... | 108 |
| LPSC (600 V)..... | 108 |
| LPHV (1000 V)..... | 109 |

Web Resources

Downloadable CAD drawings and other technical information: www.littelfuse.com/busbar

Accessories

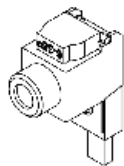

Power Feed Lug

| | |
|----------------------|----------------------|
| Part Number | BB18 |
| Ampere Rating | 115 A |
| Wire | #10 – 1/0 AWG copper |
| Torque | 50 lb-in |

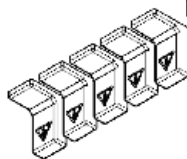

Pole Protective Covers

| | |
|--------------------|-------|
| Part Number | CTPT5 |
| 5 covers | |

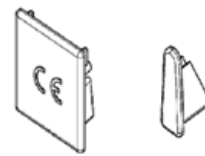

Endcaps

| | | | |
|---------------------|--------|------------------|--------------|
| Part Number: | EDCP42 | for Single Phase | 50 piece bag |
| Part Number: | EDCP7 | for Three Phase | 50 piece bag |

Specifications

Voltage Ratings 600 VAC/DC
1000 VDC*

Current Ratings

| CROSS SECTION (mm ²) | 18 mm ² | 25 mm ² |
|----------------------------------|--------------------|--------------------|
| END FED | 80 A | 100 A |
| CENTER FED | 160 A | 200 A |

SCCR 10 kA, 100 kA[†]
Conductor Copper
Pitch 17.8 mm
Approvals UL508 File E328654
Environmentals RoHS Compliant, Lead (Pb) free

*1 Phase 18 mm² rated 1000 VDC up to 160 A when center fed
 1 Phase 25 mm² rated 1000 VDC up to 200 A when center fed
[†]When protected directly upstream by Class J 175 amperes max (18 mm² bus bar) and Class J 200 amperes max (25 mm² bus bar).

Ordering Information

| 1 PHASE, 18 mm ² | | LENGTH (mm) | 1 PHASE, 25 mm ² | | LENGTH (mm) |
|-----------------------------|-------|-------------|-----------------------------|-------|-------------|
| ORDERING NUMBER | POLES | | ORDERING NUMBER | POLES | |
| 1PH3P18mm | 3 | 50 | 1PH3P25mm | 3 | 50 |
| 1PH6P18mm | 6 | 104 | 1PH6P25mm | 6 | 104 |
| 1PH9P18mm | 9 | 155 | 1PH9P25mm | 9 | 155 |
| 1PH12P18mm | 12 | 208 | 1PH12P25mm | 12 | 208 |
| 1PH15P18mm | 15 | 270 | 1PH15P25mm | 15 | 270 |
| 1PH57P18mm | 57 | 1009 | 1PH57P25mm | 57 | 1009 |

| 3 PHASE, 18 mm ² | | LENGTH (mm) | 3 PHASE, 25 mm ² | | LENGTH (mm) |
|-----------------------------|-------|-------------|-----------------------------|-------|-------------|
| ORDERING NUMBER | POLES | | ORDERING NUMBER | POLES | |
| 3PH6P18mm | 6 | 104 | 3PH6P25mm | 6 | 104 |
| 3PH9P18mm | 6 | 158 | 3PH9P25mm | 9 | 158 |
| 3PH12P18mm | 12 | 214 | 3PH12P25mm | 12 | 214 |
| 3PH15P18mm | 15 | 266 | 3PH15P25mm | 15 | 266 |
| 3PH57P18mm | 57 | 1009 | 3PH57P25mm | 57 | 1009 |

End caps are standard with all 3 phase configurations except 57-pole meter length. End caps aren't needed for the 1 phase configurations from the factory or if the copper bus is trimmed per the supplied instructions. Power feed lugs and protective covers are extra.

LPSM QUICK CONNECT POWR-SAFE FUSE HOLDERS



Description

The LPSM midget fuse holder series is a dead front design providing protection to personnel when installing and removing fuses. The compact fuse holder mounts quickly onto 35 mm DIN rail, decreasing panel layout and assembly time. This product has two Quick Connect terminals on both the top and bottom of the holder, offering an additional connection option. It is available in 1-, 2-, 3- and 4-pole configurations.

Features/Benefits

- Dual 1/4" Quick Connect Terminals on Top and Bottom of Holder
- Meets Dead Front requirements
- Mountable on 35 mm DIN Rail
- Local LED Indication

Dimensions mm (inches)

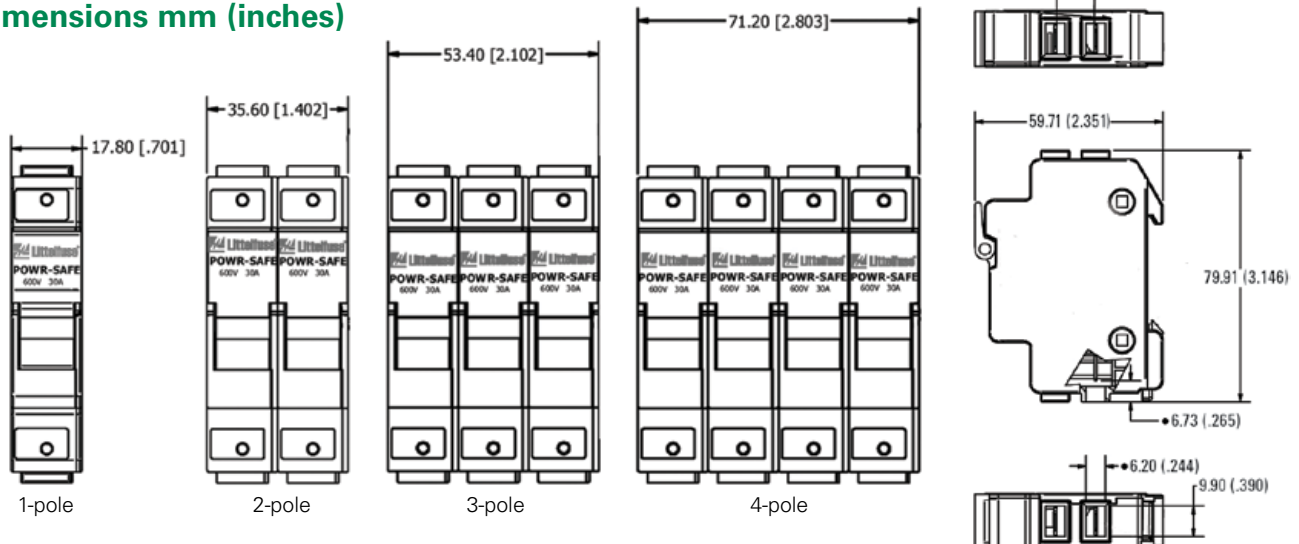

Specifications

| | |
|----------------------------|---|
| Voltage Rating | 600 VAC/DC |
| Amperage Rating | 30 A |
| Approval | UL Recognized (File No. E14721), CSA Certified (File No. LR7316), CCC Approved |
| Terminal Type | 1/4" Quick Connect Terminals |
| Fuse Type | Midget (10 X 38 mm) series |
| Material | Thermoplastic |
| Flammability Rating | UL94 V-0 |
| SCCR Rating | Same as Fuse Rating |

Ordering Information

| POLES | CATALOG NUMBER | ORDERING NUMBER |
|-------|----------------|-----------------|
| 1 | LPSM001QCID | LPSM0001ZQCID |
| 2 | LPSM002QCID | LPSM0002ZQCID |
| 3 | LPSM003QCID | LPSM0003ZQCID |
| 4 | LPSM004QCID | LPSM0004ZQCID |

Recommended Fuses

Midget-Style32

Web Resources

Sample requests, downloadable CAD drawings and other technical information: www.littelfuse.com/lpsmqc

Multi-pole Assembly Kit

Assembly kit is designed for use with LPSC/LPSM fuse holders. Kit contains 20 connector pincers and 10 handle pins.



Part No: CYHP001

LFPHV TOUCH-SAFE FUSE HOLDERS

1000 V

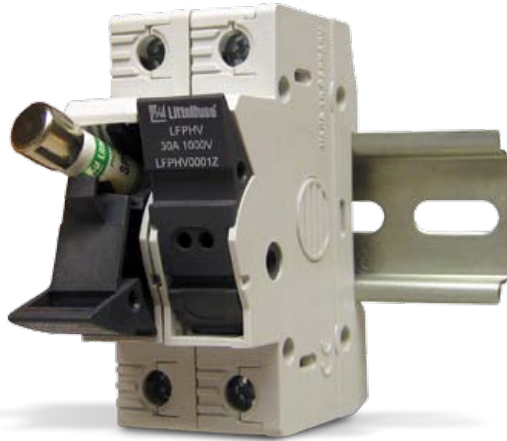

Description

The Littelfuse LFPHV fuse holder is designed to house 1000 V SPF solar and FLU 10 x 38 mm fuses. It is not designed for load break but is ideal for isolating photovoltaic module strings for maintenance and meets UL requirements for 1000 V solar fuse protection.

Dimensions Inches (mm)

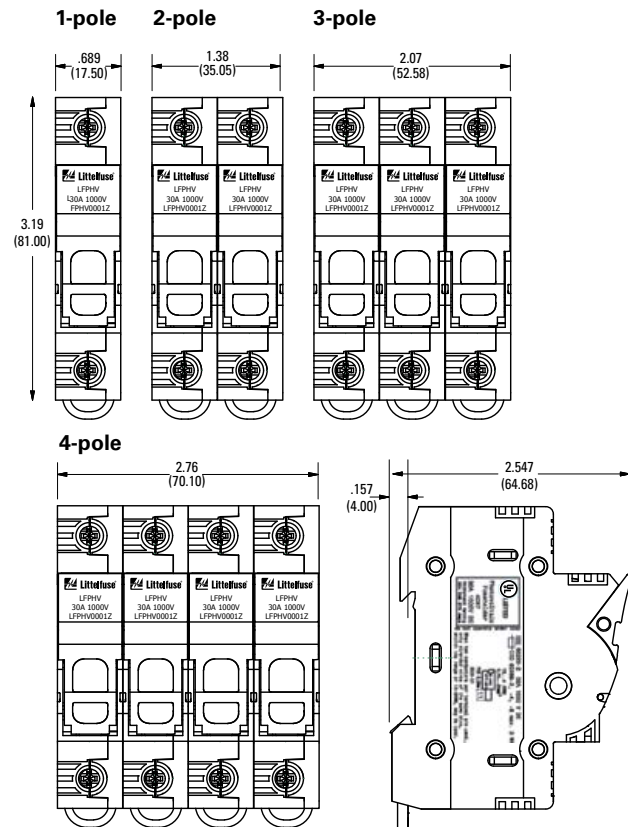

Features/Benefits

- Touch-safe design offers protection when replacing fuses
- Compact design
- 35 mm DIN Rail Mountable
- Available in 1-, 2-, 3- and 4-pole configurations
- No fuse pullers or tools required for fuse removal
- Indication option available

Specifications

| | |
|--------------------------|---------------------------------|
| Voltage Ratings | 1000 VDC |
| Amperage Rating | 30 A |
| SCCR Rating | 33 kA |
| Terminal Type | Pressure Plate |
| Power Dissipation | 3 W Maximum |
| Fuse Type | SPF and FLU midget (10 X 38 mm) |
| Material | Thermoplastic |
| Approval | UL Listed (File No. E345481) |

Environmental

IEC 60269-1* IEC 60269-4*
IEC 60269-2* IEC 60269-6*
*with VDE verification
RoHS compliant, Lead (Pb) free

| TERMINAL TORQUE | | | |
|-----------------|-------------|--------------|----------------------------|
| NUMBER OF WIRES | WIRE TYPE | WIRE SIZE | TORQUE |
| 1 | 90° Cu Only | 18 AWG-8 AWG | 18-22 lb-in/ 2.03-2.49 N-m |
| 1 | 90° Cu Only | 4 AWG-6 AWG | 22-26 lb-in/ 2.49-2.94 N-m |
| 2† | 90° Cu Only | 18 AWG-8 AWG | 18-22 lb-in/ 2.03-2.49 N-m |

†Must be the same cross-sectioned size

Ordering Information

| CATALOG NUMBER | ORDERING NUMBER | POLES | PACK QTY | INDICATION |
|----------------|-----------------|-------|----------|------------|
| LFPHV001 | LFPHV0001Z | 1 | 12 | – |
| LFPHV002 | LFPHV0002Z | 2 | 6 | – |
| LFPHV003 | LFPHV0003Z | 3 | 4 | – |
| LFPHV004 | LFPHV0004Z | 4 | 3 | – |
| LFPHV001ID | LFPHV0001ZXID | 1 | 12 | • |
| LFPHV002ID | LFPHV0002ZXID | 2 | 6 | • |
| LFPHV003ID | LFPHV0003ZXID | 3 | 4 | • |
| LFPHV004ID | LFPHV0004ZXID | 4 | 3 | • |

Web Resources

Sample requests, downloadable CAD drawings and other technical information: www.littelfuse.com/lfpvh

More information about solar applications and fuse holder details: www.littelfuse.com/solar

Recommended Fuses

| | |
|-----------------------------|----|
| 1000 VDC SPF Fuses..... | 60 |
| 1000 VAC/VDC FLU Fuses..... | 33 |



Look for this logo to indicate products that are used in solar applications. Visit our website www.littelfuse.com/solar for the latest updates on approvals, certifications, and new products.

LFPSJ DEAD FRONT CLASS J POWR-SAFE FUSE HOLDERS

600 V



Description

Littelfuse Class J POWR-SAFE Dead Front holders provide optimum protection to personnel and are UL Listed.

Features

- Indicating and non-indicating options available
- Dual LED indication distinguishes polarity in DC power applications
- Small compact design offers ultimate flexibility
- 35mm DIN Rail Mountable
- 1-, 2-, and 3-pole configurations
- Easy installation and fuse removal with no additional pullers or tools required

Dimensions Inches (mm)

30 Amp

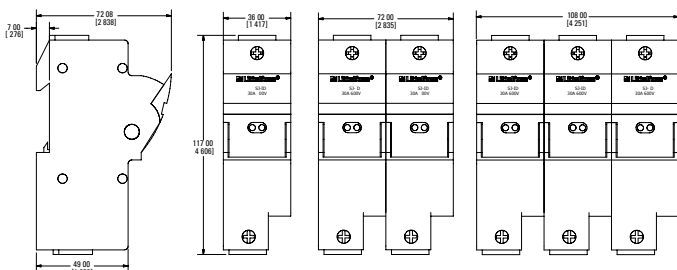

60 Amp

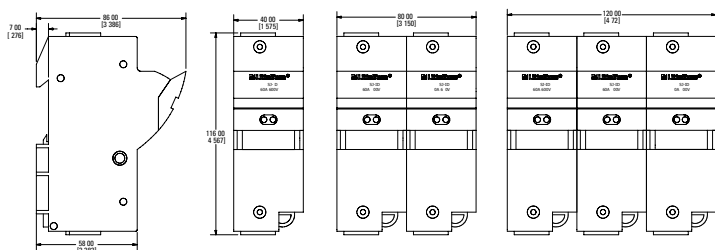

Note: These dimensions are for reference only. Please contact factory for additional information.

Specifications

| | |
|----------------------------|-----------------------------|
| Voltage Ratings | 600 VAC/VDC |
| Interrupting Rating | 200 kA |
| Ampere Rating | 30 and 60 A |
| LEDs | 110 V – 600 V |
| Terminal Type | Pressure Plate |
| Material | Thermoplastic |
| Flammability Rating | UL94 V-0 |
| Terminal Screws | Phillips / Slotted |
| Approvals | UL Listed (File No. E14721) |

Ordering Information

| AMPERE RATING | POLES | INDICATION | ORDERING NUMBER | PACK QTY. | WIRE RANGE | TORQUE |
|---------------|-------|------------|-----------------|-----------|--|--------------------------------|
| 30 A | 1 | – | LFPSJ301.Z | 6 | 0.75mm ² – 1mm ² 1.5mm ² – 50mm ² 18 – 1 AWG | 2.5 N-m 4.0 N-m 35 lb-in |
| | 2 | – | LFPSJ302.Z | 3 | | |
| | 3 | – | LFPSJ303.Z | 2 | | |
| 30 A | 1 | • | LFPSJ301.ZXID | 6 | | |
| | 2 | • | LFPSJ302.ZXID | 3 | | |
| | 3 | • | LFPSJ303.ZXID | 2 | | |
| 60 A | 1 | – | LFPSJ601.Z | 6 | 2.5mm ² – 50mm ² 14 – 1 AWG | 4.0 N-m 35 lb-in |
| | 2 | – | LFPSJ602.Z | 3 | | |
| | 3 | – | LFPSJ603.Z | 2 | | |
| 60 A | 1 | • | LFPSJ601.ZXID | 6 | | |
| | 2 | • | LFPSJ602.ZXID | 3 | | |
| | 3 | • | LFPSJ603.ZXID | 2 | | |

Multi-Pole Assembly Kit

- US3J2PAK to assemble two LFPSJ301.Z
- US3J3PAK to assemble three LFPSJ301.Z
- US6J2PAK to assemble two LFPSJ601.Z
- US6J3PAK to assemble three LFPSJ601.Z

Web Resources

Sample requests, downloadable CAD drawings and other technical information: www.littelfuse.com/lfpsj

Recommended Fuses

Class J23

FUSE PULLERS & POWR-JAW CLIP CLAMPS

MFP • LPFP • GFP • 097023



Features/Benefits

- Ergonomically designed fuse pullers designed to safely remove power fuses
- Molded design offers more comfortable and natural grip than traditional pullers, increasing performance

Specifications

| TYPE OF FUSE PULLER | PART NUMBER | FUSE SIZE (DIAMETER) |
|---------------------|-------------|--|
| Midget Fuse | MFP | 3/16" - 1/2" fuses |
| Pocket Fuse | LPFP | 250 V fuses from 0-200 A 600 V fuses from 0-100 A 9/16" - 1 19/32" fuses |
| Giant Fuse | GFP | 250 V fuses from 61-600 A 600 V fuses from 61-400 A 1 1/16" - 2 19/32" fuses |
| Tri-puller | 097023 | For ATO and glass fuses |

Web Resources

Sample requests and other technical information:
www.littelfuse.com/fusepullers

LCC Series POWR-JAW



Features/Benefits

- Improve contact between fuse and clip
- Help prevent unnecessary heat from poor contact due to the loss of spring force. This reduces:
 1. Nuisance fuse opening
 2. Premature aging of surrounding components
- High temperature phenolic resin knob for severe environments
- Wide range of coverage with simple design

Ordering Information

| CATALOG NUMBER | ORDERING NUMBER | VOLTS | AMPERES |
|----------------|-----------------|------------|---------|
| LCC1 | 0LCC1 | 250 | 0-30 |
| LCC2 | 0LCC2 | 250 | 35-60 |
| LCC2 | 0LCC2 | 600 | 0-30 |
| LCC4 | 0LCC4 | 600 | 35-60 |
| LCC5 | 0LCC5 | 250 or 600 | 70-100 |
| LCC6 | 0LCC6 | 250 or 600 | 110-200 |
| LCC7 | 0LCC7 | 250 or 600 | 225-400 |
| LCC8 | 0LCC8 | 250 or 600 | 450-600 |

*Note: POWR-JAW Clip Clamps are sold individually, not in pairs.
A minimum of 1/8" of clearance between the fuse block barrier and fuse clip is required to install Clip Clamps.*

Web Resources

Sample requests and other technical information:
www.littelfuse.com/clipclamps

3AG OMNI BLOCK®

354 OMNI-BLOK (Molded Base Type Fuse Block)



Dimensions Inches

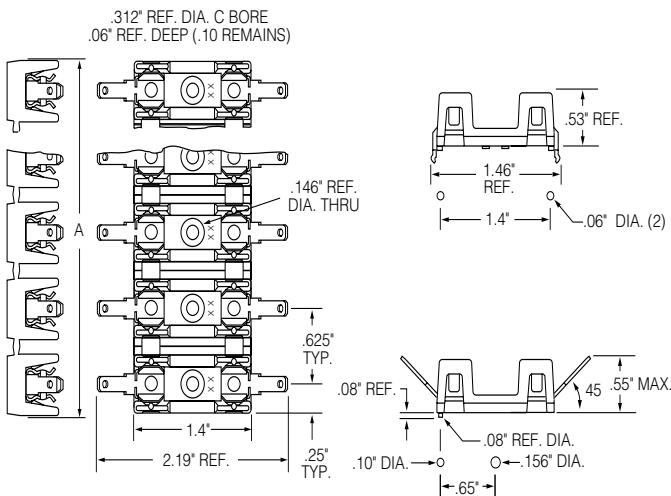

Description

A low profile fuse block featuring individual barriers that reinforce the fuse clips while providing greater protection against clip damage and electrical shock. The unique design permits self-alignment of clips to fuse cap. This, plus a one-piece clip/terminal, assures low contact resistance.

Specifications

- Dielectric Strength** 1500 V Minimum
- Clip/Terminals** Tin-Plated Spring Brass; two different style clips can be supplied for circuit identity or polarization
- Base** Glass reinforced Thermoplastic:
Gray except anti-rotation series which is black
- Flammability Rating** UL94 V-0
- Ambient Temperature** -40°C to +85°C

Ordering Information

| CATALOG NUMBER | TERMINALS | VOLTAGE | CURRENT RATING | |
|----------------|------------|---------|----------------|------|
| | | | UL | CSA |
| 354 000 | Solder | 300 V* | 30 A | 30 A |
| 354 600 | 3/16" Q.C. | 300 V | 20 A | 20 A |
| 354 800 | 1/4" Q.C. | 300 V | 20 A | 20 A |
| 354 900 | 1/4" Q.C. | 300 V | 30 A | 25 A |
| 354 101-GY | P.C. Board | 300 V | 15 A | 15 A |

*30 A capability is based on temperature rise with #10 AWG wire properly soldered.

Recommended Fuses

3AG Cartridge36

Web Resources

For additional technical information visit:
www.littelfuse.com

Technical Information

| SOLDER TYPE TERMINALS | 3/16" Q.C. TERMINALS† | 1/4" Q.C. TERMINALS | 1/4" Q.C. TERMINALS† | POLES | DIM "A" |
|-----------------------|-----------------------|---------------------|----------------------|-------|---------|
| 354 001GY | 354 601GY | 354 801GY | 354 901GY | 1 | .50" |
| 354 002GY | 354 602GY | 354 802GY | 354 902GY | 2 | 1.12" |
| 354 003GY | 354 603GY | 354 803GY | 354 903GY | 3 | 1.75" |
| 354 004 GY | 354 604GY | 354 804GY | 354 904GY | 4 | 2.38" |
| 354 005GY | 354 605GY | 354 805GY | 354 905GY | 5 | 3.00" |
| 354 006GY | 354 606GY | 354 806GY | 354 906GY | 6 | 3.63" |
| 354 007GY | 354 607GY | 354 807GY | 354 907GY | 7 | 4.25" |
| 354 008GY | 354 608GY | 354 808GY | 354 908GY | 8 | 4.88" |
| 354 009GY | 354 609GY | 354 809GY | 354 909GY | 9 | 5.50" |
| 354 010GY | 354 610GY | 354 810GY | 354 910GY | 10 | 6.13" |
| 354 011GY | 354 611GY | 354 811GY | 354 911GY | 11 | 6.75" |
| 354 012GY | 354 612GY | 354 812GY | 354 912GY | 12 | 7.38" |
| 354 021BL* | 354 621BL* | 354 821BL* | 354 921BL* | 1 | .50" |
| 354 101GY | — | — | — | 1 | .50" |

† NEMA style
* With Anti-Rotation Boss"

LFFB SERIES LIMITER BLOCK/LHFB INLINE HOLDER

LFFB



Dimensions mm (inches)

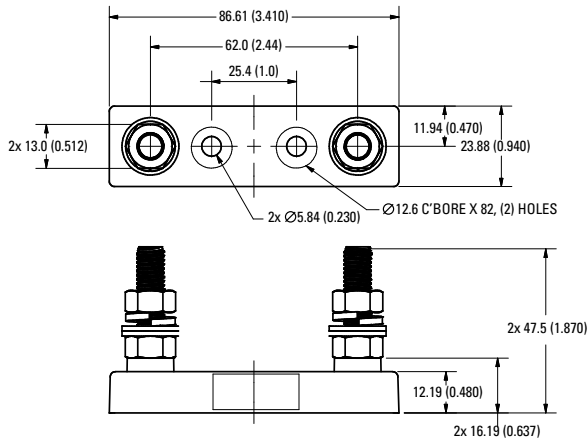

Description

The LFFB003 fuse block is designed to accept CNN and CNL style limiter fuses. Applications include but are not limited to forklifts, golf carts and other low-voltage battery equipment. It is specifically designed for the HAZGARD™ fuse but can be used for CNN/CNL fuses as well.

Specifications

| | |
|-----------------------|---|
| Voltage Rating | 150 VAC/VDC |
| Ampere Rating | 800 A |
| Approvals | UL Recognized (File No. E14721) |
| Construction | Base—Thermoset Studs—Steel Zinc Plated |

Ordering Information

| CATALOG NUMBER | ORDERING NUMBER |
|----------------|-----------------|
| LFFB003 | LFFB0003Z |

Web Resources

Sample requests, downloadable CAD drawings and other technical information: www.littelfuse.com/lffb

Recommended Fuses

| | |
|-----------------------------------|----|
| CNL/CNN Cable limiter fuses | 62 |
| HAZGARD fuse..... | 62 |

LHFB



Description

The Littelfuse LHFB waterproof in-line fuse holder is ideal for harsh environments. The LHFB holder features the voltage and ampere rating molded into the body, along with a wire strip gauge. It also withstands solvents and vibration.

Features/Benefits

- Waterproof in-line fuse holder for harsh environments
- One-piece molded thermoplastic body
- Bright green color offers high visibility
- Voltage and ampere rating molded into body

Specifications

| | |
|------------------------------|-------------------------------|
| Voltage Rating | 32 V |
| Ampere Rating | 30 A |
| Fuses | 1/4" to 1 1/4" fuses |
| Wire Size | Accepts #16 to #18 gauge wire |
| Operating Temperature | -20° C to 80° C |

Installation Instructions

1. Thread wire through fuse holder body
2. Strip wire insulation per strip gauge
3. Crimp wire to fuse clip*
4. Pull wire through and seat fuse clip in the holder body
5. Insert desired fuse type and rating
6. Snap holder body together

*Recommended crimping tools: Thomas & Betts No. WT-111M
Note: Wire is not supplied with the holder.

Web Resources

Sample requests, downloadable CAD drawings and other technical information: www.littelfuse.com/lhfb

571 & 572 SERIES PANEL-MOUNT FUSE HOLDERS

571



Description

Panel mount fuse holders are for Midget-Style and Class CC fuses. Class CC fuses have a rejection feature on one end cap, which mates with the rejection feature of Littelfuse Class CC fuses holders to prevent the installation of fuses with lower voltage ratings or interrupting ratings. Watertight version must be front panel mounted.

Dimensions Inches (mm)

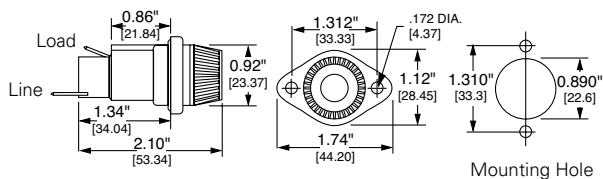

Ordering Information

| CATALOG/ORDERING NUMBER | | | | BOTTOM TERMINAL | FUSE LENGTH RANGE* | FOR USE WITH |
|-------------------------|------------|---------|-------------|-----------------|---|----------------|
| STANDARD | WATERTIGHT | | | | | |
| 571027 | 05710027L | 571027P | 05710027LXP | Straight | 1 ⁵ / ₁₆ " – 1 ³ / ₈ " | Midget Fuses |
| 571028 | 05710028L | 571028P | 05710028LXP | Rt. Angle | | |
| 571007 | 05710007L | 571007P | 05710007LXP | Straight | 1 ¹³ / ₃₂ " – 1 ¹ / ₂ " | Midget Fuses |
| 571008 | 05710008L | 571008P | 05710008LXP | Rt. Angle | | |
| 5710CC | 057100CCL | 5710CCP | 057100CCLXP | Straight | 1 ¹ / ₂ " | Class CC Fuses |
| 571RCC | 05710RCCL | 571RCCP | 05710RCCLXP | Rt. Angle | | |

*Fuse diameter is 13/32"

Note: Contact factory for versions with pre-assembled wire leads.

Specifications

| | |
|----------------------------|--|
| Voltage Rating | 600 V |
| Ampere Rating | 30 A for Class CC and Midget fuses |
| Dielectric Strength | 4000 V Minimum |
| Terminals | Tin-plated brass combination solder and quick-connect |
| O-Rings | 901-184 (body), 901-260 (knob) |
| Molded Parts | Black thermoplastic |
| Approvals | UL Recognized (File No. E14721) UL Recognized for branch circuit protection (5710CC/RCC) CSA Certified (File No. LR7316) |

Web Resources

Sample requests, downloadable CAD drawings and other technical information: www.littelfuse.com/571

572



Description

The 572 series panel mount fuse holders are designed to minimize installation time. Its unique design incorporates a snap-mount feature that allows the holder to be installed without any tools or mounting hardware.

Dimensions Inches (mm)

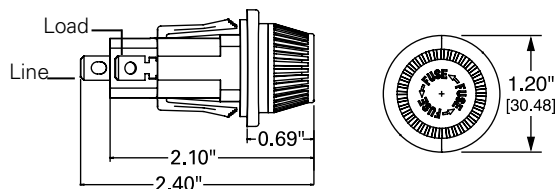

Ordering Information

| CATALOG/ORDERING NUMBER | | | | BOTTOM TERMINAL | FUSE LENGTH RANGE† | FOR USE WITH |
|-------------------------|------------|---------|-------------|-----------------|---|----------------|
| STANDARD | WATERTIGHT | | | | | |
| 572027 | 05720027L | 572027P | 05720027LXP | Straight | 1 ⁵ / ₁₆ " – 1 ³ / ₈ " | Midget Fuses |
| 572028 | 05720028L | 572028P | 05720028LXP | Rt. Angle | | |
| 572007 | 05720007L | 572007P | 05720007LXP | Straight | 1 ¹³ / ₃₂ " – 1 ¹ / ₂ " | Midget Fuses |
| 572008 | 05720008L | 572008P | 05720008LXP | Rt. Angle | | |
| 5720CC | 057200CCL | 5720CCP | 057200CCLXP | Straight | 1 ¹ / ₂ " | Class CC Fuses |
| 572RCC | 05720RCCL | 572RCCP | 05720RCCLXP | Rt. Angle | | |

†Fuse diameter is 13/32"

Note: Contact factory for versions with pre-assembled wire leads.

Specifications

| | |
|----------------------------|---|
| Voltage Rating | 600 V |
| Ampere Rating | 30 A for Class CC and Midget fuses |
| Dielectric Strength | 4000 V Minimum |
| Terminals | Tin-plated brass combination solder & quick-connect |
| Molded Parts | Black thermoplastic |
| Approvals | UL Recognized (File No. E14721) UL Recognized for branch circuit protection (5720CC/RCC) Class CC version CSA Certified (File No. LR7316) |
| Mounting | Double "D" punch Designed to fit 14-18 gauge |

Web Resources

Sample requests, downloadable CAD drawings and other technical information: www.littelfuse.com/572

PANEL MOUNT 3AG (1/4" X 1 1/4") FUSE HOLDERS

342 Series (Traditional Panel Mount Type)



Straight Terminal
Knurled Knob



Right Angle
Terminal
Fluted Knob

Description

Panel Mount Fuse holders for 3AG (1/4" x 1 1/4") fuses. Both fluted and knurled knob terminal options are available.

Ordering Information

Straight Terminal

| FLUTED KNOB | | KNURLED KNOB | | TERMINAL |
|-------------------------|-------------------------|-------------------------|-------------------------|------------|
| CATALOG/ORDERING NUMBER | CATALOG/ORDERING NUMBER | CATALOG/ORDERING NUMBER | CATALOG/ORDERING NUMBER | |
| 342014A | 03420014X | 342012A | 03420012X | Solder |
| 342038A | 03420038X | 342058A | 03420058X | 3/16" Q.C. |
| 342838A | 03420838X | 342858A | 03420858X | 1/4" Q.C. |

Straight Terminal

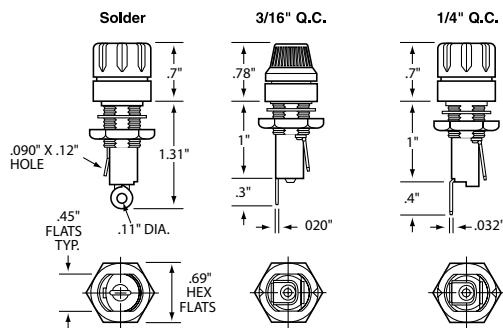

Dimensions in inches

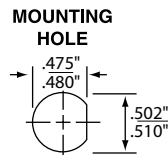

Right Angle Terminal

| FLUTED KNOB | | KNURLED KNOB | | TERMINAL |
|-------------------------|-------------------------|-------------------------|-------------------------|------------|
| CATALOG/ORDERING NUMBER | CATALOG/ORDERING NUMBER | CATALOG/ORDERING NUMBER | CATALOG/ORDERING NUMBER | |
| 342004 | 03420004X | 342022A | 03420022X | Solder |
| 342028A | 03420028X | 342048A | 03420048X | 3/16" Q.C. |
| 342828 | 03420828X | 342848 | 03420848X | 1/4" Q.C. |

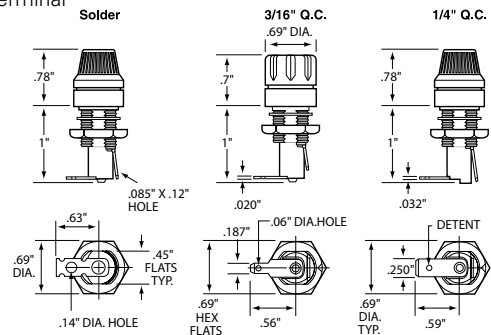

342 Series (Watertight Panel Mount Type)



Web Resources

Additional technical information available at:
www.littelfuse.com/342

Dimensions Inches

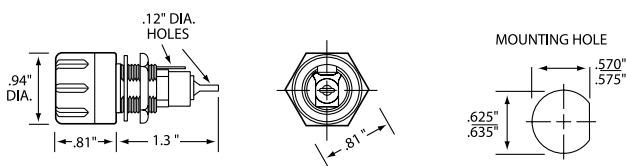

Specifications

Electrical Rated at 20 A for any voltage up to 250 V
Dielectric Strength 1500 V minimum
Mounting Withstands 15 lb-in mounting torque; maximum panel thickness is .250"
Molded Parts Black thermoset (UL94 V-0)
Knob Screw type
Seal O-ring provides a watertight seal on the front side of the panel per MIL-PRF-19207
Terminals Copper & copper alloy. Tin plated. Solder type
Ambient Temperature -40°C to +85°C
Hardware O-rings (2) and hex nut, unassembled

Ordering Information

| CATALOG NUMBER | ORDERING NUMBER |
|----------------|-----------------|
| 342006A | 0342006ZXA |

Recommended Fuses

3AG Cartridge36

INTERNATIONAL SHOCK SAFE PANEL MOUNT

345 Series (International Shock-Safe Panel Mount Type)



Description

Designed to eliminate electrical shock as defined by IEC standards 60065 and 60127, these panel-mount fuses holders offer a wide variety of options. This allows for inventory reduction and versatility.

Features/Benefits

- Anti-tease feature eliminates circuit interruption when knob is accidentally depressed
- Five fuse holder types for maximum flexibility
- Two knob styles—screwdriver slot and fingertip
- Drip proof option available on screwdriver slot knob style
- Two terminal choices depending on application



Web Resources

Downloadable CAD drawings and other technical information
www.littelfuse.com/shocksafe

Recommended Fuses

| | |
|-----------------|----|
| 2AG | 36 |
| 3AG | 36 |
| 5 x 20 mm | 35 |

Specifications

Insulation Resistance 10,000 megaohm minimum at 500 VDC
Contact Resistance Less than .005 ohm average at currents up to 1 A
Mounting Threaded styles withstand 15 in-lb mounting torque
 Profile panel thickness .032" min/310" max.
 Quick mount panel thickness .012" min/360" max.
 Rear mount panel thickness .012" min/260" max.
Body Material Black glass-filled thermoplastic (UL94 V-0)
Knob Material Grey, blue or black glass-filled thermoplastic (UL94 V-0)
Hex Nut Material Black glass-filled thermoplastic
Knob Finger-Grip, Fuse Extractor type or Screwdriver Slot, Fuse Extractor type with plated copper alloy insert
 Plated copper alloy contact clips.
 Spring loaded, locking mechanism provides an anti-tease feature and will not vibrate loose
Terminals Copper alloy, Tin-plated
Ambient Temperature -40°C to +85°C
Hardware Threaded style fuse holders are supplied with a thermoplastic hex nut unassembled
 Quick mount style fuse holders are supplied with a push-on type retaining nut, black oxide finish, unassembled
 A synthetic rubber O-ring will be supplied only with the screwdriver slot knob when the drip-proof version is requested

| AGENCY APPROVAL | FILE NUMBER | 3AG | 5 X 20 mm | 2AG |
|-----------------|-------------|------------|------------|------------|
| UL | E75961 | 20 A 250 V | 10 A 250 V | 10 A 250 V |
| CSA | LR91788 | 20 A 250 V | 10 A 250 V | 10 A 250 V |
| VDE | 116895E | 10 A 250 V | 10 A 250 V | — |

Note: To order with a metal internal tooth lockwasher (L) and/or neoprene panel washer (N) and/or drip-proof synthetic rubber "O" ring with Neoprene washer (NP) [Screwdriver slot knob only], add the appropriate suffix (L, N, or NP) respectively.

Please refer to Technical Application Guide section for information on proper fuse holder de-rating.

Ordering Information

EXAMPLE:

(Complete Assembly with Options)

Series Number **345 3 LS 7 LNP**

| FUSE SIZE | STYLE | TERMINALS | OPTIONS* |
|---------------------------------|---|--|--|
| 2 2AG .177" x .570" | LF Low Profile Body Black Fingertip Knob | 1 3/16" (Right Angle) Dual Purpose Solder/QC | L Lockwasher |
| 3 3AG .250" x 1.250" | RF Rear Mount Body Black Fingertip Knob | 2 3/16" (Straight) Dual Purpose Solder/QC | N Neoprene Washer |
| 5 5 x 20 mm .197" X .787" | HF High Profile Body Screwdriver Slot Knob | 3 3/16" (Right Angle) NEMA QC | NP Drip-Proof O-Ring [†] with Neoprene Washer |
| | LS Low Profile Body Screwdriver Slot Knob | 4 3/16" (Straight) NEMA QC | |
| | QS Quick Mount Body Screwdriver Slot Knob | 7 1/4" (Right Angle) NEMA/DIN QC | |
| | Screwdriver Slot Knob 2AG—Blue Knob 3AG—Grey Knob 5 x 20 mm—Black Knob | 8 1/4" (Straight) NEMA/DIN QC | |

*Options (L, N, NP) can be ordered individually or in combination.
[†]Screwdriver slot knob only.

SEMICONDUCTOR FUSE BLOCKS

LSCR Series



Description

Modular-designed Semiconductor fuse blocks are designed to accommodate a wide range of Semiconductor fuses, with a maximum diameter of 3".

Features/Benefits

- Modular design reduces inventory requirements
- Sold in pairs for convenience
- Constructed of molded phenolic (with plated steel studs)

Dimensions Inches

LSCR001

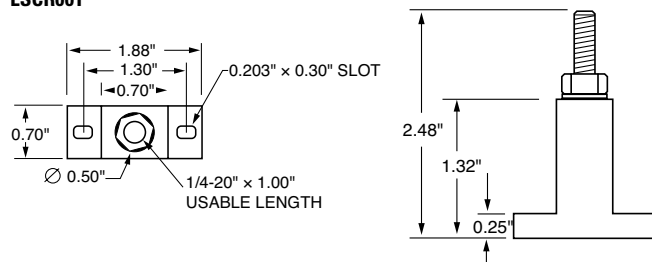

LSCR002

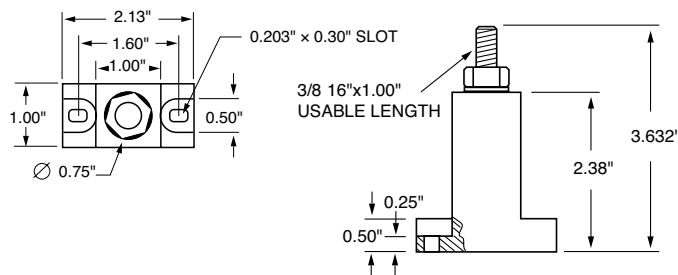

Specifications

| | |
|------------------------------|--|
| Voltage Rating | LSCR001: Accepts fuses 1" diameter or less at 600 V LSCR002: Accepts fuses up to 3" diameter at 600 V |
| Ampere Ratings | LSCR001: 1 – 400 A capacity LSCR002: 70 – 800 A capacity |
| Approvals | UL Recognized (File No. E14721) CSA Certified (File No. 73160) |
| Stud Size | LSCR001: ¼ -20 thread (Torque 61 in-lbs.) LSCR002: ⅜ -16 thread (Torque 192 in-lbs) |
| Base | Molded phenolic. 150° C temperature rating |
| Terminal Construction | Plated steel. Supplied with nut and Belleville washer |

Recommended Fuses

Semiconductor and Class T fuses. See tables below.

LSCR001 Semiconductor Fuse Block Selection Guide

| FUSE SERIES | AMPERE RATING | PAGE |
|-------------|---------------|------|
| L15S | 70-400 | 66 |
| L17T | 70-250 | 52 |
| L25S | 35-60 | 66 |
| LA30QS | 35-60 | 69 |
| L50S | 35-100 | 66 |
| LA50QS | 35-100 | 70 |
| L60S | 35-60 | 66 |
| KLC | 35-60 | 66 |
| JLLN | 70-100 | 26 |
| JLLS | 70-100 | 26 |

LSCR002 Semiconductor Fuse Block Selection Guide

| FUSE SERIES | AMPERE RATING | PAGE |
|-------------|---------------|------|
| L15S | 500-800 | 66 |
| L17T | 300-800 | 52 |
| L25S | 225-800 | 66 |
| LA30QS | 225-800 | 69 |
| L50S | 225-800 | 66 |
| LA50QS | 225-800 | 70 |
| L60S | 200-800 | 66 |
| KLC | 125-800 | 66 |
| JLLN | 225-800 | 26 |
| JLLS | 225-800 | 26 |

Web Resources

Sample requests, downloadable CAD drawings and other technical information: www.littelfuse.com/lscr

SEMICONDUCTOR FUSE BLOCKS

1LFS and 1LS Series



Specifications

| | |
|-------------------------|---------------------------------|
| Voltage Rating | 600 V |
| Ampere Range | 1 – 600 A |
| Approvals | UL Recognized |
| Insulator Base | 150° C general purpose phenolic |
| Box Lug Terminal | Tin plated aluminum |

Dimensions Inches (mm)

Dimensions for reference only.

1LFS101

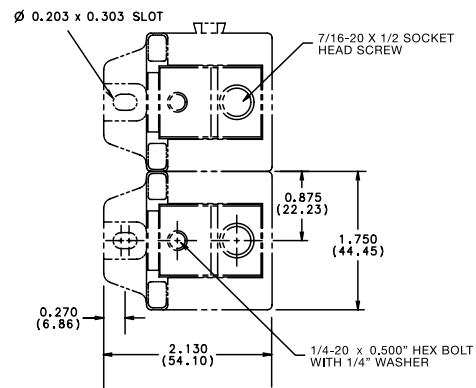

1LFS102

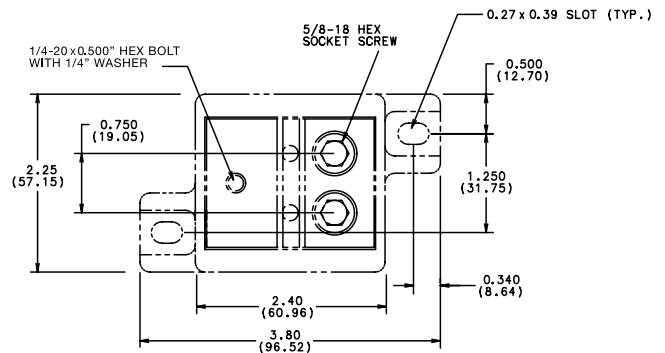

1LS110

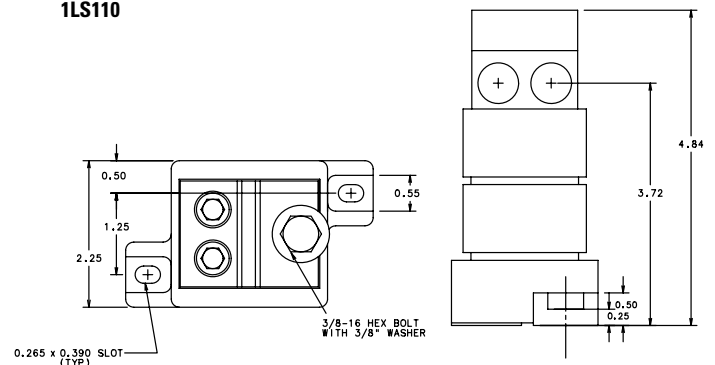

Description

Littelfuse modular style semiconductor fuse blocks accommodate a wide range of semiconductor fuses. Blocks are provided in pairs with fuse mounting hardware.

Features/Benefits

- Modular design reduces inventory requirements
- Sold in pairs for convenience
- Constructed of molded phenolic (with plated steel studs)

Ordering Information

| CATALOG/ORDERING NUMBER | AMPERE RATING | WIRE RANGE | WIRE RATING | APPROVALS |
|-------------------------|---------------|-------------------|-------------|----------------|
| 1LFS101 | 100 A | #2/0 - 14 CU/AL | 120 in-lbs | UL Recognized |
| 1LFS102 | 400 A | 250MCM - #6 CU/AL | 275 in-lbs | UL Recognized |
| 1LS110 | 400 A | 250MCM - #6 CU/AL | 275 in-lbs | Self-Certified |

Web Resources

Sample requests, downloadable CAD drawings and other technical information: www.littelfuse.com/1lf

Recommended Fuses

Wide range of semiconductor fuses66

POWR-BLOKS™

Distribution Blocks • Splicer Blocks • Covers



Description

POWR-BLOKS™ power distribution blocks offer a safe, convenient way of splicing cables, providing a fixed junction tap-off point or splitting primary power into secondary circuits. Lx2xxx-DIN series offers integral DIN-Rail mount and an optional hinged safety cover.

Optional power distribution block covers provide protection against accidental shorting between poles caused by loose wires, tools, or other conductive material. They also protect personnel from accidentally contacting energized connectors. To order protective covers, match the number of poles for the block to the cover.

Applications

Typical applications include heating, air conditioning and refrigeration systems, elevator systems, material handling equipment, control panels, motor controls, switchgear, and anywhere power needs to be distributed to more than one load.

Connectors

Box lug connectors are designed for use with a single, solid or class B or C stranded conductor. Use of more than one conductor per connector opening or use of extra-flexible, fine-stranded conductors, such as welding cable, voids the UL Listing and may cause overheating. Manufacturers of cable terminations can furnish crimp-on sleeves for fine stranded conductors which permit these conductors to be used with box lugs.

Ampere Ratings

The ampere rating per pole for power distribution blocks is based on the line ampacity of 75°C insulated conductors per NEC® Table 310.16. If 60°C insulated conductors are used, load must not exceed the ampacity of 60°C conductors. Use of conductors rated in excess of 75°C is permitted (for example 90°C), however, load must not exceed the ampacity of 75°C conductors.

Specifications

| | |
|----------------------------|--|
| Voltage Rating | 600 V |
| Current Rating | Based on NEC Table 310.16, using 75°C copper wire |
| Material | Phenolic rated at 150°C and Thermoplastic rated at 125°C (LD1400 and LS1300 series only) |
| Connector | Standard: Highly conductive aluminum, tin plated Copper: Highly conductive copper, tin plated |
| Flammability Rating | UL94 V-0 |
| Approvals | UL Recognized - LD/LS Series (File: E171395) UL Recognized - LFD/LFS Series (File: E309688) CSA Certified (File: LR700111) |
| Environmental | RoHS compliant, Lead (Pb) free |

Ordering Information

See Selection Guide on next page

Web Resources

For dimension, CAD and 3-D drawings, visit:
www.littelfuse.com/powrbloks

Hinged Plastic Covers

| CATALOG/ORDERING NUMBER | FOR USE WITH DISTRIBUTION/SPLICER BLOCK NO. | POLES |
|-------------------------|---|-------|
| OLCH1321Z | LD2xxx-1DIN / LS2xxx-1DIN | 1 |
| OLCH1322Z | LD2xxx-2DIN / LS2xxx-2DIN | 2 |
| OLCH1323Z | LD2xxx-3DIN / LS2xxx-3DIN | 3 |

Note: Optional hinged covers snap on to blocks.

Clear Plastic Covers

| CATALOG/ORDERING NUMBER | FOR USE WITH DISTRIBUTION/SPLICER BLOCK NO. | POLES |
|-------------------------|---|-------|
| LPBC02 | LD0xxx-2 / LS0xxx-2 | 2 |
| LPBC03 | LD0xxx-3 / LS0xxx-3 | 3 |
| LPBC21 | LD2xxx-1 / LS2xxx-1 | 1 |
| LPBC22 | LD2xxx-2 / LS2xxx-2 | 2 |
| LPBC23 | LD2xxx-3 / LS2xxx-3 | 3 |
| LPBC31 | LD3xxx-1 / LS3xxx-1 | 1 |
| LPBC32 | LD3xxx-2 / LS3xxx-2 | 2 |
| LPBC33 | LD3xxx-3 / LS3xxx-3 | 3 |
| LPBC41 | LD4xxx-1 / LS4xxx-1 | 1 |
| LPBC42 | LD4xxx-2 / LS4xxx-2 | 2 |
| LPBC43 | LD4xxx-3 / LS4xxx-3 | 3 |
| LPBC51 | LD5xxx-1 / LS5xxx-1 | 1 |
| LPBC52 | LD5xxx-2 / LS5xxx-2 | 2 |
| LPBC53 | LD5xxx-3 / LS5xxx-3 | 3 |

Note: For installation of optional clear plastic covers, use the screws provided with each cover.

POWR-BLOKS™

Distribution Block Selection Guide

| AMP RATING PER POLE | POLES | CONNECTOR MATERIAL | LINE CONNECTION | | | | LOAD CONNECTION | | | | DRAWING | CATALOG/ORDERING NUMBER |
|---------------------|-------|--------------------|-----------------|-------------------|-----------|----------------------------|-----------------|-------------------|----------------------------|------------|---------|-------------------------|
| | | | CONNECTOR | OPENINGS PER POLE | LUG TYPE | WIRE RANGE | CONNECTOR | OPENINGS PER POLE | LUG TYPE | WIRE RANGE | | |
| 115 | 1 | AL | | 1 | Slotted | #2 - #14 | | 4 | Slotted | #10 - #18 | 2 | OLD14001Z |
| 115 | 2 | | | 1 | Slotted | #2 - #14 | | 4 | Slotted | #10 - #18 | 2 | OLD14002Z |
| 115 | 3 | | | 1 | 5/32" Hex | #2 - #14 | | 4 | 5/64" Hex | #10 - #18 | 2 | LFD14003Z |
| 115 | 4 | | | 1 | Slotted | #2 - #14 | | 4 | Slotted | #10 - #18 | 2 | OLD14004Z |
| 175 | 2 | AL | | 1 | 5/16" Hex | 20 - #14 | | 6 | Slotted | #4 - #14 | 1 | OLD04012Z |
| 175 | 3 | | | 1 | 3/16" Hex | 20 - #14 | | 6 | 1/8" Hex | #4 - #14 | 1 | LFD04013Z |
| 175 | 2 | AL | | 1 | 5/16" Hex | 20 - #14 | | 4 | Slotted | #4 - #14 | 1 | OLD04022Z |
| 175 | 3 | | | 1 | 5/16" Hex | 20 - #14 | | 4 | Slotted | #4 - #14 | 1 | OLD04023Z |
| 310 | 2 | AL | | 1 | 5/16" Hex | 350mcm - #6 | | 6 | Slotted | #4 - #14 | 1 | OLD04042Z |
| 310 | 3 | | | 1 | 5/16" Hex | 350mcm - #6 | | 6 | Slotted | #4 - #14 | 1 | OLD04043Z |
| 175 | 1 | AL | | 1 | 5/16" Hex | 20 - #14 | | 4 | 1/8" Hex | #4 - #14 | 3 | OLD25701Z |
| 175 | 2 | | | 1 | 3/16" Hex | 20 - #14 | | 4 | 1/8" Hex | #4 - #14 | 3 | LFD25702Z |
| 175 | 3 | | | 1 | 3/16" Hex | 20 - #14 | | 4 | 1/8" Hex | #4 - #14 | 3 | LFD25703Z |
| 175 | 1 | | | CU | | 1 | | 3/16" Hex | 20 - #14 | | 4 | Slotted |
| 175 | 2 | 1 | 3/16" Hex | | | 20 - #14 | 4 | Slotted | #4 - #14 | | 3 | OLD29702Z |
| 175 | 3 | 1 | 3/16" Hex | | | 20 - #14 | 4 | Slotted | #4 - #14 | | 3 | OLD29703Z |
| 335 | 1 | AL | | 1 | 5/16" Hex | 400mcm - #6 | | 4 | Slotted | #2 - #14 | 5 | OLD35521Z |
| 335 | 2 | | | 1 | 5/16" Hex | 400mcm - #6 | | 4 | Slotted | #2 - #14 | 5 | OLD35522Z |
| 380 | 3 | | | 1 | 3/8" Hex | 500mcm - #6 | | 4 | 5/32" Hex | #2 - #14 | 5 | LFD35523Z |
| 335 | 1 | | | AL | | 1 | | 5/16" Hex | 400mcm - #6 | | 6 | Slotted |
| 335 | 2 | 1 | 5/16" Hex | | | 400mcm - #6 | 6 | Slotted | #2 - #14 | | 5 | OLD35532Z |
| 380 | 3 | 1 | 3/8" Hex | | | 500mcm - #6 | 6 | 5/32" Hex | #2 - #14 | | 5 | LFD35533Z |
| 350 | 1 | AL | | 2 | 5/16" Hex | 20 - #14 | | 6 | Slotted | #4 - #14 | 5 | OLD35551Z |
| 350 | 2 | | | 2 | 5/16" Hex | 20 - #14 | | 6 | Slotted | #4 - #14 | 5 | OLD35552Z |
| 350 | 3 | | | 2 | 3/16" Hex | 20 - #14 | | 6 | 1/8" Hex | #4 - #14 | 5 | LFD35553Z |
| 380 | 1 | | | CU | | 1 | | Slotted | 500mcm - #4 | | 6 | 5/32" Hex |
| 380 | 2 | 1 | Slotted | | | 500mcm - #4 | 6 | 5/32" Hex | #2 - #14 | | 5 | OLD39532Z |
| 380 | 3 | 1 | Slotted | | | 500mcm - #4 | 6 | 5/32" Hex | #2 - #14 | | 5 | OLD39533Z |
| 350 | 1 | CU | | 2 | Slotted | 20 - #14 | | 6 | 1/8" Hex | #4 - #14 | 5 | OLD39551Z |
| 350 | 2 | | | 2 | Slotted | 20 - #14 | | 6 | 1/8" Hex | #4 - #14 | 5 | OLD39552Z |
| 350 | 3 | | | 2 | Slotted | 20 - #14 | | 6 | 1/8" Hex | #4 - #14 | 5 | OLD39553Z |
| 380 | 1 | AL | | 1 | Slotted | 500mcm - #4 | | 6 | Slotted | #2 - #14 | 6 | OLD45511Z |
| 380 | 2 | | | 1 | Slotted | 500mcm - #4 | | 6 | Slotted | #2 - #14 | 6 | OLD45512Z |
| 380 | 3 | | | 1 | Slotted | 500mcm - #4 | | 6 | Slotted | #2 - #14 | 6 | OLD45513Z |
| 335 | 1 | | | AL | | 1 | | Slotted | 400mcm - #6 | | 8 | Slotted |
| 335 | 2 | 1 | Slotted | | | 400mcm - #6 | 8 | Slotted | #2 - #14 | | 6 | OLD45602Z |
| 335 | 3 | 1 | Slotted | | | 400mcm - #6 | 8 | Slotted | #2 - #14 | | 6 | OLD45603Z |
| 380 | 1 | AL | | 1 | Slotted | 500mcm - #4 | | 12 | Slotted | #2 - #14 | 7 | OLD55521Z |
| 380 | 2 | | | 1 | Slotted | 500mcm - #4 | | 12 | Slotted | #2 - #14 | 7 | OLD55522Z |
| 380 | 3 | | | 1 | 3/8" Hex | 500mcm - #4 | | 12 | 5/32" Hex | #2 - #14 | 7 | LFD55523Z |
| 380 | 1 | | | AL | | 1 | | 3/8" Hex | 500mcm - #4 | | 6 | 5/16" Hex |
| 380 | 2 | 1 | 3/8" Hex | | | 500mcm - #4 | 6 | 5/16" Hex | 20 - #14 | | 7 | OLD55792Z |
| 380 | 3 | 1 | 3/8" Hex | | | 500mcm - #4 | 6 | 3/16" Hex | 20 - #14 | | 7 | LFD55793Z |
| 760 | 1 | AL | | 2 | 3/8" Hex | 500mcm - #4 | | 8 | 5/16" Hex | 20 - #14 | 7 | OLD55861Z |
| 760 | 2 | | | 2 | 3/8" Hex | 500mcm - #4 | | 8 | 5/16" Hex | 20 - #14 | 7 | OLD55862Z |
| 760 | 3 | | | 2 | 3/8" Hex | 500mcm - #4 | | 8 | 3/16" Hex | 20 - #14 | 7 | LFD55863Z |
| 665 | 1 | | | AL | | 1 | | 3/8" Hex | 500mcm - #4 350mcm - #6 | | 4 | Slotted |
| 665 | 2 | 1 | 3/8" Hex | | | 500mcm - #4 350mcm - #6 | 4 | Slotted | 20 - #14 | | 7 | OLD55872Z |
| 665 | 3 | 1 | 3/8" Hex | | | 500mcm - #4 350mcm - #6 | 4 | Slotted | 20 - #14 | | 7 | OLD55873Z |
| 665 | 1 | 1 | 3/8" Hex | | | 500mcm - #4 350mcm - #6 | 4 | Slotted | 20 - #14 | | 7 | OLD55873Z |

Note: AL = Aluminum / CU = Copper

POWR-BLOKS™

Distribution Block Selection Guide

| AMP RATING PER POLE | POLES | CONNECTOR MATERIAL | LINE CONNECTION | | | | LOAD CONNECTION | | | | DRAWING | CATALOG/ORDERING NUMBER |
|---------------------|-------|--------------------|-----------------|-------------------|-----------|------------|-----------------|-------------------|-----------|------------|---------|-------------------------|
| | | | CONNECTOR | OPENINGS PER POLE | LUG TYPE | WIRE RANGE | CONNECTOR | OPENINGS PER POLE | LUG TYPE | WIRE RANGE | | |
| 760 | 1 | AL | | 2 | 3/8" Hex | 500mcm-#4 | | 12 | Slotted | #4 - #14 | 7 | OLD55921Z |
| 760 | 2 | | | 2 | 3/8" Hex | 500mcm-#4 | | 12 | Slotted | #4 - #14 | 7 | OLD55922Z |
| 760 | 3 | | | 2 | 3/8" Hex | 500mcm-#4 | | 12 | 1/8" Hex | #4 - #14 | 7 | LFD55923Z |
| 380 | 1 | AL | | 1 | 3/8" Hex | 500mcm-#4 | | 8 | 5/32" Hex | #2 - #14 | 7 | OLD55941Z |
| 380 | 2 | | | 1 | 3/8" Hex | 500mcm-#4 | | 8 | 5/32" Hex | #2 - #14 | 7 | OLD55942Z |
| 380 | 3 | | | 1 | 3/8" Hex | 500mcm-#4 | | 8 | 5/32" Hex | #2 - #14 | 7 | OLD55943Z |
| 760 | 1 | CU | | 2 | 3/8" Hex | 500mcm-#4 | | 8 | 3/16" Hex | 20 - #14 | 7 | OLD59861Z |
| 760 | 2 | | | 2 | 3/8" Hex | 500mcm-#4 | | 8 | 3/16" Hex | 20 - #14 | 7 | OLD59862Z |
| 760 | 3 | | | 2 | 3/8" Hex | 500mcm-#4 | | 8 | 3/16" Hex | 20 - #14 | 7 | OLD59863Z |
| 760 | 1 | CU | | 2 | 3/8" Hex | 500mcm-#4 | | 12 | Slotted | #2 - #14 | 7 | OLD59921Z |
| 760 | 2 | | | 2 | 3/8" Hex | 500mcm-#4 | | 12 | Slotted | #2 - #14 | 7 | OLD59922Z |
| 760 | 3 | | | 2 | 3/8" Hex | 500mcm-#4 | | 12 | Slotted | #2 - #14 | 7 | OLD59923Z |
| 175 | 1 | AL | | 1 | 3/16" Hex | 20 - #14 | | 4 | 1/8" Hex | #4 - #14 | 4 | OLD25701ZXDIN |
| 175 | 2 | | | 1 | 3/16" Hex | 20 - #14 | | 4 | 1/8" Hex | #4 - #14 | 4 | OLD25702ZXDIN |
| 175 | 3 | | | 1 | 3/16" Hex | 20 - #14 | | 4 | 1/8" Hex | #4 - #14 | 4 | OLD25703ZXDIN |
| 175 | Adder | AL | | 1 | – | 20 - #14 | | 4 | – | #4 - #14 | 4 | OLD2570AZXDIN |
| 175 | 1 | | | 1 | – | 20 - #14 | | 6 | – | #4 - #14 | 4 | OLD25801ZXDIN |
| 175 | 2 | | | 1 | 5/16" Hex | 20 - #14 | | 6 | Slotted | #4 - #14 | 4 | OLD25802ZXDIN |
| 175 | 3 | AL | | 1 | 5/16" Hex | 20 - #14 | | 6 | Slotted | #4 - #14 | 4 | OLD25803ZXDIN |
| 175 | Adder | | | 1 | – | 20 - #14 | | 6 | – | #4 - #14 | 4 | OLD2580AZXDIN |
| 175 | 1 | | | 1 | 3/16" Hex | 20 - #14 | | 4 | Slotted | #4 - #14 | 4 | OLD29701ZXDIN |
| 175 | 2 | CU | | 1 | 3/16" Hex | 20 - #14 | | 4 | Slotted | #4 - #14 | 4 | OLD29702ZXDIN |
| 175 | 3 | | | 1 | 3/16" Hex | 20 - #14 | | 4 | Slotted | #4 - #14 | 4 | OLD29703ZXDIN |
| 175 | Adder | | | 1 | – | 20 - #14 | | 4 | – | #4 - #14 | 4 | OLD2970AZXDIN |

Note: AL = Aluminum / CU = Copper

Hinged Plastic Covers





























Clear Plastic Covers



POWR-BLOKS™

Splicer Block Selection Guide

| AMP RATING PER POLE | POLES | CONNECTOR MATERIAL | LINE CONNECTION | | | | LOAD CONNECTION | | | | DRAWING | CATALOG/ ORDERING NUMBER |
|---------------------|-------|--------------------|---|-------------------|-----------|------------|---|-------------------|-----------|------------|---------|--------------------------|
| | | | CONNECTOR | OPENINGS PER POLE | LUG TYPE | WIRE RANGE | CONNECTOR | OPENINGS PER POLE | LUG TYPE | WIRE RANGE | | |
| 310 | 2 | AL |  | 1 | 5/16" Hex | 350mcm-#6 |  | 1 | 5/16" Hex | 350mcm-#6 | 1 | OLS03032Z |
| 310 | 3 | | | 1 | 5/16" Hex | 350mcm-#6 | | 1 | 5/16" Hex | 350mcm-#6 | 1 | OLS03033Z |
| 115 | 1 | AL |  | 1 | Slotted | #2 - #14 |  | 1 | Slotted | #2 - #14 | 2 | OLS13001Z |
| 115 | 2 | | | 1 | Slotted | #2 - #14 | | 1 | Slotted | #2 - #14 | 2 | OLS13002Z |
| 115 | 3 | | | 1 | 5/32" Hex | #2 - #14 | | 1 | 5/32" Hex | #2 - #14 | 2 | LFS13003Z |
| 115 | 4 | | | 1 | Slotted | #2 - #14 | | 1 | Slotted | #2 - #14 | 2 | OLS13004Z |
| 150 | 1 | CU |  | 1 | 3/16" Hex | 1/0 - #18 |  | 1 | 3/16" Hex | 1/0 - #18 | 3 | OLS21211Z |
| 150 | 2 | | | 1 | 3/16" Hex | 1/0 - #18 | | 1 | 3/16" Hex | 1/0 - #18 | 3 | OLS21212Z |
| 150 | 3 | | | 1 | 3/16" Hex | 1/0 - #18 | | 1 | 3/16" Hex | 1/0 - #18 | 3 | OLS21213Z |
| 115 | 1 | AL |  | 1 | Slotted | #2 - #14 |  | 1 | Slotted | #2 - #14 | 3 | OLS25521Z |
| 115 | 2 | | | 1 | Slotted | #2 - #14 | | 1 | Slotted | #2 - #14 | 3 | OLS25522Z |
| 115 | 3 | | | 1 | Slotted | #2 - #14 | | 1 | Slotted | #2 - #14 | 3 | OLS25523Z |
| 175 | 1 | AL |  | 1 | 5/16" Hex | 2/0 - #14 |  | 1 | 5/16" Hex | 2/0 - #14 | 3 | OLS25721Z |
| 175 | 2 | | | 1 | 5/16" Hex | 2/0 - #14 | | 1 | 5/16" Hex | 2/0 - #14 | 3 | OLS25722Z |
| 175 | 3 | | | 1 | 3/16" Hex | 2/0 - #14 | | 1 | 3/16" Hex | 2/0 - #14 | 3 | LFS25723Z |
| 255 | 1 | AL |  | 1 | 5/16" Hex | 250mcm-#6 |  | 1 | 5/16" Hex | 250mcm-#6 | 5 | OLS31231Z |
| 255 | 2 | | | 1 | 5/16" Hex | 250mcm-#6 | | 1 | 5/16" Hex | 250mcm-#6 | 5 | OLS31232Z |
| 255 | 3 | | | 1 | 5/16" Hex | 250mcm-#6 | | 1 | 5/16" Hex | 250mcm-#6 | 5 | OLS31233Z |
| 255 | 1 | CU |  | 1 | 3/8" Hex | 250mcm-#6 |  | 1 | 3/8" Hex | 250mcm-#6 | 5 | OLS31241Z |
| 255 | 2 | | | 1 | 3/8" Hex | 250mcm-#6 | | 1 | 3/8" Hex | 250mcm-#6 | 5 | OLS31242Z |
| 255 | 3 | | | 1 | 3/8" Hex | 250mcm-#6 | | 1 | 3/8" Hex | 250mcm-#6 | 5 | OLS31243Z |
| 310 | 1 | AL |  | 1 | 5/16" Hex | 350mcm-#6 |  | 1 | 5/16" Hex | 350mcm-#6 | 5 | OLS31261Z |
| 310 | 2 | | | 1 | 5/16" Hex | 350mcm-#6 | | 1 | 5/16" Hex | 350mcm-#6 | 5 | OLS31262Z |
| 310 | 3 | | | 1 | 5/16" Hex | 350mcm-#6 | | 1 | 5/16" Hex | 350mcm-#6 | 5 | OLS31263Z |
| 420 | 1 | AL |  | 1 | 1/2" Hex | 600mcm-#4 |  | 1 | 1/2" Hex | 600mcm-#4 | 6 | OLS45571Z |
| 420 | 2 | | | 1 | 1/2" Hex | 600mcm-#4 | | 1 | 1/2" Hex | 600mcm-#4 | 6 | OLS45572Z |
| 420 | 3 | | | 1 | 1/2" Hex | 600mcm-#4 | | 1 | 1/2" Hex | 600mcm-#4 | 6 | OLS45573Z |
| 620 | 1 | AL |  | 2 | 5/16" Hex | 350mcm-#4 |  | 2 | 5/16" Hex | 350mcm-#4 | 7 | OLS51291Z |
| 620 | 2 | | | 2 | 5/16" Hex | 350mcm-#4 | | 2 | 5/16" Hex | 350mcm-#4 | 7 | OLS51292Z |
| 620 | 3 | | | 2 | 5/16" Hex | 350mcm-#4 | | 2 | 5/16" Hex | 350mcm-#4 | 7 | OLS51293Z |
| 760 | 1 | AL |  | 2 | 3/8" Hex | 500mcm-#4 |  | 2 | 3/8" Hex | 500mcm-#4 | 7 | OLS53011Z |
| 760 | 2 | | | 2 | 3/8" Hex | 500mcm-#4 | | 2 | 3/8" Hex | 500mcm-#4 | 7 | OLS53012Z |
| 760 | 3 | | | 2 | 3/8" Hex | 500mcm-#4 | | 2 | 3/8" Hex | 500mcm-#4 | 7 | OLS53013Z |
| 175 | 1 | AL |  | 1 | 5/16" Hex | 2/0 - #14 |  | 1 | 5/16" Hex | 2/0 - #14 | 4 | OLS25721ZXDIN |
| 175 | 2 | | | 1 | 5/16" Hex | 2/0 - #14 | | 1 | 5/16" Hex | 2/0 - #14 | 4 | OLS25722ZXDIN |
| 175 | 3 | | | 1 | 5/16" Hex | 2/0 - #14 | | 1 | 5/16" Hex | 2/0 - #14 | 4 | OLS25723ZXDIN |
| 175 | Adder | | | 1 | - | 2/0 - #14 | | 1 | - | 2/0 - #14 | 4 | OLS2572AZXDIN |
| 175 | 1 | CU |  | 1 | 5/16" Hex | 2/0 - #14 |  | 1 | 5/16" Hex | 2/0 - #14 | 4 | OLS29721ZXDIN |
| 175 | 2 | | | 1 | 5/16" Hex | 2/0 - #14 | | 1 | 5/16" Hex | 2/0 - #14 | 4 | OLS29722ZXDIN |
| 175 | 3 | | | 1 | 5/16" Hex | 2/0 - #14 | | 1 | 5/16" Hex | 2/0 - #14 | 4 | OLS29723ZXDIN |
| 175 | Adder | | | 1 | - | 2/0 - #14 | | 1 | - | 2/0 - #14 | 4 | OLS2972AZXDIN |

Note: AL = Aluminum / CU = Copper

6 Distribution and Splicer Blocks

POWR-BLOKS™

Distribution Block and Splicer Block Outline Drawings

Dimensions Inches (mm)

LX0XXX

Figure 1

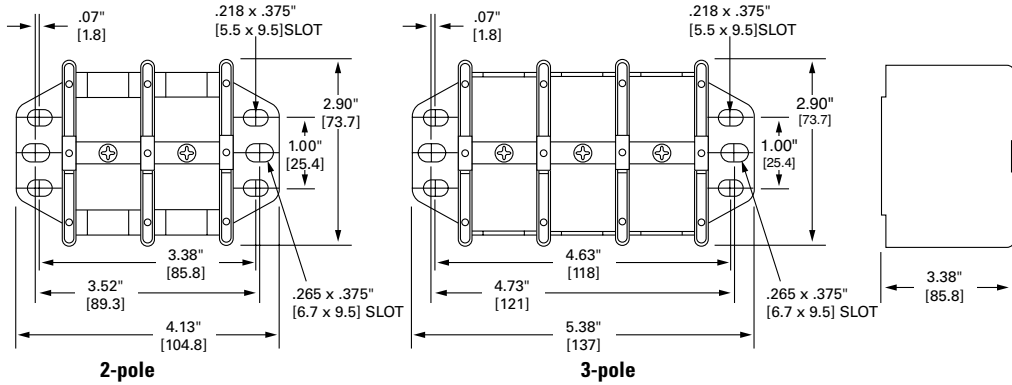

LX1XXX

Figure 2

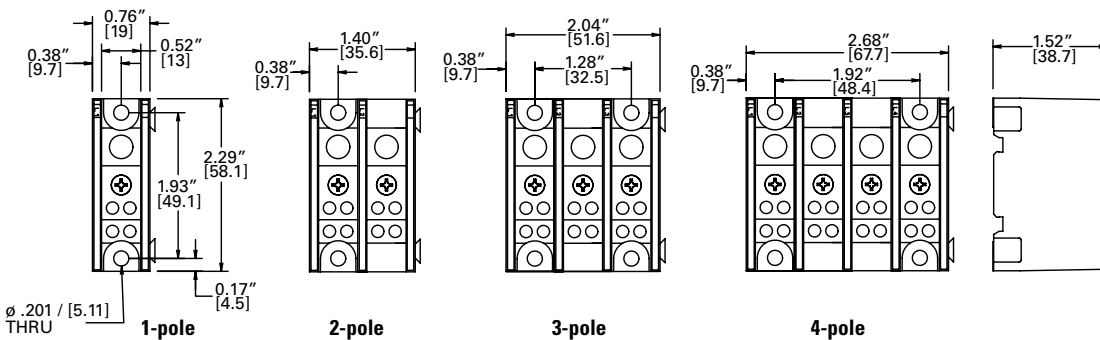

LX2XXX

Figure 3

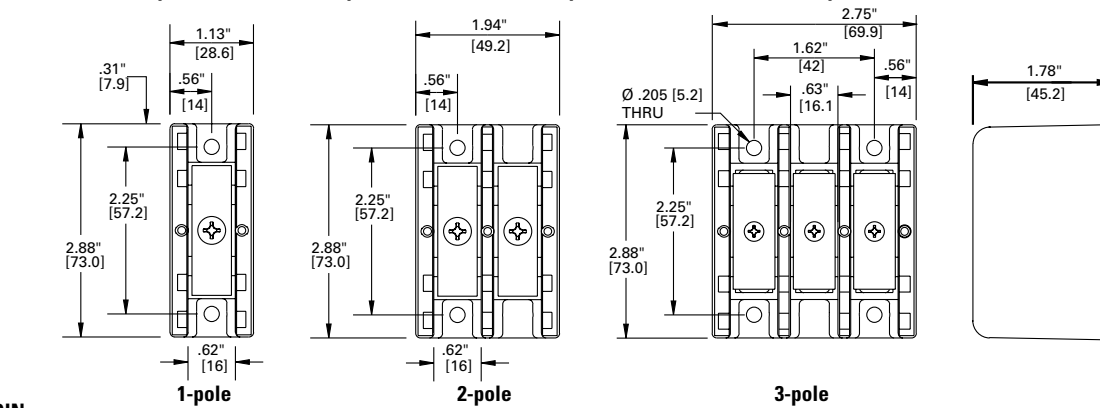

LX2XXX-XDIN

Figure 4

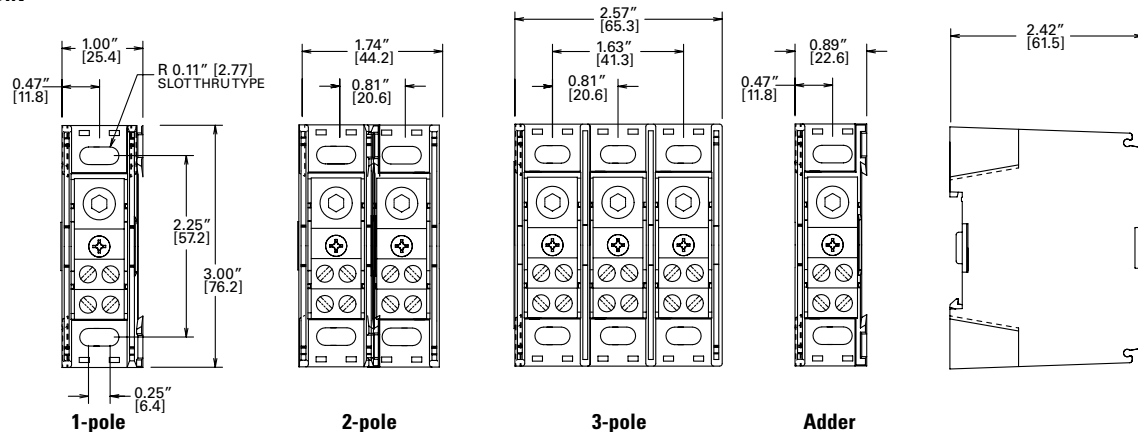

POWR-BLOKS™

Distribution Block and Splicer Block Outline Drawings

Dimensions Inches (mm)

LX3XXX

Figure 5

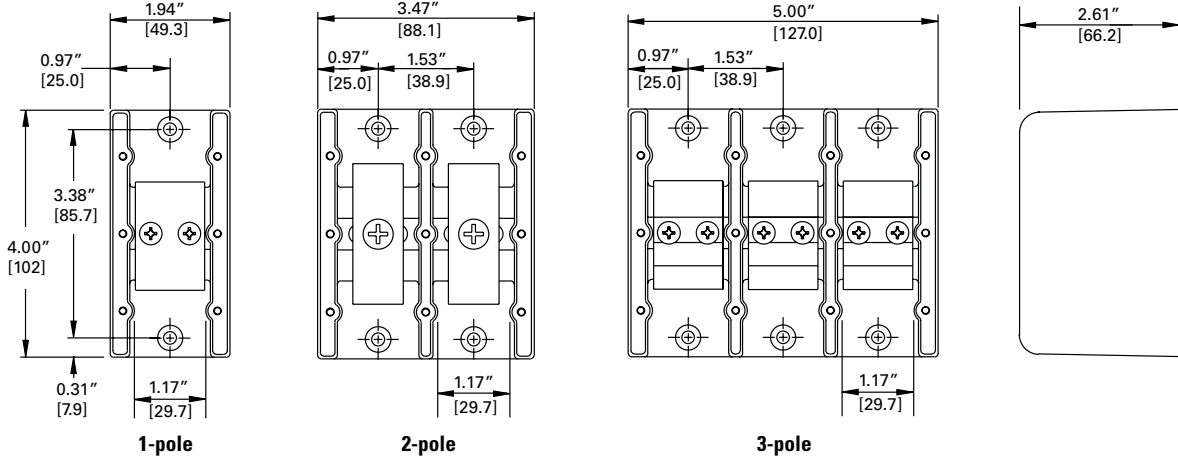

LX4XXX

Figure 6

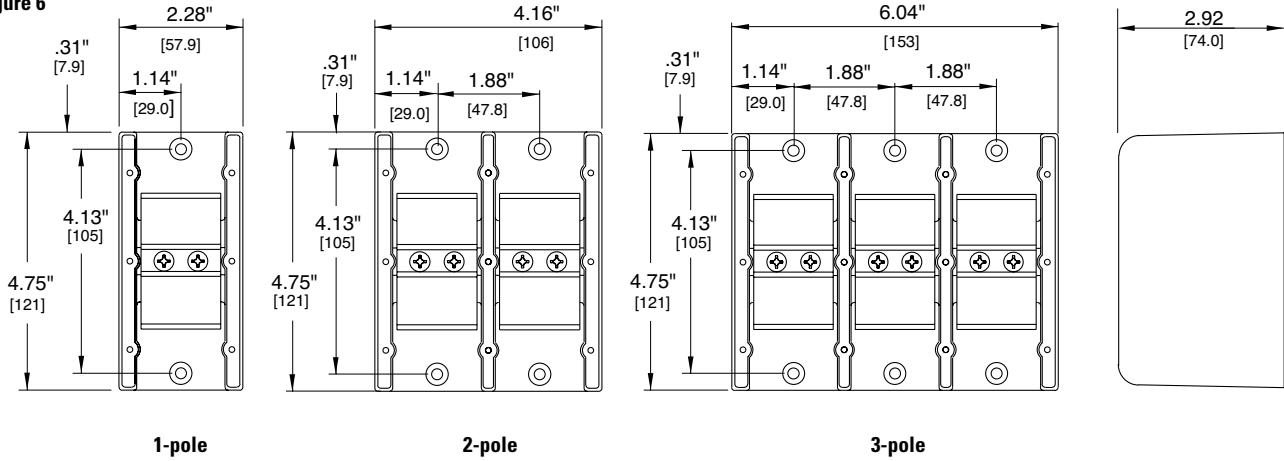

LX5XXX

Figure 7

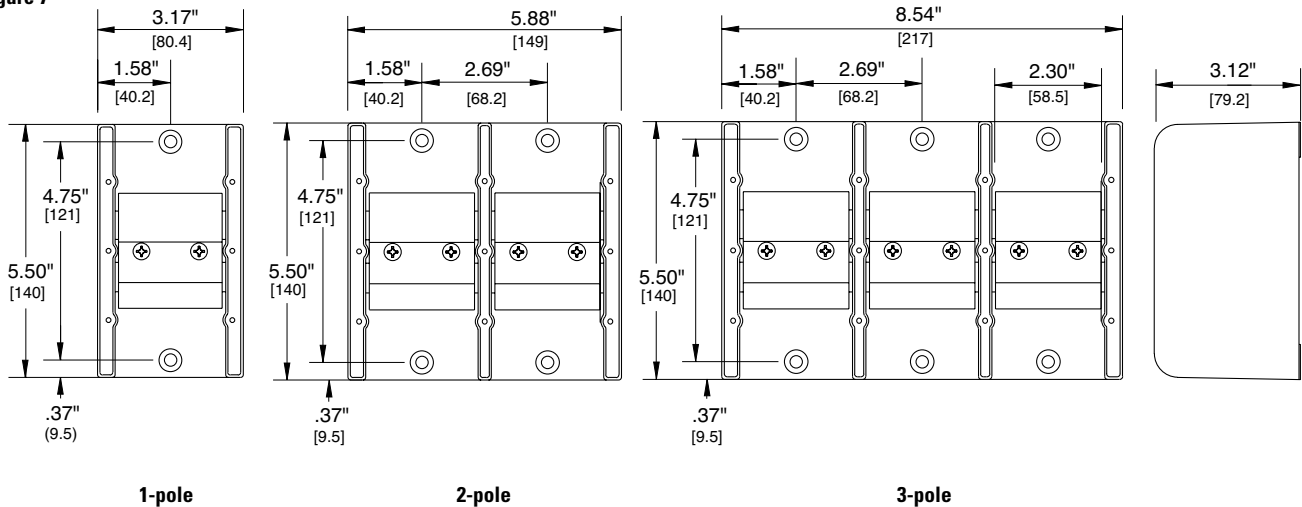

TOUCH-SAFE POWR-BLOKS™

Global Distribution Blocks



Specifications

| | |
|----------------------------|--|
| Voltage Rating | 600 V |
| Ampere Rating | 80 – 310 A |
| Material | Thermoplastic |
| Connector | Brass: Better continuity, Smaller design |
| Flammability Rating | UL94 V-0 |
| Approvals | UL Recognized (File: E309688) c-UL Recognized* CE: IEC 60947-7-1 |
| Environmental | RoHS compliant |

Description

POWR-BLOKS™ Global Distribution Blocks add safety and mounting versatility to our distribution block solutions. The Global Distribution Blocks are approved to UL standards. The Global Distribution Blocks are IP20 finger safe to reduce the risk of contact and eliminates the need for block or panel covers. Installation is quick an easy, all blocks can be mounted on DIN rail or to the panel.

Features/Benefits

- Global part meeting UL standards
- Space saving design
- Integrated touch-safe cover to increase safety
- IP20 protection rating
- Mounts to DIN rail or panels
- Reliable brass connections

Web Resources

For dimension, CAD and 3-D drawings, visit www.littelfuse.com/powrbloks

Ordering Information

| AMP RATING PER POLE | | POLES | CATALOG/ORDERING NUMBER | CONNECTOR MATERIAL | LINE CONNECTION | | | | | LOAD CONNECTION | | | | | DIN RAIL MOUNT |
|---------------------|-----|-------|-------------------------|--------------------|-------------------|------------------|-----------------|-------------|------------|-------------------|--|----------------------------------|---|------------|----------------|
| UL | IEC | | | | OPENINGS PER POLE | OPENING DIAMETER | WIRE RANGE | TORQUE | SCREW TYPE | OPENINGS PER POLE | OPENING DIAMETER | WIRE RANGE | TORQUE | SCREW TYPE | |
| 80 | 80 | 1 | GDB60801Z | Brass | 1 | ø7.0 mm | #8 – #4 | 13.5 in-lbs | Slotted | 6 | 2x ø7.0 mm 3x ø4.5 mm | #8 – #4 #10 – #14 | 13.5 in-lbs 7.2 in-lbs | Slotted | • |
| 115 | 125 | 1 | GDB61151Z | Brass | 1 | ø10.0 mm | #8 – #2 | 31 in-lbs | Hex 5 mm | 6 | ø7.0 mm | #14 – #4 | 17.5 in-lbs | Slotted | • |
| 160 | 160 | 1 | GDB61601Z | Brass | 1 | ø12.5 mm | #8 – 2/0 | 35.5 in-lbs | Hex 5 mm | 6 | ø7.0 mm | #14 – #4 | 17.5 in-lbs | Slotted | • |
| 310 | 400 | 1 | GDB63101Z | Brass | 1 | ø19.0 mm | 3/0 – 350 kcmil | 230 in-lbs | Hex 8 mm | 11 | 2x ø9.0 mm 5x ø6.5 mm 4x ø5.3 mm | #14 – #2 #14 – #6 #14 – #8 | 34.1 in-lbs 19.8 in-lbs 19.8 in-lbs | Slotted | • |
| 115 | 115 | 3 | GDB61153Z | Brass | 1 | ø10.0 mm | #8 – #2 | 31 in-lbs | Hex 4 mm | 6 | ø6.5 mm | #14 – #4 | 17.5 in-lbs | Hex 3 | • |
| 175 | 175 | 3 | GDB61753Z | Brass | 1 | ø12.0 mm | #8 – 2/0 | 35.7 in-lbs | Hex 5 mm | 6 | ø6.5 mm | #14 – #4 | 17.5 in-lbs | Hex 3 | • |

* GDB60801Z, GDB61151Z, GDB61153X, GDB61753Z Only

TOUCH-SAFE POWR-BLOKS™

Global Distribution Blocks

Dimensions mm

80 A
GDB60801Z

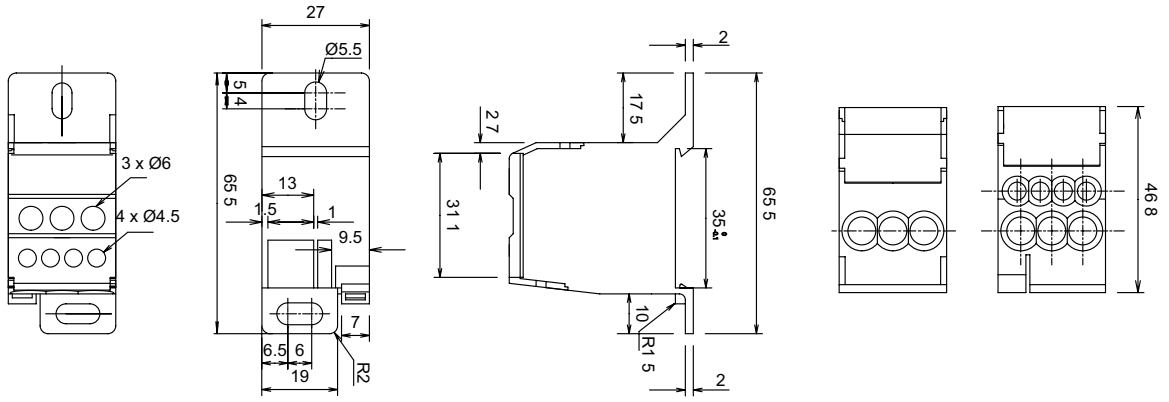

115 A
GDB61151Z

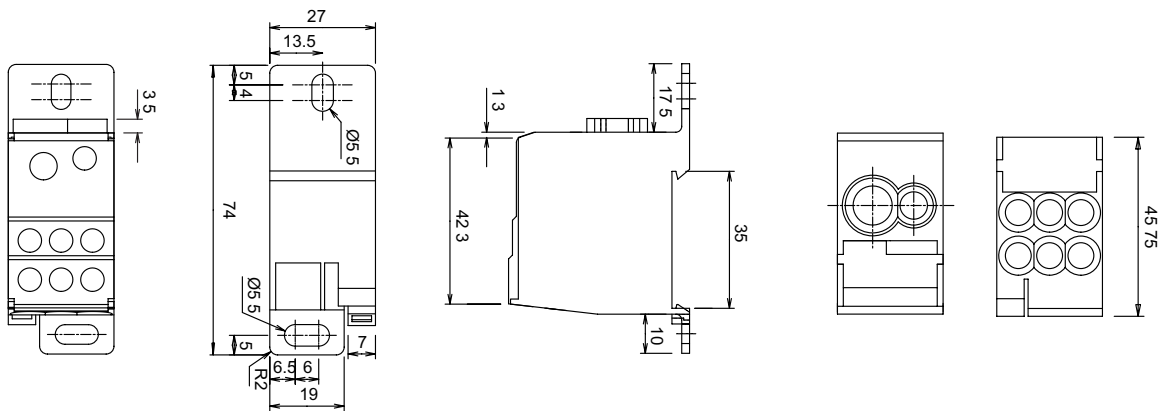

160 A
GDB61601Z

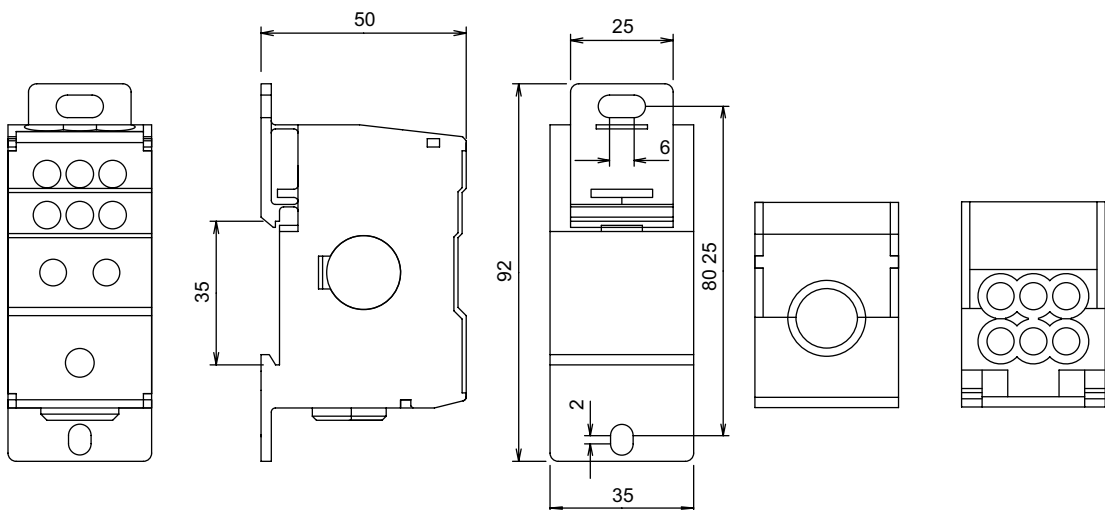

Dimensions, CAD drawings and 3-D models available at www.littelfuse.com/powrbloks

TOUCH-SAFE POWR-BLOKS™

Global Distribution Blocks

Dimensions mm

**310 A
GDB63101Z**

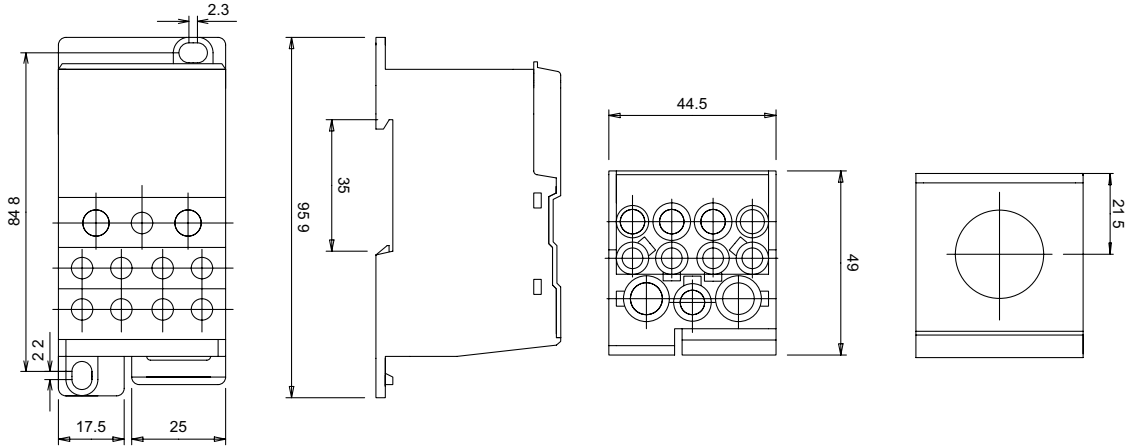

**115 A
GDB61153Z**

**175 A
GDB61753Z**

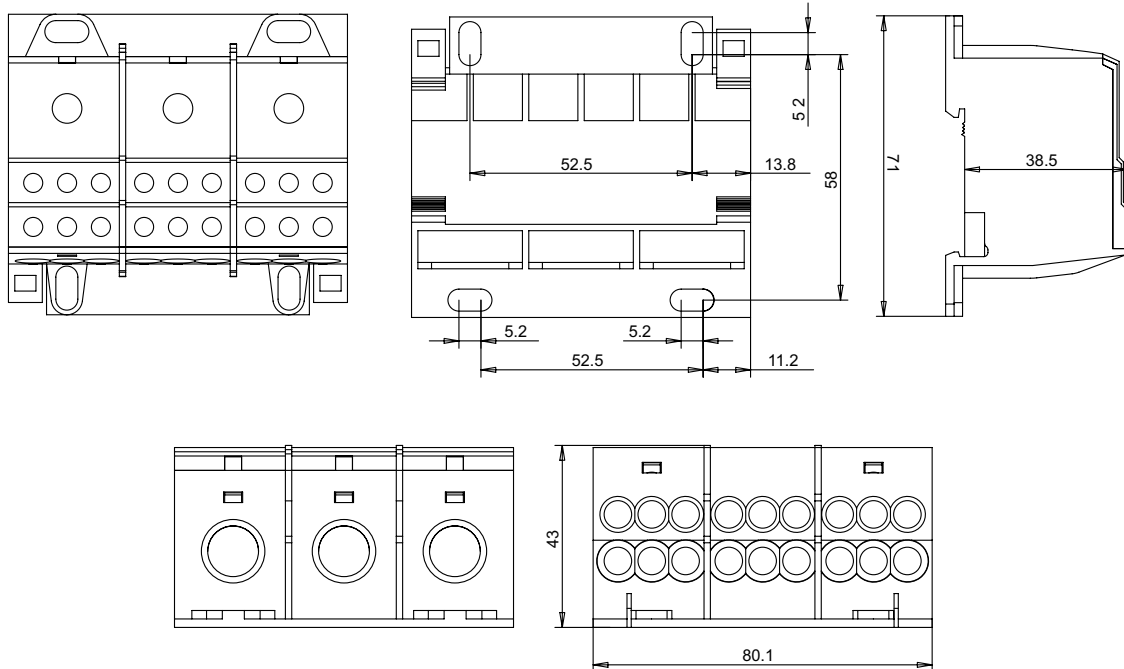

Dimensions, CAD drawings and 3-D models available at www.littelfuse.com/powrbloks

IN-LINE GLASS FUSE HOLDERS

150322



Specifications

| | |
|------------------------------|---------------------------------|
| Voltage Rating | 500 VAC, 125 VDC |
| Ampere Rating | 15 A |
| Fuse Type | ¼" x 1¼" |
| Fuse Clips | Tin-plated brass |
| Wire | Black 18 AWG, 150° C Stranded |
| Molded Body | Single piece thermoplastic |
| Flammability Rating | UL94 V-0 |
| Approvals | UL Recognized (File No. E14721) |
| Environmental | RoHS complaint, Lead (Pb) free |
| Storage Temperature | -40° C to 80° C |
| Operating Temperature | -55° C to 125° C |

Ordering Information

| CATALOG NUMBER | ORDERING NUMBER | STANDARD PACK |
|----------------|-----------------|---------------|
| 150322 | 01500322H | 100 PIECES |

Description

The 150322 is a 500 VAC/125 VDC rated inline fuse holder ideal for applications where supplemental protection is needed, such as lighting ballasts and power supplies. 8-inch pre-stripped wire leads and fuse clips come preassembled for quick installation.

Features/Benefits

- Single piece body minimizes component count
- High voltage rating accommodates many power applications
- Wire leads are pre-attached to fuse clips for quick assembly
- Single piece molded body
- UL Recognized

Recommended Fuses

| | |
|----------------------------------|----|
| 3AG (312, 313 Series) | 36 |
| 3AB (314, 326, 505 Series) | 36 |

Dimensions mm (inches)

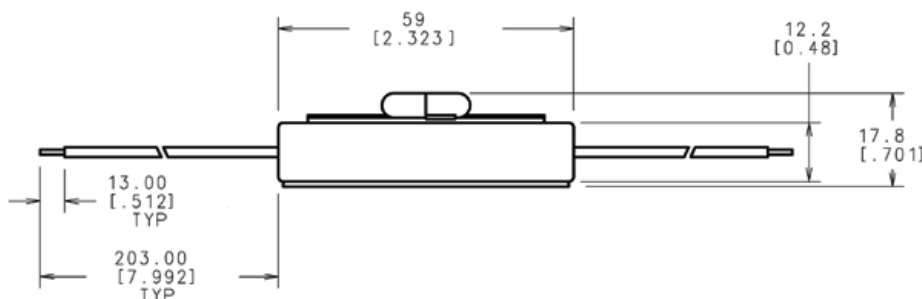

Web Resources

Sample requests, downloadable CAD drawings and other technical information: www.littelfuse.com/150322

Additional In-Line Glass Fuse Holders

| | | |
|---|--|--|
| Twist-Lock 155 Series In-Line Mount Low Voltage 3AG, SFE | Heavy-Duty Bayonet 155 Series In-Line Mount Low Voltage 3AG | Special Type 150 Series In-Line Mount 2AG, 5x20mm |
| | | |

Dimensions Inches

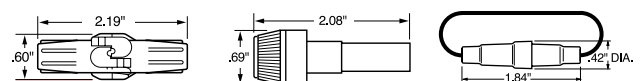

Web Resources

For more information, visit: www.littelfuse.com/150
www.littelfuse.com/155

IN-LINE WATERTIGHT FUSE HOLDERS



Description

Recently redesigned, the Littelfuse 600 V in-line watertight fuse holders allow maximum flexibility for high humidity/corrosive environments where fuses are required. A variety of options offer flexibility for several applications. See the list at the bottom of this page for improved part numbers.

Applications

- Street lighting and parking lot lighting
- Sports lighting and various outdoor illuminated signs
- Boat electrical circuits, tractors/yard equipment and general outdoor circuit protection (such as traffic signals, alley lighting and electric wheelchairs)

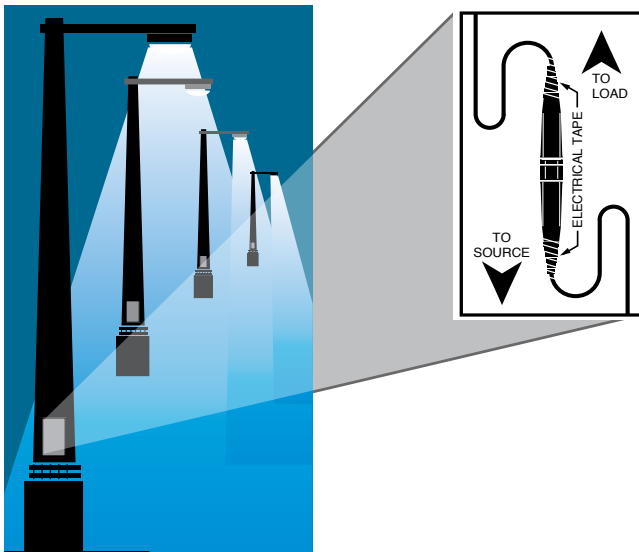

Specifications

| | |
|----------------------------|---|
| Voltage rating | 600 V |
| Ampere rating | up to 30 A |
| Interrupting rating | 200 kA rms symmetrical (with Class CC fuses) |
| Approvals | <p>LEB/LEX series UL Recognized Miscellaneous Fuse holder per UL UL 4248 (File No. E14721) CSA Certified per C22.2, No. 39 (File No. LR7316)</p> <p>LEC/LEY series UL Listed Class CC Branch Circuit Fuse holder per UL 512 (File No. E14721) CSA Certified per C22.2, No. 39 (File No. LR7316)</p> |

Features/Benefits

- Design increases safety by individual device disconnection for easy servicing, eliminating shock risk
- Increases efficiency by preventing faulted ballast from severely damaging fixture or device
- Watertight seal
- Variety of terminations available for flexible design
- Insulating boots available for harsh environments

Recommended Fuses

LEB/LEX series:

Accepts all Littelfuse Midget and Class CC series fuses

| | |
|-------------------------------------|----|
| CCMR..... | 29 |
| KLDR, KLKR..... | 30 |
| BLF, BLN, FLM, FLQ, KKK, KLKD | 32 |

LEC/LEY series:

Accepts only Littelfuse Class CC fuses

| | |
|-----------------|----|
| CCMR..... | 29 |
| KLDR, KLKR..... | 30 |

Web Resources

Sample requests, downloadable CAD drawings and other technical information: www.littelfuse.com/leb
www.littelfuse.com/lec
www.littelfuse.com/lex
www.littelfuse.com/ley
www.littelfuse.com/let

Look for these part numbers featuring our improved design

- Better surface area for ergonomic comfort, improved grip and better torque
- More pronounced seating – automatically seats as user begins twisting
- Chamfered edges for additional installation comfort

| BASE PART NUMBER | PREVIOUS ORDERING NUMBER | NEW ORDERING NUMBER |
|------------------|--------------------------|---------------------|
| LEB-AA | OLEB00AAX | OLEB00AAXK |
| LEB-AA-S | OLEB0AASX | OLEB0AASXK |
| LEC-AA | OLEC00AAX | OLEC00AAXK |
| LEB-AB | OLEB00ABX | OLEB00ABXK |
| LEB-AYC-S | OLEBAYCSX | OLEBAYCSXK |
| LEB-BB | OLEB00BBX | OLEB00BBXK |
| LEB-JJ | OLEB00JXX | OLEB00JXXK |
| LEB-JJ-S | OLEB0JJSX | OLEB0JJSXK |

IN-LINE WATERTIGHT FUSE HOLDERS

Ordering Information

To order Littelfuse in-line fuse holders and disconnects by part number, refer to the charts on the next page.

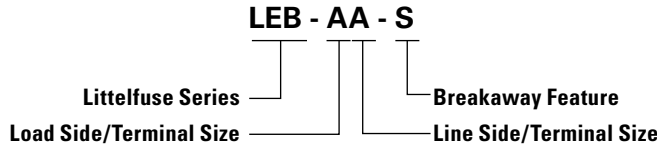

| FUSE HOLDER | DESCRIPTION |
|-------------|--|
| LEB | One-pole in-line fuse holder for Midget and Class CC fuses |
| LEC | One-pole in-line fuse holder for Class CC fuses |
| LET | One-pole in-line solid neutral disconnect |
| LEX | Two-pole in-line fuse holder for Midget and Class CC fuses |
| LEY | Two-pole in-line fuse holder for Class CC fuses |



Insulating Boots

- Molded from engineering-grade thermoplastics which provide high resistance to corrosive environments
- For watertight protection of non-breakaway Y-pole termination, order one WPB1 and one WPB3 boot

| ORDERING NUMBER | TERMINAL TYPE |
|-----------------|---------------|
| WPB1 | A, B, C, D, J |
| WPB3 | Y |

Recommended Crimping Tools

The following crimping tools or equivalents may be used on either the non-breakaway or breakaway watertight in-line fuse holders.

| TERMINAL SIZE | T&B PART NUMBER | BURNDY PART NUMBER |
|---------------|-----------------|--------------------|
| A | WT161M | – |
| B | WT161M | MR4C |
| C | M5-GREY | Hypress Y34A |
| D | M5-BROWN | Hypress Y34A |

Dimensions Inches

1-Pole

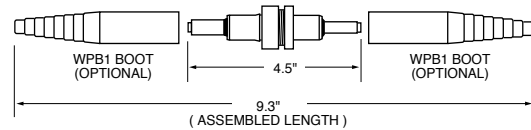

1-Pole Breakaway

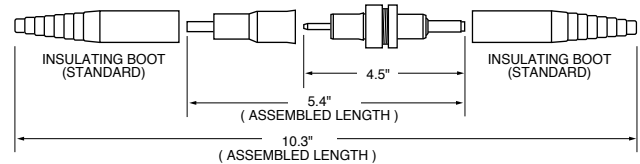

2-Pole

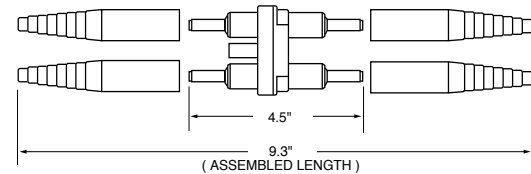

2-Pole Breakaway

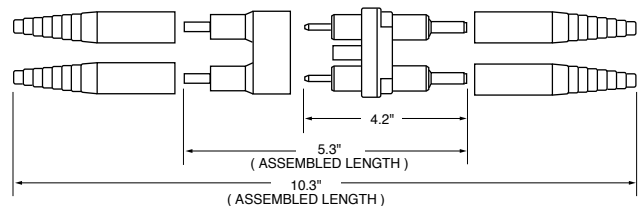

IN-LINE WATERTIGHT FUSE HOLDERS

Ordering Information (1-Pole LEB/LEC and 2-Pole LEX/LEY for Class CC and Midget Fuses)

| SINGLE POLE | | DOUBLE POLE | | LOAD TERMINAL SELECTION | | | | | LINE TERMINAL SELECTION | | | | |
|----------------------|------------------------|----------------------|------------------------|-------------------------|-------------------------------|------------------------------|-------------|---------------|---------------------------|-------------------------------|------------------------------|-------------|---------------|
| STANDARD PART NUMBER | BREAKAWAY PART NUMBER | STANDARD PART NUMBER | BREAKAWAY PART NUMBER | TERMINAL TYPE | LOAD TERMINAL WIRE SIZE RANGE | NUMBER OF WIRES PER TERMINAL | SOLID WIRE | STRANDED WIRE | TERMINAL TYPE | LINE TERMINAL WIRE SIZE RANGE | NUMBER OF WIRES PER TERMINAL | SOLID WIRE | STRANDED WIRE |
| LEB-AA LEC-AA | LEB-AA-S LEC-AA-S | LEX-AA LEY-AA | LEX-AA-S LEY-AA-S | Copper Crimp | #12 to #8 #12 | 1 2 | • • | • • | Copper Crimp | #12 to #8 #12 | 1 2 | • • | • • |
| LEB-AB LEC-AB | LEB-AB-S LEC-AB-S | LEX-AB LEY-AB | LEX-AB-S LEY-AB-S | Copper Crimp | #12 to #8 #12 | 1 2 | • • | • • | Copper Crimp | #10 #6 #4 | 2 1 1 | • • — | • • • |
| LEB-AC LEC-AC | — — | LEX-AC LEY-AC | — — | Copper Crimp | #12 to #8 #12 | 1 2 | • • | • • | Copper Crimp | #8 #4 | 2 1 | • — | • • |
| LEB-AD LEC-AD | — — | LEX-AD LEY-AD | — — | Copper Crimp | #12 to #8 #12 | 1 2 | • • | • • | Copper Crimp | #6 #2 | 2 1 | • — | • • |
| LEB-AJ LEC-AJ | LEB-AJ-S LEC-AJ-S | — — | — — | Copper Crimp | #12 to #8 #12 | 1 2 | • • | • • | Copper Set-Screw | #12 to #8 #10 to #2 | 1 1 | • — | — • |
| LEB-AYC LEC-AYC | LEB-AYC-S LEC-AYC-S | LEX-AYC LEY-AYC | LEX-AYC-S LEY-AYC-S | Copper Crimp | #12 to #8 #12 | 1 2 | • • | • • | "Y" Type Copper Set-Screw | #12 to #8 #10 to #2 | 1 1 | • — | — • |
| LEB-BA LEC-BA | LEB-BA-S LEC-BA-S | LEX-BA LEY-BA | LEX-BA-S LEY-BA-S | Copper Crimp | #10 #6 #4 | 2 1 1 | • • — | • • • | Copper Crimp | #12 to #8 #12 | 1 2 | • • • | • • • |
| LEB-BB LEC-BB | LEB-BB-S LEC-BB-S | LEX-BB LEY-BB | LEX-BB-S LEY-BB-S | Copper Crimp | #10 #6 #4 | 2 1 1 | • • — | • • • | Copper Crimp | #10 #6 #4 | 2 1 1 | • • — | • • • |
| LEB-BC LEC-BC | — — | LEX-BC LEY-BC | — — | Copper Crimp | #10 #6 #4 | 2 1 1 | • • — | • • • | Copper Crimp | #8 #4 | 2 1 | • — | • • |
| LEB-BD LEC-BD | — — | LEX-BD LEY-BD | — — | Copper Crimp | #10 #6 #4 | 2 1 1 | • • — | • • • | Copper Crimp | #6 #2 | 2 1 | • — | • • |
| LEB-BJ LEC-BJ | LEB-BJ-S LEC-BJ-S | — — | — — | Copper Crimp | #10 #6 #4 | 2 1 1 | • • — | • • • | Copper Set-Screw | #12 to #8 #10 - #2 | 1 1 | • — | — • |
| LEB-BYC LEC-BYC | LEB-BYC-S LEC-BYC-S | LEX-BYC LEY-BYC | LEX-BYC-S LEY-BYC-S | Copper Crimp | #10 #6 #4 | 2 1 1 | • • — | • • • | "Y" Type Copper Set-Screw | #12 to #8 #10 - #2 | 1 1 | • — | — • |
| LEB-CA LEC-CA | — — | LEX-CA LEY-CA | — — | Copper Crimp | #8 #4 | 2 1 | • — | • • | Copper Crimp | #12 to #8 #12 | 1 2 | • • • | • • • |
| LEB-CB LEC-CB | — — | LEX-CB LEY-CB | — — | Copper Crimp | #8 #4 | 2 1 | • — | • • | Copper Crimp | #10 #6 #4 | 2 1 1 | • • — | • • • |
| LEB-CC LEC-CC | — — | LEX-CC LEY-CC | — — | Copper Crimp | #8 #4 | 2 1 | • — | • • | Copper Crimp | #8 #4 | 2 1 | • — | • • |
| LEB-CD LEC-CD | — — | LEX-CD LEY-CD | — — | Copper Crimp | #8 #4 | 2 1 | • — | • • | Copper Crimp | #6 #2 | 2 1 | • — | • • |
| LEB-CJ LEC-CJ | — — | LEX-CJ LEY-CJ | — — | Copper Crimp | #8 #4 | 2 1 | • — | • • | Copper Set-Screw | #12 to #8 #10 - #2 | 1 1 | • — | • • |
| LEB-CYC LEC-CYC | — — | LEX-CYC LEY-CYC | — — | Copper Crimp | #8 #4 | 2 1 | • — | • • | "Y" Type Copper Set-Screw | #12 to #8 #10 to #2 | 1 1 | • — | — • |
| LEB-DA LEC-DA | — — | LEX-DA LEY-DA | — — | Copper Crimp | #6 #2 | 2 1 | • — | • • | Copper Crimp | #12 to #8 #12 | 1 2 | • • • | — • • |
| LEB-DB LEC-DB | — — | LEX-DB LEY-DB | — — | Copper Crimp | #6 #2 | 2 1 | • — | • • | Copper Crimp | #10 #6 #4 | 2 1 1 | • • — | • • • |
| LEB-DC LEC-DC | — — | LEX-DC LEY-DC | — — | Copper Crimp | #6 #2 | 2 1 | • — | • • | Copper Crimp | #8 #4 | 2 1 | • — | • • |
| LEB-DD LEC-DD | — — | LEX-DD LEY-DD | — — | Copper Crimp | #6 #2 | 2 1 | • — | • • | Copper Crimp | #6 #2 | 2 1 | • — | • • |
| LEB-DJ LEC-DJ | — — | LEX-DJ LEY-DJ | — — | Copper Crimp | #6 #2 | 2 1 | • — | • • | Copper Set-Screw | #12 to #8 #10 - #8 | 2 1 | • — | • • |
| LEB-DYC LEC-DYC | — — | LEX-DYC LEY-DYC | — — | Copper Crimp | #6 #2 | 2 1 | • — | • • | "Y" Type Copper Set-Screw | #12 to #8 #10 to #8 | 1 1 | • — | — • |
| LEB-JJ LEC-JJ | LEB-JJ-S LEC-JJ-S | LEX-JJ LEY-JJ | LEX-JJ-S LEY-JJ-S | Copper Set-Screw | #12 to #8 #10 to #2 | 1 1 | • — | — • | Copper Set-Screw | #12 to #8 #10 to #2 | 1 1 | • — | — • |
| LEB-JYC LEC-JYC | LEB-JYC-S LEC-JYC-S | — — | — — | Copper Set-Screw | #12 to #8 #10 to #2 | 1 1 | • — | — • | "Y" Type Copper Set-Screw | #12 to #8 #10 to #2 | 1 1 | • — | — • |

IN-LINE WATERTIGHT FUSE HOLDERS

Ordering Information (Solid Neutral LET Fuse Holders)

| STANDARD PART NUMBER | BREAKAWAY PART NUMBER | FUSE TYPE | LOAD TERMINAL SELECTION | | | | | LINE TERMINAL SELECTION | | | | |
|----------------------|-----------------------|---------------|-------------------------|-------------------------------|------------------------------|-------------|---------------|---------------------------------|-------------------------------|------------------------------|-------------|---------------|
| | | | TERMINAL TYPE | LOAD TERMINAL WIRE SIZE RANGE | NUMBER OF WIRES PER TERMINAL | SOLID WIRE | STRANDED WIRE | TERMINAL TYPE | LINE TERMINAL WIRE SIZE RANGE | NUMBER OF WIRES PER TERMINAL | SOLID WIRE | STRANDED WIRE |
| LET-AA | LET-AA-S | Solid Neutral | Copper Crimp | #12 to #8 #12 | 1 2 | • • | • • | Copper Crimp | #12 to #8 #12 | 1 2 | • • | • • |
| LET-AB | LET-AB-S | Solid Neutral | Copper Crimp | #12 to #8 #12 | 1 2 | • • | • • | Copper Crimp | #10 #6 #4 | 2 1 1 | • • — | • • • |
| LET-AYC | LET-AYC-S | Solid Neutral | Copper Crimp | #12 to #8 #12 | 1 2 | • • | • • | "Y" Type Copper Set-Screw | #12 to #8 #10 to #2 | 1 1 | • — | — • |
| LET-BA | LET-BA-S | Solid Neutral | Copper Crimp | #10 #6 #4 | 2 1 1 | • • — | • • • | Copper Crimp | #12 to #8 #12 | 1 2 | • • | • • |
| LET-BB | LET-BB-S | Solid Neutral | Copper Crimp | #10 #6 #4 | 2 1 1 | • • — | • • • | Copper Crimp | #10 #6 #4 | 2 1 1 | • • — | • • • |
| LET-BYC | LET-BYC-S | Solid Neutral | Copper Crimp | #10 #6 #4 | 2 1 1 | • • — | • • • | "Y" Type Copper Set-Screw | #12 to #8 #10 to #2 | 1 1 | • — | — • |
| LET-JJ | LET-JJ-S | Solid Neutral | Copper Set-Screw | #12 to #8 #10 to #2 | 1 1 | • — | — • | Copper Set-Screw | #12 to #8 #10 to #2 | 1 1 | • — | — • |
| LET-JYC | LET-JYC-S | Solid Neutral | Copper Set-Screw | #12 to #8 #10 to #2 | 1 1 | • — | — • | "Y" Type Copper Set-Screw | #12 to #8 #10 to #2 | 1 1 | • — | — • |

Ordering Information (Terminals)

| TERMINAL DESIGNATION | TERMINAL DESCRIPTION | NUMBER OF WIRES PER TERMINAL | WIRE RANGE | SOLID WIRE | STRANDED WIRE |
|----------------------|----------------------------|------------------------------|------------|------------|---------------|
| A | Copper Crimp | 1 | #12-#8 | • | • |
| | | 2 | #12 | • | • |
| | | 2 | #10 | • | • |
| B | Copper Crimp | 1 | #6 | • | • |
| | | 1 | #4 | — | • |
| | | 2 | #8 | • | • |
| C | Copper Crimp | 1 | #4 | — | • |
| | | 2 | #6 | • | • |
| D | Copper Crimp | 1 | #2 | — | • |
| | | 1 | #2 | — | • |
| J | Copper Set-Screw | 1 | #12-#8 | • | — |
| | | 1 | #10-#2 | — | • |
| Y (2 terminals) | "Y" Style Copper Set-Screw | 1 | #12-#8 | • | — |
| | | 1 | #10-#2 | — | • |

IN-LINE WATERTIGHT FUSE HOLDERS

Two-Pole Breakaway Holder



Features/Benefits

- LEXT-YY version has a permanently installed “neutral” slug to prevent the neutral from accidentally being fused
- LEX-YYC version allows for fusing of line-to-line loads or other applications requiring two fuses to disconnect under strain
- Fiberglass polymer body resists damage from impact
- Four “Y” type set-screw terminals accommodate a wide range of solid and stranded Cu or Al conductors
- O-ring and terminal boots form watertight seal, preventing leakage

Specifications

| | |
|----------------------------|--|
| Part numbers | LEXT-YY-S (Solid neutral) LEX-YYC-S |
| Voltage Rating | 600 VAC/VDC |
| Ampere Rating | 30 A |
| Interrupting Rating | 200 kA with Class CC Fuses |
| Y Terminals | Tin Plated Copper w/ set screws |
| Wire Size | 1 solid #12 to #8 or 1 stranded #10 to #2 |
| Approvals | UL Recognized (File E14721) CSA Certified (File LR7316) |

Applications

- Street lighting
- Marinas
- Travel trailer parks and other locations where fuse holders may be exposed to physical strain

Web Resources

Sample requests, downloadable CAD drawings and other technical information: www.littelfuse.com/lex
www.littelfuse.com/lex

Description

New Littelfuse LEXT-YY-S and LEX-YYC-S series breakaway fuse holders meet state and federal highway commission safety standards requiring fuse holders to readily disconnect from power in case of a pole knockdown.

The breakaway feature consists of a receptacle permanently attached to the power line and a fuse holder with matching terminals. If a knockdown occurs, the parts separate, leaving the energized conductor recessed and unexposed.

Ordering Information

| ORDERING NUMBER | FUSE TYPE | LOAD TERMINAL SELECTION | | | | | | LINE TERMINAL SELECTION | | | | |
|-----------------|------------|-------------------------|-------------------------------|------------------------------|------------|---------------|---------------|-------------------------------|------------------------------|------------|---------------|---|
| | | TERMINAL TYPE | LOAD TERMINAL WIRE SIZE RANGE | NUMBER OF WIRES PER TERMINAL | SOLID WIRE | STANDARD WIRE | TERMINAL TYPE | LINE TERMINAL WIRE SIZE RANGE | NUMBER OF WIRES PER TERMINAL | SOLID WIRE | STANDARD WIRE | |
| LEXTYYSS | LEXT0YYSSX | Midget Class CC | “Y” type Copper Set-Screw | #12 to #8 | 1 | • | — | “Y” type Copper Set-Screw | #12 to #8 | 1 | • | — |
| | | | | #10 to #2 | 1 | — | • | | #10 to #2 | 1 | — | • |
| LEXYYS | OLEXYYSX | Midget Class CC | “Y” type Copper Set-Screw | #12 to #8 | 1 | • | — | “Y” type Copper Set-Screw | #12 to #8 | 1 | • | — |
| | | | | #10 to #2 | 1 | — | • | | #10 to #2 | 1 | — | • |

IN-LINE WATERTIGHT FUSE HOLDERS

Two-Pole Breakaway Holder

Dimensions Inches

LEXT-YY-S

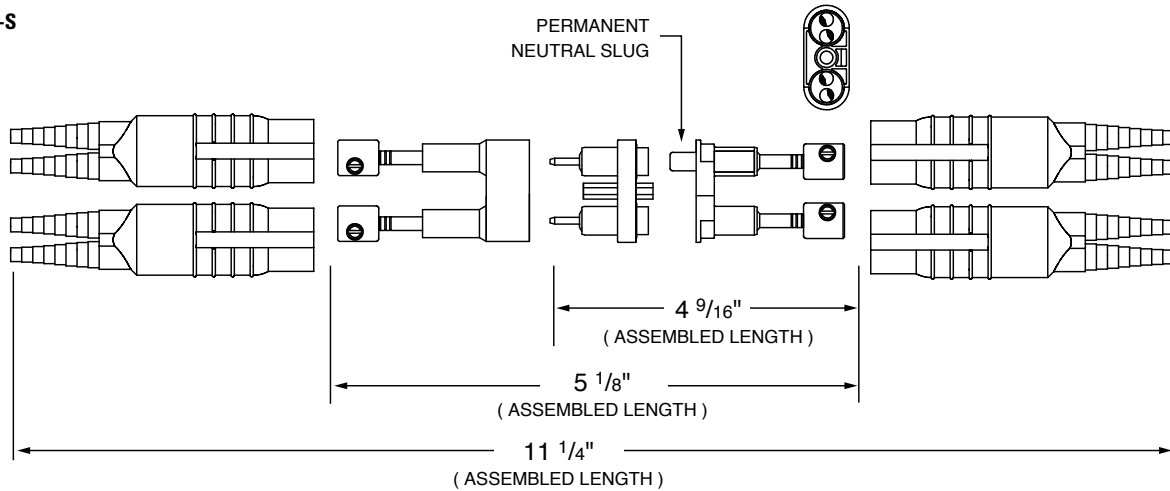

LEX-YY-C-S

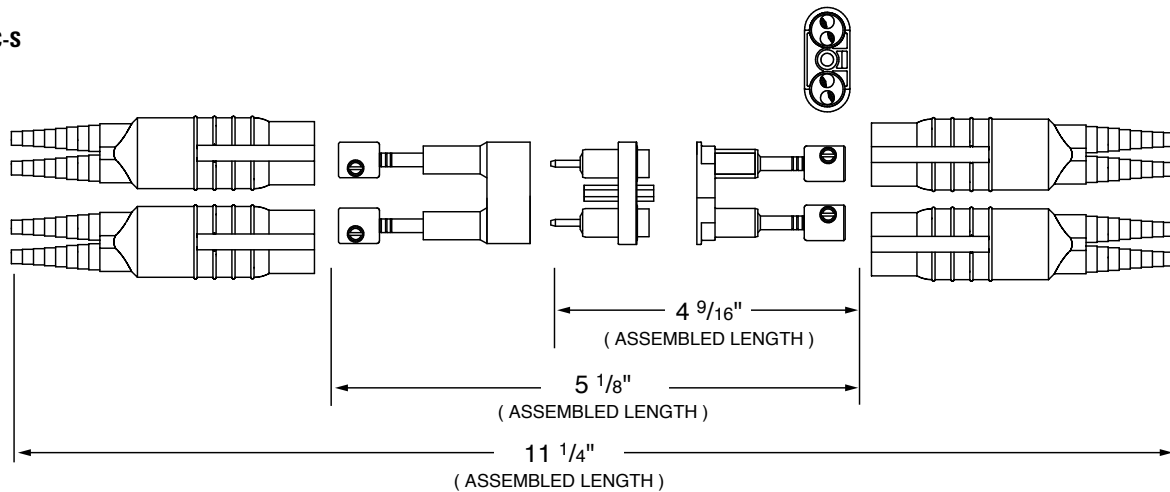

Recommended Fuses

| | |
|--|----|
| Class CC Littelfuse types: CCMR, KLDL, KLKR..... | 29 |
| Midget Littelfuse types: BLF, BLN, FLM, FLO, KLK, KLKD | 32 |

Four WPB3 insulating boots come standard with the LEXT-YY-S and LEX-YY-C-S fuse holders. Molded from non-conductive engineering grade thermoplastic to deliver a watertight seal in corrosive environments, they can be trimmed to the specific conductor size insuring a snug fit.

Section Overview

POWR-GARD's Pre-Engineered Solutions include custom-built electrical panels designed specifically to meet NEC® requirements, as well as fused and non-fused disconnect switches.



PRE-ENGINEERED SOLUTIONS

Table of Contents

| | |
|---|-----|
| LCP Fused Selective Coordination Panel..... | 140 |
| LPS Series POWR-Switch (Shunt Trip Disconnect)..... | 142 |
| LPMP Series POWR-Switch Panel | 144 |
| Specifier Tool for LCP Coordination Panel | 146 |

Meet NEC[®] Requirements and Save Time with Littelfuse Pre-Engineered Solutions



LCP Series Coordination Panel

Ideal for circuits that require selective coordination such as emergency lighting circuits or essential electrical systems.



LPS Series POWR-Switch

Individual fusible shunt trip disconnect switch easily coordinates with system's overcurrent protection. Typical applications include elevator circuits.



LPMP Series POWR-Switch Panel

Fusible panel board with shunt trip capabilities for the control of power to a bank of equipment. Typical applications include elevator circuits.

LCP FUSED COORDINATION PANEL

Selective Coordination Panel



Description

The Littelfuse® Coordination Panel provides a simple, time-saving solution for circuits that require selective coordination. This UL Listed product saves time and money, and increases safety by minimizing system downtime.

Applications

- Elevators
- Hospitals
- Hotel and Entertainment Industry
- Amusement Parks and Stadiums

Code Requirements

Systems required by the NEC® to be selectively coordinated include:

- Health Care Essential Electrical Systems (NEC 517.26)
- Elevators (NEC 620.62)
- Emergency Systems (NEC 700.27)
- Legally Required Standby Systems (NEC 701.18)
- Critical Operations Power Systems (NEC 708.54)

Features/Benefits

- Meets NEC® requirements
- Class CC and J fuse holders have built-in open-circuit indication
- Fast-acting UL Listed fuses protect against short circuits
- Feed through/sub feed lugs and 84-circuit configuration available
- Ground and neutral bars
- Copper bus standard

Advanced Design Options

- MLO, Main Circuit Breaker, or Main Fused Pullout device
- Fused Class T branch circuit pullout
- Spare fuse cabinet accessory (holds six spare fuses)
- TVSS overvoltage protection
- Any NEMA enclosure required
- High amperage sub-fed branch breakers (J60A)
- Unique Specifier Tool (see pg. 146) to easily identify panel configurations from tens of thousands of options

Specifications

| | |
|----------------------------|---|
| Voltage Ratings | 120/208, 120/240, 277/480 VAC |
| Main Bus Rating | 100 A - 400 A Standard |
| Conductor Terminals | 6 AWG - 300 kcmil |
| SCCR | 100 kA Max* |
| UL Listed | UL 67 Panel boards and UL 50 Enclosures |

*The following current-limiting fuses must be used directly upstream for 100kA SCCR.
 1. 120/208 Volt Panels – LLNRK 100 A max, JTD_ID 200 A max, or JLLN 200 A max
 2. 120/240 Volt Panels – LLSRK_ID 200 A max, JTD_ID 200 A max, or JLLS 200 A max
 3. 277/480 Volt Panels – LLSRK_ID 200 A max, JTD_ID 200 A max, or JLLS 200 A max

Web Resources

Fuse Curves, sample requests, downloadable CAD drawings and other technical information: www.littelfuse.com/lcp

To quickly specify the LCP panel, visit www.littelfuse.com/lcp and download the Specifier Tool.

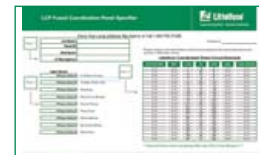

Customizable Options (select one from each column)

| NUMBER OF CIRCUITS | VOLTAGE | MAIN DEVICES | NEUTRAL RATING | PANEL MOUNTING | PANEL DOOR | FUSE HOLDERS | BRANCH CIRCUIT PROTECTION DEVICES (1-3 POLE)† | PANEL FEED | OPTIONAL LUGS | STANDARD ENCLOSURE RATING |
|--------------------|-------------------|--------------------------------------|----------------|----------------|--------------|---------------|---|--------------|---------------|---------------------------|
| 2 - 42 | 120/208 V 3P, 4 W | 125, 225, 400 or 600 A MLO | 100% | Surface | Standard | 30 A Class CC | 10 A - 60 A fused circuit breaker | Top | None | NEMA 1 |
| | 120/240 V 1P, 3 W | Up to 600 A MCB or Main Fuse Pullout | 200% | Flush | Door-in-door | 60 A Class J | 60 A - 200 A fused pullouts | | Bottom | Sub-Fed (MLO panels) |
| | 277/480 V 3P, 4 W | | | | | | >60 A (not fused) | Feed-Through | | NEMA 4X |

†Fuses quoted separately to meet panel specifications. Coordination for breakers >60 A depends on upstream and downstream devices. More specialized configurations are also available. Contact factory for more information.

Note: The Littelfuse LPS, LPMP and LCP products are custom designed products that fall outside standard specifications.

LCP FUSED COORDINATION PANEL

Selective Coordination Panel

Dimensions mm (inches)

Standard Coordination Panel Board (up to 30 circuits)

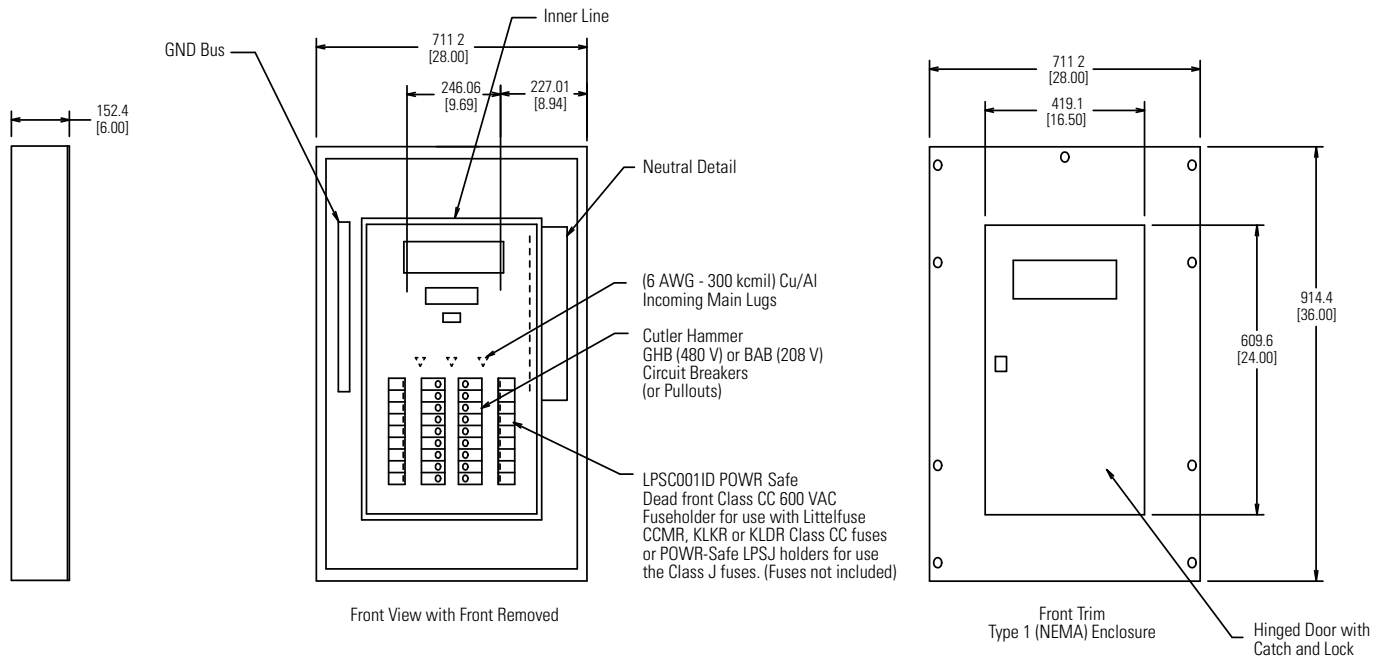

Standard Coordination Panel Board (31-42 circuits)

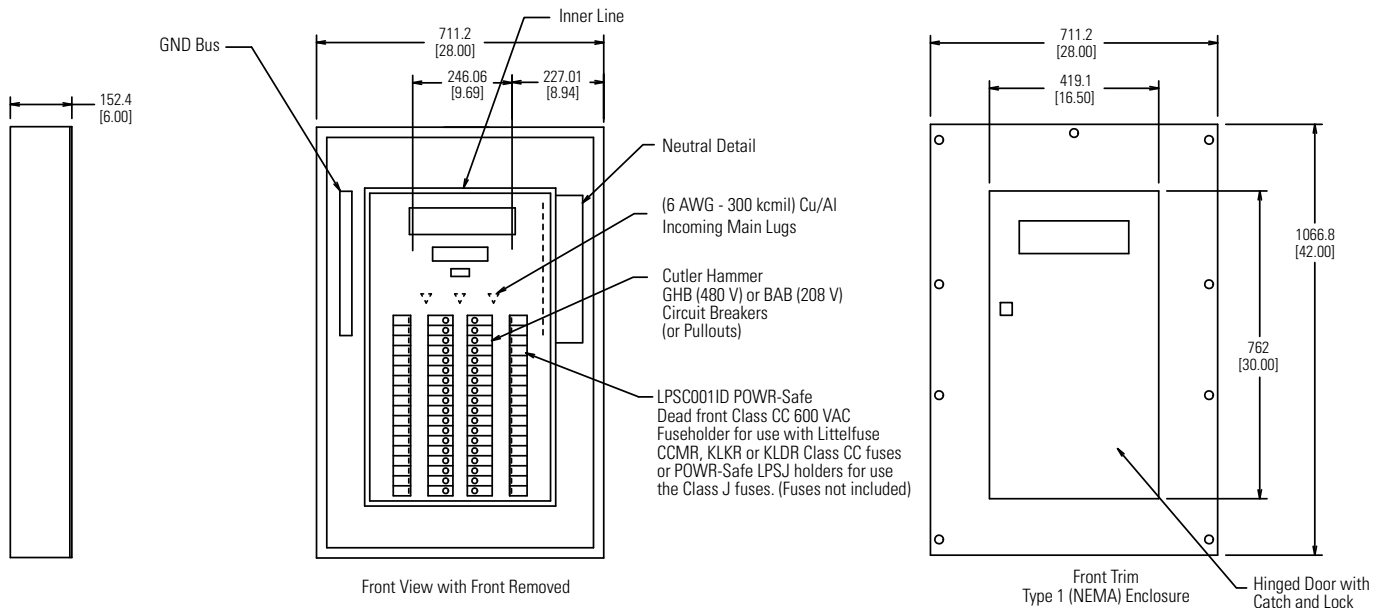

To quickly specify the LCP panel, visit www.littelfuse.com/lcp and download the Specifier Tool

Note: The Littelfuse LPS, LPMP and LCP products are custom designed products that fall outside standard specifications.

Dimensions may change depending on panel components. More specialized configurations are also available. Contact factory for more information.

LPS SERIES POWR-SWITCH

Shunt Trip Disconnect Switch



POWR-Switch 7

Description

The Littelfuse® POWR-Switch provides a simple and economical solution for applications that require selective coordination and shunt trip capabilities.

Utilizes Class J time-delay fuses that are easily coordinated with other system overcurrent devices. The shunt trip capability allows the POWR-Switch to meet the ANSI/ASME standard that requires power to be automatically disconnected before water is turned on by the fire safety system.

Applications

- Elevator circuits
- Data processing rooms
- Building emergency systems

Specifications

| | |
|----------------------------|--|
| Voltage Rating* | 208 V, 240 V, 480 V |
| Interrupting Rating | 200 kA |
| Shunt Trip | 120 V |
| Enclosures | NEMA 1 (standard) NEMA 3R, NEMA 4, NEMA 12 (optional) |
| Approvals | UL Listed CSA Certified |

*Contact factory for 600 V and other options.

Features/Benefits

- Pre-engineered single unit, which makes procurement easier than systems with multiple components
- Reduces labor costs up to 66% and total installation costs by over 30%
- Optional features offer flexibility for a variety of applications
- Control power terminal block
- UL Listed package
- Lockable operating handle
- Cu and Al wire rated
- Pre-wired control circuits lower installation time
- Lockable operating handle meets all code and safety requirements
- Every unit is fully tested before delivery

Options

- Control power transformer with fuses and blocks
- Fire safety interface relay
- Key to test switch
- Pilot light "On"
- Isolated neutral lug
- Mechanical interlock auxiliary contact for hydraulic elevators with automatic recall (5 amp 120 VAC rated)
- Fire alarm voltage monitoring relay
- Option to bypass alarm when performing maintenance (AZ option)

Web Resources

Downloadable CAD drawings, Maintenance and Operation Manuals, and other technical information:

www.littelfuse.com/lps

Note: The Littelfuse LPS, LPMP and LCP products are custom designed products that fall outside standard specifications.

More specialized configurations are also available. Contact factory for more information.

LPS SERIES POWR-SWITCH

Shunt Trip Disconnect Switch



Ordering Information

Complete catalog numbers consist of switch catalog numbers and the desired options. See example below.

Example Catalog Number from Desired Options

LPS1 T20 R1 K N1 U - AZ = Littelfuse Catalog Number LPS1T20R1KN1UAZ

| LITTELFUSE SWITCH CATALOG NUMBER | CONTROL POWER TRANSFORMER STD. 100VA WITH PRI & SEC FUSE (120 V SEC.) | | | FIRE SAFETY INTERFACE RELAY (3 PDT, 10 A, 120 V) | | KEY TO TEST SWITCH | | PILOT LIGHT "ON" | | ISOLATED NEUTRAL LUG | | MECHANICAL INTERLOCK AUX. CONTACT FOR HYDRAULIC ELEVATORS W/ AUTOMATIC RECALL (5 A, 120 VAC) | | FIRE ALARM SHUNT TRIP VOLTAGE MONITORING RELAY | | OPTIONAL ENCLOSURES | | AZ OPTION (BYPASS FIRE ALARM DURING MAINT. TEST) | |
|----------------------------------|---|--------|--------|--|--------|--------------------|--------|------------------|--------|----------------------|--------|--|--------|--|--------|---------------------|--------|--|-------------|
| | BASE CATALOG # | RATING | RATING | OPTION CODE | RATING | OPTION CODE | RATING | OPTION CODE | RATING | OPTION CODE | RATING | OPTION CODE | RATING | OPTION CODE | RATING | OPTION CODE | RATING | OPTION CODE | OPTION CODE |
| LPS3* | 30 A | 208 V | T20 | 24 VDC Coil | R2 | 120 V | K | Red | R | 30-60 A | N6 | 1 NO & 1 NC | A | 1-Pole | F1 | NEMA 3R | U | - | AZ |
| LPS6* | 60 A | 240 V | T24 | 120 VAC Coil | R1 | | | Green | G | 100 A | N1 | 2 NO & 2 NC | B | 3-Pole | F3 | NEMA 4 | Y | - | AZ |
| LPS1* | 100 A | 480 V | T48 | | | | | White | W | 200 A | N2 | | | | | NEMA 12 | Z | - | AZ |
| LPS2* | 200 A | | | | | | | | | 400 A | N4 | | | | | | | - | AZ |
| LPS4* | 400 A | | | | | | | | | | | | | | | | | - | AZ |

*Part Numbers: Any voltage can be paired with any amperage. Options can be any combination but the ratings must match the option code. Not all options are required. Contact factory for details.

Contact factory for 600 V and other options.

Note: When ordering - desired options must be listed in the order shown above. Typical options include Control Power Transformer, Fire Safety Interface Relay, Mechanical Interlock Auxiliary Contact and Fire Alarm Voltage Monitoring Relay.

Dimensions of Enclosure

| CATALOG SERIES | AMPERE RATING | NEMA 1 DIMENSIONS | NEMA 3R DIMENSIONS | NEMA 4, 12 DIMENSIONS | LUG SIZE |
|----------------|---------------|--------------------|--------------------|-----------------------|------------------------|
| LPS3 | 30 | 24"H x 20"W x 9"D | 26"H x 20"W x 8"D | 24"H x 20"W x 10"D | #14 - #8 AL or CU |
| LPS6 | 60 | 24"H x 20"W x 9"D | 26"H x 20"W x 8"D | 24"H x 20"W x 10"D | #14 - #2 AL or CU |
| LPS1 | 100 | 24"H x 20"W x 9"D | 26"H x 20"W x 8"D | 24"H x 20"W x 10"D | #8 - 1/0 AL or CU |
| LPS2 | 200 | 30"H x 20"W x 9"D | 32"H x 20"W x 8"D | 30"H x 20"W x 10"D | #6 - 250kcmil AL or CU |
| LPS4 | 400 | 48"H x 36"W x 12"D | Contact Factory | Contact Factory | 3/0 AL or CU |

Note: Over-size enclosures used to accommodate control power transformer, interface relay and terminal blocks.

Specifications (Shunt Trip)

| | |
|-------------------------|--------------|
| Voltage Rating | 120 V, 60 Hz |
| Ampere Range | 30-400 A |
| Max Inrush | 4 A |
| Max On time | 1.5 cycles |
| Momentary Inrush | 140 VA |

Note: The Littelfuse LPS, LPMP and LCP products are custom designed products that fall outside standard specifications.

More specialized configurations are also available. Contact factory for more information.

LPMP SERIES POWR-SWITCH PANEL

600 Volts • Shunt-Trip Disconnect Switch



POWR-Switch Panel 7

Features/Benefits

- Cost effective solution when multiple elevator switches are needed
- UL Listed package
- NEMA 1 Enclosure
- Fusible Class J Switches (rated 30 A – 400 A)
- 200 kA RMS SCCR

Optional Features

- Control Power Transformers
- Fire Safety Interface Relay
- Key to Test Switch
- Pilot Light "On"
- Mechanical Interlock Auxiliary Contact (for hydraulic elevators with recall)
- Fire Alarm Voltage Monitor Relay
- NEMA 3R Enclosures

Ordering Information

| SERIES | AMPERAGE | BASE PART NUMBER | CATALOG/ORDERING NUMBER |
|--------|----------|------------------|-------------------------|
| LPMP | 400 | LPMP 400 | Custom |
| LPMP | 600 | LPMP 600 | Custom |
| LPMP | 800 | LPMP 800 | Custom |

Note: Many configurations outside the standard design options can be designed. Contact factory for details

Specifications

| | |
|-----------------------------|--|
| Voltage Rating | 600 V |
| Short-Circuit Rating | 200 kA RMS |
| Ampere Ratings | 400, 600, 800 A |
| Approvals | UL Listed to UL 67 Panel boards and UL 891 Dead Front Switches |

Web Resources

Downloadable CAD drawings, FAQs, and other technical information: www.littelfuse.com/lpmp

Note: The Littelfuse LPS, LPMP and LCP products are custom designed products that fall outside standard specifications.

More specialized configurations are also available. Contact factory for more information.

Description

Littelfuse LPMP series POWR-Switch Panel is designed specifically for applications that require shunt-trip capabilities.

The POWR-Switch Panel offers the flexibility to incorporate multiple switches into a single panel enclosure and meet all applicable code requirements, reducing wiring costs.

Applications

- Elevator circuits
- Building emergency systems
- Hotels / Entertainment Industry
- Dormitories / Apartment Complexes

LPMP SERIES POWR-SWITCH PANEL

600 Volts • Shunt-Trip Disconnect Switch



Panel Spacing

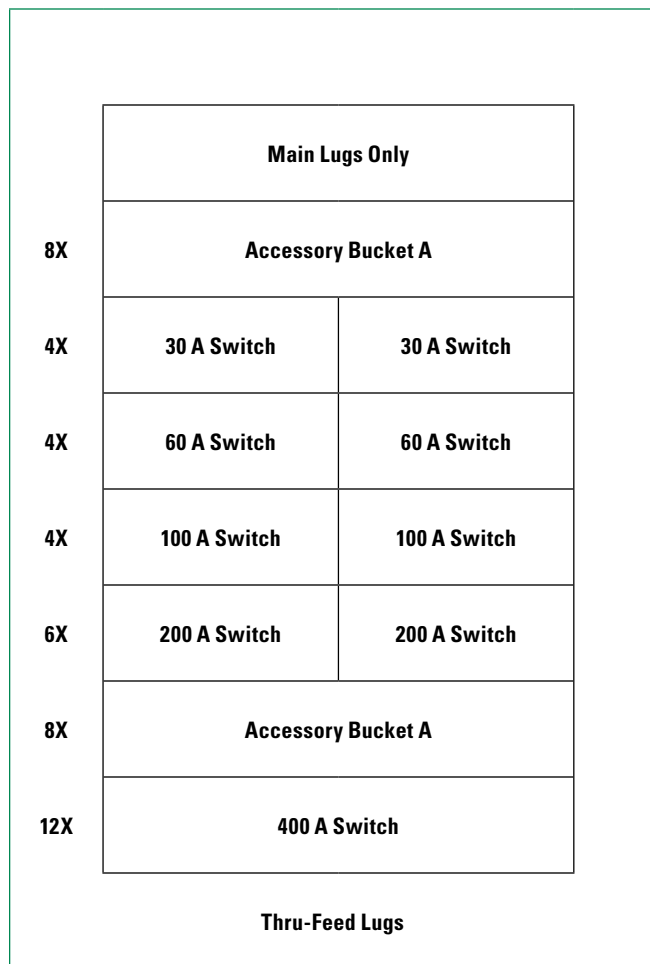

Note: Main Lug Only is standard.

Standard Panel Dimensions

| DIMENSIONS (INCHES) H X W X D | AVAILABLE SPACE (X UNITS) | |
|----------------------------------|---------------------------|--------|
| | 3 WIRE | 4 WIRE |
| 57 x 40 x 12 | 18 X | 16 X |
| 73.5 x 40 x 12 | 26 X | 24 X |
| 90 x 40 x 12 | 38 X | 35 X |

Note: "X" Space = 1 3/8 inches (refers to height only)

Main Lug Terminal Information

| PANEL RATING | COND./PHASE | WIRE RANGE | BENDING SPACE | |
|--------------|-------------|--------------------------|---------------|--------|
| | | | TOP/BOT. | SIDE |
| 400 A | (2) | # 6 - 300 kcmil Al or Cu | 11.31" | 10.00" |
| | (1) | 3/0 - 750 kcmil Al or Cu | | |
| 600 A | (2) | 3/0 - 500 kcmil Al or Cu | 11.31" | 10.00" |
| 800 A | (3) | 3/0 - 500 kcmil Al or Cu | 11.31" | 10.00" |
| | (2) | 3/0 - 750 kcmil Al or Cu | | |

Note: Local codes may change minimum wire bends.

Note: The Littelfuse LPS, LPMP and LCP products are custom designed products that fall outside standard specifications.

More specialized configurations are also available. Contact factory for more information.

POWR-Switch Panel "Bucket" Options

| BUCKET/SWITCH RATING | DESCRIPTION | SPACE | CONDUCTORS PER PHASE | WIRE RANGE |
|--|---------------------------------|-------|----------------------|--------------------------|
| 30/30 | Twin 30 A switches | 4X | (1) | # 14 - # 8 Al or Cu |
| 30 | Single 30 A switch | 4X | (1) | # 14 - # 8 Al or Cu |
| 60/60 | Twin 60 A switches | 4X | (1) | # 14 - # 2 Al or Cu |
| 60 | Single 60 A switch | 4X | (1) | # 14 - # 2 Al or Cu |
| 100/100 | Twin 100 A switches | 4X | (1) | # 8 - 1/0 Al or Cu |
| 100 | Single 100 A switch | 4X | (1) | # 8 - 1/0 Al or Cu |
| 200/200 | Twin 200 A switches | 6X | (1) | # 6 - 250 kcmil Al or Cu |
| 200 | Single 200 A switch | 6X | (1) | # 6 - 250 kcmil Al or Cu |
| 400 | Single 400 A switch | 12X | (2) | 3/0 - 750 kcmil Al or Cu |
| Accessory Bucket A -or- Accessory Bucket B | 1 required for every 4 switches | 8X | N/A | N/A |
| | 1 required for every 6 switches | 12X | N/A | N/A |

EXCEL® SPECIFIER TOOL FOR LCP COORDINATION PANEL

Simplify Communication and Minimize Errors

A Microsoft Excel® spreadsheet designed to help engineers and contractors clearly convey which technical components they would like incorporated into the Littelfuse Coordination Panel.

- Easily specify technical components of your panels/system
- Quickly and accurately captures desired electrical protection devices
- Effectively manage each job with up-to-date information
- Ensures all pertinent information is captured to prevent unnecessary delays

Get Started Today!

1. Download The Specifier from www.littelfuse.com/lcp or request it from your Littelfuse sales representative
2. Fill it out to identify what you need (See sample below)
3. Send it back to Littelfuse and get a quick quote
4. Automatically generate your custom Bill of Material and base part number

LCP Panel Specifier Tool 7

LCP Fused Coordination Panel Specifier

Expertise Applied | Answers Delivered

Fax to Your Local Littelfuse Rep Agency or Call 1-800-TEC-FUSE

Step 1

| | |
|----------------|------------------------|
| Job Name: | LCP42C-Sample |
| Panel ID: | H1EM1 |
| Distributor: | Littelfuse Distributor |
| LF Rep Agency: | Littelfuse Reps |

LF Quote # _____

Please configure individual feeder circuits by selecting fuse holder and breaker placement and size in Drop down menus.

Littelfuse Coordination Panel Circuit Schedule

| FUSE HOLDER | BKR | CKT# | PH. | CKT# | BKR | FUSE HOLDER |
|---------------|----------|------|-----|------|----------|---------------|
| 30A CC Holder | 20/1 | 1 | A | 2 | **20/3** | 30A CC Holder |
| 30A CC Holder | 20/1 | 3 | B | 4 | **/3** | 30A CC Holder |
| 30A CC Holder | 20/1 | 5 | C | 6 | **/3** | 30A CC Holder |
| 30A CC Holder | 20/1 | 7 | A | 8 | **20/3** | 30A CC Holder |
| 30A CC Holder | 20/1 | 9 | B | 10 | **/3** | 30A CC Holder |
| 60A J Holder | **60/3** | 11 | C | 12 | **/3** | 30A CC Holder |
| 60A J Holder | **/3** | 13 | A | 14 | **20/3** | 30A CC Holder |
| 60A J Holder | **/3** | 15 | B | 16 | **/3** | 30A CC Holder |
| 30A CC Holder | 20/1 | 17 | C | 18 | **/3** | 30A CC Holder |
| 30A CC Holder | 20/1 | 19 | A | 20 | 20/1 | 30A CC Holder |
| 30A CC Holder | 20/1 | 21 | B | 22 | 20/1 | 30A CC Holder |
| 30A CC Holder | 20/1 | 23 | C | 24 | 20/1 | 30A CC Holder |
| 30A CC Holder | 20/1 | 25 | A | 26 | 20/1 | 30A CC Holder |
| 30A CC Holder | 20/1 | 27 | B | 28 | 20/1 | 30A CC Holder |
| 30A CC Holder | 20/1 | 29 | C | 30 | 20/1 | 30A CC Holder |
| 30A CC Holder | 20/1 | 31 | A | 32 | 20/1 | 30A CC Holder |
| 30A CC Holder | 20/1 | 33 | B | 34 | 20/1 | 30A CC Holder |
| 30A CC Holder | 20/1 | 35 | C | 36 | 20/1 | 30A CC Holder |
| 30A CC Holder | 20/1 | 37 | A | 38 | 20/1 | 30A CC Holder |
| 30A CC Holder | 20/1 | 39 | B | 40 | **60/2** | 60A J Holder |
| 30A CC Holder | 20/1 | 41 | C | 42 | **/2** | 60A J Holder |

Consult Factory when specifying 2 Pole and 3 Pole Circuit Breakers

Step 2

| | | |
|--------------------------|----|----------------------|
| Input Values | 42 | # of Panel Circuits |
| 277/480V 3 Phase, 4 Wire | | Voltage, Phase, Wire |
| Flush Mount | | Mounting |
| 200A Main Breaker | | Main Circuit Breaker |
| 200% | | Neutral Rating |
| Bottom Feed | | Panel Feed |
| Feed Through Lugs | | Panel Options |
| Type 3R | | Enclosure Rating |
| Door in Door | | Panel Door |

Step 3

Bill of Materials

| Part Numbers | | Quantity | |
|--|------------------------|-----------------|----|
| Base Part Number: LCP 42 C 1 | | | |
| Options From above: | | | |
| Mounting: | Flush Mount | 1 | |
| Main Circuit Breaker: | 200A Main Breaker | 1 | |
| Neutral Rating: | 200% | 1 | |
| Panel Feed: | Bottom Feed | 1 | |
| Panel Options: | Feed-Through Lugs | 1 | |
| Enclosure Rating: | Type 3R | 1 | |
| Panel Door: | Door-in-Door | 1 | |
| Enter Breaker Quantities From Above Panel Schedule | | | |
| Select Poles | Breaker | Select Amperage | |
| 1 | Breaker | 20 | 31 |
| 3 | Breaker | 20 | 3 |
| 2 | Breaker | 60 | 1 |
| | Breaker | | 0 |
| | Breaker | | 0 |
| | Breaker | | 0 |
| | Breaker | | 0 |
| | Breaker | | 0 |
| | Breaker | | 0 |
| Fuseholder Quantities Calculate Automatically | | | |
| | 30 Amp Class CC Holder | | 40 |
| | 60 Amp Class J Holder | | 2 |

Easy identification for project tracking

Identify specific panel options

Automatically generates base part number

Automatically tabulates your Bill of Material to keep an accurate count

Panel circuit schedule identifies specific branch circuit protection devices each panel needs

Section Overview

Our comprehensive line of single- and multi-function protection relays safeguard equipment and personnel in order to prevent expensive damage, downtime or injury due to electrical faults.

The features and flexibility within the products and the software allow you to select the appropriate protection for each part of your electrical system.



PROTECTIONS RELAYS AND CONTROLS

Table of Contents

| | |
|--|-----|
| Feature Comparisons | 150 |
| Ground-Fault Protection | 152 |
| Trailing Cable Protection..... | 155 |
| Resistance Grounding and NGR Monitoring | 156 |
| Motor Protection | 158 |
| Pump and Feeder Protection | 160 |
| Arc-Flash Protection and GFCI..... | 161 |
| Generator and Single-Function Protection | 162 |
| Generator Control..... | 167 |
| Engine Control and Diagnosis | 171 |
| Alarm Monitoring | 172 |
| Custom Products..... | 174 |
| Accessories..... | 175 |

Download our full
Relay and Controls Catalog



For more information on relays and controls or to download our full-line relay catalog, visit

www.littelfuse.com/relayscontrols.

A Full Range of **PROTECTION RELAYS &**

Why are Protection Relays Necessary?

Protection relays safeguard critical components of an electrical circuit from damage. When the relay detects a potentially damaging or unsafe condition, the relay will send an alarm or trip signal in order to notify personnel or prevent the condition from continuing.

Protection relays increase the uptime of critical systems and enhance the safety of people and equipment during fault situations.



We Improve Electrical Safety and Increase Uptime

For decades Littelfuse has been helping customers improve their electrical systems. In addition to well-designed products, our technical expertise brings years of experience and product design support to your application.

We can provide immediate access to specialized technical resources, online references or field application support. This catalog outlines the Littelfuse line of protection relays, custom products, generator and engine controls, and alarm and annunciator systems, plus the technical capabilities we offer for your application.



Safety

- Shock Hazard
- Injury to Personnel
- Arc-Flash Hazards
- Open-CT Hazards
- Failed Resistors



Cost

- Fault Damage
- Equipment Replacement
- Calibration Costs
- Compliance Citations
- Motor Rewinds



Downtime

- Replacement Time
- Nuisance Tripping
- Intermittent Faults
- Unreliable Protection
- Calibration Time

For All Harsh Environments

- Petrochemical, Oil and Gas
- Pipelines and Transportation
- Aggregate and Cement
- Mining
- Pulp and Paper
- Water and Waste Water
- Shore-to-Ship Power
- Marine
- Data Centers
- Semiconductor Equipment
- Hospitals
- Alternative Energy
- Power Generators

CONTROLS for the Harshest Environments



GENERATOR PROTECTION & CONTROL

Our line of generator protection and control equipment offers synchronizing, frequency control, load sharing, power management, engine control and more for marine, emergency or power generation applications.



ENGINE CONTROL & MONITORING

These monitors can be configured from the front panel, a PC, or via an SD card, and support both digital and analog sensor inputs. Common alarms and shut-downs have large, user-friendly LED displays.



ARC-FLASH DETECTION

Our Arc-Flash relays can rapidly detect developing Arc-Flash incidents and send a trip signal to interrupt power before significant damage occurs.



GROUND-FAULT PROTECTION RELAYS

Improve the safety of workers and reduce incidents of Arc-Flash without affecting the uptime of critical operations. Sensitive ground-fault relays with advanced filtering will detect the breakdown in insulation resistance caused by moisture, vibration, chemicals and dust without nuisance trips.



FEEDER PROTECTION RELAYS

Protect feeder circuits from overcurrents, ground faults, phase loss or other detrimental conditions in critical applications and processes. They provide essential data for predictive and preventive maintenance—extending the life of equipment, enhancing safety and maximizing efficiency.



GENERAL PROTECTION RELAYS

These single-function, compact and cost-efficient relays are typically used on low-voltage applications. Most are DIN-rail mountable, easy to operate, install and commission. The wide-range power supply for AC and DC make these relays universal.



ENGINE DIAGNOSTICS

The EngineEye diagnostic unit can improve the efficiency and performance of combustion engines by measuring and analyzing the engine combustion process. It utilizes a unique handheld high-precision indicator of cylinder pressure.



ALARM & ANNUNCIATOR PANELS

These panels monitor instantaneous current, temperature or pressure, and include local indication, alarm and event logging.



MOTOR & PUMP PROTECTION RELAYS

Prevent expensive damage to motors caused by overloads, jams, phase loss or unbalance, heat from non-electric sources, heavy start-ups or excessive operational cycles. Dynamic thermal curves, integrated protection, metering, and data-logging functions extend motor life and maximize process efficiency.



RESISTANCE GROUNDING & MONITORING

Overcome many of the issues experienced with solidly-grounded and ungrounded systems. High-Resistance Grounding eliminates Arc-Flash Hazards associated with ground faults and transient overvoltages, and allows for continuous operation during a ground fault.

FEATURES COMPARISONS

Ground-Fault Protection Relays

| FEATURE | SE-601 | EL731 | PGR-3100 | PGR-3200 | T3200 | SE-502 | SE-703 | SE-701 | T2800 | SE-105 | SE-107 | SE-135 | SE-134C | SE-145 | SE-325 | SE-330AU | SE-330NH | SE-330HV | |
|-------------------------------|--------|-------|----------|----------|-------|--------|--------|--------|-------|--------|--------|--------|---------|--------|--------|----------|----------|----------|---|
| Detects GF via voltage | | | ✓ | ✓ | | ✓ | | | | ✓ | ✓ | ✓ | ✓ | ✓ | ✓ | ✓ | ✓ | ✓ | ✓ |
| Detects GF via current | ✓ | ✓ | | | | | ✓ | | ✓ | ✓ | ✓ | ✓ | ✓ | ✓ | ✓ | ✓ | ✓ | ✓ | ✓ |
| Detects DC GF | ✓ | ✓ | | | | | | | | | | | | | | | | | |
| Adjustable GF pickup | ✓ | ✓ | | | | | ✓ | | ✓ | ✓ | ✓ | ✓ | ✓ | ✓ | ✓ | ✓ | ✓ | ✓ | ✓ |
| Adjustable time delay | ✓ | ✓ | | | ✓ | | ✓ | | ✓ | ✓ | ✓ | ✓ | ✓ | ✓ | ✓ | ✓ | ✓ | ✓ | ✓ |
| Remote reset | ✓ | ✓ | | ✓ | | ✓ | ✓ | | ✓ | ✓ | ✓ | ✓ | ✓ | ✓ | ✓ | ✓ | ✓ | ✓ | ✓ |
| Analog output | ✓ | ✓ | | ✓ | ✓ | | ✓ | | ✓ | ✓ | ✓ | ✓ | ✓ | ✓ | ✓ | ✓ | ✓ | ✓ | ✓ |
| Fail-safe option | ✓ | ✓ | | | | ✓ | ✓ | | | ✓ | ✓ | ✓ | ✓ | ✓ | ✓ | ✓ | ✓ | ✓ | ✓ |
| Harmonic filtering | | ✓ | | ✓ | | | ✓ | | | ✓ | ✓ | ✓ | ✓ | ✓ | ✓ | ✓ | ✓ | ✓ | ✓ |
| CT-Loop monitoring | | ✓ | | | | | ✓ | | | | | ✓ | ✓ | ✓ | | | | | |
| Insulation monitoring | | | ✓ | ✓ | ✓ | | | | | | | | | | | | | | |
| Ground-check monitoring | | | | | | | | | ✓ | ✓ | ✓ | | | | | | | | |
| Grounding-resistor monitoring | | | | | | | | | | | | | | ✓ | | ✓ | | | |
| PTC/RTD overtemperature | | ✓ | | | | | | | | | | | | | | | | | |
| Communications | | ✓ | | | | | | | | | | | | | | | | ✓ | ✓ |
| Conformal coating | ‡ | ✓ | ✓ | ‡ | ✓ | ‡ | ‡ | | ✓ | ✓ | ✓ | ✓ | ✓ | ✓ | ✓ | ✓ | ✓ | ✓ | ✓ |

Arc-Flash Relays

| FEATURE | D0100 | D0900 | PGR-8800 |
|-----------------------------------|-------|-------|----------|
| Current detection | | | ✓ |
| Point sensors | ✓ | ✓ | ✓ |
| Fiber optic sensors | | | ✓ |
| Cable monitoring on sensor inputs | | | ✓ |
| USB | | | ✓ |
| DC supply | ✓ | | ✓ |
| AC supply | | ✓ | ✓ |
| Data logging | | | ✓ |

Motor & Feeder Protection Relays

| FEATURE (IEEE #) | PGR-6100 | PGR-6130 | PGR-6150 | MPU-32 | MPS | PGR-6800 | FPU-32 | FPS |
|--------------------------------|----------|----------|----------|--------|-----|----------|--------|-----|
| Ground fault (50G/N, 51G/N) | ✓ | | ✓ | ✓ | ✓ | | ✓ | ✓ |
| Overload (49, 51) | | ✓ | ✓ | ✓ | ✓ | ✓ | ✓ | ✓ |
| Unbalance (current) (46) | | ✓ | ✓ | ✓ | ✓ | ✓ | ✓ | ✓ |
| Phase loss (current) (46) | | ✓ | ✓ | ✓ | ✓ | ✓ | ✓ | ✓ |
| Phase reverse (current) (46) | | ✓ | ✓ | ✓ | ✓ | ✓ | ✓ | ✓ |
| PTC overtemperature (49) | | ✓ | ✓ | ✓ | ✓ | | ✓ | |
| Undercurrent (37) | | | ✓ | ✓ | ✓ | ✓ | | |
| Jam | | | ✓ | ✓ | ✓ | | | |
| Overcurrent (50, 51) | | | ✓ | ✓ | ✓ | | ✓ | ✓ |
| Failure to accelerate | | | ✓ | ✓ | ✓ | | | |
| RTD temperature (38, 49) | | | | ✓ | ✓ | | ✓ | ✓ |
| Starts per hour (66) | | | | ✓ | ✓ | | | |
| Differential (87) | | | | ✓ | ✓ | | | |
| Reduced overcurrent setting | | | | ✓ | ✓ | | | |
| Phase loss (voltage) (47) | | | | | ✓ | | | ✓ |
| Phase reverse (voltage) (47) | | | | | ✓ | | | ✓ |
| Unbalance (voltage) (47) | | | | | ✓ | | | ✓ |
| Overvoltage (59) | | | | | ✓ | | ✓ | ✓ |
| Undervoltage (27) | | | | | ✓ | | | ✓ |
| Power factor (55) | | | | | ✓ | | | ✓ |
| Overfrequency (81) | | | | | ✓ | | | ✓ |
| Underfrequency (81) | | | | | ✓ | | | ✓ |
| Starter control | | | | | ✓ | | | |
| Breaker control | | | | | | | | ✓ |
| Underspeed (14) | | | | | ✓ | | | |
| Integrated CTs | | ✓ | ✓ | | | ✓ | | |
| Off-line insulation monitoring | ✓ | | | | | | | |
| Metering and data logging | | | ✓ | ✓ | ✓ | | ✓ | ✓ |
| Communications | | | ✓ | ✓ | ✓ | | ✓ | ✓ |
| Conformal coating | ‡ | | | ✓ | ✓ | | ✓ | ✓ |
| 10-year warranty | | | | ✓ | ✓ | | ✓ | ✓ |

Alarm Monitors

| FEATURE | M1000 | M3000 | M4200 | M4500 | M4600 | M4700 | M4780 |
|---|-------|-------|-------|-------|-------|--------------------|--------------------|
| Alarm panel | ✓ | ✓ | ✓ | | | | |
| Indicator panel | ✓ | ✓ | ✓ | ✓ | ✓ | ✓ | ✓ |
| No. of inputs | 10 | 24 | 8 | 6 | 8 | 20 | 20 |
| Digital input | ✓ | ✓* | ✓ | ✓ | ✓ | ✓ | ✓ |
| No. of open collector outputs | 10 | 14 | 4 | | | | |
| Common alarm output [†] | 1oc | 1oc | 2dryc | | | 1dryc [‡] | 1dryc [‡] |
| Siren output | 1dryc | 1oc | 1dryc | | | 1dryc [‡] | 1dryc [‡] |
| LCD display | | ✓ | | | | | |
| Configure from PC | ✓ | ✓ | ✓ | | | | |
| Configure from DIP switches/jumper | ✓ | | ✓ | | | ✓ | ✓ |
| Configure from front panel | | ✓ | | | | | |
| MODBUS-RTU (RS485) | ✓ | ✓ | | | | | |
| LED dimming | ✓ | ✓ | ✓ | | | | |
| LED synchronizing | ✓ | | ✓ | | | | |
| Panel linking | ✓ | | | | | | |
| Remote reset | ✓ | ✓ | ✓ | | | | |
| Sensor monitoring | ✓ | ✓ | ✓ | | | | |
| Insulation monitoring of supply voltage | ✓ | | ✓ | | | | |
| Monitoring of supply voltage | ✓ | | ✓ | | | | |

*Both analog and digital input.
1oc=open collector; dryc=dry contact
‡Optional

NOTE:
Tables are for reference only and include standard and optional configurations.
Please see the respective catalog page for exact product specifications.
IEEE Device Numbers are shown in parenthesis after the applicable features.

FEATURES COMPARISONS

Generator Protection & Single-Function Relays

| FEATURE (IEEE #) | PGR-4300 | G2000 | G3000 | G3800 | T2000 | T2100 | T2200 | T2300 | T2400 | T2500 | T2700 | T2900 | T3000 | T3100 | T3300 |
|---------------------------------|----------|-------|-------|-------|-------|-------|-------|-------|-------|-------|-------|-------|-------|-------|-------|
| Overload | | | | | | | | | | | ✓ | | | | |
| Overcurrent | | | | | | | ✓ | | ✓ | ✓ | | | | | |
| Undercurrent (37) | | | | | | | | | | | | | | | |
| Short circuit | | | | | | | | ✓ | | ✓ | | | | | |
| Reverse power (32) | | ✓ | | | ✓ | | | | | | | | | | |
| Overfrequency (81) | | | ✓ | | | | | | | | | | | ✓ | |
| Underfrequency (81) | | | ✓ | | | | | | | | | | | ✓ | |
| Overvoltage (59) | | | | ✓ | | | | | | | | | | ✓ | ✓ |
| Undervoltage (27) | | | | ✓ | | | | | | | | | | ✓ | ✓ |
| Excitation loss (40) | | | | | | ✓ | | | | | | | | | |
| Earth fault | | | | | | | | | | | | | | | |
| Differential current relay (87) | | | | | | | | | | | | ✓ | | | |
| Insulation monitoring relay | | | | | | | | | | | | | | | |
| Single phase measurement | | ✓ | ✓ | | ✓ | ✓ | | | | | ✓ | | ✓ | ✓ | |
| 3-phase measurement | | | | ✓ | | | ✓ | ✓ | ✓ | ✓ | | ✓ | | | ✓ |
| Conformal coating | | | | | | ✓ | ✓ | ✓ | ✓ | ✓ | ✓ | ✓ | ✓ | ✓ | ✓ |

Engine Controls

| FEATURE (IEEE #) | M2000 | M2500 | M2600 |
|---|-------|-------|-------|
| Start/stop | ✓ | ✓ | |
| Digital sensor inputs | ✓ | ✓ | ✓ |
| Analog sensor inputs | | ✓ | |
| Cable monitoring on fuel/stop solenoid output | | ✓ | ✓ |
| Graphical display | | ✓ | |
| CAN J1939 | | ✓ | |
| USB | | ✓ | |
| SD card slot | | ✓ | |
| Pick-up input | ✓ | ✓ | ✓ |

Generator Controls

| FEATURE (IEEE #) | T2600 | T4500 | T4800 | T4900 | T5000 | E7800 | T7900 | M8100 | T8400 | C6200 | S6000 | S6100 | S6610 |
|---|-------|-------|-------|-------|-------|-------|-------|-------|-------|-------|-------|-------|-------|
| 3 phase true RMS measurement | ✓ | ✓ | ✓ | ✓ | ✓ | | | ✓ | | ✓ | ✓ | ✓ | |
| Overcurrent | | | | | | | | | | ✓ | ✓ | ✓ | |
| Short circuit | | | | | | | | | | ✓ | ✓ | ✓ | |
| Overload | | | | | | | | | | ✓ | ✓ | ✓ | |
| Reverse power (32) | | | ✓ | | | | | | | ✓ | ✓ | ✓ | |
| Excitation loss (40) | | | | | | | | | | ✓ | ✓ | ✓ | |
| Overfrequency (81) | | | | | | | | | | ✓ | ✓ | ✓ | ✓ |
| Underfrequency (81) | | | | | | | | | | ✓ | ✓ | ✓ | |
| Overvoltage (59) | | | | | | | | | | ✓ | ✓ | ✓ | |
| Undervoltage (27) | | | | | | | | | | ✓ | ✓ | ✓ | |
| ROCOF (81) | | | | | | | | | | ✓ | ✓ | ✓ | |
| Vector shift | | | | | | | | | | ✓ | ✓ | ✓ | |
| Preferential load trip | | | | | | | | | | ✓ | ✓ | ✓ | |
| Synchronizing (25) | | ✓ | | | | | | | | ✓ | ✓ | ✓ | |
| Check synchronizer (25) | | | | | ✓ | | | ✓ | | ✓ | ✓ | ✓ | |
| Active load sharing [kW] | | | ✓ | | | | | | | ✓ | ✓ | ✓ | |
| Reactive load sharing [kVAR] | | | | ✓ | | | | | | ✓ | ✓ | ✓ | |
| Power factor regulation | | | | ✓ | | | | | | ✓ | ✓ | ✓ | |
| Dead bus monitoring/black out limiter | | | | | | | | ✓ | | ✓ | ✓ | ✓ | |
| Load depending start/stop (PM) | ✓ | | | | | | | | | ✓ | ✓ | ✓ | ✓ |
| Large consumer control (PM) | | | | | | | | | | ✓ | ✓ | ✓ | ✓ |
| Dynamic grid-parallel operation control | | | | | | | | | | ✓ | ✓ | ✓ | |
| MODBUS RTU (RS485 interface) | | | | | | | | | | ✓ | ✓ | ✓ | ✓ |
| Motorized potentiometer | | | | | | ✓ | | | | | | | |
| Electronic potentiometer | | | | | | | ✓ | | | | | | |
| Dead bus closure | | | | | | | | | ✓ | | | | |

Engine Diagnostics

| FEATURES | BASIC E5000 & E5100 | ADVANCED E5000, E5100 & E5200 | PROFESSIONAL E5000, E5100, E5200 & 5300 |
|------------------------------------|---------------------------|--|---|
| USB | ✓ | ✓ | ✓ |
| Color LCD | ✓ | ✓ | ✓ |
| PC software included | ✓ | ✓ | ✓ |
| Upgradable | ✓ | ✓ | ✓ |
| Temperature compensation | ✓ | ✓ | ✓ |
| Calibration-check integration | ✓ | ✓ | ✓ |
| Connecting sensor ports | 1 | 2 | 5 |
| Pressure graph | ✓ | ✓ | ✓ |
| MIP mode | | * | ✓ |
| Misfire analysis | | ✓ | ✓ |
| p ^{max} | | ✓ | ✓ |
| p/time | ✓ | ✓ | ✓ |
| p ^{max} bar graph | | ✓ | ✓ |
| p/alpha | | * | ✓ |
| dp/alpha | | * | ✓ |
| p/V | | * | ✓ |
| Pressure sensor | ✓ | ✓ | ✓ |
| Crank-angle sensor | | | ✓ |
| Maximum engines (memory) | 5 | 10 | 20 |
| Maximum cylinders/engine (memory) | 20 | 20 | 20 |
| Maximum number of strokes (memory) | 30 | 30 | 30 |

NOTE: These tables are for reference only and include standard and optional configurations.

*Possible with a crank angle sensor E5300.

GROUND-FAULT PROTECTION

SE-601 (PGR-2601) DC Ground-Fault Relay For Ungrounded DC Systems



Features/Benefits

- Sensitive 1- to 20-mA trip settings
- A microprocessor-based ground-fault relay for ungrounded dc systems
- 50-ms to 2.5-s time-delay settings
- Limits ground-fault current to 25 mA
- Form-A and Form-B trip contacts

Specifications

IEEE Device Number 76G
Dimensions H 75 mm (3.0")
W 55 mm (2.2")
D 115 mm (4.5")
Communications Analog Output
Warranty 5 Year

Web Resources

www.littelfuse.com/se-601

| ORDERING NUMBER | SPECIFICATIONS | ACCESSORIES |
|-----------------|---------------------------------------|---|
| SE-601-OD | 24 Vdc Control Power | SE-GRM Series Ground Reference Modules PGA-0500 Analog Current Meter |
| SE-601-OT | 48 Vdc Control Power | |
| SE-601-OU | 120/240 Vac/dc 50/60 Hz Control Power | |

PGR-3100 Ground-Fault Indication System For Ungrounded AC Systems



Features/Benefits

- Meets NEC® Article 250.21 (B)
- Indicates the presence of voltage on each phase of a three-phase system by illuminating the LEDs
- Indicates ground-fault and phase
- Lamp test button to verify operation
- Redundant long-life LEDs

Specifications

IEEE Device Numbers 27, 64
Dimensions H 108 mm (4.3")
W 88.9 mm (3.5")
D 54 mm (2.1")
Warranty 5 Year

Web Resources

www.littelfuse.com/pgr-3100

| ORDERING NUMBER | SPECIFICATIONS | ACCESSORIES |
|-----------------|----------------|-------------|
| PGR-3100 | Panel Mount | — |

PGR-3200 Ground-Fault Protection System For Ungrounded AC Systems



Features/Benefits

- Meets NEC Article 250.21 (B)
- Continuously monitors the insulation integrity of ungrounded electrical systems for ground faults
- Provides 2 warnings and 1 alarm
- Analog output for insulation reading

Specifications

IEEE Device Number 27, 64
Dimensions H 99.7 mm (3.9")
W 75 mm (4.3")
D 110 mm (4.3")
Communications Analog Output
Warranty 5 Year

Web Resources

www.littelfuse.com/pgr-3200

| ORDERING NUMBER | SPECIFICATIONS | ACCESSORIES |
|-----------------|-----------------------|--|
| PGR-3200 | 240 Vac Control Power | PGH family High Tension Couplers PGA-0510 Analog Insulation Meter |

GROUND-FAULT PROTECTION

SE-701 (PGR-5701) Ground-Fault Relay For Solidly and Resistance-Grounded Systems



Features/Benefits

- Choice of input CT gives wide setting range
- A microprocessor-based ground-fault relay for resistance-grounded and solidly grounded systems
- Microprocessor-based unit with DFT
- Non-volatile trip memory retains trip state
- Compatible with VFD applications
- Adjustable pick-up settings from 1% to 99% of CT primary rating, as low as 50 mA
- Adjustable time-delay settings from 0.5 to 2.5 sec

Specifications

IEEE Device Numbers 50G, 50N, 51G, 51N
Dimensions H 75 mm (3.0")
W 55 mm (2.2")
D 115 mm (4.5")
Communications Analog Output
Warranty 5 Year

Web Resources

www.littelfuse.com/se-701

| ORDERING NUMBER | SPECIFICATIONS | ACCESSORIES |
|-----------------|-----------------------------|--|
| SE-701-OD | 9-36 Vdc Control Power | Ground Fault Current Transformers PGA-0500 Analog Current Meter |
| SE-7701-OT | 32-70 Vdc Control Power | |
| SE-701-OU | 75-275 Vac/dc Control Power | |

SE-703 Earth Leakage Monitor For Solidly and Resistance-Grounded Systems



Features/Benefits

- Provides sensitive ground-fault protection
- A microprocessor-based ground-fault relay for resistance-grounded and solidly earthed systems
- Microprocessor-based unit with DFT
- Non-volatile trip memory retains trip state
- Compatible with VFD applications
- Adjustable pick-up settings from 25 mA to 500 mA
- Adjustable time-delay settings from 50 to 500 ms

Specifications

IEEE Device Numbers 50G, 50N, 51G, 51N
Dimensions H 75 mm (3.0")
W 55 mm (2.2")
D 115 mm (4.5")
Communications Analog Output
Warranty 5 Year

Web Resources

www.littelfuse.com/se-703

| ORDERING NUMBER | SPECIFICATIONS | ACCESSORIES |
|-----------------|------------------------------|---|
| SE-703-OU | 9-36 Vdc Control Power | EFCT series Current Transformers PGA-0500 Analog Current Meter |
| SE-703-OT | 32-70 Vdc Control Power | |
| SE-703-OU | 75-275 Vac/Vdc Control Power | |

SE-704 (PGR-4704) Earth Leakage Monitor For Solidly and Resistance-Grounded Systems



Features/Benefits

- Provides very sensitive ground-fault protection
- Microprocessor-based unit with DFT
- Non-volatile trip memory retains trip state
- Compatible with VFD applications
- Adjustable pick-up settings from 10 mA to 5 A
- Adjustable time-delay settings from 0.5 to 2.5 sec

Specifications

IEEE Device Numbers 50G, 50N, 51G, 51N
Dimensions H 75 mm (3.0")
W 55 mm (2.2")
D 115 mm (4.5")
Communications Analog Output
Warranty 5 Year

Web Resources

www.littelfuse.com/se-704

| ORDERING NUMBER | SPECIFICATIONS | ACCESSORIES |
|-----------------|------------------------------|--|
| SE-704-24 | 9-36 Vdc Control Power | SE-CS30 series Current Transformers PGA-0500 Analog Current Meter |
| SE-704-120 | 32-70 Vdc Control Power | |
| SE-704-240 | 75-275 Vac/Vdc Control Power | |

GROUND-FAULT PROTECTION

**T2800 Earth-Fault Relay
For Solidly and Resistance-Grounded Systems**



Features/Benefits

- Accepts high supply voltage variation
- Visual indication of power, pick-up and output trip
- Direct line-line or line-neutral voltage supply
- Wide range of combined current and delay settings
- DIN-rail or Screw-mount

Specifications

Trip Level 0.02-0.2 x I_N or 0.2-2 x I_N
Delay 0.1-1 sec or 1-10 sec
Dimensions **H** 70 mm (2.76")
W 100 mm (3.94")
D 115 mm (4.52")

Web Resources

www.littelfuse.com/t2800

| ORDERING NUMBER | TERMINALS | | I _N |
|-----------------|-----------|-------|----------------|
| | 1-3 | 2-3 | |
| T2800-00 | 230 V | | 5 A |
| T2800-01 | 450 V | 400 V | 5 A |
| T2800-02 | 127 V | 120 V | 5 A |
| T2800-04 | 24V DC+AC | | 5 A |
| T2800-05 | 480 V | 415 V | 5 A |
| T2800-08 | 230 V | | 1 A |

**EL731 AC/DC Sensitive Earth-Leakage
For Solidly-Grounded Systems**



Features/Benefits

- Microprocessor based relay that offers complete coverage for all frequencies
- Adjustable trip settings provide wide range protection and coordination
- Operate in both AC or DC mode and single or combined ranges
- LED indication for visual trip, alarm and CT

Specifications

IEEE Device Numbers 38, 49, 50G/N, 51G/N, 79G
Dimensions **H** 48 mm (1.9")
W 96 mm (3.8")
D 129 mm (5.0")
Warranty 5 Years

Web Resources

www.littelfuse.com/el731

| ORDERING NUMBER | CONTROL POWER | COMMUNICATIONS |
|-----------------|-----------------|----------------|
| EL731-00-00 | 120/240-Vac/Vdc | None |
| EL731-01-00 | 120/240-Vac/Vdc | DeviceNet™ |
| EL731-02-00 | 120/240-Vac/Vdc | Profibus® |
| EL731-03-00 | 120/240-Vac/Vdc | Ethernet |
| EL731-04-00 | 120/240-Vac/Vdc | Modbus |
| EL731-10-00 | 48 Vdc & 24 Vac | None |
| EL731-11-00 | 48 Vdc & 24 Vac | DeviceNet™ |
| EL731-12-00 | 48 Vdc & 24 Vac | Profibus® |
| EL731-13-00 | 48 Vdc & 24 Vac | Ethernet |
| EL731-14-00 | 48 Vdc & 24 Vac | Modbus |

| ORDERING NUMBER | CONTROL POWER | COMMUNICATIONS |
|-----------------|---------------|----------------|
| EL731-20-00 | 24 Vdc | None |
| EL731-21-00 | 24 Vdc | DeviceNet™ |
| EL731-22-00 | 24 Vdc | Profibus® |
| EL731-23-00 | 24 Vdc | Ethernet |
| EL731-24-00 | 24 Vdc | Modbus |

**T3200 Double Insulation Monitoring Relay
For Solidly-Grounded Systems**



Features/Benefits

- Continuously monitors two systems galvanically separated from each other
- Ensures correct operation in spite of voltage supply fluctuations
- Visual indication of power pick-up, and output trip

Specifications

Insulation Level 0-5 MW
Max Voltage 660 V
Dimensions **H** 70 mm (2.75")
W 100 mm (3.94")
D 115 mm (4.52")

Web Resources

www.littelfuse.com/t3200

| ORDERING NUMBER | 1-3 TERMINALS | 2-3 TERMINALS | ACCESSORIES |
|-----------------|---------------|---------------|--------------------|
| T3200.0010 | 230 V | | E2333 Megaohmmeter |
| T3200.0020 | 450 V | 400 V | |
| T3200.0030 | 480 V | 415 V | |
| T3200.0050 | 110 V | 100 V | |
| T3200.0060 | 127 V | 120 V | |

TRAILING CABLE PROTECTION

SE-105 • SE-107 Ground-Fault Ground-Check Monitor



Features/Benefits

- Adjustable pickup so unit can be used on a wide variety of trailing cable applications
- Adjustable time delay for quick protection and system coordination
- Harmonic filter prevents false operation

Specifications

IEEE Device Numbers 3GC, 50G/N, 51G/N
Dimensions **H** 50 mm (5.9")
W 109 mm (4.3")
D 100 mm (4.0")
Warranty 5 Years

Web Resources

www.littelfuse.com/se-105
www.littelfuse.com/se-107

| ORDERING NUMBER | CONTROL POWER | ACCESSORIES |
|-----------------|---------------|---|
| SE-105 | 120 Vac | |
| SE-105D | 120 Vac/Vdc | CT200 Series Current Transformer |
| SE-105E | 240 Vac | 1N5339B Termination Assembly |
| SE-107 | 120 Vac | SE-TA6 Termination Assembly |
| SE-107D | 120 Vac/Vdc | SE-TA6-SM Stud-Mount Termination Assembly |
| SE-107E | 240 Vac | |

SE-134C (PGM-8134C) • SE-135 Ground-Fault Ground-Check Monitor



Features/Benefits

- Fail-safe ground check circuit
- Combination ground-wire monitor and ground-fault relay
- Zener-characteristic termination device
- High-induced-ac rejection
- DFT (harmonic) filter

Specifications

IEEE Device Numbers 3GC, 50G, 50N, 51G, 51N
Dimensions **H** 213 mm (8.4")
W 99 mm (3.9")
D 145 mm (5.7")
Warranty 5 Year

Web Resources

www.littelfuse.com/se-134c
www.littelfuse.com/se-135

| ORDERING NUMBER | SPECIFICATIONS | ACCESSORIES |
|-----------------|------------------------|---|
| SE-134C-00 | 60-265 Vac; 80-370 Vdc | SE-CS10 Ground-Fault Current Transformer |
| SE-135-00 | 60-265 Vac; 80-370 Vdc | SE-TA6A Series Termination Assembly SE-TA12A Series Termination Assembly |

SE-145 Ground-Fault Ground-Check Monitor



Features/Benefits

- Adjustable pick can be used on a wide variety of trailing cable applications
- Adjustable time delay for quick protection and system coordination
- Separate annunciations of ground-fault and ground-check faults

Specifications

IEEE Device Number 3GC, 50G, 50N, 51G, 51N
Dimensions **H** 213 mm (8.4")
W 192 mm (7.6")
D 176 mm (7.0")
Communications Ethernet Optional
Warranty 5 Year

Web Resources

www.littelfuse.com/se-145

| ORDERING NUMBER | CONTROL POWER | COMM |
|-----------------|------------------------|---|
| SE-145-00-00 | 60-265 Vac; 80-370 Vdc | |
| SE-145-00-10 | 24/48 Vdc | SE-CS10 Series Ground-Fault Current Transformer |
| SE-145-03-00 | 60-265 Vac; 80-370 Vdc | SE-CS40 Series Ground-Fault Current Transformer |
| SE-145-03-10 | 24/48 Vdc | SE-TA12A Series Termination Assembly |

RESISTANCE GROUNDING AND NGR MONITORING

SE-325 (PGM-8325) Neutral-Grounding-Resistor Monitor



Description

The SE-325 Neutral-Grounding-Resistor Monitor is used on resistance-grounded systems up to 25 kVac to monitor the integrity of the neutral-to-ground path for loose connection, corrosion, and ground faults.

Features/Benefits

- Adjustable ground-fault detection
- Adjustable time-delay settings
- Selectable fail-safe mode
- Conformally coated circuit boards

Specifications

IEEE Device Numbers 50G/N, 51G/N, 59N, 86, 3
Dimensions **H** 150 mm (5.9")
W 109 mm (4.3")
D 100 mm (4.0")
Warranty 5 Year

Web Resources

www.littelfuse.com/se-325

| ORDERING NUMBER | SPECIFICATIONS | ACCESSORIES |
|-----------------|----------------|--|
| SE-325 | 120 Vac | CT200 Series Current Transformers ER Series Sensing Resistors |
| SE-325D | 120 Vdc | |
| SE-325E | 240 Vac | |

SE-330AU Neutral-Grounding-Resistor Monitor



Description

An advanced ground-fault and ground-resistor monitoring relay for low and medium-voltage transformers and generators. The SE-330AU complies with AS/NZS 2081.3:2002.

Features/Benefits

- Continuous NGR monitoring
- Detect ground-fault anywhere on monitored system
- Adjustable pickup settings
- Adjustable time delay settings

Specifications

Dimensions **H** 213 mm (8.4")
W 98 mm (3.9")
D 132 mm (5.2")
Communications RS-232; DeviceNet™, Profibus®, Ethernet
Warranty 5 Year

Web Resources

www.littelfuse.com/se-330au

| ORDERING NUMBER | SPECIFICATIONS | ACCESSORIES |
|-----------------|----------------|---|
| SE-330AU-00-00 | 80-265 Vac/Vdc | ER Series Sensing Resistor EFCT Series Ground-Fault Current Transformer SE-CS30 Series Ground-Fault Current Transformer |
| SE-330AU-01-00 | 80-265 Vac/Vdc | |
| SE-330AU-02-00 | 80-265 Vac/Vdc | |
| SE-330AU-03-00 | 80-265 Vac/Vdc | |

SE-330 (PGR-5330), SE-330HV Neutral-Grounding-Resistor Monitor



Description

An advanced ground-fault and grounding-resistor monitoring relay. It measures neutral current, neutral-to-ground voltage and neutral-to-ground resistance.

Features/Benefits

- Continuous NGR monitoring
- Detect ground-fault anywhere on monitored system
- Adjustable pickup (2-100%)
- Adjustable time delay (0.1 - 10s)

Specifications

IEEE Device Numbers 50G/N, 51G/N, 59N, 3, 86
Dimensions **H** 213 mm (8.4")
W 98 mm (3.9")
D 132 mm (5.2")
Communications RS-232; DeviceNet™, Profibus®, Ethernet
Warranty 5 Year

Web Resources

www.littelfuse.com/se-330

| ORDERING NUMBER | SPECIFICATIONS | ACCESSORIES |
|-----------------|----------------|---|
| SE-330-00-00 | 80-265 Vac/dc | ER Series Sensing Resistor EFCT Series Ground-Fault Current Transformer SE-CS30 Series Ground-Fault Current Transformer |
| SE-330-01-00 | 80-265 Vac/dc | |
| SE-330-02-00 | 80-265 Vac/dc | |
| SE-330-03-00 | 80-265 Vac/dc | |

RESISTANCE GROUNDING AND NGR MONITORING

SE-502 Ground-Fault Ground-Continuity Detector



Description

Provides Class-A GFCI trip level and trip times for personnel protection.

Features/Benefits

- Sensitive ground-fault detection
- Internal neutral-grounding resistor eliminates arc-flash hazards
- Neutral-to-ground connection monitoring can detect a hazardous ungrounded condition

Specifications

IEEE Device Numbers 64, 86, 95
Dimensions
H 75 mm (3.0")
W 100 mm (4.0")
D 113 mm (4.4")
Warranty 5 Year

Web Resources

www.littelfuse.com/se-502

| ORDERING NUMBER | CONTROL POWER |
|-----------------|---------------|
| SE-502-01 | 120 Vac |

PGN-1000 Low-Resistance Grounding System



Low-Resistance grounding is typically applied on transformers and generators, and limits the ground-fault current to 25 A and above. Since ground-fault current is above 25 A, the faulted feeder must be de-energized. The reduced ground-fault current allows for an orderly shut-down procedure, typically within 10 seconds.

Web Resources

For more information on Resistance Grounding Systems, visit www.littelfuse.com/pgn-1000

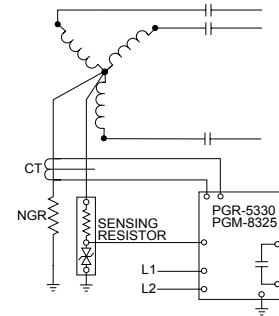

PGN-3000 High-Resistance Grounding System



High-Resistance grounding is typically applied on transformers and generators, and limits the ground-fault current to 10 A or less. Since ground-fault current is below 10 A, the faulted feeder can remain in operation. The reduced ground-fault current allows for an orderly shut-down procedure.

Web Resources

For more information on Resistance Grounding Systems, visit www.littelfuse.com/pgn-3000

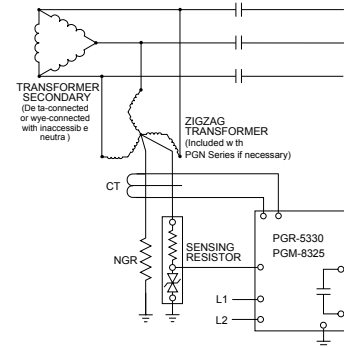

MOTOR PROTECTION

PGR-6100 (GFR-4000) Motor Ground-Fault and Insulation Relay



Features/Benefits

- Online monitoring to detect ground faults
- Offline monitoring of insulation resistance
- Continuously monitors for predictive protective capabilities
- CT loop monitoring
- Individual alarm contacts (form C)
- Individual analog outputs to indicate insulation resistance and ground-fault current

Specifications

IEEE Device Numbers 50G/N, 51G/N, 64, 74
Dimensions H 75 mm (3.0")
W 99.7 mm (3.9")
D 110 mm (4.3")
Communications 2 Analog Outputs
Warranty 5 years

Web Resources

www.littelfuse.com/pgr-6100

| ORDERING NUMBER | SPECIFICATIONS | ACCESSORIES |
|-----------------|------------------------------|---|
| PGR-6100-120 | 24 Vdc/120 Vac Control Power | PGC-5000 Series Ground-Fault Transformers PGA-0500 Analog % Current Meter PGA-0510 Analog Ohm Meter PGH Family High Tension Couplers |
| PGR-6100-240 | 240 Vac Control Power | |

PGR-6130 Electronic Overload Relay

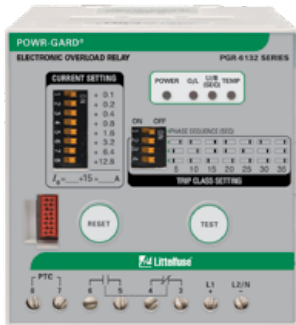

Features/Benefits

- No external CT required for currents up to 90 A
- Cause-of-trip indication
- N.O. and N.C. alarm contacts
- Adjustable overload trip class setting
- Adjustable current pickup
- Over-temperature (PTC) protection
- Thermal overload protection

Specifications

IEEE Device Numbers 46, 49, 51
Dimensions H 83 mm (3.3")
W 78 mm (3.1")
D 99 mm (3.9")
Warranty 5 years

Web Resources

www.littelfuse.com/pgr-6130

| ORDERING NUMBER | SPECIFICATIONS | FULL-LOAD CURRENT | ACCESSORIES |
|-----------------|----------------|-------------------|---|
| PGR-6131-24 | 24 Vdc | 4-16.7 A | PGB-6130 Remote Indication and Reset Assembly |
| PGR-6131-120 | 120 Vac | 4-16.7 A | |
| PGR-6131-240 | 240 Vac | 4-16.7 A | |
| PGR-6132-24 | 24 Vdc | 15-40.5 A | |
| PGR-6132-120 | 120 Vac | 15-40.5 A | |
| PGR-6132-240 | 240 Vac | 15-40.5 A | |
| PGR-6133-24 | 24 Vdc | 40-91 A | |
| PGR-6133-120 | 120 Vac | 40-91 A | |
| PGR-6133-240 | 240 Vac | 40-91 A | |

PGR-6150 Motor Protection System



Features/Benefits

- 13 protective functions
- 2 relay outputs, 1 digital input
- No external CT required for currents up to 25 A
- Thermal protection through starting, running, overload and cooling cycles
- RS-485 interface with Modbus® RTU
- Optional PGR-6150-OPI Operator Interface

Specifications

IEEE Device Numbers 37, 46, 49, 50, 50G/N, 51, 51G/N, 66
Dimensions (Relay) H 83 mm (3.3")
W 78 mm (3.1")
D 99 mm (3.95")
Dimensions (OPI) H 56 mm (2.2")
W 106 mm (4.2")
D 23 mm (0.9")
Communications RS-485 with Modbus® RTU
Warranty 5 years

Web Resources

www.littelfuse.com/pgr-6150

| ORDERING NUMBER | SPECIFICATIONS | ACCESSORIES |
|-----------------|-------------------------------|---|
| PGR-6150-24 | 24/48 Vdc (Control Unit) | PGR-6150-OPI Operator Interface PGC-6000 Series Ground-Fault Transformer |
| PGR-6150-120 | 120/240 Vac/dc (Control Unit) | |
| PGR-6150-OPI | Operator Interface | |

MOTOR PROTECTION

MPU-32 (PGR-6200) Motor Protection Unit



Features/Benefits

- Reduced overcurrent setting for maintenance
- Dynamic thermal modeling
- Communications for different networks
- Optional RTD protection
- Optional differential protection
- Conformal coating
- Modular system and compact design makes installation easy for new or retrofit applications

Specifications

| | |
|----------------------------|--|
| IEEE Device Numbers | 37, 38, 46, 49, 50, 50G/N, 51, 51G/N, 66, 74, 86, 87 |
| Dimensions | H 96 mm (3.78") W 96 mm (3.78") D 132 mm (5.2") |
| Communications | RS-232 (Standard); RS-485, DeviceNet™ Ethernet (Optional) |
| Warranty | 10 years |

Web Resources

www.littelfuse.com/mpu-32

| ORDERING NUMBER | COMMUNICATIONS | ACCESSORIES |
|-----------------|----------------------|-------------------------------------|
| MPU-32-00-00 | TIA-232 | Phase Current Transformers |
| MPU-32-01-00 | TIA-232 & RS-485 | Ground-Fault Current Transformers |
| MPU-32-02-00 | TIA-232 & DeviceNet™ | MPS-RTD Temperature Input Module |
| MPU-32-04-00 | TIA-232 & Ethernet | MPS-DIF Differential Current Module |

MPS (PGR-6300) Motor Protection System



Features/Benefits

- Overcurrent reduction setting for maintenance
- Monitors voltage, current, and temperature
- 22 motor protection functions
- Conformal coating
- Dynamic thermal modeling
- Starter control, Metering, and Data Logging
- Optional RTD protection with hazardous-location certified RTD module
- Optional differential protection
- Modular design makes installation easy

Specifications

| | |
|----------------------------|--|
| IEEE Device Numbers | 1, 2, 3, 5, 9, 14, 18, 19, 27, 34, 37, 38, 46, 47, 48, 49, 50, 50G, 50N, 51, 51G/N, 55, 59, 66, 74, 81, 86, 87, 94 |
| Dimensions (OPI) | H 98 mm (3.86") W 192 mm (7.56") D 0.42 mm (1.65") |
| Communications | Allen-Bradley® DF1 & Modbus® RTU (Standard); DeviceNet™, Profibus®, Ethernet (Optional) |
| Warranty | 10 years |

Web Resources

www.littelfuse.com/mps

| ORDERING NUMBER | COMMUNICATIONS | ACCESSORIES |
|-----------------|---------------------|-------------------------------------|
| MPS-CTU-01-00 | RS-485 | Phase Current Transformers |
| MPS-CTU-02-00 | RS-485 & DeviceNet™ | Ground-Fault Current Transformers |
| MPS-CTU-03-00 | RS-485 & Profibus® | MPS-RTD Temperature Input Module |
| MPS-CTU-04-00 | RS-485 & Ethernet | MPS-DIF Differential Current Module |
| MPS-OPI-01-00 | Operator Interface | |

MPU-32-X69X (PGR-6210) & MPS-469X (PGR-6310) Motor Protection Retrofit Kits



Features/Benefits

- Direct replacement for GE Multilin 169, 269, 369 and 469 relays
- Microprocessor-based protection
- Proven reliability
- Conformally coated circuit boards
- Pre-wired module allows minimal change-out time
- Ability to match existing overcurrent values

Ordering Information

MPU-32-X69X

| | RTD INPUTS | MPU-32 COMMUNICATION | GROUND-FAULT CT | FUTURE OPTIONS |
|-------------|---|------------------------|---|----------------|
| MPU-32-X69X | X | X | X | 00 |
| | 0 = One Platinum 100 Ω | 0 = TIA232 | 0 = Wired for wGround-Fault CT (50 mA Secondary) | |
| | 1 = One Platinum 100 Ω & 8-input MPS-RTD Module | 1 = TIA232 & TIA485 | 1 = Wired for 1- or 5-A Secondary Ground-Fault CT | |
| | | 2 = TIA232 & DeviceNet | | |
| | | 4 = TIA232 & Ethernet | | |

Ordering Information

MPS-469X

| | MODULE CONFIGURATION | MPS COMMUNICATION | FUTURE OPTIONS |
|----------|---|-----------------------|----------------|
| MPS-469X | X | X | 000 |
| | 0 = None | 1 = RS485 | |
| | 1 = One MPS-RTD Module | 2 = RS485 & DeviceNet | |
| | 2 = Two MPS-RTD Modules | 3 = RS485 & Profibus | |
| | 3 = One MPS-DIF Module | 4 = RS485 & Ethernet | |
| | 4 = One MPS-RTD Module & One MPS-DIF Module | | |

PUMP AND FEEDER PROTECTION

PGR-6800 Pump Protection Relay



Features/Benefits

- No external CT required for currents up to 90 A
- Cause-of-trip indication
- N.O. and N.C. alarm contacts
- Adjustable overload trip class setting
- Adjustable current pickup
- Undercurrent protection

Specifications

IEEE Device Numbers 37, 46, 49, 51
Dimensions **H** 83 mm (3.3")
W 78 mm (3.1")
D 99 mm (3.9")

Warranty 5 years

Web Resources

www.littelfuse.com/pgr-6800

| ORDERING NUMBER | SPECIFICATIONS | FULL-LOAD CURRENT | ACCESSORIES |
|-----------------|----------------|-------------------|---|
| PGR-6801-24 | 24 Vdc | 7-19.6 A | PGB-6800 - Remote Indication and Reset Assembly |
| PGR-6801-120 | 120 Vac | 7-19.6 A | |
| PGR-6801-240 | 240 Vac | 7-19.6 A | |
| PGR-6802-24 | 24 Vdc | 19-44.2 A | |
| PGR-6802-120 | 120 Vac | 19-44.2 A | |
| PGR-6802-240 | 240 Vac | 19-44.2 A | |
| PGR-6803-24 | 24 Vdc | 40-90.4 A | |
| PGR-6803-120 | 120 Vac | 40-90.4 A | |
| PGR-6803-240 | 240 Vac | 40-90.4 A | |

FPU-32 (PGR-7200) Feeder Protection Unit



Features/Benefits

- Protection, metering, and data-logging functions
- Programmable using the operator interface, the TIA-232 port, or an optional communications network
- IEC & IEEE protection curves
- CT saturation compensation
- Communications for different networks
- Two set-point groups

Specifications

IEEE Device Numbers 26, 46, 49, 50, 50G/N, 51, 51G/N, 74, 86
Dimensions **H** 96 mm (3.78")
W 96 mm (3.78")
D 132 mm (5.2")

Communications TIA-232, RS-485, DeviceNet™, Ethernet
Warranty 10 years

Web Resources

www.littelfuse.com/fpu-32

| ORDERING NUMBER | SPECIFICATIONS | ACCESSORIES |
|-----------------|-------------------------------------|--|
| FPU-32-00-00 | TIA-232 Communications | Phase Current Transformers Ground-Fault Transformer |
| FPU-3200-01-00 | TIA-232 & RS-485 Communications | |
| FPU-3200-02-00 | TIA-232 & DeviceNet™ Communications | |
| FPU-3200-04-00 | TIA-232 & Ethernet Communications | |

FPS (PGR-7300) Feeder Protection System



Features/Benefits

- Monitors voltage and current
- Long-time overcurrent provides thermal protection for feeder or load
- Instantaneous overcurrent to detect catastrophic failure
- Coordinations using IEEE and IEC

Specifications

IEEE Device Numbers 27, 38, 46, 47, 49, 50, 50G/N, 51, 51G/N, 55, 59, 81,
Dimensions (OPI) **H** 98 mm (3.86")
W 192 mm (7.56")
D 0.42 mm (1.65")

Warranty 10 years

Web Resources

www.littelfuse.com/fps

| ORDERING NUMBER | SPECIFICATIONS | ACCESSORIES |
|-----------------|------------------------------------|--|
| FPS-CTU-01-00 | RS-485 Communications | Phase Current Transformers Ground-Fault Current Transformer MPS-RTD Temperature Input Module SE-IP65CVR-M Cover |
| FPS-CTU-02-00 | RS-485 & DeviceNet™ Communications | |
| FPS-CTU-03-00 | RS-485 & Profibus® Communications | |
| FPS-CTU-04-00 | RS-485 & Ethernet Communications | |
| FPS-OPI-01-00 | Recommended | |

ARC-FLASH PROTECTION AND GFCI

D0900 Arc-Flash Protection Relay



Features/Benefits

- Simple and cost effective solution for arc-flash monitoring
- Compact module fits into a wide range of applications
- Arc-flash trip time is less than 1 ms
- Single arc-flash relay can monitor 2 sensors

Specifications

| | |
|-------------------|------------------------|
| Dimensions | H 90 mm (3.5") |
| | W 105 mm (4.1") |
| | D 75 mm (3.0") |

Web Resources

www.littelfuse.com/d0900

| ORDERING NUMBER | SPECIFICATIONS | ACCESSORIES |
|-----------------|----------------|--------------------------|
| D0100.0010 | 48-220 Vdc | A0200 Light Sensor |
| D0100.0020 | 24 Vdc | A0300 Light Sensor |
| D0900.0010 | 220-250 Vac | D0400/D0500 Junction Box |

PGR-8800 (D1000) Arc-Flash Protection Relay



Features/Benefits

- Microprocessor-based relay that limits arc-fault damage by detecting the light from an arc flash and rapidly tripping
- Sensors, inputs and connections are monitored to ensure fail-safe operation
- Arc-flash trip time is less than 1 ms
- Single module can monitor up to 6 sensors and up to 4 PGR-8800 units can be linked into one system
- Phase-CT inputs provide overcurrent protection and prevent nuisance trips
- LED indication provides at-a-glance status for module and I/O state

Specifications

| | |
|----------------------------|------------------------|
| IEEE Device Numbers | 50, AFD |
| Dimensions | H 130 mm (5.2") |
| | W 200 mm (7.9") |
| | D 54 mm (2.2") |
| Communications | USB Interface |
| Warranty | 5 years |

Web Resources

www.littelfuse.com/afv

| ORDERING NUMBER | SPECIFICATIONS | ACCESSORIES |
|-----------------|---------------------------------------|---|
| PGR-8800-00 | Multi-unit linking, USB Communication | PGA-LS10 Point Sensor PGA-LS20 Fiber-Optic Sensor Current Transformer |

Industrial Shock-Block Ground-Fault Circuit Interruption

Enclosed Model



Open-Chassis Model

Features/Benefits

- First permanently connected special purpose GFCI
- Meets UL standard 943C Class C and Class D
- UL 943 inverse time trip curve reduces probability of nuisance tripping
- 3x Class T, 600 V incoming fuses provide overcurrent protection for the internal contractor

Specifications

| | |
|-------------------|--|
| Dimensions | Enclosed |
| | H 453 mm (17.8") |
| | W 406 mm (16.0") D 223 mm (8.8") |
| | Open-chassis |
| | H 387 mm (15.2") |
| | W 341 mm (13.4") D 161 mm (6.4") |

Web Resources

www.littelfuse.com/industrialshockblock

| ORDERING NUMBER | SPECIFICATIONS | TRIP LEVEL | ACCESSORIES |
|-----------------|----------------|-----------------------------|---|
| SB6100-00x-0 | 208 V | 20 mA Fixed | SB-OPI Operator Interface 1N5339B Termination Device |
| SB6100-10x-0 | 240 V | | |
| SB6100-20x-0 | 480 V | | |
| SB6100-30x-0 | 600 V | 6, 10, 20, 30 mA Selectable | |
| SB6100-01x-0 | 208 V | | |
| SB6100-11x-0 | 240 V | | |
| SB6100-21x-0 | 480 V | | |
| SB6100-31x-0 | 600 V | | |

Note: x=0 for open-chassis models and 1 for enclosed model

GENERATOR & SINGLE-FUNCTION PROTECTION

PGR-4300 Generator Ground-Fault Relay



Features/Benefits

- No CTs required
- Provides a simple method for tripping a ground-fault condition on generators
- Use with 3- or 4-pole transfer switches
- Monitors neutral-to-ground integrity
- Adjustable pick-up settings from 100 to 1200 A
- Adjustable time-delay settings from 0 to 1 sec

Specifications

IEEE Device Numbers 50G/N, 51G/N
Dimensions H 75 mm (3.0")
W 55 mm (2.2")
D 115 mm (4.5")
Communications Analog Output
Warranty 5 Year

Web Resources

www.littelfuse.com/pgr-4300

| ORDERING NUMBER | SPECIFICATIONS | ACCESSORIES |
|-----------------|-----------------------|-------------------------------|
| PGR-4300-12 | 12 Vdc Control Power | |
| PGR-4300-24 | 24 Vdc Control Power | PGA-0500 Analog Current Meter |
| PGR-4300-120 | 120 Vac Control Power | |

G2000 Power Relay



Features/Benefits

- Detects power level for protection, control and monitoring
- PC configuration for forward power or reverse power functionality
- User configured scales and setpoints suits a broad variety of applications
- 63 Vac to 690 Vac systems can be monitored by the same unit

Specifications

Supply 8-36 Vdc/0.75 W at 24 Vdc
Input Voltage 63-690 Vac \pm 30%
Input Current 5 A CT, max. 10 A
Frequency 35-75 Hz
Dimensions H 73 mm (2.9")
W 75 mm (3.0")
D 114 mm (4.5")

Web Resources

www.littelfuse.com/g2000

| ORDERING NUMBER | SPECIFICATIONS | ACCESSORIES |
|-----------------|---------------------------|-----------------------|
| G2000.0010 | 24 Vdc, 5 A Control Power | G0100 Programming Kit |

G3000 Frequency Relay



Features/Benefits

- Frequency monitor generators, busbars or other distribution systems
- PC configuration for over and under frequency protection one unit
- User configured scales and setpoints suits a broad variety of applications
- 63 Vac to 690 Vac systems can be monitored by the same unit

Specifications

Supply 8-36 Vdc/0.75 W at 24 Vdc
Input Voltage 63-690 Vac \pm 30%
Input Current 5 A CT, max. 10 A
Frequency 35-75 Hz
Dimensions H 73 mm (2.9")
W 75 mm (3.0")
D 114 mm (4.5")

Web Resources

www.littelfuse.com/g3000

| ORDERING NUMBER | SPECIFICATIONS | ACCESSORIES |
|-----------------|----------------------|-----------------------|
| G3000.0010 | 24 Vdc Control Power | G0100 Programming Kit |

GENERATOR & SINGLE-FUNCTION PROTECTION

G3300 Voltage Relay

CE



Features/Benefits

- Monitors voltage on generators, busbars or other distribution systems
- PC configuration for over and undervoltage protection in one relay
- User configured scales and setpoints suits a broad variety of applications
- Phase symmetry monitor enables use in grid connection applications
- 63 Vac to 690 Vac systems can be monitored by the same unit

Specifications

Supply 8-36 Vdc/0.75 W at 24 Vdc
Input Voltage 63-690 Vac \pm 30%
Frequency 35-75 Hz
Dimensions **H** 73 mm (2.9")
W 75 mm (3.0")
D 114 mm (4.5")

Web Resources

www.littelfuse.com/g3300

| ORDERING NUMBER | SPECIFICATIONS | ACCESSORIES |
|-----------------|----------------------|-----------------------|
| G3300.0010 | 24 Vdc Control Power | G0100 Programming Kit |

T2000 Reverse Power Relay

CE



Features/Benefits

- Protects the generator from being run as an electric motor
- Accepts high supply voltage variation to ensure correct operation in spite of voltage supply fluctuations
- Visual indication of power, pick-up and output trip provides quick and concise status information

Specifications

Trip level 2-20% I_N
Delay 2-20 sec.
Max. Voltage 660 V
Dimensions **H** 70 mm (2.8")
W 100 mm (3.9")
D 115 mm (4.5")

Web Resources

www.littelfuse.com/t2000

| ORDERING NUMBER | TERMINALS 1-3 | TERMINALS 2-3 | I_N | SUPPLY |
|-----------------|---------------|---------------|-------|--------|
| T2000.0010 | 230 V | | 5 A | L-N |
| T2000.0020 | 450 V | 400 V | 5 A | L-L |
| T2000.0030 | 127 V | 120 V | 5 A | L-N |
| T2000.0040 | 110 V | 100 V | 5 A | L-L |
| T2000.0050 | 110 V | 100 V | 5 A | L-L |
| T2000.0060 | 230 V | | 1 A | L-N |
| T2000.0070 | 660 V | | 5 A | L-L |
| T2000.0080 | 450 V | 400 V | 5 A | L-N |
| T2000.0090 | 127 V | 120 V | 5 A | L-L |
| T2000.0100 | 110 V | 100 V | 1 A | L-L |
| T2000.0110 | 450 V | 400 V | 5 A | L-L |
| T2000.0120 | 480 V | 415 V | 5 A | L-L |
| T2000.0130 | 230 V | | 5 A | L-N |
| T2000.0140 | 230 V | | 5 A | L-L |
| T2000.0150 | 480 V | 415 V | 1 A | L-L |
| T2000.0160 | 450 V | 400 V | 1 A | L-L |

T2100 Excitation Loss Relay

CE



Features/Benefits

- Protects against loss of excitation in a synchronous generator
- Accepts high supply voltage variation to ensure correct operation in spite of voltage supply fluctuations
- Visual indication of power, pick-up and output trip provides quick and concise status information

Specifications

Trip level 0.5-1.5 x I_N
Delay 2-20 sec.
Max. Voltage 660 V
Dimensions **H** 70 mm (2.8")
W 100 mm (3.9")
D 115 mm (4.5")

Web Resources

www.littelfuse.com/t2100

| ORDERING NUMBER | TERMINALS 1-3 | TERMINALS 2-3 | I_N | SUPPLY |
|-----------------|---------------|---------------|-------|--------|
| T2100.0010 | 230 V | | 5 A | L-N |
| T2100.0020 | 480 V | 415 V | 5 A | L-L |
| T2100.0030 | 450 V | 400 V | 5 A | L-L |
| T2100.0040 | 110 V | 100 V | 1 A | L-L |
| T2100.0050 | 110 V | 100 V | 5 A | L-L |
| T2100.0060 | 110 V | 100 V | 5 A | L-L |
| T2100.0070 | 480 V | 415 V | 5 A | L-L |
| T2100.0080 | 110 V | 100 V | 5 A | L-L |

GENERATOR & SINGLE-FUNCTION PROTECTION

T2200 3-Phase Overcurrent Relay

CE

Features/Benefits

- Designed for generator or feeder protection against overcurrent in each of the 3 phases
- Accepts high supply voltage variation to ensure correct operation in spite of voltage supply fluctuations
- Visual indication of power, pick-up and output trip provides quick and concise status information



Specifications

- Trip level** 0.5-1.4 x I_N
Delay 3-30 sec.
Max. Voltage 660 V
Dimensions H 70 mm (2.8")
W 100 mm (3.9")
D 115 mm (4.5")

Web Resources

www.littelfuse.com/t2200

| ORDERING NUMBER | TERMINALS 1-3 | TERMINALS 2-3 | I _N | FUNCTION |
|-----------------|---------------|---------------|----------------|--|
| T2200.0010 | 450 V | 400 V | 5 A | Latching output, resetable |
| T2200.0020 | 450 V | 400 V | 5 A | Normally energized output, latching, resetable |
| T2200.0030 | 230 V | | 5 A | Latching output, resetable |
| T2200.0040 | 230 V | 110 V | 5 A | Latching output, resetable |
| T2200.0050 | 230 V | | 1 A | Latching output, resetable |
| T2200.0060 | 450 V | 400 V | 5 A | Normally energized output, latching, resetable |
| T2200.0070 | 110 V | 100 V | 5 A | Latching output, resetable |
| T2200.0080 | 480 V | 415 V | 5 A | Latching output, resetable |
| T2200.0090 | 24 Vdc | | 5 A | Latching output, resetable |
| T2200.0100 | 450 V | 400 V | 5 A | Instantly extra output relay |
| T2200.0110 | 450 V | 400 V | 1 A | Instantly extra output relay |

T2300 3-Phase Short-Circuit Relay

CE

Features/Benefits

- Designed for protection of generators, power transmissions and consumer's supply against short circuit
- Accepts high supply voltage variation to ensure correct operation in spite of voltage supply fluctuations
- Visual indication of power, pick-up and output trip provides quick and concise status information



Specifications

- Trip level** 1.0-4.0 x I_N
Delay 0.1-1.0 sec.
Max. Voltage 660 V
Dimensions H 70 mm (2.8")
W 100 mm (3.9")
D 115 mm (4.5")

Web Resources

www.littelfuse.com/t2300

| ORDERING NUMBER | TERMINALS 1-3 | TERMINALS 2-3 | I _N | FUNCTION |
|-----------------|---------------|---------------|----------------|------------------------------|
| T2300.0100 | 230 V | | 5 A | |
| T2300.0020 | 450 V | 400 V | 5 A | |
| T2300.0030 | 24 Vdc | | 5 A | |
| T2300.0040 | 24 Vdc | | 1 A | |
| T2300.0050 | 450 V | 400 V | 5 A | Normally de-energized output |
| T2300.0060 | 480 V | 415 V | 5 A | |
| T2300.0070 | 230 V | | 1 A | |

T2400 3-Phase Dual Overcurrent Relay

CE

Features/Benefits

- Includes 2 combined overcurrent designed for protection or monitoring of generators and power transmissions
- Accepts high supply voltage variation to ensure correct operation in spite of voltage supply fluctuations
- Combining 2 relays is an economic solution for non-essential load tripping and occupying less space in the switch panel



Specifications

- Trip level** 0.5-1.4 x I_N
Delay 3-30 sec.
Max. Voltage 660 V
Dimensions H 70 mm (2.8")
W 100 mm (3.9")
D 115 mm (4.5")

Web Resources

www.littelfuse.com/t2400

| ORDERING NUMBER | TERMINALS 1-3 | TERMINALS 2-3 | I _N | FUNCTION |
|-----------------|---------------|---------------|----------------|--|
| T2400.0010 | 230 V | | 5 A | |
| T2400.0020 | 450 V | 400 V | 5 A | |
| T2400.0030 | 110 V | 100 V | 5 A | |
| T2400.0040 | 450 V | 400 V | 5 A | Latching output on relay 1, 6-60 sec. delay on relay 1 |
| T2400.0050 | 480 V | 415 V | 5 A | |
| T2400.0060 | 450 V | 400 V | 1 A | |
| T2400.0070 | 450 V | 400 V | 5 A | Latching output on relay 1, normally energized relay 1 |
| T2400.0080 | 127 V | 120 V | 5 A | |
| T2400.0090 | 24 Vdc | | 5 A | |

GENERATOR & SINGLE-FUNCTION PROTECTION

T2500 Overcurrent and Short-Circuit Relay

CE



Features/Benefits

- The short-circuit relays protects against faults causing high currents and the overcurrent relay protects against thermal damage
- Accepts high supply voltage variation to ensure correct operation in spite of voltage supply fluctuations
- Combining 2 relays is an economic solution, occupying less space in the switch panel

Specifications

| | |
|---------------------|--|
| Trip level | 0.5-1.4 x I _N |
| Delay | 3-30 sec. |
| Max. Voltage | 660 V |
| Dimensions | H 70 mm (2.8") W 100 mm (3.9") D 115 mm (4.5") |

Web Resources

www.littelfuse.com/t2500

| ORDERING NUMBER | TERMINALS 1-3 | TERMINALS 2-3 | I _N | FUNCTION |
|-----------------|---------------|---------------|----------------|---|
| T2500.0010 | 450 V | 400 V | 5 A | Latching output, resetable |
| T2500.0020 | 230 V | | 5 A | Latching output, resetable |
| T2500.0030 | 480 V | 415 V | 5 A | Latching output, resetable |
| T2500.0040 | 450 V | 400 V | 1 A | Latching output, resetable |
| T2500.0050 | 24 Vdc | | 5 A | Latching output, resetable |
| T2500.0060 | 230 V | | 5 A | De-energized extra output relay |
| T2500.0070 | 450 V | 400 V | 5 A | De-energized extra output relay |
| T2500.0080 | 450 V | 400 V | 5 A | De-energized extra output relay, latching outputs |
| T2500.0090 | 480 V | 415 V | 5 A | De-energized extra output relay |
| T2500.0100 | 24 Vdc | | 1 A | De-energized extra output relay |
| T2500.0110 | 450 V | 400 V | 5 A | De-energized extra output relay, latching short circuit output |
| T2500.0120 | 24 Vdc | | 5 A | De-energized extra output relay, de-energized relay 1, no internal power backup |

T2700 Power Relay

CE



Features/Benefits

- Detects power levels for protection, control or monitoring and will protect against excessive active loads
- Accepts high supply voltage variation to ensure correct operation in spite of voltage supply fluctuations
- Visual indication of power, pick-up and output trip provides quick and concise status information

Specifications

| | |
|---------------------|--|
| Trip level | 15-150 x I _N |
| Delay | 2-20 sec. |
| Max. Voltage | 660 V |
| Dimensions | H 70 mm (2.8") W 100 mm (3.9") D 115 mm (4.5") |

Web Resources

www.littelfuse.com/t2700

| ORDERING NUMBER | TERMINALS 1-3 | TERMINALS 2-3 | I _N | SUPPLY | FUNCTION |
|-----------------|---------------|---------------|----------------|--------|---------------------------|
| T2700.00 | 230 V | | 5 A | L-N | |
| T2700.02 | 450 V | 400 V | 5 A | L-L | |
| T2700.03 | 230 V | 400 V | 5 A | L-L | |
| T2700.04 | 110 V | 100 V | 5 A | L-L | Normally energized output |
| T2700.08 | 127 V | 120 V | 5 A | L-N | |

T2900 3-Phase Differential Relay

CE



Features/Benefits

- Monitors current leakage in generators and measures the differential current of each of the 3 phases
- Accepts high supply voltage variation to ensure correct operation in spite of voltage supply fluctuations
- Visual indication of power, pick-up and output trip provides quick and concise status information

Specifications

| | |
|---------------------|--|
| Trip level | 0.04-0.4 x I _N |
| Delay | 1-10 sec. (0.1-1 sec. bridging terminals 18/19) |
| Max. Voltage | 660 V |
| Dimensions | H 70 mm (2.8") W 100 mm (3.9") D 115 mm (4.5") |

Web Resources

www.littelfuse.com/t2900

| ORDERING NUMBER | TERMINALS 1-3 | TERMINALS 2-3 | I _N |
|-----------------|---------------|---------------|----------------|
| T2900.0010 | 450 V | 400 V | 5 A |
| T2900.0020 | 230 V | | 5 A |
| T2900.0030 | 480 V | 415 V | 5 A |
| T2900.0040 | 110 V | 100 V | 5 A |

GENERATOR & SINGLE-FUNCTION PROTECTION

T3000 Frequency Relay

CE



Features/Benefits

- Frequency monitor generators, busbars or other distribution systems
- Accepts high supply voltage variation to ensure correct operation in spite of voltage supply fluctuations
- Visual indication of power, pick-up and output trip provides quick and concise status information
- Combining 2 relays is an economic solution for monitoring both underfrequency and overfrequency in the same unit

Specifications

Overfrequency Level Delay 45-65 Hz
1-10 sec.
Underfrequency Level Delay 45-65 Hz
1-10 sec.
Max. Voltage 660 V
Dimensions H 70 mm (2.8")
W 100 mm (3.9")
D 115 mm (4.5")

Web Resources

www.littelfuse.com/t3000

| ORDERING NUMBER | TERMINALS 1-3 | TERMINALS 2-3 |
|-----------------|---------------|---------------|
| T3000.0010 | 230 V | |
| T3000.0020 | 450 V | 400 V |
| T3000.0030 | 110 V | 100 V |
| T3000.0040 | 480 V | 415 V |
| T3000.0050 | 127 V | 120 V |

T3100 Voltage Relay

CE



Features/Benefits

- Monitors voltage on generators, busbars or other distribution systems
- Signals when voltage is out of its limits
- Consists of two, one for overvoltage and one for undervoltage monitoring
- Accepts high supply voltage variation to ensure correct operation in spite of voltage supply fluctuations

Specifications

Overvoltage level Delay 100-120%
1-10 sec.
Undervoltage Level 80-100%
Max. Voltage 660 V
Dimensions H 70 mm (2.8")
W 100 mm (3.9")
D 115 mm (4.5")

Web Resources

www.littelfuse.com/t3100

| ORDERING NUMBER | TERMINALS 1-3 | TERMINALS 2-3 |
|-----------------|---------------|---------------|
| T3100.0010 | 230 V | |
| T3100.0020 | 450 V | 400 V |
| T3100.0030 | 110 V | 100 V |
| T3100.0040 | 480 V | 415 V |
| T3100.0060 | 127 V | 120 V |

T3300 3-Phase Voltage Relay

CE



Features/Benefits

- Monitors voltage on generators, busbars or other distribution systems
- Signals when voltage is out of its limits
- Consists of two, one for overvoltage and one for undervoltage monitoring
- Accepts high supply voltage variation to ensure correct operation in spite of voltage supply fluctuations

Specifications

Overvoltage Level Delay 100-120%
1-10 sec.
Undervoltage Level 80-100%
Max. Voltage 660 V
Dimensions H 70 mm (2.8")
W 150 mm (5.9")
D 115 mm (4.5")

Web Resources

www.littelfuse.com/t3300

| ORDERING NUMBER | TERMINALS 17-19, 21-23, 25-27 | TERMINALS 18-19, 22-23, 26-27 |
|-----------------|-------------------------------|-------------------------------|
| T3300.0010 | 230 V | |
| T3300.0020 | 450 V | 400 V |
| T3300.0030 | 110 V | 100 V |
| T3300.0040 | 480 V | 415 V |

GENERATOR CONTROL

T2600 Dual-Current Relay

CE

Features/Benefits

- Start or stop the standby diesel generator according to the load situation
- Accepts high supply voltage variation to ensure correct operation in spite of voltage supply fluctuations
- Visual indication of power, pick-up and output trip provides quick and concise status information



Specifications

Max. Voltage 600 V
Voltage Range 70-110%
Dimensions H 70 mm (2.8")
W 150 mm (5.9")
D 115 mm (4.5")

Web Resources

www.littelfuse.com/t2600

| ORDERING NUMBER | TERMINALS 1-3 | TERMINALS 2-3 | I _N | FUNCTION |
|-----------------|---------------|---------------|----------------|---|
| T2600.0010 | 230 V | | 5 A | 30 sec. or 1 sec.* |
| T2600.0020 | 450 V | 400 V | 5 A | 30 sec. or 1 sec.* |
| T2600.0030 | 480 V | 415 V | 5 A | 30 sec. or 1 sec.* |
| T2600.0040 | 450 V | 400 V | 5 A | 30 sec.*; bridge 17-18 = stop current increased 34% |
| T2600.0050 | 480 V | | 5 A | 30 sec.*; bridge 17-18 = stop current increased 34% |
| T2600.0060 | 110 V | 100 V | 5 A | 30 sec. or 1 sec.* |
| T2600.0070 | 110 V | 100 V | 5 A | 30 sec. or 1 sec.*; start current delay 1.0-10 secs |
| T2600.0080 | 230 V | | 5 A | 30 sec. or 1 sec.*; normally de-energized start relay |
| T2600.0090 | | | | Extension Unit |

T4500 Auto Synchronizer for Conventional Governors

CE

Features/Benefits

- Provides automatic synchronization of a generator to a busbar quickly via speed controller
- Inputs for disabling internal frequency control enables synchronization to external setpoint from other busbar sections, generators or the main grid
- Visual indication of signals provides quick and concise status information



Specifications

Max. Voltage 600 V
Voltage Range 70-110%
Dimensions H 70 mm (2.8")
W 100 mm (3.9")
D 115 mm (4.5")

Web Resources

www.littelfuse.com/t4500

| ORDERING NUMBER | TERMINALS 1-3, 5-7 | TERMINALS 2-3, 6-7 |
|-----------------|--------------------|--------------------|
| T4500.0010 | 450 V | 400 V |
| T4500.0020 | 230 V | |
| T4500.0030 | 480 V | 415 V |
| T4500.0040 | 110 V | 63 V |
| T4500.0050 | 127 V | 120 V |
| T4500.0060 | 110 V | 100 V |
| T4500.0070 | 600 V | |

T4800 Load Sharer for Conventional Governors

CE

Features/Benefits

- Provides automatic load sharing and frequency control for parallel running generators
- Inputs for disabling internal frequency control enables operation where system frequency is set externally such as in grid-parallel operation
- Visual indication of signals provides quick and concise status information



Specifications

Max. Voltage 600 V
Voltage Range 70-110%
Dimensions H 70 mm (2.8")
W 150 mm (5.9")
D 115 mm (4.5")

Web Resources

www.littelfuse.com/t4800

| ORDERING NUMBER | TERMINALS 1-3 | TERMINALS 2-3 | I _N |
|-----------------|---------------|---------------|----------------|
| T4800.0010 | 450 V | 400 V | 5 A |
| T4800.0020 | 230 V | | 5 A |
| T4800.0030 | 480 V | 415 V | 5 A |
| T4800.0040 | 110 V | 100 V | 1 A |
| T4800.0050 | 450 V | 400 V | 1 A |
| T4800.0060 | 127 V | 120 V | 5 A |
| T4800.0070 | 110 V | 100 V | 5 A |

GENERATOR CONTROL

T4900 VAR Load Sharer

CE

Features/Benefits

- Provides automatic load sharing of reactive power and voltage control for parallel running generators
- Inputs for disabling internal voltage control enables operation where system voltage is set externally such as in grid-parallel operation
- Visual indication of voltage increase/decrease provides quick and concise status information

Specifications

| | |
|----------------------|---|
| Max. Voltage | 660 V |
| Voltage Range | 110% |
| Dimensions | H 70 mm (2.8") W 150 mm (5.9") D 115 mm (4.5") |

Web Resources

www.littelfuse.com/t4900



| ORDERING NUMBER | TERMINALS 1-3 | TERMINALS 2-3 | I _N | ACCESSORIES |
|-----------------|---------------|---------------|----------------|---|
| T4900.0010 | 450 V | 400 V | 5 A | T4910-07 Potentiometer with Cable for External Power Factor Setting |
| T4900.0020 | 230 V | — | 5 A | |
| T4900.0030 | 480 V | 415 V | 5 A | |
| T4900.0040 | 110 V | 63 V | 5 A | |
| T4900.0050 | 127 V | 120 V | 1 A | |
| T4900.0060 | 110 V | 100 V | 1 A | |

T5000 Paralleling Relay

CE

Features/Benefits

- Inhibits closure of circuit breaker if synchronizing parameters such as voltage, frequency and phase angle are outside limits
- Prevents generator damage and disturbance to busbar
- Visual indication of voltage and closing signal provides quick and concise status information

Specifications

| | |
|----------------------|---|
| Max. Voltage | 600 V |
| Voltage Range | 70-110% |
| Dimensions | H 70 mm (2.8") W 100 mm (3.9") D 115 mm (4.5") |

Web Resources

www.littelfuse.com/t5000



| ORDERING NUMBER | TERMINALS 1-3 | TERMINALS 2-3 | FUNCTION |
|-----------------|---------------|---------------|--|
| T5000.0010 | 450 V | 400 V | |
| T5000.0020 | 230 V | | |
| T5000.0030 | 480 V | 415 V | |
| T5000.0040 | 110 V | 100 V | |
| T5000.0050 | 127 V | 120 V | |
| T5000.0060 | 480 V | 415 V | $\Delta\phi=9-13.5^\circ$, $\Delta F=0.2-0.3$ Hz |
| T5000.0070 | 450 V | 400 V | $\Delta U=15-20\%$, $\Delta\phi=9-13.5^\circ$, $\Delta F=0.2-0.3$ Hz |
| T5000.0080 | 110 V | 100 V | $\Delta U=15-20\%$, $\Delta\phi=9-13.5^\circ$, $\Delta F=0.2-0.3$ Hz |
| T5000.0090 | 450 V | 400 V | $\Delta\phi=9-13.5^\circ$, $\Delta F=0.2-0.3$ Hz |
| T5000.0100 | 660 V | | |

E7800 Motorized Potentiometer

UL SF

Features/Benefits

- Interface between increase/decrease contacts and a device requiring control/adjustments by an external potentiometer
- Can be used as speed trim of an electric speed governor in generator applications
- Wire would for longer life than carbon potentiometers

Specifications

| | |
|----------------------|---|
| Voltage Range | AC: 90-120% DC: 75-125% |
| Consumption | AC: 2.5 VA DC: 2 W |
| Dimensions | H 96 mm (3.8") W 96 mm (3.8") D 80 mm (3.1") |

Web Resources

www.littelfuse.com/e7800



| ORDERING NUMBER | VOLTAGE | RPM | POTENTIOMETER |
|-----------------|---------------|-------------|-------------------------------------|
| E7800.00.xx | 230 V-240 Vac | 1.0 (50 Hz) | 5 k Ω -1 turn |
| E7800.01.xx | 220 V-240 Vac | 2.0 (50 Hz) | 5 k Ω -10 turn |
| E7800.02.xx | 100 V-110 Vac | 1.0 (50 Hz) | 5 k Ω -1 turn |
| E7800.03.xx | 24 Vac | 2.0 (50 Hz) | 5 k Ω -10 turn |
| E7800.04.xx | 100 V-110 Vac | 2.0 (50 Hz) | 5 k Ω -10 turn |
| E7800.05.xx | 220 V-240 Vac | 2.0 (50 Hz) | 5 k Ω -1 turn |
| E7800.09.xx | 24 Vac | 1.0 (50 Hz) | 5 k Ω -1 turn |
| E7800.23.xx | 24 Vdc | 0.8-6 Adj. | 5 k Ω -1 turn |
| E7800.24.xx | 24 Vdc | 0.8-6 Adj. | 5 k Ω -10 turn |
| E7800.90.00 | 24 Vdc | 0.8-6 Adj. | DC output voltage, 0-1.0 V (0-100%) |

GENERATOR CONTROL

T7900 Electronic Potentiometer

CE



Features/Benefits

- Used as a converter between pulse contacts and a device requiring control adjustment by a voltage or current signal
- Wide selection of output ranges including PWM which ensures possible use with a broad variety of speed governors and voltage regulators
- Independent ramp-up and ramp-down time setting provides optimum controllability

Specifications

Supply 8-36 Vdc/Vac
Consumption Max. 120 mA at 24 Vdc
Dimensions **H** 70 mm (2.8")
W 100 mm (3.9")
D 115 mm (4.5")

Web Resources

www.littelfuse.com/t7900

| ORDERING NUMBER | TERMINALS 11-12 | TERMINALS 1-3 |
|-----------------|-----------------|---------------|
| T7900.0010 | 24 Vdc/Vac | |
| T7900.0030 | | 250 Vac |

M8100 Synchroscope



Features/Benefits

- Provides illuminated indication of the phase and frequency difference between voltages on two separate AC systems
- High resolutions visual indications by 38 LEDs
- Available with check synchronizer relay which enables use as manual synchronizing unit, or as auto -synchronizing back-up

Specifications

Max. Voltage 600 V
Voltage Range 70-110%
Consumption 2x3 VA max.
Dimensions **H** 96 mm (3.8")
W 96 mm (3.8")
D 80 mm (3.1")

Web Resources

www.littelfuse.com/m8100

| ORDERING NUMBER | TERMINALS 1-1, 5-7 | TERMINALS 1-3, 6-7 | FUNCTION |
|-----------------|--------------------|--------------------|-------------------------------|
| M8100.0010 | 450 V | 400 V | |
| M8100.0020 | 230 V | | |
| M8100.0030 | 480 V | 415 V | |
| M8100.0040 | 110 V | 100 V | |
| M8100.0050 | 450 V | 400 V | With check synchronizer relay |
| M8100.0060 | 230 V | | With check synchronizer relay |
| M8100.0070 | 480 V | 415 V | With check synchronizer relay |
| M8100.0080 | 110 V | 100 V | With check synchronizer relay |

T8400 Blackout Limiter

CE



Features/Benefits

- Enables fast clearing of a blackout
- Monitors up to four generators or eight generators with two units
- Independent 24 Vdc supply with wide tolerance operates regardless of system voltage failure

Specifications

Supply Voltage 24 Vdc 30%
Max. Voltage 660 Vac
Frequency Range 35-70 Hz
Dimensions **H** 70 mm (2.7")
W 150 mm (5.9")
D 115 mm (4.5")

Web Resources

www.littelfuse.com/m8400

| ORDERING NUMBER | TERMINALS 1-3, 8-10, 17-19, 24-26 | FUNCTION |
|-----------------|-----------------------------------|------------------|
| T8400.0010 | 400 V | 1-1.5-2-2.5 sec. |
| T8400.0020 | 400 V | 3-3.5-4-4.5 sec. |
| T8400.0030 | 230 V | 1-1.5-2-2.5 sec. |
| T8400.0040 | 230 V | 3-3.5-4-4.5 sec. |
| T8400.0050 | 415 V | 1-1.5-2-2.5 sec. |
| T8400.0060 | 415 V | 3-3.5-4-4.5 sec. |

GENERATOR CONTROL

C6200 FlexGen Standard Generator Control



Description

FlexGen controllers are intended for paralleling of generators with each other or with the grid. One FlexGen controller is installed for each generator in the installation and handles all electrical control. Both Basic and Advanced versions include basic functions such as auto-synchronizing, frequency control, active load sharing, dead bus monitoring and reverse power protection. In addition the FlexGen Advanced contains reactive load sharing, voltage matching, power factor control, grid-parallel operation control, and protection against excitation loss, RoCoF (df/dt), and vector shift.

Features/Benefits

- 3-phase true RMS measurement is more reliable and immune to high noise
- Analog outputs for speed and voltage control fit most electronic governors and
- 10 programmable inputs and outputs for flexible configuration on wide range of applications

Specifications

| | |
|----------------------------------|--|
| Auxiliary Supply | 10 Vdc to 36 Vdc (24 Vdc-58%/+50%) |
| Generator Voltage | 63 V-690 V |
| Generator Rated Frequency | 50 Hz/60 Hz |
| C/T Secondary Current | 5 A |
| Consumption | 7 W |
| Ambient Temp Range | -20°C to +70°C |
| Dimensions | H 182 mm (7.2") W 282 mm (11.1") D 50 mm (2.0") |

Web Resources

www.littelfuse.com/c6200

| ORDERING NUMBER | MODEL NAME | ACCESSORIES |
|-----------------|------------------|--|
| C6200.0060 | FlexGen Basic | C6500 FlexGen UI User Interface Module |
| C6200.0100 | FlexGen Advanced | |

S6000 Sigma Advanced Protection Module



Description

The SIGMA Generator Control and Protection System is a range of integrated modules for protection and control of marine and land based generators. The modules are marine approved and include all relevant functions, such as protection of generators, synchronizing and active/ reactive load sharing and Power Management.

**IO/P Module S6000
Input/ Output and Protection Module**

The SIGMA S6000 performs all measurements on the generator side (voltages, currents, frequency), does the generator protection, includes a non-essential load trip in two steps and includes three measurement transducers.

**S/LS Module S6100
Synchronizing and Load-Sharing Module**

This module performs the control functions like synchronizing and active and reactive load sharing. It performs the measurements on the busbar side.

Features/Benefits

- 3-phase true RMS measurement is more reliable and immune to high noise
- Analog outputs for speed and voltage control fit most electronic governors and
- Large consumer request inputs with load feedback optimizes quantity of running generators and saves fuel

Specifications

| | |
|-----------------------|---|
| Primary Supply | +24 Vdc (-30%/+30%) Isolated, 500 mA |
| Backup Supply | +24 Vdc (-30%/+30%) Isolated, 500 mA |
| Environmental | |
| Temp Range | -15°C to +70°C |
| Dimensions | H 145 mm (5.7") W 190 mm (7.5") D 64 mm (2.5") |

Web Resources

www.littelfuse.com/s6000

| ORDERING NUMBER | DESCRIPTION | ACCESSORIES |
|-----------------|--|---|
| S6000.0010 | Input/ Output and Protection Module– 5 A C/T | S6500.0010 Power Manager Module S6610.0010 User Interface Module |
| S6000.0020 | Input/ Output and Protection Module– 1 A C/T | |
| S6100.0010 | Synchronization and Load Sharing Module | |

ENGINE CONTROL AND DIAGNOSIS

M2000 Engine Control

CE



Features/Benefits

- Controls start and stop of the engine, monitors and protects the engine during start and operation, and simultaneously indicates the engine and alarm status on the front of the unit
- Eight inputs for monitoring e.g. oil pressure, coolant, temperature and engine speed
- Cable monitoring on sensor inputs for a fail safe system
- Can be combined with M0600 to build a complete control, alarm and safety system for marine engines

Specifications

| | |
|-----------------------|--|
| Voltage Supply | 12-24 Vdc±30% (8-32 Vdc) |
| Consumption | Max. 180 mA |
| Dimensions | H 144 mm (5.7") W 144 mm (5.7") D 35 mm (1.4") |

Web Resources

www.littelfuse.com/m2000

| ORDERING NUMBER | CONTROL POWER | ACCESSORIES |
|-----------------|--------------------------|--|
| M2000.0130 | 12-24 Vdc, IP54 at front | M0600 Shutdown Unit M0500 Tacho Detector K3452 RS232 Cable |

M2500 Engine Control and Monitoring Unit

CE



Features/Benefits

- Control and monitor engines in marine applications such as auxiliary generators, emergency generators and propulsion engines
- Allows manual (local) and automatic (remote) start of the engine and will monitor all engine parameters
- Nine digital alarm/shutdown inputs for monitoring e.g. oil pressure, coolant, temperature and engine speed
- Combine with M2600 to build a complete control, alarm and safety system for marine engines

Specifications

| | |
|------------------------|--|
| Operating Temp. | -15°C to +70°C |
| Humidity | 95% |
| Dimensions | H 137 mm (6.2") W 209 mm (8.2") D 39 mm (1.5") |

Web Resources

www.littelfuse.com/m2500

| ORDERING NUMBER | CONTROL POWER | ACCESSORIES |
|-----------------|---------------|--|
| M2500.0010 | 12-24 Vdc | M2600 Shutdown Unit K2502 SD Card K1025 USB A to B Cable |

E5000 Handheld EngineEye Unit

CE



Features/Benefits

- Reliable robust tool for engine diagnostics, consisting of a cylinder pressure analyzer for collection of measurements, a pressure sensor, an optional top dead center sensor and an optional crank angle sensor
- Tune and balance engine during operation
- Large display and intuitive software for easy operation

Specifications

| | |
|--------------------------|---|
| Pressure Range | 0-250 Bar |
| Pressure Accuracy | 1% |
| Temperature Range | -50 to +350°C |
| Dimensions | H 150 mm (5.9") W 260 mm (10.2") D 55 mm (2.2") |

Web Resources

www.littelfuse.com/e5000

| ORDERING NUMBER | DESCRIPTION | ACCESSORIES |
|-----------------|---|---|
| E5000.1000 | EngineEye Basic (E5000.0010 + E5100.0010) | |
| E5000.2000 | EngineEye Advanced (E5000.0020 + E5100.0010 + E5200.0010) | |
| E5000.3000 | EngineEye Professional (E5000.0030 + E5100.0010 + E5300.0010) | |
| E5100.0010 | Pressure Sensor with 1.5 m armored cable | E5250 Crank Angle Band E5220 Break-Out Box |
| E5200.0010 | Inductive TDC Sensor+Junction Box+Extension Cable (10 m armored) | |
| E5300.0010 | Crank Angle Sensor+ Crank Angle Band + Junction Box + Extension Cable | |

ALARM MONITORING

M1000 Alarm Monitor

CE



Features/Benefits

- Alarm panel with ten digital inputs that trigger a corresponding LED to flash with a common alarm and siren output
- Supports both normally open and normally closed input contacts
- Multiple units can be connected ad one system for a modular and scalable solution

Specifications

- Voltage Supply** 12-24 Vdc -30/+30% (8-32 Vdc)
48-110 Vdc -30/+40% (33-155 Vdc)
- Siren Relay Contact** 220 Vac/2 A; 30 Vdc/2 A, 30 W
- Communication** RS485 Interface
- Dimensions** **H** 144 mm (5.7")
W 144 mm (5.7")
D 35 mm (1.4")

Web Resources

www.littelfuse.com/m1000

| ORDERING NUMBER | CONTROL POWER | FUNCTION |
|-----------------|---------------|-------------------------------|
| M1000.0040 | 48-110 Vdc | IP54 front |
| M1000.0080 | 12-24 Vdc | IP54 front |
| M1000.0220 | 12-24 Vdc | Internal siren, IP54 at front |

M3000 Analog Alarm Annunciator

CE



Features/Benefits

- 24 inputs that can be configured individually for dry contact (normally open or normally closed) inputs or analog inputs
- Programmable 10-character LCD text so each alarm is indicated clearly
- 24 inputs and 48 alarms allow for individual reference to any input and easy configuration of group and individual alarms

Specifications

- Voltage Supply** 24 Vdc ±30%
- Consumption** Max. 400 mA
- Sensor Inputs** 24
- Alarms** 48
- LEDs** 24
- Communication** RS485 Interface
- Dimensions** **H** 144 mm (5.7")
W 144 mm (5.7")
D 70 mm (2.7")

Web Resources

www.littelfuse.com/m3000

| ORDERING NUMBER | CONTROL POWER | ACCESSORIES |
|-----------------|---------------|-------------------------------|
| M3000.0010 | 24 Vdc | M1500 PT100 6-way Transmitter |

M4200 Alarm Monitor

CE



Features/Benefits

- Cost effective solution, with the possibility of monitoring eight individual sensors
- Supports both normally open and normally closed input contacts
- Programmable LED color change allows flexible adjustment according to application
- Cable monitoring on sensor inputs indicates sensor health in case a sensor is lost

Specifications

- Voltage Supply** 8.4-40 Vdc; 8.4-50 Vac
- Consumption** Max. 180 mA
- Relay Output** Max. 250 Vac/6 A
- Dimensions** **H** 96 mm (3.8")
W 96 mm (3.8")
D 20 mm (0.8")

Web Resources

www.littelfuse.com/m4200

| ORDERING NUMBER | CONTROL POWER |
|-----------------|---------------|
| M4200.0010 | 24 Vdc |

ALARM MONITORING

M4500, M4600 & M4700 Alarm Indicators



Features/Benefits

The M4500, M4600 and M4700 Indicator Panels are intended for status indication of any process providing on/off outputs. The panels contain 6, 8 or 20 channels.

- Clamping fittings and plug-in terminal blocks allow for easy installation
- RS485 communication available for a remote display or PLCs



Specifications

| | |
|-----------------------|---|
| Voltage Supply | 24 Vdc ±25% |
| Dimensions | M4500: H 72 mm (2.8") W 72 mm (2.8") D 67 mm (2.6") M4600: H 96 mm (3.8") W 96 mm (3.8") D 67 mm (2.6") M4700: H 144 mm (5.7") W 144 mm (5.7") D 67 mm (2.6") |

Web Resources

- www.littelfuse.com/m4500
- www.littelfuse.com/m4600
- www.littelfuse.com/m4700

| ORDERING NUMBER | CONTROL POWER | INPUT REFERENCE | ACCESSORIES |
|-----------------|---------------|-----------------|---|
| M4500.0010 | 24 Vdc/Vac | +24 Vdc | |
| M4500.0020 | 48 Vdc/Vac | +48 Vdc | |
| M4500.0030 | 12 Vdc/Vac | +12 Vdc | |
| M4500.0040 | 24 Vdc/Vac | 0 Vdc | |
| M4500.0050 | 48 Vdc/Vac | 0 Vdc | |
| M4500.0060 | 12 Vdc/Vac | 0 Vdc | |
| M4600.0010 | 24 Vdc/Vac | +24 Vdc | M0845.0010 Front cover for M4500 with handle IP54 |
| M4600.0020 | 48 Vdc/Vac | +48 Vdc | |
| M4600.0030 | 12 Vdc/Vac | +12 Vdc | M0845.0020 Front cover for M4500 with key IP54 |
| M4600.0040 | 110 Vdc | +110 Vdc | |
| M4600.0050 | 24 Vdc/Vac | 0 Vdc | |
| M4600.0060 | 48 Vdc/Vac | 0 Vdc | M0846.0010 Front cover for M4600 with handle IP54 |
| M4600.0070 | 12 Vdc/Vac | 0 Vdc | |
| M4700.0010 | 24 Vdc/Vac | +24 Vdc | |
| M4700.0020 | 48 Vdc/Vac | +48 Vdc | |
| M4700.0030 | 12 Vdc/Vac | +12 Vdc | M0846.0020 Front cover for M4600 with key IP54 |
| M4700.0040 | 110 Vdc | +110 Vdc | |
| M4700.0050 | 24 Vdc/Vac | 0 Vdc | |
| M4700.0060 | 48 Vdc/Vac | 0 Vdc | M0847.0010 Front cover for M4700/M4780 with handle IP54 |
| M4700.0070 | 12 Vdc/Vac | 0 Vdc | |
| M4700.0080 | 110 Vdc | 0 Vdc | |
| M4700.0090 | 230 Vac | +24 Vdc | M0847.0020 Front cover for M4700/M4780 with key IP54 |
| M4700.0100 | 110 Vac | +24 Vdc | |
| M4700.0110 | 230 Vac | 0 Vdc | |
| M4700.0120* | 24 Vdc | +24 Vdc | |
| M4700.0120* | 24 Vdc | +24 Vdc | |
| M4700.0130† | 230 Vac | +24 Vdc | |
| M4780.0010‡ | 24 Vdc | 24 Vdc | |

*With common alarm relay, siren relay and built-in siren.

†Inverted reference. With common alarm relay, siren relay and built-in siren.

‡ Modbus Indicator Panel, 20 channels, 24 Vdc, common alarm relay and built-in siren.

H4000 HMI Operator Panels



Features/Benefits

The HMI operator panel is a touch-screen solution for SCADA solutions, designed for applications like engine control and supervision systems, power management systems and alarm systems. They can be integrated with products such as the M2500, Engine Controller, Generator Controllers and Alarm Panels.

- Clear, high-resolution screen provides high level of details

Specifications

| | |
|-------------------|---|
| Dimensions | M4000: H 219 mm (8.6") W 154 mm (6.0") D 6 mm (0.2") M4100: H 301 mm (11.9") W 228 mm (9.0") D 6 mm (0.2") M4200: H 398 mm (15.7") W 304 mm (12.0") D 6 mm (0.2") |
|-------------------|---|

Web Resources

- www.littelfuse.com/h4000



| ORDERING NUMBER | DESCRIPTION |
|-----------------|------------------------------|
| H4000.0010 | HMI Panel 6,5" |
| H4000.0020 | HMI Panel 6,5", sun readable |
| H4100.0010 | HMI Panel 10,4" |
| H4100.0020 | HMI Panel 10,4" sun readable |
| H4200.0010 | HMI Panel 15,1" |
| H4200.0020 | HMI Panel 15,1" sun readable |
| H4900.0010 | Programming Software |

CUSTOM PRODUCTS

Portable Power Centers



Description

Littelfuse Startco is the leading Canadian manufacturer of custom-built, portable mine power centers. Littelfuse Startco portable mine power centers are skid-mounted, metal-enclosed, and typically used in underground mines. The extremely rugged enclosure is mine-duty NEMA-12 casing, tub type, flat bottom, and typically features a dry-type power transformer, three-pole medium-voltage load interrupter switch, secondary power-distribution breakers, and application-specific controls and protection. Each Littelfuse Startco power center is HIPOT and High Voltage tested, and is fully tested and inspected before shipping.

Miner Control Console



Description

Littelfuse Startco builds very rugged and high-quality control consoles for portable mining machines. These consoles typically include Littelfuse MPU-32 or MPS Motor Protection Relays, rugged industrial automation equipment, and custom Littelfuse Startco keypads.

Custom-Built Panels



Description

Littelfuse Startco can assemble custom panels, complete with ground-fault and motor-protection relays as required.

Solid-State Soft Starters



Description

Littelfuse Startco Starters are designed for starting squirrel-cage induction motors in single or parallel operation on pumps, fans, conveyor belts, centrifuges, and other high-inertia loads. The Littelfuse Starters are an extremely rugged design that incorporates the SE-3SCR-LM Load Manager and Littelfuse motor protections.

PANEL MOUNT ADAPTERS • SOFTWARE • ACCESSORIES

Panel Mount Adapters







Features/Benefits





- Add communications capability to older switchgear and improve system performance
- Save cost by not calibrating older electromechanical devices
- Conformally coated circuit boards
- Additional protective functions, including reduced overcurrent and dynamic thermal model
- Minimal change-out time by using existing CTs
- PGR-6200 and PGR-6300 can use existing RTDs with an optional RTD module
- Ability to match existing overcurrent curves

Adapter Plates

| RELAY TO REPLACE | PANEL MOUNT | NEW RELAY |
|------------------------------|-----------------|-----------|
| AB BULLETIN 1406 | PMA-14 | MPS |
| FPL-GFRM | PMA-6 | SE-704 |
| FPL-GFRM | PMA-6 | SE-701 |
| GE S1 GE S1 | PMA-9 | MPU-32 |
| GE S1 | PMA-9 | FPU-32 |
| GE LODTRAK III | PMA-10 | MPU-32 |
| | PMA-13 | MPS |
| GE MULTILIN 169, 269, OR 369 | PMA-16 | MPU-32 |
| | PMA-16 | FPU-32 |
| GE MULTILIN 469 | PMA-24 | MPS |
| GE MULTILIN P4A | PMA-15 | MPU-32 |
| GE MULTILIN P4A | PMA-15 | FPU-32 |
| GEC/MCGG | PMA-3 | SE-704 |
| GEC/MCGG | PMA-3 | SE-701 |
| GE & WESTINGHOUSE FT-11 | PMA-12 | MPU-32 |
| P&B GOLDS | Contact Factory | FPU-32 |
| WESTINGHOUSE C09 & C011 | Contact Factory | FPU-32 |





Software

| Product | Image | Software For |
|--|---|--|
| SE-COMM-RIS Relay Interface Software |  | MPU-32 MPS FPU-32 FPS |
| VMPU Virtual Motor Protection Relay |  | MPU-32 |
| VMPS Virtual Motor Protection System |  | MPS |
| VFPU Virtual Feeder Protection Relay |  | FPU-32 |
| PGW-6150 Relay Interface Software |  | PGR-6150 |

| Product | Image | Software For |
|--|---|--|
| SE-FLASH Firmware Update Utility |  | MPU-32 MPS FPU-32 FPS |
| SE-MON330 Relay Interface Software |  | SE-330 SE-330HV SE-330AU |
| MPU-32 Tutorial PGR-6200 Online Self-Training Tutorial |  | MPU-32 |
| H4900 Programming Software |  | H4000 H4100 H4200 |
| PGW-8800 Relay Interface Software |  | PGR-8800 |

Accessories

Most protective relays require an accessory for operation. Visit www.littelfuse.com/relayscontrols for a complete listing.

| PRODUCT | Image |
|--------------------------|---|
| Current Transformers |  |
| Ground Reference Modules |  |
| High Tension Couplers |  |
| Protection Relay Testers |  |
| Input Modules |  |

| PRODUCT | Image |
|--|---|
| Remote Indication and Meters |  |
| Sensing Resistors |  |
| Terminations and Adapters |  |
| Accessories for Controls and Diagnostics |  |
| DIN Mount Adapters |  |

Section Overview

System overvoltage is a growing concern in the electrical industry. Component miniaturization has resulted in increased sensitivity to many devices. The majority of these devices are unable to handle high currents that result from Electrostatic Discharge (ESD) and other voltage transients. Littelfuse® offers a broad range of overvoltage protection to safeguard against these conditions.



→ SUPPRESSION PRODUCTS ←

Table of Contents

| | |
|------------------------------------|-----|
| Industrial Varistor Products | 177 |
| Surge Suppression Fuses | 179 |

OVERVOLTAGE SUPPRESSION PRODUCTS

Varistors, Surge Fuses and Varistor Assemblies



What Are Transients?

Transients are short duration surges of electrical energy that result from the sudden release of previously stored energy. In terms of electrical and electronic circuits, this energy can be released through intentional, controlled switching action, or induced into a circuit from external sources. If the voltage magnitude of the transient is large enough, circuit component damage or malfunction of the circuit may result.

Transient Sources and Magnitude

| | VOLTAGE | CURRENT | RISE-TIME | DURATION |
|-----------|---------|---------|------------|----------|
| Lightning | 25 kV | 20 kA | 10 μ s | 50 ms |
| Switching | 600 V | 500 A | 50 μ s | 500 ms |
| EMP | 300 kV | 10 A | 20 ns | 1 ms |
| ESD | 15 kV | 30 A | 1-5 ns | 100 ns |

Transient Voltage Scenarios

The switching of inductive loads generates high energy transients that increase in magnitude with increasingly heavy loads. When the inductive load is switched off, the collapsing magnetic field is converted into electrical energy, which takes the form of a double exponential transient. Depending on the source, these transients can be as large as hundreds of volts and hundreds of amps with duration times of 400 milliseconds.

Typical sources of inductive transients are:

- Generators
- Motors
- Relays
- Transformers

These examples are extremely common in electrical and electronic systems. Because the sizes of the loads vary according to the application, the wave shape, duration, peak current, and peak voltage are all variables which exist in real world transients. Once these variables can be approximated, a suitable suppressor technology can be selected.

Overvoltage Applications

- Industrial, High Energy AC Products such as Solenoids, Motor Drives and Robotics
- Telecommunications Products
- UPS, AC Panels, Power Supplies, Circuit Breakers (TVSS Products)
- Portable and Automotive Electronic Equipment

Lightning Induced Transients

Transients induced by lightning are not the result of a direct strike. When a lightning strike occurs, the event creates a magnetic field which can induce transients of large magnitude in nearby electrical cables.

Technological Solutions for Transient Threats

Because of the various types of transients and applications, it is necessary to employ protection devices with different characteristics in different applications. Littelfuse offers the broadest range of circuit protection technologies. Our overvoltage protection portfolio includes:

MOVs (Metal Oxide Varistors)

A ceramic technology that offers medium to very high energy ratings for a wide range of applications. Available in screw terminal, radial, square and axial leaded connections.

Discrete TVS Diode

This Silicon Avalanche Diode Technology is available in surface mount and axial leaded packages. It offers protection from medium to very high energy transients and can be used in wide range of applications.



OVERVOLTAGE SUPPRESSION PRODUCTS

Varistors, Surge Fuses and Varistor Assemblies



Radial Leaded MOV

| SERIES NAME ¹ | OPERATING AC VOLTAGE RANGE | OPERATING DC VOLTAGE RANGE | PEAK CURRENT RANGE ² (A) | PEAK ENERGY RANGE ³ | OPERATING TEMPERATURE RANGE | MOUNT/FORM FACTOR | DISC SIZE | AGENCY | | | | | |
|--------------------------|----------------------------|----------------------------|-------------------------------------|--------------------------------|-----------------------------|-------------------|----------------------|--------|-----|-----|------|------|-----------|
| | | | | | | | | UL | CSA | VDE | CECC | ROHS | LEAD FREE |
| TMOV®/iTMOV® | 115-750 | — | 6000-10,000 | 35-480 | -55 to +85°C | Radial Leaded | 14, 20, 34 mm | • | • | • | • | • | • |
| TMOV® 25S | 115-750 | — | 20,000 | 170-670 | | | 25 mm | • | | | | • | • |
| UltraMOV™ | 130-625 | 170-825 | 1750-10,000 | 12.5-720 | | | 7, 10, 14, 20, 25 mm | • | • | • | • | • | • |
| UltraMOV™ 25S | 115-750 | 150-970 | 22,000 | 230-890 | | | 25 mm | • | • | • | • | • | • |
| C-III | 130-660 | | 3500-9000 | 40-530 | | | 10, 14, 20 mm | • | • | • | • | • | • |
| LA | 130-1000 | 175-1200 | 1200-6500 | 11-360 | | | 7, 10, 14, 20 mm | • | • | • | • | • | • |
| ZA | 4-460 | 5.5-615 | 50-6500 | 0.1-52 | | | 5, 7, 10, 14, 20 mm | • | • | • | • | • | • |

Industrial High Energy Terminal MOV

| SERIES NAME ¹ | OPERATING AC VOLTAGE RANGE | OPERATING DC VOLTAGE RANGE | PEAK CURRENT RANGE ² (A) | PEAK ENERGY RANGE ³ | OPERATING TEMPERATURE RANGE | MOUNT/FORM FACTOR | DISC SIZE | AGENCY | | | |
|--------------------------|----------------------------|----------------------------|-------------------------------------|--------------------------------|-----------------------------|----------------------------------|-----------|--------|-----|------|-----------|
| | | | | | | | | UL | CSA | ROHS | LEAD FREE |
| BA/BB | 130-2800 | 175-3500 | 50,000 70,000 | 450-10000 | -55 to +85°C | Screw / Clip Terminals | 60 mm | • | | • | |
| DA/DB | 130-750 | 175-970 | 40,000 | 270-1050 | | | 40 mm | • | | • | • |
| HA | 130-750 | 175-970 | 25,000 40,000 | 200-1050 | | | 32, 40 mm | • | • | • | • |
| TMOV34S® | 115-750 | — | 40,000 | 235-1050 | | Industrial Packaged Radial Leads | 34 mm | • | | • | • |
| HB34, HG34, HF34 | 130-750 | 175-970 | 40,000 | 270-1050 | | | 34 mm | • | • | • | • |
| DHB34 | 250-2800 | 330-3500 | 20,000 70,000 | 330-10000 | | | 34 mm | | | | • |
| CA | 250-2800 | 330-3500 | 20,000 70,000 | 330-10000 | | Bare Disc | 60 mm | | | | • |

High Power TVS Diodes

| Series Name ¹ | Package Type | Reverse Standoff Voltage (V _R) | Peak Pulse Power Range ¹ (P _{PP}) | Peak Pulse Current (I _{PP} 8x20µs) | Operating Temperature | Halogen Free | RoHS Compliant |
|--------------------------|--------------|--|--|---|--------------------------------------|--------------|----------------|
| 15KPA | P600 | 17-280 | 15000W | Not Applicable | -85° to +302° F (-55° to +175° C) | • | • |
| 20KPA | | 20.0-300 | 20000W | | | • | • |
| 30KPA | | 28.0-288 | 30000W | | | • | • |
| AK6 | Radial Lead | 58-430 | NA | 6000A | -67° to +347° F (-55° to +150° C) | • | • |
| AK10 | Radial Lead | 58-430 | NA | 10000A | | • | • |

1. Detailed information about most product series listed here can be found on www.littelfuse.com/varistor
 2. Not an applicable parameter for Crowbar devices
 3. Value shown in Joules

LVSP SURGE SUPPRESSION FUSE

600 Volt • 5-100 kA



Description

The Littelfuse® Varistor Protection (LVSP) Fuses are intended for the protection of TVSS products. The LVSP series has been designed to survive the 8 x 20 μs lightning surges described in various standards (UL 1449, IEC 61000-4-5 and IEEE C62.41) without opening. This allows the TVSS to perform the necessary suppression. The LVSP is not rated for continuous current and the ratings are specific 8 x 20 μs surge capability. The LVSP series can be used to facilitate TVSS module compliance to UL 1449 in permanently connected applications (abnormal overvoltage, unlimited current conditions).

Dimensions Inches (mm)

Figure 1: Cartridge 5-20 A Figure 2: Cartridge 30-80 A Figure 3: Leaded 5-20 A

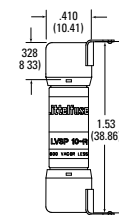
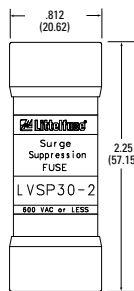
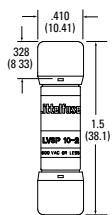

Figure 4: Bolt-In 30-80 A

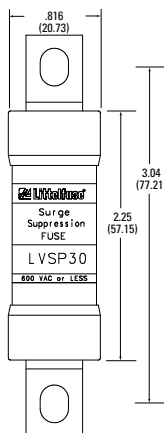
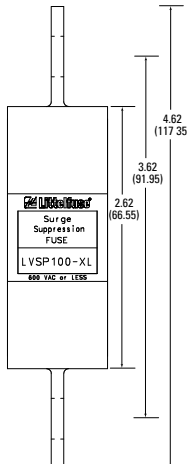

Figure 5: Bolt-In 100 A



Features/Benefits

- Very current limiting under AC short-circuit conditions
- Available in multiple mounting configurations (cartridge, bolt-in, PC board mount)
- Provides short circuit protection in TVSS systems and complements the Littelfuse line of overvoltage products (HA, HB34, TMOV® and iTMOV® varistors as well as the AK-10 series TVS diodes)

Applications

- TVSS products
- Surge arrestors

| CATALOG NUMBER | ORDERING NUMBER | 8 X 20 μS SURGE RATING | NOMINAL MELTING I ² T (A ² S) | NOMINAL CLEARING I ² T (A ² S) | I _{peak} @100 kHz (A) |
|----------------|-----------------|------------------------|---|--|--------------------------------|
| LVSP5 | LVSP005T | 5,000 | 359 | 981 | 3,700 |
| LVSP10 | LVSP0010T | 10,000 | 1,300 | 3,210 | 5,823 |
| LVSP15 | LVSP0015T | 15,000 | 3,267 | 6,235 | 7,765 |
| LVSP20 | LVSP0020T | 20,000 | 4,940 | 11,710 | 8,135 |
| LVSP30 | LVSP0030T | 30,000 | 11,950 | 35,325 | 12,478 |
| LVSP40 | LVSP0040T | 40,000 | 20,550 | 61,700 | 15,250 |
| LVSP60 | LVSP0060T | 60,000 | 39,240 | 145,555 | 19,604 |
| LVSP80 | LVSP0080T | 80,000 | 75,000 | 254,000 | 24,600 |
| LVSP100 | LVSP0100T | 100,000 | Contact Factory | | |

Specifications

- Voltage Rating** 600 VAC
- Interrupting Rating** 200 kA
- Ratings** 5 – 100 kA 8 x 20 μs surge withstand
- Approvals** UL Recognized (File No. E71611)

Recommended Fuse Blocks

- LVSP (5-20)-2**
- L60030M (open block) 99
 - LPSM (dead front)..... 108

- LVSP (30-80)-2**
- LFJ60030 (open block) 83
 - LPSJ30 (dead front) 113

- LVSP (100)**
- LFJ60100 (open block)..... 83

Mounting Options

| SURGE RATING | CATALOG/ORDERING NUMBER | | | | | |
|--------------|-------------------------|-------------|---------|-------------|-----------|-------------|
| | CARTRIDGE | | LEADED | | BOLT-IN | |
| 5 | LVSP52 | LVSP0005TX2 | LVSP5R | LVSP0005TXR | – | – |
| 10 | LVSP102 | LVSP0010TX2 | LVSP10R | LVSP0010TXR | – | – |
| 15 | LVSP152 | LVSP0015TX2 | LVSP15R | LVSP0015TXR | – | – |
| 20 | LVSP202 | LVSP0020TX2 | LVSP20R | LVSP0020TXR | – | – |
| 30 | LVSP302 | LVSP0030TX2 | – | – | LVSP30 | LVSP0030T |
| 40 | LVSP402 | LVSP0040TX2 | – | – | LVSP40 | LVSP0040T |
| 60 | LVSP60-2 | LVSP0060TX2 | – | – | LVSP60 | LVSP0060T |
| 80 | LVSP802 | LVSP0080TX2 | – | – | LVSP80 | LVSP0080T |
| 100 | – | – | – | – | LVSP100-L | LVSP0100VXL |

Note: Contact factory for dimensions and availability of specific mounting configurations.

For additional information, visit www.littelfuse.com/lvsp

Section Overview

With over 25 locations around the globe, Littelfuse® is the supplier of choice when it comes to international fuses, fuse holders and accessories. With an ever expanding portfolio of products and global resources, we provide comprehensive solutions for each customer's unique application no matter where they are located around the world.

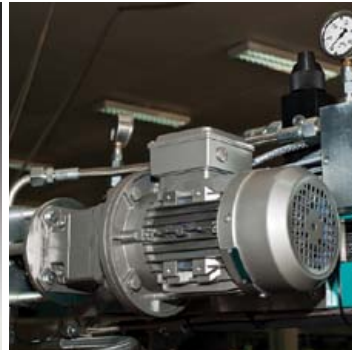

INTERNATIONAL PRODUCTS

Table of Contents

| | |
|-------------------------|-----|
| NH Fuse Links | 181 |
| Cylindrical Fuses | 183 |



International Products

Look for latest international products. Visits us online at:

www.littelfuse.com

NH FUSE LINKS

500 Volts • 2-630 A



Description

Littelfuse® European style NH fuse links are designed for the protection of conductors and motors. The gL-gG characteristic fuse links are generally used to protect cables and installation lines from overloads and short-circuits. The aM characteristic fuse links are used for the short-circuit protection of motors and switchgear. They are available in NH00C to NH3 sizes up to 630 A.

Specifications

| | |
|----------------------------|--|
| Voltage Rating | 500 VAC 440 VDC |
| Ampere Range | 2-630 A |
| Interrupting Rating | 120 kA AC 25 kA DC |
| Standards | DIN 43.620, IEC 269-2-1 |
| Approvals | VDE |
| Example part number | NH1CG25 (size, characteristic and amperage) |
| Indication | All NH fuse links incorporate a blown fuse indicator |

Recommended Fuse Holders

| | |
|---------------------------|-----|
| NH Fuse Base | 182 |
| NH Fuse Disconnects | 182 |

Web Resources

For the latest international fuse products, visit:
www.littelfuse.com/nh

Ordering Information

| AMPERAGE | gL-gG 500 V ORDERING NUMBER | | | | | aM 500 V ORDERING NUMBER | | | |
|----------|-----------------------------|---------|------------|------------|------------|--------------------------|---------|---------|---------|
| | NH00C / NH00 | NH0 | NH1C / NH1 | NH2C / NH2 | NH3C / NH3 | NH00CM | NH1 | NH2 | NH3 |
| 2 | NH00CG2 | — | — | — | — | NH00CM2 | — | — | — |
| 4 | NH00CG4 | — | — | — | — | NH00CM4 | — | — | — |
| 6 | NH00CG6 | NH0G6 | — | — | — | NH00CM6 | — | — | — |
| 10 | NH00CG10 | NH0G10 | — | — | — | NH00CM10 | — | — | — |
| 16 | NH00CG16 | NH0G16 | — | — | — | NH00CM16 | — | — | — |
| 20 | NH00CG20 | NH0G20 | — | — | — | NH00CM20 | — | — | — |
| 25 | NH00CG25 | NH0G25 | NH1CG25 | — | — | NH00CM25 | — | — | — |
| 32 | NH00CG32 | NH0G32 | NH1CG32 | — | — | NH00CM32 | — | — | — |
| 35 | NH00CG35 | NH0G35 | NH1CG35 | — | — | NH00CM35 | — | — | — |
| 40 | NH00CG40 | NH0G40 | NH1CG40 | NH2CG40 | — | NH00CM40 | — | — | — |
| 50 | NH00CG50 | NH0G50 | NH1CG50 | NH2CG50 | — | NH00CM50 | — | — | — |
| 63 | NH00CG63 | NH0G63 | NH1CG63 | NH2CG63 | — | NH00CM63 | NH1M63 | — | — |
| 80 | NH00CG80 | NH0G80 | NH1CG80 | NH2CG80 | — | NH00CM80 | NH1M80 | — | — |
| 100 | NH00CG100 | NH0G100 | NH1CG100 | NH2CG100 | — | NH00CM100 | NH1M100 | — | — |
| 125 | NH00G125 | NH0G125 | NH1CG125 | NH2CG125 | — | — | NH1M125 | NH2M125 | — |
| 160 | NH00G160 | NH0G160 | NH1CG160 | NH2CG160 | — | — | NH1M160 | NH2M160 | — |
| 200 | — | — | NH1G200 | NH2CG200 | — | — | NH1M200 | NH2M200 | — |
| 224 | — | — | NH1G224 | NH2CG224 | — | — | NH1M224 | NH2M224 | — |
| 250 | — | — | NH1G250 | NH2CG250 | — | — | NH1M250 | NH2M250 | — |
| 300 | — | — | — | NH2G300 | — | — | — | NH2M300 | — |
| 315 | — | — | — | NH2G315 | NH3CG315 | — | — | NH2M315 | NH3M315 |
| 355 | — | — | — | NH2G355 | NH3CG355 | — | — | NH2M355 | NH3M355 |
| 400 | — | — | — | NH2G400 | NH3CG400 | — | — | NH2M400 | NH3M400 |
| 425 | — | — | — | — | NH3G425 | — | — | — | — |
| 500 | — | — | — | — | NH3G500 | — | — | — | NH3M500 |
| 630 | — | — | — | — | NH3G630 | — | — | — | NH3M630 |

NH FUSE LINKS DIMENSIONS, BASES, AND DISCONNECTS

Dimensions

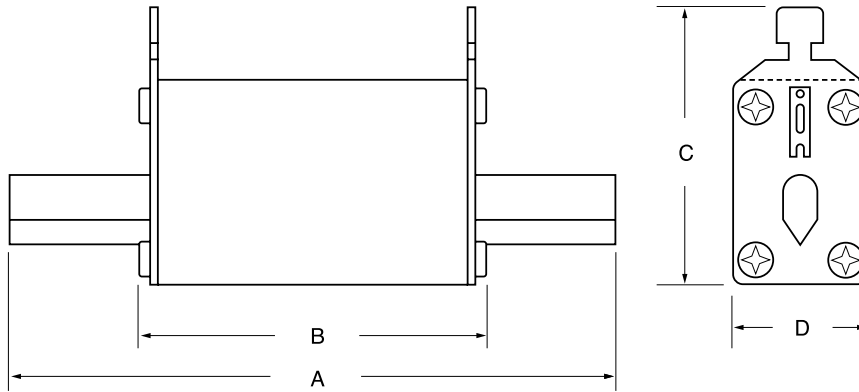

| SIZE | CURRENT RANGE | VOLTAGE (AC/DC) | INTERRUPTING RATING (AC/DC) | NOMINAL FREQUENCY | SELECTIVITY | DIMENSIONS (mm) | | | |
|------|---------------|-----------------|-----------------------------|-------------------|-------------|-----------------|-------|-------|-------|
| | | | | | | A | B | C | D |
| 00C | 2-100 A | 500 V/440 V | 120 kA/25 kA | 45 - 62 HZ | 1:1 25 | 78.00 | 54.00 | 51.30 | 20.00 |
| 00 | 125-160 A | 500 V/440 V | 120 kA/25 kA | 45 - 62 HZ | 1:1 25 | 78.00 | 54.00 | 56.40 | 30.00 |
| 0 | 6-160 A | 500 V/440 V | 120 kA/25 kA | 45 - 62 HZ | 1:1 25 | 123.95 | 70.11 | 53.34 | 30.00 |
| 1C | 25-160 A | 500 V/440 V | 120 kA/25 kA | 45 - 62 HZ | 1:1 25 | 135.00 | 72.00 | 56.40 | 30.00 |
| 1 | 63-250 A | 500 V/440 V | 120 kA/25 kA | 45 - 62 HZ | 1:1 25 | 135.00 | 72.00 | 65.00 | 40.00 |
| 2C | 40-250 A | 500 V/440 V | 120 kA/25 kA | 45 - 62 HZ | 1:1 25 | 150.00 | 72.00 | 61.00 | 40.00 |
| 2 | 125-400 A | 500 V/440 V | 120 kA/25 kA | 45 - 62 HZ | 1:1 25 | 150.00 | 72.00 | 74.20 | 50.00 |
| 3C | 315-400 A | 500 V/440 V | 120 kA/25 kA | 45 - 62 HZ | 1:1 25 | 150.00 | 72.00 | 74.20 | 50.00 |
| 3 | 315-630 A | 500 V/440 V | 120 kA/25 kA | 45 - 62 HZ | 1:1 25 | 150.00 | 72.00 | 84.00 | 71.88 |

NH Fuse Bases and Disconnects

Fuse Bases

| CATALOG NUMBER | ORDERING NUMBER | SIZE | RATING | CONNECTION |
|----------------|-----------------|------|-------------|------------|
| NHB00B | NHB00B | 00 | 690 V/160 A | Bolt |
| NHB00C | NHB00C | 00 | 690 V/160 A | V-Clamp |
| NHB1B | NHB1B | 1 | 690 V/250 A | Bolt |
| NHB2B | NHB2B | 2 | 690 V/400 A | Bolt |
| NHB3B | NHB3B | 3 | 690 V/630 A | Bolt |

All fuse bases are single pole and gangable.

Fuse Disconnects

| CATALOG NUMBER | ORDERING NUMBER | SIZE | RATING | CONNECTION |
|----------------|-----------------|------|-------------|------------|
| NHFS00B | NHFS00B | C00 | 690 V/100 A | Bolt |
| NHFS0B | NHFS0B | 0 | 690 V/160 A | Bolt |
| NHFS1B | NHFS1B | 1 | 690 V/250 A | Bolt |
| NHFS2B | NHFS2B | 2 | 690 V/400 A | Bolt |
| NHFS3B | NHFS3B | 3 | 690 V/630 A | Bolt |

All disconnects are 3 pole.

Contact factory for dimensional information.

Web Resources

For the latest international fuse products, visit:
www.littelfuse.com/nh

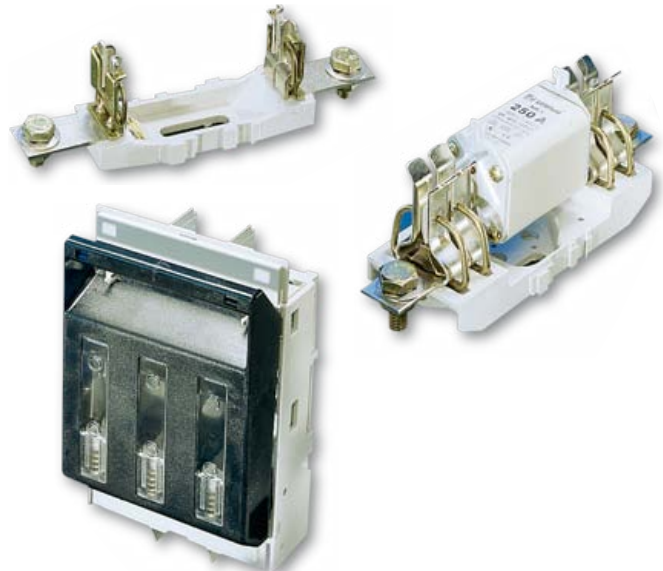

CYLINDRICAL FUSES

500 Volts • 0.5-100 A



Description

Littelfuse® fast acting (gL-gG) fuses are used for the protection of cables against short-circuits. Time-lag (aM) fuses are used for protection of motors.

Specifications

Standards IEC 269-2-1

Ordering Information

| BASE PART NUMBER | SIZE (mm) | CURRENT RANGE | VOLTAGE AC | INTERRUPTING RATING |
|------------------|------------|---------------------------|---|---------------------------|
| CY10X38 | 10 X 38 mm | 0.5-25 A 32 A | 500 V 400 V | 120 kA |
| CY14X51 | 14 X 51 mm | 2-25 A 32-40 A 50 A | 690 V 500 V 400 V (aM) / 500 V (gL-gG) | 80 kA 120 kA 120 kA |
| CY22X58 | 22 X 58 mm | 16-63 A 80-100 A | 690 V 500 V | 80 kA 120 kA |

| AMPERAGE | gL-gG ORDERING NUMBERS | | | aM ORDERING NUMBERS | | | |
|-----------------|------------------------|------------|-------------|---------------------|------------|-------------|----|
| | 10 X 38 | 14 X 51 | 22 X 58 | 10 X 38 | 14 X 51 | 22 X 58 | |
| 0.5 | CY10X38G05 | — | — | CY10X38M05 | — | — | |
| 1 | CY10X38G1 | — | — | CY10X38M1 | — | — | |
| 2 | CY10X38G2 | CY14X51G2 | — | CY10X38M2 | CY14X51M2 | — | |
| 4 | CY10X38G4 | CY14X51G4 | — | CY10X38M4 | CY14X51M4 | — | |
| 6 | CY10X38G6 | CY14X51G6 | — | CY10X38M6 | CY14X51M6 | — | |
| 8 | CY10X38G8 | CY14X51G8 | — | CY10X38M8 | CY14X51M8 | — | |
| 10 | CY10X38G10 | CY14X51G10 | — | CY10X38M10 | CY14X51M10 | — | |
| 12 | CY10X38G12 | CY14X51G12 | — | CY10X38M12 | CY14X51M12 | — | |
| 16 | CY10X38G16 | CY14X51G16 | CY22X58G16 | CY10X38M16 | CY14X51M16 | CY22X58M16 | |
| 20 | CY10X38G20 | CY14X51G20 | CY22X58G20 | CY10X38M20 | CY14X51M20 | CY22X58M20 | |
| 25 | CY10X38G25 | CY14X51G25 | CY22X58G25 | CY10X38M25 | CY14X51M25 | CY22X58M25 | |
| 32 | CY10X38G32 | CY14X51G32 | CY22X58G32 | CY10X38M32 | CY14X51M32 | CY22X58M32 | |
| 40 | — | CY14X51G40 | CY22X58G40 | — | CY14X51M40 | CY22X58M40 | |
| 50 | — | CY14X51G50 | CY22X58G50 | — | CY14X51M50 | CY22X58M50 | |
| 63 | — | — | CY22X58G63 | — | — | CY22X58M63 | |
| 80 | — | — | CY22X58G80 | — | — | CY22X58M80 | |
| 100 | — | — | CY22X58G100 | — | — | CY22X58M100 | |
| DIMENSIONS (mm) | A | 10 | 14 | 22 | 10 | 14 | 22 |
| | B | 38 | 51 | 58 | 38 | 51 | 58 |

Fuse Holders

| CATALOG/ ORDERING # | SIZE | POLES | AMP RATING | VOLTAGE | TERMINAL TYPE |
|---------------------|---------|-------|------------|---------|----------------|
| CYH10381 | 10 X 38 | 1 | 32 A | 690 V | Pressure Plate |
| CYH10382 | 10 X 38 | 2 | 32 A | 690 V | Pressure Plate |
| CYH10383 | 10 X 38 | 3 | 32 A | 690 V | Pressure Plate |
| CYH10381ID* | 10 X 38 | 1 | 32 A | 690 V | Pressure Plate |
| CYH14511 | 14 X 51 | 1 | 50 A | 690 V | Pressure Plate |
| CYH14512 | 14 X 51 | 2 | 50 A | 690 V | Pressure Plate |
| CYH14513 | 14 X 51 | 3 | 50 A | 690 V | Pressure Plate |
| CYH22581 | 22 X 58 | 1 | 125 A | 690 V | Pressure Plate |
| CYH22582 | 22 X 58 | 2 | 125 A | 690 V | Pressure Plate |
| CYH22583 | 22 X 58 | 3 | 125 A | 690 V | Pressure Plate |

* Indicating
NOTE: All fuse holders are DIN-Rail mountable. Contact factory for dimensional information.

Web Resources

For the latest international fuse products, visit:
www.littelfuse.com/cy

Section Overview

Miscellaneous Accessories include custom-built solutions designed specifically to meet code requirements, fuse reducers, box cover units and an assortment of useful fuse and holder accessories.

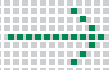

MISCELLANEOUS ACCESSORIES

Table of Contents

| | |
|---|-----|
| Fuse Reducers | 185 |
| Box Cover Units | 186 |
| Electronic Fuse Display & Spare Fuse Cabinet..... | 187 |

FUSE REDUCERS



Description

Littelfuse® fuse reducers allow smaller size fuses to be installed into existing fuse clips to prevent overfusing.

Features/Benefits

- Simple installation
- Reduces inventory requirements
- Silver brazed joints for maximum strength
- UL Listed (File No. E136855)
- CSA Certified (File No. LR92899)

Web Resources

Downloadable CAD drawings, FAQs, and other technical information visit: www.littelfuse.com/lruh
www.littelfuse.com/lrur
www.littelfuse.com/lruj

Refer to fuse section of this catalog for fuse dimensions.

Ordering Information

250 Volt

| CATALOG/ORDERING NUMBER | | FUSE CLIP | FUSE CASE SIZE |
|-------------------------|-------------|-----------|----------------|
| CLASS H/K5 | CLASS R | | |
| LRU 263 | LRU 263 R | 60 A | 30 A |
| LRU 213 | LRU 213 R | 100 A | 30 A |
| LRU 216 | LRU 216 R | 100 A | 60 A |
| LRU 226 | LRU 226 R | 200 A | 60 A |
| LRU 2621 | LRU 2621 R | 200 A | 100 A |
| LRU 2641 | LRU 2641 R | 400 A | 100 A |
| LRU 2642 | LRU 2642 R | 400 A | 200 A |
| LRU 2661 | LRU 2661 R | 600 A | 100 A |
| LRU 2662 | LRU 2662 R | 600 A | 200 A |
| LRU 2664 | LRU 2664 R* | 600 A | 400 A |

*Only one reducer required.

600 Volt

| CATALOG / ORDERING NUMBER | | | FUSE CLIP | FUSE CASE SIZE |
|---------------------------|-------------|---------|-----------|----------------|
| CLASS H/K5 | CLASS R | CLASS J | | |
| LRU 663 | LRU 663 R | LRUJ63 | 60 A | 30 A |
| LRU 216 | LRU 216 R | LRUJ13 | 100 A | 30 A |
| LRU 616 | LRU 616 R | LRUJ16† | 100 A | 60 A |
| LRU 626 | LRU 626 R | LRUJ26 | 200 A | 60 A |
| LRU 2621 | LRU 2621 R | LRUJ21 | 200 A | 100 A |
| LRU 2641 | LRU 2641 R | LRUJ41 | 400 A | 100 A |
| LRU 2642 | LRU 2642 R | LRUJ42 | 400 A | 200 A |
| LRU 2661 | LRU 2661 R | — | 600 A | 100 A |
| LRU 2662 | LRU 2662 R | — | 600 A | 200 A |
| LRU 2664 | LRU 2664 R† | LRUJ64 | 600 A | 400 A |

†Only one reducer required.

‡Fuse and reducer combination is slightly larger in diameter than 100 A Class J fuses. For specific applications, contact factory.
 Class J reducers cannot be used in bolt-on applications.

Recommended Fuses

Class H/K5 Fuse Reducers

| | |
|-----------------|----|
| NLN / NLS | 21 |
| RLN / RLS | 22 |

Class R Fuse Reducers

| | |
|-------------------------|----|
| FLNR / FLNR_ID | 18 |
| FLNR_ID / FLNR_ID | 18 |
| IDSR | 17 |
| LLNRK / LLSRK | 14 |
| LLSRK_ID | 14 |
| KLNR / KLSR | 15 |

Class J Fuse Reducers

| | |
|--------------------|----|
| JTD_ID / JTD | 23 |
| JLS | 24 |

BOX COVER UNITS



Description

Provide economical method of protecting small motors against overcurrent damage.

Applications

- Edison-Base plug fuses (TOO, TLO)
- Type S plug fuses (SOO, SLO) with adapters (SAO)

Specifications

Voltage Rating 125 V
Max Ampere Rating 15 A
Approvals UL Listed parts

Web Resources

Sample requests, downloadable CAD drawings and other technical information: www.littelfuse.com/boxcover

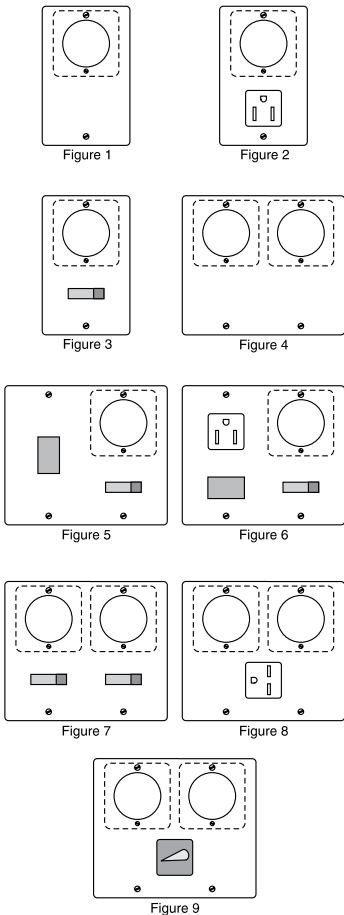

| FIGURE NUMBER | LITTELFUSE PART NUMBER | BOX COVER FEATURES | | | | | TO BE MOUNTED ON |
|---------------|------------------------|-------------------------|----------------------|--------------------|-----------------|-------------|--------------------|
| | | EDISON BASE FUSE HOLDER | GROUNDING RECEPTACLE | SINGLE POLE SWITCH | TWO POLE SWITCH | PILOT LIGHT | |
| 1 | LSOU | 1 | — | — | — | — | 2-1/4" Handy Box |
| | LSOW | 1 | — | — | — | — | 2-3/4" Switch Box |
| | LSOX | 1 | — | — | — | — | 4" Octagon Box |
| | LSOY | 1 | — | — | — | — | 4" Square Box |
| 2 | LSRU* | 1 | 1 | — | — | — | 2-1/4" Handy Box |
| | LSRW | 1 | 1 | — | — | — | 2-3/4" Switch Box |
| | LSRX | 1 | 1 | — | — | — | 4" Octagon Box |
| | LSRY | 1 | 1 | — | — | — | 4" Square Box |
| 3 | LSSU* | 1 | — | 1 | — | — | 2-1/4" Handy Box |
| | LSSW | 1 | — | 1 | — | — | 2-3/4" Switch Box |
| | LSSX | 1 | — | 1 | — | — | 4" Octagon Box |
| | LSSY* | 1 | — | 1 | — | — | 4" Square Box |
| 4 | LSOY-B | 2 | — | — | — | — | 4" Square Box |
| 5 | LSSY-L | 1 | — | 1 | — | 1 | 4" Square Box |
| 6 | LSSY-RL | 1 | 1 | 1 | — | 1 | 4" Square Box |
| 7 | LSCY | 2 | — | 2 | — | — | 4" Square Box |
| 8 | LSKA | 2 | 1 (250V) | — | — | — | 4-1/16" Square Box |
| 9 | LSTY | 2 | — | — | 1 | — | 4" Square Box |

*UL Listed (File No. E308725)

FUSE DISPLAYS AND CABINETS

Electronic Fuse Display



Description

This wall-mountable or free-standing modular rack system prominently displays Littelfuse glass and automotive fuses. Additional sections can be quickly snapped on for a larger product selection. Each rack features a cross reference guide to help customers locate the proper replacement fuse.

Features/Benefits

- Holds 720 (144 5-packs) of the most popular glass, ceramic, and automotive fuses
- Designed to save space—measures 14" H x 9" W x 4" D. Suitable for wall or counter mounting
- Includes cross reference, product identification guide, and back-up card for easy reordering
- Expandable with modular section that can hold 240 fuses (48 5-packs) per section

Fully stocked rack includes the following parts

| 3AG (GLASS) FAST ACTING FUSES | | 3AG (GLASS) SLO-BLO® FUSES | |
|----------------------------------|----------------|-------------------------------|----------------|
| QUANTITY | CATALOG NUMBER | QUANTITY | CATALOG NUMBER |
| 25 | 312 1/2A | 25 | 313 1/2A |
| 50 | 312 1A | 25 | 313 3/4A |
| 25 | 312 1 1/2A | 25 | 313 1A |
| 75 | 312 2A | 25 | 313 1 1/2A |
| 25 | 312 2 1/2A | 50 | 313 2A |
| 75 | 312 3A | 25 | 313 2 1/2A |
| 25 | 312 4A | 25 | 313 3A |
| 25 | 312 5A | 25 | 313 4A |
| 25 | 312 10A | 25 | 313 5A |

| 3AB (CERAMIC) NORMAL-BLO FUSES | | 3AB (CERAMIC) SLO-BLO® FUSES | |
|-----------------------------------|----------------|---------------------------------|----------------|
| QUANTITY | CATALOG NUMBER | QUANTITY | CATALOG NUMBER |
| 25 | 314 15A | 25 | 326 8A |
| 25 | 314 20A | 20 | 326 10A |
| 25 | 314 30A | | |

Ordering Information

| TYPE | CATALOG NUMBER | ORDERING NUMBER |
|-----------------------|----------------|-----------------|
| Fully Stocked Display | 094324PG | 00940324ZXP |
| Empty Display Rack | FDR001PG | 0FDR0001ZXP |
| Additional Sections | MRS001PG | 0MRS0001ZXP |

Spare Fuse Cabinet



Description

- Steel cabinet with piano hinges that can be locked to prevent unauthorized access. Weather stripped to reduce the accumulation of dust, dirt and moisture
- Convenient inventory card located inside door. Measures 30" H x 24" W x 12" D. Keyhole mounting holes 16" on center for easy installation

Ordering Information

| TYPE | CATALOG NUMBER | ORDERING NUMBER |
|--------------------|----------------|-----------------|
| Spare Fuse Cabinet | LSFC | LSFC |
| Spare Keys | LKEY001 | LKEY0001Z |

Web Resources

Sample requests and data sheets www.littelfuse.com/lisfc

Section Overview

This Technical Application Guide or 'Fuseology' section provides the information needed to select the correct types of Littelfuse POWR-GARD® fuses for most applications. If there are any questions or if additional data is needed for a specific use, call the Littelfuse Technical Support and Engineering Service Group at 1-800-TEC-FUSE (1-800-832-3873) or visit us online at www.littelfuse.com.



TECHNICAL APPLICATION GUIDE

Table of Contents

| | |
|--|-----|
| Fuseology Fundamentals..... | 189 |
| Selection Considerations..... | 191 |
| Time-current Curves and Peak Let-through Charts..... | 195 |
| Selective Coordination..... | 198 |
| UL/CSA Fuse Classes and Applications..... | 200 |
| Electrical Safety Guide..... | 202 |
| Terms and Definitions..... | 204 |
| Motor Protection Tables..... | 211 |
| Alphanumeric Index of Catalog Numbers..... | 214 |
| Condensed Fuse Cross Reference..... | 216 |

Additional Technical Information



An expanded Technical Application Guide and Fuseology section, white papers, and a library of technical information is available online at

www.littelfuse.com/technicalcenter

FUSEOLOGY FUNDAMENTALS

I. OVERCURRENT PROTECTION FUNDAMENTALS (FUSES AND HOW THEY WORK)

Introduction

An important part of developing quality overcurrent protection is an understanding of system needs and overcurrent protective device fundamentals. This section discusses these topics with special attention to the application of fuses. If you have additional questions, call our Technical Support Group at 1-800-TEC-FUSE (1-800-832-3873). Definitions of terms used in this section are located towards the end of this Technical Application Guide.

Why Overcurrent Protection?

All electrical systems eventually experience overcurrents. Unless removed in time, even moderate overcurrents quickly overheat system components, damaging insulation, conductors, and equipment. Large overcurrents may melt conductors and vaporize insulation. Very high currents produce magnetic forces that bend and twist bus bars. These high currents can pull cables from their terminals and crack insulators and spacers.

Too frequently, fires, explosions, poisonous fumes and panic accompany uncontrolled overcurrents. This not only damages electrical systems and equipment, but may cause injury or death to personnel nearby.

To reduce these hazards, the National Electrical Code® (NEC®), OSHA regulations, and other applicable design and installation standards require overcurrent protection that will disconnect overloaded or faulted equipment.

Industry and governmental organizations have developed performance standards for overcurrent devices and testing procedures that show compliance with the standards and with the NEC. These organizations include: the American National Standards Institute (ANSI), National Electrical Manufacturers Association (NEMA), and the National Fire Protection Association (NFPA), all of which work in conjunction with Nationally Recognized Testing Laboratories (NRTL) such as Underwriters Laboratories (UL).

Electrical systems must meet applicable code requirements including those for overcurrent protection before electric utilities are allowed to provide electric power to a facility.

What is Quality Overcurrent Protection?

A system with quality overcurrent protection has the following characteristics:

1. Meets all legal requirements, such as NEC, OSHA, local codes, etc.
2. Provides maximum safety for personnel, exceeding minimum code requirements as necessary.

3. Minimizes overcurrent damage to property, equipment, and electrical systems.
4. Provides coordinated protection. Only the protective device immediately on the line side of an overcurrent opens to protect the system and minimize unnecessary downtime.
5. Is cost effective while providing reserve interrupting capacity for future growth.
6. Consists of equipment and components not subject to obsolescence and requiring only minimum maintenance that can be performed by regular maintenance personnel using readily available tools and equipment.

Overcurrent Types and Effects

An overcurrent is any current that exceeds the ampere rating of conductors, equipment, or devices under conditions of use. The term "overcurrent" includes both overloads and short-circuits.

Overloads

An overload is an overcurrent confined to normal current paths in which there is no insulation breakdown.

Sustained overloads are commonly caused by installing excessive equipment such as additional lighting fixtures or too many motors. Sustained overloads are also caused by overloading mechanical equipment and by equipment breakdown such as failed bearings. If not disconnected within established time limits, sustained overloads eventually overheat circuit components causing thermal damage to insulation and other system components.

Overcurrent protective devices must disconnect circuits and equipment experiencing continuous or sustained overloads before overheating occurs. Even moderate insulation overheating can seriously reduce the life of the components and/or equipment involved. For example, motors overloaded by just 15% may experience less than 50% of normal insulation life.

Temporary overloads occur frequently. Common causes include temporary equipment overloads such as a machine tool taking too deep of a cut, or simply the starting of an inductive load such as a motor. Since temporary overloads are by definition harmless, overcurrent protective devices should not open or clear the circuit.

It is important to realize that fuses selected must have sufficient time-delay to allow motors to start and temporary overloads to subside. However, should the overcurrent continue, fuses must then open before system components are damaged. Littelfuse POWR-PRO® and POWR-GARD® time-delay fuses are designed to meet these types of protective needs. In general, time-delay fuses hold 500% of the rated current for a minimum of ten seconds, yet will still open quickly on higher values of current.

FUSEOLOGY FUNDAMENTALS

Even though government-mandated high-efficiency motors and NEMA Design E motors have much higher locked rotor currents, POWR-PRO® time-delay fuses such as the FLSR_ID, LLSRK_ID, or IDSR series have sufficient time-delay to permit motors to start when the fuses are properly selected in accordance with the NEC®.

Short-Circuits

A short-circuit is an overcurrent flowing outside of its normal path. Types of short-circuits are generally divided into three categories: bolted faults, arcing faults, and ground faults. Each type of short-circuit is defined in the Terms and Definitions section.

A short-circuit is caused by an insulation breakdown or faulty connection. During a circuit's normal operation, the connected load determines current. When a short-circuit occurs, the current bypasses the normal load and takes a "shorter path," hence the term 'short-circuit'. Since there is no load impedance, the only factor limiting current flow is the total distribution system's impedance from the utility's generators to the point of fault.

A typical electrical system might have a normal load impedance of 10 ohms. But in a single-phase situation, the same system might have a load impedance of 0.005 ohms or less. In order to compare the two scenarios, it is best to apply Ohm's Law ($I = E/R$ for AC systems). A 480 volt single-phase circuit with the 10 ohm load impedance would draw 48 amperes ($480/10 = 48$). If the same circuit has a 0.005 ohm system impedance when the load is shorted, the available fault current would increase significantly to 96,000 amperes ($480/0.005 = 96,000$).

As stated, short-circuits are currents that flow outside of their normal path. Regardless of the magnitude of overcurrent, the excessive current must be removed quickly. If not removed promptly, the large currents associated with short-circuits may have three profound effects on an electrical system: heating, magnetic stress, and arcing.

Heating occurs in every part of an electrical system when current passes through the system. When overcurrents are large enough, heating is practically instantaneous. The energy in such overcurrents is measured in ampere-squared seconds (I^2t). An overcurrent of 10,000 amperes that lasts for 0.01 seconds has an I^2t of 1,000,000 A^2s . If the current could be reduced from 10,000 amperes to 1,000 amperes for the same period of time, the corresponding I^2t would be reduced to 10,000 A^2s , or just one percent of the original value.

If the current in a conductor increases 10 times, the I^2t increases 100 times. A current of only 7,500 amperes can melt a #8 AWG copper wire in 0.1 second. Within eight milliseconds (0.008 seconds or one-half cycle), a current of 6,500 amperes can raise the temperature of #12 AWG THHN thermoplastic insulated copper wire from its operating temperature of 75°C to its maximum short-circuit

temperature of 150°C. Any currents larger than this may immediately vaporize organic insulations. Arcs at the point of fault or from mechanical switching such as automatic transfer switches or circuit breakers may ignite the vapors causing violent explosions and electrical flash.

Magnetic stress (or force) is a function of the peak current squared. Fault currents of 100,000 amperes can exert forces of more than 7,000 lb. per foot of bus bar. Stresses of this magnitude may damage insulation, pull conductors from terminals, and stress equipment terminals sufficiently such that significant damage occurs.

Arcing at the point of fault melts and vaporizes all of the conductors and components involved in the fault. The arcs often burn through raceways and equipment enclosures, showering the area with molten metal that quickly starts fires and/or injures any personnel in the area. Additional short-circuits are often created when vaporized material is deposited on insulators and other surfaces. Sustained arcing-faults vaporize organic insulation, and the vapors may explode or burn.

Whether the effects are heating, magnetic stress, and/or arcing, the potential damage to electrical systems can be significant as a result of short-circuits occurring.

II. SELECTION CONSIDERATIONS

Selection Considerations for Fuses (600 volts and below)

Since overcurrent protection is crucial to reliable electrical system operation and safety, overcurrent device selection and application should be carefully considered. When selecting fuses, the following parameters or considerations need to be evaluated:

- Current Rating
- Voltage Rating
- Interrupting Rating
- Type of Protection and Fuse Characteristics
- Current Limitation
- Physical Size
- Indication

Current Rating

The current rating of a fuse is the AC or DC current, expressed in amperes, which the fuse is capable of carrying continuously under specified conditions. Fuses selected for a circuit must have ampere ratings that meet NEC requirements, namely those found in NEC Articles 240 and 430. These NEC requirements establish maximum ratings and in some cases, minimum ratings. When selecting a fuse, it is generally recommended to select a current rating as close as possible to the system's normal running current.

SELECTION CONSIDERATIONS

Voltage Rating

The voltage rating of a fuse is the maximum AC or DC voltage at which the fuse is designed to operate. Fuse voltage ratings must equal or exceed the circuit voltage where the fuses will be installed, and fuses used in DC circuits must be specifically rated for DC applications. In terms of voltage, fuses may be rated for AC only, DC only, or both AC and DC. However, exceeding the voltage ratings or using an AC only fuse in a DC circuit could result in violent destruction of the fuse.

The standard 600 volt rated fuses discussed in this section may be applied at any voltage less than or equal to their rating. For example, a 600 volt fuse may be used in a 277 volt or even a 32 volt system, but not any system exceeding 600 volts.

NOTE: This does not apply to semiconductor fuses and medium voltage fuses. See the semiconductor and medium voltage fuse application information on www.littelfuse.com for voltage limitations of these fuses.

Interrupting Rating

The interrupting rating of a fuse is the highest available symmetrical rms alternating current that the fuse is required to safely interrupt at its rated voltage under standardized test conditions. A fuse must interrupt all overcurrents up to its interrupting rating without experiencing damage. Standard UL fuses are available with interrupting ratings of 10,000 A, 50,000 A, 100,000 A, 200,000 A, and 300,000 A.

NEC® Article 110.9 requires that all equipment intended to break current at fault levels have an interrupting rating sufficient for the system voltage and current available at the equipment's line terminals. Refer to *Figure 1*. It is vitally important to select fuses with interrupting ratings which equal or exceed the available fault current.

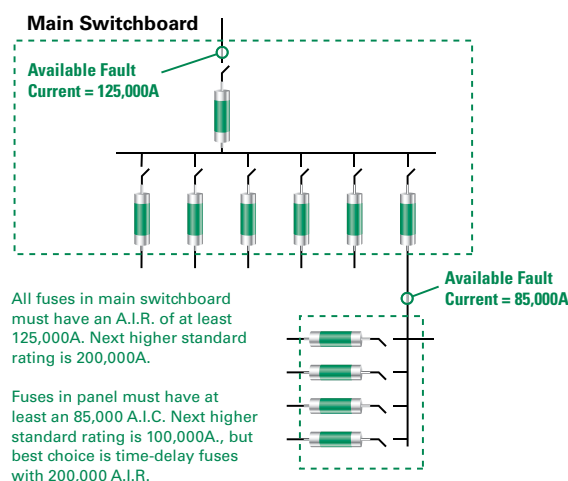

Figure 1 – Interrupting Rating Requirements per NEC

The recommendation to standardize on fuses with at least a 200,000 ampere interrupting rating (AIR) ensures that all fuses have an adequate interrupting rating while providing reserve interrupting capacity for future increases in available fault current.

300,000 AIR Fuses

Littelfuse POWR-PRO® fuse series have a Littelfuse Self-Certified interrupting rating of 300,000 amperes rms symmetrical. The 300,000 ampere testing was performed in a Nationally Recognized Testing Laboratory, and the tests were UL witnessed. UL has ruled that fuses with a UL interrupting rating greater than 200,000 amperes must be marked as “Special Purpose Fuses” and may not be labeled as UL Listed Class RK5, RK1, L, etc.

Type of Protection and Fuse Characteristics

Time current characteristics determine how fast a fuse responds to overcurrents. All fuses have inverse time characteristics; that is, the fuse opening time decreases as the magnitude of overcurrent increases. When properly rated in accordance with NEC requirements, fuses provide both overload and short-circuit protection to system conductors and components. However, in some instances such as when fuses are used to backup circuit breakers or to provide motor branch circuit short-circuit and ground fault protection, fuses provide only short-circuit protection. A fuse's response to overcurrents is divided into short-circuits and overloads.

Short-Circuits

A fuse's short-circuit response is its opening time on higher-value currents. For power fuses, higher-value currents are generally over 500-600% of the fuse's current rating. As stated earlier, all fuses have inverse time characteristics: the higher the current, the faster the opening time. Since short-circuits should be removed quickly, inverse time is especially important for short-circuit protection.

Overloads

While fuses must disconnect overloaded conductors and equipment before the conductors and components are seriously overheated, they should not disconnect harmless temporary overloads. To provide sufficient overload protection for system conductors, UL has established maximum fuse opening times at 135% and 200% of a fuse's current rating. All UL Listed fuses for application in accordance with the National Electrical Code® must meet these limits whether they are fast-acting or time-delay fuses.

As just stated, a fuse is designed to respond to two types of overcurrents – short circuits and overloads. As a result, selecting the proper fuse for a given application usually involves deciding whether to use a time-delay fuse or a fast-acting fuse. A more in-depth review of both possible scenarios is important at this time.

SELECTION CONSIDERATIONS

Fast-Acting (Normal-Opening) Fuses

Fast-acting fuses (sometimes called “Normal-opening” fuses) have no intentional time-delay. Typical opening times at 500% of the fuse ampere rating range from 0.05 second to approximately 2 seconds. Fast-Acting fuses are suitable for non-inductive loads such as incandescent lighting and general-purpose feeders, or branch circuits with little or no motor load. When protecting motors and other inductive loads, fast-acting fuses must be rated at 200-300% of load currents to prevent nuisance opening on in-rush currents. Fuses with such increased ratings no longer furnish adequate protection from overloads and only provide short-circuit protection. Overload relays or other overload protection devices must be provided to properly protect conductors and equipment from overload conditions.

All fast-acting fuses provide fast short-circuit response within their interrupting rating. Some are considered current-limiting, such as UL Class T and Class J. Others are non-current-limiting, such as UL Class H.

Time-Delay (SLO-BLO®) Fuses

Most UL Class CC, CD, G, J, L, RK5 and RK1 fuses, plus some of the UL Listed Miscellaneous fuses are considered time-delay. If so, they are identified as such on the fuse label with the words “Time-Delay,” “TD,” “D,” or some other suitable marking. Minimum time-delay varies with the fuse class, and to some degree with the fuse ampere rating. UL standards for POWR-GARD® fuse series FLNR, FLNR_ID, FLSR, FLSR_ID, IDSR (UL Class RK5), LLNRK, LLSRK, LLSRK_ID (UL Class RK1), and JTD, JTD_ID (UL Class J) require these fuses to carry 500% rated current for a minimum of 10 seconds. Standards for CCMR and KLDR (UL Class CC and CD) and SLC (UL Class G) fuses require them to carry 200% rated current for a minimum of 12 seconds.

Although there is no UL Classification for time-delay Class L fuses, it is still permissible for them to be marked “Time-Delay.” The amount of time-delay is determined by the manufacturer. Littelfuse KLPC series and KLLU series fuses will hold 500% current for 10 seconds or more.

In addition to providing time-delay for surges and short time overloads, time-delay fuses meet all UL requirements for sustained overload protection. On higher values of current, time-delay fuses are current-limiting; meaning they remove large overcurrents in less than one-half cycle (0.00833 seconds). Time-delay fuses provide the best overall protection for both motor and general purpose circuits, and eliminate nuisance fuse opening and most situations of downtime.

Compared to fast-acting fuses, time-delay fuses can be selected with ratings much closer to a circuit’s operating current. For example, on most motor circuits Class RK5 and RK1 fuses can be rated at 125-150% of a motor’s full load current (FLA). This provides superior overload and short-

circuit protection, and often permits the use of smaller, less expensive disconnect switches. Time-delay fuses have gradually replaced most one-time (UL Class K5) and renewable (UL Class H) fuses. Today, more than 50% of all fuses sold by electrical distributors are time-delay fuses.

Dual Element Fuses

Littelfuse time-delay FLNR, FLNR_ID, FLSR, FLSR_ID, IDSR (UL Class RK5), and LLNRK, LLSRK, LLSRK_ID (UL Class RK1), and some JTD, JTD_ID (UL Class J) series fuses have true dual-element construction meaning the fuse has an internal construction consisting of separate short-circuit and overload sections or elements. Time-delay elements are used for overload protection, and separate fast acting fuse elements or links are used to provide current-limiting short-circuit protection.

Very Fast-Acting Fuses

This category of fuses exists for limited applications. The principle use of very fast acting fuses is to protect solid-state electronic components, such as semiconductors. Fuse series designated as ‘Semiconductor Fuses’ have special characteristics including quick overload response, very low I^2t and I_{peak} currents, and peak transient voltages, that provide protection for components that cannot withstand line surges, low value overloads, or short-circuit currents. Very fast-acting fuses are designed for very fast response to overloads and short-circuits, and are very current-limiting.

Effect of Ambient Temperature on Fuses

The current carrying capacity of fuses is 110% of the fuse rating when installed in a standard UL test circuit and tested in open air at 25°C ambient. This allows for derating to 100% of rating in an enclosure at 40°C ambient.

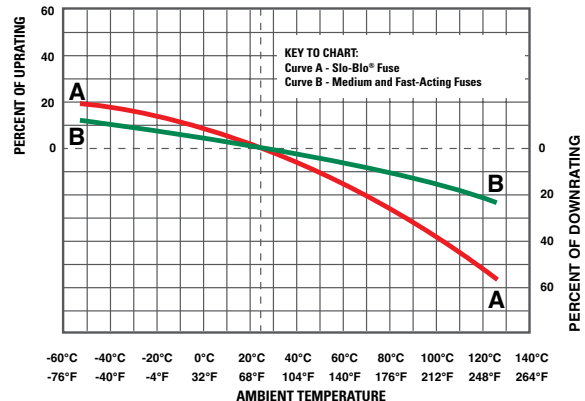

Figure 2 – Fuse Rerating Curve

SELECTION CONSIDERATIONS

Current Limitation

A current-limiting fuse is one that opens and clears a fault in less than 180 electrical degrees, or in other words, within the first half electrical cycle (0.00833 seconds). See the definition of Current-limiting Fuse and *Figure 13* in the Terms and Definitions section.

NEC® Article 240.2 states that a current-limiting overcurrent protective device must reduce the peak let-through current to a value substantially less than the potential peak current that would have occurred if the fuse were not used in the circuit or were replaced with solid conductors of the same impedance. The total destructive heat energy (I^2t) to the circuit and its components is greatly minimized as a result of using current-limiting fuses.

It is important to note that UL Class H 'Renewable' fuses designed decades ago are considered non-current limiting. Other than Midget fuses, almost all other fuse types used in today's electrical systems and applications are considered current-limiting per the above parameters. This selection consideration now involves determining the degree or level of current limitation required to properly protect a given device or system.

It is also important to point out that matching fuse holders and/or fuse blocks must reject non-current-limiting fuses and accept only current-limiting fuses of the stated UL Class.

Physical Size

While often overlooked, the physical size or overall dimensions of the fuse to be used in a given application is another important selection consideration to evaluate. There is a trend toward reduction of size in almost everything, and electrical equipment is no exception. Fuse size is actually determined by the size and dimensions of the fuse block or disconnect switch in which it is installed.

While saving space may be an important factor when selecting the proper fuses, other considerations should not be overlooked. Some of these include:

- Does the smallest fuse have the most desirable characteristics for the application?
- Does the equipment in which the fuse will be installed provide adequate space for maintenance?
- Do smaller fuses coordinate well with the system's other overcurrent protection?

If looking at just physical dimensions, a 600 volt, 60 ampere, 200,000 AIR, time-delay, dual-element UL Class CD fuse is smaller than a similarly rated UL Class J fuse, which is in turn, considerably smaller than a similarly rated UL Class RK1 or Class RK5 fuse. However, smaller-sized fuses can sometimes have less time-delay or more nuisance openings than their larger counterparts, so it is always important to consider all factors involved.

Indication

The newest consideration for selecting the best fuse for a given application is indication. Many of the more commonly used UL fuse classes are now available in both indicating and non-indicating versions. Built-in, blown-fuse indication that quickly identifies which fuse or fuses within an electrical panel or system have blown can be found on the Littelfuse POWR-PRO® LLSRK_ID Class RK1, FLNR_ID, FLSR_ID and IDSR Class RK5, and JTD_ID Class J fuse series.

The indicating feature on these fuses provides reduced downtime, increased safety, and reduced housekeeping or troubleshooting headaches and delays. Littelfuse Indicator® fuses will help lower the costs associated with downtime, provide longer fuse life by minimizing nuisance openings, increase system performance by minimizing equipment damage, and improve safety by minimizing accidents.

III. GENERAL FUSING RECOMMENDATIONS

Based on the above selection considerations, the following is recommended:

Fuses with ampere ratings from 1/10 through 600 amperes

- When available fault currents are less than 100,000 amperes and when equipment does not require the more current-limiting characteristics of UL Class RK1 fuses, FLNR and FLSR_ID Series Class RK5 current-limiting fuses provide superior time-delay and cycling characteristics at a lower cost than RK1 fuses. If available fault currents exceed 100,000 amperes, equipment may need the additional current-limitation capabilities of the LLNRK, LLSRK and LLSRK_ID series Class RK1 fuses.
- Fast-acting JLLN and JLLS series Class T fuses possess space-saving features that make them especially suitable for protection of molded case circuit breakers, meter banks, and similar limited-space applications.
- Time-delay JTD_ID and JTD series Class J fuses are used in OEM motor control center applications as well as other MRO motor and transformer applications requiring space-saving IEC Type 2 protection.
- Class CC and Class CD series fuses are used in control circuits and control panels where space is at a premium. The Littelfuse POWR-PRO CCMR series fuses are best used for protection of small motors, while the Littelfuse KLDR series fuses provide optimal protection for control power transformers and similar devices.

For questions about product applications, call our Technical Support Group at 800-TEC-FUSE.

SELECTION CONSIDERATIONS

Fuses with ampere ratings from 601 through 6,000 amperes

For superior protection of most general-purpose and motor circuits, it is recommended to use the POWR-PRO® KLPC series Class L fuses. The Class L fuses are the only time-delay fuse series available in these higher ampere ratings.

Information on all the Littelfuse fuse series referenced above can be found on the UL/CSA Fuse Classes and Applications Charts found later in this Technical Application Guide.

IV. SELECTION CONSIDERATIONS FOR FUSE HOLDERS

Equally important to the selection of the proper fuse is the correct selection of the proper fuse holder or fuse block for a given application. Fuse holders are available using most of the same Selection Considerations outlined above for UL fuse classes. Considerations for fuse holders include:

- Current Rating
- Voltage Rating
- Interrupting Rating
- Physical Size
- Indication

Additional selection considerations for fuse holders and fuse blocks include:

- Number of poles
- Mounting configuration
- Connector type

Number of Poles

The number of poles for each set of fuses is determined by the characteristics of the circuit. Most fuse block series are available in 1, 2, or 3 pole configurations, although some are also available with four or more poles. The option to gang individual fuse blocks into longer strips will be determined by the available space and type of wire being used.

Mounting Configuration

Depending on the fuse block design, another selection consideration to evaluate is how the fuse block is mounted or inserted into the panel. Historically, fuse blocks simply screwed into the back of the panel, but many newer designs have now added (or replaced the screw-in design with) a DIN rail mounting capability. The DIN rail mounting feature allows the blocks to be quickly installed and removed from the rails.

Connector Type

For Littelfuse fuse blocks, a choice of three connector types or wire terminations is available:

- Screw – for use with spade lugs or ring terminals.
- Screw with Pressure Plate – for use with solid or stranded wire without terminal and recommended for applications where vibration will be a factor.
- Box Lug – the most durable of the three options and used with all types of solid wire and Class B and Class C stranded wire.

There are a few additional aspects to keep in mind when selecting the fuse holder or fuse block needed for a given application. UL Class H blocks accept Class H, Class K5, and Class R fuses. Similarly, Midget-style fuse blocks accept both Midget and UL Class CC fuses.

Both UL Class R and Class CC fuse holders contain a rejection feature which prevents the insertion of a different Class or type of fuse. The physical size and dimensions of UL Class J and Class T fuses accomplish the same thing in preventing the insertion of a different Class of fuse as well.

V. CIRCUIT PROTECTION CHECKLIST

To select the proper overcurrent protective device for an electrical system, circuit and system designers should ask themselves the following questions before a system is designed:

- What is the normal or average current expected?
- What is the maximum continuous (three hours or more) current expected?
- What inrush or temporary surge currents can be expected?
- Are the overcurrent protective devices able to distinguish between expected inrush and surge currents, and open under sustained overloads and fault conditions?
- What kind of environmental extremes are possible? Dust, humidity, temperature extremes and other factors need to be considered.
- What is the maximum available fault current the protective device may have to interrupt?
- Is the overcurrent protective device rated for the system voltage?
- Will the overcurrent protective device provide the safest and most reliable protection for the specific equipment?
- Under short-circuit conditions, will the overcurrent protective device minimize the possibility of a fire or explosion?
- Does the overcurrent protective device meet all the applicable safety standards and installation requirements?

Answers to these questions and other criteria will help to determine the type overcurrent protection device to use for optimum safety, reliability and performance.

FUSE CHARACTERISTIC CURVES AND CHARTS

The performance capabilities of various fuses are graphically represented by two different types of fuse characteristic curves: time-current curves and peak let-through charts. These curves and charts define the operating characteristics of a given fuse, and assist system designers and engineers in selecting the proper fuse to protect equipment and electrical systems.

Understanding Time-current Curves

Time-current curves provide a graphical representation or plot of a fuse’s average melting (opening) time at any current. Time-current curves for Littelfuse POWR-GARD® fuses can be found online at www.littelfuse.com/technicalcenter.

In order to make the curves more readable, the performance information is presented on log-log paper. The overcurrent values appear across the bottom and increase in magnitude from left to right. Average melting times appear on the left-hand side of the curve and increase in magnitude from bottom to top. The ampere ratings of the individual fuses for a given series are listed at the top and increase in rating from left to right. *Figure 4* shows the average melting time curves for a typical time-delay fuse series.

As discussed earlier in the Fuseology Fundamentals section, time-delay, fast-acting, and very fast-acting fuses all respond differently based on the overcurrents occurring in the systems each is protecting. To illustrate the basic differences between each type of fuse, *Figure 5* compares the average melting times for 100 and 600 amp ratings

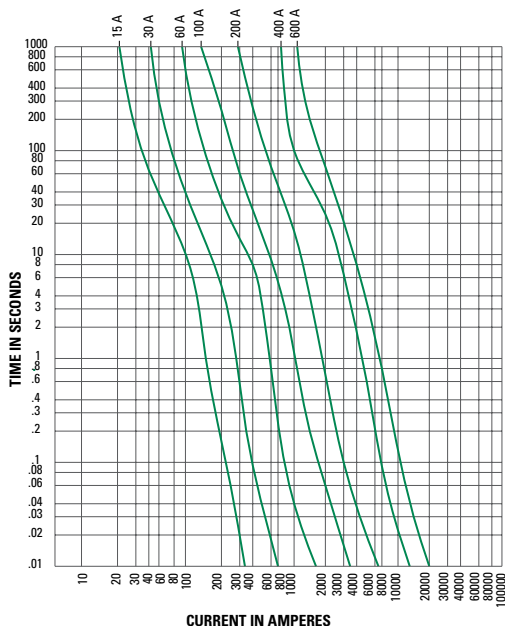

Figure 4 – Average Melting Time Curves for Typical Time-Delay Fuse Series

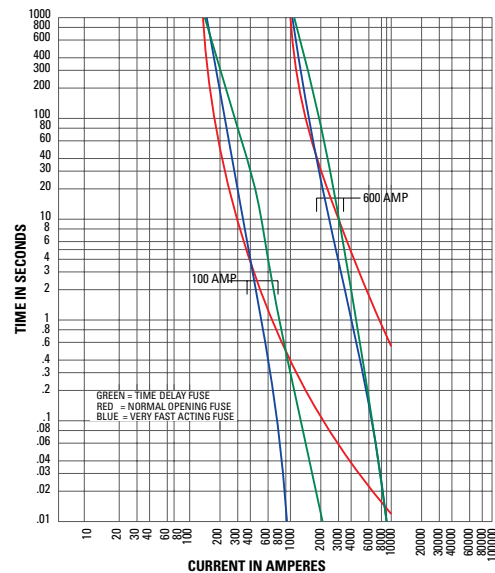

Figure 5 – Comparison of Average Melting Times for Three Fuse Types

of three fuse types: Littelfuse dual-element, time-delay LLSRK series class RK1 fuses; Littelfuse normal opening NLS series class K5 fuses; and Littelfuse very fast acting L60S series semiconductor fuses.

To better illustrate this point, *Table 3* also compares the opening times for each of these fuses.

| AMPERE RATING | FUSE TYPE | OPENING TIME IN SECONDS | | |
|---------------|------------------|-------------------------|-------------|--------------|
| | | 500% RATING | 800% RATING | 1200% RATING |
| 100 | TIME-DELAY | 12 secs. | 0.9 secs. | 0.14 secs. |
| | NORMAL OPENING | 2 secs. | 0.7 secs. | 0.3 secs. |
| | VERY FAST-ACTING | 1.3 secs. | 0.02 secs. | >0.01 secs. |
| 600 | TIME-DELAY | 14 secs. | 0.7 secs. | 0.045 secs. |
| | NORMAL OPENING | 10 secs. | 3 secs. | 1.1 secs. |
| | VERY FAST-ACTING | 2 secs. | 0.05 secs. | >0.01 secs. |

Table 3 – Comparative Opening Times for Time-Delay, Fast-Acting, and Very Fast-Acting Fuses

Peak Let-through Charts

Peak let-through charts illustrate the maximum instantaneous current through the fuse during the total clearing time. This represents the current limiting ability of a fuse.

Fuses that are current-limiting open severe short-circuits within the first half-cycle (180 electrical degrees or 0.00833 seconds) after the fault occurs. Current-limiting fuses also reduce the peak current of the available fault current to a value less than would occur without the fuse. This reduction is shown in *Figure 6*.

A fuse’s current-limiting effects are shown graphically on Peak Let-through charts such as the one shown in *Figure 7*. The values across the chart’s bottom represent the available

FUSE CHARACTERISTIC CURVES AND CHARTS

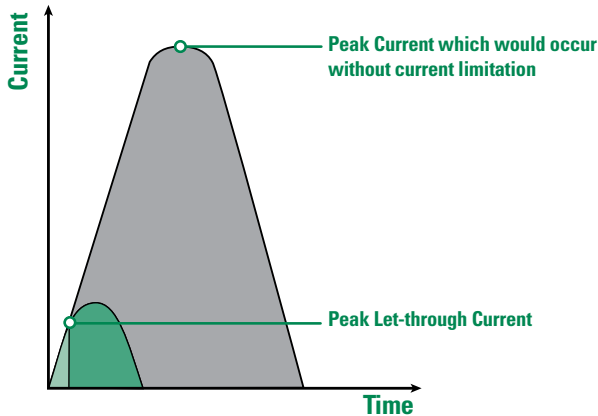

Figure 6 – Current limiting effect of fuses

(also referred to as potential or prospective) rms symmetrical fault current. The values on the chart's left side represent the instantaneous available peak current and the peak let-through current for various fuse ratings.

To better explain the function of these charts, let's run through an example. Start by entering the chart on the bottom at 100,000 rms symmetrical amperes and read upwards to the A-B line. From this point, read horizontally to the left and read the instantaneous peak let-thru current of 230,000 amperes. In a circuit with a typical 15% short-circuit power factor, the instantaneous peak of the available current is approximately 2.3 times the rms symmetrical value. This occurs since the A-B line on the chart has a 2.3:1 slope.

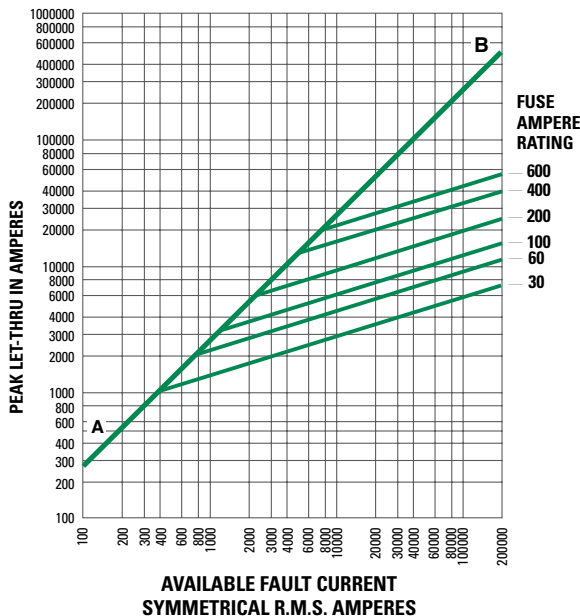

Figure 7 – Peak Let-through Charts

The diagonal curves that branch off the A-B line illustrate the current-limiting effects of different fuse ampere ratings for a given fuse series. To continue the example from above, enter the chart in *Figure 7* on the bottom at 100,000 rms symmetrical amperes and read upwards to the intersection of the 200 ampere fuse curve. Now read from this point horizontally to the left and read a peak let-through current of approximately 20,000 amperes.

What this tells us is that the 200 ampere fuse has reduced the peak current during the fault from 230,000 amperes to 20,000 amperes. In other words, this is the current-limiting effect of the 200 ampere fuse. 20,000 amperes is less than one-tenth of the available current. This is important because the magnetic force created by current flow is a function of the peak current squared. If the peak let-through current of a current-limiting fuse is one-tenth of the available peak, the magnetic force is reduced to less than 1/100 of what would occur without the fuse.

Using the Peak Let-through Charts (“Up-Over-and-Down”)

Peak Let-through Charts for Littelfuse POWR-GARD® fuses can be found online at www.littelfuse.com/technicalcenter. These charts are useful in determining whether a given fuse can properly protect a specific piece of equipment.

For example, given an available fault-current of 100,000 rms symmetrical amperes, determine whether 600 amp 250 volt time-delay Class RK1 fuses can sufficiently protect equipment that has a 22,000 amp short-circuit rating. Refer to *Figure 8*.

Start by locating the 100,000 A available fault-current on the bottom of the chart (Point A) and follow this value upwards to the intersection with the 600 amp fuse curve (Point B). Next, follow this point horizontally to the left to intersect with the A-B line (Point C). Finally, read down to the bottom of the chart (Point D) to read a value of approximately 18,000 amps.

Can the fuse selected properly protect the equipment for this application? Yes, the POWR-PRO® LLNRK 600 ampere RK1 current-limiting fuses have reduced the 100,000 amperes available current to an apparent or equivalent 18,000 amps. When protected by 600 amp LLNRK RK1 fuses, equipment with short-circuit ratings of 22,000 amps may be safely connected to a system having 100,000 available rms symmetrical amperes.

This method, sometimes referred to as the “Up-Over-and-Down” method, may be used to:

1. Provide back-up short-circuit protection to large air power circuit breakers.
2. Enable non-interrupting equipment such as bus duct to be

FUSE CHARACTERISTICS CURVES AND CHARTS

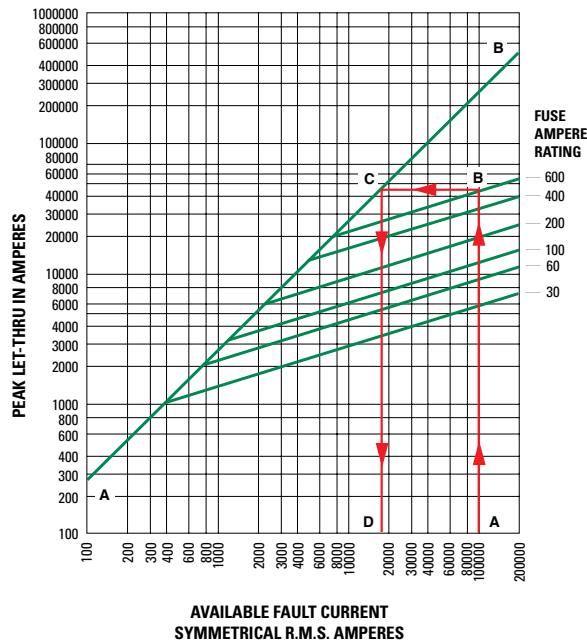

Figure 8 – Peak Let-through Chart for POWR-PRO® LLNRK Class RK1 Dual-Element Fuses Using the Up-Over-and-Down Method

installed in systems with available short-circuit currents greater than their short circuit (withstand) ratings.

However, this method may not be used to select fuses for backup protection of molded case or intermediate frame circuit breakers. National Electrical Code® (NEC®) Article 240.86 requires Series Ratings. Refer to the NEC for more information.

UL Listed fuse-to-circuit breaker series ratings are now available from most national load center and panelboard manufacturers. Listings are shown in their product digests, catalogs, and online. Many local builders have also obtained fuse-to-circuit breaker series ratings. For additional information contact the Littelfuse Technical Support Group at 1-800-TEC-FUSE (1-800-832-3873).

Short-Circuit Current Rating (SCCR)

Since 2005, the NEC has required Industrial Control Panels to be labeled with their SCCR. These labels allow users and inspectors to compare the SCCR of the equipment to the available fault current in order to avoid potential hazards in facilities. For additional information, the latest specific NEC requirements, and solutions on how to increase the SCCR for a panel, visit www.littelfuse.com/sccr.

Selective Coordination

A “coordinated” or “selective” system is a system whose overcurrent protective devices have been carefully chosen and their time-current characteristics coordinated.

Only the overcurrent device immediately on the line side of an overcurrent will open for any overload or short-circuit condition.

To further clarify, refer to the Terms and Definitions section for the definition of Selective Coordination and *Figure 15* for a graphical example.

Since the advent of electrical and electronic equipment, businesses have become entirely dependent on the continuous availability of electric energy. Loss of power halts all production and order processing, yet expenses continue to increase. Even many UPS systems become unintentionally non-selective causing power loss to computers and other critical equipment. Non-selectivity may defeat otherwise well-engineered UPS systems.

In a selective system, none of this occurs. Overloads and faults are disconnected by the overcurrent protective device immediately on the line side of the problem. The amount of equipment removed from service is minimized, the faulted or overloaded circuit is easier to locate, and a minimum amount of time is required to restore full service.

For these and many other reasons, selectivity is the standard by which many systems are judged and designed.

Fuse Selectivity

To get a better sense of how to ensure that fuses are selectively coordinated within an electrical system, refer to *Figure 4* shown earlier in this Technical Application Guide. This figure shows typical average melting time-current curves for one class of fuses. Note that the curves are roughly parallel to each other and that for a given overcurrent, the smaller fuse ratings respond quicker than the larger ratings. The heat energy required to open a fuse is separated into melting I^2t and arcing I^2t (see definition of Ampere-Squared-Seconds). The sum of these is the total clearing I^2t .

For a system to be considered coordinated, the smaller fuse total clearing I^2t must be less than the larger fuse melting I^2t . In other words, if the downstream (branch) fuse opens the circuit before the overcurrent affects the upstream (feeder) fuse element, the system will be considered selective. This can be determined by analyzing curves displaying melting and total clearing I^2t , or from minimum melting and maximum clearing time-current curves.

But the simplest method of coordinating low voltage power fuses is by using a Fuse Coordination Table such as the one shown in *Table 4*. This table is only applicable for the Littelfuse POWR-PRO® and POWR-GARD® fuse series listed. Tables such as this greatly reduce design time. For example, the coordination table shows that POWR-PRO KLPC Class L fuses coordinate at a two-to-one ratio with other Class L fuses, with POWR-PRO LLNRK / LLSRK / LLSRK_ID series

SELECTIVE COORDINATION

Class RK1 fuses, and POWR-PRO JTD / JTD_ID series Class J fuses.

In the system shown in *Figure 9*, the 3000 amp Class L main fuses are at least twice the ratings of the 1500, 1200, and 1000 amp Class L feeder fuses. Using the 2:1 ratio just referenced above, it is determined that these fuses will coordinate. The Coordination Table also shows that the LLSRK_ID series time-delay RK1 feeder and branch circuit fuses coordinate at a two-to-one ratio with the Class L feeder fuses, so the entire system in *Figure 9* would be considered 100% coordinated.

Circuit Breaker Coordination

As a result of the numerous types of circuit breakers and circuit breaker trip units available in today's market, developing a coordinated circuit breaker system or coordinating circuit breakers with fuses is beyond the scope of this Technical Application Guide. For further questions, contact the Littelfuse Technical Support Group.

NEC® Requirements for Selective Coordination

Component Short-Circuit Protecting Ability

As shown in *Figure 10*, the NEC® requires equipment protection to be coordinated with overcurrent protective devices and the available fault current in order to prevent extensive damage to the equipment. Essentially, this means that electrical equipment must be capable of withstanding heavy overcurrents without damage or be

properly protected by overcurrent protective devices that will limit damage.

When a severe fault occurs in an unprotected circuit, current immediately increases to a very high value. This is the available or prospective fault current. Some fuses respond so quickly to the increasing current that they interrupt current within the first half-cycle - or before the current even reaches its first peak. This is illustrated in *Figure 6* found earlier in the Technical Application Guide. Such fuses are termed "current-limiting fuses."

Current-limiting fuses stop damaging current faster than any other protective device, and greatly reduce or totally prevent component damage from high fault currents. This performance capability helps users meet the NEC Article 110.10 requirements listed in *Figure 10*.

Pre-Engineered Solutions

Applicable code requirements also continue to expand with each new edition of the National Electrical Code®. As of the 2011 edition of the NEC, the following requirements need to be met – and can be, utilizing Littelfuse POWR-GARD® Pre-Engineered Solutions:

- NEC 517.26 – Healthcare Essential Electrical Systems
- NEC 620.62 – Elevators
- NEC 700.27 – Emergency Systems
- NEC 701.27 – Legally Required Standby Systems
- NEC 708.54 – Critical Operations Power Systems

| LINE-SIDE FUSES | | | LOAD-SIDE FUSES | | | | | | | | |
|-----------------|----------|------------------------|--|---------------|-------------------|---------------|----------------------------|---------------|--|-------------|-----------|
| AMPERE RANGE | UL CLASS | LITTELFUSE CATALOG NO. | TIME-DELAY FUSES | | | | | | FAST-ACTING FUSES | | |
| | | | AMPERE RANGE, UL CLASS AND CATALOG NO. | | | | | | AMPERE RANGE, UL CLASS AND CATALOG NO. | | |
| | | | 601-6000 L | 601-4000 L | 30-600 RK1 | 30-600 J | 30-600 RK5 | 30-600 RK1 | 30-1200 T | 30-600 J | 1-60 G |
| | | | KLPC LDC | KLLU | LLNRK LLSRK_ID | JTD_ID JTD | FLNR_ID FLSR_ID IDSR | KLNR KLSR | JLLN JLLS | JLS | SLC |
| 601-6000 | L | KLPC | 2:1 | 2:1 | 2:1 | 2:1 | 4:1 | 2:1 | 2:1 | 2:1 | N/A |
| 601-4000 | L | KLLU | 2:1 | 2:1 | 2:1 | 2:1 | 4:1 | 2:1 | 2:1 | 2:1 | N/A |
| 601-2000 | L | LDC | 2:1 | 2:1 | 2:1 | 2:1 | 4:1 | 2:1 | 2:1 | 2:1 | N/A |
| 30-600 | RK1 | LLNRK | N/A | N/A | 2:1 | 2:1 | 8:1 | 3:1 | 3:1 | 3:1 | 4:1 |
| 30-600 | RK1 | LLSRK_ID | N/A | N/A | 2:1 | 2:1 | 8:1 | 3:1 | 3:1 | 3:1 | 4:1 |
| 30-600 | J | JTD_ID | N/A | N/A | 2:1 | 2:1 | 8:1 | 3:1 | 3:1 | 3:1 | 4:1 |
| 30-600 | RK5 | IDSR | N/A | N/A | 1.5:1 | 1.5:1 | 2:1 | 1.5:1 | 1.5:1 | 1.5:1 | 1.5:1 |
| 30-600 | RK5 | FLNR_ID | N/A | N/A | 1.5:1 | 1.5:1 | 2:1 | 1.5:1 | 1.5:1 | 1.5:1 | 1.5:1 |
| 30-600 | RK5 | FLSR_ID | N/A | N/A | 1.5:1 | 1.5:1 | 2:1 | 1.5:1 | 1.5:1 | 1.5:1 | 1.5:1 |
| 30-600 | RK1 | KLNR | N/A | N/A | 3:1 | 3:1 | 8:1 | 3:1 | 3:1 | 3:1 | 4:1 |
| 30-600 | RK1 | KLSR | N/A | N/A | 3:1 | 3:1 | 8:1 | 3:1 | 3:1 | 3:1 | 4:1 |
| 30-1200 | T | JLLN | N/A | N/A | 3:1 | 3:1 | 8:1 | 3:1 | 3:1 | 3:1 | 4:1 |
| 30-1200 | T | JLLS | N/A | N/A | 3:1 | 3:1 | 8:1 | 3:1 | 3:1 | 3:1 | 4:1 |
| 30-600 | J | JLS | N/A | N/A | 3:1 | 3:1 | 8:1 | 3:1 | 3:1 | 3:1 | 4:1 |
| 1-60 | G | SLC | N/A | N/A | 3:1 | 3:1 | 4:1 | 2:1 | 2:1 | 2:1 | 2:1 |

Table 4 – Fuse Coordination Table. Selecting the Correct Fuse Ampere Ratio to Maintain Selectively Coordinated Systems. (Ratios are expressed as Line-Side Fuse to Load-Side Fuse.)

SELECTIVE COORDINATION

The Littelfuse product line of Pre-Engineered Solutions includes:

- LPS Series POWR-Switch (single elevator shunt-trip disconnect switch)
- LPMP Series POWR-Switch Panel (multiple elevator shunt-trip disconnect switches)
- LCP Selective Coordination Panel

These products continue to gain in popularity because they meet NEC® requirements and offer simple, economical solutions for a variety of applications.

Visit www.littelfuse.com/lcp for more information on Littelfuse Pre-Engineered Solution products and corresponding selective coordination requirements.

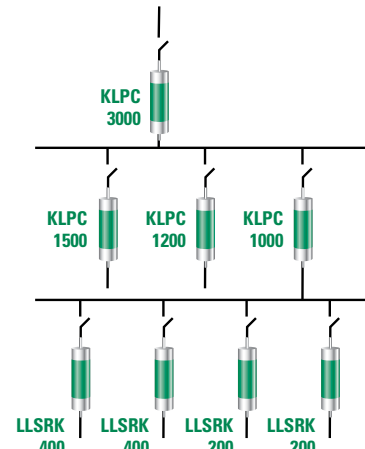

Figure 9 – Example of Selectively Coordinated Fused System

NATIONAL ELECTRICAL CODE®

ARTICLE 110 – Requirements for Electrical Installations

I. General

110.3. Examination, Identification, Installation, and Use of Equipment.

(A) **Examination.** In judging equipment, considerations such as the following shall be evaluated:

- (5) Heating effects under normal conditions of use and also under abnormal conditions likely to arise in service.
- (6) Arcing effects.

(B) **Installation and Use.** Listed or labeled equipment shall be used or installed in accordance with any instructions included in the listing or labeling.

110.9 Interrupting Rating. Equipment intended to interrupt current at fault levels shall have an interrupting rating not less than the nominal circuit voltage and the current that is available at the line terminals of the equipment.

Equipment intended to interrupt current at other than fault levels shall have an interrupting rating at nominal circuit voltage not less than the current that must be interrupted.

110.10 Circuit Impedance, Short-Circuit Current Ratings, and Other Characteristics. The overcurrent protective devices, the total impedance, the equipment short-circuit current ratings, and other characteristics of the circuit to be protected shall be selected and coordinated to permit the circuit protective devices used to clear a fault to do so without extensive damage to the electrical equipment of the circuit. This fault shall be assumed to be either between two or more of the circuit conductors or between any circuit conductor and the equipment grounding conductor(s) permitted in 250.118. Listed equipment applied in accordance with their listing shall be considered to meet the requirements of this section.

ARTICLE 240 – Overcurrent Protection

240.1 Scope. Parts I through VII of this article provide the general requirements for overcurrent protection and overcurrent protective devices not more than 600 volts, nominal. Part VIII covers overcurrent protection for those portions of supervised industrial installations operating at voltages of not more than 600 volts, nominal. Part IX covers overcurrent protection over 600 volts, nominal.

Informational Note: Overcurrent protection for conductors and equipment is provided to open the circuit if the current reaches a value that will cause an excessive or dangerous temperature in conductors or conductor insulation. See also Articles 110.9 for requirements for interrupting ratings and 110.10 for requirements for protection against fault currents.

(Reproduced by permission of NFPA)

Figure 10 – National Electrical Code Requires Effective Overcurrent Protection

UL/CSA FUSE CLASSES AND APPLICATIONS

Overcurrent and short-circuit protection of power and lighting feeders and branch circuits

Current Limiting

Fuses which meet the requirements for current limiting fuses are required to be labeled "Current Limiting". Fuse labels must include: UL/CSA fuse class, manufacturer's name or trademark, current rating, AC and/or DC voltage rating, and AC and/or DC interrupting rating. "Time Delay," "D," "TD" or equivalent may also be included on the label when the fuse complies with the time delay requirements of its class.

CLASS L

STANDARDS: UL Standard 248-14, CSA Standard C22.2, No. 106, classified as HRCI-L

VOLTAGE RATING: 600 volts, AC and/or DC

CURRENT RATINGS: 601-6000 amps
KLPC also available 200-600A; LDC also available 150-600A

INTERRUPTING RATING: AC: 200,000 amps rms symmetrical
DC: 50,000, 100,000, or 200,000 amps

Not interchangeable with any other UL fuse class.
Time delay: Class L fuses may be marked "Time-Delay" although UL does not investigate time-delay characteristics of Class L fuses.
KLPC & KLLU: 10 seconds at 500% current rating
LDC: 4 seconds at 500% current rating

LF SERIES: KLPC, KLLU, LDC

PAGE: 9

CLASS R

STANDARDS: UL Standard 248-12, CSA Standard C22.2, No. 106, classified as HRCI-R

VOLTAGE RATINGS: 250 and 600 volts, AC; 125 and 300 volts DC

CURRENT RATINGS: 0-600 amps

INTERRUPTING RATING: 200,000 amps rms symmetrical

TWO CLASSES: RK1 and RK5
Time delay is optional for Class R fuses.
Time Delay fuses are required to hold 500% current rating for a minimum of ten seconds. Same dimensions as UL Class H fuses, terminals modified to provide rejection feature. Fits UL Class R fuse holders which reject non Class R fuses. Physically interchangeable with UL Class H, NEMA Class H, and UL Classes K1 & K5 when equipment has Class H fuse holders.

CLASS RK1

High degree of current limitation. Provides IEC Type 2 (no damage) protection for motor starters and control components. Time Delay optional, LLSRK_ID Series provides visual indication of blown fuse.

LF SERIES: Time Delay: LLNRK, LLSRK, LLSRK_ID
Fast Acting: KLNR, KLSR

PAGE: 14

CLASS RK5

Moderate degree of current limitation, adequate for most applications. Time delay optional. FLNR_ID, FLRSR_ID and IDSR series provides visual indication of blown fuse.

LF SERIES: FLNR, FLNR_ID, FLRSR, FLRSR_ID, and IDSR

PAGE: 17

CLASS J

STANDARDS: UL Standard 248-8, CSA Standard C22.2, No. 106, classified as HRCI-J

VOLTAGE RATING: 600 volts, AC

CURRENT RATINGS: 0-600 amps

INTERRUPTING RATING: 200,000 amps rms symmetrical

Not interchangeable with any other UL fuse class.
Time delay optional: Minimum of 10 seconds at 500% current rating.

LF SERIES: Time Delay: JTD_ID, JTD
Fast Acting: JLS

PAGE: 23

CLASS CC/CD

STANDARDS: UL Standard 248-4, CSA Standard C22.2, No. 106, classified as HRCI Misc.

VOLTAGE RATING: 600 volts, AC

CURRENT RATINGS: UL Class CC: 0-30 amps
UL Class CD: 35-60 amps

INTERRUPTING RATINGS: 200,000 amps rms symmetrical
Time delay optional: Minimum of 12 seconds at 200% current rating.

LF SERIES: Time Delay: CCMR (motors), KLDR (transformers)
Fast Acting: KLKR

PAGE: 29

CLASS T

STANDARDS: UL Standard 248-15, CSA Standard C22.2, No. 106, classified as HRCI-T

VOLTAGE RATINGS: 300 and 600 volts AC, 125 and 300 volts DC

CURRENT RATINGS: 0-1200 amps
900 to 1200 amps UL Recognized for 600V version

INTERRUPTING RATING: 200,000 amps rms symmetrical
Fast-Acting fuses. High degree of current limitation. Very small fuses; space-saving and non-interchangeable with any other UL fuse class.

LF SERIES: JLLN, JLLS

PAGE: 26

CLASS G

STANDARDS: UL Standard 248-5, CSA Standard C22.2, No. 106, classified as HRCI Misc.

VOLTAGE RATING: 480 volts, AC

CURRENT RATINGS: 0-60 amps

INTERRUPTING RATING: 100,000 amps rms symmetrical

Not interchangeable with any other UL fuse class.
Time delay optional: Minimum of 12 seconds at 200% current rating.

LF SERIES: SLC

PAGE: 28

CLASS K

STANDARDS: UL Standard 248-9; No CSA Standard

VOLTAGE RATINGS: 250 and 600 volts, AC

CURRENT RATING: 0-600 amps

INTERRUPTING RATINGS: Three permitted: 50,000, 100,000, and 200,000 amps rms symmetrical

Time delay is optional for Class K fuses.
Time Delay fuses are required to hold 500% current rating for a minimum of ten seconds. Same Dimensions and Physically interchangeable with UL Class H fuse holders. Class K fuses are not permitted to be labeled Current Limiting because there is no rejection feature as required by NEC Article 240-60(B).

CLASS K1

Same prescribed degree of current limitation as RK1 fuses when tested at 50,000 or 100,000 amps rms symmetrical.

LF SERIES: Time Delay: LLNRK, LLSRK
Fast Acting: KLNR, KLSR

PAGE: 14

CLASS K5

Same prescribed degree of current limitation as RK5 fuses when tested at 50,000 or 100,000 amps rms symmetrical.

LF SERIES: NLN, NLS

PAGE: 21

UL/CSA FUSE CLASSES AND APPLICATIONS

Overcurrent and short-circuit protection of power and lighting feeders and branch circuits

FUSES FOR SUPPLEMENTARY OVERCURRENT PROTECTION

STANDARDS: UL Standard 248-14; CSA Standard C22.2, No. 59-1. Three Classifications covered.
NOTE: Fuses may be rated for AC and/or DC when suitable for such use.

- (1) **MICRO FUSES**
 Voltage ratings: UL, 125 volts; CSA, 0-250 volts
 Current ratings: UL, 0-10 amps; CSA, 0-60 amps
 Interrupting rating: 50 amps rms symmetrical
- (2) **MINIATURE FUSES** (CSA classifies these as Supplemental Fuses)
 Voltage ratings: UL, 125 or 250 volts; CSA, 0-600 volts
 Current ratings: UL, 0-30 amps; CSA, 0-60 amps
 Interrupting rating: 10,000 amps rms symmetrical
- (3) **MISCELLANEOUS CARTRIDGE FUSES** (CSA classifies these as Supplemental Fuses)
 Voltage ratings: UL, 125-1000 volts; CSA, 0-100 volts
 Current ratings: UL, 0-30 amps; CSA 0-60 amps
 Interrupting ratings: 10,000, 50,000, or 100,000 amps rms symmetrical
 Time delay (Optional); Minimum delay at 200% fuse rating:
 5 seconds for fuses rated 3 amps or less
 12 seconds for fuses rated more than 3 amps

LF SERIES: BLF, BLN, BLS, FLA, FLM, FLQ, FLU, KLK, KLKD (600 Volts DC), SPF
NOTE: Littelfuse electronic fuses are also covered by these standards; see electronic section of this catalog, or request Electronic Designer's Guide (Publication No. EC101) for complete listing.

PAGE: 32

SPECIAL PURPOSE FUSES

There are no UL Standards covering this category of fuses. These fuses have special characteristics designed to protect special types of electrical or electronic equipment such as diodes, SCR, transistors, thyristors, capacitors, integrally fused circuit breakers, parallel cable runs, etc.
 Fuses may be UL Recognized for use as a component in UL Listed equipment. UL Recognized fuses are tested for characteristics such as published interrupting capacity. They are also covered by UL re-examination service.

Non-renewable
VOLTAGE RATINGS: up to 1000 volts AC and/or DC
AMPERE RATINGS: up to 6000 amperes
INTERRUPTING RATINGS: up to 200,000 amperes
 Many of these fuses are extremely current limiting. When considering application of these fuses, or if you have special requirements, contact Littelfuse Technical Support Group for assistance.

LF SERIES: KLC, LA15QS, LA30QS, LA50QS, LA60QS, LA60X, LA70QS, LA100P, LA120X, LA070URD, LA130URD, L15S, L25S, L50S, L60S, L70S, JLLS 900 amp through 1200 amp

PAGES: 57-78

Non-Current Limiting

CLASS H

STANDARDS: UL Standard 248-6
 CSA Standard C22.2, No. 59.1
 Also known as NEMA Class H, and sometimes referred to as "NEC" or "Code" fuses

VOLTAGE RATINGS: 250 and 600 volts, AC
AMPERE RATINGS: 0-600 amps
INTERRUPTING RATINGS: 10,000 amps rms symmetrical
 Two types: one-time and renewable

Physically interchangeable with UL Classes K1 & K5;
 Fits UL Class H fuse holders which will also accept K1, K5, RK5, and RK1 fuses.
 Manufacturers are upgrading Class H One-time fuses to Class K5 per UL Standard 248-9D, See Class K fuses.

ONE-TIME FUSES (NON-RENEWABLE)

Time delay: Optional
 Time-delay fuses must hold 500% current rating for a minimum of ten seconds.

LF SERIES: NLKP

PAGE: 21

RENEWABLE FUSES

Only Class H fuses may be renewable. While time delay is optional, no renewable fuses meet requirements for time delay.
 Some renewable fuses have a moderate amount of time delay, referred to as "time lag" to differentiate from true time delay.

LF SERIES: RLN, RLS
REPLACEABLE LINKS SERIES: LKN, LKS

PAGE: 22

PLUG FUSES

STANDARDS: UL Standard 248-11,
 CSA Standard C22.2, No. 59.1

VOLTAGE RATINGS: 125 volts AC only
AMPERE RATINGS: 0-30 amps
INTERRUPTING RATINGS: 10,000 amps rms symmetrical. Interrupting rating need not be marked on fuse.

Two types: Edison-base and Type S

EDISON-BASE: Base is same as standard light bulb. All amp ratings interchangeable. NEC permits Edison-base plug fuses to be used only as replacements for existing fuses, and only when there is no evidence of tampering or overfusing.

TYPE S: Not interchangeable with Edison-base fuses unless non-removable Type S fuse adapter is installed in Edison-base fuse socket. To prevent overfusing, adapters have three ampere ratings: 10-15, 16-20, and 21-30 amps.

Time delay: Fuses may be time delay, if so, they are required to hold 200% of rating for 12 seconds minimum.

NOTE: Plug fuses may be used where there is not more than 125 volts between conductors or more than 150 volts from any conductor to ground. This permits their use in 120/240 volts grounded, single-phase circuits.

LF SERIES: Edison-base: TOQ, TLO
 Type S: SOO, SLO
 Type S Adapters: SAO

PAGE: 63

ELECTRICAL SAFETY GUIDE

Introduction

Electrical safety is an important issue for employers and employees alike. Unfortunately, thousands of electrical accidents continue to occur each year resulting in permanent disabilities to personnel and excessive medical and equipment replacement costs.

OSHA requirements are often the motivating factor increasing electrical safety in the workplace. OSHA continues to increase enforcement activities and is seeking to increase penalties for violations.

Typical OSHA violations related to electrical safety include improper Lockout/Tagout, faulty electrical wiring, failure to follow electrical safe work practices, failure to assess and identify hazards, failure to train employees and failure to provide PPE (personal protective equipment) to workers.

Industry consensus standards such as NFPA 70E, *Standard for Electrical Safety in the Workplace*, has been created at the request of OSHA to define and quantify electrical hazards including Shock, Arc-Flash and Arc-Blast.

Steps to Electrical Safety Compliance

- Define the project scope and identify any current safety program gaps
- Collect data and document your electrical system
- Evaluate your electrical system through engineering analysis
- Identify hazards and re-engineer to reduce hazards
- Label equipment to communicate hazards
- Update or develop an Electrical Safety Program
- Obtain Personnel Protective Equipment (PPE) and insulated tools
- Train Personnel
- Maintain and Audit One-Line Drawings and Electrical Safety Programs

WHAT OSHA REQUIRES YOU...

TO COMPLY WITH 1910 SUBPARTS

| |
|---|
| You MUST assess and identify all hazards above 50 volts |
| You MUST put safeguards in place for hazards above 50 volts |
| You MUST train employees on safe work practices |

HOW NFPA 70E MUST BE FOLLOWED...

TO COMPLY WITH 1910 SUBPART S

| |
|---|
| NFPA 70E explains how to perform a Shock & Arc-Flash Hazard Assessment down to 50 volts using tables and calculations |
| NFPA 70E establishes Hazard Risk Categories, Protection Boundaries, LO/TO, PPE requirements and the use of Energized Work Permits |
| NFPA 70E defines Qualified and Unqualified workers along with training requirements |

Table 5 - Comparison of OSHA and NFPA 70E

OSHA Standard 29 Part 1910 Subpart S (electrical)

generally addresses electrical safety standards, work practices, and maintenance requirements.

NFPA 70E Standard for Electrical Safety in the Workplace

is an industry consensus standard that focuses on safety requirements to protect employees. OSHA commonly is referred to as the "What" or "Shall" and NFPA 70E as the "How" with regards to electrical safety compliance.

OSHA and NFPA 70E reinforce the need for Electrical Hazard Analysis.

Electrical Hazard Analysis should address all potential hazards including Shock, Arc-Flash, Arc-Blast and burns. OSHA's general duty clause requires a workplace free from hazards and OSHA 1910.132(d) requires employers to identify hazards and protect workers. NFPA 70E Article 130.3(B)(1) specifically requires Electrical Hazard Analysis within all areas of the electrical system that operate at 50 volts or greater.

ELECTRICAL SAFETY GUIDE

Sources of Electrical Hazards and Faults

- Exposed energized parts
- Equipment fatigue or failure
- Accidental contact with energized parts
- Worn or broken insulation
- Loose connections
- Improperly maintained equipment or circuit breakers
- Water or liquid near electrical equipment
- Obstructions near or on equipment
- Improper grounding

Types of Electrical Faults

It is well documented and estimated that 95% of electrical faults start as ground faults. The remaining 5% are either phase-to-phase or three-phase faults. So in essence, if we are able to eliminate phase-to-ground faults, or 95% of all faults, we have essentially reduced the potential for 95% of the Arc-Flash Hazard, making the electrical system much safer.

| LEADING INITIATORS OF FAULTS | % OF ALL FAULTS |
|------------------------------------|-----------------|
| Exposure to moisture | 22.5% |
| Shortening by tools, rodents, etc. | 18.0% |
| Exposure to dust | 14.5% |
| Other mechanical damage | 12.1% |
| Exposure to chemicals | 9.0% |
| Normal deterioration from age | 7.0% |

Table 6 - Leading initiators of electrical faults

Reducing Electrical Hazards

There are many methods and practices for reducing Arc-Flash and other electrical hazards while conforming to OSHA, NEC®, and NFPA 70E regulations and guidelines. Circuit designers and electrical engineers should carefully consider the following recommendations:

- Design the hazard out of the system through engineering design and component selection
- Identify and assess electrical hazards
- Use and upgrade to current-limiting overcurrent protective devices
- Implement an Electrical Safety Program
- Observe safe work practices
- Use properly selected Personal Protective Equipment (PPE) including insulated tools
- Use Warning Labels to identify and communicate electrical hazards
- Enforce Lockout/Tagout procedures and use Energized Electrical Work Permits
- Increase system protection by achieving Selective Coordination and using Ground Fault Protection devices.

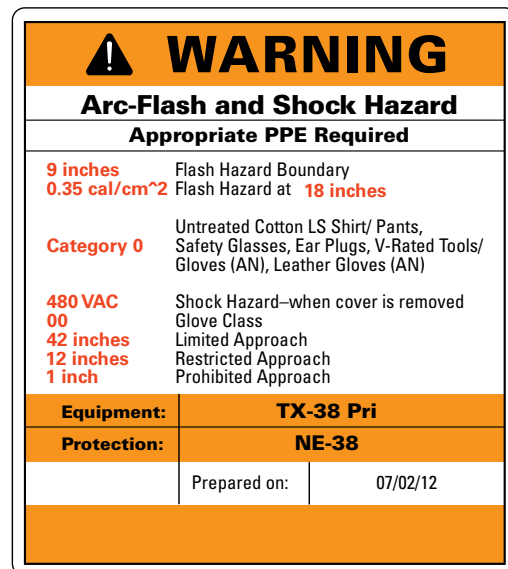

Example of warning label

TERMS AND DEFINITIONS

Adjustable Alarm Level – A setting on a protection relay at which an LED or an output contact operates to activate a visual or audible alarm.

Adjustable Time Delay – A setting on a protection relay that determines the time between the fault detection and relay operation.

AIC or A.I.C. – See Interrupting Capacity.

AIR or A.I.R. – See Interrupting Rating.

Alarm Relay Contact – The output of the relay that acts as a switch and is connected to a visual or audible alarm.

Ambient Temperature – The air temperature surrounding a device. For fuses or circuit breakers in an enclosure, the air temperature within the enclosure.

Ampacity – The current in amperes that a conductor can carry continuously under the conditions of use without exceeding its temperature rating. It is sometimes informally applied to switches or other devices which are more properly referred to by their ampere rating.

Ampere Rating – The current rating, in amperes, that is marked on fuses, circuit breakers, or other equipment.

Ampere-Squared-Seconds (I^2t) – A means of describing the thermal energy generated by current flow. When a fuse is interrupting a current within its current-limiting range, the term is usually expressed as melting, arcing, or total clearing I^2t .

- Melting I^2t is the heat energy passed by a fuse after an overcurrent occurs and until the fuse link melts. It equals the rms current squared multiplied by the melting time in seconds. For times less than 0.004 seconds, melting I^2t approaches a constant value for a given fuse.
- Arcing I^2t is the heat energy passed by a fuse during its arcing time. It is equal to the rms arcing current squared (see definition below), multiplied by arcing time.
- Clearing I^2t (also Total Clearing I^2t) is the ampere-squared seconds (I^2t) through an overcurrent device from the inception of the overcurrent until the current is completely interrupted. Clearing I^2t is the sum of the Melting I^2t plus the Arcing I^2t .

Analog Output – A 0–1 mA, 4–20 mA or 0–5 Vdc signal from a protection relay used to pass information to a device or controller.

Arc-Blast – A pressure wave created by the heating, melting, vaporization, and expansion of conducting material and surrounding gases or air.

Arc-Flash – The sudden release of heat energy and intense light at the point of an arc. Can be considered a short-circuit through the air, usually created by accidental contact between live conductors.

Arc Gap – The distance between energized conductors or between energized conductors and ground. Shorter arc gaps result in less energy being expended in the arc, while longer gaps reduce arc current. For 600 volts and below, arc gaps of 1.25 inches (32 mm) typically produce the maximum incident energy.

Arc Rating – A rating assigned to material(s) that relates to the maximum incident energy the material can resist before break open of the material or onset of a second-degree burn. The arc rating is typically shown in cal/cm².

Arcing Current (See *Figure 11*) – The current that flows through the fuse after the fuse link has melted and until the circuit is interrupted.

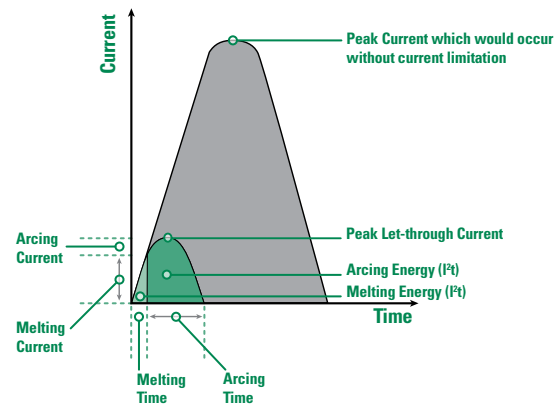

Figure 11 – Arcing and melting currents plus arcing, melting and clearing times

Arcing I^2t – See Ampere-Squared-Seconds (I^2t).

Arcing Fault – A short-circuit that arcs at the point of fault. The arc impedance (resistance) tends to reduce the short-circuit current. Arcing faults may turn into bolted faults by welding of the faulted components. Arcing faults may be phase-to-phase or phase-to-ground.

Arcing Time (See *Figure 11*) – The time between the melting of a fuse link or parting of circuit breaker contacts, until the overcurrent is interrupted.

Arc Voltage (See *Figure 12*) – Arc voltage is a transient voltage that occurs across an overcurrent protection device during the arcing time. It is usually expressed as peak instantaneous voltage (V_{peak} or E_{peak}), or on rare occasion as rms voltage.

Asymmetrical Current – See Symmetrical Current.

Available Short-Circuit Current (also Available or Prospective Fault Current) – The maximum rms Symmetrical Current that would flow at a given point in a system under bolted-fault conditions. Short-circuit current is maximum during the first half-cycle after the fault occurs. See definitions of Bolted Fault and Symmetrical Current.

TERMS AND DEFINITIONS

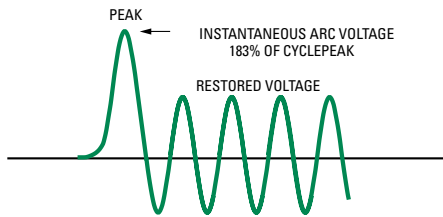

Figure 12 – Transient overvoltage during arcing time

Blade Fuse – See Knife Blade Fuse.

Body – The part of a fuse enclosing the fuse elements and supporting the contacts. Body is also referred to as cartridge, tube, or case.

Bolted Fault – A short-circuit that has no electrical resistance at the point of the fault. It results from a firm mechanical connection between two conductors, or a conductor and ground. Bolted faults are characterized by a lack of arcing. Examples of bolted faults are a heavy wrench lying across two bare bus bars, or a crossed-phase condition due to incorrect wiring.

Boundaries of Approach – Protection boundaries established to protect personnel from shock and Arc-Flash hazards.

Calorie – The amount of heat needed to raise the temperature of one gram of water by one degree Celsius. 1 cal/cm² is equivalent to the exposure on the tip of a finger by a cigarette lighter for one second.

Cartridge Fuse – A fuse that contains a current-responsive element inside a tubular fuse body with cylindrical ferrules (end caps).

Case Size (also Cartridge Size) – The maximum allowable ampere rating of a cartridge fuse having defined dimensions and shape. For example, case sizes for UL Listed Class H, K, J, RK1, and RK5 are 30, 60, 100, 200, 400, and 600 amperes. The physical dimensions vary with fuse class, voltage, and ampere rating. UL Standards establish the dimensions for each UL Fuse Class. This catalog's product section contains case size dimensions for all Littelfuse POWR-GARD® fuses.

Clearing I²t – See Ampere-Square-Seconds (I²t).

Clearing Time (see Figure 11) – The time between the initiation of an overcurrent condition to the point at which the overcurrent is interrupted. Clearing Time is the sum of Melting Time and Arcing Time.

Conformal Coating – Coating used to protect circuit boards from pollutants, corrosion, and mildew.

Contacts (Fuse) – The external metal parts of the fuse used to complete the circuit. These consist of ferrules, caps, blades or terminals, as shown in this catalog.

Coordination or Coordinated System – See Selective Coordination.

Continuous Load – An electrical load where the maximum current is expected to continue for three hours or more.

CT Loop – The electrical circuit between a current transformer and a protection relay or monitoring device.

Current-Based Protection – Protection parameters (trip-levels/ data collection etc.) derived from current levels in a circuit.

Current-limiting Fuse (See Figure 13) – A fuse which, when interrupting currents within its current-limiting range, reduces the current in the faulted circuit to a magnitude substantially less than that obtainable in the same circuit if the device was replaced with a solid conductor having comparable impedance. To be labeled “current limiting,” a fuse must mate with a fuse block or fuse holder that has either a rejection feature or dimensions that will reject non-current-limiting fuses.

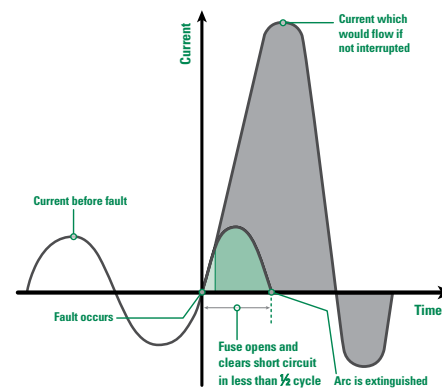

Figure 13 – Current-limiting Fuse

Current-limiting Range – For an individual overcurrent protective device, the current-limiting range begins at the lowest value of rms symmetrical current at which the device becomes current-limiting (the threshold current) and extends to the maximum interrupting capacity of the device. See definitions of Threshold Current and Interrupting Capacity.

Current Rating – See Ampere Rating.

Current Transformer (CT) – A transformer that produces a current in its secondary circuit in a known proportion to current in its primary circuit.

Data Logging – Collecting and storing information in a format that can be reviewed for trending, troubleshooting and reporting.

DFT (Discrete Fourier Transform) Harmonic Filter – An algorithm used to measure the fundamental component of current and voltage and reject harmonics. This allows lower trip settings and eliminates nuisance trips due to harmonics.

TERMS AND DEFINITIONS

Distance to Arc – Refers to the distance from the receiving surface to the arc center. The value used for most calculations is typically 18 inches.

Dual-Element Fuse – A fuse with internal construction consisting of a separate time-delay overload element(s) that interrupts overcurrents up to approximately 500%-600% of its nominal rating, plus separate fuse links that quickly open higher value currents. All dual-element fuses have time delay, but, since there are other methods of achieving time delay, not all time-delay fuses have dual-element construction. See Time-Delay Fuse.

EFCT (Earth Fault Current Transformer) – A current transformer engineered to accurately detect low level ground-fault current.

Electrical Hazard Analysis – A study performed to identify the potential electrical hazards to which personnel may be exposed. The analysis should address both shock and Arc-Flash hazards.

Electrically Safe Work Condition – Condition where the equipment and or circuit components have been disconnected from electrical energy sources, locked/tagged out, and tested to verify all sources of power are removed.

Element – A fuse's internal current-carrying components that melt and interrupt the current when subjected to an overcurrent of sufficient duration or value. Also called fuse link.

Fail-Safe Mode (also known as Under Voltage or UV) – Output relay is energized during normal (not tripped) operation. If the protection relay loses supply voltage, the system will trip or alarm.

Fast-Acting Fuse – May also be termed Normal-opening fuse, this is a fuse that has no intentional or built-in time delay. Actual opening time is determined by the fuse class, the overcurrent, and other conditions. Fast-acting is indicated on the fuse label by "Fast-Acting," "FA," "F," or other suitable marking.

Fault – Same as Short-Circuit and used interchangeably.

Fault Current – The current that flows when a phase conductor is faulted to another phase or ground.

Feeder Protection – Overcurrent or overvoltage devices installed on a feeder circuit to supplement, compliment or replace downstream protective devices.

Filler – A material, such as granular quartz, used to fill a section or sections of a fuse and aid in arc quenching.

Filter – An algorithm used to measure the fundamental component of current and voltage and reject harmonics. This allows lower trip settings and eliminates nuisance trips due to harmonics.

Flash Hazard Analysis – A study that analyzes potential exposure to Arc-Flash hazards. The outcome of the study establishes Incident Energy levels, Hazard Risk Categories,

Flash Protection Boundaries, and required PPE. It also helps define safe work practices.

Flash Protection Boundary – A protection boundary established to protect personnel from Arc-Flash hazards. The Flash Protection Boundary is the distance at which an unprotected worker can receive a second-degree burn to bare skin.

Fuse – An overcurrent protective device consisting of one or more current carrying elements enclosed in a body fitted with contacts, so that the fuse may be readily inserted into or removed from an electrical circuit. The elements are heated by the current passing through them, thus interrupting current flow by melting during specified overcurrent conditions.

Ground Continuity Monitor - A protection relay that continuously monitors a ground conductor and trips if this conductor opens or shorts to the ground-check conductor.

Ground-Fault – Unintentional contact between a phase conductor and ground or equipment frame. The words "ground" and "earth" are used interchangeably when it comes to electrical applications.

Ground-Fault Current – The current that returns to the supply neutral through the ground-fault and the ground-return path.

Ground-Fault Protection – A system that protects equipment from damaging ground-fault current by operating a disconnecting means to open all ungrounded conductors of a faulted circuit. This protection is at current levels less than those required to operate a supply circuit overcurrent device.

Ground-Fault Relay – A protection relay designed to detect a phase-to-ground-fault on a system and trip when current exceeds the pickup setting for greater than the trip time setting.

Hazard Risk Category – A classification of risks (from 0 to 4) defined by NFPA 70E. Each category requires PPE and is related to incident energy levels.

High-Resistance Grounding – Achieved when a neutral-ground resistor (NGR) is used to limit the current to a low level. Typically high-resistance grounding is 25 A and lower. See Low-Resistance Grounding.

I²t – See Ampere-Squared-Seconds (I²t).

IEEE Device Numbers – The devices in switching equipment are referred to by numbers, according to the functions they perform. These numbers are based on a system which has been adopted as standard for automatic switchgear by IEEE. This system is used on connection diagrams, in instruction books and in specifications.

IEC Type 2 Protection – Fused protection for control components that prevents damage to these components under short-circuit conditions. See definition of No Damage.

TERMS AND DEFINITIONS

Incident Energy – The amount of thermal energy impressed on a surface generated during an electrical arc at a certain distance from the arc. Typically measured in cal/cm².

Instantaneous Peak Current (I_p or I_{peak}) – The maximum instantaneous current value developed during the first half-cycle (180 electrical degrees) after fault inception. The peak current determines magnetic stress within the circuit. See Symmetrical Current.

Insulation Monitoring – Monitoring the resistance from phase to ground to detect insulation breakdown on a system.

Interrupting Capacity (AIC) – The highest available symmetrical rms alternating current (for DC fuses the highest direct current) at which the protective device has been tested, and which it has interrupted safely under standardized test conditions. The device must interrupt all available overcurrents up to its interrupting capacity. Also commonly called interrupting rating. See Interrupting Rating below.

Interrupting Rating (IR, I.R., AIR or A.I.R.) – The highest RMS symmetrical current, at specified test conditions, which the device is rated to interrupt. The difference between interrupting capacity and interrupting rating is in the test circuits used to establish the ratings.

Inverse-time Characteristics – A term describing protective devices whose opening time decreases with increasing current.

IR or I.R. (also AIR or A.I.R.) – See Interrupting Rating above.

Kiloamperes (kA) – 1,000 amperes.

Knife Blade Fuse – Cylindrical or square body fuses with flat blade terminals extending from the fuse body. Knife blades may be designed for insertion into mating fuse clips and/or to be bolted in place. Knife blade terminals may include a rejection feature that mates with a similar feature on a fuse block of the same class.

Leakage Current – Very low level ground-fault current, typically measured in milliamperes (mA, thousandths of amperes).

Limited Approach Boundary – An approach boundary to protect personnel from shock. A boundary distance is established from an energized part based on system voltage. To enter this boundary, unqualified persons must be accompanied with a qualified person and use the proper PPE.

Low-Resistance Grounding – A Resistance Grounded System that allows high currents to flow during a ground-fault. Typically 100A and higher is considered Low-Resistance grounding. See High-Resistance Grounding.

Melting Current (see *Figure 11*) – The current that flows through the fuse from the initiation of an overcurrent condition to the instant arcing begins inside the fuse.

Melting I²t – See Ampere-Squared-Seconds (I²t).

Melting Time (see *Figure 11*) – The time span from the initiation of an overcurrent condition to the instant arcing begins inside the fuse.

Motor Protection – Overload protection designed to protect the windings of a motor from high current levels. Modern motor protection relays add many additional features, including metering, data logging and communications.

NEC – In general, the National Electrical Code® (NEC®). Specifically, as referenced herein, NEC refers to NFPA Standard 70, *National Electrical Code*, National Fire Protection Association, Quincy, MA 02269.

Sections of the NEC reprinted herein, and/or quotations there from, are done so with permission. The quoted and reprinted sections are not the official position of the National Fire Protection Association which is represented only by the Standard in its entirety. Readers are cautioned that not all authorities have adopted the most recent edition of the NEC; many are still using earlier editions.

Neutral Grounding Resistor (NGR) – A current-limiting resistor connecting the power-system neutral to ground.

No Damage – A term describing the requirement that a system component be in essentially the same condition after the occurrence of a short-circuit as prior to the short-circuit.

Non-renewable Fuse – A fuse that must be replaced after it has opened due to an overcurrent. It cannot be restored to service.

Normal-opening Fuse – See Fast-Acting Fuse.

Nuisance Trip – An undesired change in relay output due to misinterpreted readings.

One-time Fuse – Technically, any non-renewable fuse. However, the term usually refers to UL Class H fuses and to fast acting UL Class K5 fuses. Such fuses are not current-limiting and do not have a rejection feature. One-time fuses are also referred to as “Code” fuses.

Open CT Hazard – An open-circuited CT secondary can develop a dangerously high voltage when the primary is energized.

Overcurrent – Any current larger than the equipment, conductor, or devices are rated to carry under specified conditions.

Overload – An overcurrent that is confined to the normal current path (e.g., not a short-circuit), which if allowed to persist, will cause damage to equipment and/or wiring. Additional information regarding fuse applications for overload protection can be found earlier in this Technical Application Guide.

TERMS AND DEFINITIONS

Peak Let-through Current (See Figure 14) – The maximum instantaneous current that passes through an overcurrent protective device during its total clearing time when the available current is within its current-limiting range.

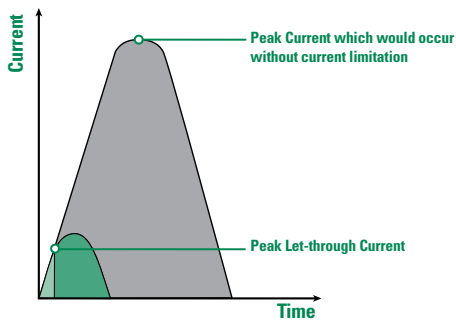

Figure 14 – Peak Let-through Current

Phase Current – The current present in a phase conductor.

Phase Voltage – The voltage measured between a phase conductor and ground.

Power Factor (X/R) – As used in overcurrent protection, power factor is the relationship between the inductive reactance (X) and the resistance (R) in the system during a fault. Under normal conditions a system may be operating at a 0.85 power factor (85%). When a fault occurs, much of the system resistance is shorted out and the power factor may drop to 25% or less. This may cause the current to become asymmetrical. See definition of Symmetrical Current. The UL test circuits used to test fuses with interrupting ratings exceeding 10,000 amperes are required to have a power factor of 20% or less. Since the power factor of test circuits tends to vary during test procedures, actual test circuits are usually set to a 15% power factor. The resulting asymmetrical current has an rms value of 1.33 times the available symmetrical rms. The instantaneous peak current of the first peak after the fault is 2.309 times the available symmetrical rms.

PPE – An acronym for Personal Protective Equipment. It can include clothing, tools, and equipment.

Primary Rating (for CTs) – The current rating of the primary side of a current transformer. The first number in the ratio 500:5 is the primary rating. Under ideal conditions 500 A of primary current flow through the CT will produce 5 A of current out the secondary terminals.

Prohibited Approach Boundary – An approach boundary to protect personnel from shock. Work in this boundary is considered the same as making direct contact with an energized part. Only qualified persons are allowed to enter this boundary and they must use the proper PPE.

Prospective Current – See Available Short-Circuit Current.

Protection Boundaries – Boundaries established to protect personnel from electrical hazards.

Pulsing – Modulating the ground-fault current on a resistance grounded system using a contactor to short out part of the NGR elements (or to open one of two NGRs connected in parallel). Another version of pulsing is imposing a higher frequency signal on power lines and using a wand detector to locate the point of fault on a conductor.

QPL (Qualified Products List) – A list of approved fuses and holders that meet various Military specifications.

Qualified Person – A person who is trained, knowledgeable, and has demonstrated skills on the construction and operation of the equipment, and can recognize and avoid electrical hazards that may be encountered.

Rating – A designated limit of operating characteristics based on definite conditions such as current rating, voltage rating and interrupting rating.

Rectifier Fuse – See Semiconductor Fuse.

Rejection Feature – The physical characteristic(s) of a fuse block or fuse holder that prevents the insertion of a fuse unless it has the proper mating characteristics. This may be achieved through the use of slots, grooves, projections, or the actual physical dimensions of the fuse. This feature prevents the substitution of fuses of a Class or size other than the Class and size intended.

Relay – An electrical switch that opens and closes a contact (or contacts) under the control of another circuit. Typically an electromagnet.

Renewable Element (also Renewable Link) – A renewable fuse current-carrying component that is replaced to restore the fuse to a functional condition after the link opens due to an overcurrent condition.

Renewable Fuse – A fuse that may be readily restored to service by replacing the renewable element after operation.

Resistance-Grounded System – An electrical system in which the transformer or generator neutral is connected to ground through a current-limiting resistor. See Solidly Grounded System, Ungrounded System.

Restricted Approach Boundary – An approach boundary to protect personnel from shock. A boundary distance is established from an energized part based on system voltage. Only qualified persons are allowed in the boundary and they must use the proper PPE.

Selective Coordination (See Figure 15) – In a selectively coordinated system, only the protective device immediately on the line side of an overcurrent opens. Upstream protective devices remain closed. All other equipment remains in service, which simplifies the identification and location of overloaded

TERMS AND DEFINITIONS

equipment or short-circuits. For additional information, refer to the Selective Coordination pages of this Technical Application Guide.

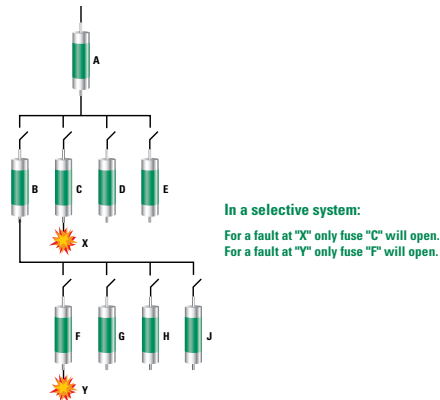

Figure 15 – Selective Coordination Example

Semiconductor Fuse – A fuse specifically designed to protect semiconductors such as silicon rectifiers, silicon-controlled rectifiers, thyristors, transistors, and similar components.

Sensitive Ground-Fault Protection – Protection designed to accurately detect extremely low ground-fault current levels without nuisance tripping.

Shock – A trauma subjected to the body by electrical current. When personnel come in contact with energized conductors, it can result in current flowing through their body often causing serious injury or death.

Short-Circuit (See *Figure 16*) – A current flowing outside its normal path, caused by a breakdown of insulation or by faulty equipment connections. In a short-circuit, current bypasses the normal load. Current is determined by the system impedance (AC resistance) rather than the load impedance. Short-circuit currents may vary from fractions of an ampere to 200,000 amperes or more.

Short-Circuit Current Rating (SCCR) – The prospective symmetrical fault current at a nominal voltage to which an apparatus or system is able to be connected without sustaining damage exceeding defined acceptance criteria.

Short-Circuit Rating – The maximum RMS symmetrical short-circuit current at which a given piece of equipment has been tested under specified conditions, and which, at the end of the test is in essentially the same condition as prior to the test. Short-circuit ratings (also called withstand ratings) apply to equipment that will be subjected to fault currents, but which are not required to interrupt them. This includes switches, busway (bus duct), switchgear and switchboard structures, motor control centers and transformers.

Most short-circuit ratings are based on tests which last three complete electrical cycles (0.05 seconds). However, if the equipment is protected during the test by fuses or by a circuit breaker with instantaneous trips, the test duration is the time required for the overcurrent protective device to open the circuit.

When protected as such during testing, the equipment instructions and labels must indicate that the equipment shall be protected by a given fuse class and rating or by a specific make, type, and rating of circuit breaker. Circuit breakers equipped with short-delay trip elements instead of instantaneous trip elements have withstand (short-circuit) ratings in addition to their interrupting rating. The breaker must be able to withstand the available fault current during the time that opening is delayed.

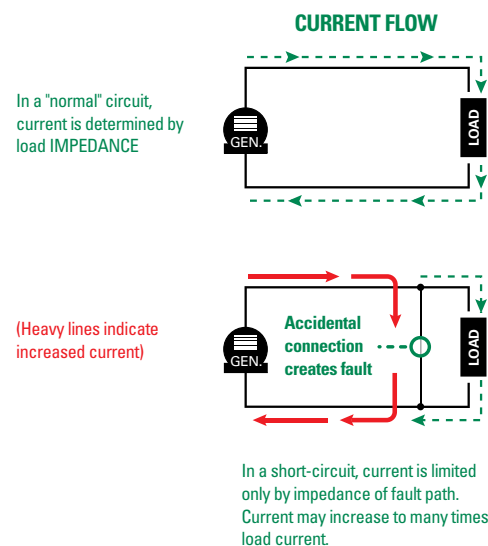

Figure 16 – Current Flow in Normal and Short Circuit Situations

Solidly Grounded System – An electrical system in which the neutral point of a wye connected supply transformer is connected directly to ground.

Symmetrical Current – The terms “Symmetrical Current” and “Asymmetrical Current” describe an AC wave symmetry around the zero axis. The current is symmetrical when the peak currents above and below the zero axis are equal in value, as shown in *Figure 17* (next page). If the peak currents are not equal, as shown in *Figure 18*, the current is considered asymmetrical. The degree of asymmetry during a fault is determined by the change in power factor (X/R) and the point in the voltage wave when the fault occurs. See definition of Power Factor. In general, lower short-circuit power factors increase the degree of asymmetry.

TERMS AND DEFINITIONS

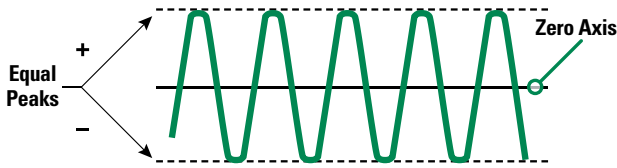

Figure 17 – Symmetrical Current

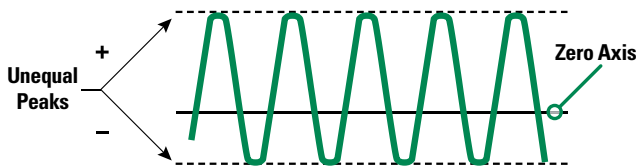

Figure 18 – Asymmetrical Current

Threshold Current – The minimum current for a given fuse size and type at which the fuse becomes current-limiting. It is the lowest value of available rms symmetrical current that will cause the device to begin opening within the first 1/4 cycle (90 electrical degrees) and completely clear the circuit within 1/2 cycle (180 electrical degrees). The approximate threshold current can be determined from the fuse’s peak let-through charts. (See Figure 19.)

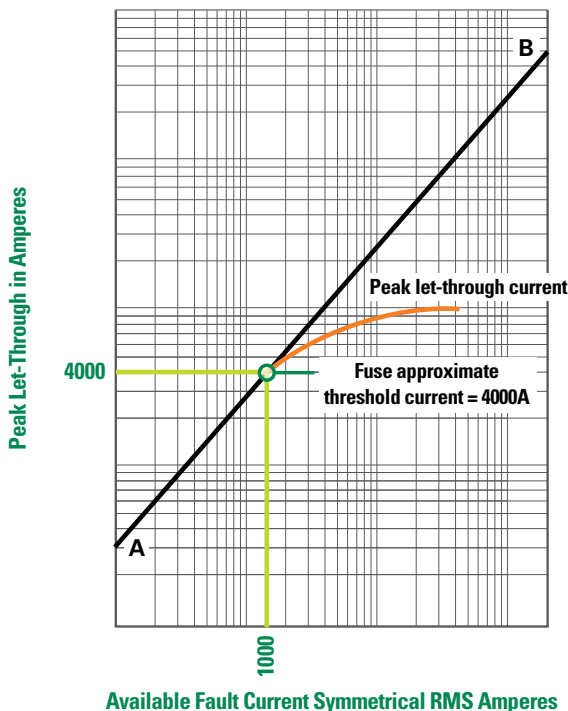

Figure 19 – Determining Threshold Current from Peak Let-through Chart

Threshold Ratio – Consists of the threshold current divided by the ampere rating of a specific type or class of overcurrent device. A fuse with a threshold ratio of 15 becomes current-limiting at 15 times its current rating.

Time-Delay Fuse – Fuses designed with an intentional, built-in delay in opening. When compared to fast-opening fuses, time-delay fuses have an increased opening time for overcurrents between approximately 200% and 600% of the fuse’s current rating. Time-delay is indicated on the fuse label by “Time-Delay”, “T-D”, “D”, or other suitable marking. Time-delay in the overload range (200%-600% of the fuse rating) permits the fuse to withstand system switching surges, motor starting currents, and other harmless temporary overcurrents.

UL Standards require time-delay Class H, K, RK1, RK5, and J fuses to hold 500% of their normal current rating for a minimum of 10 seconds. They must also pass the same opening time tests (135% and 200% of current rating) as fast acting fuses.

Time-delay Class CC, CD, G, Plug, and Miscellaneous fuses have different requirements. For more information, please refer to the corresponding descriptions provided in the Product Information Section.

For the UL Standard, Class L fuses have no standard time-delay. The time-delay varies from series to series for a given manufacturer, as well as from manufacturer to manufacturer. For reference, Littelfuse KLPC series POWR-PRO® fuses hold 500% of rated current for a minimum of 10 seconds.

Ungrounded System – An electrical system in which no point in the system is intentionally grounded. This was most common in process industries where continuity of service during a single-phase-to-ground-fault was required.

Unqualified Person – A person that does not possess all the skills and knowledge or has not been trained for a particular task.

Voltage Rating – The maximum rms AC voltage and/or the maximum DC voltage at which the fuse is designed to operate. For example, fuses rated 600 volts and below may be applied at any voltage less than their rating. There is no rule for applying AC fuses in DC circuits such as applying the fuse at half its AC voltage rating. Fuses used on DC circuits must have DC ratings.

Withstand Rating – See Short-Circuit.

MOTOR PROTECTION TABLES

Selection of Class RK5 Fuses (FLNR_ID / FLSR_ID / IDSR Series) or POWR-PRO® Class RK1 Fuses (LLNRK / LLSRK / LLSRK_ID Series) Based on Motor Full Load Amps

Using AC Motor Protection Tables to Select Fuse Ratings

Time-delay RK1 and RK5 fuse ratings selected in accordance with the following recommendations also meet NEC® requirements for Motor Branch circuit and Short-Circuit Protection.

Selecting Fuses for Motor Running Protection Based on Motor Horsepower

Motor horsepower and motor Full Load Amperes (FLA) shown are taken from NEC Tables 430.248 through 430.250 covering standard speed AC motors with normal torque characteristics. Fuse ratings for motors with special characteristics may need to vary from given values.

If motor running protection will be provided by the fuses, select fuse ratings for correct type of motor from Motor Protection Table Columns headed, "Without Overload Relays."

If overload relays will provide principal motor running protection, select fuse ratings for correct type of motor from Motor Protection Table Columns headed, "Back-up Running Protection" or "With Overload Relays." Fuse ratings selected from these columns coordinate with most UL Class 10 and 20 overload relays which covers over 90% of motor applications.

Selecting Fuses for Motor Running Protection Based on Motor Actual Full Load Currents

Better protection is achieved when fuse ratings are based on motor actual FLA obtained from motor nameplates. Locate motor nameplate FLA in the column appropriate for the type of motor and type of protection required. Then select the corresponding ampere rating of the fuse from the first column of that line.

| TIME DELAY UL CLASS RK1 OR RK5 FUSE AMPERE RATING | MOTOR RUNNING PROTECTION (USED WITHOUT PROPERLY SIZED OVERLOAD RELAYS) MOTOR FULL-LOAD AMPS | | BACK-UP MOTOR RUNNING PROTECTION (USED WITH PROPERLY SIZED OVERLOAD RELAYS) MOTOR FULL-LOAD AMPS | |
|---|---|---|--|---|
| | MOTOR SERVICE FACTOR OF 1.15 OR GREATER OR WITH TEMP. RISE NOT OVER 40°C. | MOTOR SERVICE FACTOR LESS THAN 1.15 OR WITH TEMP. RISE GREATER THAN 40°C. | MOTOR SERVICE FACTOR OF 1.15 OR GREATER OR WITH TEMP. RISE NOT OVER 40°C. | MOTOR SERVICE FACTOR LESS THAN 1.15 OR WITH TEMP. RISE GREATER THAN 40°C. |
| 1/10 | 0.08-0.09 | 0.09-0.10 | 0-0.08 | 0-0.09 |
| 1/8 | 0.10-0.11 | 0.11-0.125 | 0.09-0.10 | 0.10-0.11 |
| 15/100 | 0.12-0.15 | 0.14-0.15 | 0.11-0.12 | 0.12-0.13 |
| 2/10 | 0.16-0.19 | 0.18-0.20 | 0.13-0.16 | 0.14-0.17 |
| 3/4 | 0.20-0.23 | 0.22-0.25 | 0.17-0.20 | 0.18-0.22 |
| 3/10 | 0.24-0.30 | 0.27-0.30 | 0.21-0.24 | 0.23-0.26 |
| 4/10 | 0.32-0.39 | 0.35-0.40 | 0.25-0.32 | 0.27-0.35 |
| 1/2 | 0.40-0.47 | 0.44-0.50 | 0.33-0.40 | 0.36-0.43 |
| 6/10 | 0.48-0.60 | 0.53-0.60 | 0.41-0.48 | 0.44-0.52 |
| 8/10 | 0.64-0.79 | 0.70-0.80 | 0.49-0.64 | 0.53-0.70 |
| 1 | 0.80-0.89 | 0.87-0.97 | 0.65-0.80 | 0.71-0.87 |
| 1 1/8 | 0.90-0.99 | 0.98-1.08 | 0.81-0.90 | 0.88-0.98 |
| 1 1/4 | 1.00-1.11 | 1.09-1.21 | 0.91-1.00 | 0.99-1.09 |
| 1 1/10 | 1.12-1.19 | 1.22-1.30 | 1.01-1.12 | 1.10-1.22 |
| 1 1/2 | 1.20-1.27 | 1.31-1.39 | 1.13-1.20 | 1.23-1.30 |
| 1 9/10 | 1.28-1.43 | 1.40-1.56 | 1.21-1.28 | 1.31-1.39 |
| 1 7/10 | 1.44-1.59 | 1.57-1.73 | 1.29-1.44 | 1.40-1.57 |
| 2 | 1.60-1.79 | 1.74-1.95 | 1.45-1.60 | 1.58-1.74 |
| 2 1/4 | 1.80-1.99 | 1.96-2.17 | 1.61-1.80 | 1.75-1.96 |
| 2 1/2 | 2.00-2.23 | 2.18-2.43 | 1.81-2.00 | 1.97-2.17 |
| 2 9/10 | 2.24-2.39 | 2.44-2.60 | 2.01-2.24 | 2.18-2.43 |
| 3 | 2.40-2.55 | 2.61-2.78 | 2.25-2.40 | 2.44-2.60 |
| 3 1/10 | 2.56-2.79 | 2.79-3.04 | 2.41-2.56 | 2.61-2.78 |
| 3 1/2 | 2.80-3.19 | 3.05-3.47 | 2.57-2.80 | 2.79-3.04 |
| 4 | 3.20-3.59 | 3.48-3.91 | 2.81-3.20 | 3.05-3.48 |
| 4 1/2 | 3.60-3.99 | 3.92-4.34 | 3.21-3.60 | 3.49-3.91 |
| 5 | 4.00-4.47 | 4.35-4.86 | 3.61-4.00 | 3.92-4.35 |
| 5 1/10 | 4.48-4.79 | 4.87-5.21 | 4.01-4.48 | 4.36-4.87 |
| 6 | 4.80-4.99 | 5.22-5.43 | 4.49-4.80 | 4.88-5.22 |
| 6 1/4 | 5.00-5.59 | 5.44-6.08 | 4.81-5.00 | 5.23-5.43 |
| 7 | 5.60-5.99 | 6.09-6.52 | 5.01-5.60 | 5.44-6.09 |
| 7 1/2 | 6.00-6.39 | 6.53-6.95 | 5.61-6.00 | 6.10-6.52 |
| 8 | 6.40-7.19 | 6.96-7.82 | 6.01-6.40 | 6.53-6.96 |
| 9 | 7.20-7.99 | 7.83-8.69 | 6.41-7.20 | 6.97-7.83 |
| 10 | 8.00-9.59 | 8.70-10.00 | 7.21-8.00 | 7.84-8.70 |
| 12 | 9.60-11.99 | 10.44-12.00 | 8.01-9.60 | 8.71-10.43 |
| 15 | 12.00-13.99 | 13.05-15.00 | 9.61-12.00 | 10.44-13.04 |
| 17 1/2 | 14.00-15.99 | 15.22-17.39 | 12.01-14.00 | 13.05-15.21 |
| 20 | 16.00-19.99 | 17.40-20.00 | 14.01-16.00 | 15.22-17.39 |
| 25 | 20.00-23.99 | 21.74-25.00 | 16.01-20.00 | 17.40-21.74 |
| 30 | 24.00-27.99 | 26.09-30.00 | 20.01-24.00 | 21.75-26.09 |
| 35 | 28.00-31.99 | 30.44-34.78 | 24.01-28.00 | 26.10-30.43 |
| 40 | 32.00-35.99 | 34.79-39.12 | 28.01-32.00 | 30.44-37.78 |
| 45 | 36.00-39.99 | 39.13-43.47 | 32.01-36.00 | 37.79-39.13 |
| 50 | 40.00-47.99 | 43.48-50.00 | 36.01-40.00 | 39.14-43.48 |
| 60 | 48.00-55.99 | 52.17-60.00 | 40.01-48.00 | 43.49-52.17 |
| 70 | 56.00-59.99 | 60.87-65.21 | 48.01-56.00 | 52.18-60.87 |
| 75 | 60.00-63.99 | 65.22-69.56 | 56.01-60.00 | 60.88-65.22 |
| 80 | 64.00-71.99 | 69.57-78.25 | 60.01-64.00 | 65.23-69.57 |
| 90 | 72.00-79.99 | 78.26-86.95 | 64.01-72.00 | 69.58-78.26 |
| 100 | 80.00-87.99 | 86.96-95.64 | 72.01-80.00 | 78.27-86.96 |
| 110 | 88.00-99.99 | 95.65-108.69 | 80.01-88.00 | 86.97-95.65 |
| 125 | 100.00-119.99 | 108.70-125.00 | 88.01-100.00 | 95.66-108.70 |
| 150 | 120.00-139.99 | 131.30-150.00 | 100.01-120.00 | 108.71-130.43 |
| 175 | 140.00-159.99 | 152.17-173.90 | 120.01-140.00 | 130.44-152.17 |
| 200 | 160.00-179.99 | 173.91-195.64 | 140.01-160.00 | 152.18-173.91 |
| 225 | 180.00-199.99 | 195.65-217.38 | 160.01-180.00 | 173.92-195.62 |
| 250 | 200.00-239.99 | 217.39-250.00 | 180.01-200.00 | 195.63-217.39 |
| 300 | 240.00-279.99 | 260.87-300.00 | 200.01-240.00 | 217.40-260.87 |
| 350 | 280.00-319.99 | 304.35-347.82 | 240.01-280.00 | 260.88-304.35 |
| 400 | 320.00-359.99 | 347.83-391.29 | 280.01-320.00 | 304.36-347.83 |
| 450 | 360.00-399.99 | 391.30-434.77 | 320.01-360.00 | 347.84-391.30 |
| 500 | 400.00-479.99 | 434.78-500.00 | 360.01-400.00 | 391.31-434.78 |
| 600 | 480.00-600.00 | 521.74-600.00 | 400.01-480.00 | 434.79-521.74 |



Motor Protection White Paper

Download our white paper on motor protection at littelfuse.com/technicalcenter

MOTOR PROTECTION TABLES

Selection of Class RK5 Fuses (FLNR_ID / FLRS_ID / IDSR Series) or POWR-PRO® Class RK1 Fuses (LLNRK / LLSRK / LLSRK_ID Series) Based on Motor Horsepower

| MOTOR HP | FULL LOAD AMPS | WITHOUT OVERLOAD RELAYS | | WITH OVERLOAD RELAYS | | SWITCH OR FUSE CLIP RATING |
|---|----------------|--|---|--|---|----------------------------|
| | | S.F. = 1.15 OR MORE, TEMP RISE NOT OVER 40°C | S.F. = LESS THAN 1.15 OR TEMP RISE MORE THAN 40°C | S.F. = 1.15 OR MORE, TEMP RISE NOT OVER 40°C | S.F. = LESS THAN 1.15 OR TEMP RISE MORE THAN 40°C | |
| 120 VOLT 1-PHASE MOTORS (120V CIRCUIT) | | | | | | |
| 1/8 | 4.4 | 5 | 5 | 5 ^{9/10} | 5 ^{9/10} | 30 |
| 1/4 | 5.8 | 7 | 6 ^{1/4} | 7 ^{1/2} | 7 | 30 |
| 1/2 | 7.2 | 9 | 8 | 9 | 9 | 30 |
| 3/4 | 9.8 | 12 | 10 | 15 | 12 | 30 |
| 1 | 13.8 | 15 | 15 | 17 ^{1/2} | 17 ^{1/2} | 30 |
| 1 1/2 | 16 | 20 | 17 ^{1/2} | 20 | 20 | 30 |
| 2 | 20 | 25 | 20 | 25 | 25 | 30 |
| 3 | 24 | 30 | 25 | 30 | 30 | 30 |
| 230 VOLT 1-PHASE MOTORS (240V CIRCUIT) | | | | | | |
| 1/8 | 2.2 | 2 ^{1/2} | 2 ^{1/2} | 2 ^{9/10} | 2 ^{9/10} | 30 |
| 1/4 | 2.9 | 3 ^{1/2} | 3 ^{1/10} | 4 | 3 ^{1/2} | 30 |
| 1/2 | 3.6 | 4 ^{1/2} | 4 | 4 ^{1/2} | 4 ^{1/2} | 30 |
| 3/4 | 4.9 | 5 ^{9/10} | 5 ^{9/10} | 6 ^{1/4} | 6 | 30 |
| 1 | 6.9 | 8 | 7 ^{1/2} | 9 | 8 | 30 |
| 1 1/2 | 8 | 10 | 9 | 10 | 10 | 30 |
| 2 | 10 | 12 | 10 | 15 | 12 | 30 |
| 3 | 12 | 15 | 12 | 15 | 15 | 30 |
| 5 | 17 | 20 | 17 ^{1/2} | 25 | 20 | 30 |
| 7 1/2 | 28 | 35 | 30* | 35 | 35 | 60 |
| 10 | 40 | 50 | 45 | 50 | 50 | 60 |
| 15 | 50 | 60 | 50 | 70 | 60 | 60 |
| 200 VOLT 3-PHASE MOTORS (208V CIRCUIT) | | | | | | |
| 1/2 | 2.5 | 3 | 2 ^{9/10} | 3 ^{1/10} | 3 | 30 |
| 3/4 | 3.7 | 4 ^{1/2} | 4 | 5 | 4 ^{1/2} | 30 |
| 1 | 4.8 | 6 | 5 ^{9/10} | 6 ^{1/4} | 6 | 30 |
| 1 1/2 | 6.9 | 8 | 7 ^{1/2} | 7 ^{1/2} | 8 | 30 |
| 2 | 7.8 | 9 | 8 | 10 | 9 | 30 |
| 3 | 11 | 12 | 12 | 15 | 15 | 30 |
| 5 | 17.5 | 20 | 20 | 25 | 25 | 30 |
| 7 1/2 | 25.3 | 30* | 25* | 35 | 30* | 60 |
| 10 | 32.2 | 40 | 35 | 45 | 40 | 60 |
| 15 | 48.3 | 60 | 50 | 70† | 60 | 60 |
| 20 | 62.1 | 75 | 70 | 80 | 75 | 100 |
| 25 | 78.2 | 90 | 80 | 100 | 90 | 100 |
| 30 | 92 | 110 | 100* | 125 | 110 | 200 |
| 40 | 120 | 150 | 125 | 150 | 150 | 200 |
| 50 | 150 | 175 | 150 | 200 | 175 | 200 |
| 60 | 177 | 200* | 200* | 225 | 225 | 400 |
| 75 | 221 | 250 | 250 | 300 | 300 | 400 |
| 100 | 285 | 350 | 300 | 400 | 350 | 400 |
| 125 | 359 | 400* | 400* | 450 | 450 | 600 |
| 150 | 414 | 500 | 450 | 600 | 500 | 600 |
| 230 VOLT 3-PHASE MOTORS (240V CIRCUIT) | | | | | | |
| 1/2 | 2.2 | 2 ^{9/10} | 2 ^{1/2} | 2 ^{9/10} | 2 ^{9/10} | 30 |
| 3/4 | 3.2 | 4 | 3 ^{1/2} | 4 | 4 | 30 |
| 1 | 4.2 | 5 | 4 ^{1/2} | 5 ^{9/10} | 5 | 30 |
| 1 1/2 | 6.0 | 7 ^{1/2} | 6 ^{1/4} | 7 ^{1/2} | 7 ^{1/2} | 30 |
| 2 | 6.8 | 8 | 7 ^{1/2} | 9 | 8 | 30 |
| 3 | 9.6 | 12 | 10 | 12 | 12 | 30 |
| 5 | 15.2 | 17 ^{1/2} | 17 ^{1/2} | 20 | 17 ^{1/2} | 30 |
| 7 1/2 | 22 | 25 | 25 | 30 | 30 | 30 |
| 10 | 28 | 35 | 30* | 35 | 35 | 60 |
| 15 | 42 | 50 | 45 | 60 | 50 | 60 |
| 20 | 54 | 60* | 60* | 70 | 70 | 100 |
| 25 | 68 | 80 | 75 | 90 | 80 | 100 |
| 30 | 80 | 100 | 90 | 100 | 100 | 100 |
| 40 | 104 | 125 | 110 | 150 | 125 | 200 |
| 50 | 130 | 150 | 150 | 175 | 150 | 200 |
| 60 | 154 | 175 | 175 | 200 | 200 | 200 |
| 75 | 192 | 225 | 200* | 250 | 225 | 400 |
| 100 | 248 | 300 | 250 | 350 | 300 | 400 |
| 125 | 312 | 350 | 350 | 400 | 400 | 400 |
| 150 | 360 | 450 | 400* | 450 | 450 | 600 |
| 200 | 480 | 600 | 500 | 600 | 600 | 600 |

| MOTOR HP | FULL LOAD AMPS | WITHOUT OVERLOAD RELAYS | | WITH OVERLOAD RELAYS | | SWITCH OR FUSE CLIP RATING |
|---|----------------|--|---|--|---|----------------------------|
| | | S.F. = 1.15 OR MORE, TEMP RISE NOT OVER 40°C | S.F. = LESS THAN 1.15 OR TEMP RISE MORE THAN 40°C | S.F. = 1.15 OR MORE, TEMP RISE NOT OVER 40°C | S.F. = LESS THAN 1.15 OR TEMP RISE MORE THAN 40°C | |
| 460 VOLT 3-PHASE MOTORS (480V CIRCUIT) | | | | | | |
| 1/2 | 1.1 | 1 ^{1/10} | 1 ^{1/4} | 1 ^{1/10} | 1 ^{1/10} | 30 |
| 3/4 | 1.6 | 2 | 1 ^{9/10} | 2 | 2 | 30 |
| 1 | 2.1 | 2 ^{1/2} | 2 ^{1/4} | 2 ^{9/10} | 2 ^{1/2} | 30 |
| 1 1/2 | 3.0 | 3 ^{1/2} | 3 ^{3/10} | 4 | 3 ^{1/2} | 30 |
| 2 | 3.4 | 4 | 3 ^{1/2} | 4 ^{1/2} | 4 | 30 |
| 3 | 4.8 | 5 ^{9/10} | 5 | 6 | 5 ^{9/10} | 30 |
| 5 | 7.6 | 9 | 8 | 10 | 9 | 30 |
| 7 1/2 | 11 | 12 | 12 | 15 | 15 | 30 |
| 10 | 14 | 17 ^{1/2} | 15 | 17 ^{1/2} | 17 ^{1/2} | 30 |
| 15 | 21 | 25 | 20 | 30 | 25 | 30 |
| 20 | 27 | 30* | 30* | 35 | 35 | 60 |
| 25 | 34 | 40 | 35 | 45 | 40 | 60 |
| 30 | 40 | 50 | 45 | 50 | 50 | 60 |
| 40 | 54 | 60* | 60* | 70 | 60* | 100 |
| 50 | 65 | 80 | 70 | 90 | 75 | 100 |
| 60 | 77 | 90 | 80 | 100 | 90 | 100 |
| 75 | 96 | 110 | 110 | 125 | 125 | 200 |
| 100 | 124 | 150 | 125 | 175 | 150 | 200 |
| 125 | 156 | 175 | 175 | 200 | 200 | 200 |
| 150 | 180 | 225 | 200* | 225 | 225 | 400 |
| 200 | 240 | 300 | 250 | 300 | 300 | 400 |
| 575 VOLT 3-PHASE MOTORS (600V CIRCUIT) | | | | | | |
| 1/2 | 0.9 | 1 ^{1/8} | 1 | 1 ^{1/8} | 1 ^{1/8} | 30 |
| 3/4 | 1.3 | 1 ^{9/10} | 1 ^{1/10} | 1 ^{9/10} | 1 ^{9/10} | 30 |
| 1 | 1.7 | 2 | 1 ^{9/10} | 2 ^{1/4} | 2 | 30 |
| 1 1/2 | 2.4 | 3 | 2 ^{1/2} | 3 | 3 | 30 |
| 2 | 2.7 | 3 ^{1/10} | 2 ^{9/10} | 3 ^{1/2} | 3 ^{1/10} | 30 |
| 3 | 3.9 | 4 ^{1/2} | 4 | 5 | 4 ^{1/2} | 30 |
| 5 | 6.1 | 7 ^{1/2} | 7 | 8 | 7 ^{1/2} | 30 |
| 7 1/2 | 9 | 10 | 10 | 12 | 12 | 30 |
| 10 | 11 | 12 | 12 | 15 | 15 | 30 |
| 15 | 17 | 20 | 17 ^{1/2} | 25 | 20 | 30 |
| 20 | 22 | 25 | 25 | 30 | 30 | 30 |
| 25 | 27 | 30* | 30* | 35 | 35 | 60 |
| 30 | 32 | 40 | 35 | 40 | 40 | 60 |
| 40 | 41 | 50 | 45 | 60 | 50 | 60 |
| 50 | 52 | 60 | 60 | 70† | 60 | 60 |
| 60 | 62 | 75 | 70 | 80 | 75 | 100 |
| 75 | 77 | 90 | 80 | 100 | 90 | 100 |
| 100 | 99 | 110 | 110 | 125 | 125 | 200 |
| 125 | 125 | 150 | 125 | 175 | 150 | 200 |
| 150 | 144 | 175 | 150 | 200 | 175 | 200 |
| 200 | 192 | 225 | 200* | 250 | 225 | 400 |

NOTES

S.F. = Motor Service Factor
* Fuse Reducers Required
† 100 Amp Switch Required



Motor Protection White Paper

Download our white paper on motor protection at littelfuse.com/technicalcenter

MOTOR PROTECTION TABLES

Selection of POWR-PRO® Class J Fuses (JTD_ID / JTD Series) Based on Motor Full Load Amps

| MOTOR F.L.A. | JTD_ID / JTD AMPERE RATING | MOTOR F.L.A. | JTD_ID / JTD AMPERE RATING | MOTOR F.L.A. | JTD_ID / JTD AMPERE RATING |
|--------------|----------------------------|--------------|----------------------------|--------------|----------------------------|
| 0.00 – 0.60 | 3/10 | 12.1 – 14.5 | 17 1/2 | 76.1 – 84.0 | 110 |
| 0.61 – 0.80 | 1 | 14.6 – 17.0 | 20 | 84.1 – 90.0 | 125 |
| 0.81 – 1.00 | 1 1/4 | 17.1 – 21.0 | 25 | 90.1 – 102 | 150 |
| 1.01 – 1.20 | 1 1/2 | 21.1 – 25.0 | 30 | 103 – 125 | 175 |
| 1.21 – 1.65 | 2 | 25.1 – 28.5 | 35 | 126 – 144 | 200 |
| 1.66 – 2.00 | 2 1/2 | 28.6 – 34.0 | 40 | 145 – 162 | 225 |
| 2.01 – 2.40 | 3 | 34.1 – 37.0 | 45 | 163 – 180 | 250 |
| 2.41 – 3.30 | 4 | 37.1 – 41.0 | 50 | 181 – 204 | 300 |
| 3.31 – 4.10 | 5 | 41.1 – 48.0 | 60 | 205 – 240 | 350 |
| 4.11 – 4.90 | 6 | 48.1 – 52.0 | 70 | 241 – 288 | 400 |
| 4.91 – 6.40 | 8 | 52.1 – 59.0 | 80 | 289 – 312 | 450 |
| 6.41 – 8.00 | 10 | 59.1 – 66.0 | 90 | 313 – 360 | 500 |
| 8.01 – 9.80 | 12 | 66.1 – 76.0 | 100 | 361 – 432 | 600 |
| 9.81 – 12.0 | 15 | | | | |

NOTE: For severe motor starting conditions, fuses may be sized up to 225% motor F.L.A. (See NEC® Article 430.52 for Exceptions)

Selection of CCMR Time-Delay Fuses Based on Motor Full Load Amps

| MOTOR FULL LOAD CURRENT (F.L.A.) | | | | | | CCMR AMPERE RATING |
|---|----------------|---|----------------|---|----------------|--------------------|
| FOR MOTORS WITH AN ACCELERATION TIME OF 2 SECONDS OR LESS | | FOR MOTORS WITH AN ACCELERATION TIME OF 5 SECONDS OR LESS | | FOR MOTORS WITH AN ACCELERATION TIME OF 8 SECONDS OR LESS | | |
| MIN. F.L.A. (1) | MAX F.L.A. (3) | MIN. F.L.A. (1) | MAX F.L.A. (3) | MIN F.L.A. (2) | MAX F.L.A. (3) | |
| 0.2 | 0.2 | 0.2 | 0.2 | 0.2 | 0.2 | 3/10 |
| 0.3 | 0.4 | 0.3 | 0.4 | 0.3 | 0.3 | 1/2 |
| 0.4 | 0.6 | 0.4 | 0.5 | 0.4 | 0.5 | 5/10 |
| 0.5 | 0.7 | 0.5 | 0.6 | 0.5 | 0.6 | 1 |
| 0.6 | 1.0 | 0.6 | 0.9 | 0.6 | 0.8 | 1 1/4 |
| 0.8 | 1.1 | 0.8 | 1.0 | 0.7 | 0.9 | 1 1/2 |
| 0.9 | 1.3 | 0.9 | 1.1 | 0.8 | 1.0 | 1 5/10 |
| 1.1 | 1.4 | 1.1 | 1.2 | 0.9 | 1.1 | 2 |
| 1.2 | 2.1 | 1.2 | 2.1 | 1.2 | 1.8 | 2 1/2 |
| 1.5 | 2.6 | 1.5 | 2.6 | 1.4 | 2.3 | 3 |
| 1.8 | 3.0 | 1.8 | 3.0 | 1.6 | 2.6 | 3 1/2 |
| 2.1 | 3.4 | 2.1 | 3.2 | 1.8 | 2.8 | 4 |
| 2.3 | 3.9 | 2.3 | 3.3 | 2.0 | 2.8 | 4 1/2 |
| 2.6 | 4.3 | 2.6 | 3.4 | 2.3 | 2.8 | 5 |
| 2.9 | 4.8 | 2.9 | 3.7 | 2.5 | 3.1 | 5 5/10 |
| 3.3 | 5.2 | 3.3 | 4.0 | 2.7 | 3.4 | 6 |
| 3.5 | 5.4 | 3.5 | 4.1 | 2.8 | 3.5 | 6 1/4 |
| 3.6 | 5.7 | 3.6 | 4.2 | 3.2 | 3.7 | 7 |
| 4.1 | 5.8 | 4.1 | 4.3 | 3.4 | 3.8 | 7 1/2 |
| 4.3 | 6.2 | 4.3 | 4.6 | 3.6 | 4.2 | 8 |
| 4.6 | 6.9 | 4.6 | 5.2 | 4.0 | 4.5 | 9 |
| 5.2 | 7.7 | 5.2 | 5.8 | 4.5 | 4.9 | 10 |
| 5.8 | 8.9 | 5.8 | 6.6 | 5.4 | 5.5 | 12 |
| 6.9 | 10.0 | 6.9 | 7.7 | 6.7 | 6.7 | 15 |
| 8.9 | 13.5 | 8.9 | 10.0 | 6.8 | 9.0 | 20 |
| 11.5 | 15.8 | 11.2 (2) | 11.8 | 9.0 | 11.0 | 25 |
| 14.3 | 17.8 | 13.4 (2) | 13.4 | 10.0 | 15.0 | 30 |
| 20.7 | 23.3 | 16.1 | 17.9 | 15.6 | 15.9 | 35 |
| 23.7 | 26.7 | 18.4 | 20.5 | 17.8 | 18.2 | 40 |
| 26.6 | 30.0 | 20.7 | 23.1 | 20.0 | 20.4 | 45 |
| 30.0 | 33.3 | 23.0 | 25.6 | 22.3 | 22.7 | 50 |
| 35.5 | 40.0 | 27.6 | 30.1 | 26.7 | 27.3 | 60 |

- 1 Based on NEC requirement limiting the rating of time-delay fuses to 175% of motor F.L.A., or next higher rating.
- 2 Based on NEC exception permitting fuse rating to be increased, but not to exceed, 225% motor F.L.A., however per NEC Article 430.52 Class CC (0-30) fuses can now be sized up to 400% of motor F.L.A.
- 3 Based on Littelfuse CCMR time-delay characteristics.

NOTE: These values were calculated for motors with Locked Rotor Current (LRA), not exceeding the following values:

| MOTOR F.L.A. | *LRA |
|--------------|------|
| 0.00 – 1.00 | 850% |
| 1.01 – 2.00 | 750% |
| 2.01 – 10.0 | 650% |
| 10.1 – 17.8 | 600% |

*If motor LRA varies from these values, contact Littelfuse.

ALPHANUMERIC INDEX

| Product Name | Page Number | Product Name | Page Number | Product Name | Page Number |
|---------------------------|---------------|------------------------------|-------------|-----------------------|-------------|
| Alarm Monitoring | 172 | Fuse Blocks, Fuse Holders | 80-121 | LET Series | 132 |
| Arc-Flash | 161, 202 | Fuse Classifications | 200 | LEX Series | 132 |
| ATO Series | 38 | Fuseology | 189 | LEX YY Series | 136 |
| BLF Series | 32 | Fuse Reducers | 185 | LEXT YY Series | 132 |
| BLN Series | 32 | G2000 | 162 | LEY Series | 132 |
| BLS Series | 33 | G3000 | 162 | LFC600 | 99 |
| Box Cover Units | 186 | G3300 | 163 | LF Series Covers | 103 |
| Bolt-Down Fuses | 63 | Generator Protection/Control | 162-170 | LFCL Series | 165 |
| Bus Bar Series | 110 | GDB Series | 128 | LFFB003 | 116 |
| C6200 | 170 | GFP | 114 | LFG480, LFG600 Series | 97 |
| Cable Limiters | 65 | Ground-Fault Protection | 152-154 | LFH250, LFH600 Series | 86 |
| CCMR Series | 29 | H4000 | 173 | LFJ 1000V Series | 104 |
| Class CC | 29-31, 99-100 | HAZGARD™ | 62 | LFJ600 Series | 83 |
| Class CD | 29-31, 99-100 | IDSR Series | 17 | LFPHV | 112 |
| Class G | 28, 97 | Industrial Shock-Block | 161 | LFPSJ | 113 |
| Class H | 22, 86-91 | In-Line Fuse Holders | 131 | LFR250, LFR600 Series | 86 |
| Class J | 23-25, 82-85 | International Products | 180 | LFT300, LFT600 Series | 92 |
| Class K5 | 21, 86-91 | JCASE Series | 39 | LGR Series | 64 |
| Class L | 9-13 | JLLN Series | 26 | LHFB | 116 |
| Class RK1 | 14-16, 86-91 | JLLS Series | 26 | LHR Series | 64 |
| Class RK5 | 17-20, 86-91 | JLS Series | 24 | Live Parts | 50 |
| Class T | 26-27, 92-96 | JTD/JTD_ID Series | 23 | LKN Series | 22 |
| CNL Series | 62 | KLC Series | 66 | LKS Series | 22 |
| CNN / CNN/E Series | 62 | KLDR Series | 30 | LLNRK Series | 14 |
| Controls | 147 | KLK Series | 32 | LLSRK/LLSRK_ID Series | 14 |
| Coordination Panels | 140 | KLKD Series | 32 | LMF Series | 64 |
| CYHP001 | 183 | KLKR Series | 30 | LPBC Series | 122 |
| Cylindrical Fuses | 183 | KLLU Series | 10 | LPPF Series | 114 |
| D0900 | 161 | KLNR Series | 15 | LPHV Series | 109 |
| Definitions | 204 | KLPC Series | 9 | LPMP Series | 144 |
| Distribution Blocks | 122 | KLQ Series | 32 | LPS | 142 |
| E5000 | 171 | KLSR Series | 15 | LPSC Series | 108 |
| E7800 | 168 | L15S Series | 66 | LPSM Series | 108 |
| EL731 | 154 | L17T Series | 52 | LRU Series | 185 |
| Electrical Safety | 202 | L25S Series | 66 | LS Series | 122 |
| Electronic Fuses | 35-37 | L50S Series | 66 | LSCR Series | 120 |
| Engine Controls/Diagnosis | 171 | L60030C, L60030M Series | 99 | LSCY | 186 |
| EngineEye | 171 | L60030MPCB | 101 | LSKA | 186 |
| E-Rated Fuses | 44-48 | L60S Series | 66 | LSOU | 186 |
| European Fuses | 180 | L70S Series | 66 | LSOW | 186 |
| FBDIN1 | 102 | LA15QS Series | 68 | LSOX | 186 |
| Feeder Protection | 160 | LA30QS Series | 69 | LSOY | 186 |
| FLA Series | 33 | LA50QS Series | 70 | LSOY-B | 186 |
| FlexGen | 170 | LA60Q Series | 71 | LSRU | 186 |
| FLM Series | 32 | LA70QS Series | 71 | LSRW | 186 |
| FLNR Series | 18 | LA100P Series | 73 | LSRX | 186 |
| FLNR_ID Series | 18 | LA070URD Series | 74 | LSRY | 186 |
| FLQ Series | 32 | LA130URD Series | 74 | LSSU | 186 |
| FLSR Series | 18 | LCC Series | 114 | LSSW | 186 |
| FLSR_ID Series | 18 | LCP Series | 140 | LSSX | 186 |
| FLU Series | 33 | LD Series | 122 | LSSY | 186 |
| Fork-Lift Fuses | 62 | LDC Series | 11 | LSTY | 186 |
| FPS | 160 | LEB Series | 132 | LTFD Series | 56 |
| FPU-32 | 160 | LEC Series | 132 | LVSP Series | 179 |

ALPHANUMERIC INDEX

| Product Name | Page Number | Product Name | Page Number | Product Name | Page Number |
|--------------------------|-------------|---------------------------|-------------|--------------|-------------|
| M1000 | 172 | SE-502 | 157 | 229 Series | 36 |
| M2000 | 171 | SE-601 | 152 | 230 Series | 36 |
| M2500 | 171 | SE-701 | 153 | 235 Series | 37 |
| M3000 | 172 | SE-703 | 153 | 239 Series | 37 |
| M4200 | 172 | SE-704 | 153 | 251 Series | 35 |
| M4500 | 173 | Semiconductor Fuses | 66 | 257 Series | 38 |
| M4600 | 173 | Sigma | 170 | 273 Series | 35 |
| M4700 | 173 | SLC Series | 28 | 297 Series | 38 |
| M8100 | 169 | Solar Fuses | 58-61 | 299 Series | 38 |
| MAXI Series | 38 | SPF Series | 60 | 312 Series | 36 |
| Medium Voltage | 40-50 | SPFJ Series | 61 | 313 Series | 36 |
| MEGA Series | 63 | SPL001 | 103 | 314 Series | 36 |
| MFP | 114 | Splicer Blocks | 122 | 315 Series | 36 |
| Midget Fuses | 32-33 | Stud-Mounted Fuse Blocks | 120 | 318 Series | 36 |
| MINI Series | 38 | Suppression Products | 177 | 324 Series | 36 |
| Motor Protection | 158-159 | T2000 | 163 | 325 Series | 36 |
| MOV | 177 | T2100 | 163 | 326 Series | 36 |
| MPS | 159 | T2200 | 164 | 342 Series | 118 |
| MPU-32 | 159 | T2300 | 164 | 345 Series | 119 |
| MROplus | 3 | T2400 | 164 | 354 Series | 115 |
| NH Fuse Links | 181 | T2500 | 165 | 451 Series | 35 |
| NLKP Series | 21 | T2600 | 167 | 477 Series | 35 |
| NLN Series | 21 | T2700 | 165 | 481 Series | 50 |
| NLS Series | 21 | T2800 | 154 | 505 Series | 35 |
| Overvoltage Products | 177 | T2900 | 165 | 571 Series | 117 |
| Panel Mount Adapters | 175 | T3000 | 166 | 572 Series | 117 |
| PGN-1000 | 157 | T3100 | 166 | 70 Series | 55 |
| PGN-3000 | 157 | T3200 | 154 | | |
| PGR-3100 | 152 | T3300 | 166 | | |
| PGR-3200 | 152 | T4500 | 167 | | |
| PGR-4300 | 162 | T4800 | 167 | | |
| PGR-6100 | 158 | T4900 | 168 | | |
| PGR-6130 | 158 | T5000 | 168 | | |
| PGR-6150 | 158 | T7900 | 169 | | |
| PGR-6800 | 160 | T8400 | 169 | | |
| PGR-8800 | 161 | Technical Information | 188 | | |
| Plug Fuses | 63 | Telecom Fuses | 51-55 | | |
| POWR-PRO® Fuses | 3 | TLN Series | 53 | | |
| Pre-Engineered Solutions | 138-146 | TLO Series | 63 | | |
| Protection Relays | 147 | TLS Series | 54 | | |
| Potential Transformer | 49 | TMOV | 177 | | |
| Pump Protection | 160 | T00 Series | 63 | | |
| Quick-LINK Series | 107 | Trailing Cable Protection | 155 | | |
| Resistance Grounding | 156-157 | Up-LINK™ Series | 107 | | |
| RLN Series | 22 | Varistors | 177 | | |
| RLS Series | 22 | WPB Series | 132 | | |
| R-Rated Fuses | 42 | 150322 | 131 | | |
| S6000 | 170 | 1LFS, 1LS Series | 121 | | |
| SE-105 | 155 | 215 Series | 37 | | |
| SE-134C | 155 | 216 Series | 37 | | |
| SE-145 | 155 | 217 Series | 37 | | |
| SE-325 | 156 | 218 Series | 37 | | |
| SE-330 | 156 | 224 Series | 36 | | |
| SE-330AU | 156 | 225 Series | 36 | | |

CONDENSED CROSS REFERENCE

Power (Electrical) and Electronic Fuses

This cross reference covers the most popular fuses for which there is a similar Littelfuse standard item. Furnished for your convenience, it is meant to serve as a guide only for product selection. We suggest you check all applicable specifications before making substitutions. For special applications, more complete information, and for fuse block and medium voltage fuse cross referencing, visit www.littelfuse.com or call 1-800-TEC-FUSE (1-800-832-3873).

| COMPETITION | LITTELFUSE | COMPETITION | LITTELFUSE | COMPETITION | LITTELFUSE | COMPETITION | LITTELFUSE |
|-------------------|--------------------------|--------------|-------------------------|---|--------------------------|--------------|-------------------------|
| 10K0TN | NLN | CNM | FLM | KAB | L25S | NOS | NLS |
| 10K0TS | NLS | CNQ | FLO | KAC | KLC | NRN | NLN |
| 50K0TN | NLN | CRN-R | FLNR_ID (note 3) | KBH | L50S | NRN (15-60A) | NLKP |
| 50K0TS | NLS | CRS-R | FLSR_ID | KLM | KLKD | NRS | NLS |
| A | 251 | CSF13X | L15S | KLMR | CCMR | OT | NLN |
| A013F | L15S | CSF25X | L25S (AC only) | KLU | KLLU or KLPC | OTM | BLF or BLN |
| A015F | L15S | CSF50P | L50S | KN | KLNR | OTN | NLN |
| A015R | L15S | CSF60C | KLC (AC only) | KON | NLN | OTS | NLS |
| A025F | L25S | CSF60X | L60S (AC only) | KOS | NLS | REN | RLN |
| A050F | L50S | CSF70P | L70S | KRPC (SP) | KLPC | RES | RLS |
| A060F | L60S | CTN-R | KLNR | KRPC-L | KLPC | RF | RLN |
| A060URL | KLK | CTS-R | KLSR | KS | KLSR | RFA | L15S |
| A070F | L70S | EBS | BLS | KTK | KLK | RFC | KLC |
| A13X | L15S | ECNR | FLNR_ID (note 3) | KTKR | KLKR | RFL (750V) | L70S (700 V) |
| A25X | L25S (AC only) | ECSR | FLSR_ID | KTNR | KLNR | RFN (Ferraz) | RLN |
| A2D-R | LLNRK | ELN | LKN | KTSR | KLSR | RFS (Ferraz) | RLS |
| A2K-R | KLNR | ELS | LKS | KTU | KLPC | RFV | L50S |
| A3T | JLLN | ERN | RLN | L | KLLU or KLPC | RHN | KLNR |
| A4BQ | KLPC | ERS | RLS | LCL | KLPC or KLLU | RHS | KLSR |
| A4BT | KLLU or KLPC | FNA | FLA | LCU | KLPC or KLLU | RLN (Ferraz) | LKN |
| A4BY | KLPC or KLLU | FNB | 235 | LENRK | LLNRK | RLS (Ferraz) | LKS |
| A4J | JLS | FNM | FLM | LESRK | LLSRK_ID | S | S00 |
| A50P (type 1 & 4) | L50S | FNQ | FLO | LKN | LKN | SA | SAO |
| A60X | L60S | FNQ-R | KLDR | LKS | LKS | SC | SLC |
| A6D-R | LLSRK_ID (note 4) | FRN-R | FLNR_ID (note 3) | LKU | KLLU | SCLR | KLSR |
| A6K-R | KLSR | FRS-R | FLSR_ID | LONRK | LLNRK | SEC | SLC |
| A6T | JLLS | FWA (note 2) | L15S | LOSrk | LLSRK_ID | SF13X | L15S |
| A70P | L70S | FWH (note 2) | L50S | LPCC | CCMR | SF25X | L25S |
| ACK | CCK | FWP (note 1) | L70S | LPJ (SP) | JTD_ID | SF50P | L50S |
| AG | SLC | FWX (note 1) | L25S | LPNRK (SP) | LLNRK | SF60X | L60S |
| AGA | AGA | GDA | 216 | LPSRK (SP) | LLSRK_ID (note 4) | SF70P | L70S |
| AGC | 312 | GDB | 217 | MCL | KLK | SFE | SFE |
| AGU (1-30A) | BLN | GDC | 218 | MDA | 326 | SL | SLO |
| AGW | AGW | GDL | 313 | MDL | 313 | T | TOO |
| AJT | JTD_ID | GEB | LEB | MDQ | 313 | TJN | JLLN |
| ANL | CNL | GEBN | LET | MDV | 315 | TJS | JLLS |
| ANN | CNN | GFA | 251 | MDX | 313 | TL | TLO |
| ATC | ATO (257) | GFN | FLA | MEN | FLM | TR | FLNR_ID (note 3) |
| AT-DE | FLNR_ID (note 3) | GGC | 312 | MEQ | FLO | TRM | FLM |
| ATDR | CCMR | GGM | 235 | MID | FLA | TRN-R | FLNR_ID (note 3) |
| ATM (Ferraz) | KLKD | GLR | LGR | MOF | BLN | TRS | FLSR_ID |
| ATMR | KLKR | GMT | 481 | MOL | BLF | TRS-R | FLSR_ID (note 4) |
| ATQ | FLO | HCLR | KLKR | MTH | 312 | XL25X | L25S |
| ATQR | KLDR | HCTR | KLDR | NCLR | KLNR | XL50F | L50S (note 1) |
| AX | 481 | HEB | LEB | NON | NLN | XL70F | L70S (note 1) |
| BAF | BLF | HET | LET | 1) Check specific mounting dimensions before substituting. 2) Check fuse characteristics and mounting dimensions for specific application before substituting. 3) For 1/10 - 30 amperes, order non-indicating FLNR series fuses. 4) Verify voltage for DC applications. | | | |
| BAN | BLN | HLR | LHR | | | | |
| BBS | BLS | J | JLS | | | | |
| CJ | JLS | JDL | JTD_ID | | | | |
| CJS | JLS | JFL | JLS | Remember a fuse may be used in circuits where the fuse's voltage rating is equal to or greater than the circuit voltage, unless otherwise stated on the fuse. For example, the FLSR_ID indicating fuse has a voltage rating of 75-600 volts. This fuse can be used on 600 volts, 480 volts, 250 volts, 125 volts, or 75 volts. Never use a fuse in a circuit having a higher rated voltage than the fuse. | | | |
| CLF | KLPC or KLLU | JHC | JTD_ID | | | | |
| CLL | KLLU or KLPC | JJN | JLLN | | | | |
| CLU | KLLU or KLPC | JJS | JLLS | | | | |
| CM | BLF | JKS | JLS | | | | |
| CMF | BLN | KAA | L15S | | | | |

Additional Resources

1-800-TEC-FUSE

For additional questions, call the Littelfuse® Technical Support and Engineering Service Group at 1-800-TEC-FUSE (1-800-832-3873) or visit us online at www.littelfuse.com

Safety By Design

Learn about our products designed specifically to increase safety. Find training videos, white papers and product information for designing in safety. Visit: www.littelfuse.com/safetybydesign



White Papers and Additional Technical Information

An expanded Technical Application Guide, White Papers, and a library of technical information is available online at www.littelfuse.com/technicalcenter. Littelfuse POWR-GARD® can help you address application and circuit protection challenges while achieving regulatory compliance.



Motor Protection

Effective motor protection is critical in today's highly automated industrial facilities. POWR-GARD fuses and protection relays provide optimum protection for motors in main, feeder, and branch circuits.



SCCR

The NEC® requires Industrial Control Panels be labeled with their Short-Circuit Current Rating so users and inspectors can compare their equipment to available fault currents to avoid potential hazards.



Transformer Protection

POWR-GARD fuses provide optimal overcurrent protection for both the primary and secondary of control transformers and other regular transformers above and below 600 volts.



Arc-Flash Protection

Arc-Flash protection relays are intelligent controllers that safeguard equipment and personnel to prevent damage, downtime or injury due to arc flash.



Medium Voltage Fuse Protection

POWR-GARD medium voltage fuses provide short-circuit protection for motors and transformers rated 2,400 to 38,000 volts AC.



Overvoltage Suppression Basics

Overvoltage conditions are an increasing concern in the electrical industry. Littelfuse's broadest range of circuit protection technologies protect against voltage transients in a wide range of applications.

Littelfuse® POWR-GARD® products and technical resources enhance the productivity and safety of electrical systems. POWR-GARD offers current-limiting fuses to decrease Arc-Flash exposure, fuse holders and fuse covers to reduce incidental contact, protection relays to safeguard equipment and safety resources to improve safety.

- Fuses and Fuse Holders
- Solar-Rated Products
- Relays and Controls
- Remote Indication
- Safety Resources



WWW.LITTELFUSE.COM

For 35 years Littelfuse POWR-GARD has helped OEM engineers, consulting engineers and end users select the right products to protect critical electrical equipment—supported by our full line of product catalogs and reference materials.

Relays & Controls Catalog

The comprehensive line of electronic and microprocessor-based protection relays and controls safeguard equipment and personnel to prevent expensive damage, downtime or injury due to electrical faults.

Up-LINK™ Product Brochure

Up-LINK is a patented remote indication technology, incorporated in a growing number of fuse holders and other products that improve productivity by providing necessary information to monitoring sites.

Varistor Catalog

Littelfuse offers industrial Metal Oxide Varistors (MOVs) to protect against transient voltage surges.

OEM Design Brochure

Design engineers can work with Littelfuse POWR-GARD to add value to their products with standard or custom circuit protection solutions.

To view all Littelfuse product catalogs, visit our web site at www.littelfuse.com/catalogs



Littelfuse POWR-GARD is in the App Store!

Our free Littelfuse Catalogs and Literature App keeps our products and technical resources at your finger tips, wherever you are. Find products and technical specifications you need, quickly and easily!

Данный компонент на территории Российской Федерации

Вы можете приобрести в компании MosChip.

Для оперативного оформления запроса Вам необходимо перейти по данной ссылке:

<http://moschip.ru/get-element>

Вы можете разместить у нас заказ для любого Вашего проекта, будь то серийное производство или разработка единичного прибора.

В нашем ассортименте представлены ведущие мировые производители активных и пассивных электронных компонентов.

Нашей специализацией является поставка электронной компонентной базы двойного назначения, продукции таких производителей как XILINX, Intel (ex.ALTERA), Vicor, Microchip, Texas Instruments, Analog Devices, Mini-Circuits, Amphenol, Glenair.

Сотрудничество с глобальными дистрибьюторами электронных компонентов, предоставляет возможность заказывать и получать с международных складов практически любой перечень компонентов в оптимальные для Вас сроки.

На всех этапах разработки и производства наши партнеры могут получить квалифицированную поддержку опытных инженеров.

Система менеджмента качества компании отвечает требованиям в соответствии с ГОСТ Р ИСО 9001, ГОСТ РВ 0015-002 и ЭС РД 009

Офис по работе с юридическими лицами:

105318, г.Москва, ул.Щербаковская д.3, офис 1107, 1118, ДЦ «Щербаковский»

Телефон: +7 495 668-12-70 (многоканальный)

Факс: +7 495 668-12-70 (доб.304)

E-mail: info@moschip.ru

Skype отдела продаж:

moschip.ru

moschip.ru_4

moschip.ru_6

moschip.ru_9