



MIC2845A

High Efficiency 6 Channel Linear WLED Driver with DAM™, Ultra Fast PWM™ Control and Dual Low I_Q LDOs

General Description

The MIC2845A is a high efficiency White LED (WLED) driver designed to drive up to six LEDs, greatly extending battery life for portable display backlighting, keypad backlighting, and camera flash in mobile devices. The MIC2845A provides the highest possible efficiency as this architecture has no switching losses present in traditional charge pumps or inductive boost circuits. The MIC2845A provides six linear drivers channels which maintain constant current for up to six LEDs. It features a typical dropout of 40mV at 20mA. This allows the LEDs to be driven directly from the battery eliminating switching noise/losses present with the use of boost circuitry.

The MIC2845A features Dynamic Average Matching™ (DAM™) which is specifically designed to provide optimum matching across all WLEDs. The six channels are matched better than ±1.5% typical, ensuring uniform display illumination under all conditions. The brightness is controlled through an Ultra Fast PWM™ Control interface operating down to less than 1% duty cycle.

The MIC2845A also features two independently enabled low quiescent current LDOs. Each LDO offers ±3% accuracy from the nominal voltage over temperature, low dropout voltage (150mV @ 150mA), and low ground current under all load conditions (typically 35µA). Both LDOs can be disabled to draw virtually no current.

The MIC2845A is available in the 14-pin 2.5mm x 2.5mm Thin MLF® leadless package with a junction temperature range of -40°C to +125°C.

Datasheets and support documentation can be found on Micrel's web site at: www.micrel.com.

Features

WLED Driver

- **High Efficiency (no Voltage Boost losses)**
- Dynamic Average Matching™ (DAM™)
- Ultra Fast PWM™ control (200Hz to 500kHz)
- Input voltage range: 3.0V to 5.5V
- Dropout of 40mV at 20mA
- Matching better than ±1.5% (typical)
- Current accuracy better than ±1.5% (typical)
- Maintains proper regulation regardless of how many channels are utilized

LDOs

- Very low ground current – Typical 35µA
- Stable with 1µF ceramic output capacitor
- Dropout of 150mV at 150mA
- Thermal shutdown and current limit protection
- Available in a 14-pin 2.5mm x 2.5mm Thin MLF® package

Applications

- Mobile handsets
- LCD Handset backlighting
- Handset keypad backlighting
- Digital cameras
- Portable media/MP3 players
- Portable navigation devices (GPS)
- Portable applications

DAM, Dynamic Average Matching and Ultra Fast PWM are trademarks of Micrel, Inc.
MLF and *MicroLeadFrame* are registered trademark Amkor Technology Inc.

Micrel Inc. • 2180 Fortune Drive • San Jose, CA 95131 • USA • tel +1 (408) 944-0800 • fax + 1 (408) 474-1000 • <http://www.micrel.com>

Typical Application

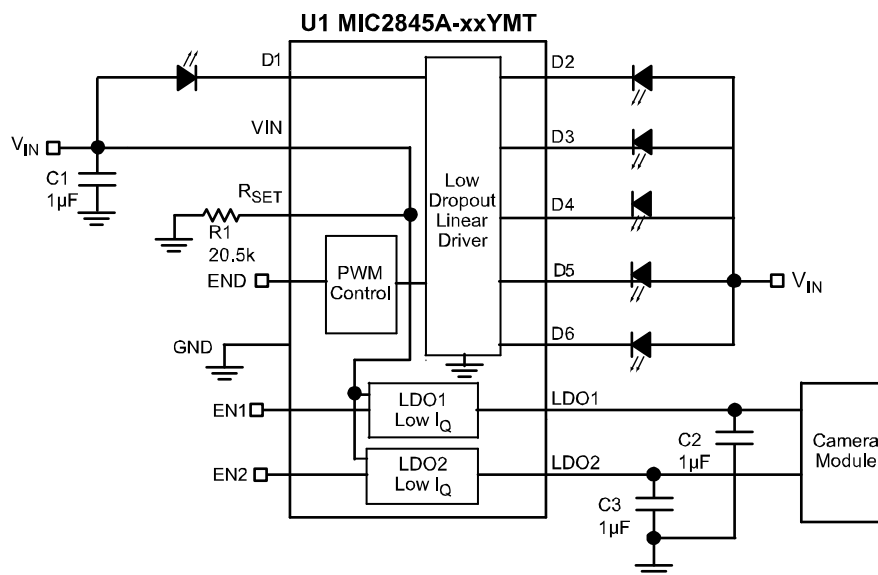

LCD Display Backlight with 6 WLEDs and Camera Module

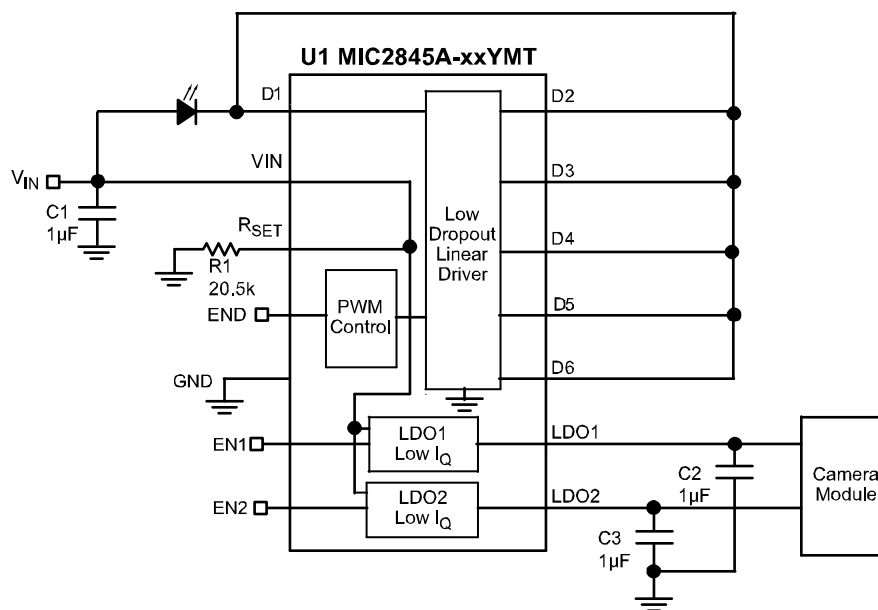

High Current Flash Driver

Ordering Information

Part Number	Mark Code ⁽¹⁾	LDO1 VOUT	LDO2 VOUT	Temperature Range	Package ⁽²⁾
MIC2845A-MFYMT	YNMF	2.8V	1.5V	-40°C to +125°C	14-Pin 2.5mm x 2.5mm Thin MLF [®]
MIC2845A-MGYMT	YNMG	2.8V	1.8V	-40°C to +125°C	14-Pin 2.5mm x 2.5mm Thin MLF [®]
MIC2845A-PGYMT	YNPG	3.0V	1.8V	-40°C to +125°C	14-Pin 2.5mm x 2.5mm Thin MLF [®]
MIC2845A-PPYMT	YNPP	3.0V	3.0V	-40°C to +125°C	14-Pin 2.5mm x 2.5mm Thin MLF [®]
MIC2845A-SCYMT	YNSC	3.3V	1.0V	-40°C to +125°C	14-Pin 2.5mm x 2.5mm Thin MLF [®]

Notes:

- Thin MLF[®] ▲ = Pin 1 identifier.
- Thin MLF[®] is a GREEN RoHS compliant package. Lead finish is NiPdAu. Mold compound is halogen free.
- Contact Micrel for other voltage options.

Pin Configuration

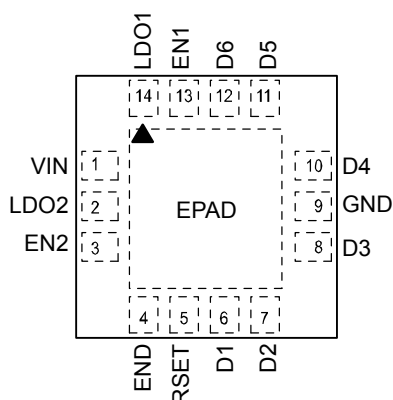

14-Pin 2.5mm x 2.5mm Thin MLF[®] (MT)
(Top View)

Pin Description

Pin Number	Pin Name	Pin Function
1	VIN	Voltage Input. Connect at least 1μF ceramic capacitor between VIN and GND.
2	LDO2	Output of LDO2. Connect at least 1μF ceramic output capacitor.
3	EN2	Enable Input for LDO2. Active High Input. Logic High = On; Logic Low = Off; Do not leave floating.
4	END	Enable for LED driver. Can be used as a PWM input for dimming of LEDs. Do not leave floating.
5	RSET	An internal 1.27V reference sets the nominal maximum LED current. Example, apply a 20.5kΩ resistor between RSET and GND to set LED current to 20mA at 100% duty cycle.
6	D1	LED1 driver. Connect LED anode to VIN and cathode to this pin.
7	D2	LED2 driver. Connect LED anode to VIN and cathode to this pin.
8	D3	LED3 driver. Connect LED anode to VIN and cathode to this pin.
9	GND	Ground.
10	D4	LED4 driver. Connect LED anode to VIN and cathode to this pin.
11	D5	LED5 driver. Connect LED anode to VIN and cathode to this pin.
12	D6	LED6 driver. Connect LED anode to VIN and cathode to this pin.
13	EN1	Enable Input for LDO1. Active High Input. Logic High = On; Logic Low = Off; Do not leave floating.
14	LDO1	Output of LDO1. Connect at least 1μF ceramic output capacitor.
EPAD	HS PAD	Heat sink pad. Not internally connected. Connect to ground.

Absolute Maximum Ratings⁽¹⁾

Main Input Voltage (V_{IN})	-0.3V to +6V
Enable Input Voltage (V_{END} , V_{EN1} , V_{EN2})	-0.3V to +6V
LED Driver Voltage (V_{D1-D6})	-0.3V to +6V
Power Dissipation	Internally Limited ⁽³⁾
Lead Temperature (soldering, 10sec.)	260°C
Storage Temperature (T_s)	-65°C to +150°C
ESD Rating ⁽⁴⁾	ESD Sensitive

Operating Ratings⁽²⁾

Supply Voltage (V_{IN})	+3.0V to +5.5V
Enable Input Voltage (V_{END} , V_{EN1} , V_{EN2})	0V to V_{IN}
LED Driver Voltage (V_{D1-D6})	0V to V_{IN}
Junction Temperature (T_J)	-40°C to +125°C
Junction Thermal Resistance	
2.5mm x 2.5mm Thin MLF-14L (θ_{JA})	89°C/W

Electrical Characteristics**WLED Linear Drivers**

$V_{IN} = V_{END} = 3.8V$, $V_{EN1} = V_{EN2} = 0V$, $R_{SET} = 20.5k\Omega$; $V_{D1-D6} = 0.6V$; $T_J = 25^\circ C$, **bold** values indicate $-40^\circ C \leq T_J \leq 125^\circ C$; unless noted.

Parameter	Conditions	Min	Typ	Max	Units
Current Accuracy ⁽⁵⁾			1.5		%
Matching ⁽⁶⁾			1.5	3.6	%
Drop-out	Where $I_{LED} = 90\%$ of LED current seen at $V_{DROPNOM} = 0.6V$, 100% brightness level		40	80	mV
Supply Bias Current	$I_{LED} = 20mA$		1.4	1.8	mA
Shutdown Current (current source leakage)	$V_{END} = 0V$		0.01	1	μA
PWM Dimming					
Enable Input Voltage (V_{END})	Logic Low			0.2	V
	Logic High	1.2			V
Enable Input Current	$V_{IH} = 1.2V$		0.01	1	μA
Current Source Delay (50% levels)	Shutdown to On		40	80	μs
	Standby to On		2		μs
	On to Standby		0.3		μs
Current Source Transient Time (10%-90%)	T_{RISE}		1.3		μs
	T_{FALL}		0.3		μs
Stand-by to Shutdown Time	$V_{END} = 0V$	10	24	40	ms

LDOs

$V_{IN} = V_{EN1} = V_{EN2} = 3.8V$, $V_{END} = 0V$, $C_{OUT1} = C_{OUT2} = 1\mu F$, $I_{OUT1} = I_{OUT2} = 100\mu A$; $T_J = 25^\circ C$, **bold** values indicate $-40^\circ C \leq T_J \leq 125^\circ C$; unless noted.

Parameter	Conditions	Min	Typ	Max	Units
Output Voltage Accuracy	Variation from nominal V_{OUT}	-2		+2	%
		-3		+3	%
V_{IN} Line Regulation			0.02	0.3	%/V
Load Regulation	$I_{OUT} = 100\mu A$ to 150mA		7		mV
Dropout Voltage ⁽⁷⁾	$V_{OUT} \geq 3.0V$, $I_{OUT} = 150mA$		150	330	mV
Ground Pin Current			35	70	μA
Ground Pin Current in Shutdown	$V_{EN} = 0V$		0.05	1	μA
Ripple Rejection	$f = 1kHz$; $C_{OUT} = 2.2\mu F$		65		dB
Current Limit	$V_{OUT} = 0V$	175	300	500	mA
Output Voltage Noise	Frequency 10Hz to 100kHz		200		μV_{RMS}
Enable Inputs (EN1, EN2)					
Enable Input Voltage	Logic Low			0.2	V
	Logic High	1.2			V
Enable Input Current	$V_{EN1} = V_{EN2} = 1.2V$		0.01	1	μA
Turn-on Time	$C_{OUT} = 1\mu F$; 90% of V_{OUT}		50	100	μs

Notes:

- Exceeding the absolute maximum rating may damage the device.
- The device is not guaranteed to function outside its operating rating.
- The maximum allowable power dissipation of any T_A (ambient temperature) is $P_{D(max)} = (T_{J(max)} - T_A) / \theta_{JA}$. Exceeding the maximum allowable power dissipation will result in excessive die temperature, and the regulator will go into thermal shutdown ($150^\circ C$).
- Devices are ESD sensitive. Handling precautions recommended. Human Body Model (HBM), 1.5k Ω in series with 100pF.
- As determined by average current of all channels in use and all channels loaded.
- The current through each channel meets the stated limits from the average current of all channels.
- Dropout voltage is defined as the input-output differential at which the output voltage drops 2% below its nominal value measured at $V_{IN} = V_{OUT} + 1V$.

Typical Characteristics

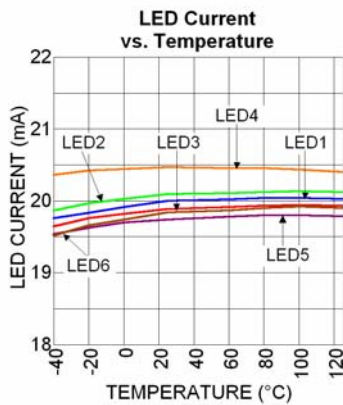
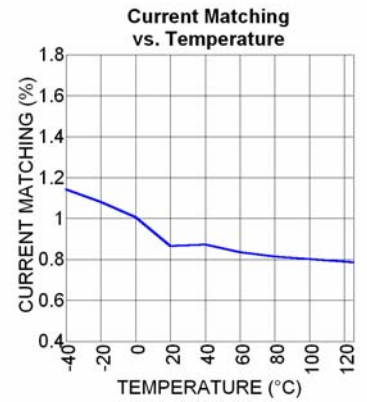
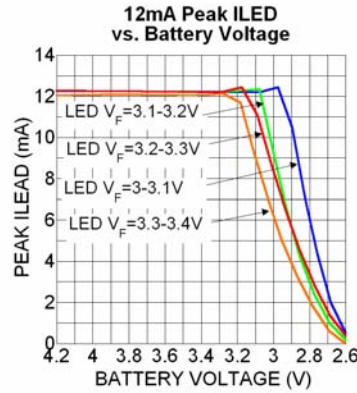
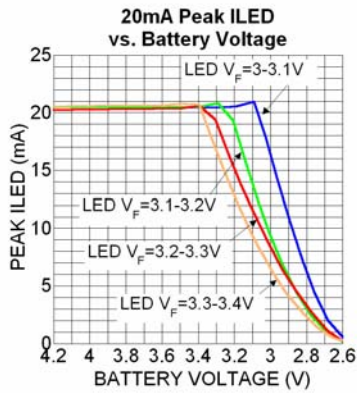
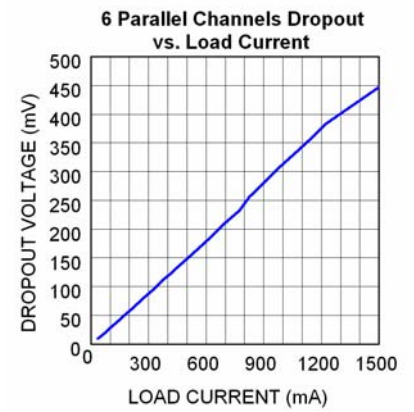
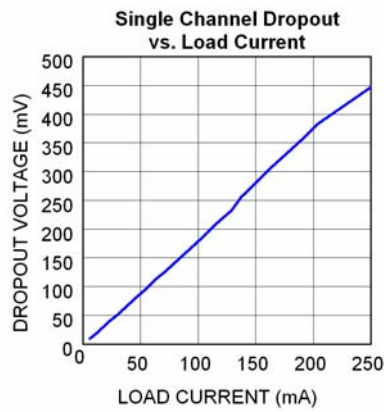
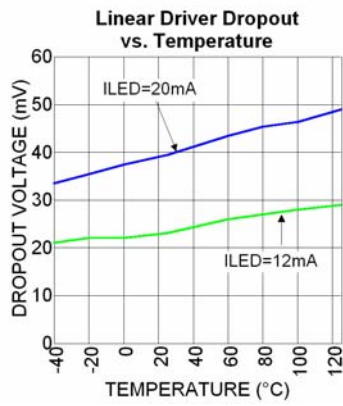
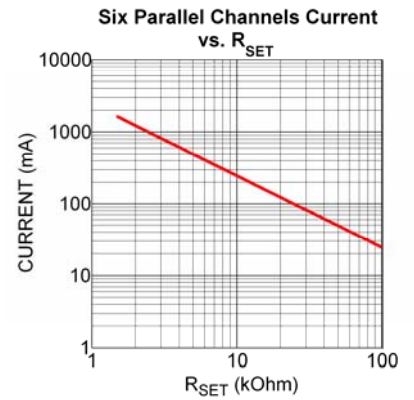
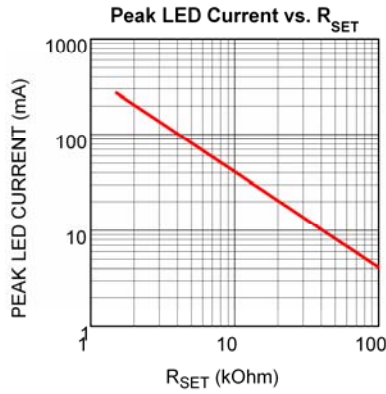
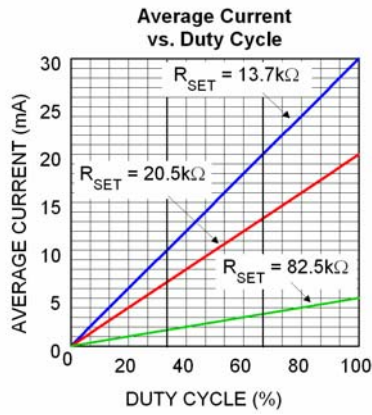

Typical Characteristics (LDO)

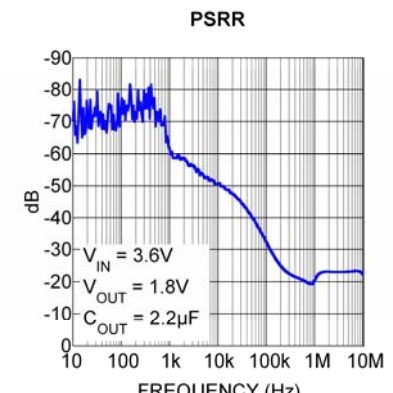
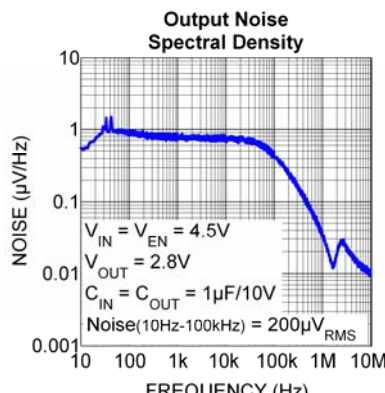
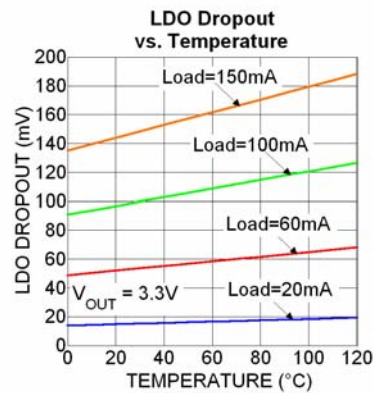
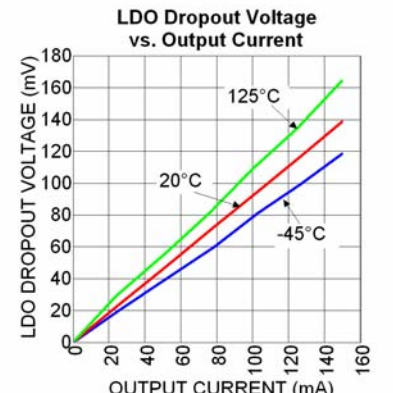
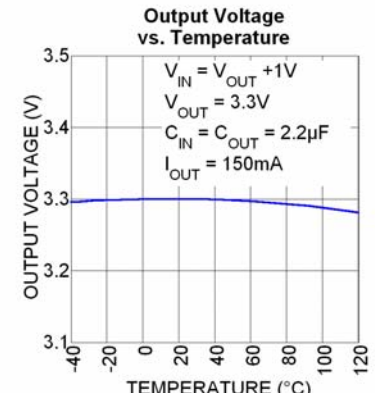
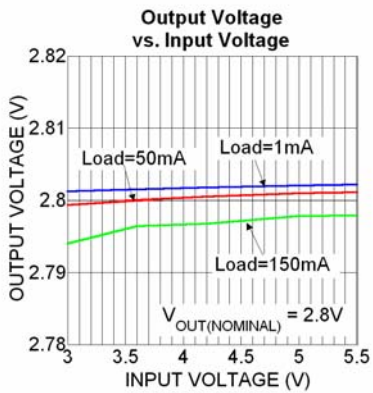
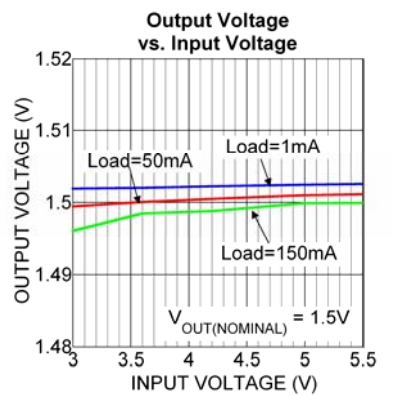
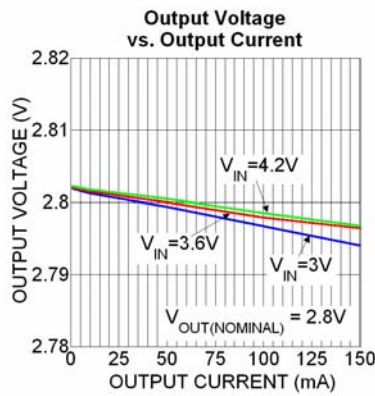
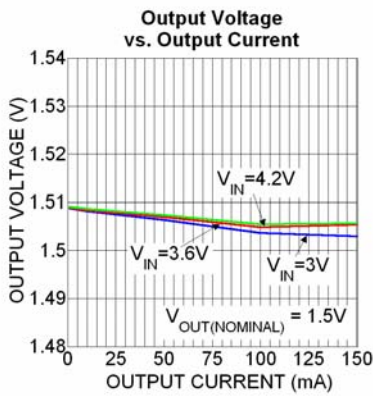
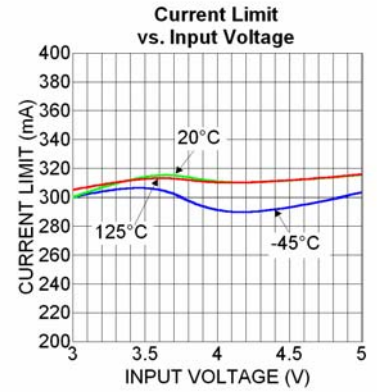
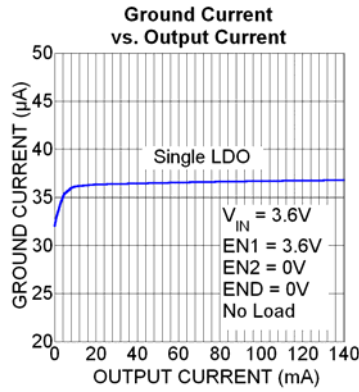
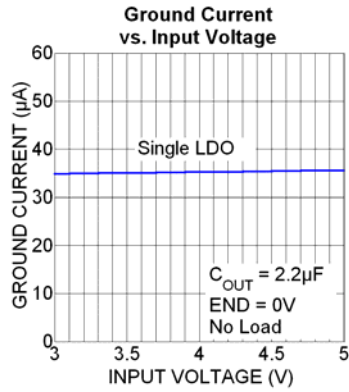

Functional Characteristics (WLED Driver)

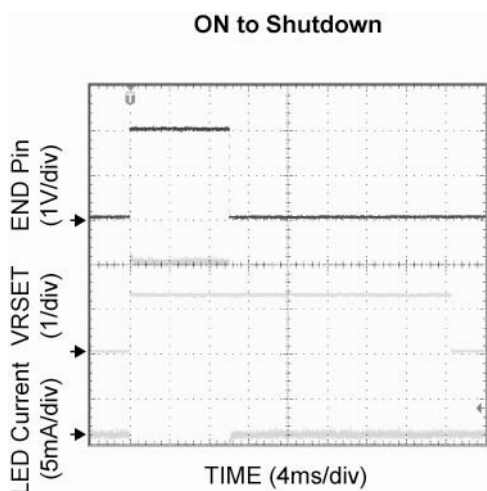
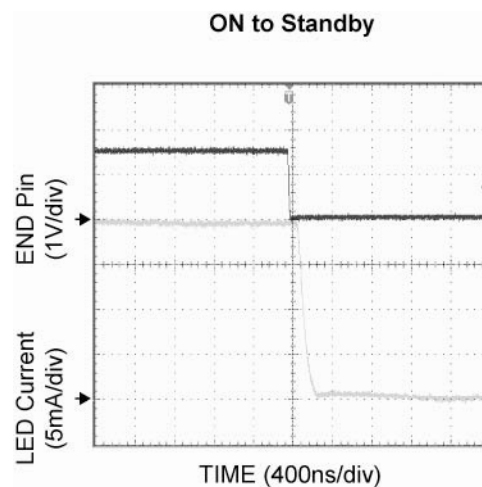
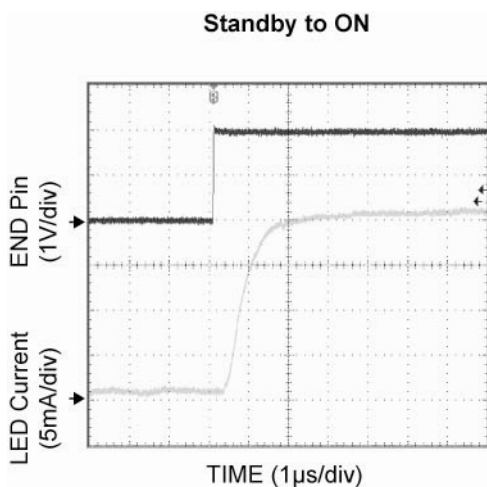
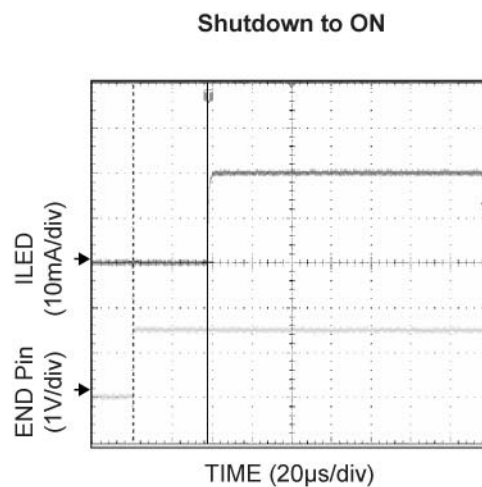
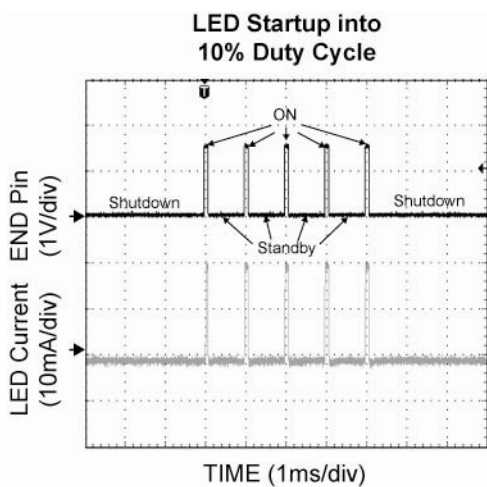

Functional Characteristics (LDO)

LDO Start-Up with No Load

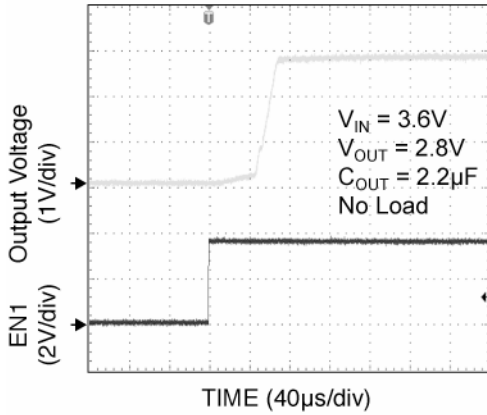

LDO Start-Up with 150mA Load

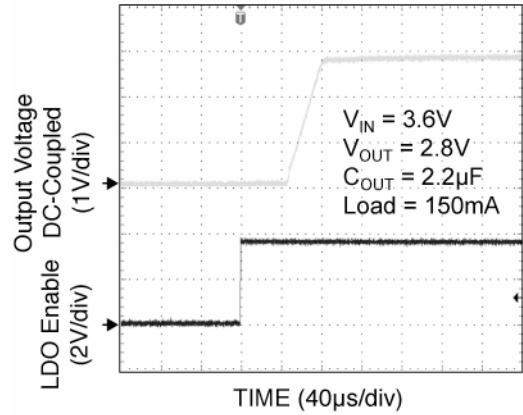

Dual LDO Start-Up with 150mA Load Each

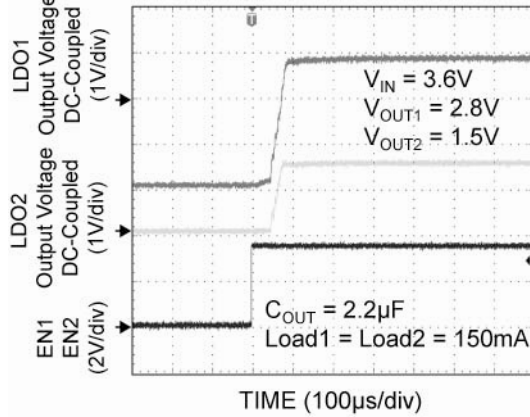

Load Transient from 10mA to 150mA on LDO1

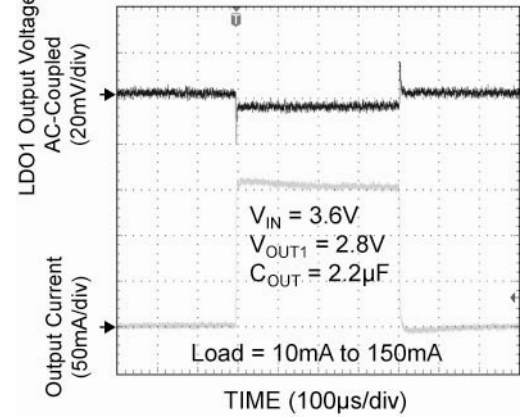

Load Transient from 10mA to 150mA on LDO1

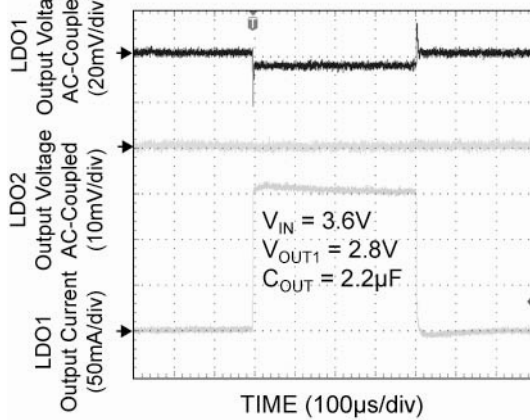

LDO Short Circuit Recovery to 150mA Load

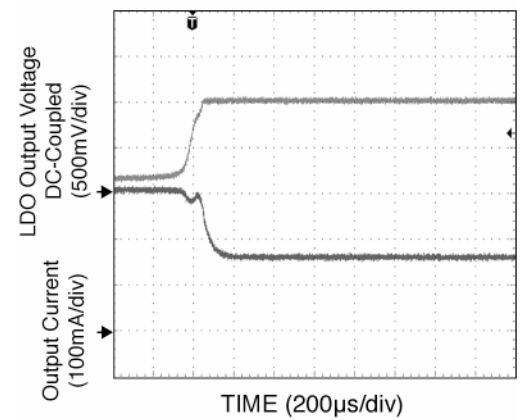

Functional Diagram

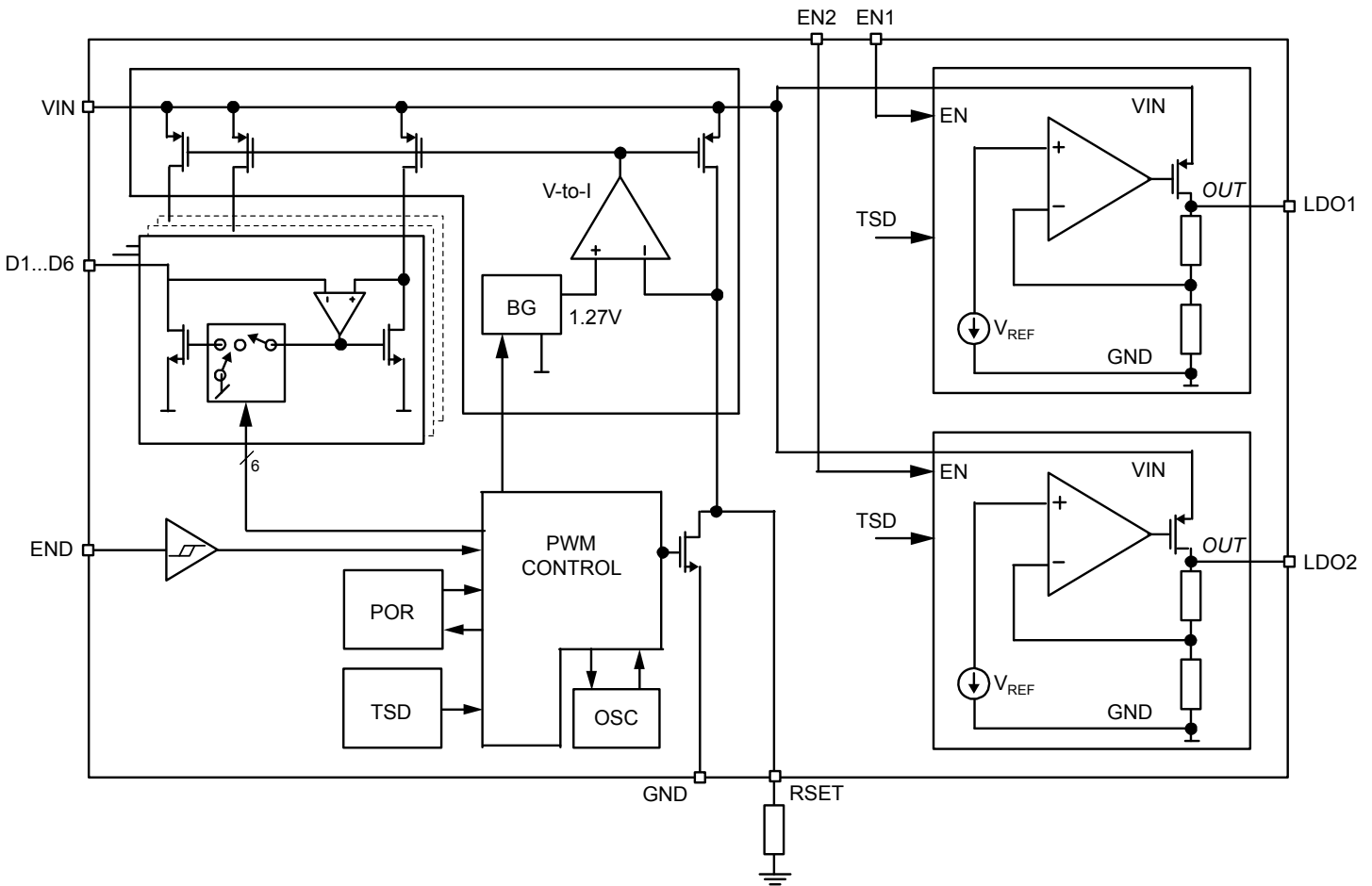

Figure 1. MIC2845A Functional Block Diagram

Functional Description

The MIC2845A is a six channel linear LED driver with dual 150mA LDOs. The LED driver is designed to maintain proper current regulation with LED current accuracy of 1.5% while the typical matching between the six channels is 1.5% at room temperature. The LED currents are independently driven from the input supply and will maintain regulation with a dropout of 40mV at 20mA. The low dropout of the linear drivers allows the LEDs to be driven directly from the battery voltage and eliminates the need for boost or large and inefficient charge pumps. The maximum LED current for each channel is set via an external resistor. Dimming is controlled by applying a PWM signal to the END pin. The MIC2845A accommodates a wide PWM frequency range as outlined in the application information section.

The MIC2845A has two LDOs with a dropout voltage of 150mV at 150mA and consume 35µA of current in operation. Each LDO has an independent enable pin,

which reduces the operating current to less than 1µA in shutdown. Both linear regulators are stable with just 1µF of output capacitance.

Block Diagram

As shown in Figure 1, the MIC2845A consists of two LDOs with six current mirrors set to copy a master current determined by R_{SET} . The linear LED drivers have a designated control block for enabling and dimming of the LEDs. The MIC2845A dimming is controlled by the Ultra Fast PWM™ control block that receives PWM signals for dimming. The LDOs each have their own control and are independent of the linear LED drivers. Each LDO consists of internal feedback resistors, an error amplifier, a PFET transistor and a control circuit for enabling.

V_{IN}

The input supply (V_{IN}) provides power to the linear LED drivers and the control circuitry. The V_{IN} operating range is 3V to 5.5V. A minimum bypass capacitor of 1µF should be placed close to the input (VIN) pin and the ground (GND) pin. Refer to the layout recommendations section for details on placing the input capacitor (C1).

LDO1/LDO2

The output pins for LDO one and LDO two are labeled LDO1 and LDO2, respectively. A minimum of 1µF bypass capacitor should be placed as close as possible to the output pin of each LDO. Refer to the layout recommendations section for details on placing the output capacitor (C2, C3) of the LDOs.

EN1/EN2

A logic high signal on the enable pin activates the LDO output voltage of the device. A logic low signal on the enable pin deactivates the output and reduces supply current to less than 1µA. EN1 controls LDO1 and EN2 controls LDO2. Do not leave these control pins floating.

END

The END pin is equivalent to the enable pin for the linear drivers on the MIC2845A. It can also be used for dimming applying a PWM signal. See the PWM Dimming Interface in the Application Information section for details. Pulling the END low for more than 24ms puts the MIC2845A into a low I_q sleep mode. The END pin cannot be left floating; a floating enable pin may cause an indeterminate state on the outputs. A 200kΩ pull down resistor is recommended.

R_{SET}

The R_{SET} pin is used to set the peak current of the linear driver by connecting a R_{SET} resistor to ground. The average LED current can be calculated by equation (1):

$$I_{LED} \text{ (mA)} = 410 * D / R_{SET} \text{ (k}\Omega) \tag{1}$$

D is the duty cycle of the LED current during PWM dimming. When the device is fully on the duty cycle equals 100% (D = 1). A plot of I_{LED} versus R_{SET} is shown in Figure 2.

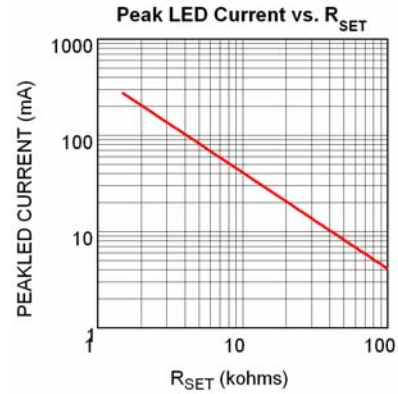

Figure 2. Peak LED Current vs. R_{SET}

D1-D6

The D1 through D6 pins are the linear driver for LED 1 through 6, respectively. Connect the anodes of the LEDs to V_{IN} and each cathode of the LEDs to D1 through D6. When operating with less than six LEDs, leave the unused D pins unconnected. The six LED channels are independent of one another and may be combined or used separately.

GND

The ground pin is the ground path for the linear drivers and LDOs. The ground of the input capacitor should be routed with low impedance traces to the GND pin and made as short as possible. Refer to the layout recommendations for more details.

Application Information

Dynamic Average Matching (DAM™)

The Dynamic Average Matching architecture multiplexes four current references to provide highly accurate LED current and channel matching. The MIC2845A achieves industry leading LED channel matching of 1.5% across the entire dimming range.

Ultra Fast PWM™ Dimming Interface

The MIC2845A supports a wide range of PWM control signal frequencies from 200Hz to 500kHz. This extremely wide range of control provides ultimate flexibility for handheld applications using high frequency PWM control signals.

WLED dimming is achieved by applying a pulse width modulated (PWM) signal to the END pin. For PWM frequencies between 200Hz – 20kHz the MIC2845A supports a duty cycle range from 1% to 100%, as shown in Figure 3. The MIC2845A incorporates an internal shutdown delay to ensure that the internal control circuitry remains active during PWM dimming. This feature prevents the possibility of backlight flickering when using low frequency PWM control signals. The MIC2845A also supports Ultra Fast PWM™ frequencies from 20kHz to 500kHz. Due to input signal propagation delay, PWM frequencies above 20kHz have a non-linear relationship between the duty cycle and the average LED current, as shown in Figure 4 and Figure 5. Figures 6 through 10 show the WLED current response when a PWM signal is applied to the END pin ⁽¹⁾.

⁽¹⁾ From the low Iq sleep mode PWM frequencies above 15kHz require a logic high enable signal for 80µs to first enable the MIC2845A prior to PWM dimming.

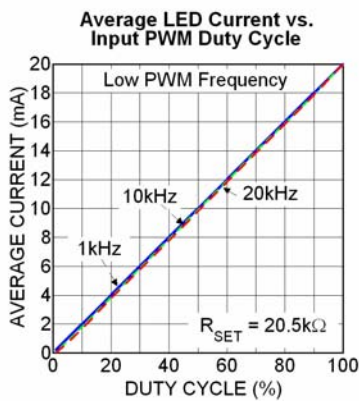

Figure 3. Average Current per LED Dimming by Changing PWM Duty Cycle for PWM Frequencies up to 20kHz

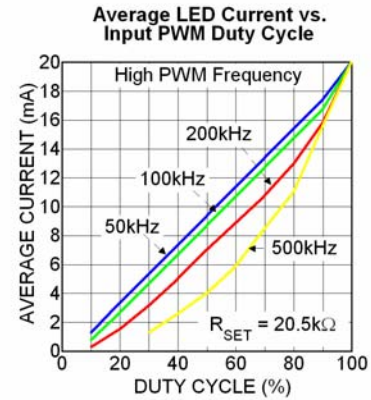

Figure 4. Channel Current Response to PWM Control Signal Frequencies from 50kHz to 500kHz

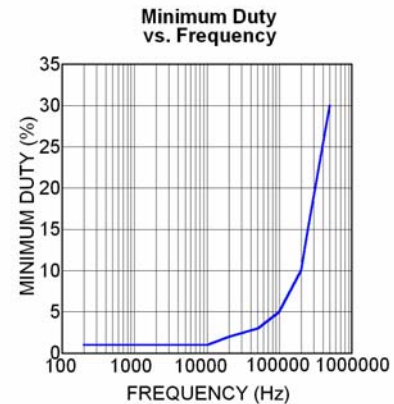

Figure 5. Minimum Duty Cycle for Varying PWM Frequency

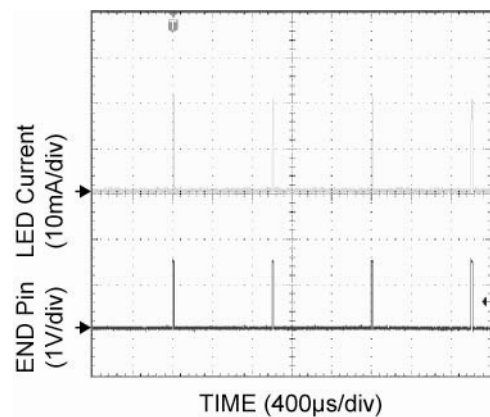

Figure 6. PWM Signal at 1% Duty Cycle ($I_{avg} = 0.2mA$)

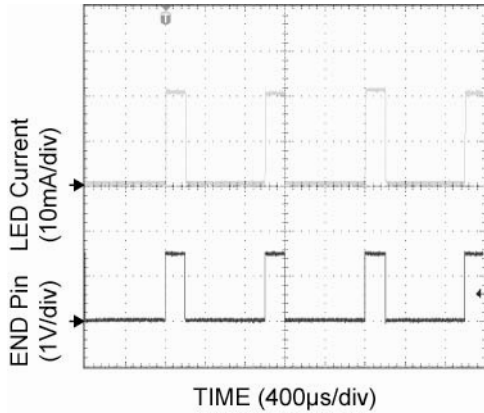

Figure 7. PWM Signal at 20% Duty Cycle ($I_{avg} = 4mA$)

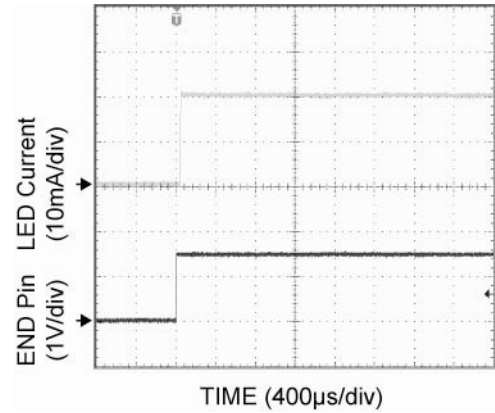

Figure 10. PWM Signal at 100% Duty Cycle ($I_{avg} = 20mA$)

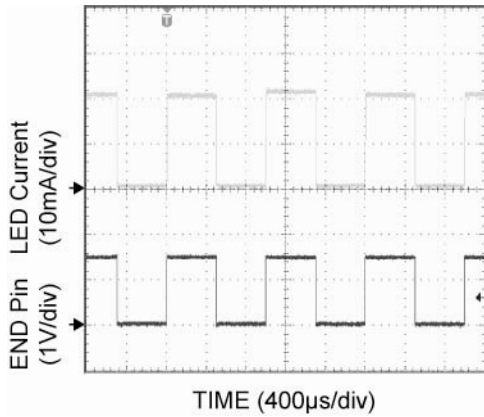

Figure 8. PWM Signal at 50% Duty Cycle ($I_{avg} = 10mA$)

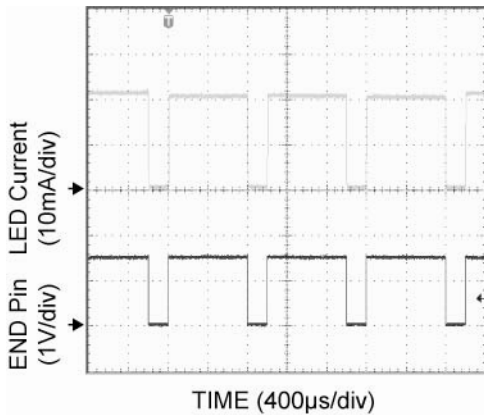

Figure 9. PWM Signal at 80% Duty Cycle ($I_{avg} = 16mA$)

High Current Parallel Operation

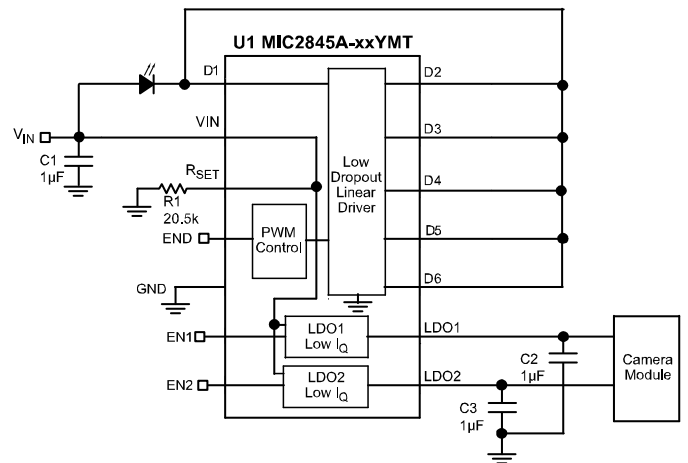

Figure 11. Six Channel (Parallel) Application Circuit

The linear drivers are independent of each other and can be used individually or paralleled to provide larger current. A single LED can be driven with all 6 linear drivers by connecting D1 through D6 together with the cathode of the LED as shown in Figure 11. This will generate a current 6 times the LED current setting and can be used for higher current LEDs such as those used in flash or torch applications. The current is set by the R_{SET} resistor, and can be calculated by the following equation.

$$I_{LED} (mA) = 6 * 410 * D / R_{SET} (k\Omega).$$

D is the duty cycle of the LED current during PWM dimming. When the device is fully on the duty cycle equals 100% ($D = 1$). Figure 12 shows the response time of the six paralleled linear drivers to the enable signal, while Figure 13 shows the turn off response. With a R_{SET} resistor of 1.65k, each linear driver is set to 250mA, with all 6 linear drivers connected in parallel, the MIC2843 is capable of driving a total current of 1.5A.

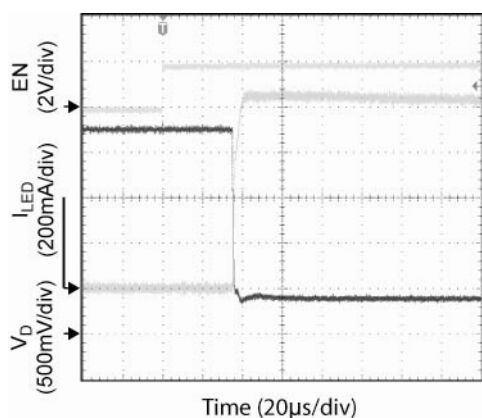

Figure 12. Current Response Time to Enable Signal Turning On (Six Paralleled Channels)

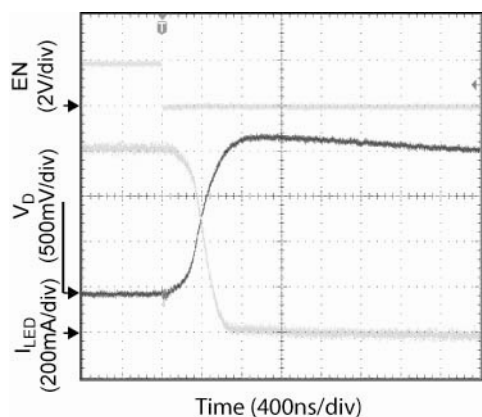

Figure 13. Current Response Time to Enable Signal Turning Off (Six Paralleled Channels)

LDO

MIC2845A LDOs are low noise 150mA LDOs. The MIC2845A LDO regulators are fully protected from damage due to fault conditions, offering linear current limiting and thermal shutdown.

Input Capacitor

The MIC2845A LDOs are high-performance, high bandwidth devices. Stability can be maintained using a ceramic input capacitor of 1µF. Low-ESR ceramic capacitors provide optimal performance at a minimum amount of space. Additional high-frequency capacitors, such as small-valued NPO dielectric-type capacitors, help filter out high-frequency noise and are good practice in any noise sensitive circuit. X5R or X7R dielectrics are recommended for the input capacitor. Y5V dielectrics lose most of their capacitance over temperature and are therefore, not recommended.

Output Capacitor

The MIC2845A LDOs require an output capacitor of at least 1µF or greater to maintain stability, however, the output capacitor can be increased to 2.2µF to reduce output noise without increasing package size. The design is optimized for use with low-ESR ceramic chip capacitors. High ESR capacitors are not recommended because they may cause high frequency oscillation. X7R/X5R dielectric-type ceramic capacitors are recommended due to their improved temperature performance compared to Z5U and Y5V capacitors. X7R-type capacitors change capacitance by 15% over their operating temperature range and are the most stable type of ceramic capacitors. Z5U and Y5V dielectric capacitors change value by as much as 50% and 60%, respectively, over their operating temperature ranges. While using Z5U and Y5V ceramic capacitors, ensure that the loss in capacitance does not drop below the minimum requirement of the device.

No-Load Stability

Unlike many other voltage regulators, the MIC2845A LDOs will remain stable and in regulation with no load.

Thermal Considerations

The MIC2845A LDOs are each designed to provide 150mA of continuous current. Maximum ambient operating temperature can be calculated based on the output current and the voltage drop across the part. For example if the input voltage is 3.6V, the output voltage is 2.8V, and the output current = 150mA. The actual power dissipation of the regulator circuit can be determined using the equation:

$$P_{LDO1} = (V_{IN} - V_{OUT1}) I_{OUT} + V_{IN} I_{GND}$$

Because this device is CMOS and the ground current (I_{GND}) is typically <100µA over the load range, the power dissipation contributed by the ground current is < 1% and can be ignored for this calculation.

$$P_{LDO1} = (3.6V - 2.8V) \times 150mA$$

$$P_{LDO1} = 0.120W$$

Since there are two LDOs in the same package, the power dissipation must be calculated individually and then summed together to arrive at the total power dissipation.

$$P_{TOTAL} = P_{LDO1} + P_{LDO2}$$

To determine the maximum ambient operating temperature of the package, use the junction-to-ambient thermal resistance ($\theta_{JA} = 60^{\circ}C/W$) of the device and the following basic equation:

$$P_{TOTAL(max)} = \left(\frac{T_{J(max)} - T_A}{\theta_{JA}} \right)$$

$T_{J(max)} = 125^{\circ}\text{C}$, is the maximum junction temperature of the die and θ_{JA} , is the thermal resistance = $60^{\circ}\text{C}/\text{W}$.

Substituting P_{TOTAL} for $P_{TOTAL(max)}$ and solving for the ambient operating temperature will give the maximum operating conditions for the regulator circuit.

For example, when operating the MIC2845A LDOs (LDO1 = 2.8V and LDO2 = 1.5V) at an input voltage of 3.6V with 150mA load on each, the maximum ambient operating temperature T_A can be determined as follows:

$$P_{LDO1} = (3.6\text{V} - 2.8\text{V}) \times 150\text{mA} = 0.120\text{W}$$

$$P_{LDO2} = (3.6\text{V} - 1.5\text{V}) \times 150\text{mA} = 0.315\text{W}$$

$$P_{TOTAL} = 0.120\text{W} + 0.315\text{W} = 0.435\text{W}$$

$$= (125^{\circ}\text{C} - T_A) / (60^{\circ}\text{C}/\text{W})$$

$$T_A = 125^{\circ}\text{C} - 0.435\text{W} \times 60^{\circ}\text{C}/\text{W}$$

$$T_A = 98.9^{\circ}\text{C}$$

Therefore, under the above conditions, the maximum ambient operating temperature of 98.9°C is allowed.

MIC2845A Typical Application Circuit

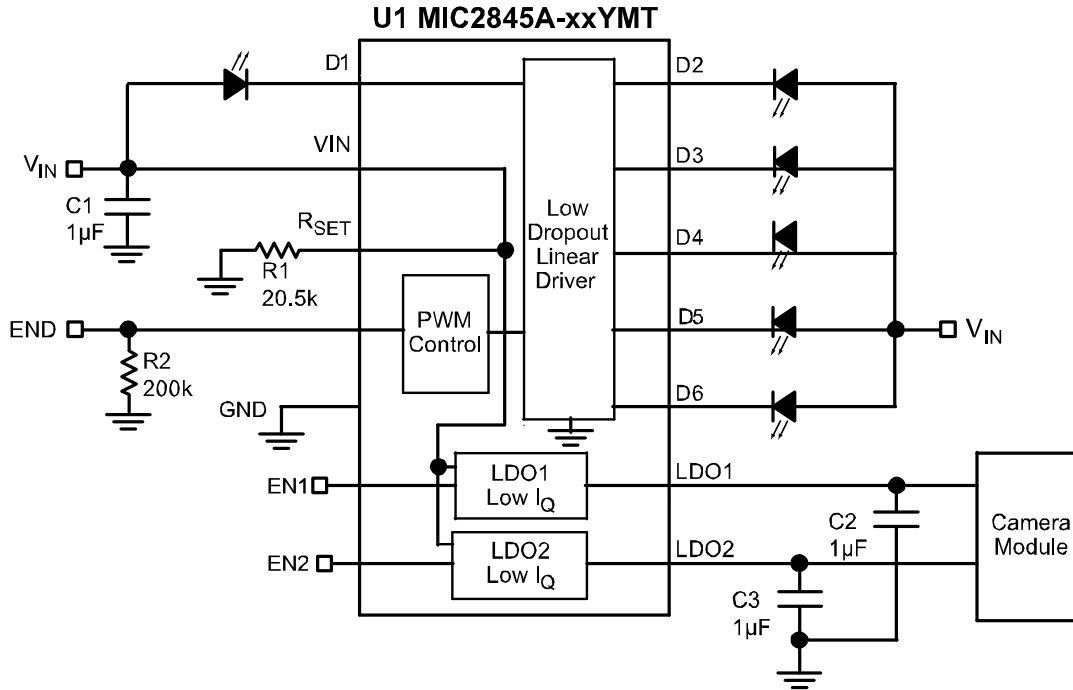

Bill of Materials

Item	Part Number	Manufacturer	Description	Qty.
C1, C2, C3	C1608X5R0J105K	TDK ⁽¹⁾	Ceramic Capacitor, 1µF, 6.3V, X5R, Size 0603	1
	06036D105KAT2A	AVX ⁽²⁾		
	GRM188R60J105KE19D	Murata ⁽³⁾		
	VJ0603G225KXYAT	Vishay ⁽⁴⁾		
D1 – D6	SWTS1007	Seoul Semiconductor ⁽⁵⁾	WLED	6
	99-116UNC	EverLight ⁽⁶⁾		
R1	CRCW060320K5F5EA	Vishay ⁽⁴⁾	Resistor, 20.5k, 1%, 1/16W, Size 0603	1
R2	CRCW06032003FKEA	Vishay ⁽⁴⁾	Resistor, 200k, 1%, 1/16W, Size 0603	1
U1	MIC2845A-xxYMT	Micrel, Inc. ⁽⁷⁾	6 Channel Ultra Fast PWM™ Linear WLED Driver with DAM™ and Dual Low I _Q LDOs	1

Notes:

1. TDK: www.tdk.com
2. AVX: www.avx.com
3. Murata: www.murata.com
4. Vishay: www.vishay.com
5. Seoul Semiconductor: www.seoulsemicon.com
6. EverLight: www.everlight.com
7. Micrel, Inc.: www.micrel.com

PCB Layout Recommendations

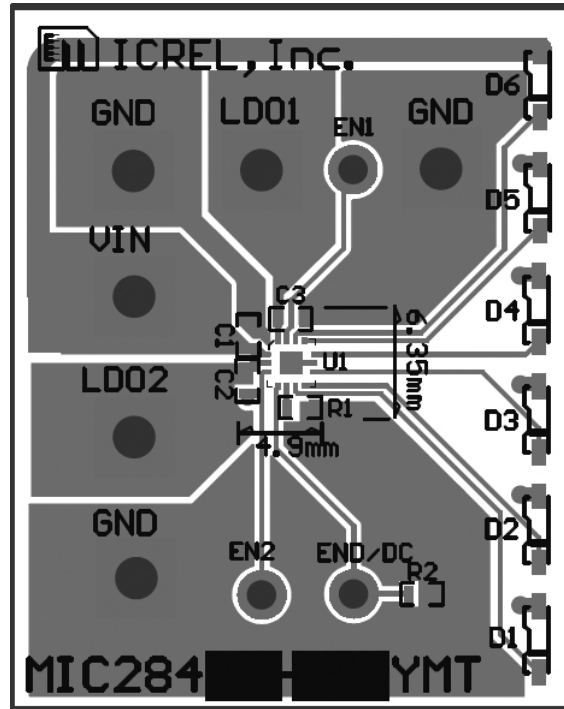

Top Layer

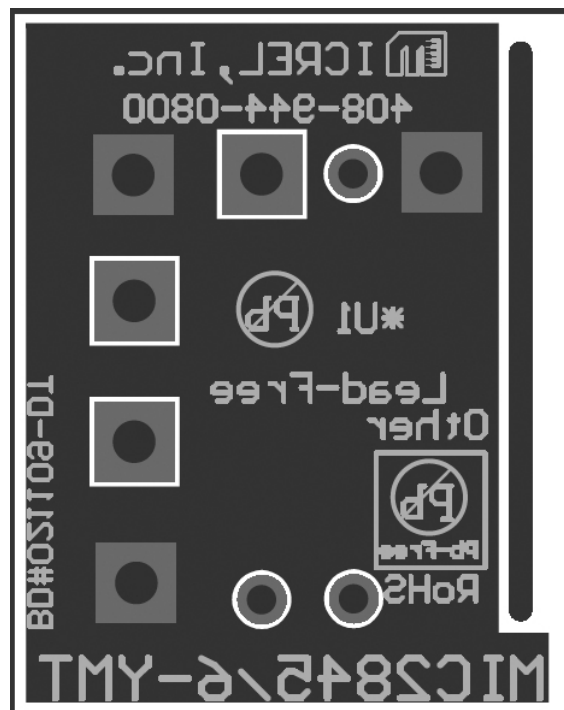

Bottom Layer

Package Information

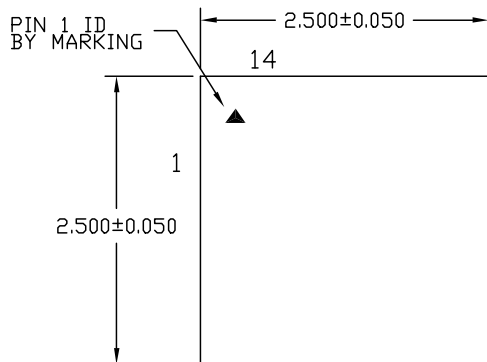

TOP VIEW

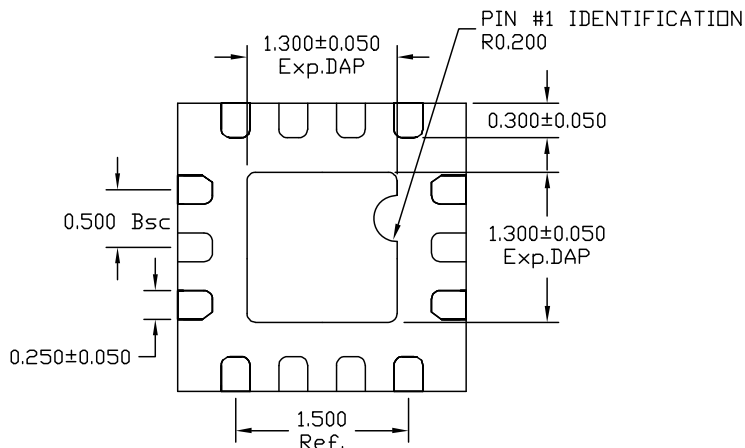

BOTTOM VIEW

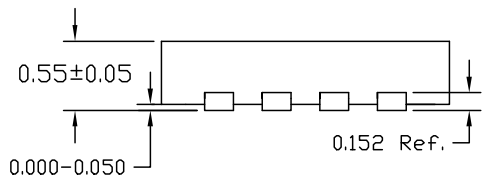

SIDE VIEW

NOTES :

1. ALL DIMENSIONS ARE IN MILLIMETERS.
2. MAX. PACKAGE WARPAGE IS 0.05 mm.
3. MAXIMUM ALLOWABLE BURRS IS 0.076 mm IN ALL DIRECTIONS.
4. PIN #1 ID ON TOP WILL BE LASER MARKED.

14-Pin (2.5mm x 2.5mm) Thin MLF® (MT)

MICREL, INC. 2180 FORTUNE DRIVE SAN JOSE, CA 95131 USA
 TEL +1 (408) 944-0800 FAX +1 (408) 474-1000 WEB <http://www.micrel.com>

The information furnished by Micrel in this data sheet is believed to be accurate and reliable. However, no responsibility is assumed by Micrel for its use. Micrel reserves the right to change circuitry and specifications at any time without notification to the customer.

Micrel Products are not designed or authorized for use as components in life support appliances, devices or systems where malfunction of a product can reasonably be expected to result in personal injury. Life support devices or systems are devices or systems that (a) are intended for surgical implant into the body or (b) support or sustain life, and whose failure to perform can be reasonably expected to result in a significant injury to the user. A Purchaser's use or sale of Micrel Products for use in life support appliances, devices or systems is a Purchaser's own risk and Purchaser agrees to fully indemnify Micrel for any damages resulting from such use or sale.

Данный компонент на территории Российской Федерации

Вы можете приобрести в компании MosChip.

Для оперативного оформления запроса Вам необходимо перейти по данной ссылке:

<http://moschip.ru/get-element>

Вы можете разместить у нас заказ для любого Вашего проекта, будь то серийное производство или разработка единичного прибора.

В нашем ассортименте представлены ведущие мировые производители активных и пассивных электронных компонентов.

Нашей специализацией является поставка электронной компонентной базы двойного назначения, продукции таких производителей как XILINX, Intel (ex.ALTERA), Vicor, Microchip, Texas Instruments, Analog Devices, Mini-Circuits, Amphenol, Glenair.

Сотрудничество с глобальными дистрибьюторами электронных компонентов, предоставляет возможность заказывать и получать с международных складов практически любой перечень компонентов в оптимальные для Вас сроки.

На всех этапах разработки и производства наши партнеры могут получить квалифицированную поддержку опытных инженеров.

Система менеджмента качества компании отвечает требованиям в соответствии с ГОСТ Р ИСО 9001, ГОСТ РВ 0015-002 и ЭС РД 009

Офис по работе с юридическими лицами:

105318, г.Москва, ул.Щербаковская д.3, офис 1107, 1118, ДЦ «Щербаковский»

Телефон: +7 495 668-12-70 (многоканальный)

Факс: +7 495 668-12-70 (доб.304)

E-mail: info@moschip.ru

Skype отдела продаж:

moschip.ru

moschip.ru_4

moschip.ru_6

moschip.ru_9