

**Silicon Tuning Diode**

- High Q hyperabrupt tuning diode
- Designed for low tuning voltage operation for VCO's in mobile communications equipment
- High ratio at low reverse voltage
- Pb-free (RoHS compliant) package

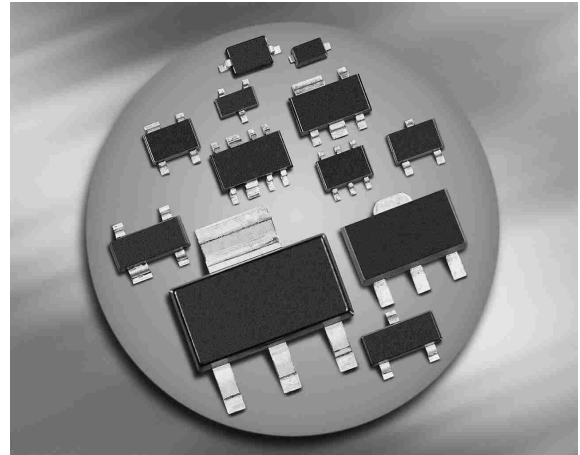

**BBY53-02L**  
**BBY53-02V**  
**BBY53-02W**  
**BBY53-03W**

**BBY53**  
**BBY53-05W**

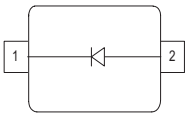

| Type      | Package  | Configuration    | $L_S$ (nH) | Marking |
|-----------|----------|------------------|------------|---------|
| BBY53     | SOT23    | common cathode   | 2          | S7s     |
| BBY53-02L | TSLP-2-1 | single, leadless | 0.4        | LL      |
| BBY53-02V | SC79     | single           | 0.6        | L       |
| BBY53-02W | SCD80    | single           | 0.6        | LL      |
| BBY53-03W | SOD323   | single           | 1.8        | white 5 |
| BBY53-05W | SOT323   | common cathode   | 1.4        | S7s     |

**Maximum Ratings at  $T_A = 25^\circ\text{C}$ , unless otherwise specified**

| Parameter                   | Symbol    | Value       | Unit |
|-----------------------------|-----------|-------------|------|
| Diode reverse voltage       | $V_R$     | 6           | V    |
| Forward current             | $I_F$     | 20          | mA   |
| Operating temperature range | $T_{op}$  | -55 ... 125 | °C   |
| Storage temperature         | $T_{stg}$ | -55 ... 150 |      |

**Electrical Characteristics at  $T_A = 25^\circ\text{C}$ , unless otherwise specified**

| Parameter  | Symbol          | Values |      |      | Unit     |
|--|-----------------|--------|------|------|----------|
|  |                 | min.   | typ. | max. |          |
| <b>DC Characteristics</b>                              |                 |        |      |      |          |
| Reverse current  | $I_R$           |        |      |      | nA       |
| $V_R = 4\text{ V}$                                     |                 | -      | -    | 10   |          |
| $V_R = 4\text{ V}, T_A = 85^\circ\text{C}$             |                 | -      | -    | 200  |          |
| <b>AC Characteristics</b>                              |                 |        |      |      |          |
| Diode capacitance                                      | $C_T$           |        |      |      | pF       |
| $V_R = 1\text{ V}, f = 1\text{ MHz}$                   |                 | 4.8    | 5.3  | 5.8  |          |
| $V_R = 3\text{ V}, f = 1\text{ MHz}$                   |                 | 1.85   | 2.4  | 3.1  |          |
| Capacitance ratio                                      | $C_{T1}/C_{T3}$ | 1.8    | 2.2  | 2.6  | -        |
| $V_R = 1\text{ V}, V_R = 3\text{ V}, f = 1\text{ MHz}$ |                 |        |      |      |          |
| Series resistance                                      | $r_S$           | -      | 0.47 | -    | $\Omega$ |
| $V_R = 1\text{ V}, f = 1\text{ GHz}$                   |                 |        |      |      |          |

**Diode capacitance  $C_T = f(V_R)$**

$f = 1\text{ MHz}$

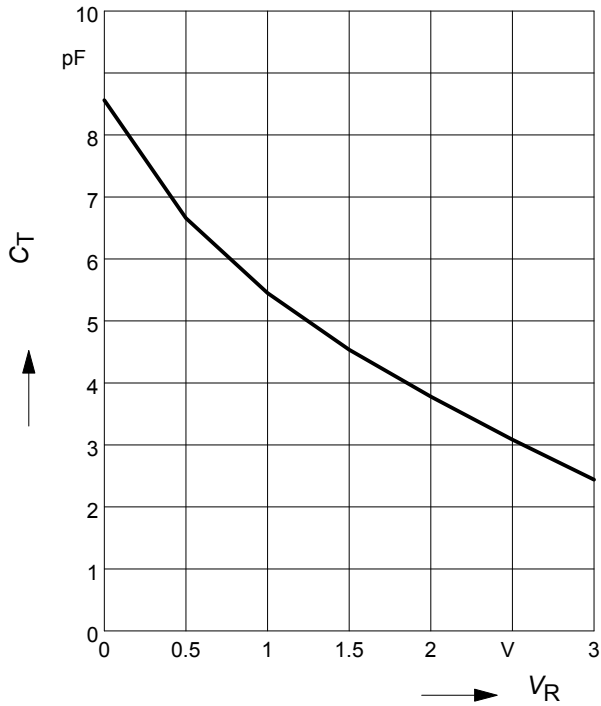

**Capacitance change  $\Delta C = f(T_A)$**

$f = 1\text{ MHz}$

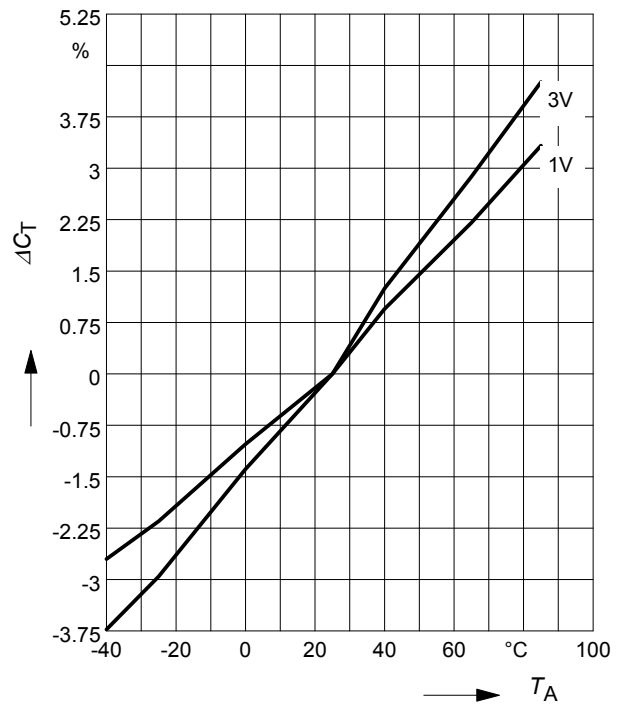

**Temperature coefficient of the diode capacitance  $TC_C = f(V_R)$**

$f = 1\text{ MHz}$

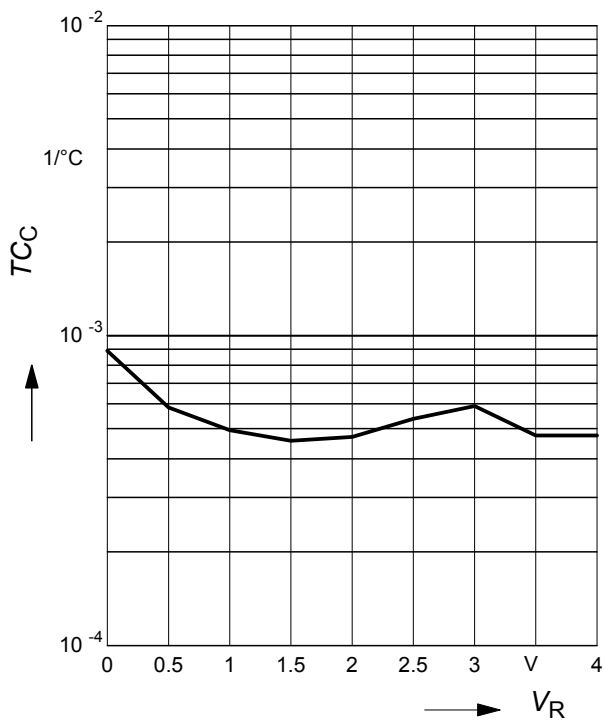

### Package Outline



### Foot Print



### Marking Layout (Example)

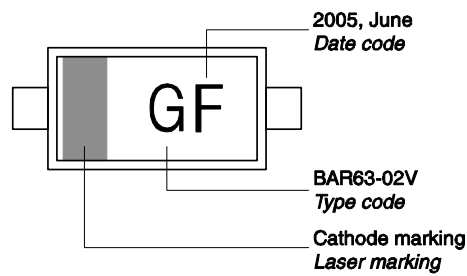

### Standard Packing

- Reel ø180 mm = 3.000 Pieces/Reel
- Reel ø180 mm = 8.000 Pieces/Reel (2 mm Pitch)
- Reel ø330 mm = 10.000 Pieces/Reel

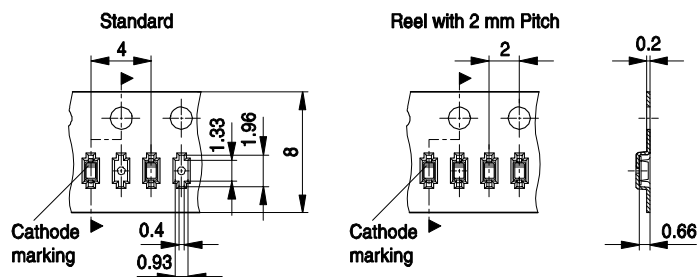

Package Outline

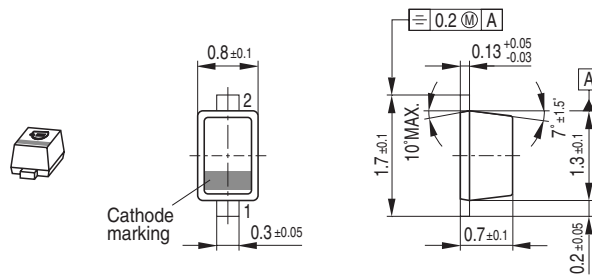

Foot Print



Marking Layout (Example)



Standard Packing

Reel  $\varnothing$ 180 mm = 3.000 Pieces/Reel  
 Reel  $\varnothing$ 180 mm = 8.000 Pieces/Reel (2 mm Pitch)  
 Reel  $\varnothing$ 330 mm = 10.000 Pieces/Reel



Date Code marking for discrete packages with one digit (SCD80, SC79, SC75<sup>1)</sup>) CES-Code

| Month | 2003 | 2004 | 2005 | 2006 | 2007 | 2008 | 2009 | 2010 | 2011 | 2012 | 2013 | 2014 |
|-------|------|------|------|------|------|------|------|------|------|------|------|------|
| 01    | a    | p    | A    | P    | a    | p    | A    | P    | a    | p    | A    | P    |
| 02    | b    | q    | B    | Q    | b    | q    | B    | Q    | b    | q    | B    | Q    |
| 03    | c    | r    | C    | R    | c    | r    | C    | R    | c    | r    | C    | R    |
| 04    | d    | s    | D    | S    | d    | s    | D    | S    | d    | s    | D    | S    |
| 05    | e    | t    | E    | T    | e    | t    | E    | T    | e    | t    | E    | T    |
| 06    | f    | u    | F    | U    | f    | u    | F    | U    | f    | u    | F    | U    |
| 07    | g    | v    | G    | V    | g    | v    | G    | V    | g    | v    | G    | V    |
| 08    | h    | x    | H    | X    | h    | x    | H    | X    | h    | x    | H    | X    |
| 09    | j    | y    | J    | Y    | j    | y    | J    | Y    | j    | y    | J    | Y    |
| 10    | k    | z    | K    | Z    | k    | z    | K    | Z    | k    | z    | K    | Z    |
| 11    | l    | 2    | L    | 4    | l    | 2    | L    | 4    | l    | 2    | L    | 4    |
| 12    | n    | 3    | N    | 5    | n    | 3    | N    | 5    | n    | 3    | N    | 5    |

1) New Marking Layout for SC75, implemented at October 2005.

### Package Outline

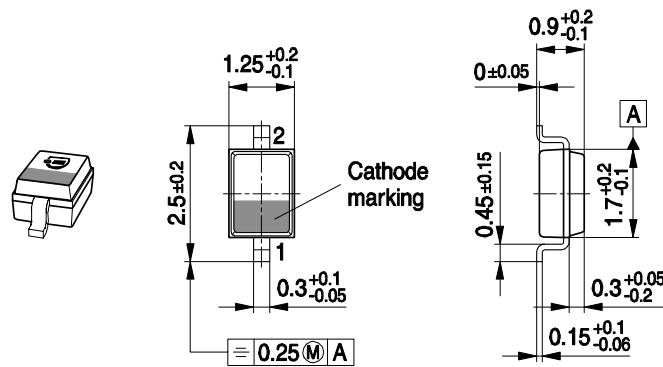

### Foot Print

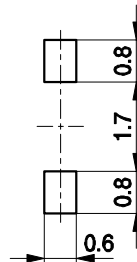

### Marking Layout (Example)



### Standard Packing

Reel  $\varnothing$ 180 mm = 3.000 Pieces/Reel  
 Reel  $\varnothing$ 330 mm = 10.000 Pieces/Reel

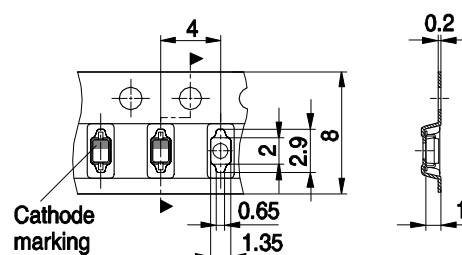

Package Outline



1) Lead width can be 0.6 max. in dambar area

Foot Print



Marking Layout (Example)



Standard Packing

Reel  $\varnothing$ 180 mm = 3.000 Pieces/Reel  
 Reel  $\varnothing$ 330 mm = 10.000 Pieces/Reel





Package Outline



Foot Print



Marking Layout (Example)



Standard Packing

Reel  $\varnothing$ 180 mm = 3.000 Pieces/Reel  
 Reel  $\varnothing$ 330 mm = 10.000 Pieces/Reel



### Package Outline



### Foot Print

For board assembly information please refer to Infineon website "Packages"



### Marking Layout (Example)



### Standard Packing

Reel  $\varnothing$ 180 mm = 15.000 Pieces/Reel  
 Reel  $\varnothing$ 330 mm = 50.000 Pieces/Reel (optional)



**Edition 2009-11-16**

**Published by  
Infineon Technologies AG  
81726 Munich, Germany**

**© 2009 Infineon Technologies AG  
All Rights Reserved.**

### **Legal Disclaimer**

The information given in this document shall in no event be regarded as a guarantee of conditions or characteristics. With respect to any examples or hints given herein, any typical values stated herein and/or any information regarding the application of the device, Infineon Technologies hereby disclaims any and all warranties and liabilities of any kind, including without limitation, warranties of non-infringement of intellectual property rights of any third party.

### **Information**

For further information on technology, delivery terms and conditions and prices, please contact the nearest Infineon Technologies Office ([www.infineon.com](http://www.infineon.com)).

### **Warnings**

Due to technical requirements, components may contain dangerous substances. For information on the types in question, please contact the nearest Infineon Technologies Office.

Infineon Technologies components may be used in life-support devices or systems only with the express written approval of Infineon Technologies, if a failure of such components can reasonably be expected to cause the failure of that life-support device or system or to affect the safety or effectiveness of that device or system. Life support devices or systems are intended to be implanted in the human body or to support and/or maintain and sustain and/or protect human life. If they fail, it is reasonable to assume that the health of the user or other persons may be endangered.

## Данный компонент на территории Российской Федерации

### Вы можете приобрести в компании MosChip.

Для оперативного оформления запроса Вам необходимо перейти по данной ссылке:

<http://moschip.ru/get-element>

Вы можете разместить у нас заказ для любого Вашего проекта, будь то серийное производство или разработка единичного прибора.

В нашем ассортименте представлены ведущие мировые производители активных и пассивных электронных компонентов.

Нашей специализацией является поставка электронной компонентной базы двойного назначения, продукции таких производителей как XILINX, Intel (ex.ALTERA), Vicor, Microchip, Texas Instruments, Analog Devices, Mini-Circuits, Amphenol, Glenair.

Сотрудничество с глобальными дистрибьюторами электронных компонентов, предоставляет возможность заказывать и получать с международных складов практически любой перечень компонентов в оптимальные для Вас сроки.

На всех этапах разработки и производства наши партнеры могут получить квалифицированную поддержку опытных инженеров.

Система менеджмента качества компании отвечает требованиям в соответствии с ГОСТ Р ИСО 9001, ГОСТ РВ 0015-002 и ЭС РД 009

### Офис по работе с юридическими лицами:

105318, г.Москва, ул.Щербаковская д.3, офис 1107, 1118, ДЦ «Щербаковский»

Телефон: +7 495 668-12-70 (многоканальный)

Факс: +7 495 668-12-70 (доб.304)

E-mail: [info@moschip.ru](mailto:info@moschip.ru)

Skype отдела продаж:

moschip.ru

moschip.ru\_4

moschip.ru\_6

moschip.ru\_9