

J-Series SiPM Sensors

Silicon Photomultipliers (SiPM), High PDE and Timing Resolution Sensors in a TSV Package



ON Semiconductor®

www.onsemi.com

ON Semiconductor's J-Series low-light sensors feature a high PDE (photon detection efficiency) that is achieved using a high-volume, P-on-N silicon foundry process. The J-Series sensors incorporate major improvements in the transit time spread which results in a significant improvement in the timing performance of the sensor. J-Series sensors are available in different sizes (3 mm, 4 mm and 6 mm) and use a TSV (Through Silicon Via) process to create a package with minimal deadspace, that is compatible with industry standard lead-free, reflow soldering processes.

The J-Series Silicon Photomultipliers (SiPM) combine high performance with the practical advantages of solid-state technology: low operating voltage, excellent temperature stability, robustness, compactness, output uniformity, and low cost. For more information on the J-Series sensors please refer to the [website](#).



ORDERING INFORMATION

See detailed ordering and shipping information on page 11 of this data sheet.

Table 1. GENERAL PARAMETERS

Parameter (Note 1)	Minimum	Typical	Maximum	Unit
Breakdown Voltage (Vbr) (Note 2)	24.2		24.7	V
Overvoltage (OV)	1		6	V
Operating Voltage (Vop = Vbr + OV)	25.2		30.7	V
Spectral Range (Note 3)	200		900	nm
Peak PDE Wavelength (λ_p)		420		nm
Temperature dependence of Vbr		21.5		mV/°C

1. All measurements made at 21°C unless otherwise stated.
2. The breakdown voltage (Vbr) is defined as the value of the voltage intercept of a straight line fit to a plot of \sqrt{I} vs V, where I is the current and V is the bias voltage.
3. The range where PDE > 2.0% at Vbr + 6.0 V.

Table 2. PHYSICAL PARAMETERS

Parameter	3 mm	4 mm	6 mm
	30020, 30035	40035	60035
Active Area	3.07 × 3.07 mm ²	3.93 × 3.93 mm ²	6.07 × 6.07 mm ²
No. of Microcells	30020: 14,410 30035: 5,676	40035: 9,260	60035: 22,292
Microcell Fill Factor	30020: 62% 30035: 75%	40035: 75%	60035: 75%

J-Series SiPM Sensors

Table 3. PERFORMANCE PARAMETERS

Parameter (Note 4)	30035		40035		60035		Unit
	Overvoltage						Unit
	+2.5 V	+6 V	+2.5 V	+6 V	+2.5 V	+6 V	
PDE (Note 5)	38	50	38	50	38	50	%
Dark Count Rate	50	150	50	150	50	150	kHz/mm ²
Gain (anode-cathode)	2.9×10^6	6.3×10^6	2.9×10^6	6.3×10^6	2.9×10^6	6.3×10^6	
Dark Current – typical	0.23	1.9	0.35	3.0	0.9	7.5	μA
Dark Current – maximum	0.31	3.00	0.45	4.0	1.25	12.0	
Rise Time (Note 6) – anode-cathode output	90	110	90	110	180	250	ps
Microcell Recharge Time Constant (Note 7)	45		48		50		ns
Capacitance (Note 8) (anode output)	1070		1800		4140		pF
Capacitance (Note 8) (fast output)	40		70		160		pF
Fast Output Pulse Width (FWHM)	1.5		1.7		3.0		ns
Crosstalk	8	25	8	25	8	25	%
Afterpulsing	0.75	5.0	0.75	5.0	0.75	5.0	%
Parameter (Note 4)	30020						Unit
	Overvoltage						
	+2.5 V			+5 V			
PDE (Note 5)	30			38			%
Dark Count Rate	50			125			kHz/mm ²
Gain (anode-cathode)	1.0×10^6			1.9×10^6			
Dark Current – typical	0.1			0.45			μA
Dark Current – maximum	0.2			0.72			
Rise Time (Note 6) – anode-cathode output	130			160			ps
Microcell Recharge Time Constant (Note 7)	15						ns
Capacitance (Note 8) (anode output)	1040						pF
Capacitance (Note 8) (fast output)	50						pF
Fast Output Pulse Width (FWHM)	1.4						ns
Crosstalk	2.5			7.5			%
Afterpulsing	0.75			5.0			%

4. All measurements made at 21°C unless otherwise stated.

5. PDE does not contain afterpulsing or crosstalk, and is quoted at the peak wavelength (λ_p).

6. Measured as time to go from 10% to 90% of the peak amplitude and measured over a 1 Ω series output resistor.

7. RC charging time constant of the microcell (τ).

8. Capacitance values are for the complete TSV package.

Table 4. TVS PACKAGE SPECIFICS

	3 mm		4 mm		6 mm	
	30020, 30035		40035		60035	
Package Dimensions	3.16 × 3.16 mm ²		4.00 × 4.00 mm ²		6.13 × 6.13 mm ²	
Recommended Operating Temperature Range	–40°C – +85°C					
Soldering Conditions	Reflow Solder					
Cover Material	Glass					
Cover Refractive Index	1.53 @ 436 nm					
Moisture Sensitivity Level	Tape & reel	MSL3*				
	Cut tape	MSL4*				
Maximum Average Current	10 mA		10 mA		15 mA	

*Please refer to the [TSV Handling and Soldering](#) guide for more information on MSL for different delivery options.

J-Series SiPM Sensors

PERFORMANCE PLOTS



Figure 1. Photon Detection Efficiency (PDE)
(MicroFJ-60035-TSV)



Figure 2. PDE vs. Overvoltage
(MicroFJ-60035-TSV)



Figure 3. PDE vs. Crosstalk
(MicroFJ-60035-TSV)

J-Series SiPM Sensors



Figure 4. Gain vs. Overvoltage
(MicroFJ-30035-TSV)

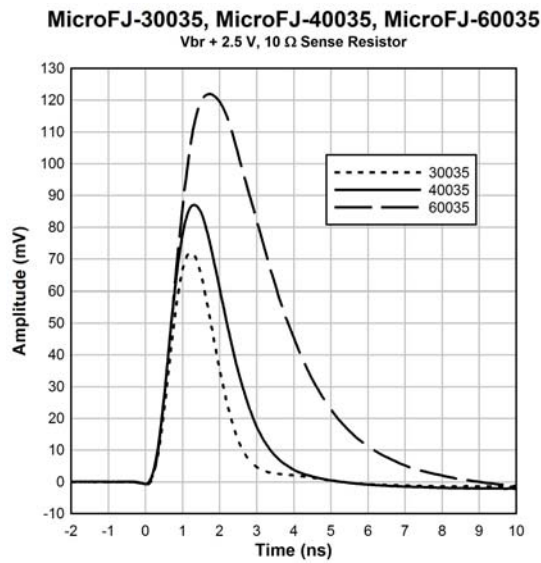

Figure 5. Fast Output Pulse Shape
(MicroFJ-30035, MicroFJ-40035, MicroFJ-60035)
Vbr + 2.5 V, 10 Ω Sense Resistor)

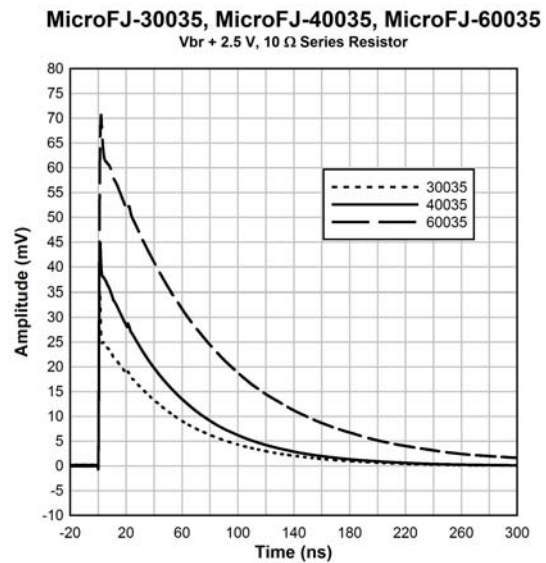

Figure 6. Standard Output Pulse Shape
(MicroFJ-30035, MicroFJ-40035, MicroFJ-60035)
Vbr + 2.5 V, 10 Ω Sense Resistor)

J-Series SiPM Sensors

EVALUATION BOARD OPTIONS

SMA BIASING BOARD (MicroFJ-SMA-XXXXX)

The MicroFJ-SMA is a printed circuit board (PCB) that can facilitate the evaluation of the J-Series sensors. The board has three female SMA connectors for connecting the bias voltage, the standard output from the anode and the fast output signal. The output signals can be connected directly to a 50 Ω-terminated oscilloscope for viewing. The biasing and output signal tracks are laid out in such a way as to preserve the fast timing characteristics of the sensor.

The MicroFJ-SMA is recommended for users who require a plug-and-play set-up to quickly evaluate J-Series TSV sensors with optimum timing performance. The board also allows the standard output from the anode to be observed at the same time as the fast output. The outputs can be connected directly to the oscilloscope or measurement device, but external preamplification may be required to boost the signal. The table below lists the SMA board connections. The SMA board electrical schematics are available to download in the [AND9808/D](#) document.



MicroFJ-SMA-XXXXX	
Output	Function
Vbias	Positive bias input (cathode)
Fout	Fast output
Sout	Standard output (anode)

PIN ADAPTER (MicroFJ-SMTPA-XXXXX)

The TSV Pin Adapter board (SMTPA) is a small PCB board that houses the TSV sensor and has through-hole pins to allow its use with standard sockets or probe clips. This product is useful for those needing a quick way to evaluate the TSV package without the need for specialist surface-mount soldering. While this is a ‘quick fix’ suitable for many evaluations, it should be noted that the timing performance from this board will not be optimized and if the best possible timing performance is required, the MicroFJ-SMA-XXXXX is recommended. The SMTPA

circuit schematic is shown in Figure 8. Please consult the [Readout and Biasing Application Note](#) for further information on biasing. The SMTPA board electrical schematics are available to download in the [AND9808/D](#).



Figure 7. Top View of the SMTPA Board Showing the Pin Numbering

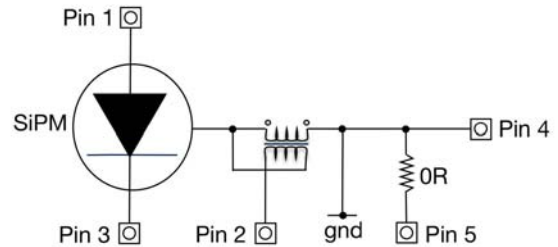

Figure 8. SMTPA Circuit Schematic

MicroFJ-SMTPA-XXXXX	
Pin No.	Connection
1	Anode
2	Fast output
3	Cathode
4	Ground
5	No connect

J-Series SiPM Sensors

CIRCUIT SCHEMATICS

An SiPM is formed of a large number (hundreds or thousands) of microcells. Each microcell (Figure 9) is an avalanche photodiode with its own quench resistor and a capacitively coupled fast output. These microcells are arranged in a close-packed array with all of the like terminals

(e.g. all of the anodes) summed together (Figure 10). The array of microcells can thus be considered as a single photodiode sensor with three terminals: anode, cathode and fast output, as shown in Figure 11.



Figure 10. Simplified Circuit Schematic of the ON Semiconductor SiPM showing only a 12 Microcell Example. Typically, SiPM Sensors have Hundreds or Thousands of Microcells



Figure 9. Circuit Schematic of the ON Semiconductor SiPM Microcell, showing Details of the Fast Output



Figure 11. ON Semiconductor SiPM Component Symbol

TILING OF THE TSV PACKAGE

For the J-Series, ON Semiconductor has developed a market-leading, high-performance package using a TSV process. It is a chip-scale package that is compatible with lead-free, reflow soldering processes. The glass cover is ideal for coupling to scintillators or fibre optic elements.

The dead-space between the sensor active area and the edge of the package has been minimized, resulting in a package that can be tiled on 4 sides with high fill-factor.

This allows multiple sensors to be configured into unique layouts for a wide range of custom applications. The distance between sensor packages can be as little as 200 μm when tiled, but actual alignment and placement tolerances will depend on the accuracy of the user's assembly process. An [Application Note](#) is available that gives advice on creating arrays of the TSV sensors.

J-Series SiPM Sensors

PACKAGE DIMENSIONS

(All Dimensions in mm)

MicroFJ-300XX-TSV



*The 'No Connect' pins are electrically isolated and should be soldered to a ground (or bias) plane to help with heat dissipation.

The MicroFJ-300XX-TSV-A2 CAD, and solder footprint, is available to download [here](#).



J-Series SiPM Sensors

PACKAGE DIMENSIONS

(All Dimensions in mm)

MicroFJ-40035-TSV



BOTTOM VIEW

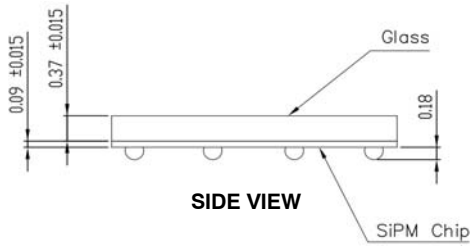

SIDE VIEW

Pin Assignments	
Pin Number	MicroFJ-40035-TSV
B1, C1	Anode
B4, C4	Fast output
A1, D4	Cathode
All others	No Connect*

*The 'No Connect' pins are electrically isolated and should be soldered to a ground (or bias) plane to help with heat dissipation.

The MicroFJ-40035-TSV CAD, and solder footprint, is available to download [here](#).

J-Series SiPM Sensors

PACKAGE DIMENSIONS

(All Dimensions in mm)

MicroFJ-60035-TSV

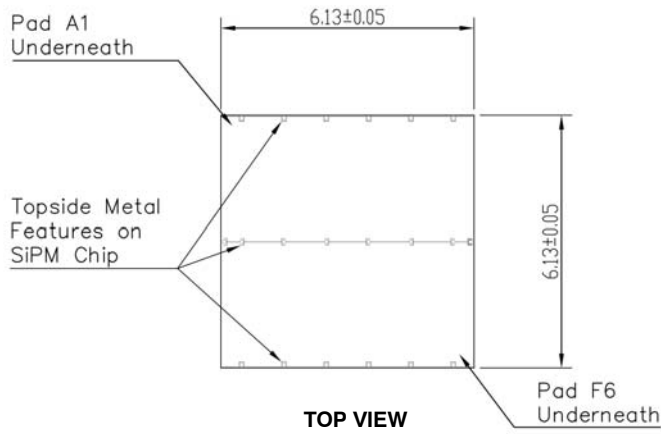

BOTTOM VIEW

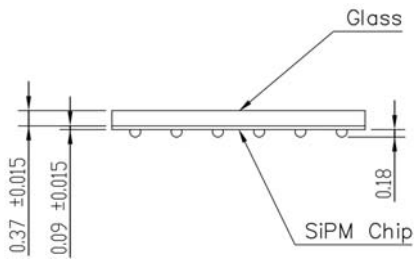

SIDE VIEW

Pin Assignments	
Pin Number	MicroFJ-60035-TSV
C1, D1	Anode
A1, F6	Cathode
C6, D6	Fast output
All others	No Connect*

*The 'No Connect' pins are electrically isolated and should be soldered to a ground (or bias) plane to help with heat dissipation.

The MicroFJ-60035-TSV CAD, and solder footprint, is available to download [here](#).

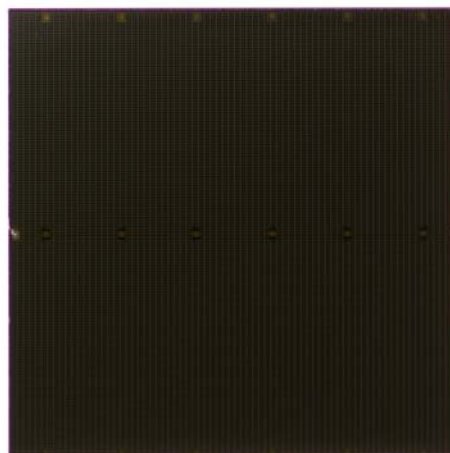
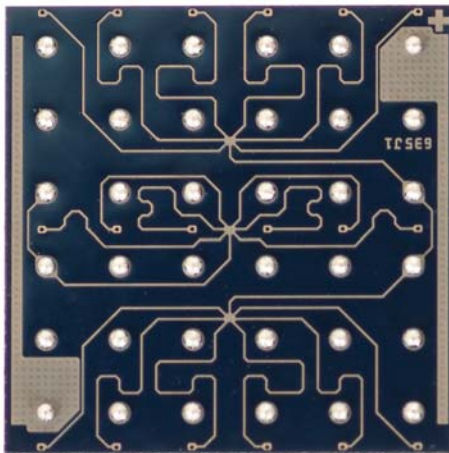

J-Series SiPM Sensors

MicroFJ-SMA-60035 Board



The complete CAD for the SMA boards can be downloaded from the website: [3 mm](#), [4 mm](#) and [6 mm](#) versions.

MicroFJ-SMTPA-60035 Board

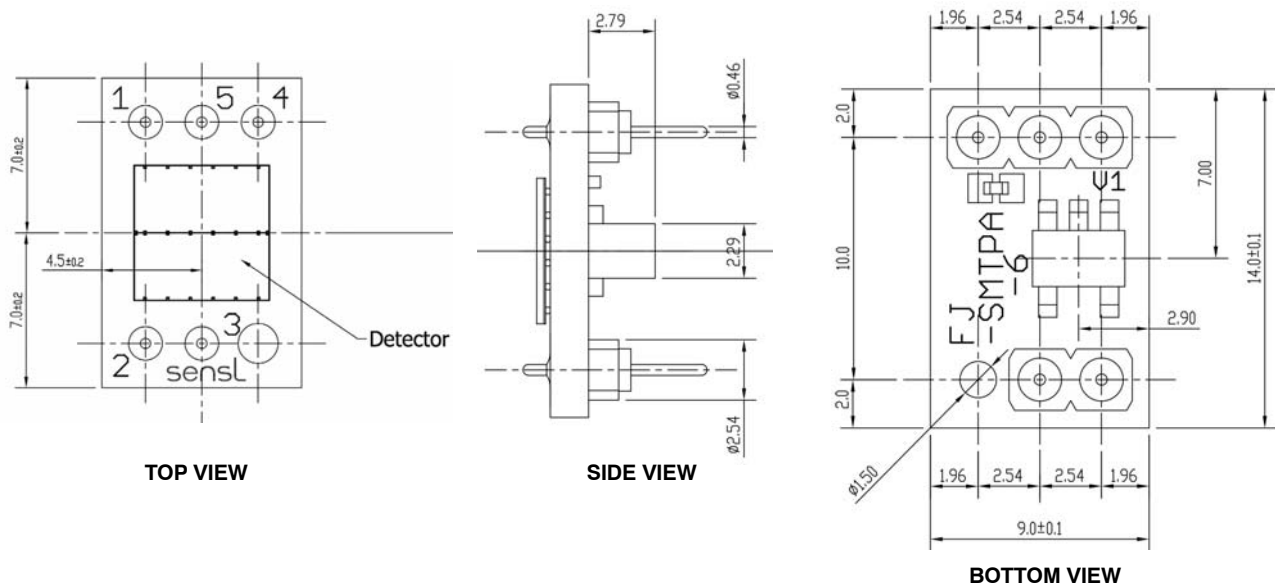

The complete CAD for the SMTPA boards can be downloaded from the website: [3 mm](#) and [6 mm](#) versions.

J-Series SiPM Sensors

ORDERING INFORMATION

Table 5. ORDERING INFORMATION

Product Code	Microcell Size (No. of Microcells)	Sensor Active Area	Description	Delivery Option (Note 9)
3 mm Sensors				
MICROFJ-30020-TSV	20 μm (14,410)	3.07 \times 3.07 mm	4-side tileable, chip scale package with through-silicon vias (TSV)	TR1, TR
MICROFJ-SMA-30020-GEVB			TSV sensor mounted onto a PCB with three SMA connectors for bias, standard output and fast output	PK
MICROFJ-SMTPA-30020-GEVB			TSV sensor mounted onto a pin adapter board	PK
MICROFJ-30035-TSV	35 μm (5,676)		4-side tileable, chip scale package with through-silicon vias (TSV)	TR1, TR
MICROFJ-SMA-30035-GEVB			TSV sensor mounted onto a PCB with three SMA connectors for bias, standard output and fast output	PK
MICROFJ-SMTPA-30035-GEVB			TSV sensor mounted onto a pin adapter board	PK
4 mm Sensors				
MICROFJ-40035-TSV	35 μm (9,260)	3.93 \times 3.93 mm	4-side tileable, chip scale package with through-silicon vias (TSV)	TR1, TR
MICROFJ-SMA-40035-GEVB			TSV sensor mounted onto a PCB with three SMA connectors for bias, standard output and fast output.	PK
6 mm Sensors				
MICROFJ-60035-TSV	35 μm (22,292)	6.07 \times 6.07 mm	4-side tileable, chip scale package with through-silicon vias (TSV)	TR1, TR
MICROFJ-SMA-60035-GEVB			TSV sensor mounted onto a PCB with three SMA connectors for bias, standard output and fast output	PK
MICROFJ-SMTPA-60035-GEVB			TSV sensor mounted onto a pin adapter board	PK

9. The two-letter delivery option code should be appended to the order number, e.g.) to receive a MICROFJ-60035-TSV on tape and reel, use MICROFJ-60035-TSV-TR. The codes are as follows:
 PK = ESD Package
 TR1 = Tape
 TR = Tape and Reel

There is a minimum order quantity (MOQ) of 3000 for the tape and reel (TR) option. Quantities less than this are available on tape (-TR1). The TR option is only available in multiples of the MOQ.

J-Series SiPM Sensors

SensL is a registered trademark of Semiconductor Components Industries, LLC (SCILLC) or its subsidiaries in the United States and/or other countries.

ON Semiconductor and  are trademarks of Semiconductor Components Industries, LLC dba ON Semiconductor or its subsidiaries in the United States and/or other countries. ON Semiconductor owns the rights to a number of patents, trademarks, copyrights, trade secrets, and other intellectual property. A listing of ON Semiconductor's product/patent coverage may be accessed at www.onsemi.com/site/pdf/Patent-Marking.pdf. ON Semiconductor reserves the right to make changes without further notice to any products herein. ON Semiconductor makes no warranty, representation or guarantee regarding the suitability of its products for any particular purpose, nor does ON Semiconductor assume any liability arising out of the application or use of any product or circuit, and specifically disclaims any and all liability, including without limitation special, consequential or incidental damages. Buyer is responsible for its products and applications using ON Semiconductor products, including compliance with all laws, regulations and safety requirements or standards, regardless of any support or applications information provided by ON Semiconductor. "Typical" parameters which may be provided in ON Semiconductor data sheets and/or specifications can and do vary in different applications and actual performance may vary over time. All operating parameters, including "Typicals" must be validated for each customer application by customer's technical experts. ON Semiconductor does not convey any license under its patent rights nor the rights of others. ON Semiconductor products are not designed, intended, or authorized for use as a critical component in life support systems or any FDA Class 3 medical devices or medical devices with a same or similar classification in a foreign jurisdiction or any devices intended for implantation in the human body. Should Buyer purchase or use ON Semiconductor products for any such unintended or unauthorized application, Buyer shall indemnify and hold ON Semiconductor and its officers, employees, subsidiaries, affiliates, and distributors harmless against all claims, costs, damages, and expenses, and reasonable attorney fees arising out of, directly or indirectly, any claim of personal injury or death associated with such unintended or unauthorized use, even if such claim alleges that ON Semiconductor was negligent regarding the design or manufacture of the part. ON Semiconductor is an Equal Opportunity/Affirmative Action Employer. This literature is subject to all applicable copyright laws and is not for resale in any manner.

PUBLICATION ORDERING INFORMATION

LITERATURE FULFILLMENT:

Literature Distribution Center for ON Semiconductor
19521 E. 32nd Pkwy, Aurora, Colorado 80011 USA
Phone: 303-675-2175 or 800-344-3860 Toll Free USA/Canada
Fax: 303-675-2176 or 800-344-3867 Toll Free USA/Canada
Email: orderlit@onsemi.com

N. American Technical Support: 800-282-9855 Toll Free
USA/Canada
Europe, Middle East and Africa Technical Support:
Phone: 421 33 790 2910

ON Semiconductor Website: www.onsemi.com
Order Literature: <http://www.onsemi.com/orderlit>

For additional information, please contact your local Sales Representative

Данный компонент на территории Российской Федерации

Вы можете приобрести в компании MosChip.

Для оперативного оформления запроса Вам необходимо перейти по данной ссылке:

<http://moschip.ru/get-element>

Вы можете разместить у нас заказ для любого Вашего проекта, будь то серийное производство или разработка единичного прибора.

В нашем ассортименте представлены ведущие мировые производители активных и пассивных электронных компонентов.

Нашей специализацией является поставка электронной компонентной базы двойного назначения, продукции таких производителей как XILINX, Intel (ex.ALTERA), Vicor, Microchip, Texas Instruments, Analog Devices, Mini-Circuits, Amphenol, Glenair.

Сотрудничество с глобальными дистрибьюторами электронных компонентов, предоставляет возможность заказывать и получать с международных складов практически любой перечень компонентов в оптимальные для Вас сроки.

На всех этапах разработки и производства наши партнеры могут получить квалифицированную поддержку опытных инженеров.

Система менеджмента качества компании отвечает требованиям в соответствии с ГОСТ Р ИСО 9001, ГОСТ РВ 0015-002 и ЭС РД 009

Офис по работе с юридическими лицами:

105318, г.Москва, ул.Щербаковская д.3, офис 1107, 1118, ДЦ «Щербаковский»

Телефон: +7 495 668-12-70 (многоканальный)

Факс: +7 495 668-12-70 (доб.304)

E-mail: info@moschip.ru

Skype отдела продаж:

moschip.ru

moschip.ru_4

moschip.ru_6

moschip.ru_9