

## VERONICA-SQ-W

~50° wide beam

### TECHNICAL SPECIFICATIONS:

Dimensions	22.5 mm
Height	11.8 mm
Fastening	tape
ROHS compliant	yes 

### MATERIAL SPECIFICATIONS:

Component	Type	Material	Colour	Finish
VERONICA-SQ-W	Single lens	PMMA	clear	
VERONICA-TAPE	Tape	PU tape	clear	

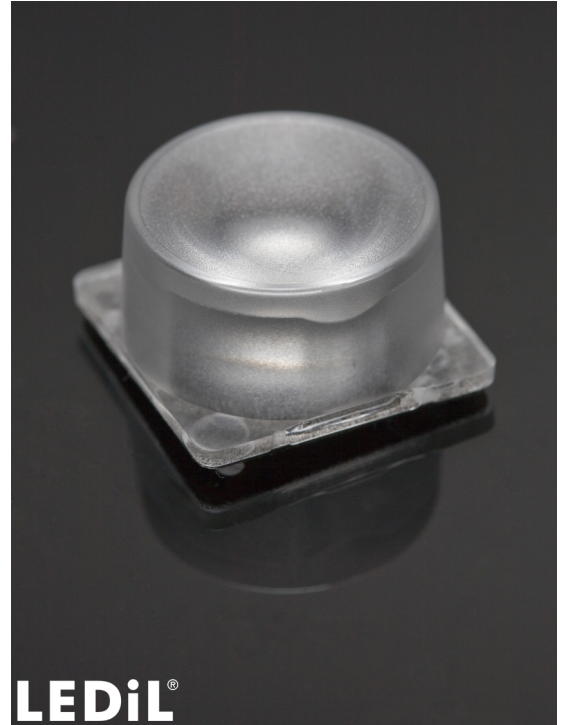

### ORDERING INFORMATION:

Component		Qty in box	MOQ	MPQ	Box weight (kg)
CA14442_VERONICA-SQ-W	Single lens	1980	360	180	8.8
» Box size: 476 x 273 x 197 mm					

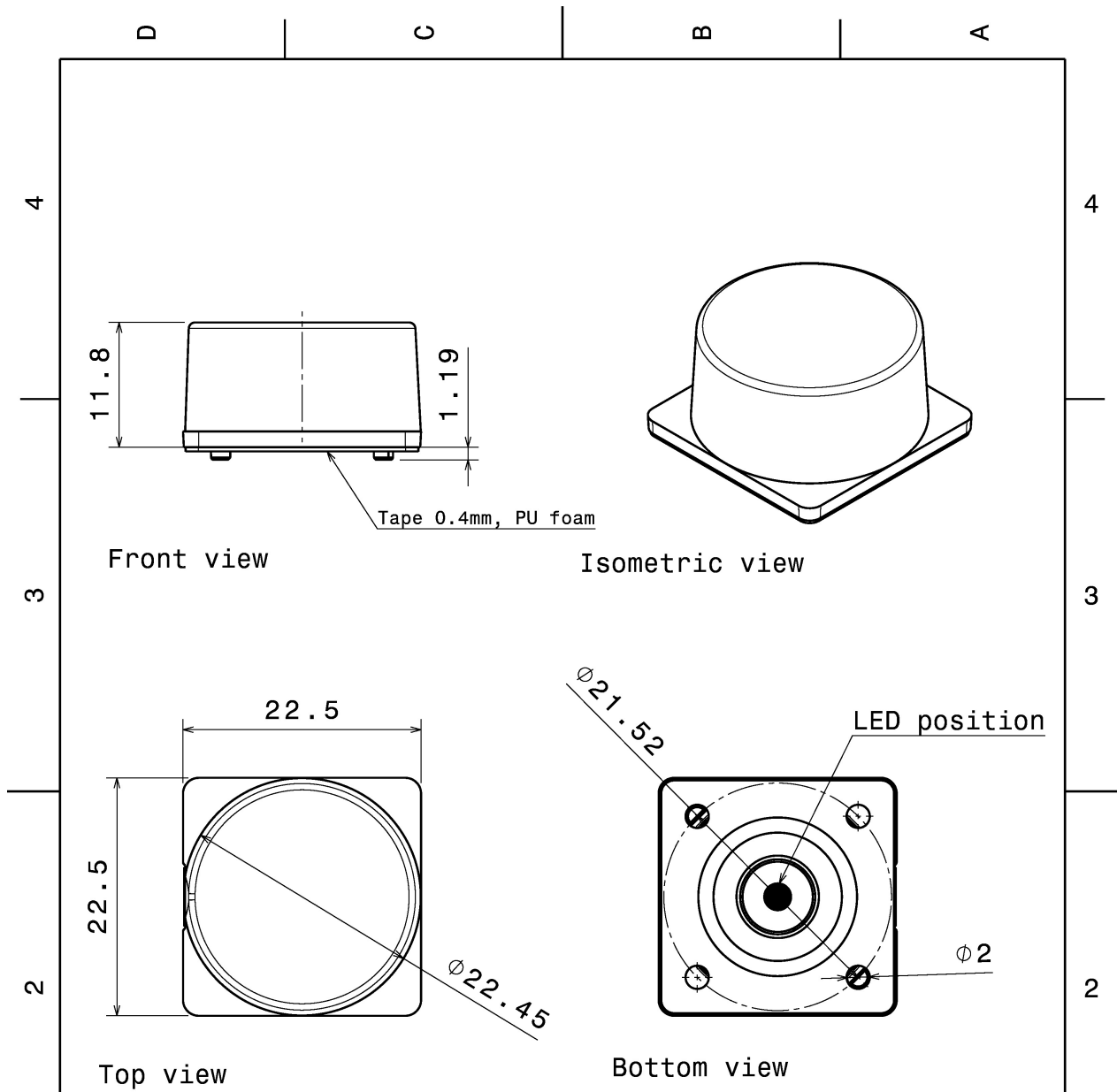

INDEX	PART NO	DESCRIPTION	MATERIAL	COLOUR
1	C14447	VERONICA-SQ-W	PMMA	clear

Tolerances if not otherwise shown  
According to DIN ISO 2768-1  
Linear measures:  
Up to 30mm class M, otherwise class C  
According to DIN ISO 2768-2  
Form and position: class L

**LEDiL**

Ledil Oy  
Salorankatu 10  
FIN 24240 SALO  
Finland

THIRD ANGLE PROJECTION:

DRAWING TITLE

CA14442\_VERONICA-SQ-W

This drawing is the property of LEDiL Oy. It may not be reproduced, copied or communicated without a written agreement with LEDiL Oy.

SIZE PART NUMBER

A4

CA14442

SCALE 2:1 WEIGHT 3,90 g SHEET 1/1

### PHOTOMETRIC DATA (MEASURED):

#### CREE

LED XB-H  
 FWHM 50.0°  
 Efficiency 80 %  
 Peak intensity 0.9 cd/lm  
 LEDs/each optic 1  
 Light colour White  
 Required components:

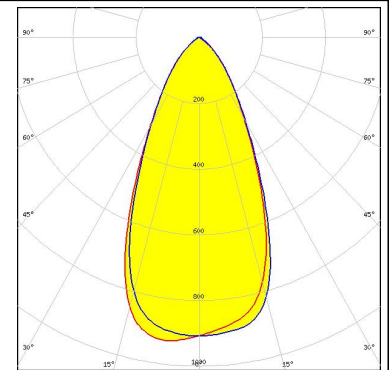

#### CREE

LED XHP35 HD  
 FWHM 52.0°  
 Efficiency 78 %  
 Peak intensity 1 cd/lm  
 LEDs/each optic 1  
 Light colour White  
 Required components:

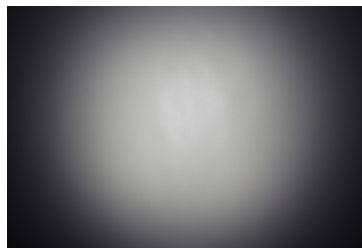

#### CREE

LED XHP35 HI  
 FWHM 49.0°  
 Efficiency 81 %  
 Peak intensity 1.1 cd/lm  
 LEDs/each optic 1  
 Light colour White  
 Required components:

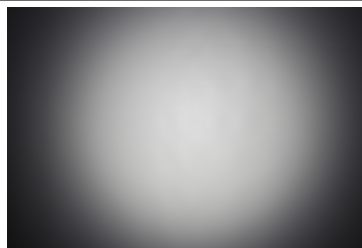

#### CREE

LED XHP50.2  
 FWHM 47.0°  
 Efficiency 86 %  
 Peak intensity 1 cd/lm  
 LEDs/each optic 1  
 Light colour White  
 Required components:

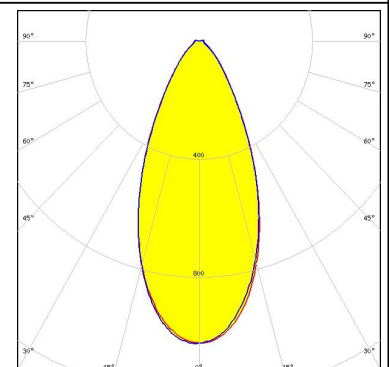
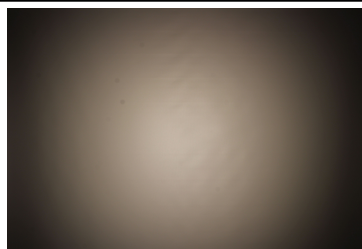

#### PHOTOMETRIC DATA (MEASURED):

#### **CREE**

LED XM-L  
 FWHM 53.0°  
 Efficiency 81 %  
 Peak intensity 0.9 cd/lm  
 LEDs/each optic 1  
 Light colour White  
 Required components:

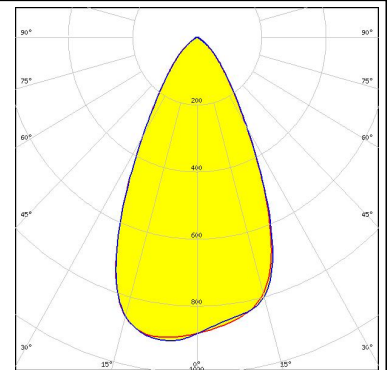
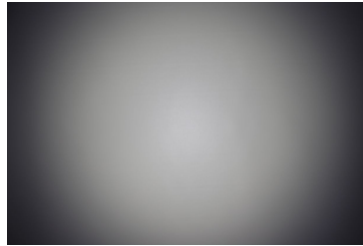

#### **CREE**

LED XM-L2  
 FWHM 53.0°  
 Efficiency 80 %  
 Peak intensity 0.9 cd/lm  
 LEDs/each optic 1  
 Light colour White  
 Required components:

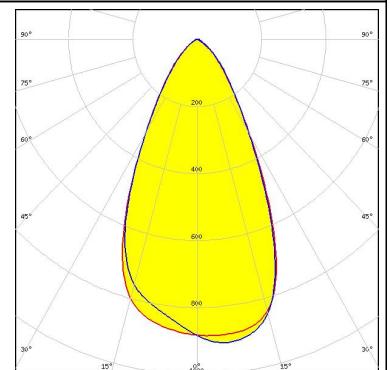
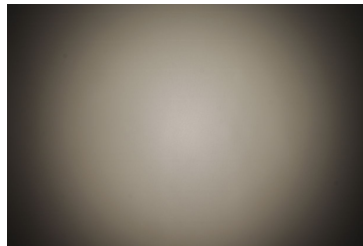

#### **CREE**

LED XP-E  
 FWHM 51.0°  
 Efficiency 81 %  
 Peak intensity 1 cd/lm  
 LEDs/each optic 1  
 Light colour White  
 Required components:

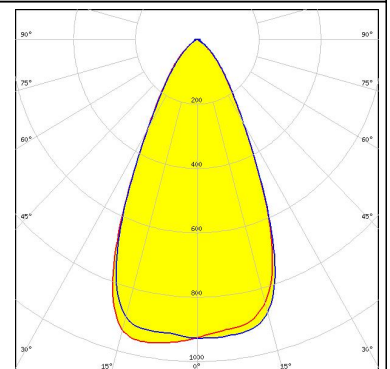
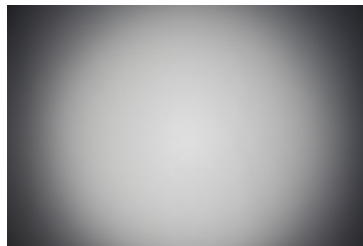

#### **CREE**

LED XP-E2  
 FWHM 52.0°  
 Efficiency 92 %  
 Peak intensity 1.2 cd/lm  
 LEDs/each optic 1  
 Light colour White  
 Required components:

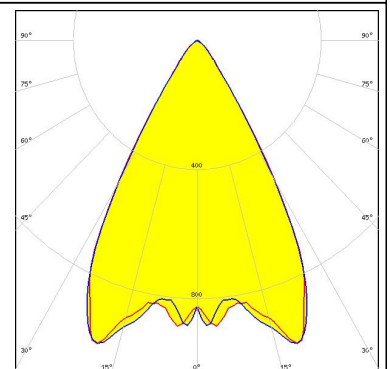
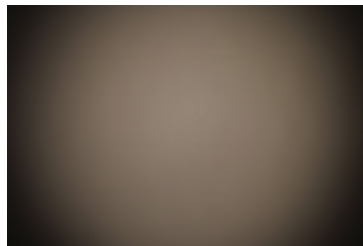

#### PHOTOMETRIC DATA (MEASURED):



LED XP-G  
 FWHM 53.0°  
 Efficiency 81 %  
 Peak intensity 0.9 cd/lm  
 LEDs/each optic 1  
 Light colour White  
 Required components:

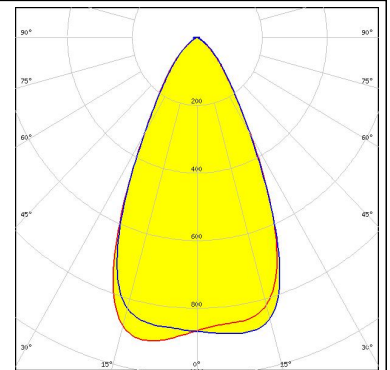
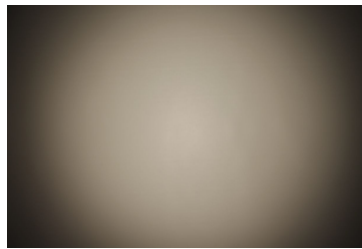

LED XT-E  
 FWHM 46.0°  
 Efficiency 80 %  
 Peak intensity 1.1 cd/lm  
 LEDs/each optic 1  
 Light colour White  
 Required components:

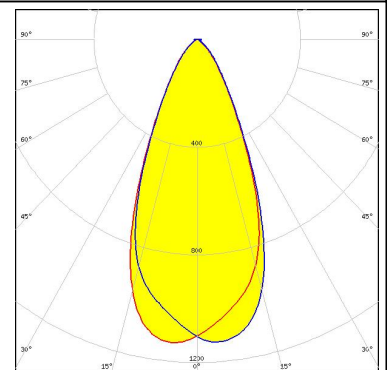
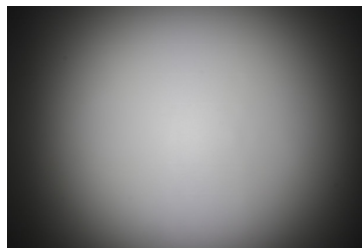

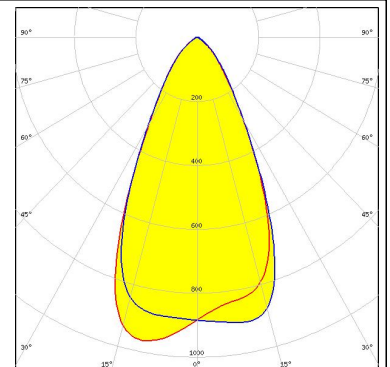
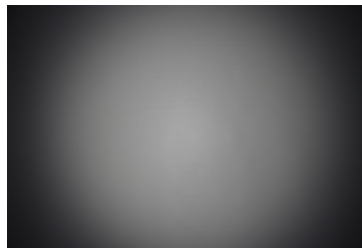

LED H35C1 (LEMWA33)  
 FWHM 52.0°  
 Efficiency 81 %  
 Peak intensity 1 cd/lm  
 LEDs/each optic 1  
 Light colour White  
 Required components:

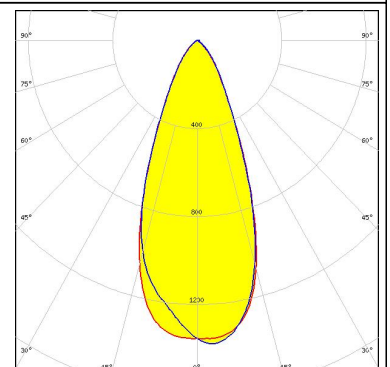
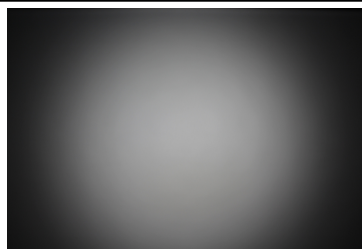

LED LUXEON 3030 2D (Round LES)  
 FWHM 42.0°  
 Efficiency 83 %  
 Peak intensity 1.4 cd/lm  
 LEDs/each optic 1  
 Light colour White  
 Required components:

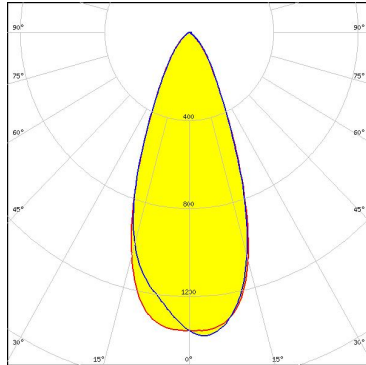
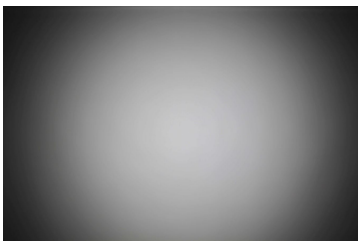
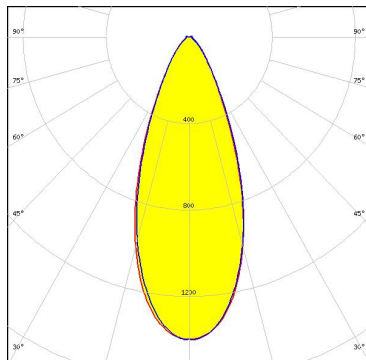

### PHOTOMETRIC DATA (MEASURED):

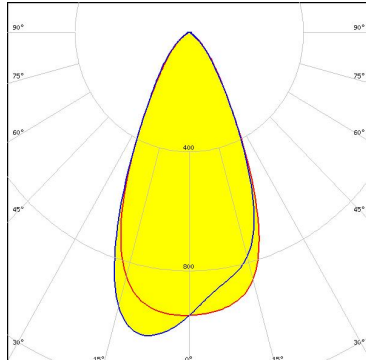
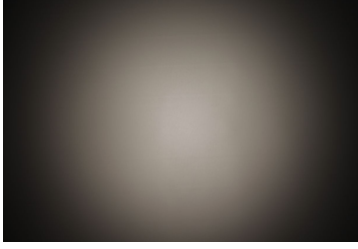
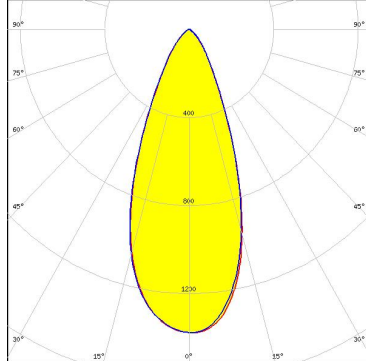
<p><b>LUMILEDS</b></p> <p>LED LUXEON 3030 2D (Square LES)</p> <p>FWHM 42.0°</p> <p>Efficiency 83 %</p> <p>Peak intensity 1.4 cd/lm</p> <p>LEDs/each optic 1</p> <p>Light colour White</p> <p>Required components:</p>		
<p><b>LUMILEDS</b></p> <p>LED LUXEON 5050 Round LES</p> <p>FWHM 41.0°</p> <p>Efficiency 90 %</p> <p>Peak intensity 1.4 cd/lm</p> <p>LEDs/each optic 1</p> <p>Light colour White</p> <p>Required components:</p>		
<p><b>LUMILEDS</b></p> <p>LED LUXEON A</p> <p>FWHM 50.0°</p> <p>Efficiency 79 %</p> <p>Peak intensity 1 cd/lm</p> <p>LEDs/each optic 1</p> <p>Light colour White</p> <p>Required components:</p>		
<p><b>LUMILEDS</b></p> <p>LED LUXEON MZ</p> <p>FWHM 41.0°</p> <p>Efficiency 83 %</p> <p>Peak intensity 1.4 cd/lm</p> <p>LEDs/each optic 1</p> <p>Light colour White</p> <p>Required components:</p>		

### PHOTOMETRIC DATA (MEASURED):

#### LUMILEDS

LED LUXEON R  
 FWHM 48.0°  
 Efficiency 80 %  
 Peak intensity 1.1 cd/lm  
 LEDs/each optic 1  
 Light colour White  
 Required components:

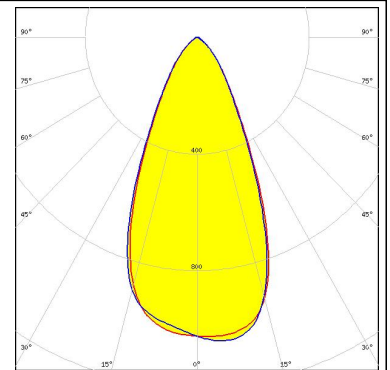
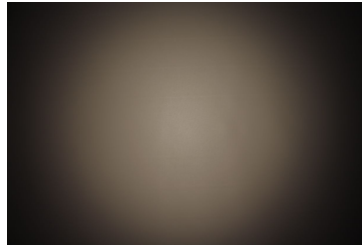

#### LUMILEDS

LED LUXEON Rebel ES  
 FWHM 46.0°  
 Efficiency 80 %  
 Peak intensity 1.1 cd/lm  
 LEDs/each optic 1  
 Light colour White  
 Required components:

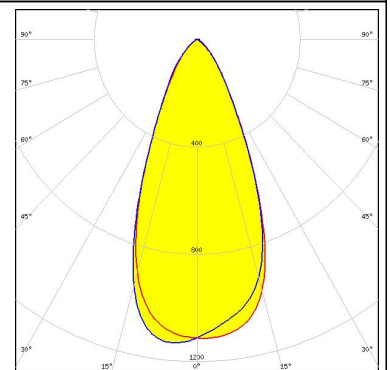
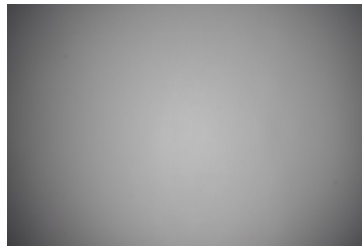

#### LUMILEDS

LED LUXEON T  
 FWHM 49.0°  
 Efficiency 82 %  
 Peak intensity 1 cd/lm  
 LEDs/each optic 1  
 Light colour White  
 Required components:

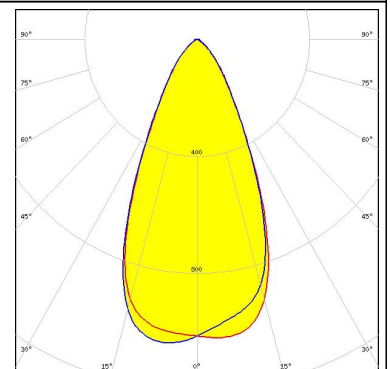
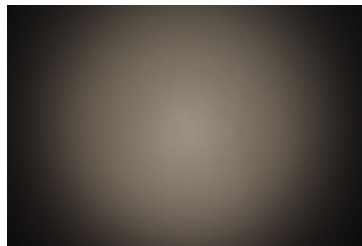

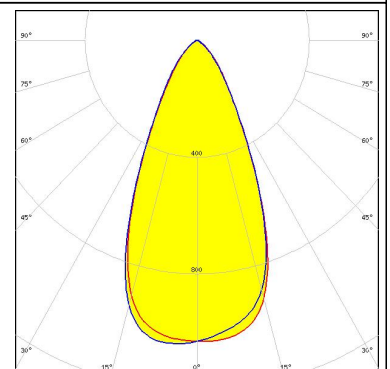
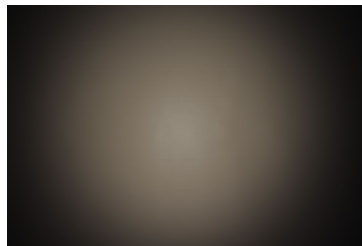

#### LUMILEDS

LED LUXEON TX  
 FWHM 48.0°  
 Efficiency 81 %  
 Peak intensity 1 cd/lm  
 LEDs/each optic 1  
 Light colour White  
 Required components:

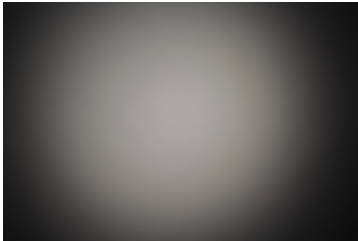
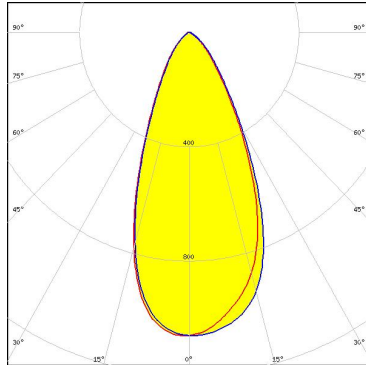
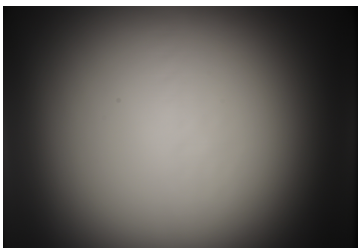
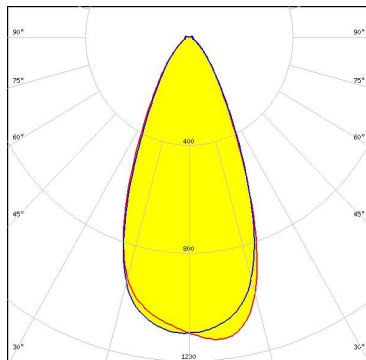

#### PHOTOMETRIC DATA (MEASURED):

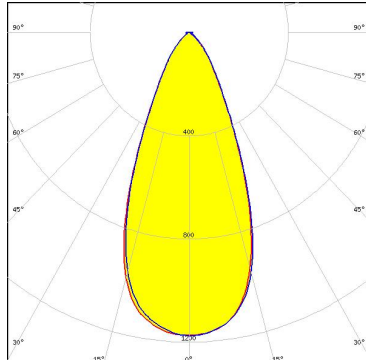
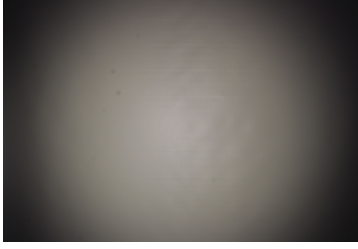
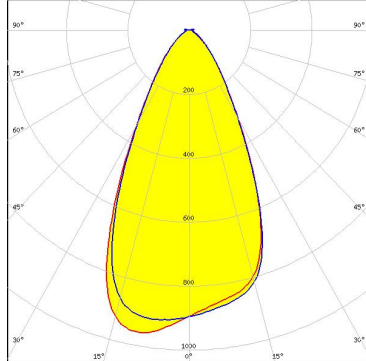
<p><b>LUMILEDS</b></p> <p>LED LUXEON V            FWHM 46.0°            Efficiency 79 %            Peak intensity 1.1 cd/lm            LEDs/each optic 1            Light colour White            Required components:</p>		
<p><b>LUMILEDS</b></p> <p>LED LUXEON V2            FWHM 47.0°            Efficiency 88 %            Peak intensity 1.1 cd/lm            LEDs/each optic 1            Light colour White            Required components:</p>		
<p><b>NICHIA</b></p> <p>LED NCSxx19B            FWHM 45.0°            Efficiency 80 %            Peak intensity 1.2 cd/lm            LEDs/each optic 1            Light colour White            Required components:</p>		
<p><b>NICHIA</b></p> <p>LED NVSW219F            FWHM 52.0°            Efficiency 88 %            Peak intensity 1 cd/lm            LEDs/each optic 1            Light colour White            Required components:</p>		



### PHOTOMETRIC DATA (MEASURED):



LED NVSW3x9A  
 FWHM 48.0°  
 Efficiency 78 %  
 Peak intensity 1.1 cd/lm  
 LEDs/each optic 1  
 Light colour White  
 Required components:

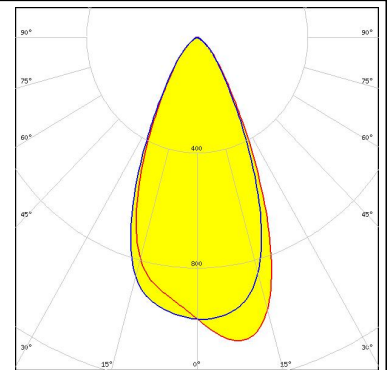

LED NVSxx19B/NVSxx19C  
 FWHM 46.0°  
 Efficiency 81 %  
 Peak intensity 1.1 cd/lm  
 LEDs/each optic 1  
 Light colour White  
 Required components:

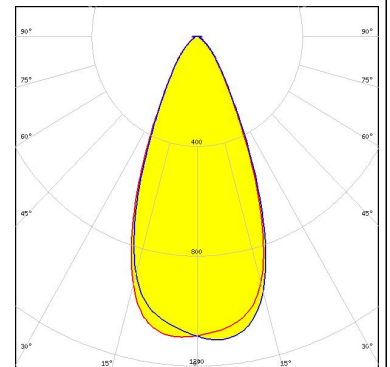
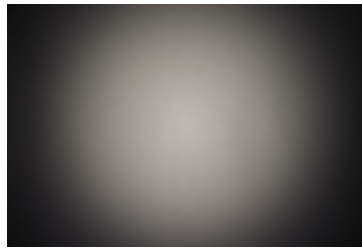

LED NWSx229A  
 FWHM 51.0°  
 Efficiency 78 %  
 Peak intensity 0.9 cd/lm  
 LEDs/each optic 1  
 Light colour White  
 Required components:

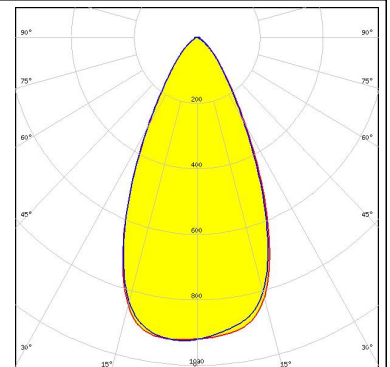
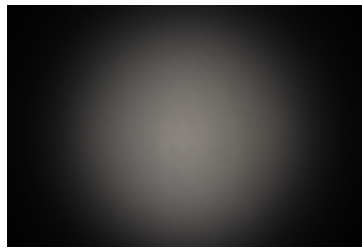

LED OSLON Square EC  
 FWHM 48.0°  
 Efficiency 80 %  
 Peak intensity 1.1 cd/lm  
 LEDs/each optic 1  
 Light colour White  
 Required components:

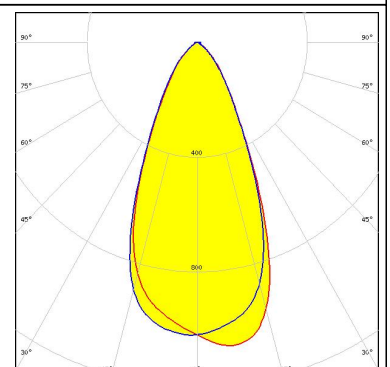
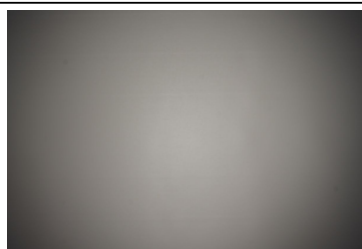

### PHOTOMETRIC DATA (MEASURED):

#### OSRAM

Opto Semiconductors

LED OSLON Square PC  
 FWHM 48.0°  
 Efficiency 79 %  
 Peak intensity 1.1 cd/lm  
 LEDs/each optic 1  
 Light colour White  
 Required components:

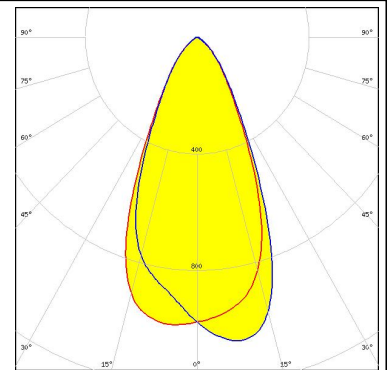
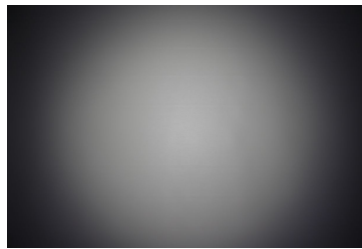

#### OSRAM

Opto Semiconductors

LED OSLON SSL 80  
 FWHM 46.0°  
 Efficiency 80 %  
 Peak intensity 1.1 cd/lm  
 LEDs/each optic 1  
 Light colour White  
 Required components:

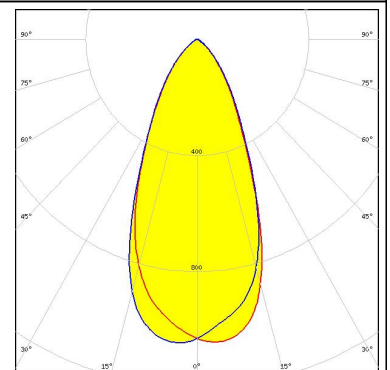
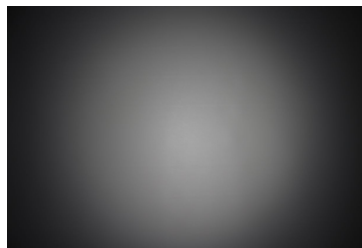

#### SAMSUNG

LED LH181A  
 FWHM 34.0°  
 Efficiency 87 %  
 Peak intensity 1.7 cd/lm  
 LEDs/each optic 1  
 Light colour White  
 Required components:

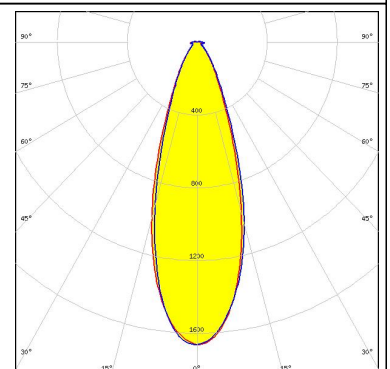
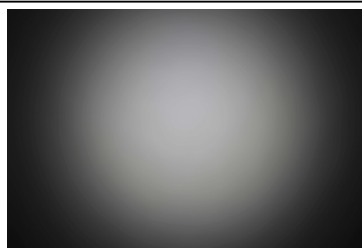





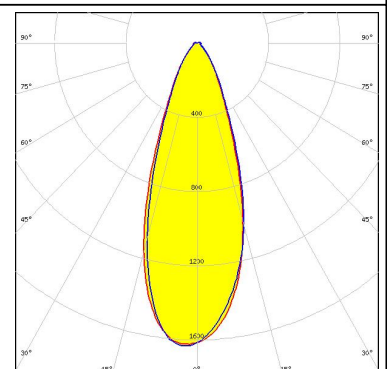
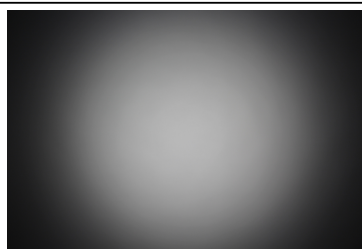

#### SAMSUNG

LED LH181B  
 FWHM 37.0°  
 Efficiency 90 %  
 Peak intensity 1.6 cd/lm  
 LEDs/each optic 1  
 Light colour White  
 Required components:

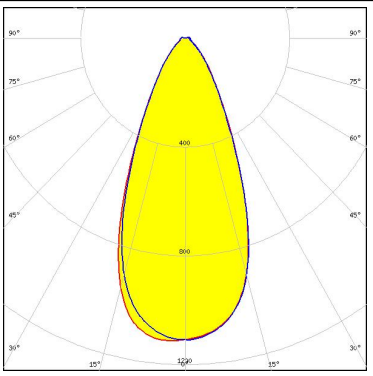

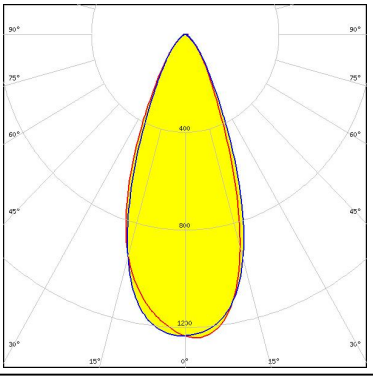
**PHOTOMETRIC DATA (MEASURED):**

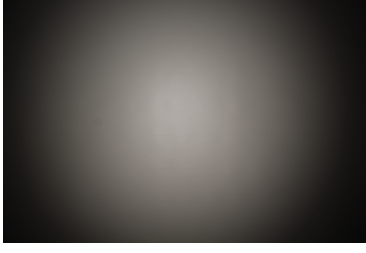
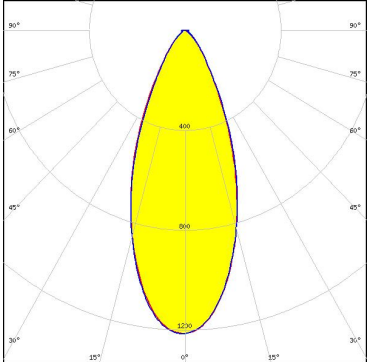
<p> SEUL SEMICONDUCTOR</p> <p>LED Z5M3 FWHM 46.0° Efficiency 88 % Peak intensity 1.1 cd/lm LEDs/each optic 1 Light colour White Required components:</p>		
<p> SEUL SEMICONDUCTOR</p> <p>LED Z8Y22P FWHM 42.0° Efficiency 78 % Peak intensity 1.2 cd/lm LEDs/each optic 1 Light colour White Required components:</p>		
<p> SEUL SEMICONDUCTOR</p> <p>LED Z8Y50P FWHM 42.0° Efficiency 77 % Peak intensity 1.2 cd/lm LEDs/each optic 1 Light colour White Required components:</p>		

#### PHOTOMETRIC DATA (SIMULATED):



LED XP-G2 HE  
 FWHM 62.0°  
 Efficiency 97 %  
 Peak intensity 0.8 cd/lm  
 LEDs/each optic 1  
 Light colour White  
 Required components:

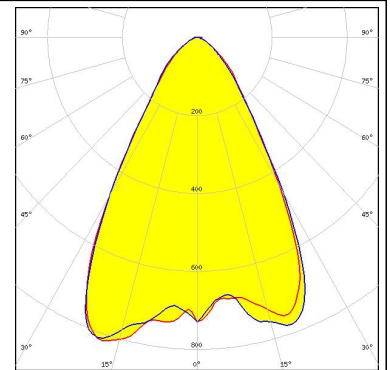

LED LUXEON M/MX  
 FWHM 45.0°  
 Efficiency 94 %  
 Peak intensity 1.4 cd/lm  
 LEDs/each optic 1  
 Light colour White  
 Required components:

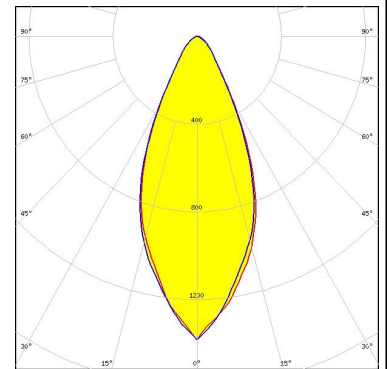

LED NV4x144A  
 FWHM 54.0°  
 Efficiency 89 %  
 Peak intensity 1 cd/lm  
 LEDs/each optic 1  
 Light colour White  
 Required components:

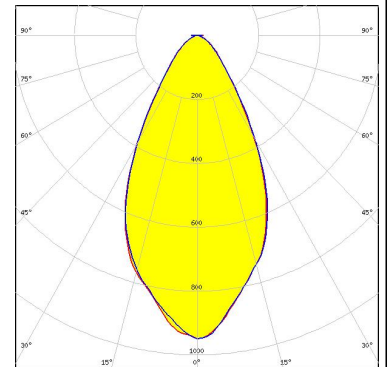

LED OSCONIQ C 2424  
 FWHM 32.0°  
 Efficiency 94 %  
 Peak intensity 2 cd/lm  
 LEDs/each optic 4  
 Light colour White  
 Required components:

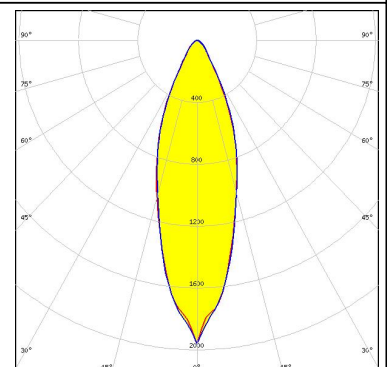

### PHOTOMETRIC DATA (SIMULATED):

<p><b>OSRAM</b> Opto Semiconductors</p> <p>LED                   OSCONIQ P 3030</p> <p>FWHM                48.0°</p> <p>Efficiency           95 %</p> <p>Peak intensity      1.3 cd/lm</p> <p>LEDs/each optic    1</p> <p>Light colour        White</p> <p>Required components:</p>	
<p><b>OSRAM</b> Opto Semiconductors</p> <p>LED                   OSCONIQ P 7070</p> <p>FWHM                42.0°</p> <p>Efficiency           90 %</p> <p>Peak intensity      1.4 cd/lm</p> <p>LEDs/each optic    1</p> <p>Light colour        White</p> <p>Required components:</p>	
<p><b>OSRAM</b> Opto Semiconductors</p> <p>LED                   OSLON Square CSSRM2/CSSRM3</p> <p>FWHM                50.0°</p> <p>Efficiency           90 %</p> <p>Peak intensity      1.1 cd/lm</p> <p>LEDs/each optic    1</p> <p>Light colour        White</p> <p>Required components:</p>	
<p><b>SEOUL SEMICONDUCTOR</b></p> <p>LED                   Z8Y22T</p> <p>FWHM                41.0°</p> <p>Efficiency           94 %</p> <p>Peak intensity      1.7 cd/lm</p> <p>LEDs/each optic    1</p> <p>Light colour        White</p> <p>Required components:</p>	

### GENERAL INFORMATION:

NOTE: The typical beam angle will be changed by different color, chip size and chip position tolerance. The typical total beam angle is the full angle measured where the luminous intensity is half of the peak value.

### MATERIALS:

As part of our continuous research and improvement processes, and to ensure the best possible quality and availability of our products, LEDiL reserves the right to change material grades without notice.

### PRODUCT DATA USER AGREEMENT AND DISCLAIMER:

The measured data in the provided downloadable LEDiL Product Datasheets and Mechanical 2D-Drawings is rounded and provided as reference for planning. LEDiL Oy's optical specifications have been verified by conducting performance testing of the products in accordance with the company's quality system. The reported data are averaged results of multiple measurements with typical variation. LEDiL Oy reserves the right to without prior notification make changes and improvements to its products.

LEDiL Oy assumes neither warranty, nor guarantee nor any other liability of any kind for the contents and correctness of the provided data. The provided data has been generated with highest diligence but the provided data may in reality not represent the complete possible variation range of all intrinsic parameters. Therefore, in certain cases a deviation from the provided data could occur.

LEDiL Oy reserves the right to undertake technical changes of its products without further notification which could lead to changes in the provided data. LEDiL Oy assumes no liability of any kind for the possible deviation from any provided data or any other damage resulting from the usage of the provided data.

The user agrees to this disclaimer and user agreement with the download or usage of the provided files.

#### LEDiL Oy

Joensuunkatu 13  
FI-24240 SALO  
Finland

#### LEDiL Inc.

228 West Page Street  
Suite D  
Sycamore IL 60178  
USA

#### Local sales and technical support

[www.ledil.com/  
where\\_to\\_buy](http://www.ledil.com/where_to_buy)

#### Shipping locations

Salo, Finland  
Hong Kong, China

#### Distribution Partners

[www.ledil.com/  
where\\_to\\_buy](http://www.ledil.com/where_to_buy)

## Данный компонент на территории Российской Федерации

### Вы можете приобрести в компании MosChip.

Для оперативного оформления запроса Вам необходимо перейти по данной ссылке:

<http://moschip.ru/get-element>

Вы можете разместить у нас заказ для любого Вашего проекта, будь то серийное производство или разработка единичного прибора.

В нашем ассортименте представлены ведущие мировые производители активных и пассивных электронных компонентов.

Нашей специализацией является поставка электронной компонентной базы двойного назначения, продукции таких производителей как XILINX, Intel (ex.ALTERA), Vicor, Microchip, Texas Instruments, Analog Devices, Mini-Circuits, Amphenol, Glenair.

Сотрудничество с глобальными дистрибьюторами электронных компонентов, предоставляет возможность заказывать и получать с международных складов практически любой перечень компонентов в оптимальные для Вас сроки.

На всех этапах разработки и производства наши партнеры могут получить квалифицированную поддержку опытных инженеров.

Система менеджмента качества компании отвечает требованиям в соответствии с ГОСТ Р ИСО 9001, ГОСТ РВ 0015-002 и ЭС РД 009

### Офис по работе с юридическими лицами:

105318, г.Москва, ул.Щербаковская д.3, офис 1107, 1118, ДЦ «Щербаковский»

Телефон: +7 495 668-12-70 (многоканальный)

Факс: +7 495 668-12-70 (доб.304)

E-mail: [info@moschip.ru](mailto:info@moschip.ru)

Skype отдела продаж:

moschip.ru

moschip.ru\_4

moschip.ru\_6

moschip.ru\_9