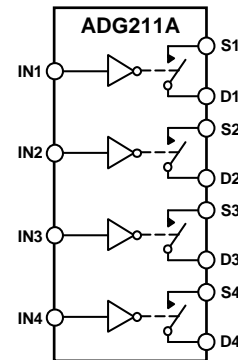

FEATURES

44 V supply maximum rating
±15 V analog signal range
Low R_{ON}: 115 Ω maximum
Low leakage: 0.5 nA typical
Break-before-make switching
Single supply operation possible
Extended plastic temperature range: -40°C to +85°C
TTL/CMOS compatible
Available in 16-lead PDIP/SOIC and 20-lead PLCC packages
Pin compatible to DG211/DG212

FUNCTIONAL BLOCK DIAGRAM

NOTES
 1. SWITCHES SHOWN FOR A LOGIC 1 INPUT.

10856-001

Figure 1.

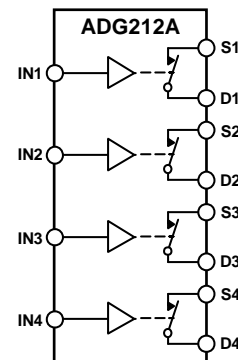

NOTES
 1. SWITCHES SHOWN FOR A LOGIC 1 INPUT.

10856-002

Figure 2.

GENERAL DESCRIPTION

The **ADG211A** and **ADG212A** are monolithic CMOS devices comprising four independently selectable switches. They are designed on an enhanced LC²MOS process, which gives an increased signal handling capability of ±15 V. These switches also feature high switching speeds and low R_{ON}.

The **ADG211A** and **ADG212A** consist of four SPST switches. They differ only in that the digital control logic is inverted. In multiplexer applications, all switches exhibit break-before-make switching action when driven simultaneously. Inherent in the design is low charge injection for minimum transients when switching the digital inputs.

PRODUCT HIGHLIGHTS

- Extended Signal Range.**
 These switches are fabricated on an enhanced LC²MOS process, resulting in high breakdown and an increased analog signal range of ±15 V.
- Single Supply Operation.**
 For applications where the analog signal is unipolar (0 V to 15 V), the switches can be operated from a single 15 V supply.
- Low Leakage.**
 Leakage currents in the range of 500 pA make these switches suitable for high precision circuits. The added feature of break-before-make allows for multiple outputs to be tied together for multiplexer applications while keeping leakage errors to a minimum.

Rev. C

[Document Feedback](#)

Information furnished by Analog Devices is believed to be accurate and reliable. However, no responsibility is assumed by Analog Devices for its use, nor for any infringements of patents or other rights of third parties that may result from its use. Specifications subject to change without notice. No license is granted by implication or otherwise under any patent or patent rights of Analog Devices. Trademarks and registered trademarks are the property of their respective owners.

TABLE OF CONTENTS

| | | | |
|--------------------------------|---|--|----|
| Features | 1 | ESD Caution..... | 4 |
| Functional Block Diagram | 1 | Pin Configurations and Function Descriptions | 5 |
| General Description | 1 | Typical Performance Characteristics | 6 |
| Product Highlights | 1 | Terminology | 9 |
| Revision History | 2 | Test Circuits..... | 10 |
| Specifications..... | 3 | Outline Dimensions | 12 |
| Absolute Maximum Ratings..... | 4 | Ordering Guide | 13 |

REVISION HISTORY

10/12—Rev. B to Rev. C

| | |
|--|-----------|
| Updated Format..... | Universal |
| Added Pin Descriptions, Table 3 | 5 |
| Moved Table 4 | 5 |
| Changes to Figure 5, Figure 6, Figure 8, and Figure 9..... | 6 |
| Updated Outline Dimensions | 13 |
| Changes to Ordering Guide | 14 |

9/02—Rev. A to Rev. B

SPECIFICATIONS

$V_{DD} = +15\text{ V}$, $V_{SS} = -15\text{ V}$, $V_L = 5\text{ V}$, unless otherwise noted.

Table 1.

| Parameter | 25°C | | | -40°C to +85°C | | | Unit | Test Conditions/Comments |
|--------------------------------------|------|-----|-----|----------------|-----|-----|------|--|
| | Min | Typ | Max | Min | Typ | Max | | |
| ANALOG SWITCH | | | | | | | | |
| Analog Signal Range | | ±15 | | | ±15 | | V | -10 V ≤ V_S ≤ +10 V, $I_{DS} = 1\text{ mA}$, see Figure 21 $V_S = 0\text{ V}$, $I_{DS} = 1\text{ mA}$ |
| R_{ON} | | | 115 | | | 175 | Ω | |
| R_{ON} vs. V_D (V_S) | | 20 | | | | | % | |
| R_{ON} Drift | | 0.5 | | | | | %/°C | |
| R_{ON} Match | | 5 | | | | | % | |
| LEAKAGE CURRENTS | | | | | | | | |
| I_S (Off) | | 0.5 | | | | | nA | $V_D = \pm 14\text{ V}$; $V_S = \mp 14\text{ V}$; see Figure 22 |
| Off Input Leakage | | | 5 | | | 100 | nA | |
| I_D (Off) | | 0.5 | | | | | nA | $V_D = \pm 14\text{ V}$; $V_S = \mp 14\text{ V}$; see Figure 22 |
| Off Output Leakage | | | 5 | | | 100 | nA | |
| I_D (On) | | 0.5 | | | | | nA | $V_D = V_S = \pm 14\text{ V}$; see Figure 23 |
| On Channel Leakage | | | 5 | | | 200 | nA | |
| DIGITAL CONTROL | | | | | | | | |
| V_{INH} , Input High Voltage | | | | 2.4 | | | V | TTL compatibility is independent of V_L |
| V_{INL} , Input Low Voltage | | | | | | 0.8 | V | |
| I_{NL} or I_{NH} | | | | | | 1 | μA | |
| C_{IN} , Digital Input Capacitance | | 5 | | | | | pF | |
| DYNAMIC CHARACTERISTICS | | | | | | | | |
| t_{OPEN}^1 | | 30 | | | | | ns | See Figure 24 |
| t_{ON}^1 | | | 600 | | | | ns | See Figure 25 |
| t_{OFF}^1 | | | 450 | | | | ns | See Figure 25 |
| Off Isolation | | 80 | | | | | dB | $V_S = 10\text{ V}$ (p-p); $f = 100\text{ kHz}$; $R_L = 75\text{ Ω}$; see Figure 26 |
| Channel-to-Channel Crosstalk | | 80 | | | | | dB | See Figure 27 |
| C_S (Off) | | 5 | | | | | pF | $R_S = 0\text{ Ω}$; $C_L = 1000\text{ pF}$; $V_S = 0\text{ V}$; see Figure 28 |
| C_D (Off) | | 5 | | | | | pF | |
| C_S, C_D (On) | | 16 | | | | | pF | |
| Q_{INJ} , Charge Injection | | 20 | | | | | pC | |
| POWER SUPPLY | | | | | | | | |
| I_{DD} | | 0.6 | | | | | mA | Digital inputs = V_{INL} or V_{INH} |
| I_{DD} | | | 1 | | | | mA | |
| I_{SS} | | 0.1 | | | | | mA | |
| I_{SS} | | | 0.2 | | | | mA | |
| I_L | | | 0.9 | | | | mA | |
| | | | | | | | | |

¹ Sample tested at 25°C to ensure compliance.

ABSOLUTE MAXIMUM RATINGS

$T_A = 25^\circ\text{C}$, unless otherwise stated.

Table 2.

| Parameter | Rating |
|--|---|
| V_{DD} to V_{SS} | 44 V |
| V_{DD} to GND | 25 V |
| V_{SS} to GND | -25 V |
| V_L to GND | -0.3 V, 25 V |
| Analog Inputs ¹ | |
| Voltage at S, D | $V_{SS} - 0.3 \text{ V}$ to $V_{DD} + 0.3 \text{ V}$ |
| Continuous Current, S or D | 30 mA |
| Pulsed Current S or D 1 ms Duration, 10% Duty Cycle | 70 mA |
| Digital Inputs ¹ | |
| Voltage at IN | $V_{SS} - 2 \text{ V}$ to $V_{DD} + 2 \text{ V}$ or 20 mA, Whichever Occurs First |
| Power Dissipation (Any Package) | |
| Up to $+75^\circ\text{C}$ | 470 mW |
| Derates above $+75^\circ\text{C}$ by | 6 mW/ $^\circ\text{C}$ |
| Operating Temperature | -40°C to $+85^\circ\text{C}$ |
| Storage Temperature Range | -65°C to $+150^\circ\text{C}$ |
| Lead Temperature (Soldering 10 sec) | $+300^\circ\text{C}$ |

¹ Overvoltage at IN, S, or D will be clamped by diodes. Current should be limited to the Maximum Rating listed in Table 2.

Stresses above those listed under Absolute Maximum Ratings may cause permanent damage to the device. This is a stress rating only; functional operation of the device at these or any other conditions above those indicated in the operational section of this specification is not implied. Exposure to absolute maximum rating conditions for extended periods may affect device reliability.

ESD CAUTION



ESD (electrostatic discharge) sensitive device. Charged devices and circuit boards can discharge without detection. Although this product features patented or proprietary protection circuitry, damage may occur on devices subjected to high energy ESD. Therefore, proper ESD precautions should be taken to avoid performance degradation or loss of functionality.

PIN CONFIGURATIONS AND FUNCTION DESCRIPTIONS

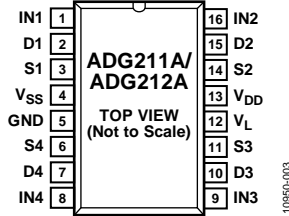
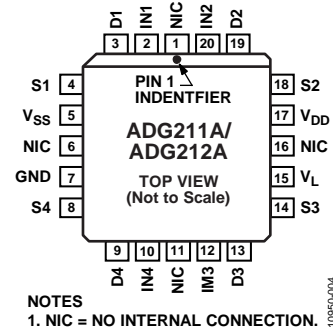

Figure 3. PDIP, SOIC Pin Configuration



NOTES
1. NIC = NO INTERNAL CONNECTION.

Figure 4. PLCC Pin Configuration

Table 3. Pin Function Descriptions

| Pin No. | | Mnemonic | Description |
|------------|--------------|-----------------|---|
| PDIP, SOIC | PLCC | | |
| 1 | 2 | IN1 | Logic Control Input. |
| 2 | 3 | D1 | Drain Terminal. Can be an input or output. |
| 3 | 4 | S1 | Source Terminal. Can be an input or output. |
| 4 | 5 | V _{SS} | Most Negative Power Supply Potential. |
| 5 | 7 | GND | Ground (0 V) Reference. |
| 6 | 8 | S4 | Source Terminal. Can be an input or output. |
| 7 | 9 | D4 | Drain Terminal. Can be an input or output. |
| 8 | 10 | IN4 | Logic Control Input. |
| 9 | 12 | IN3 | Logic Control Input. |
| 10 | 13 | D3 | Drain Terminal. Can be an input or output. |
| 11 | 14 | S3 | Source Terminal. Can be an input or output. |
| 12 | 15 | V _L | Logic Supply Voltage. |
| 13 | 17 | V _{DD} | Most Positive Power Supply Potential. |
| 14 | 18 | S2 | Source Terminal. Can be an input or output. |
| 15 | 19 | D2 | Drain Terminal. Can be an input or output. |
| 16 | 20 | IN2 | Logic Control Input. |
| | 1, 6, 11, 16 | NIC | No Internal Connection. |

Table 4. Truth Table

| ADG211A In | ADG212A In | Switch Condition |
|------------|------------|------------------|
| 0 | 1 | On |
| 1 | 0 | Off |

TYPICAL PERFORMANCE CHARACTERISTICS

The switches can comfortably operate anywhere in the 10 V to 15 V single or dual supply range, with only a slight degradation in performance. The following graphs show the relevant performance curves. The test circuits and test conditions are given in a following section, Test Circuits.

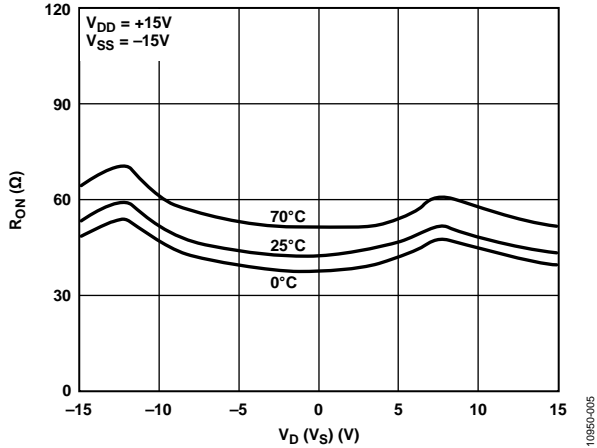

Figure 5. R_{ON} as a Function of V_D (V_S), Dual ± 15 V Supplies

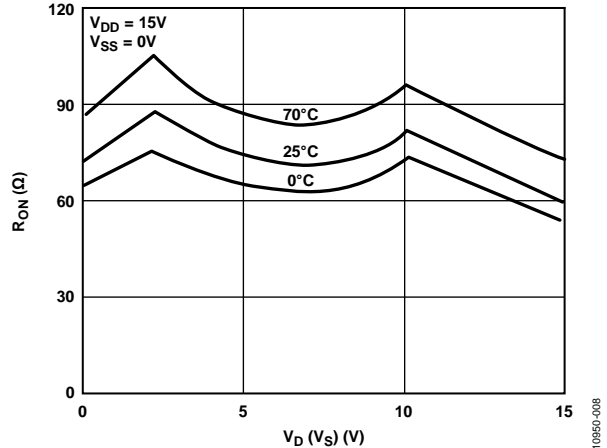

Figure 8. R_{ON} as a Function of V_D (V_S), Single +15 V Supply

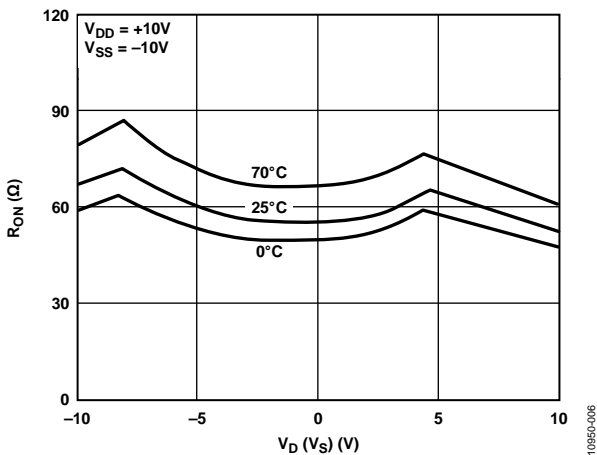

Figure 6. R_{ON} as a Function of V_D (V_S), Dual ± 10 V Supplies

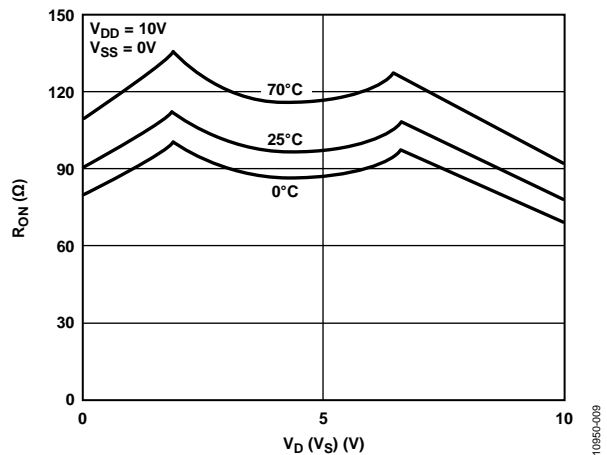

Figure 9. R_{ON} as a Function of V_D (V_S), Single +10 V Supply

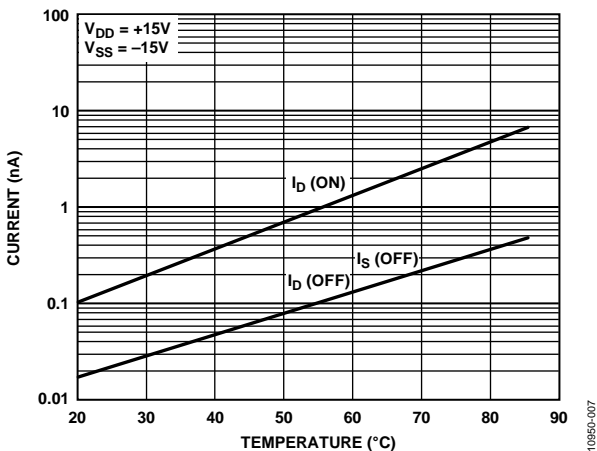

Figure 7. Leakage Current as a Function of Temperature (Note That Leakage Current Reduces as the Supply Voltages Reduce)

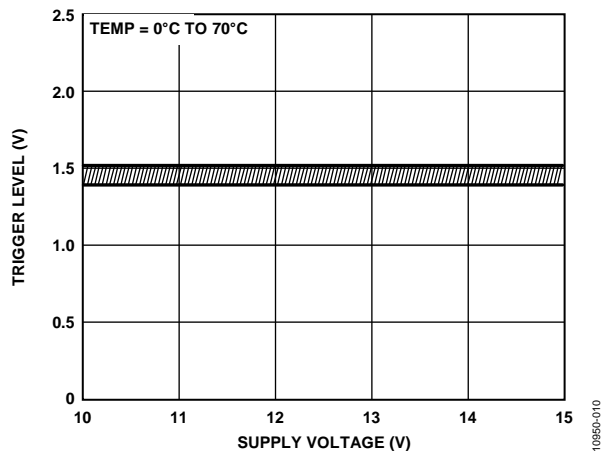

Figure 10. Trigger Levels vs. Power Supply Voltage, Dual or Single Supply Voltage

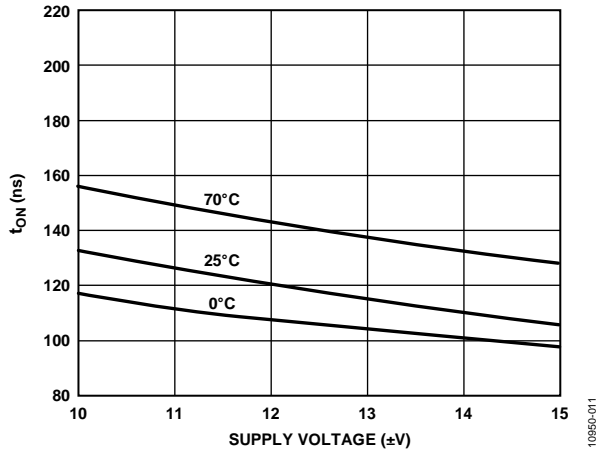

Figure 11. t_{ON} vs. Supply Voltage (Dual Supply)

10950-011

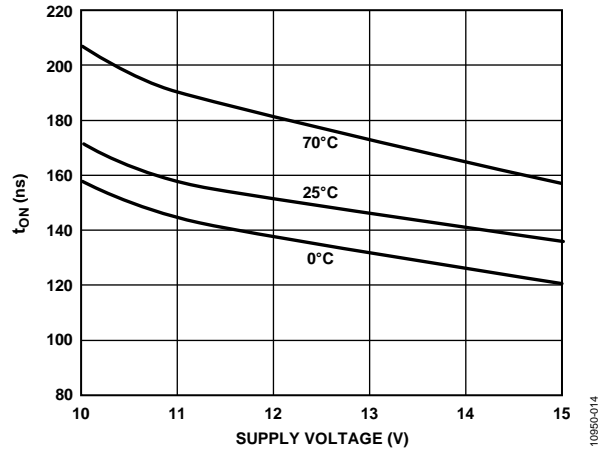

Figure 14. t_{ON} vs. Supply Voltage (Single Supply)

10950-014

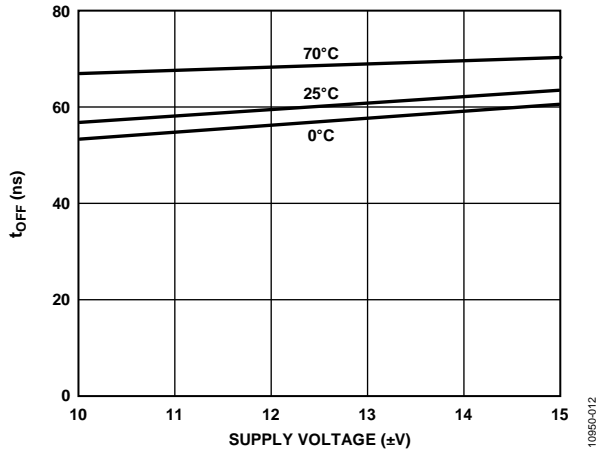

Figure 12. t_{OFF} vs. Supply Voltage (Dual Supply)

10950-012

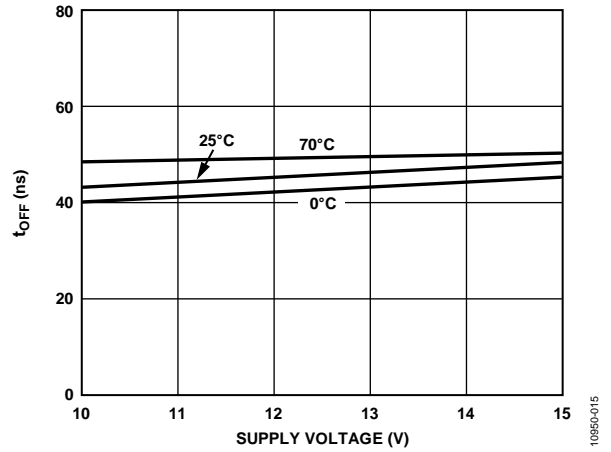

Figure 15. t_{OFF} vs. Supply Voltage (Single Supply)

10950-015

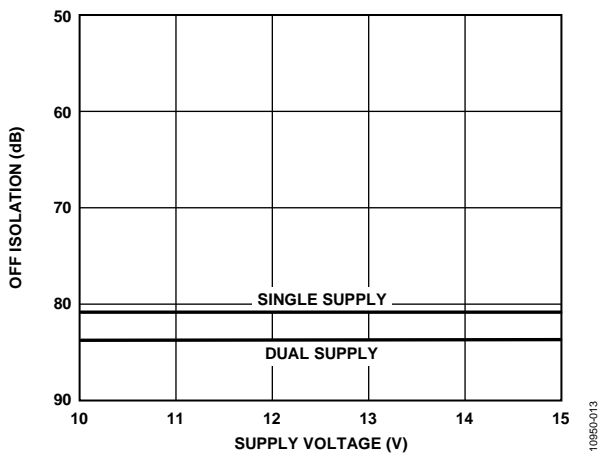

Figure 13. Off Isolation and Channel-to-Channel Crosstalk vs. Supply Voltage

10950-013

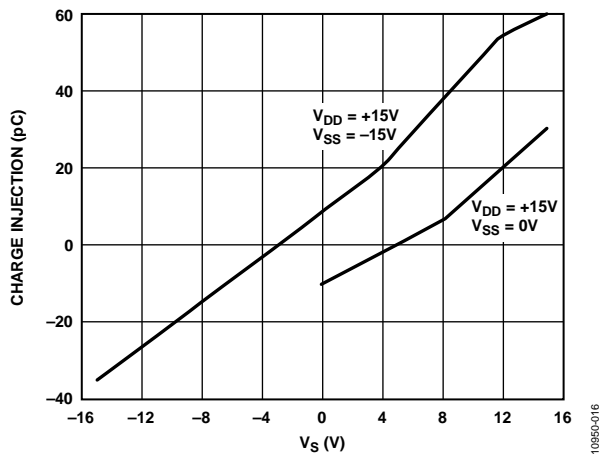

Figure 16. Charge Injection vs. Source Voltage (V_S) for Dual and Single 15V Supplies

10950-016

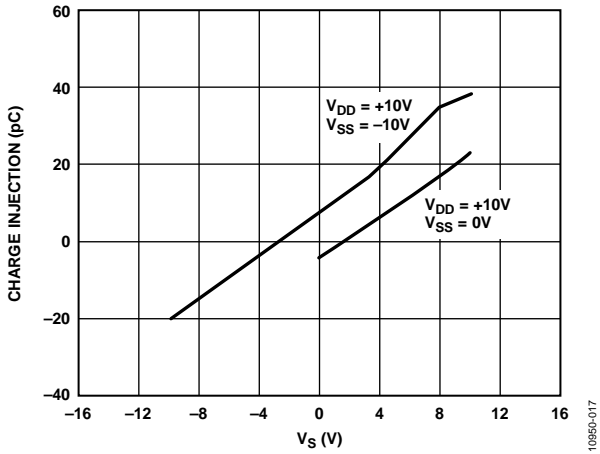

Figure 17. Charge Injection vs. Source Voltage for Dual and Single 10V Supplies

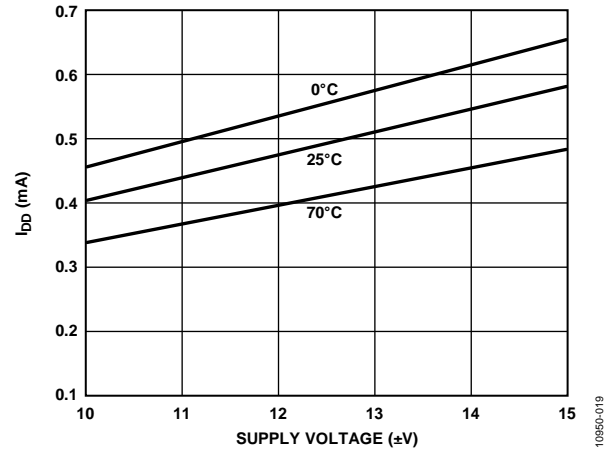

Figure 19. I_{DD} vs. Supply Voltage, (Dual Supply)

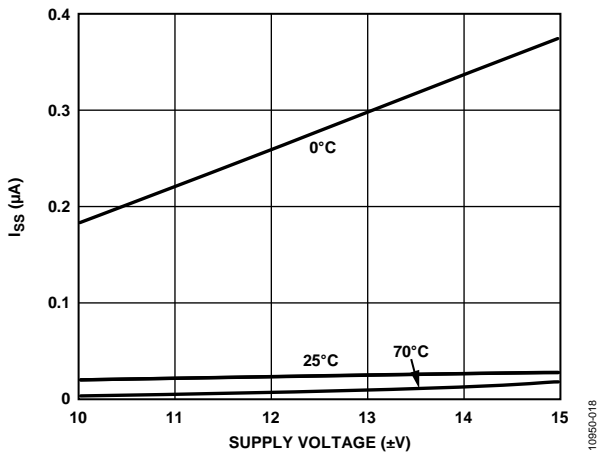

Figure 18. I_{SS} vs. Supply Voltage (Dual Supply)

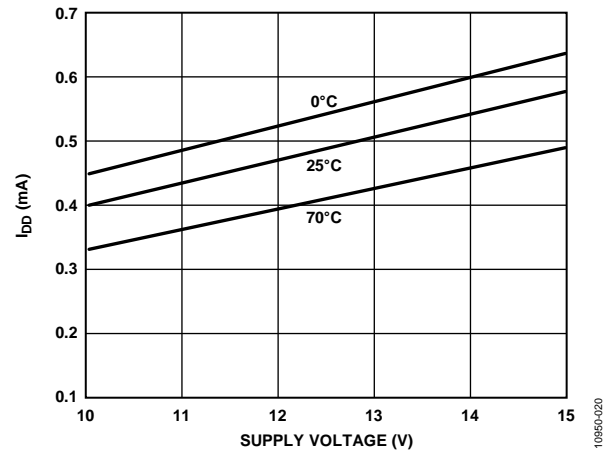

Figure 20. I_{DD} vs. Supply Voltage (Single Supply)

TERMINOLOGY

R_{ON}

Ohmic resistance between the out and S terminals.

R_{ON Match}

Difference between the R_{ON} of any two channels.

I_S (Off)

Source terminal leakage current when the switch is off.

I_D (Off)

Drain terminal leakage current when the switch is off.

I_D (On)

Leakage current that flows from the closed switch into the body.

V_D (V_S)

Analog voltage on the D, S terminals.

C_S (Off)

Switch input capacitance off condition.

C_D (Off)

Switch output capacitance off condition.

C_{IN}

Digital input capacitance.

C_D, C_S (On)

Input or output capacitance when the switch is on.

t_{ON}

Delay time between the 50% and 90% points of the digital input and switch on condition.

t_{OFF}

Delay time between the 50% and 90% points of the digital input and switch off condition.

t_{OPEN}

Off time measured between 50% points of both switches, which are connected as a multiplexer when switching from one address state to another.

V_{INL}

Maximum input voltage for a logic low.

V_{INH}

Minimum input voltage for a logic high.

I_{INL} (I_{INH})

Input current of the digital input.

V_{DD}

Most positive voltage supply.

V_{SS}

Most negative voltage supply.

V_L

Logic supply voltage.

I_{DD}

Positive supply current.

I_{SS}

Negative supply current.

TEST CIRCUITS

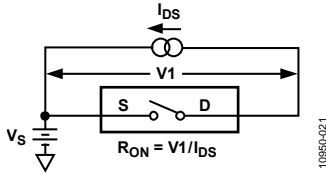

Figure 21.

10850-021

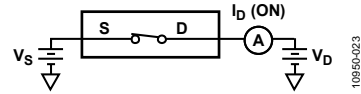

Figure 23.

10850-023

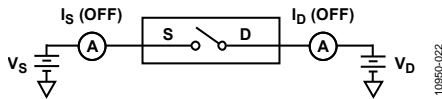
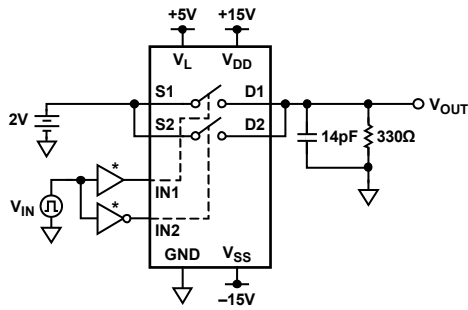

Figure 22.

10850-022



* BOTH THE BUFFER AND INVERTER SHOULD HAVE THE SAME PROPAGATION DELAY.

Figure 24.

10850-024

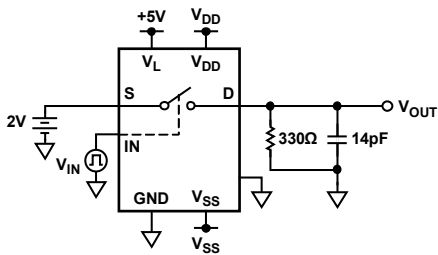
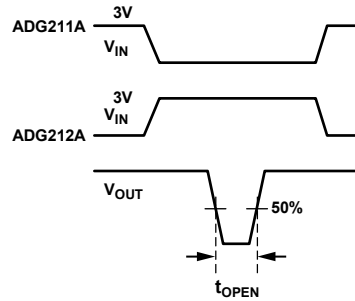
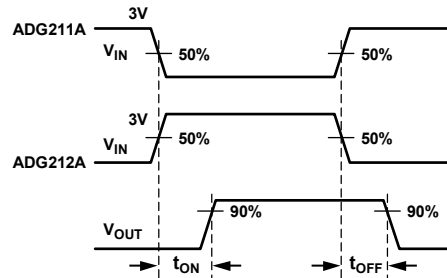

Figure 25.

10850-025



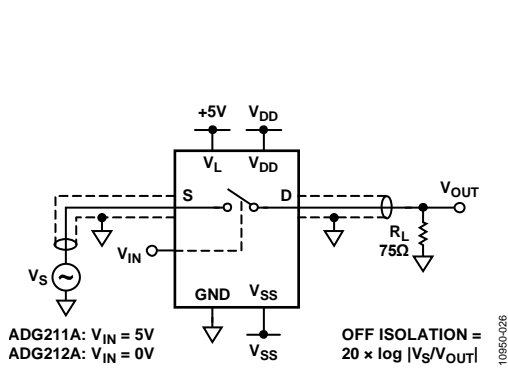

Figure 26. Off Isolation

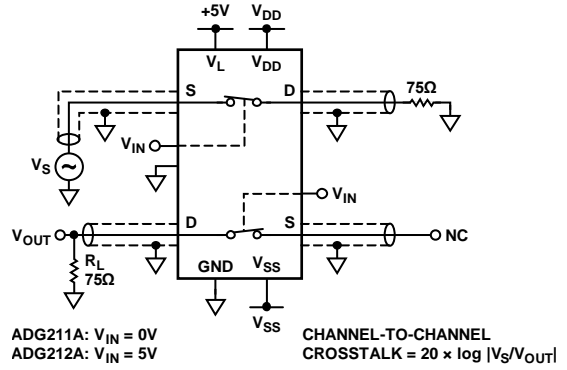

Figure 27. Channel-to-Channel Crosstalk

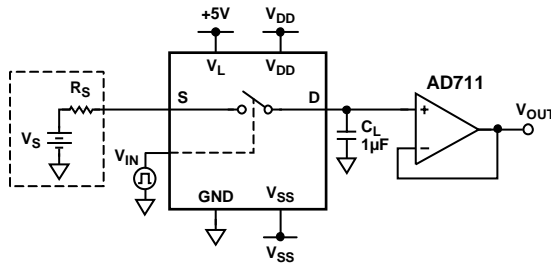
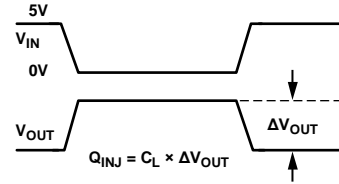
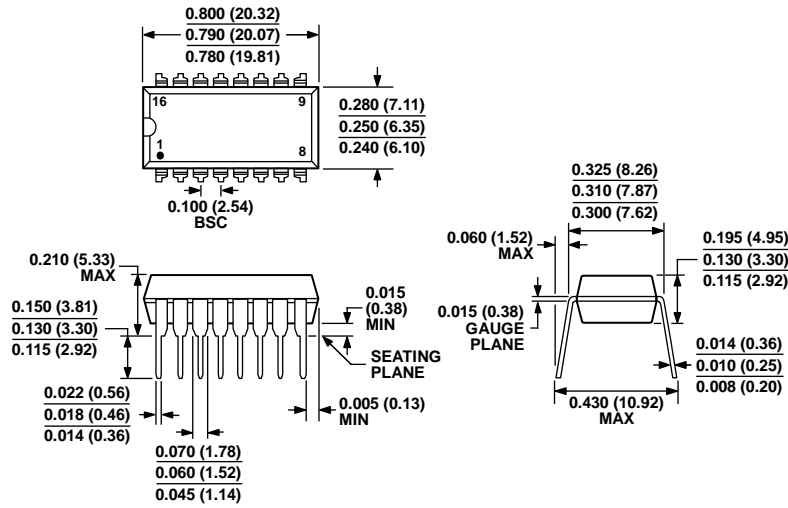

Figure 28. Charge Injection



OUTLINE DIMENSIONS



COMPLIANT TO JEDEC STANDARDS MS-001-AB
 CONTROLLING DIMENSIONS ARE IN INCHES; MILLIMETER DIMENSIONS (IN PARENTHESES) ARE ROUNDED-OFF INCH EQUIVALENTS FOR REFERENCE ONLY AND ARE NOT APPROPRIATE FOR USE IN DESIGN. CORNER LEADS MAY BE CONFIGURED AS WHOLE OR HALF LEADS.

Figure 29. 16-Lead Plastic Dual In-Line Package [PDIP]
 Narrow Body
 (N-16)
 Dimensions shown in inches and (millimeters)

073106-B

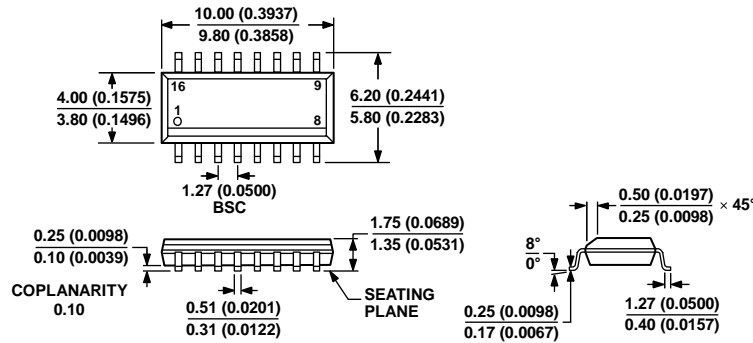

COMPLIANT TO JEDEC STANDARDS MS-012-AC
 CONTROLLING DIMENSIONS ARE IN MILLIMETERS; INCH DIMENSIONS (IN PARENTHESES) ARE ROUNDED-OFF MILLIMETER EQUIVALENTS FOR REFERENCE ONLY AND ARE NOT APPROPRIATE FOR USE IN DESIGN.

Figure 30. 16-Lead Standard Small Outline Package [SOIC_N]
 Narrow Body
 (R-16)
 Dimensions shown in millimeters and (inches)

060806-A

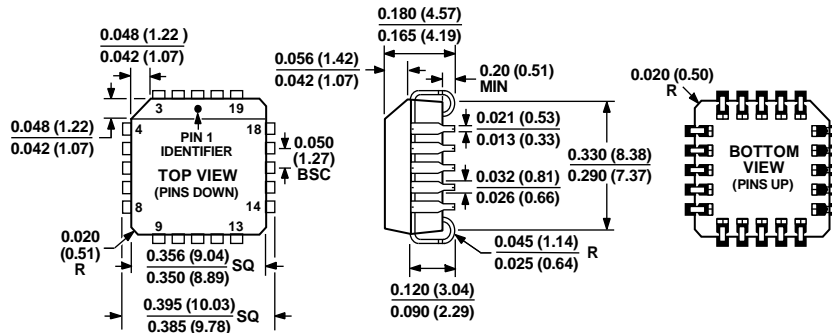

COMPLIANT TO JEDEC STANDARDS MO-047-AA
 CONTROLLING DIMENSIONS ARE IN INCHES; MILLIMETER DIMENSIONS
 (IN PARENTHESES) ARE ROUNDED-OFF INCH EQUIVALENTS FOR
 REFERENCE ONLY AND ARE NOT APPROPRIATE FOR USE IN DESIGN.

Figure 31. 20-Lead Plastic Leaded Chip Carrier (PLCC)
 (P-20)

Dimensions shown in inches and (millimeters)

ORDERING GUIDE

| Model ¹ | Temperature Range | Package Description | Package Option |
|--------------------|-------------------|---------------------|----------------|
| ADG211AKN | -40°C to +85°C | 16-Lead PDIP | N-16 |
| ADG211AKNZ | -40°C to +85°C | 16-Lead PDIP | N-16 |
| ADG211AKPZ | -40°C to +85°C | 20-Lead PLCC | P-20 |
| ADG211AKR | -40°C to +85°C | 16-Lead SOIC_N | R-16 |
| ADG211AKRZ | -40°C to +85°C | 16-Lead SOIC_N | R-16 |
| ADG211AKRZ-REEL | -40°C to +85°C | 16-Lead SOIC_N | R-16 |
| ADG211AKRZ-REEL7 | -40°C to +85°C | 16-Lead SOIC_N | R-16 |
| ADG212AKNZ | -40°C to +85°C | 16-Lead PDIP | N-16 |
| ADG212AKPZ | -40°C to +85°C | 20-Lead PLCC | P-20 |
| ADG212AKPZ-REEL | -40°C to +85°C | 20-Lead PLCC | P-20 |
| ADG212AKR | -40°C to +85°C | 16-Lead SOIC_N | R-16 |
| ADG212AKRZ | -40°C to +85°C | 16-Lead SOIC_N | R-16 |
| ADG212AKRZ-REEL | -40°C to +85°C | 16-Lead SOIC_N | R-16 |

¹ Z = RoHS Compliant Part.

NOTES

NOTES

NOTES

Данный компонент на территории Российской Федерации

Вы можете приобрести в компании MosChip.

Для оперативного оформления запроса Вам необходимо перейти по данной ссылке:

<http://moschip.ru/get-element>

Вы можете разместить у нас заказ для любого Вашего проекта, будь то серийное производство или разработка единичного прибора.

В нашем ассортименте представлены ведущие мировые производители активных и пассивных электронных компонентов.

Нашей специализацией является поставка электронной компонентной базы двойного назначения, продукции таких производителей как XILINX, Intel (ex.ALTERA), Vicor, Microchip, Texas Instruments, Analog Devices, Mini-Circuits, Amphenol, Glenair.

Сотрудничество с глобальными дистрибьюторами электронных компонентов, предоставляет возможность заказывать и получать с международных складов практически любой перечень компонентов в оптимальные для Вас сроки.

На всех этапах разработки и производства наши партнеры могут получить квалифицированную поддержку опытных инженеров.

Система менеджмента качества компании отвечает требованиям в соответствии с ГОСТ Р ИСО 9001, ГОСТ РВ 0015-002 и ЭС РД 009

Офис по работе с юридическими лицами:

105318, г.Москва, ул.Щербаковская д.3, офис 1107, 1118, ДЦ «Щербаковский»

Телефон: +7 495 668-12-70 (многоканальный)

Факс: +7 495 668-12-70 (доб.304)

E-mail: info@moschip.ru

Skype отдела продаж:

moschip.ru

moschip.ru_4

moschip.ru_6

moschip.ru_9