

TPS22966-Q1 Dual-Channel, Ultralow Resistance Load Switch

1 Features

- Qualified for Automotive Applications
- AEC-Q100 Qualified With the Following Results:
 - Device Temperature Grade 2: -40°C to 105°C Ambient Operating Temperature Range
 - Device HBM ESD Classification Level H1C
 - Device CDM ESD Classification Level C6
- Integrated Dual-Channel Load Switch
- Input Voltage Range: 0.8 V to 5.5 V
- Ultralow ON-Resistance (R_{ON})
 - $R_{\text{ON}} = 16\text{ m}\Omega$ at $V_{\text{IN}} = 5\text{ V}$ ($V_{\text{BIAS}} = 5\text{ V}$)
 - $R_{\text{ON}} = 16\text{ m}\Omega$ at $V_{\text{IN}} = 3.3\text{ V}$ ($V_{\text{BIAS}} = 5\text{ V}$)
 - $R_{\text{ON}} = 16\text{ m}\Omega$ at $V_{\text{IN}} = 1.8\text{ V}$ ($V_{\text{BIAS}} = 5\text{ V}$)
- 4-A Maximum Continuous Switch Current per Channel
- Low Quiescent Current
 - 80 μA (Both Channels)
 - 80 μA (Single Channel)
- Low Control Input Threshold Enables Use of 1.2-V, 1.8-V, 2.5-V, and 3.3-V Logic
- Configurable Rise Time
- Quick Output Discharge (QOD)
- SON 14-Pin Package With Thermal Pad

2 Applications

- Infotainment
- ADAS (Advanced Driver Assistance Systems)

3 Description

The TPS22966-Q1 device is a small, ultralow R_{ON} , dual-channel load switch with adjustable rise time. The device contains two N-channel MOSFETs that can operate over an input voltage range of 0.8 V to 5.5 V and can support a maximum continuous current of up to 4 A per channel. Each switch is independently controlled by an on/off input (ON1 and ON2), which can interface directly with low-voltage control signals. The TPS22966-Q1 includes a 230- Ω on-chip resistor for quick output discharge when the switch is turned off.

The TPS22966-Q1 is available in a small, space-saving 2-mm \times 3-mm 14-SON package (DPU) with integrated thermal pad allowing for high power dissipation. The device is characterized for operation over the free-air temperature range of -40°C to 105°C .

Device Information⁽¹⁾

PART NUMBER	PACKAGE	BODY SIZE (NOM)
TPS22966-Q1	WSON (14)	3.00 mm \times 2.00 mm

(1) For all available packages, see the orderable addendum at the end of the datasheet.

Typical Application Schematic

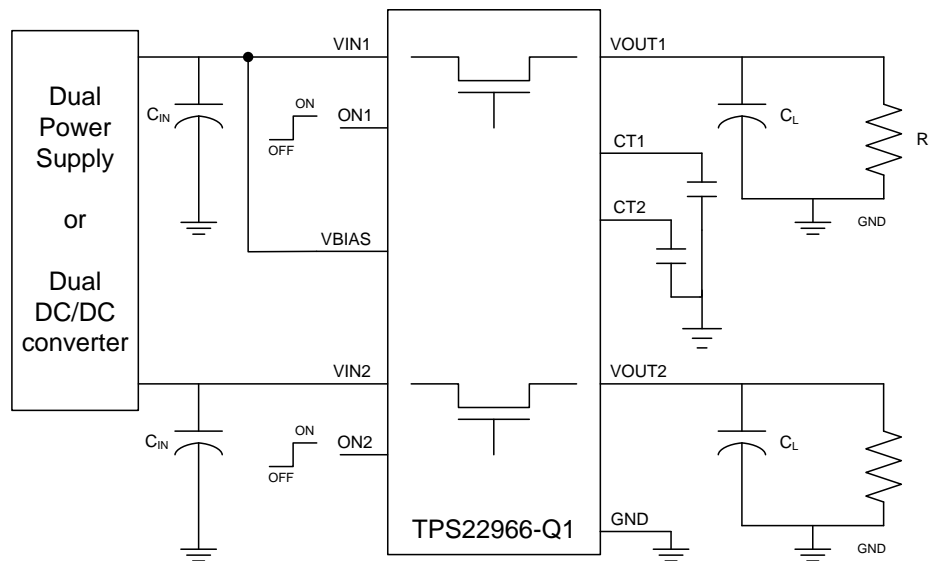

Table of Contents

1 Features	1	8.1 Overview	14
2 Applications	1	8.2 Functional Block Diagram	14
3 Description	1	8.3 Feature Description	15
4 Revision History	2	8.4 Device Functional Modes	15
5 Pin Configuration and Functions	3	9 Application and Implementation	16
6 Specifications	4	9.1 Application Information	16
6.1 Absolute Maximum Ratings	4	9.2 Typical Application	18
6.2 ESD Ratings	4	10 Power Supply Recommendations	20
6.3 Recommended Operating Conditions	4	11 Layout	20
6.4 Thermal Information	5	11.1 Layout Guidelines	20
6.5 Electrical Characteristics: $V_{BIAS} = 5\text{ V}$	5	11.2 Layout Example	21
6.6 Electrical Characteristics: $V_{BIAS} = 2.5\text{ V}$	6	12 Device and Documentation Support	22
6.7 Switching Characteristics	7	12.1 Trademarks	22
6.8 Typical Characteristics	8	12.2 Electrostatic Discharge Caution	22
7 Parameter Measurement Information	13	12.3 Glossary	22
8 Detailed Description	14	13 Mechanical, Packaging, and Orderable Information	22

4 Revision History

Changes from Original (December 2013) to Revision A

Page

- Added *Pin Configuration and Functions* section, *ESD Ratings* table, *Feature Description* section, *Device Functional Modes*, *Application and Implementation* section, *Power Supply Recommendations* section, *Layout* section, *Device and Documentation Support* section, and *Mechanical, Packaging, and Orderable Information* section **1**

5 Pin Configuration and Functions

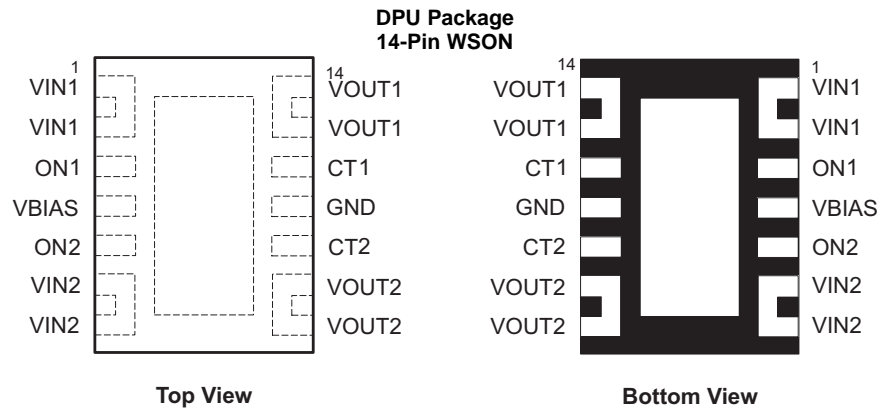

Pin Functions

PIN		I/O	DESCRIPTION
NO.	NAME		
1	VIN1	I	Switch 1 input. Place an optional decoupling capacitor between this pin and GND for reduce VIN dip during turnon of the channel. See Application Information section for more information.
2	VIN1	I	Switch 1 input. Place an optional decoupling capacitor between this pin and GND for reduce VIN dip during turnon of the channel. See Application Information for more information.
3	ON1	I	Active high switch 1 control input. Do not leave floating.
4	VBIAS	I	Bias voltage. Power supply to the device. See Application Information for more information.
5	ON2	I	Active high switch 2 control input. Do not leave floating.
6	VIN2	I	Switch 2 input. Place an optional decoupling capacitor between this pin and GND for reduce VIN dip during turnon of the channel. See Application Information for more information.
7	VIN2	I	Switch 2 input. Place an optional decoupling capacitor between this pin and GND for reduce VIN dip during turnon of the channel. See Application Information for more information.
8	VOUT2	O	Switch 2 output.
9	VOUT2	O	Switch 2 output.
10	CT2	O	Switch 2 slew rate control. Can be left floating. Capacitor used on this pin should be rated for a minimum of 25 V for desired rise time performance.
11	GND	–	Ground
12	CT1	O	Switch 1 slew rate control. Can be left floating. Capacitor used on this pin should be rated for a minimum of 25 V for desired rise time performance.
13	VOUT1	O	Switch 1 output.
14	VOUT1	O	Switch 1 output.
15	Thermal Pad	O	Thermal pad (exposed center pad) to alleviate thermal stress. Tie to GND. See Layout Guidelines for layout guidelines.

6 Specifications

6.1 Absolute Maximum Ratings

Over operating free-air temperature range (unless otherwise noted)⁽¹⁾ ⁽²⁾

		MIN	MAX	UNIT
V _{IN1,2}	Input voltage	-0.3	6	V
V _{OUT1,2}	Output voltage	-0.3	6	V
V _{ON1,2}	ON-pin voltage	-0.3	6	V
V _{BIAS}	VBIAS voltage	-0.3	6	V
I _{MAX}	Maximum continuous switch current per channel		4	A
I _{PLS}	Maximum pulsed switch current per channel, pulse <300 μs, 2% duty cycle		6	A
T _J	Maximum junction temperature		150	°C
T _{LEAD}	Maximum lead temperature (10-s soldering time)		300	°C
T _{STG}	Storage temperature	-65	150	°C

- (1) Stresses beyond those listed under *Absolute Maximum Ratings* may cause permanent damage to the device. These are stress ratings only, which do not imply functional operation of the device at these or any other conditions beyond those indicated under *Recommended Operating Conditions*. Exposure to absolute-maximum-rated conditions for extended periods may affect device reliability.
- (2) All voltage values are with respect to network ground terminal.

6.2 ESD Ratings

		VALUE	UNIT
V _(ESD)	Electrostatic discharge	Human body model (HBM), per ANSI/ESDA/JEDEC JS-001 ⁽¹⁾	±4000
		Charged-device model (CDM), per JEDEC specification JESD22-C101 ⁽²⁾	±1500

- (1) JEDEC document JEP155 states that 500-V HBM allows safe manufacturing with a standard ESD control process.
- (2) JEDEC document JEP157 states that 250-V CDM allows safe manufacturing with a standard ESD control process.

6.3 Recommended Operating Conditions

			MIN	MAX	UNIT
V _{IN1,2}	Input voltage range		0.8	V _{BIAS}	V
V _{BIAS}	Bias voltage range		2.5	5.5	V
V _{ON1,2}	ON voltage range		0	5.5	V
V _{OUT1,2}	Output voltage range			V _{IN}	V
V _{IH}	High-level input voltage, ON	V _{BIAS} = 2.5 V to 5.5 V	1.2	5.5	V
V _{IL}	Low-level input voltage, ON	V _{BIAS} = 2.5 V to 5.5 V	0	0.5	V
C _{IN1,2}	Input capacitor		1 ⁽¹⁾		μF
T _A	Operating free-air temperature ⁽²⁾		-40	105	°C

- (1) Refer to [Application Information](#).
- (2) In applications where high power dissipation and/or poor package thermal resistance is present, the maximum ambient temperature may have to be derated. Maximum ambient temperature [T_{A(max)}] is dependent on the maximum operating junction temperature [T_{J(max)}], the maximum power dissipation of the device in the application [P_{D(max)}], and the junction-to-ambient thermal resistance of the part/package in the application (θ_{JA}), as given by the following equation: T_{A(max)} = T_{J(max)} - (θ_{JA} × P_{D(max)})

6.4 Thermal Information

THERMAL METRIC ⁽¹⁾		TPS22966-Q1	UNIT
		DPU (WSON)	
		14 PINS	
θ_{JA}	Junction-to-ambient thermal resistance	52.3	°C/W
θ_{JCTop}	Junction-to-case (top) thermal resistance	45.9	
θ_{JB}	Junction-to-board thermal resistance	11.5	
ψ_{JT}	Junction-to-top characterization parameter	0.8	
ψ_{JB}	Junction-to-board characterization parameter	11.4	
θ_{JCbot}	Junction-to-case (bottom) thermal resistance	6.9	

(1) For more information about traditional and new thermal metrics, see the *IC Package Thermal Metrics* application report, [SPRA953](#).

6.5 Electrical Characteristics: $V_{BIAS} = 5\text{ V}$

Unless otherwise noted, the specifications apply over the operating ambient temperature, $-40^{\circ}\text{C} \leq T_A \leq 105^{\circ}\text{C}$ (full) and $V_{BIAS} = 5\text{ V}$. Typical values are for $T_A = 25^{\circ}\text{C}$ (unless otherwise noted).

PARAMETER		TEST CONDITIONS	T_A	MIN	TYP	MAX	UNIT	
POWER SUPPLIES AND CURRENTS								
$I_{IN(VBIAS-ON)}$	V_{BIAS} quiescent current (both channels)	$I_{OUT1} = I_{OUT2} = 0\text{ mA}$, $V_{IN1,2} = V_{ON1,2} = V_{BIAS} = 5\text{ V}$	-40°C to 105°C	80	120		μA	
$I_{IN(VBIAS-ON)}$	V_{BIAS} quiescent current (single channel)	$I_{OUT1} = I_{OUT2} = 0\text{ mA}$, $V_{ON2} = 0\text{ V}$ $V_{IN1,2} = V_{ON1} = V_{BIAS} = 5\text{ V}$	-40°C to 105°C	80	120		μA	
$I_{IN(VBIAS-OFF)}$	V_{BIAS} shutdown current	$V_{ON1,2} = 0\text{ V}$, $V_{OUT1,2} = 0\text{ V}$	-40°C to 105°C			2	μA	
$I_{IN(VIN-OFF)}$	$V_{IN1,2}$ off-state supply current (per channel)	$V_{ON1,2} = 0\text{ V}$, $V_{OUT1,2} = 0\text{ V}$	-40°C to 105°C		$V_{IN1,2} = 5\text{ V}$	0.5	8	μA
					$V_{IN1,2} = 3.3\text{ V}$	0.1	3	
					$V_{IN1,2} = 1.8\text{ V}$	0.07	2	
					$V_{IN1,2} = 0.8\text{ V}$	0.04	1	
I_{ON}	ON pin input leakage current	$V_{ON} = 5.5\text{ V}$	-40°C to 105°C			1	μA	
RESISTANCE CHARACTERISTICS								
R_{ON}	ON-state resistance (per channel)	$I_{OUT} = -200\text{ mA}$, $V_{BIAS} = 5\text{ V}$	$V_{IN} = 5\text{ V}$	25°C		16	19	m Ω
				-40°C to 85°C			21	
				-40°C to 105°C			23	
			$V_{IN} = 3.3\text{ V}$	25°C		16	19	
				-40°C to 85°C			21	
				-40°C to 105°C			23	
			$V_{IN} = 1.8\text{ V}$	25°C		16	19	
				-40°C to 85°C			21	
				-40°C to 105°C			23	
			$V_{IN} = 1.5\text{ V}$	25°C		16	19	
				-40°C to 85°C			21	
				-40°C to 105°C			23	
			$V_{IN} = 1.2\text{ V}$	25°C		16	19	
				-40°C to 85°C			21	
				-40°C to 105°C			23	
			$V_{IN} = 0.8\text{ V}$	25°C		16	19	
-40°C to 85°C				21				
-40°C to 105°C				23				
R_{PD}	Output pulldown resistance	$V_{IN} = 5.0\text{ V}$, $V_{ON} = 0\text{ V}$, $I_{OUT} = 15\text{ mA}$	-40°C to 105°C	230	330		Ω	

6.6 Electrical Characteristics: $V_{BIAS} = 2.5\text{ V}$

Unless otherwise noted, the specifications apply over the operating ambient temperature $-40^{\circ}\text{C} \leq T_A \leq 105^{\circ}\text{C}$ (full) and $V_{BIAS} = 2.5\text{ V}$. Typical values are for $T_A = 25^{\circ}\text{C}$ (unless otherwise noted).

PARAMETER		TEST CONDITIONS	T_A	MIN	TYP	MAX	UNIT	
POWER SUPPLIES AND CURRENTS								
$I_{IN(VBIAS-ON)}$	V_{BIAS} quiescent current (both channels)	$I_{OUT1} = I_{OUT2} = 0\text{ mA}$, $V_{IN1,2} = V_{ON1,2} = V_{BIAS} = 2.5\text{ V}$	-40°C to 105°C	32	40		μA	
$I_{IN(VBIAS-ON)}$	V_{BIAS} quiescent current (single channel)	$I_{OUT1} = I_{OUT2} = 0\text{ mA}$, $V_{ON2} = 0\text{ V}$ $V_{IN1,2} = V_{ON1} = V_{BIAS} = 2.5\text{ V}$	-40°C to 105°C	32	40		μA	
$I_{IN(VBIAS-OFF)}$	V_{BIAS} shutdown current	$V_{ON1,2} = 0\text{ V}$, $V_{OUT1,2} = 0\text{ V}$	-40°C to 105°C		2		μA	
$I_{IN(VIN-OFF)}$	$V_{IN1,2}$ off-state supply current (per channel)	$V_{ON1,2} = 0\text{ V}$, $V_{OUT1,2} = 0\text{ V}$	-40°C to 105°C		$V_{IN1,2} = 2.5\text{ V}$	0.13	3	μA
					$V_{IN1,2} = 1.8\text{ V}$	0.07	2	
					$V_{IN1,2} = 1.2\text{ V}$	0.05	2	
					$V_{IN1,2} = 0.8\text{ V}$	0.04	1	
I_{ON}	ON pin input leakage current	$V_{ON} = 5.5\text{ V}$	-40°C to 105°C		1		μA	
RESISTANCE CHARACTERISTICS								
R_{ON}	ON-state resistance	$I_{OUT} = -200\text{ mA}$, $V_{BIAS} = 2.5\text{ V}$	$V_{IN} = 2.5\text{ V}$	25 $^{\circ}\text{C}$	21	24	m Ω	
				-40°C to 85°C		27		
				-40°C to 105°C		29		
			$V_{IN} = 1.8\text{ V}$	25 $^{\circ}\text{C}$	19	22		
				-40°C to 85°C		25		
				-40°C to 105°C		27		
			$V_{IN} = 1.5\text{ V}$	25 $^{\circ}\text{C}$	18	21		
				-40°C to 85°C		24		
				-40°C to 105°C		26		
			$V_{IN} = 1.2\text{ V}$	25 $^{\circ}\text{C}$	18	21		
				-40°C to 85°C		24		
				-40°C to 105°C		26		
$V_{IN} = 0.8\text{ V}$	25 $^{\circ}\text{C}$	17	20					
	-40°C to 85°C		23					
	-40°C to 105°C		25					
R_{PD}	Output pulldown resistance	$V_{IN} = 2.5\text{ V}$, $V_{ON} = 0\text{ V}$, $I_{OUT} = 1\text{ mA}$	Full	280	330		Ω	

6.7 Switching Characteristics

PARAMETER		TEST CONDITION	MIN	TYP	MAX	UNIT
$V_{IN} = V_{ON} = V_{BIAS} = 5\text{ V}$, $T_A = 25^\circ\text{C}$ (unless otherwise noted)						
t_{ON}	Turnon time	$R_L = 10\ \Omega$, $C_L = 0.1\ \mu\text{F}$, $C_T = 1000\ \text{pF}$		1559		μs
t_{OFF}	Turnoff time	$R_L = 10\ \Omega$, $C_L = 0.1\ \mu\text{F}$, $C_T = 1000\ \text{pF}$		6		
t_R	V_{OUT} rise time	$R_L = 10\ \Omega$, $C_L = 0.1\ \mu\text{F}$, $C_T = 1000\ \text{pF}$		1991		
t_F	V_{OUT} fall time	$R_L = 10\ \Omega$, $C_L = 0.1\ \mu\text{F}$, $C_T = 1000\ \text{pF}$		2		
t_D	ON delay time	$R_L = 10\ \Omega$, $C_L = 0.1\ \mu\text{F}$, $C_T = 1000\ \text{pF}$		665		
$V_{IN} = 0.8\text{ V}$, $V_{ON} = V_{BIAS} = 5\text{ V}$, $T_A = 25^\circ\text{C}$ (unless otherwise noted)						
t_{ON}	Turnon time	$R_L = 10\ \Omega$, $C_L = 0.1\ \mu\text{F}$, $C_T = 1000\ \text{pF}$		732		μs
t_{OFF}	Turnoff time	$R_L = 10\ \Omega$, $C_L = 0.1\ \mu\text{F}$, $C_T = 1000\ \text{pF}$		161		
t_R	V_{OUT} rise time	$R_L = 10\ \Omega$, $C_L = 0.1\ \mu\text{F}$, $C_T = 1000\ \text{pF}$		371		
t_F	V_{OUT} fall time	$R_L = 10\ \Omega$, $C_L = 0.1\ \mu\text{F}$, $C_T = 1000\ \text{pF}$		14		
t_D	ON delay time	$R_L = 10\ \Omega$, $C_L = 0.1\ \mu\text{F}$, $C_T = 1000\ \text{pF}$		544		
$V_{IN} = 2.5\text{ V}$, $V_{ON} = 5\text{ V}$, $V_{BIAS} = 2.5\text{ V}$, $T_A = 25^\circ\text{C}$ (unless otherwise noted)						
t_{ON}	Turnon time	$R_L = 10\ \Omega$, $C_L = 0.1\ \mu\text{F}$, $C_T = 1000\ \text{pF}$		2410		μs
t_{OFF}	Turnoff time	$R_L = 10\ \Omega$, $C_L = 0.1\ \mu\text{F}$, $C_T = 1000\ \text{pF}$		7		
t_R	V_{OUT} rise time	$R_L = 10\ \Omega$, $C_L = 0.1\ \mu\text{F}$, $C_T = 1000\ \text{pF}$		2412		
t_F	V_{OUT} fall time	$R_L = 10\ \Omega$, $C_L = 0.1\ \mu\text{F}$, $C_T = 1000\ \text{pF}$		2		
t_D	ON delay time	$R_L = 10\ \Omega$, $C_L = 0.1\ \mu\text{F}$, $C_T = 1000\ \text{pF}$		1181		
$V_{IN} = 0.8\text{ V}$, $V_{ON} = 5\text{ V}$, $V_{BIAS} = 2.5\text{ V}$, $T_A = 25^\circ\text{C}$ (unless otherwise noted)						
t_{ON}	Turnon time	$R_L = 10\ \Omega$, $C_L = 0.1\ \mu\text{F}$, $C_T = 1000\ \text{pF}$		1575		μs
t_{OFF}	Turnoff time	$R_L = 10\ \Omega$, $C_L = 0.1\ \mu\text{F}$, $C_T = 1000\ \text{pF}$		124		
t_R	V_{OUT} rise time	$R_L = 10\ \Omega$, $C_L = 0.1\ \mu\text{F}$, $C_T = 1000\ \text{pF}$		927		
t_F	V_{OUT} fall time	$R_L = 10\ \Omega$, $C_L = 0.1\ \mu\text{F}$, $C_T = 1000\ \text{pF}$		14		
t_D	ON delay time	$R_L = 10\ \Omega$, $C_L = 0.1\ \mu\text{F}$, $C_T = 1000\ \text{pF}$		1089		

6.8 Typical Characteristics

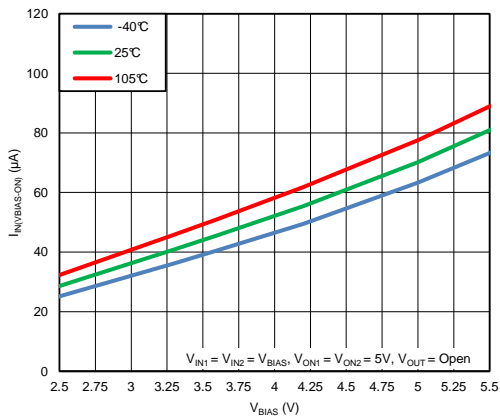

Figure 1. Quiescent Current vs. V_{BIAS} (Both Channels)

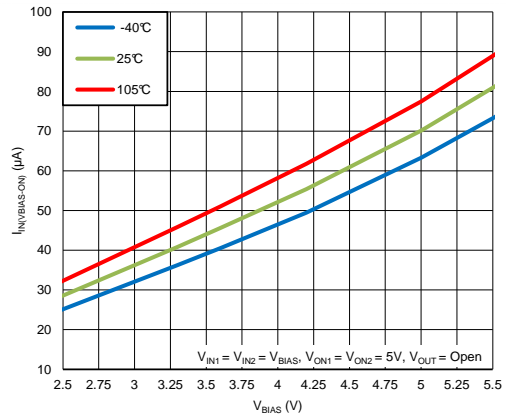

Figure 2. Quiescent Current vs. V_{BIAS} (Single Channel)

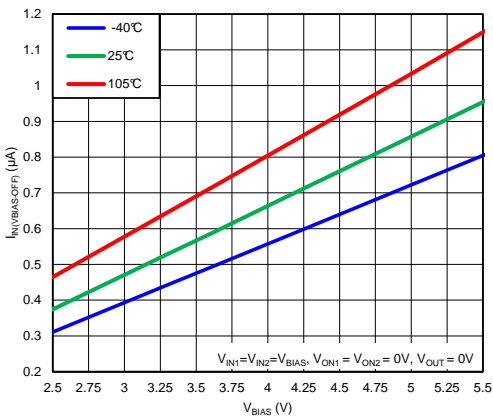

Figure 3. Shutdown Current vs. V_{BIAS} (Both Channels)

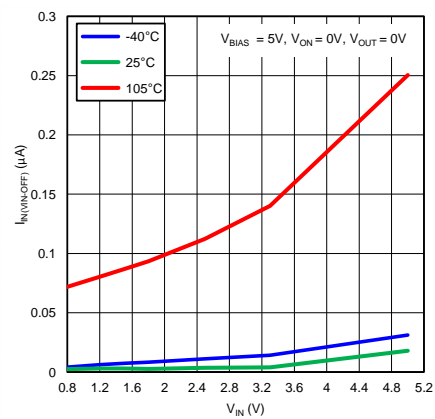

Figure 4. Off-State V_{IN} Current vs. V_{IN} (Single Channel)

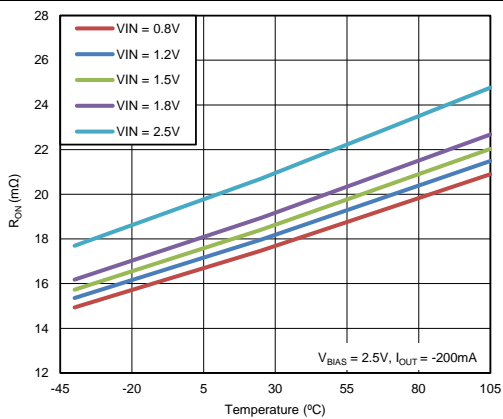

Figure 5. R_{ON} vs. Temperature ($V_{BIAS} = 2.5$ V, Single Channel)

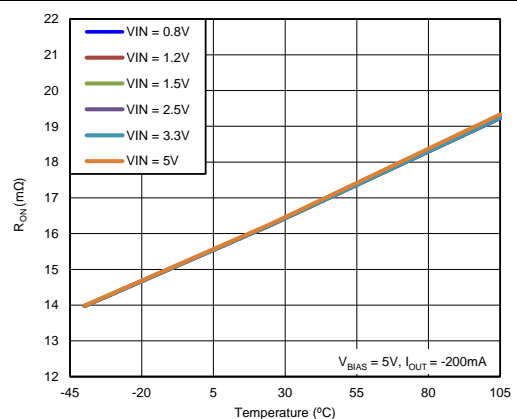

Figure 6. R_{ON} vs. Temperature ($V_{BIAS} = 5$ V, Single Channel)

Typical Characteristics (continued)

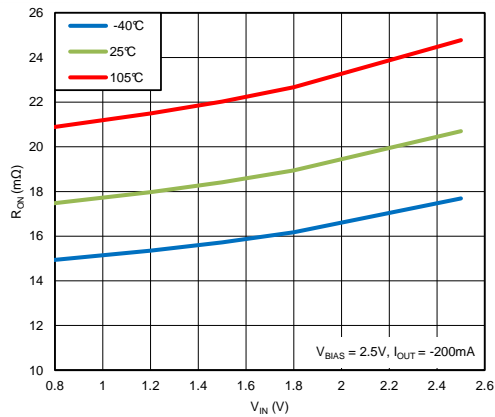

Figure 7. R_{ON} vs. V_{IN} ($V_{BIAS} = 2.5$ V, Single Channel)

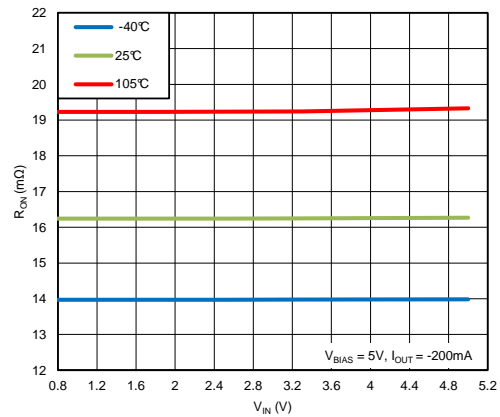

Figure 8. R_{ON} vs. V_{IN} ($V_{BIAS} = 5$ V, Single Channel)

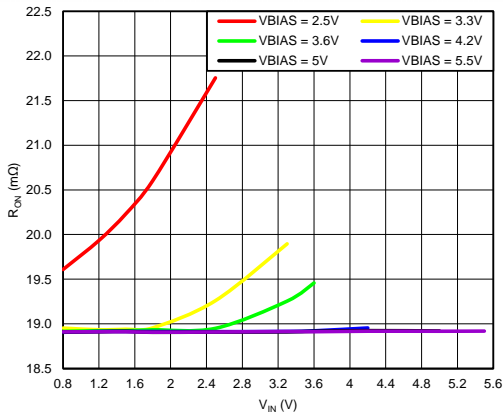

Figure 9. R_{ON} vs. V_{IN} ($T_A = 25^\circ\text{C}$, Single Channel)

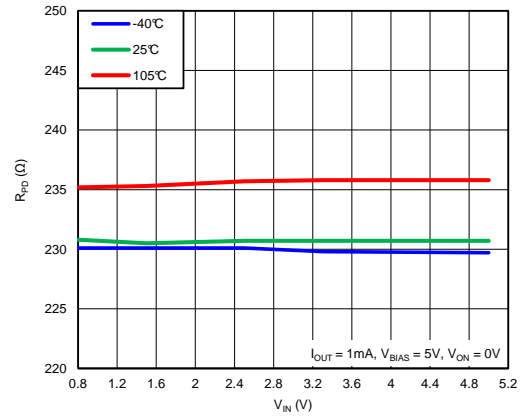

Figure 10. R_{PD} vs. V_{IN} ($V_{BIAS} = 5$ V, Single Channel)

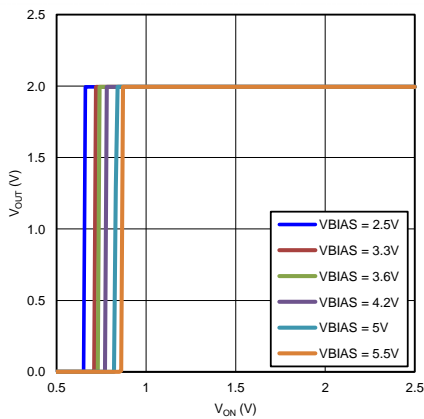

Figure 11. V_{OUT} vs. V_{ON} ($T_A = 25^\circ\text{C}$, Single Channel)

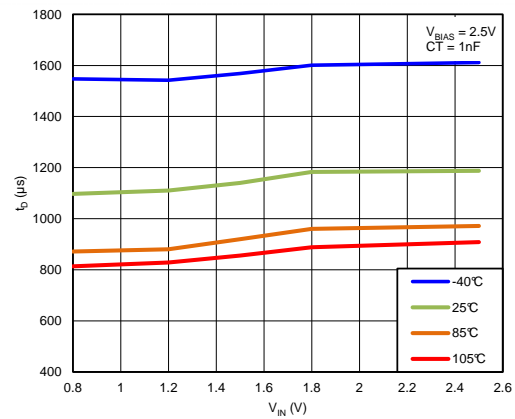

Figure 12. t_D vs. V_{IN} ($V_{BIAS} = 2.5$ V, $C_T = 1$ nF)

Typical Characteristics (continued)

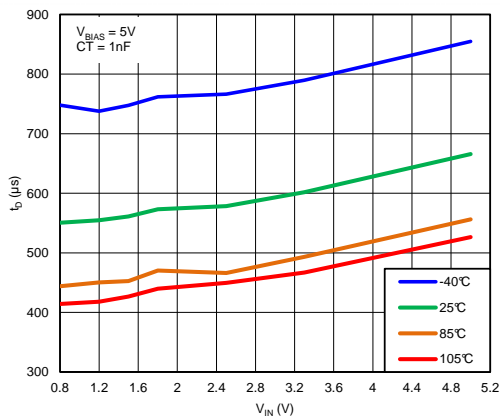

Figure 13. t_D vs. V_{IN} ($V_{BIAS} = 5\text{ V}$, $CT = 1\text{ nF}$)

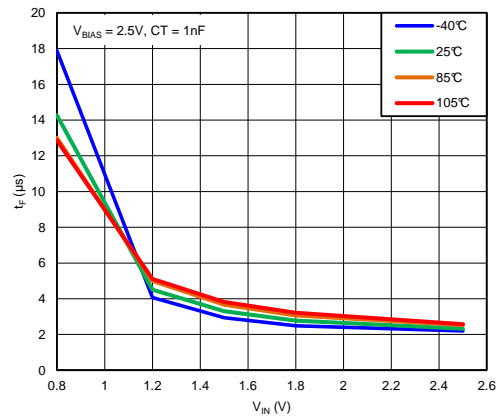

Figure 14. t_F vs. V_{IN} ($V_{BIAS} = 2.5\text{ V}$, $CT = 1\text{ nF}$)

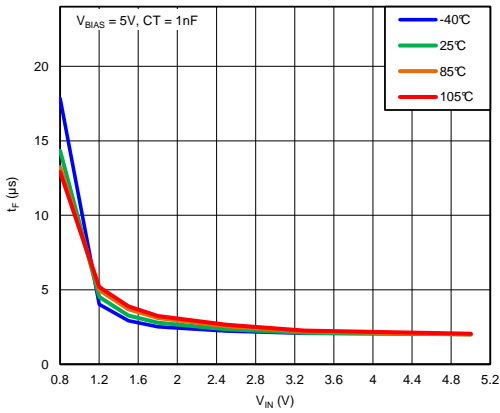

Figure 15. t_F vs. V_{IN} ($V_{BIAS} = 5\text{ V}$, $CT = 1\text{ nF}$)

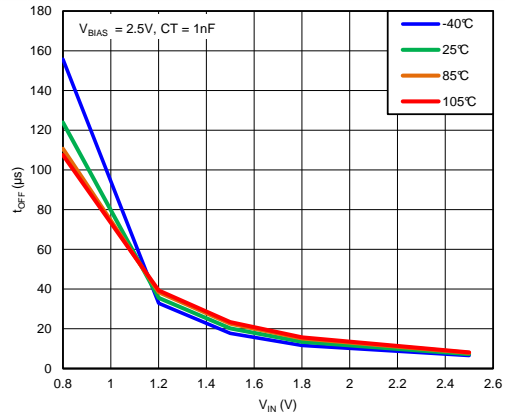

Figure 16. t_{OFF} vs. V_{IN} ($V_{BIAS} = 2.5\text{ V}$, $CT = 1\text{ nF}$)

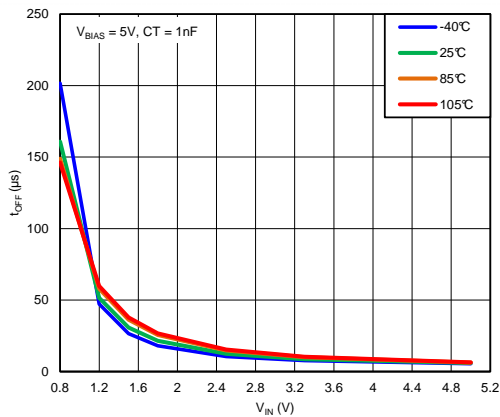

Figure 17. t_{OFF} vs. V_{IN} ($V_{BIAS} = 5\text{ V}$, $CT = 1\text{ nF}$)

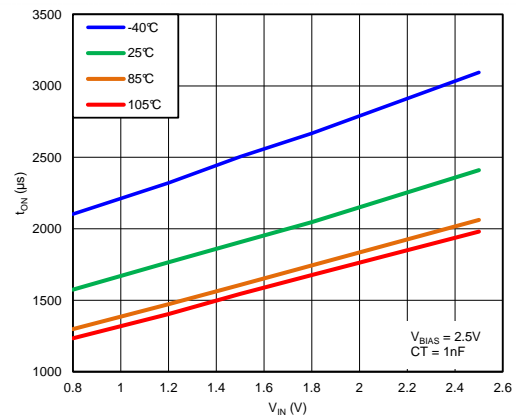

Figure 18. t_{ON} vs. V_{IN} ($V_{BIAS} = 2.5\text{ V}$, $CT = 1\text{ nF}$)

Typical Characteristics (continued)

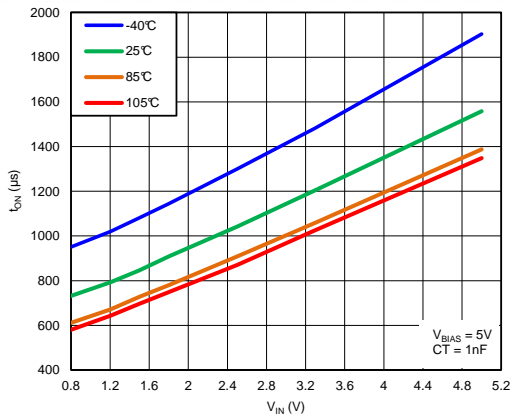

Figure 19. t_{ON} vs. V_{IN} ($V_{BIAS} = 5\text{ V}$, $C_T = 1\text{ nF}$)

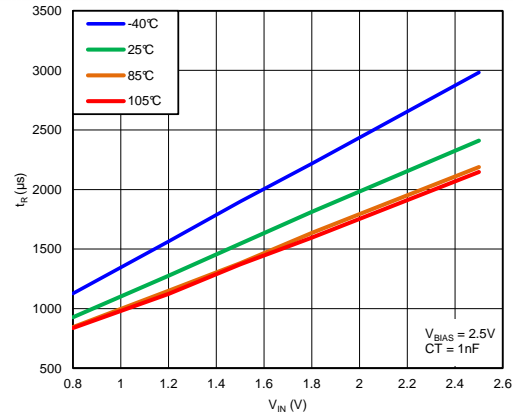

Figure 20. t_R vs. V_{IN} ($V_{BIAS} = 2.5\text{ V}$, $C_T = 1\text{ nF}$)

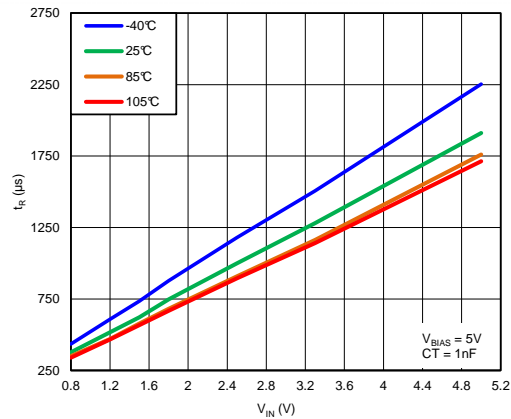

Figure 21. t_R vs. V_{IN} ($V_{BIAS} = 5\text{ V}$, $C_T = 1\text{ nF}$)

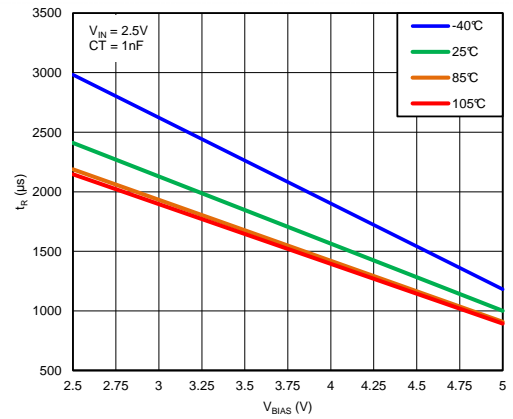

Figure 22. t_R vs. V_{BIAS} ($V_{IN} = 2.5\text{ V}$, $C_T = 1\text{ nF}$)

6.8.1 Typical AC Scope Captures at $T_A = 25^\circ\text{C}$, $C_T = 1\text{ nF}$

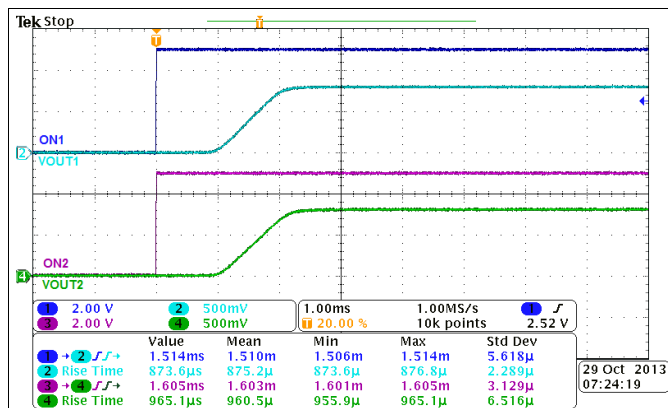

Figure 23. Turnon Response Time ($V_{IN} = 0.8\text{ V}$, $V_{BIAS} = 2.5\text{ V}$, $C_{IN} = 1\text{ }\mu\text{F}$, $C_L = 0.1\text{ }\mu\text{F}$, $R_L = 10\text{ }\Omega$)

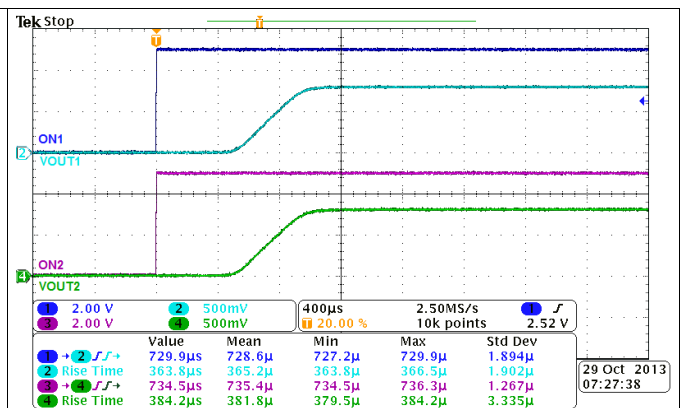

Figure 24. Turnon Response Time ($V_{IN} = 0.8\text{ V}$, $V_{BIAS} = 5\text{ V}$, $C_{IN} = 1\text{ }\mu\text{F}$, $C_L = 0.1\text{ }\mu\text{F}$, $R_L = 10\text{ }\Omega$)

Typical AC Scope Captures at $T_A = 25^\circ\text{C}$, $C_T = 1\text{ nF}$ (continued)

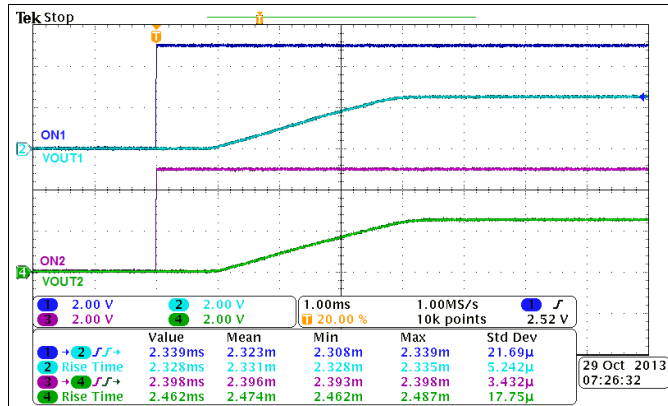

Figure 25. Turnon Response Time ($V_{IN} = 2.5\text{ V}$, $V_{BIAS} = 2.5\text{ V}$, $C_{IN} = 1\text{ }\mu\text{F}$, $C_L = 0.1\text{ }\mu\text{F}$, $R_L = 10\text{ }\Omega$)

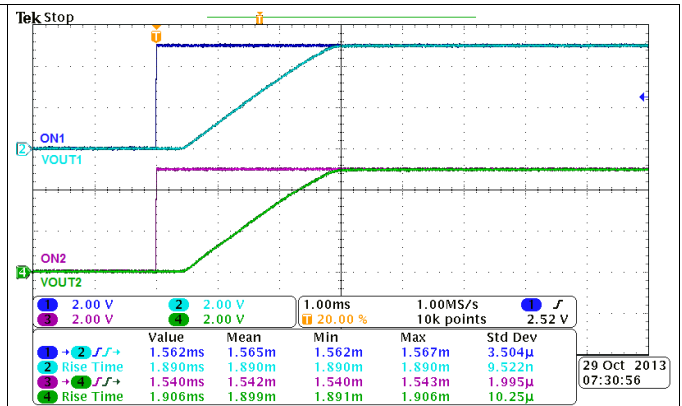

Figure 26. Turnon Response Time ($V_{IN} = 5\text{ V}$, $V_{BIAS} = 5\text{ V}$, $C_{IN} = 1\text{ }\mu\text{F}$, $C_L = 0.1\text{ }\mu\text{F}$, $R_L = 10\text{ }\Omega$)

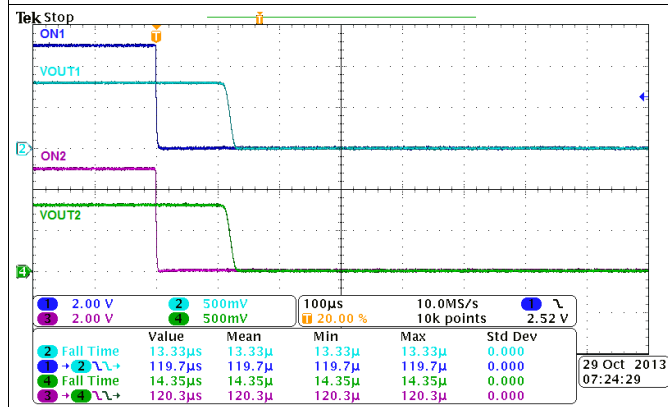

Figure 27. Turnoff Response Time ($V_{IN} = 0.8\text{ V}$, $V_{BIAS} = 2.5\text{ V}$, $C_{IN} = 1\text{ }\mu\text{F}$, $C_L = 0.1\text{ }\mu\text{F}$, $R_L = 10\text{ }\Omega$)

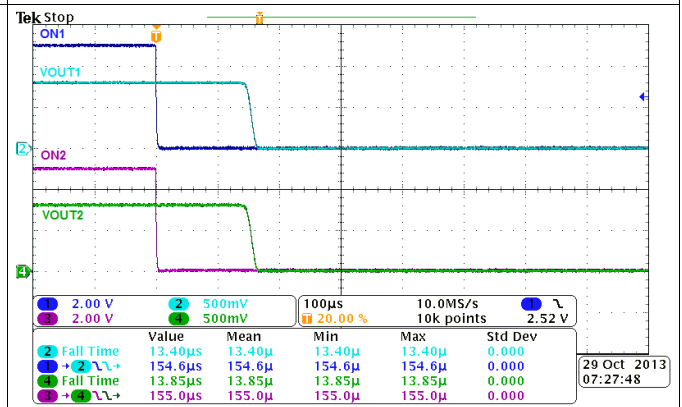

Figure 28. Turnoff Response Time ($V_{IN} = 0.8\text{ V}$, $V_{BIAS} = 5\text{ V}$, $C_{IN} = 1\text{ }\mu\text{F}$, $C_L = 0.1\text{ }\mu\text{F}$, $R_L = 10\text{ }\Omega$)

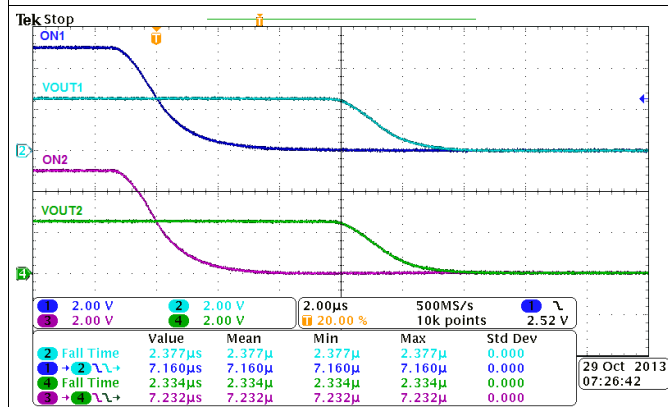

Figure 29. Turnoff Response Time ($V_{IN} = 2.5\text{ V}$, $V_{BIAS} = 2.5\text{ V}$, $C_{IN} = 1\text{ }\mu\text{F}$, $C_L = 0.1\text{ }\mu\text{F}$, $R_L = 10\text{ }\Omega$)

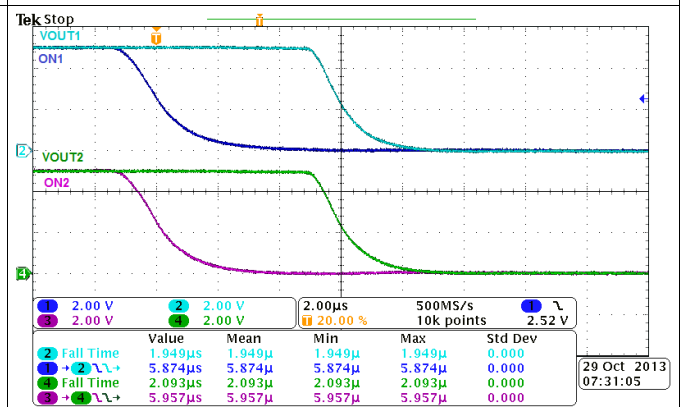
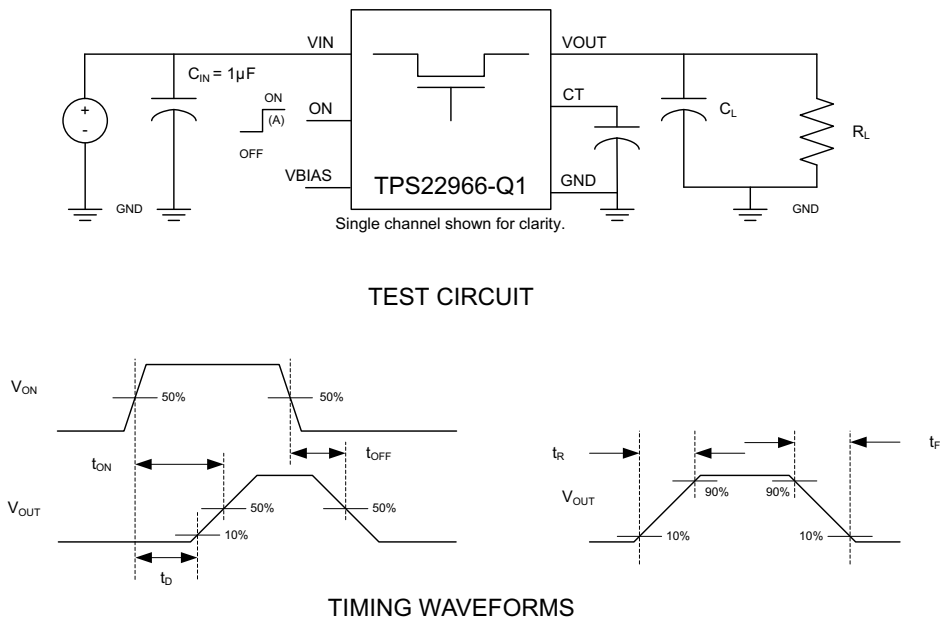

Figure 30. Turnoff Response Time ($V_{IN} = 5\text{ V}$, $V_{BIAS} = 5\text{ V}$, $C_{IN} = 1\text{ }\mu\text{F}$, $C_L = 0.1\text{ }\mu\text{F}$, $R_L = 10\text{ }\Omega$)

7 Parameter Measurement Information



(A) Control signal rise and fall times are 100 ns.

Figure 31. Test Circuit and Timing Waveforms

8 Detailed Description

8.1 Overview

The device is a dual-channel, 4-A automotive load switch in a 14-pin SON package. To reduce the voltage drop in high current rails, the device implements a low-resistance N-channel MOSFET.

The device has a programmable slew rate for applications that require specific rise-time. The device has very low leakage current during off state. This prevents downstream circuits from pulling high standby current from the supply. Integrated control logic, driver, power supply, and output discharge FET eliminates the need for any external components, which reduces solution size and bill of materials (BOM) count.

8.2 Functional Block Diagram

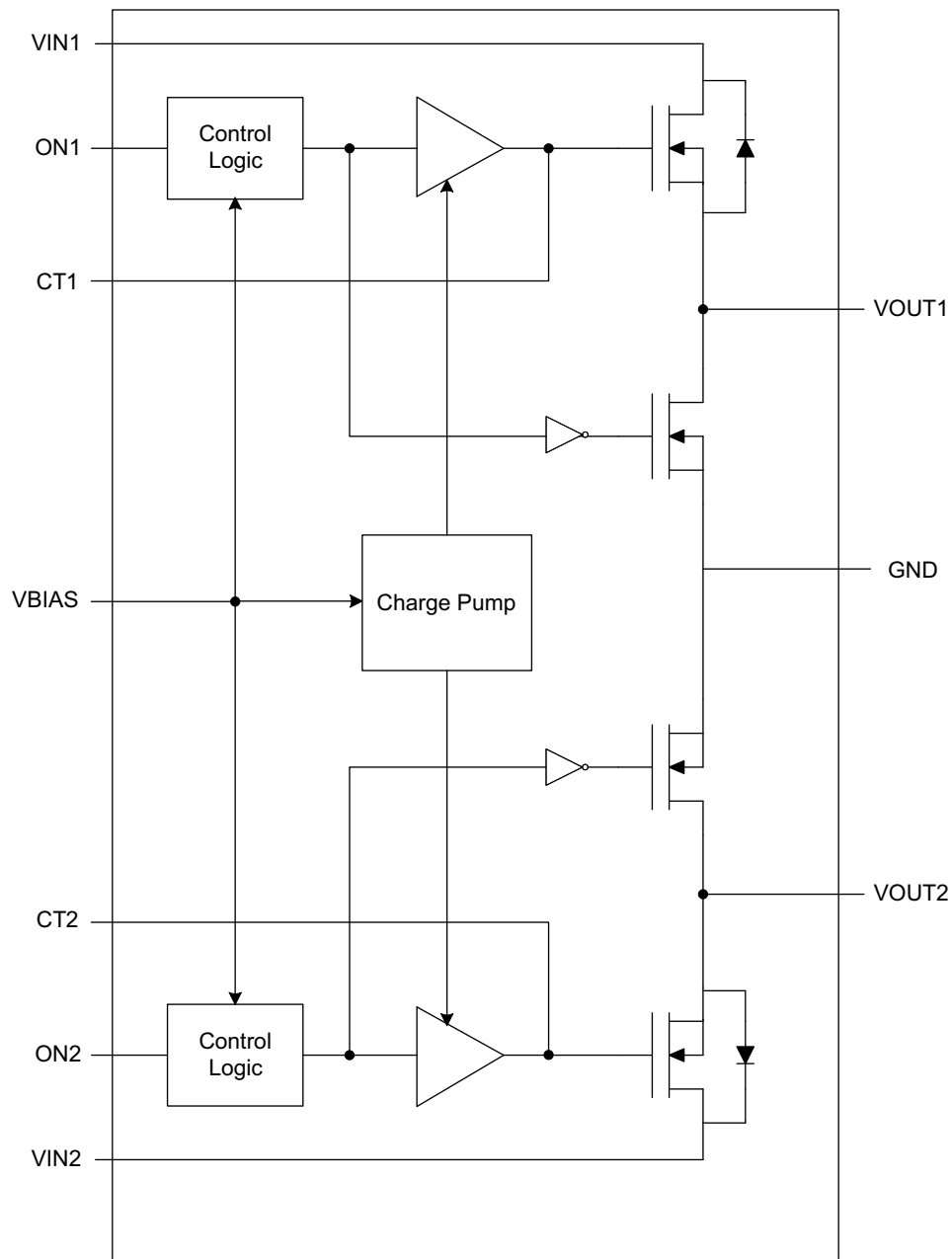

8.3 Feature Description

8.3.1 Quick Output Discharge

Each channel of the TPS22966-Q1 includes a Quick Output Discharge (QOD) feature. When the switch is disabled, a discharge resistor is connected between VOUT and GND. This resistor has a typical value of 230-Ω and prevents the output from floating while the switch is disabled.

8.3.2 ON/OFF Control

The ON pins control the state of the switch. Asserting ON high enables the switch. ON is active high and has a low threshold, making it capable of interfacing with low-voltage signals. The ON pin is compatible with standard GPIO logic threshold. It can be used with any microcontroller with 1.2-V or higher GPIO voltage. This pin cannot be left floating and must be tied either high or low for proper functionality.

8.3.3 Adjustable Rise Time

A capacitor to GND on the CTx pins sets the slew rate for each channel. To ensure desired performance, a capacitor with a minimum voltage rating of 25 V should be used on the CTx pin. An approximate formula for the relationship between CTx and slew rate is (the equation below accounts for 10% to 90% measurement on V_{OUT} and does **NOT** apply for CTx = 0 pF). Use [Table 1](#) to determine rise times for when CTx = 0 pF):

$$SR = 0.32 \times CT + 13.7$$

where

- SR = slew rate (in μs/V)
- CT = the capacitance value on the CTx pin (in pF)
- The units for the constant 13.7 is in μs/V. (1)

Rise time can be calculated by multiplying the input voltage by the slew rate. [Table 1](#) shows rise time values measured on a typical device. Rise times shown below are only valid for the power-up sequence where V_{IN} and V_{BIAS} are already in steady state condition, and the ON pin is asserted high.

Table 1. Rise Time Values

CTx (pF)	RISE TIME (μs) 10% - 90%, C _L = 0.1μF, C _{IN} = 1μF, R _L = 10Ω TYPICAL VALUES at 25°C, V _{BIAS} = 5V, 25V X7R 10% CERAMIC CAP						
	5V	3.3V	1.8V	1.5V	1.2V	1.05V	0.8V
0	124	88	63	60	53	49	42
220	481	323	193	166	143	133	109
470	855	603	348	299	251	228	175
1000	1724	1185	670	570	469	411	342
2200	3328	2240	1308	1088	893	808	650
4700	7459	4950	2820	2429	1920	1748	1411
10000	16059	10835	6040	5055	4230	3770	3033

8.4 Device Functional Modes

Table 2. Functional Table

ONx	VINx to VOUTx	VOUTx to GND
L	Off	On
H	On	Off

9 Application and Implementation

NOTE

Information in the following applications sections is not part of the TI component specification, and TI does not warrant its accuracy or completeness. TI's customers are responsible for determining suitability of components for their purposes. Customers should validate and test their design implementation to confirm system functionality.

9.1 Application Information

9.1.1 Input Capacitor (Optional)

To limit the voltage drop on the input supply caused by transient in-rush currents when the switch turns on into a discharged load capacitor, a capacitor needs to be placed between V_{IN} and GND. A 1- μ F ceramic capacitor, C_{IN} , placed close to the pins, is usually sufficient. Higher values of C_{IN} can be used to further reduce the voltage drop in high-current application. When switching heavy loads, it is recommended to have an input capacitor about 10 times higher than the output capacitor to avoid excessive voltage drop.

9.1.2 Output Capacitor (Optional)

Due to the integrated body diode in the NMOS switch, a C_{IN} greater than C_L is highly recommended. A C_L greater than C_{IN} can cause V_{OUT} to exceed V_{IN} when the system supply is removed. This could result in current flow through the body diode from V_{OUT} to V_{IN} . A C_{IN} to C_L ratio of 10 to 1 is recommended for minimizing V_{IN} dip caused by inrush currents during start-up, however a 10 to 1 ratio for capacitance is not required for proper functionality of the device. A ratio smaller than 10 to 1 (such as 1 to 1) could cause slightly more V_{IN} dip upon turnon due to inrush currents. This can be mitigated by increasing the capacitance on the CT pin for a longer rise time (see [Adjustable Rise Time](#)).

9.1.3 V_{IN} and V_{BIAS} Voltage Range

For optimal R_{ON} performance, make sure $V_{IN} \leq V_{BIAS}$. The device will still be functional if $V_{IN} > V_{BIAS}$ but it will exhibit R_{ON} greater than what is listed in [Electrical Characteristics](#). See [Figure 32](#) for an example of a typical device. Notice the increasing R_{ON} as V_{IN} exceeds V_{BIAS} voltage.

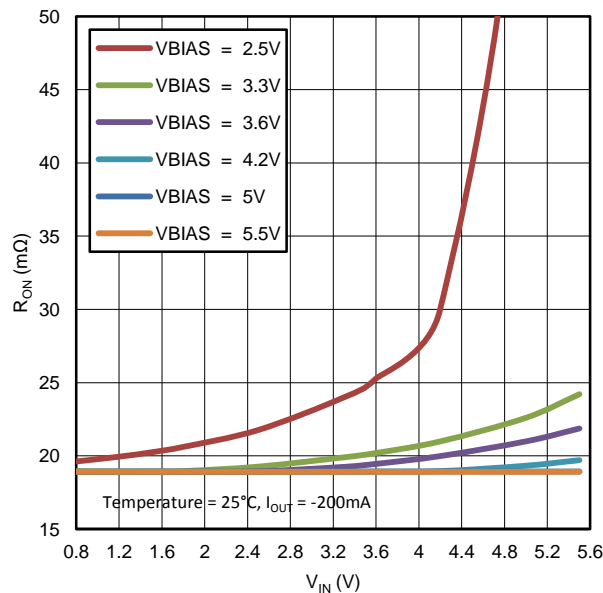

Figure 32. R_{ON} vs. V_{IN} (Single Channel)

Application Information (continued)

9.1.4 Safe Operating Area (SOA)

The SOA curves in [Figure 33](#) show the continuous current carrying capability of the device versus ambient temperature (T_A) to ensure reliable operation over 100,000 hours of device lifetime. Each curve represents a specific percent of time that the switch is on.

The 100% curve represents use for a full 24 hours in a day. The 75% curve indicates 18 hours of use in a day while the 12.5% curve shows 3 hours of use per day.

Examples on how to use this plot:

- The application has an ambient temperature of 60°C and the switch will be on 100% of the time. The maximum continuous current that can be applied is approximately 2.1 A.
- The application requires the switch to be on 12.5% of the time and the current while on will be 3 A. The maximum ambient temperature is approximately 100°C.
- The application requires 2 A and will be operated at 70°C. The switch can be on for a maximum of 75% of the time.
- It is expected that most applications will not have specific use cases as defined in the examples above. Different use cases can be combined to generate a more complete view of a specific application. This example shows use under various conditions simplified to an average use case. The application requires operation at 4 A for 25% of the time, 1 A for 25% of the time and is off the remaining 50% of the time. Ambient temperature will vary from 25°C to 50°C. Will there be any limitations? The average current can be calculated as $(4\text{ A} \times 25\% + 1\text{ A} \times 25\% + 0\text{ A} \times 50\%)$. The average current calculates to be 1.25 A. Assuming worst case temperature of 50°C, the resulting application is within the safe operating area.

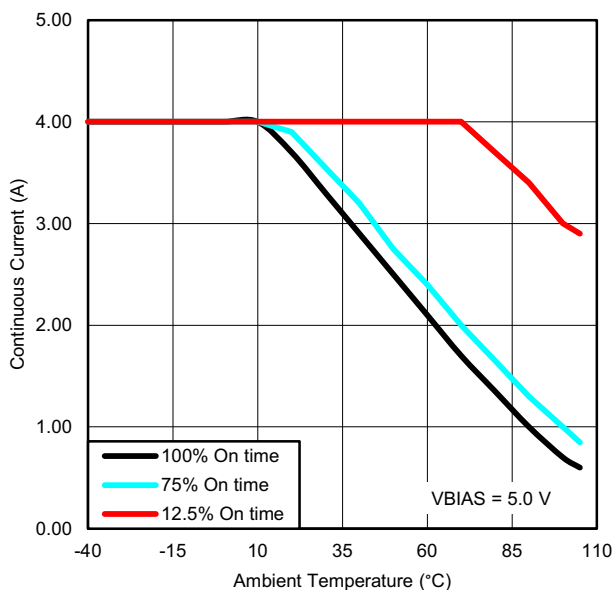

Figure 33. Safe Operating Area

9.2 Typical Application

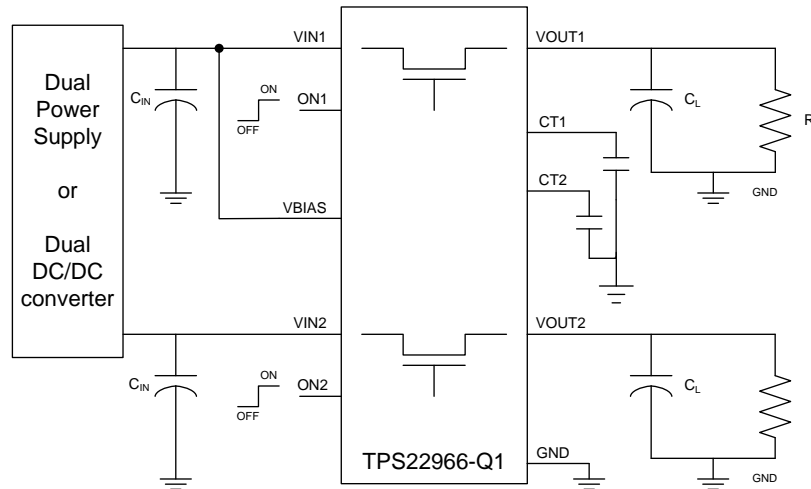

Figure 34. Typical Application Schematic

9.2.1 Design Requirements

For this design example, use the parameters listed in [Table 3](#) as the input parameters.

Table 3. Design Parameters

DESIGN PARAMETER	VALUE
Input voltage	3.3 V
Bias voltage	5 V
Load capacitance (C_L)	22 μ F
Maximum acceptable inrush current	400 mA

9.2.2 Detailed Design Procedure

When the switch is enabled, the output capacitors must be charged up from 0 V to the set value (3.3 V in this example). This charge arrives in the form of inrush current. Inrush current can be calculated using [Equation 2](#):

$$\text{Inrush Current} = C \times dV/dt \quad (2)$$

where

- C = output capacitance
- dV = output voltage
- dt = rise time

The TPS22966-Q1 offers adjustable rise time for VOUT. This feature allows the user to control the inrush current during turnon. The appropriate rise time can be calculated using [Table 3](#) and the inrush current equation.

$$400 \text{ mA} = 22 \mu\text{F} \times 3.3 \text{ V}/dt \quad (3)$$

$$dt = 181.5 \mu\text{s} \quad (4)$$

To ensure an inrush current of less than 400 mA, choose a CT value that will yield a rise time of more than 181.5 μ s. See the oscilloscope captures in for an example of how the CT capacitor can be used to reduce inrush current.

9.2.3 Application Curves

$V_{BIAS} = 5\text{ V}$; $V_{IN} = 3.3\text{ V}$; $C_L = 22\text{ }\mu\text{F}$

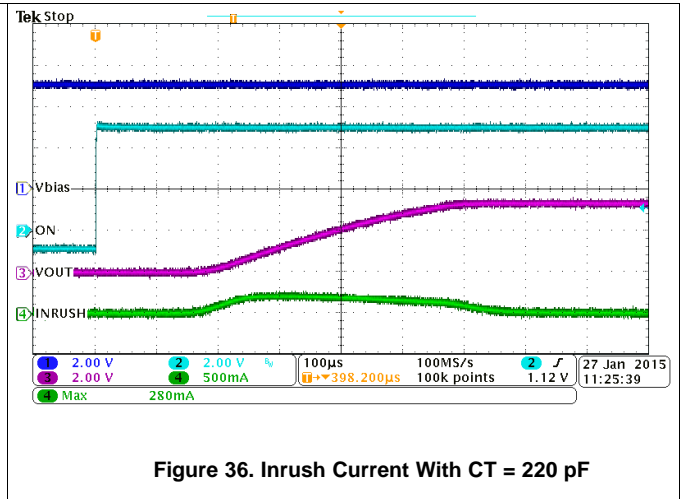
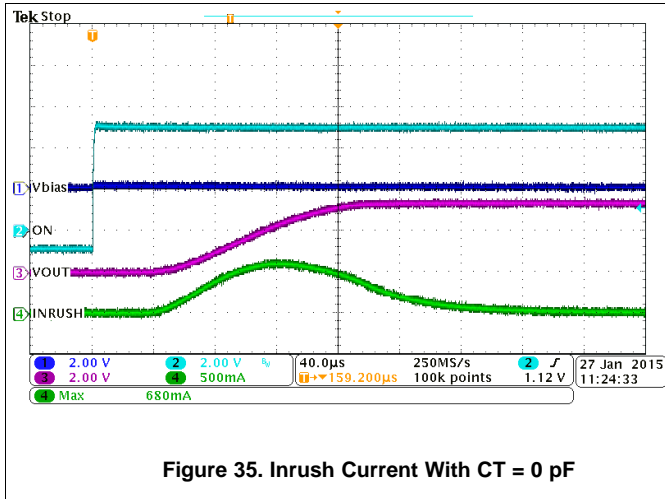

10 Power Supply Recommendations

The device is designed to operate from a VBIAS range of 2.5 V to 5.5 V and a VIN voltage range of 0.8 V to 5.5 V. The power supply should be well regulated and placed as close to the device terminals as possible. It must be able to withstand all transient and load current steps. In most situations, using an input capacitance of 1 uF is sufficient to prevent the supply voltage from dipping when the switch is turned on. In cases where the power supply is slow to respond to a large transient current or large load current step, additional bulk capacitance may be required on the input.

The requirements for larger input capacitance can be mitigated by adding additional capacitance to the CT pin. This will cause the load switch to turn on more slowly. Not only will this reduce transient inrush current, but it will also give the power supply more time to respond to the load current step.

11 Layout

11.1 Layout Guidelines

For best performance, all traces should be as short as possible. To be most effective, the input and output capacitors should be placed close to the device to minimize the effects that parasitic trace inductances may have on normal operation. Using wide traces for VIN, VOUT, and GND helps minimize the parasitic electrical effects along with minimizing the case to ambient thermal impedance.

The maximum IC junction temperature should be restricted to 150°C under normal operating conditions. To calculate the maximum allowable power dissipation, $P_{D(max)}$ for a given output current and ambient temperature, use the following equation:

$$P_{D(max)} = \frac{T_{J(max)} - T_A}{\theta_{JA}}$$

where

- $P_{D(max)}$ = maximum allowable power dissipation
- $T_{J(max)}$ = maximum allowable junction temperature (150°C for the TPS22966-Q1)
- T_A = ambient temperature
- θ_{JA} = junction to air thermal impedance. See Thermal Information section. This parameter is highly dependent upon board layout. (5)

[Figure 37](#) shows an example of a layout. Notice the thermal vias located under the exposed thermal pad of the device. This allows for thermal diffusion away from the device.

11.2 Layout Example

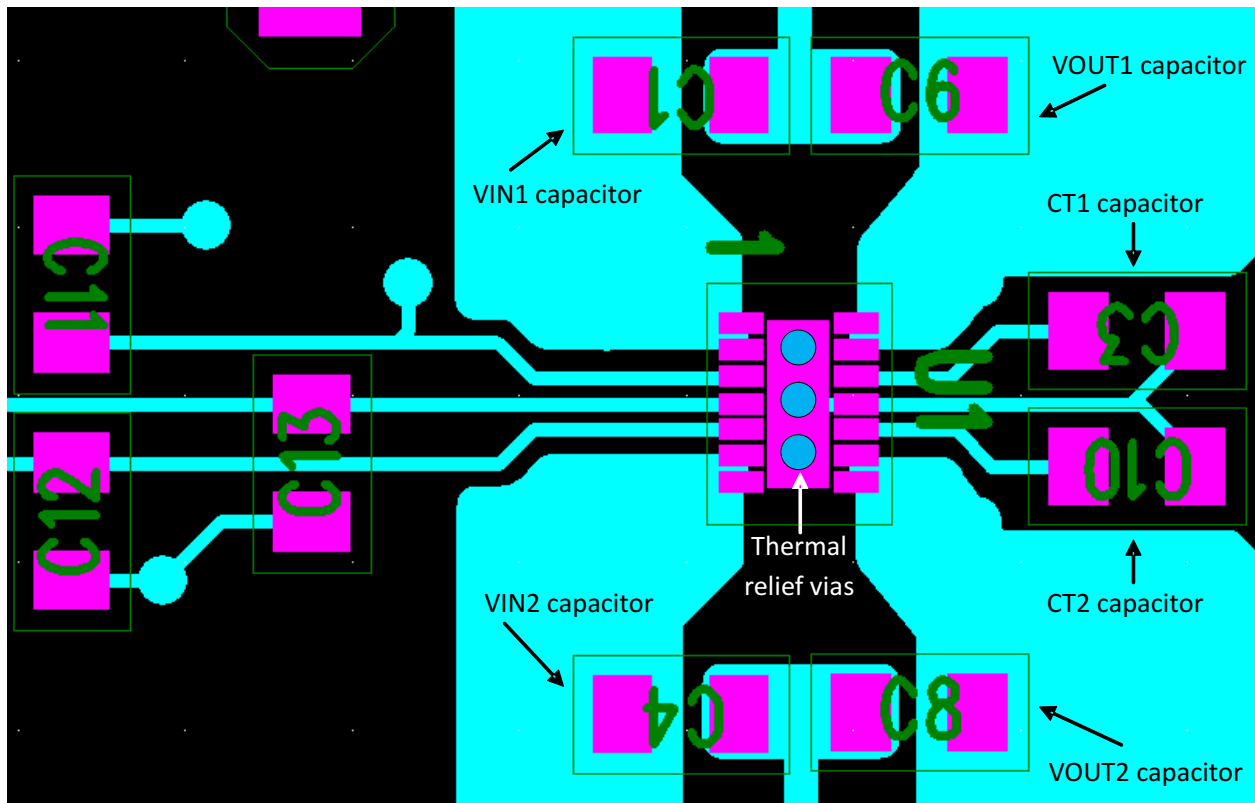

Figure 37. Layout Example

12 Device and Documentation Support

12.1 Trademarks

All trademarks are the property of their respective owners.

12.2 Electrostatic Discharge Caution



These devices have limited built-in ESD protection. The leads should be shorted together or the device placed in conductive foam during storage or handling to prevent electrostatic damage to the MOS gates.

12.3 Glossary

[SLYZ022](#) — *TI Glossary*.

This glossary lists and explains terms, acronyms, and definitions.

13 Mechanical, Packaging, and Orderable Information

The following pages include mechanical, packaging, and orderable information. This information is the most current data available for the designated devices. This data is subject to change without notice and revision of this document. For browser-based versions of this data sheet, refer to the left-hand navigation.

PACKAGING INFORMATION

Orderable Device	Status (1)	Package Type	Package Drawing	Pins	Package Qty	Eco Plan (2)	Lead/Ball Finish (6)	MSL Peak Temp (3)	Op Temp (°C)	Device Marking (4/5)	Samples
TPS22966TDPURQ1	ACTIVE	WSON	DPU	14	3000	Green (RoHS & no Sb/Br)	CU NIPDAU	Level-2-260C-1 YEAR	-40 to 105	966TQ1	Samples
TPS22966TDPURQ1	ACTIVE	WSON	DPU	14	250	Green (RoHS & no Sb/Br)	CU NIPDAU	Level-2-260C-1 YEAR	-40 to 105	966TQ1	Samples

(1) The marketing status values are defined as follows:

ACTIVE: Product device recommended for new designs.

LIFEBUY: TI has announced that the device will be discontinued, and a lifetime-buy period is in effect.

NRND: Not recommended for new designs. Device is in production to support existing customers, but TI does not recommend using this part in a new design.

PREVIEW: Device has been announced but is not in production. Samples may or may not be available.

OBSELETE: TI has discontinued the production of the device.

(2) Eco Plan - The planned eco-friendly classification: Pb-Free (RoHS), Pb-Free (RoHS Exempt), or Green (RoHS & no Sb/Br) - please check <http://www.ti.com/productcontent> for the latest availability information and additional product content details.

TBD: The Pb-Free/Green conversion plan has not been defined.

Pb-Free (RoHS): TI's terms "Lead-Free" or "Pb-Free" mean semiconductor products that are compatible with the current RoHS requirements for all 6 substances, including the requirement that lead not exceed 0.1% by weight in homogeneous materials. Where designed to be soldered at high temperatures, TI Pb-Free products are suitable for use in specified lead-free processes.

Pb-Free (RoHS Exempt): This component has a RoHS exemption for either 1) lead-based flip-chip solder bumps used between the die and package, or 2) lead-based die adhesive used between the die and leadframe. The component is otherwise considered Pb-Free (RoHS compatible) as defined above.

Green (RoHS & no Sb/Br): TI defines "Green" to mean Pb-Free (RoHS compatible), and free of Bromine (Br) and Antimony (Sb) based flame retardants (Br or Sb do not exceed 0.1% by weight in homogeneous material)

(3) MSL, Peak Temp. - The Moisture Sensitivity Level rating according to the JEDEC industry standard classifications, and peak solder temperature.

(4) There may be additional marking, which relates to the logo, the lot trace code information, or the environmental category on the device.

(5) Multiple Device Markings will be inside parentheses. Only one Device Marking contained in parentheses and separated by a "~" will appear on a device. If a line is indented then it is a continuation of the previous line and the two combined represent the entire Device Marking for that device.

(6) Lead/Ball Finish - Orderable Devices may have multiple material finish options. Finish options are separated by a vertical ruled line. Lead/Ball Finish values may wrap to two lines if the finish value exceeds the maximum column width.

Important Information and Disclaimer:The information provided on this page represents TI's knowledge and belief as of the date that it is provided. TI bases its knowledge and belief on information provided by third parties, and makes no representation or warranty as to the accuracy of such information. Efforts are underway to better integrate information from third parties. TI has taken and continues to take reasonable steps to provide representative and accurate information but may not have conducted destructive testing or chemical analysis on incoming materials and chemicals. TI and TI suppliers consider certain information to be proprietary, and thus CAS numbers and other limited information may not be available for release.

In no event shall TI's liability arising out of such information exceed the total purchase price of the TI part(s) at issue in this document sold by TI to Customer on an annual basis.

OTHER QUALIFIED VERSIONS OF TPS22966-Q1 :

- Catalog: [TPS22966](#)

NOTE: Qualified Version Definitions:

- Catalog - TI's standard catalog product

TAPE AND REEL INFORMATION

QUADRANT ASSIGNMENTS FOR PIN 1 ORIENTATION IN TAPE

*All dimensions are nominal

Device	Package Type	Package Drawing	Pins	SPQ	Reel Diameter (mm)	Reel Width W1 (mm)	A0 (mm)	B0 (mm)	K0 (mm)	P1 (mm)	W (mm)	Pin1 Quadrant
TPS22966TDPURQ1	WSON	DPU	14	3000	180.0	8.4	2.25	3.25	1.05	4.0	8.0	Q1
TPS22966TDPUTQ1	WSON	DPU	14	250	180.0	8.4	2.25	3.25	1.05	4.0	8.0	Q1

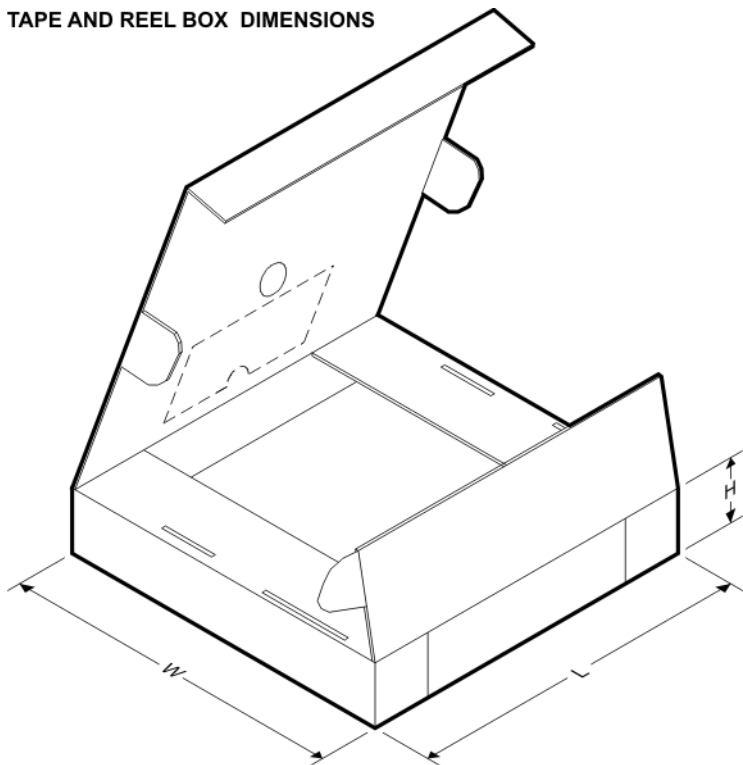
TAPE AND REEL BOX DIMENSIONS



*All dimensions are nominal

Device	Package Type	Package Drawing	Pins	SPQ	Length (mm)	Width (mm)	Height (mm)
TPS22966TDPURQ1	WSON	DPU	14	3000	210.0	185.0	35.0
TPS22966TDPUTQ1	WSON	DPU	14	250	210.0	185.0	35.0

DPU (R-PWSON-N14)

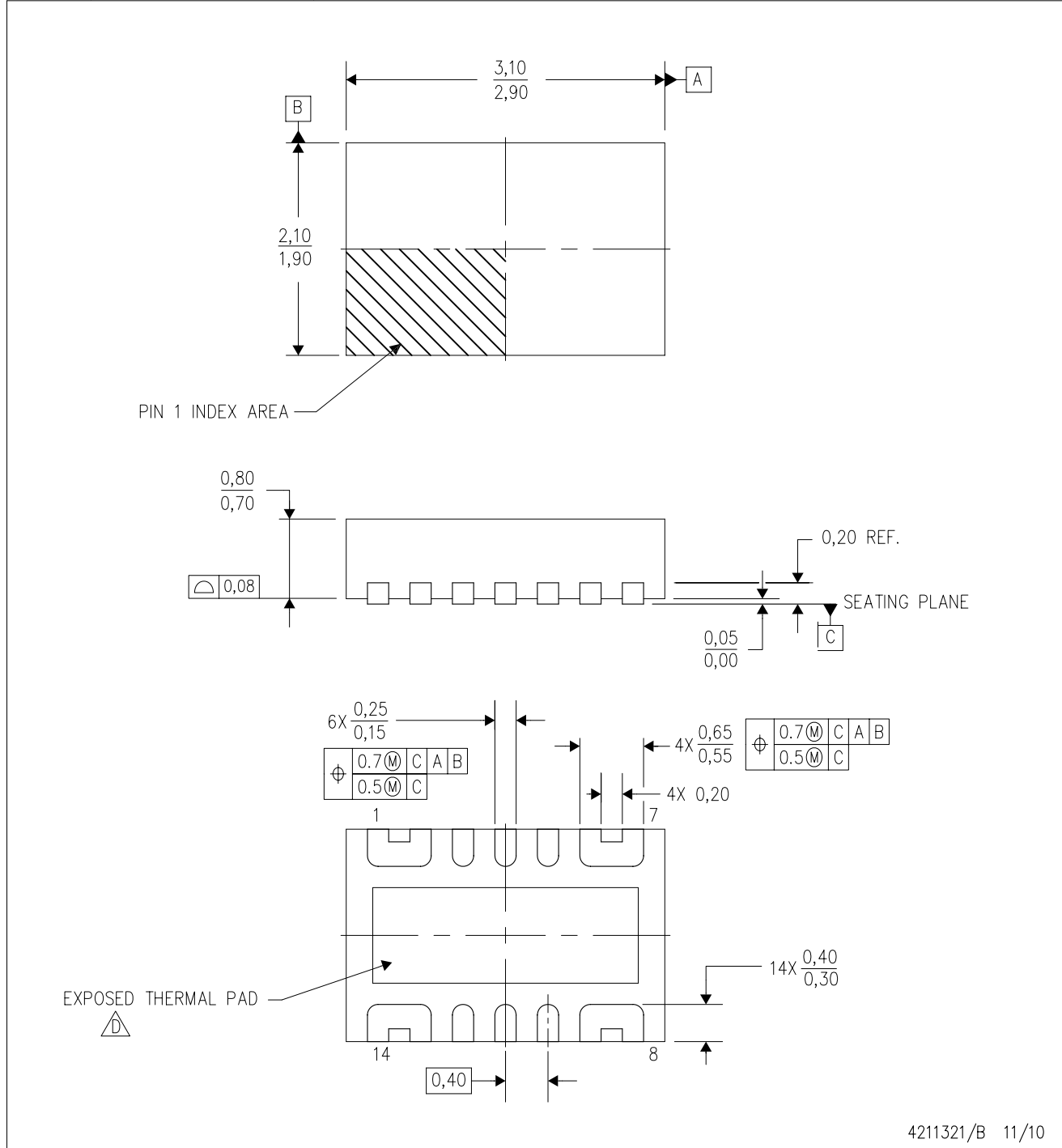
PLASTIC SMALL OUTLINE NO-LEAD



- NOTES:
- All linear dimensions are in millimeters. Dimensioning and tolerancing per ASME Y14.5M-1994.
 - This drawing is subject to change without notice.
 - Small Outline No-Lead (SON) package configuration.
 -  The package thermal pad must be soldered to the board for thermal and mechanical performance. See the Product Data Sheet for details regarding the exposed thermal pad dimensions.
 - This package is Pb-free.

THERMAL PAD MECHANICAL DATA

DPU (R-PWSON-N14)

PLASTIC SMALL OUTLINE NO-LEAD

THERMAL INFORMATION

This package incorporates an exposed thermal pad that is designed to be attached directly to an external heatsink. The thermal pad must be soldered directly to the printed circuit board (PCB). After soldering, the PCB can be used as a heatsink. In addition, through the use of thermal vias, the thermal pad can be attached directly to the appropriate copper plane shown in the electrical schematic for the device, or alternatively, can be attached to a special heatsink structure designed into the PCB. This design optimizes the heat transfer from the integrated circuit (IC).

For information on the Quad Flatpack No-Lead (QFN) package and its advantages, refer to Application Report, QFN/SON PCB Attachment, Texas Instruments Literature No. SLUA271. This document is available at www.ti.com.

The exposed thermal pad dimensions for this package are shown in the following illustration.

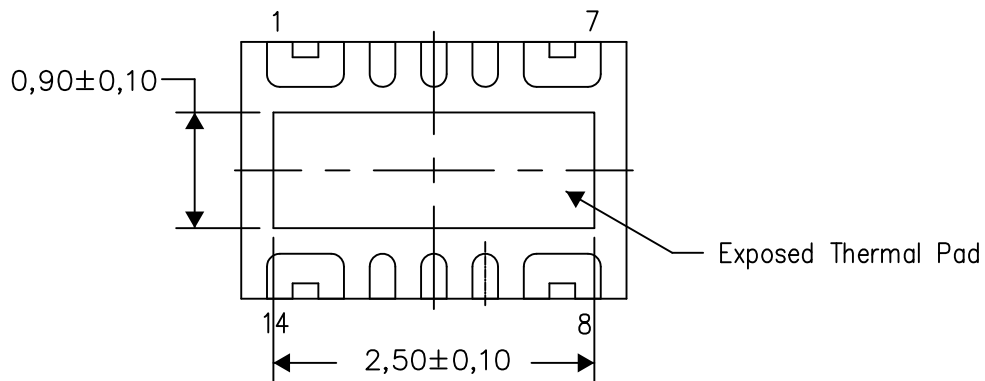

Bottom View

Exposed Thermal Pad Dimensions

4211395/B 12/12

NOTE: All linear dimensions are in millimeters

DPU (R-PWSON-N14)

PLASTIC SMALL OUTLINE NO-LEAD

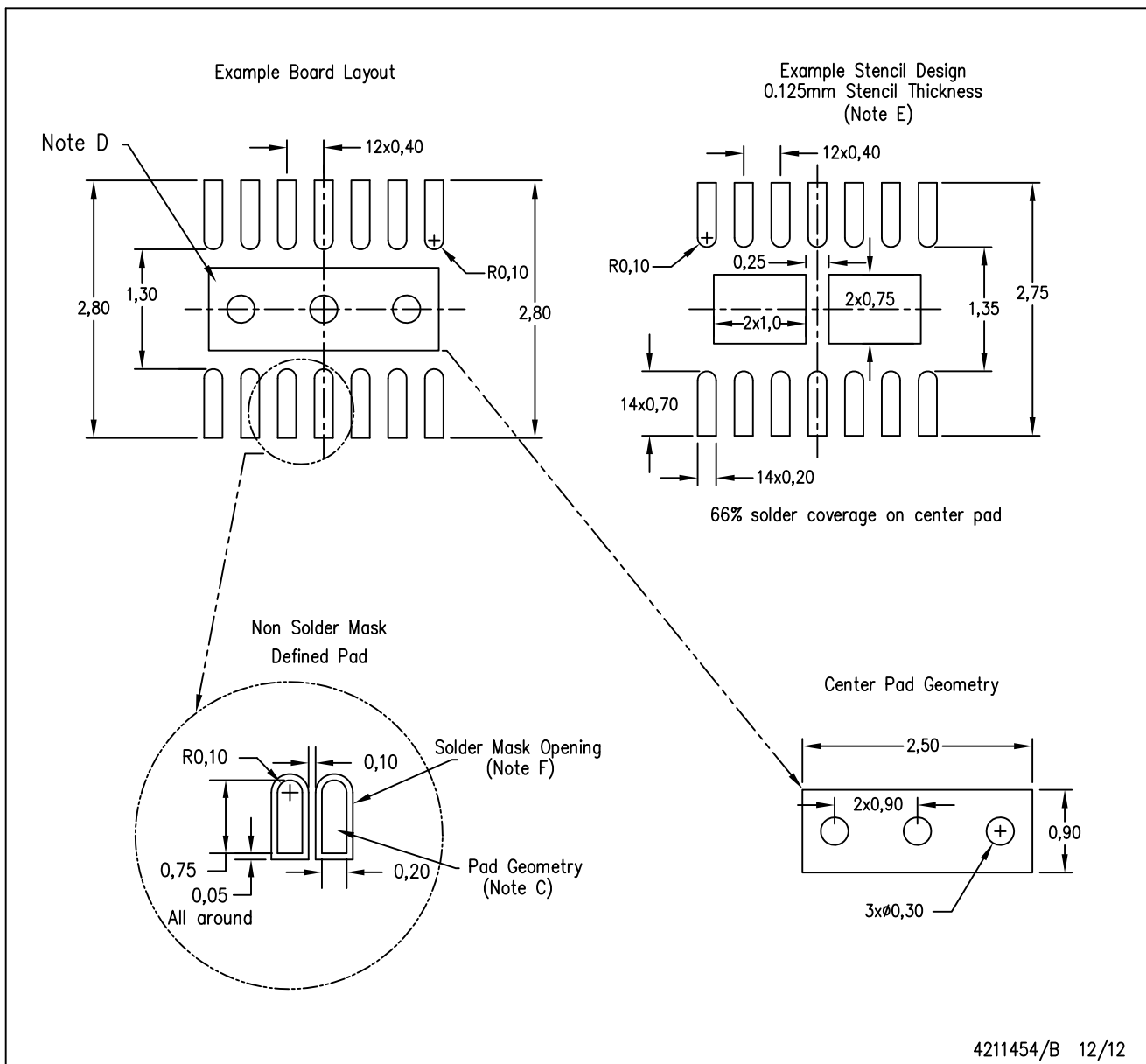

- NOTES:
- All linear dimensions are in millimeters.
 - This drawing is subject to change without notice.
 - Publication IPC-7351 is recommended for alternate designs.
 - This package is designed to be soldered to a thermal pad on the board. Refer to Application Note, QFN/SON PCB Attachment, Texas Instruments Literature No. SLUA271, and also the Product Data Sheets for specific thermal information, via requirements, and recommended board layout. These documents are available at www.ti.com <<http://www.ti.com>>.
 - Laser cutting apertures with trapezoidal walls and also rounding corners will offer better paste release. Customers should contact their board assembly site for stencil design recommendations. Refer to IPC 7525 for stencil design considerations.
 - Customers should contact their board fabrication site for minimum solder mask web tolerances between signal pads.

IMPORTANT NOTICE

Texas Instruments Incorporated and its subsidiaries (TI) reserve the right to make corrections, enhancements, improvements and other changes to its semiconductor products and services per JESD46, latest issue, and to discontinue any product or service per JESD48, latest issue. Buyers should obtain the latest relevant information before placing orders and should verify that such information is current and complete. All semiconductor products (also referred to herein as "components") are sold subject to TI's terms and conditions of sale supplied at the time of order acknowledgment.

TI warrants performance of its components to the specifications applicable at the time of sale, in accordance with the warranty in TI's terms and conditions of sale of semiconductor products. Testing and other quality control techniques are used to the extent TI deems necessary to support this warranty. Except where mandated by applicable law, testing of all parameters of each component is not necessarily performed.

TI assumes no liability for applications assistance or the design of Buyers' products. Buyers are responsible for their products and applications using TI components. To minimize the risks associated with Buyers' products and applications, Buyers should provide adequate design and operating safeguards.

TI does not warrant or represent that any license, either express or implied, is granted under any patent right, copyright, mask work right, or other intellectual property right relating to any combination, machine, or process in which TI components or services are used. Information published by TI regarding third-party products or services does not constitute a license to use such products or services or a warranty or endorsement thereof. Use of such information may require a license from a third party under the patents or other intellectual property of the third party, or a license from TI under the patents or other intellectual property of TI.

Reproduction of significant portions of TI information in TI data books or data sheets is permissible only if reproduction is without alteration and is accompanied by all associated warranties, conditions, limitations, and notices. TI is not responsible or liable for such altered documentation. Information of third parties may be subject to additional restrictions.

Resale of TI components or services with statements different from or beyond the parameters stated by TI for that component or service voids all express and any implied warranties for the associated TI component or service and is an unfair and deceptive business practice. TI is not responsible or liable for any such statements.

Buyer acknowledges and agrees that it is solely responsible for compliance with all legal, regulatory and safety-related requirements concerning its products, and any use of TI components in its applications, notwithstanding any applications-related information or support that may be provided by TI. Buyer represents and agrees that it has all the necessary expertise to create and implement safeguards which anticipate dangerous consequences of failures, monitor failures and their consequences, lessen the likelihood of failures that might cause harm and take appropriate remedial actions. Buyer will fully indemnify TI and its representatives against any damages arising out of the use of any TI components in safety-critical applications.

In some cases, TI components may be promoted specifically to facilitate safety-related applications. With such components, TI's goal is to help enable customers to design and create their own end-product solutions that meet applicable functional safety standards and requirements. Nonetheless, such components are subject to these terms.

No TI components are authorized for use in FDA Class III (or similar life-critical medical equipment) unless authorized officers of the parties have executed a special agreement specifically governing such use.

Only those TI components which TI has specifically designated as military grade or "enhanced plastic" are designed and intended for use in military/aerospace applications or environments. Buyer acknowledges and agrees that any military or aerospace use of TI components which have **not** been so designated is solely at the Buyer's risk, and that Buyer is solely responsible for compliance with all legal and regulatory requirements in connection with such use.

TI has specifically designated certain components as meeting ISO/TS16949 requirements, mainly for automotive use. In any case of use of non-designated products, TI will not be responsible for any failure to meet ISO/TS16949.

Products

Audio	www.ti.com/audio
Amplifiers	amplifier.ti.com
Data Converters	dataconverter.ti.com
DLP® Products	www.dlp.com
DSP	dsp.ti.com
Clocks and Timers	www.ti.com/clocks
Interface	interface.ti.com
Logic	logic.ti.com
Power Mgmt	power.ti.com
Microcontrollers	microcontroller.ti.com
RFID	www.ti-rfid.com
OMAP Applications Processors	www.ti.com/omap
Wireless Connectivity	www.ti.com/wirelessconnectivity

Applications

Automotive and Transportation	www.ti.com/automotive
Communications and Telecom	www.ti.com/communications
Computers and Peripherals	www.ti.com/computers
Consumer Electronics	www.ti.com/consumer-apps
Energy and Lighting	www.ti.com/energy
Industrial	www.ti.com/industrial
Medical	www.ti.com/medical
Security	www.ti.com/security
Space, Avionics and Defense	www.ti.com/space-avionics-defense
Video and Imaging	www.ti.com/video

TI E2E Community

e2e.ti.com

Данный компонент на территории Российской Федерации

Вы можете приобрести в компании MosChip.

Для оперативного оформления запроса Вам необходимо перейти по данной ссылке:

<http://moschip.ru/get-element>

Вы можете разместить у нас заказ для любого Вашего проекта, будь то серийное производство или разработка единичного прибора.

В нашем ассортименте представлены ведущие мировые производители активных и пассивных электронных компонентов.

Нашей специализацией является поставка электронной компонентной базы двойного назначения, продукции таких производителей как XILINX, Intel (ex.ALTERA), Vicor, Microchip, Texas Instruments, Analog Devices, Mini-Circuits, Amphenol, Glenair.

Сотрудничество с глобальными дистрибьюторами электронных компонентов, предоставляет возможность заказывать и получать с международных складов практически любой перечень компонентов в оптимальные для Вас сроки.

На всех этапах разработки и производства наши партнеры могут получить квалифицированную поддержку опытных инженеров.

Система менеджмента качества компании отвечает требованиям в соответствии с ГОСТ Р ИСО 9001, ГОСТ РВ 0015-002 и ЭС РД 009

Офис по работе с юридическими лицами:

105318, г.Москва, ул.Щербаковская д.3, офис 1107, 1118, ДЦ «Щербаковский»

Телефон: +7 495 668-12-70 (многоканальный)

Факс: +7 495 668-12-70 (доб.304)

E-mail: info@moschip.ru

Skype отдела продаж:

moschip.ru

moschip.ru_4

moschip.ru_6

moschip.ru_9