

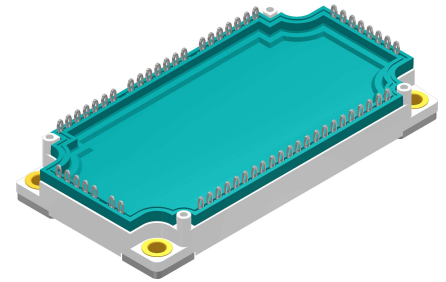
# Standard Rectifier Module

<b>3~ Rectifier</b>
$V_{RRM} = 1600\text{ V}$
$I_{DAV} = 900\text{ A}$
$I_{FSM} = 8000\text{ A}$


## 3~ Rectifier Bridge + NTC

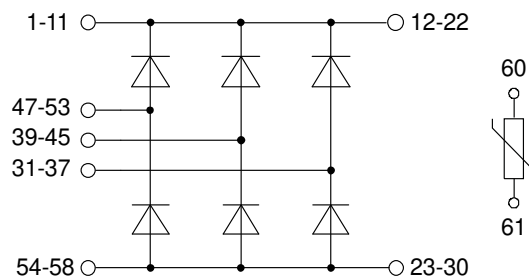
Part number

**MDMA900U1600PTEH**



Backside: isolated

 E72873



### Features / Advantages:

- Package with DCB ceramic
- Improved temperature and power cycling
- Planar passivated chips
- Very low forward voltage drop
- Very low leakage current

### Applications:

- Diode for main rectification
- For three phase bridge configurations
- Supplies for DC power equipment
- Input rectifiers for PWM inverter
- Battery DC power supplies
- Field supply for DC motors

### Package: E3-Pack

- Isolation Voltage: 3600 V~
- Industry standard outline
- RoHS compliant
- PressFit-Pins for PCB mounting
- Height: 17 mm
- Base plate: Copper internally DCB isolated
- Advanced power cycling
- Phase Change Material available

### Disclaimer Notice

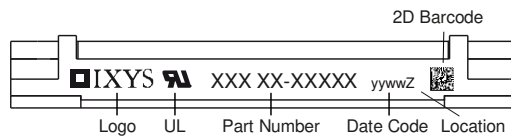
Information furnished is believed to be accurate and reliable. However, users should independently evaluate the suitability of and test each product selected for their own applications. Littelfuse products are not designed for, and may not be used in, all applications. Read complete Disclaimer Notice at [www.littelfuse.com/disclaimer-electronics](http://www.littelfuse.com/disclaimer-electronics).



Rectifier				Ratings			
Symbol	Definition	Conditions		min.	typ.	max.	Unit
$V_{RSM}$	max. non-repetitive reverse blocking voltage			$T_{VJ} = 25^{\circ}C$		1700	V
$V_{RRM}$	max. repetitive reverse blocking voltage			$T_{VJ} = 25^{\circ}C$		1600	V
$I_R$	reverse current	$V_R = 1600$ V		$T_{VJ} = 25^{\circ}C$		200	$\mu A$
		$V_R = 1600$ V		$T_{VJ} = 150^{\circ}C$		5	mA
$V_F$	forward voltage drop	$I_F = 300$ A		$T_{VJ} = 25^{\circ}C$		1.27	V
		$I_F = 900$ A				1.92	V
		$I_F = 300$ A		$T_{VJ} = 125^{\circ}C$		1.19	V
		$I_F = 900$ A				1.94	V
$I_{DAV}$	bridge output current	$T_C = 85^{\circ}C$		$T_{VJ} = 150^{\circ}C$		900	A
		rectangular	$d = \frac{1}{3}$				
$V_{FO}$	threshold voltage			$T_{VJ} = 150^{\circ}C$		0.78	V
$r_F$	slope resistance					1.3	m $\Omega$
						} for power loss calculation only	
$R_{thJC}$	thermal resistance junction to case					0.1	K/W
$R_{thCH}$	thermal resistance case to heatsink				0.05		K/W
$P_{tot}$	total power dissipation			$T_C = 25^{\circ}C$		1250	W
$I_{FSM}$	max. forward surge current	$t = 10$ ms; (50 Hz), sine		$T_{VJ} = 45^{\circ}C$		8.00	kA
		$t = 8,3$ ms; (60 Hz), sine		$V_R = 0$ V		8.64	kA
		$t = 10$ ms; (50 Hz), sine		$T_{VJ} = 150^{\circ}C$		6.80	kA
		$t = 8,3$ ms; (60 Hz), sine		$V_R = 0$ V		7.35	kA
$I^2t$	value for fusing	$t = 10$ ms; (50 Hz), sine		$T_{VJ} = 45^{\circ}C$		320.0	kA <sup>2</sup> s
		$t = 8,3$ ms; (60 Hz), sine		$V_R = 0$ V		310.5	kA <sup>2</sup> s
		$t = 10$ ms; (50 Hz), sine		$T_{VJ} = 150^{\circ}C$		231.2	kA <sup>2</sup> s
		$t = 8,3$ ms; (60 Hz), sine		$V_R = 0$ V		224.4	kA <sup>2</sup> s
$C_J$	junction capacitance	$V_R = 400$ V; $f = 1$ MHz		$T_{VJ} = 25^{\circ}C$		343	pF



Package E3-Pack		Ratings				
Symbol	Definition	Conditions	min.	typ.	max.	Unit
$I_{RMS}$	RMS current	per terminal			30	A
$T_{VJ}$	virtual junction temperature		-40		150	°C
$T_{op}$	operation temperature		-40		125	°C
$T_{stg}$	storage temperature		-40		125	°C
<b>Weight</b>				270		g
$M_D$	mounting torque		3		6	Nm
$d_{Spp/App}$	creepage distance on surface / striking distance through air	terminal to terminal	6.0			mm
$d_{Spb/Apb}$		terminal to backside	12.0			mm
$V_{ISOL}$	isolation voltage	t = 1 second t = 1 minute	3600 3000			V V
		50/60 Hz, RMS; $I_{ISOL} \leq 1$ mA				



**Part description**

- M = Module
- D = Diode
- M = Standard Rectifier
- A = (up to 1800V)
- 900 = Current Rating [A]
- U = 3- Rectifier Bridge
- 1600 = Reverse Voltage [V]
- PT = PressFit-Pin, Thermistor
- EH = E3-Pack
- = Hyphen
- PC = Phase Change Material

Ordering	Ordering Number	Marking on Product	Delivery Mode	Quantity	Code No.
Standard	MDMA900U1600PTEH	MDMA900U1600PTEH	Blister	24	515661
Alternative	MDMA900U1600PTEH-PC	MDMA900U1600PTEH	Blister	24	514468

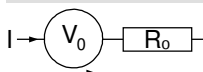
**Temperature Sensor NTC**

Symbol	Definition	Conditions	min.	typ.	max.	Unit
$R_{25}$	resistance	$T_{VJ} = 25^\circ$	4.85	5	5.15	k $\Omega$
$B_{25/50}$	temperature coefficient			3375		K

**Equivalent Circuits for Simulation**

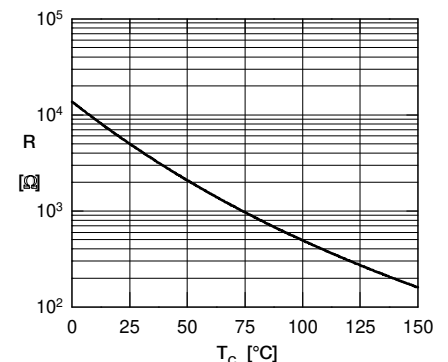
\* on die level

$T_{VJ} = 150^\circ\text{C}$



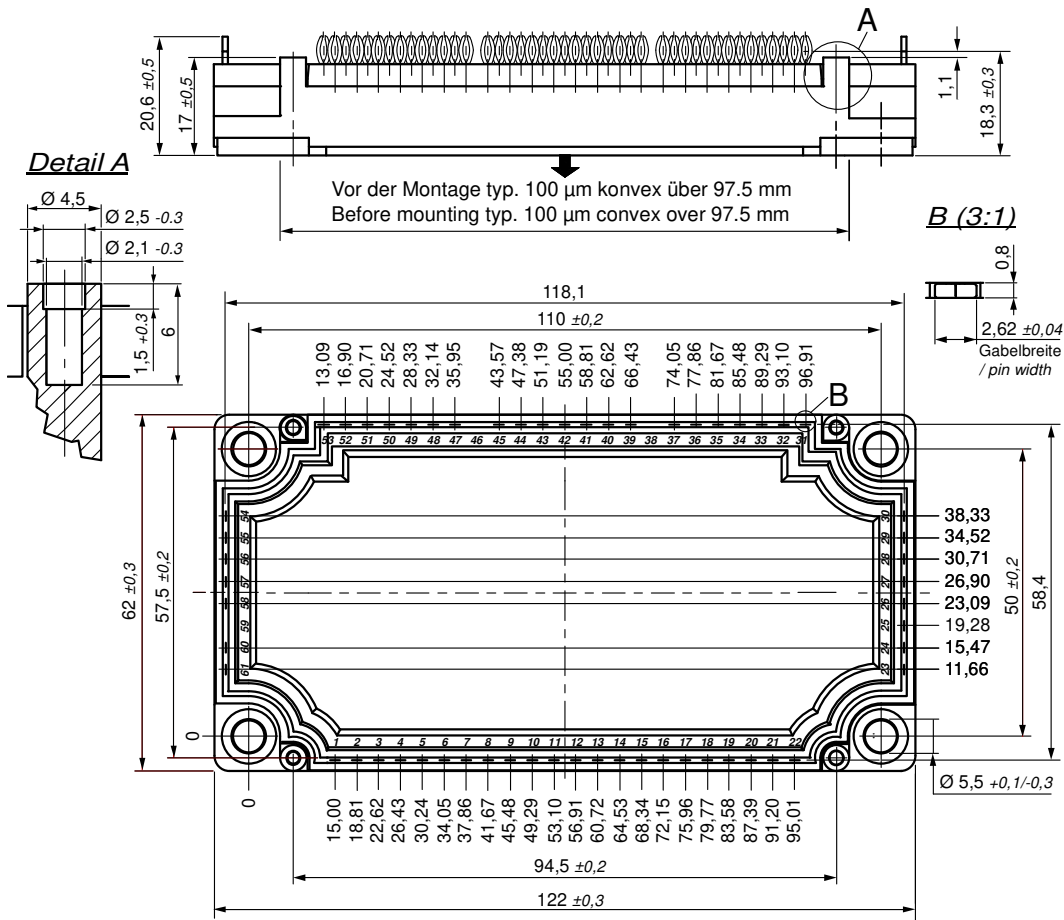
**Rectifier**

$V_{0 \max}$	threshold voltage	0.78				V
$R_{0 \max}$	slope resistance *	0.36				m $\Omega$





**Outlines E3-Pack**

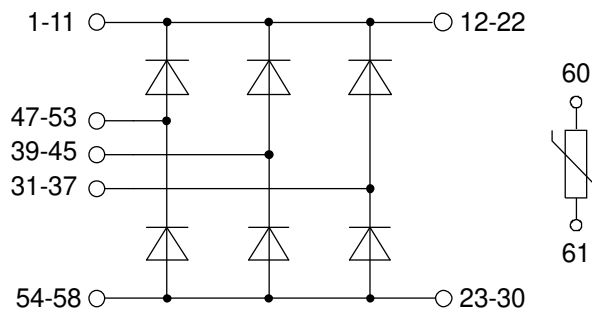


**Bemerkung / Note:**

- Nichttolerierete Maße nach / Measure without tolerances according DIN ISO 2768-T1-m
- PCB-Lochmuster / PCB hole pattern: **see pin position**
- Toleranz Pin-Position und PCB-Lochmuster / Tolerance of pin position and PCB hole pattern:  $\oplus 0.1$
- Bohrlochdurchmesser / Diameter of drill: **Ø 2.35 mm**
- Endlochdurchmesser / Diameter of plated holes: **Ø 2.14 - 2.29 mm** (Cu thickness in via typ. 50 µm)
- Beschichtung / Plating: **chem. Sn max. 15 µm**
- Einpresskraft / Insert Force: per terminal with a typ. insert speed of 7 mm/s: **typ. 90 N**
- Weitere Angaben / Further information: [www.ixys.com](http://www.ixys.com) **Application note IXAN0077**
- Montageanleitung / Mounting instruction: [www.ixys.com](http://www.ixys.com) **Application note IXAN0024**

**Detail A:** PCB-Montage / Mounting on PCB<sup>1</sup>

- Empfohlene, selbstschneidende Schraube / Recommended, self-tapping screw: **EJOT PT®** (Größe / size: **K25**)<sup>1</sup>
- Max. Schraubenlänge / Max. screw length: **PCB-Dicke / thickness + 6 mm** (max. Lochtiefe / hole depth)<sup>1</sup>
- Empfohlenes Drehmoment / Recommended mounting torque: **1.5 Nm**



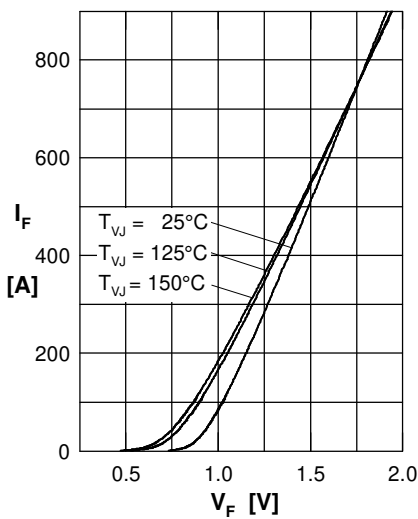
**Rectifier**


Fig. 1 Forward current versus voltage drop per diode

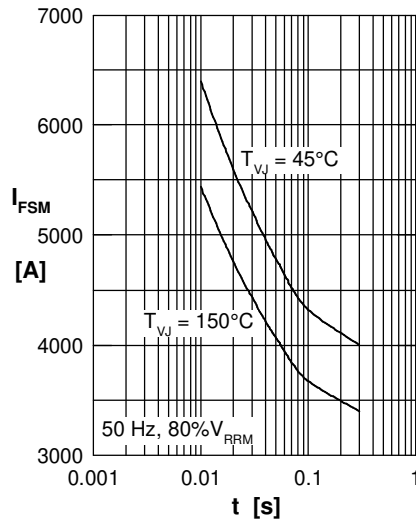


Fig. 2 Surge overload current vs. time per diode

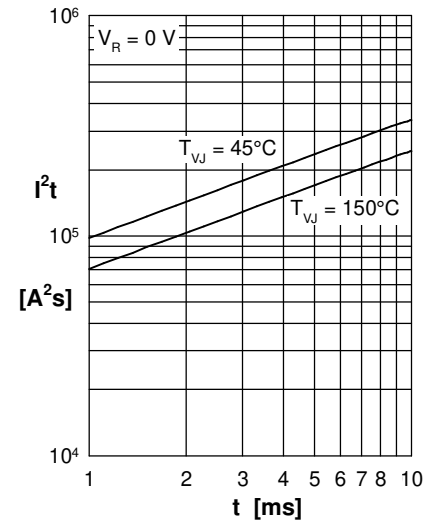
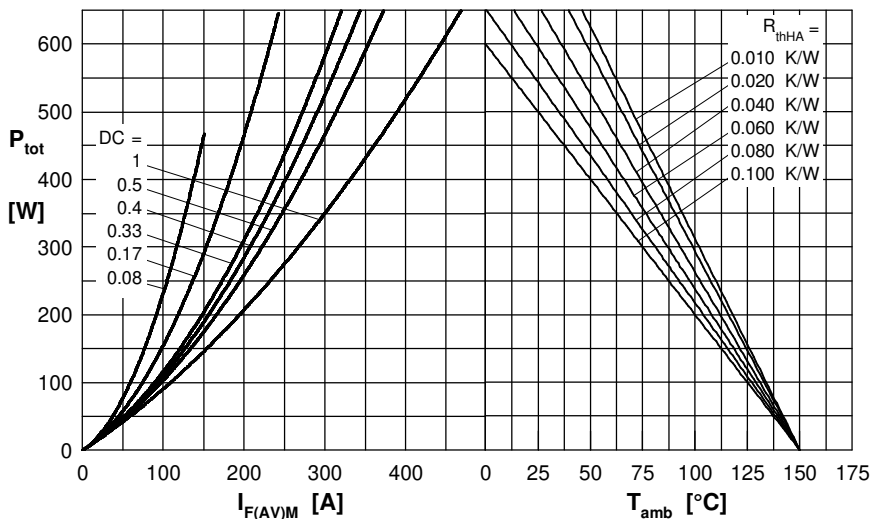

 Fig. 3  $I^2t$  versus time per diode


Fig. 4 Power dissipation vs. forward current and ambient temperature per diode

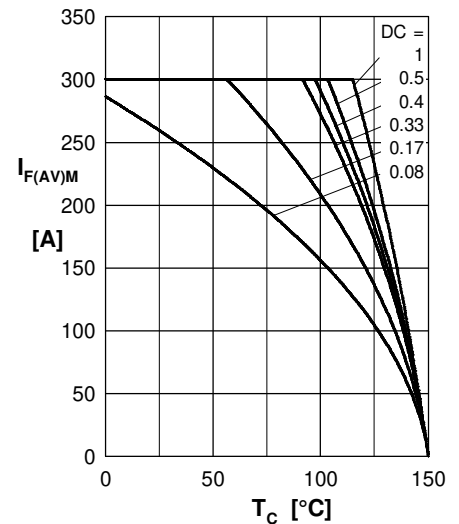


Fig. 5 Max. forward current vs. case temperature per diode

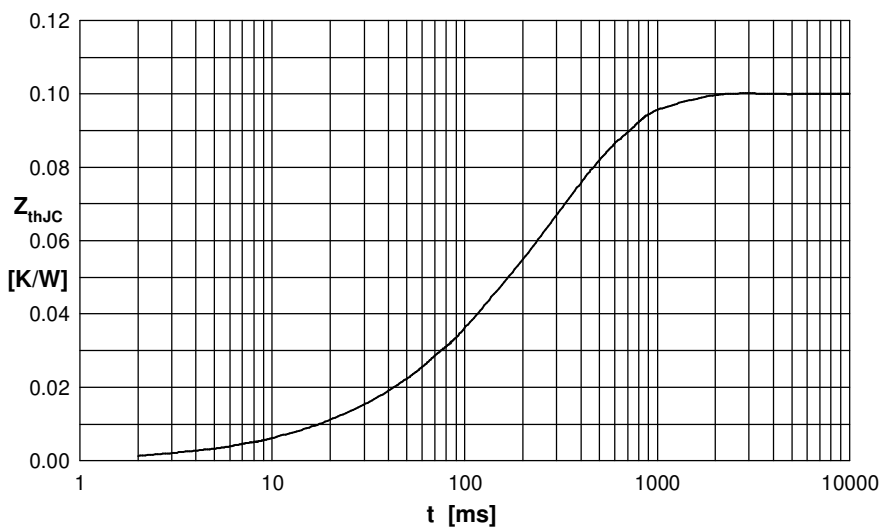


Fig. 6 Transient thermal impedance junction to case vs. time per diode

 Constants for  $Z_{thJC}$  calculation:

i	$R_{thi}$ (K/W)	$t_i$ (s)
1	0.004	0.015
2	0.014	0.080
3	0.024	0.220
4	0.058	0.380

## Данный компонент на территории Российской Федерации

### Вы можете приобрести в компании MosChip.

Для оперативного оформления запроса Вам необходимо перейти по данной ссылке:

<http://moschip.ru/get-element>

Вы можете разместить у нас заказ для любого Вашего проекта, будь то серийное производство или разработка единичного прибора.

В нашем ассортименте представлены ведущие мировые производители активных и пассивных электронных компонентов.

Нашей специализацией является поставка электронной компонентной базы двойного назначения, продукции таких производителей как XILINX, Intel (ex.ALTERA), Vicor, Microchip, Texas Instruments, Analog Devices, Mini-Circuits, Amphenol, Glenair.

Сотрудничество с глобальными дистрибьюторами электронных компонентов, предоставляет возможность заказывать и получать с международных складов практически любой перечень компонентов в оптимальные для Вас сроки.

На всех этапах разработки и производства наши партнеры могут получить квалифицированную поддержку опытных инженеров.

Система менеджмента качества компании отвечает требованиям в соответствии с ГОСТ Р ИСО 9001, ГОСТ РВ 0015-002 и ЭС РД 009

### Офис по работе с юридическими лицами:

105318, г.Москва, ул.Щербаковская д.3, офис 1107, 1118, ДЦ «Щербаковский»

Телефон: +7 495 668-12-70 (многоканальный)

Факс: +7 495 668-12-70 (доб.304)

E-mail: [info@moschip.ru](mailto:info@moschip.ru)

Skype отдела продаж:

moschip.ru

moschip.ru\_4

moschip.ru\_6

moschip.ru\_9