



# CBM100S Series Application Note

---

## AC-DC Switching Power Module

### CBM100S Series

### APPLICATION NOTE

Ver. 1.0





# CBM100S Series

## Application Note

### Content

- 1.INTRODUCTION.....3
- 2. CBM100S SERIES CONVERTER FEATURES.....3
- 3. TECHNICAL SPECIFICATIONS.....4
- 4. MAIN FEATURES AND FUNCTION.....6
  - 4.1 *Operating Temperature Range*.....6
  - 4.2 *Output Protection*.....6
- 5. EMC & SAFETY.....6
- 6. APPLICATIONS.....6
  - 6.1 *CBM100S Series Derating Curve*.....6
  - 6.2 *Full-Brick Heat Sink*.....7
  - 6.3 *Test Set-Up*.....7
  - 6.4 *Output Ripple and Noise Measurement*.....7
  - 6.5 *Efficiency VS. Load*.....8
- 7. CBM100S SERIES MECHANICAL OUTLINE DIAGRAMS.....9
- 8. PART NUMBER.....10

#### Revision History

Revision Version	Date	Change Description	Signature
1.0	31 May 2013	Original Issue	SYLin



# CBM100S Series

## Application Note

---

### 1. Introduction

This application note describes the features and functions of Cincon's CBM100S series, the switching AC-DC power module. The CBM100S series with single output AC/DC power modules are highly efficient, reliable, compact, and highly power-density. The module is fully protected against short-circuit and over-voltage conditions. Cincon's world-class automated manufacturing methods, extensive test and qualified program, ensure that the CBM100S series power module is extremely reliable.

### 2. CBM100S Series Converter Features

- Universal Input Range 90~264Vac
- Full Load with Baseplate Cooled and no fan required
- Wide Operating Temperature Range
- 17mm Ultra Low Profile Package
- Safety Meets EN60950-1
- Built-in EN55022 Class B Filter
- Active PFC Meets EN61000-3-2
- High Efficiency Up to 90% Typical
- No Load Input Power Consumption <0.5W
- Over Temperature Protection
- Over Voltage Protection
- Over Current Protection



# CBM100S Series

## Application Note

### 3. Technical Specifications

(All specifications are typical at nominal input, full load at 25°C unless otherwise noted.)

PARAMETER	NOTES and CONDITIONS	Device	Min.	Typical	Max.	Units
<b>ABSOLUTE RATINGS</b>						
Input Voltage (Continuous)			90		264	Vac
Operating Temperature	See derating curve		-20		+85	°C
Storage Temperature			-40		+100	°C
Input/Output Isolation Voltage	1 minute		4242			Vdc
<b>INPUT CHARACTERISTICS</b>						
Operating Voltage Range			100		240	Vac
Input Frequency Range			47		63	Hz
Input Current	100% Load, Vin=100Vac				1.5	A
Leakage Current	Vin=264Vac				3.5	mA
Inrush Current	Vin=240Vac, cold start at 25°C.				100	A
<b>OUTPUT CHARACTERISTICS</b>						
Output Voltage Set Point	Vin=Nominal Line, Io=Io.max, Tc=25°C	CBM100S120	11.88	12	12.12	Vdc
		CBM100S240	23.76	24	24.24	
		CBM100S280	27.72	28	28.28	
		CBM100S360	35.64	36	36.36	
		CBM100S480	47.52	48	48.48	
Operating Output Current Range		CBM100S120			8.4	A
		CBM100S240			4.2	
		CBM100S280			3.6	
		CBM100S360			2.8	
		CBM100S480			2.1	
Holdup Time	Vin=115Vac			12		mS
<b>OUTPUT VOLTAGE REGULATION</b>						
Load Regulation	20% to 60% & 60% to 100% rated load				±1.0	%
Line Regulation	Vin= High Line to Low Line				±0.5	%
Over current Protection			130	160	200	%



# CBM100S Series

## Application Note

PARAMETER	NOTES and CONDITIONS	Device	Min.	Typical	Max.	Unit
Over Voltage Protection		CBM100S120		15		Vdc
		CBM100S240		33		
		CBM100S280		33		
		CBM100S360		45		
		CBM100S480		60		
Output Ripple and Noise	1. Add a 0.1uF ceramic capacitor and a 10uF aluminum electrolytic capacitor to output . 2. The bandwidth of oscilloscope is 20MHz . 3. Ambient temperature = 25°C	CBM100S120			120	mVp-p
		CBM100S240			240	
		CBM100S280			280	
		CBM100S360			360	
		CBM100S480			480	
Load Capacitance	1. Ambient temperature = 25°C 2. Input voltage is 115Vac and 230Vac 3. Output is rated load	CBM100S120			8570	uF
		CBM100S240			4220	
		CBM100S280			3600	
		CBM100S360			2860	
		CBM100S480			2100	
Efficiency	1. Output is Rated Load 2. Ambient temperature = 25°C 3. Input voltage is 230Vac	CBM100S120		90		%
		CBM100S240		91		
		CBM100S280		91		
		CBM100S360		91		
		CBM100S480		91.5		
<b>ISOLATION CHARACTERISTICS</b>						
Input to Output	1 minute				4242	Vdc
Input to Earth(Ground)	1 minute				2121	Vdc
Output to Earth(Ground)	1 minute				500	Vdc
Isolation Resistance			100			MΩ
<b>GENERAL SPECIFICATIONS</b>						
MTBF	Vin = 115Vac, Io = 100%, Ta=25°C per MIL-HDBK-217F		100			K Hours
Switching Frequency				130		KHz
Weight				236		g



# CBM100S Series

## Application Note

### 4. Main Features and Functions

#### 4.1 Operating Temperature Range

The highly efficient design of Cincon's CBM100S series power module has resulted in their ability to operate within ambient temperature environments from -20°C to 85°C. The derating curve was drawn from the CBM100S power module.

#### 4.2 Output Protection

##### ■ Over current protection (OCP)

CBM100S Series provide fully continuous short-circuit protection. The unit will auto recover until the short circuit is removed. To provide a protection in a fault condition, the unit is equipped with internal OCP. The unit will operate normally until the fault condition is removed. The power module will go to hiccup mode if output current reaches the condition of OCP, 130% to 200% rated current.

##### ■ Over voltage protection (OVP)

All different voltage models have a fully continuous OVP. The power module will supply OVP, and the maximum voltage of OVP is 140% rated voltage. In the event of happen the OVP, the converter will shut down, and then It must recycle AC input to restart the converter.

### 5. EMC & Safety

- CB IEC 60950-1
- TUV EN 60950-1
- UL/cUL UL60950-1
- CE EN 55022 Class B,
- FCC Part 15 for a Class B, CISPR 22

### 6. Applications

#### 6.1 CBM100S Series Derating Curve

The operating temperature range of CBM100S series is -25°C to +85°C. When operating the CBM100S series, proper derating is needed. The maximum ambient temperature under any operating condition should not exceed 85°C.

The following chart is the derating curve of CBM100S series.

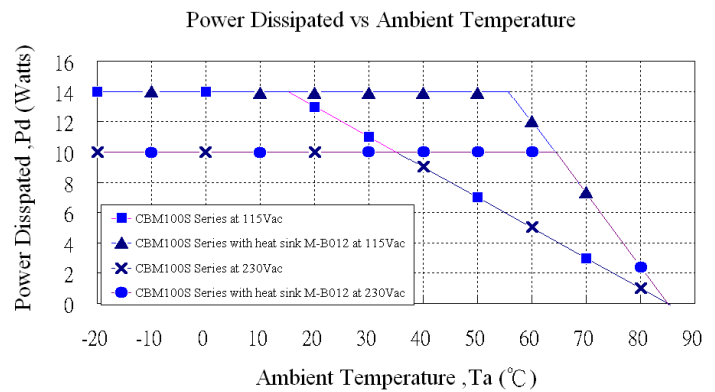

#### Example :

What is the maximum ambient temperature of CBM100S120 operating at Vin=115Vac and 50% rated load with heat sink M-B012?

	Typical Thermal Resistance (Rca)
Heat Sink M-B012 Natural Convection 20ft./min.(0.1m/s)	2.07°C/W
No Heat Sink Natural Convection 20ft./min.(0.1m/s)	5.0°C/W

#### Solution:

Given:

- Heat sink M-B012 thermal resistance 2.07°C/W
- Vin=115Vac, Vo=12Vdc
- When Io=4.2A, efficiency=88.6% (see chapter 6.5)

Determine Power dissipation (Pd):

$$Pd = P_i - P_o = P_o(1 - \eta) / \eta$$

$$= 12 \times 4.2 \times (1 - 0.886) / 0.886 = 6.4 \text{ Watts}$$

Determine maximum ambient temperature:

- Given: Pd=6.4W
- Then check above Power derating curve
- The maximum ambient temperature is about Ta=71°C

Verify:

$$\text{Maximum temperature rise } \Delta T = Pd \times Rca = 6.4 \times 2.07 = 13.248^\circ\text{C}$$

$$\text{Maximum ambient temperature } Ta = Tc - \Delta T = 85 - 13.248 = 71.752^\circ\text{C}$$

Where:

- The Rca is thermal resistance from case to ambience.
- The Ta is ambient temperature and the Tc is case temperature.



# CBM100S Series

## Application Note

### 6.2 Full-Brick Heat Sink

#### Longitudinal Fins

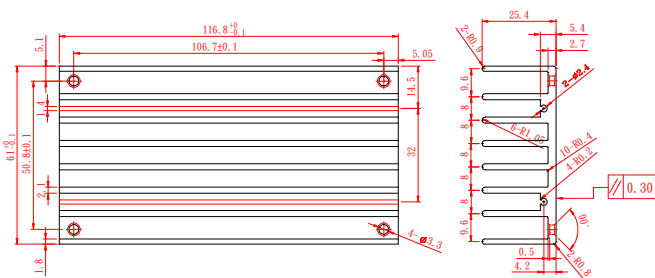

Heat Sink: 116.8\*61\*25.4(mm)(M-B012-00A) (G6620090204)  
 Thermal pad: SR60\*115.8\*0.23 (G6135013070)  
 Screw SMP+SW M3\*8L (G75A1300322)  
 Rca: 2.07°C/W (typ.), at natural convection

### 6.3 Test Set-Up

The basic test set-up to measure parameters such as efficiency and load regulation is shown in Figure 1. When testing the Cincon's CBM100S series under any transient conditions, please ensure that the transient response of the source is sufficient to power the equipment under test. We can calculate the

- Efficiency
- Load regulation and line regulation.

The value of efficiency is defined as:

$$\eta = \frac{V_o \times I_o}{P_{in}} \times 100\%$$

Where:

- Vo is output voltage,
- Io is output current,
- Pin is input power,

The value of load regulation is defined as:

$$Load_{reg.} = \frac{V_{Full-Load} - V_{60\% Full-Load}}{V_{60\% Full-Load}} \times 100\%$$

$$Load_{reg.} = \frac{V_{60\% Full-Load} - V_{20\% Full-Load}}{V_{20\% Full-Load}} \times 100\%$$

The value of line regulation is defined as:

$$Line_{reg.} = \frac{V_{HL} - V_{LL}}{V_{LL}} \times 100\%$$

Where :

- V<sub>HL</sub> is the output voltage of maximum input voltage at full load.
- V<sub>LL</sub> is the output voltage of minimum input voltage at full load.



Figure 1. CBM100S Series Test Setup

### 6.4 Output Ripple and Noise Measurement

The test which set-up for noise and ripple measurement is shown in Figure 2.

Add a 0.1 uF ceramic capacitor and a 47 uF electrolytic capacitor to output at 20 MHz Band Width.

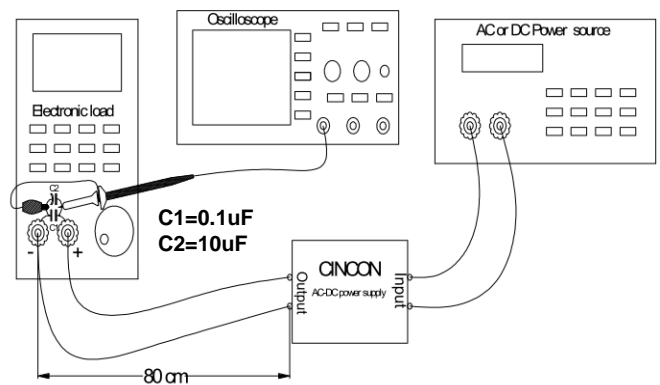

Figure 2. Output Voltage Ripple and Noise Measurement



# CBM100S Series

## Application Note

### 6.5 Efficiency VS. Load

**CBM100S120**  
Efficiency VS . Load

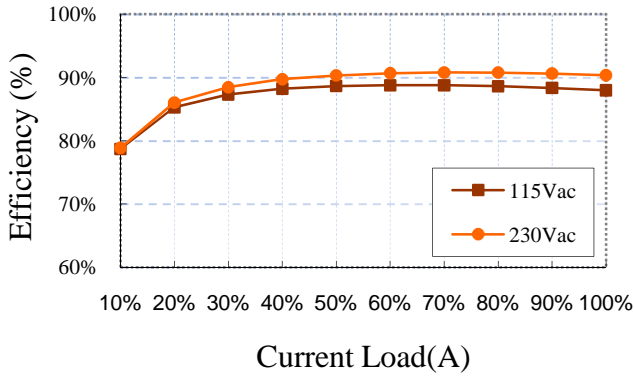

**CBM100S240**  
Efficiency VS . Load

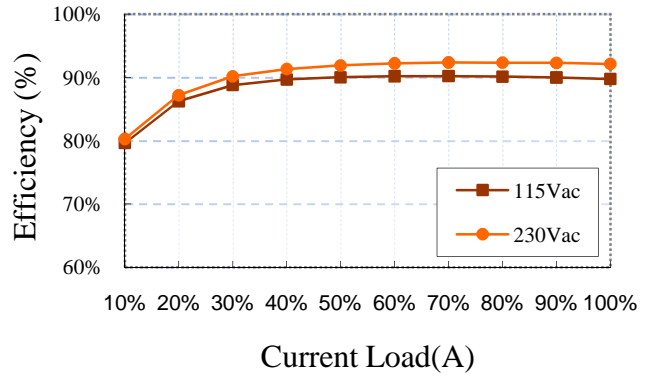

**CBM100S280**  
Efficiency VS . Load

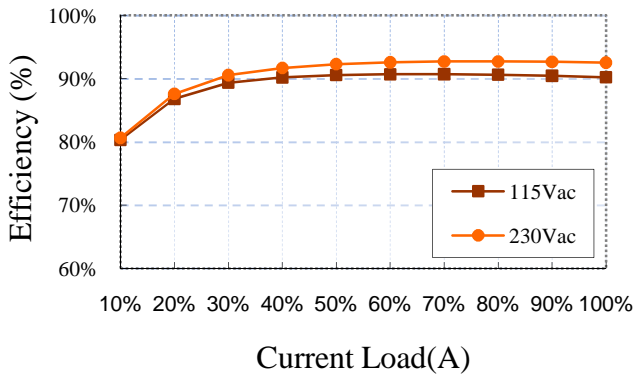

**CBM100S360**  
Efficiency VS . Load

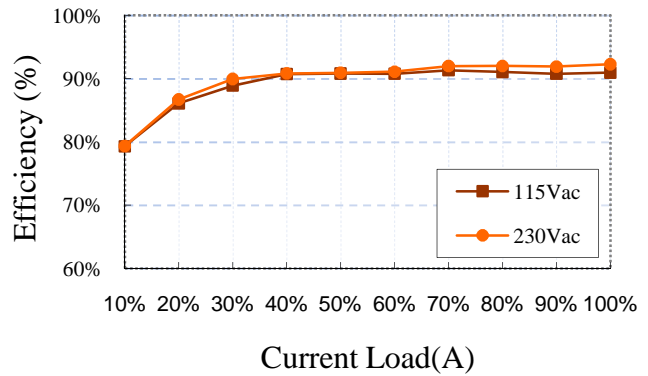

**CBM100S480**  
Efficiency VS . Load

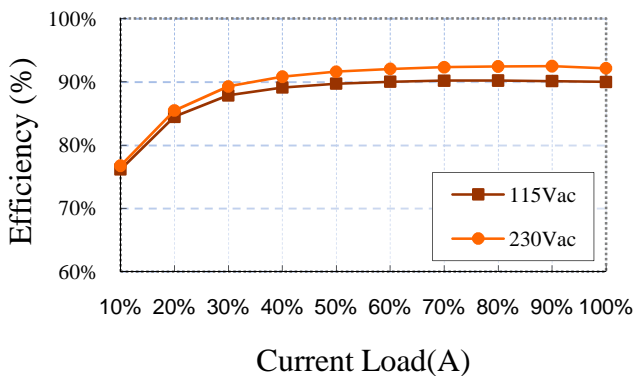





# CBM100S Series Application Note

## 7. CBM100S Series Mechanical Outline Diagrams

### Annotations :

All Dimensions in Inches[mm]

Tolerance : Inches : x.xx ±0.02, x.xxx±0.01

Millimeters:x.x=±0.5, x.xx=±0.25

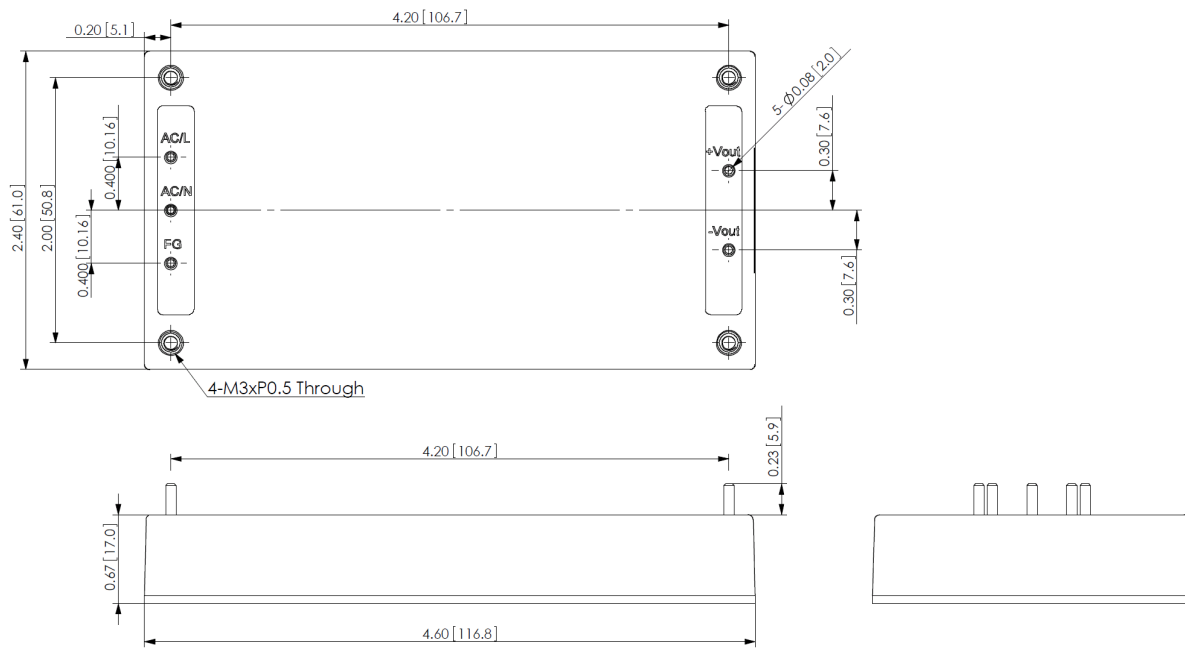

CBM100S series Mechanical Outline Diagram



# CBM100S Series

## Application Note

### 8. Part Number

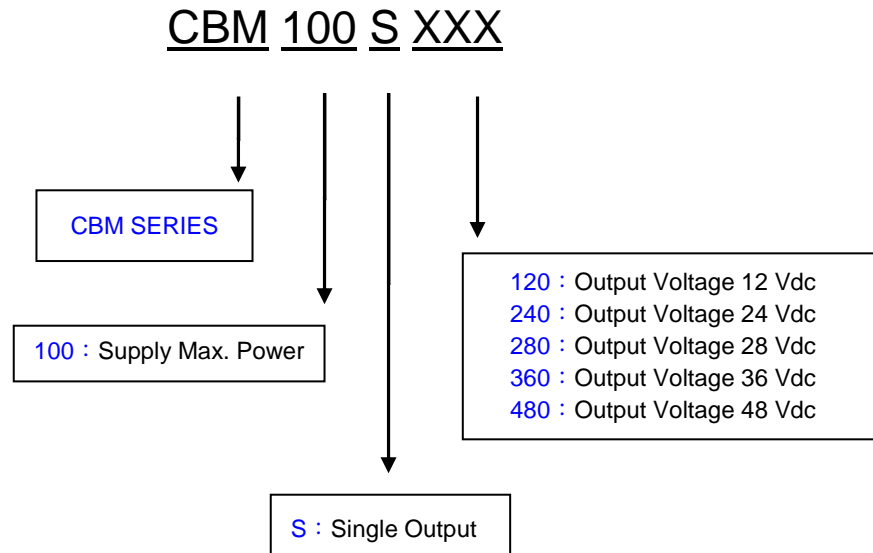

### CINCON ELECTRONICS CO., LTD.

#### Headquarters:

14F, No.306, Sec.4, Hsin Yi Rd.  
Taipei, Taiwan  
Tel: 886-2-27086210  
Fax: 886-2-27029852  
E-mail: [support@cincon.com.tw](mailto:support@cincon.com.tw)  
Web Site: <http://www.cincon.com>

#### Factory:

No. 8-1, Fu Kung Rd.  
Fu Hsing Industrial Park  
Fu Hsing Hsiang,  
Chang Hua Hsien, Taiwan  
Tel: 886-4-7690261  
Fax: 886-4-7698031

#### Cincon North America:

1655 Mesa Verde Ave. Ste 180  
Ventura, CA 93003  
Tel: 805-639-3350  
Fax: 805-639-4101  
E-mail: [info@cincon.com](mailto:info@cincon.com)

## Данный компонент на территории Российской Федерации

### Вы можете приобрести в компании MosChip.

Для оперативного оформления запроса Вам необходимо перейти по данной ссылке:

<http://moschip.ru/get-element>

Вы можете разместить у нас заказ для любого Вашего проекта, будь то серийное производство или разработка единичного прибора.

В нашем ассортименте представлены ведущие мировые производители активных и пассивных электронных компонентов.

Нашей специализацией является поставка электронной компонентной базы двойного назначения, продукции таких производителей как XILINX, Intel (ex.ALTERA), Vicor, Microchip, Texas Instruments, Analog Devices, Mini-Circuits, Amphenol, Glenair.

Сотрудничество с глобальными дистрибьюторами электронных компонентов, предоставляет возможность заказывать и получать с международных складов практически любой перечень компонентов в оптимальные для Вас сроки.

На всех этапах разработки и производства наши партнеры могут получить квалифицированную поддержку опытных инженеров.

Система менеджмента качества компании отвечает требованиям в соответствии с ГОСТ Р ИСО 9001, ГОСТ РВ 0015-002 и ЭС РД 009

### Офис по работе с юридическими лицами:

105318, г.Москва, ул.Щербаковская д.3, офис 1107, 1118, ДЦ «Щербаковский»

Телефон: +7 495 668-12-70 (многоканальный)

Факс: +7 495 668-12-70 (доб.304)

E-mail: [info@moschip.ru](mailto:info@moschip.ru)

Skype отдела продаж:

moschip.ru

moschip.ru\_4

moschip.ru\_6

moschip.ru\_9