

## Automotive single-line low capacitance Transil™, transient surge voltage suppressor (TVS) for ESD protection

Datasheet – production data



### Features

- Single-line bidirectional protection
- Breakdown voltage = 5.8 V min.
- Low capacitance = 26 pF at 0 V
- Lead-free packages
- ECOPACK®2 compliant component
- AEC-Q101 qualified

### Benefits

- Low capacitance for optimized data integrity
- Low leakage current < 60 nA
- Low PCB space consumption: 0.6 mm<sup>2</sup>
- High reliability offered by monolithic integration

### Complies with the following standards:

- IEC 61000-4-2 (exceeds level 4)
  - 30 kV (air discharge)
  - 30kV (contact discharge)
- ISO10605: C = 330 pF, R = 330 Ω
  - 30kV (air discharge)
  - 30kV (contact discharge)
- ISO 7637-3:
  - Pulse 3a: V<sub>S</sub> = -150 V
  - Pulse 3b: V<sub>S</sub> = +100 V

### Applications

Where transient overvoltage protection in ESD sensitive equipment is required, such as:

- Automotive applications
- Computers
- Printers
- Communication systems
- Cellular phone handsets and accessories
- Video equipment

### Description

The ESDALC5-1BT2Y is bidirectional single-line TVS diode designed to protect data lines or other I/O ports against ESD transients.

This device is ideal for applications where both printed circuit board space and power absorption capability are required.

Figure 1. Functional diagram

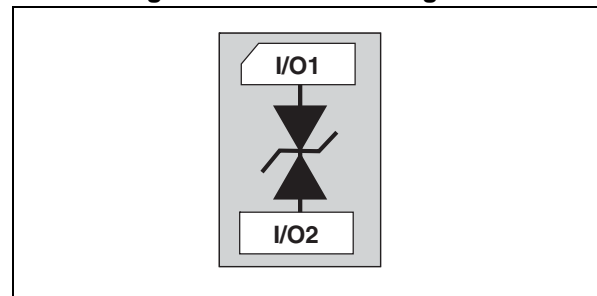

TM: Transil is a trademark of STMicroelectronics

# 1 Characteristics

**Table 1. Absolute maximum ratings ( $T_{amb} = 25\text{ }^{\circ}\text{C}$ )**

Symbol	Parameter		Value	Unit
$V_{PP}$	Peak pulse voltage	IEC 61000-4-2 contact discharge	30	kV
		IEC 61000-4-2 air discharge	30	
		ISO10605 contact discharge	30	
		ISO10605 air discharge	30	
		MIL STD 883G - Method 3015-7: class 3	25	
$P_{PP}$	Peak pulse power dissipation (8/20 $\mu\text{s}$ )	$T_j \text{ initial} = T_{amb}$	150	W
$I_{PP}$	Peak pulse current (8/20 $\mu\text{s}$ )		9	A
$T_{OP}$	Operating junction temperature range		- 50 to + 125	$^{\circ}\text{C}$
$T_{stg}$	Storage temperature range		- 65 to + 125	$^{\circ}\text{C}$
$T_L$	Maximum lead temperature for soldering during 10 s		260	$^{\circ}\text{C}$

**Figure 2. Electrical characteristics (definitions)**

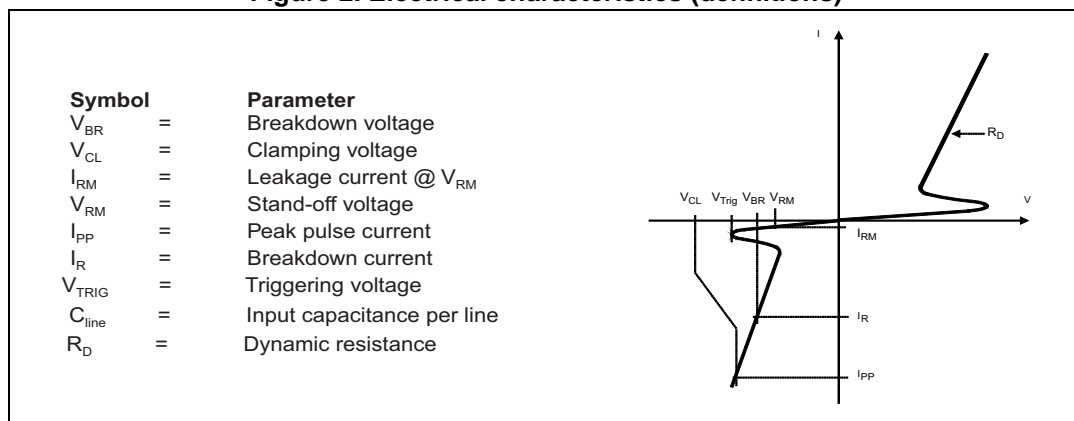

**Table 2. Electrical characteristics (values,  $T_{amb} = 25\text{ }^{\circ}\text{C}$ )**

Symbol	Test condition	Min.	Typ.	Max.	Unit
$V_{BR}$	From I/O1 to I/O2, $I_R = 1\text{ mA}$	11	13	17	V
	From I/O2 to I/O1, $I_R = 1\text{ mA}$	5.8	8	11	
$I_{RM}$	$V_{RM} = 5\text{ V}$			60	nA
$R_d$	Dynamic resistance, pulse width 100 ns				$\Omega$
	From I/O1 to I/O2		0.25		
	From I/O2 to I/O1		0.23		
$V_{CL}$	8 kV contact discharge after 30 ns IEC 61000 4-2				V
	From I/O1 to I/O2		17.5		
	From I/O2 to I/O1		12.5		
$C_{line}$	$F = 1\text{ MHz}, V_R = 0\text{ V}$		26	30	pF

Figure 3. Peak pulse power versus initial junction temperature (maximum values)

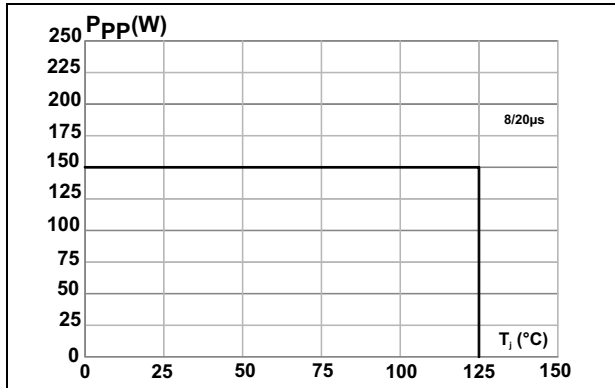

Figure 4. Junction capacitance versus reverse voltage applied (typical values)

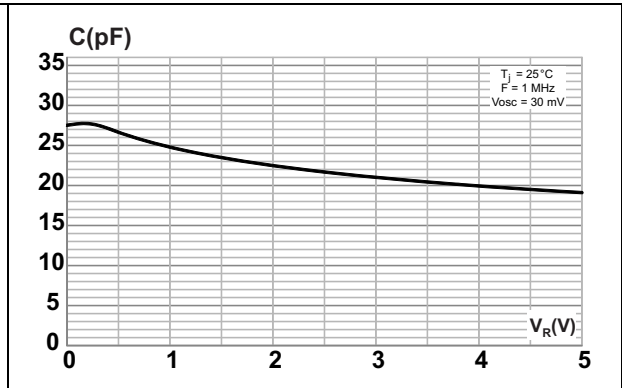

Figure 5. Peak pulse power versus exponential pulse duration (maximum values)

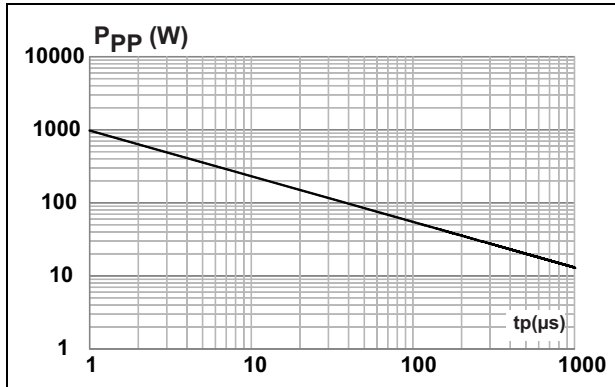

Figure 6. Clamping voltage versus peak pulse current (typical values)

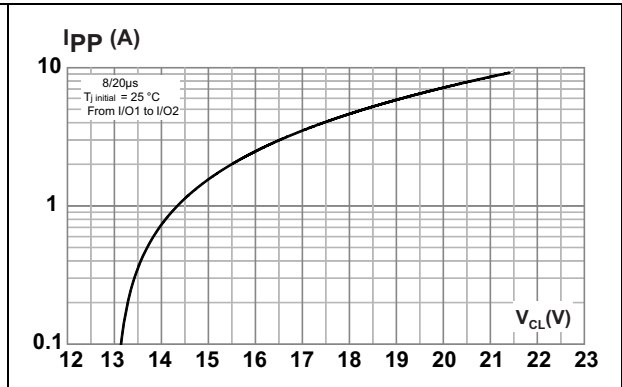

Figure 7. Clamping voltage versus peak pulse current (typical values)

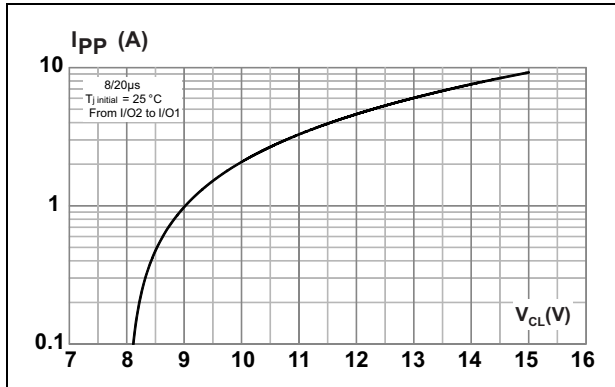

Figure 8. Leakage current versus junction temperature (typical values)

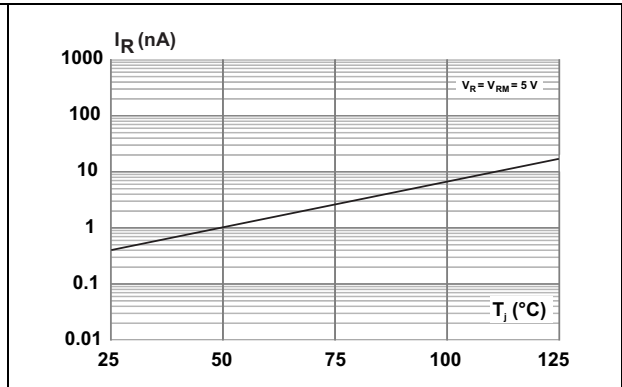

Figure 9. S21 attenuation measurement

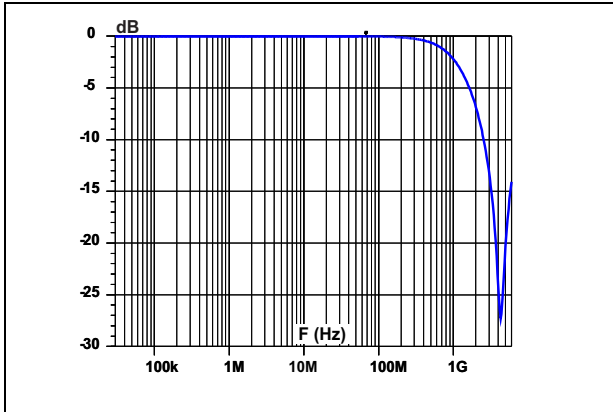

Figure 10. TLP measurements

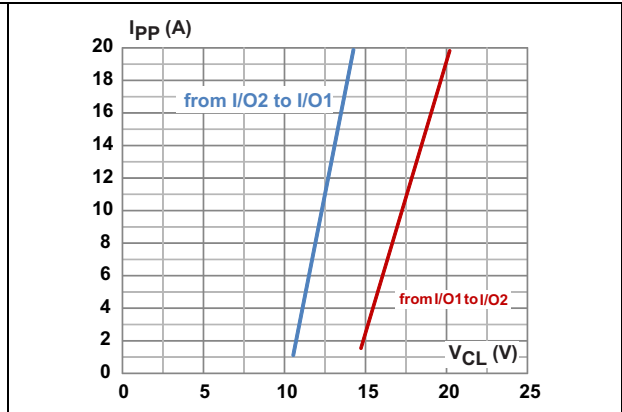

Figure 11. ESD response to ISO 10605, C = 150 pF, R = 330 Ω (+8 kV contact)

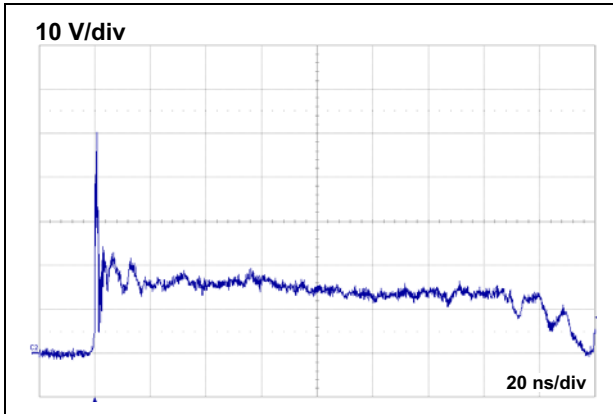

Figure 12. ESD response to ISO 10605, C = 150 pF, R = 330 Ω (-8 kV contact)

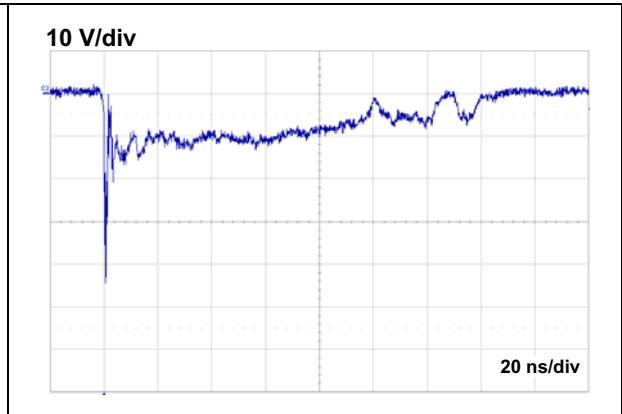

Figure 13. Response to ISO 7637-3 (pulse 3a) U<sub>S</sub> = -150 V

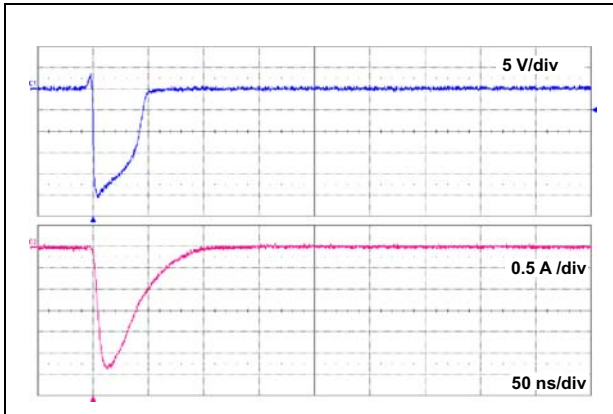
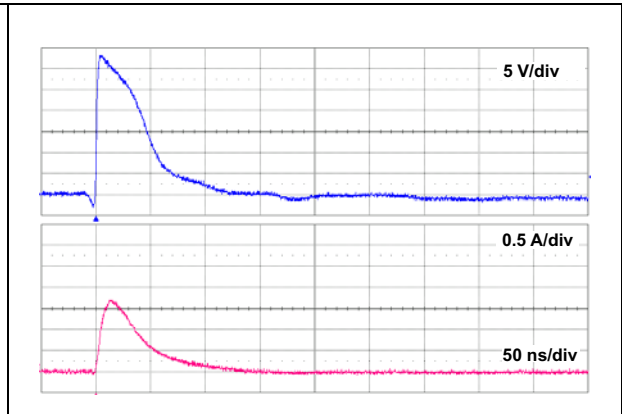

Figure 14. Response to ISO 7637-3 (pulse 3b) U<sub>S</sub> = +100 V



## 2 Package information

- Epoxy meets UL94, V0
- Lead-free packages

In order to meet environmental requirements, ST offers these devices in different grades of ECOPACK<sup>®</sup> packages, depending on their level of environmental compliance. ECOPACK<sup>®</sup> specifications, grade definitions and product status are available at: [www.st.com](http://www.st.com). ECOPACK<sup>®</sup> is an ST trademark.

Figure 15. SOD882T dimension definitions

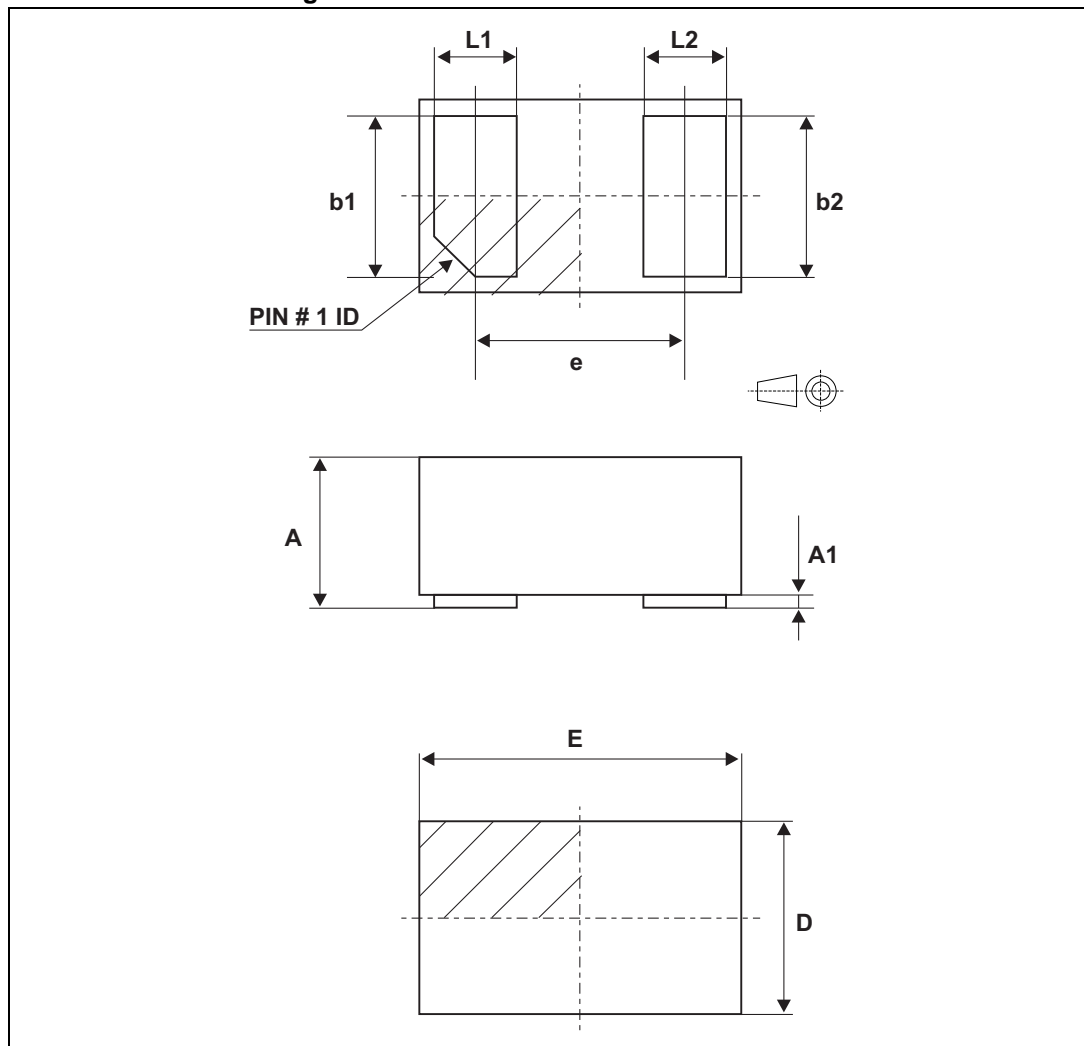

Table 3. SOD882T dimension values

Ref.	Dimensions					
	Millimeters			Inches		
	Min.	Typ.	Max.	Min.	Typ.	Max.
A	0.30		0.40	0.012		0.016
A1	0.00		0.05	0.000		0.002
b1	0.45	0.50	0.55	0.018	0.020	0.022
b2	0.45	0.50	0.55	0.018	0.020	0.022
D	0.55	0.60	0.65	0.022	0.024	0.026
E	0.95	1.00	1.05	0.037	0.039	0.041
e	0.60	0.65	0.70	0.024	0.026	0.028
L1	0.20	0.25	0.30	0.008	0.010	0.012
L2	0.20	0.25	0.30	0.008	0.010	0.012

Figure 16. SOD882T footprint in mm (inches)

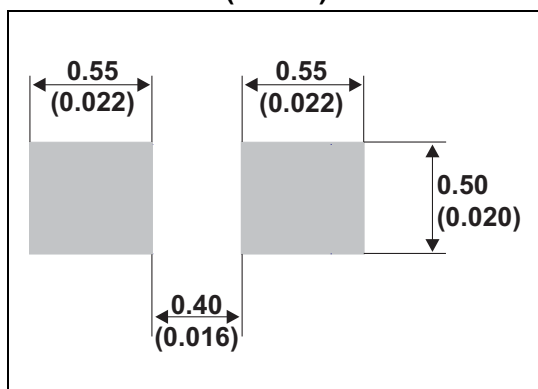
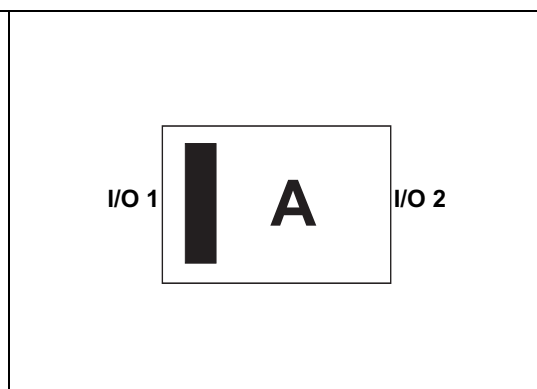
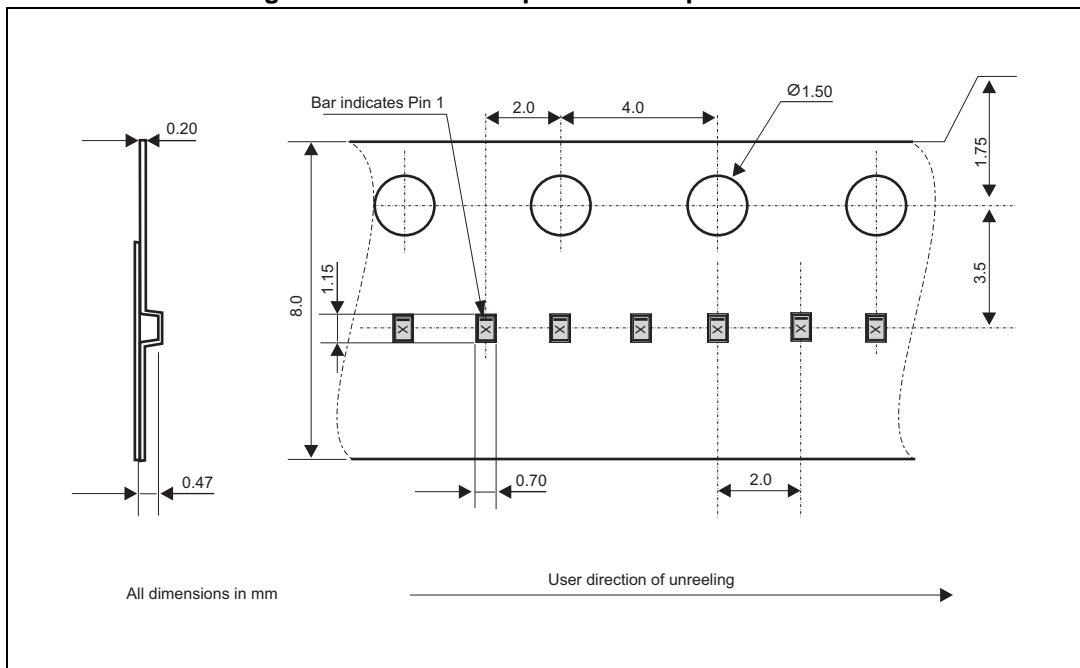

Figure 17. SOD882T marking



Note: Product marking may be rotated by multiples of 90° for assembly plant differentiation. In no case should this product marking be used to orient the component for its placement on a PCB. Only pin 1 mark is to be used for this purpose.

Figure 18. SOD882T tape and reel specifications



### 3 Recommendation on PCB assembly

#### 3.1 Stencil opening design

1. General recommendation on stencil opening design
  - a) Stencil opening dimensions: L (Length), W (Width), T (Thickness).

Figure 19. Stencil opening dimensions

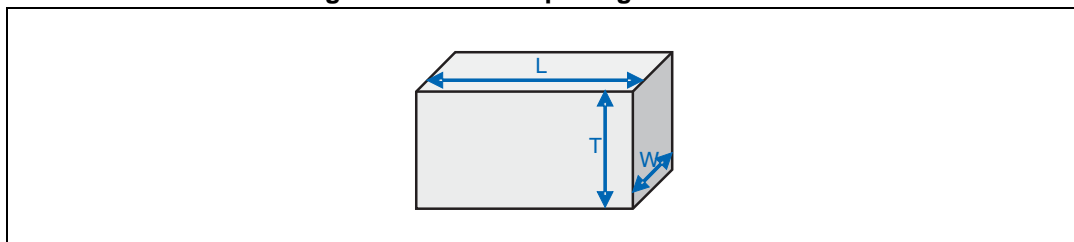

- b) General design rule
  - Stencil thickness (T) = 75 ~ 125 μm
  - Aspect Ratio =  $\frac{W}{T} \geq 1,5$
  - Aspect Area =  $\frac{L \times W}{2T(L + W)} \geq 0,66$

2. Reference design
  - a) Stencil opening thickness: 100 μm
  - b) Stencil opening for central exposed pad: Opening to footprint ratio is 50%.
  - c) Stencil opening for leads: Opening to footprint ratio is 90%.

Figure 20. Recommended stencil window position in mm (inches)

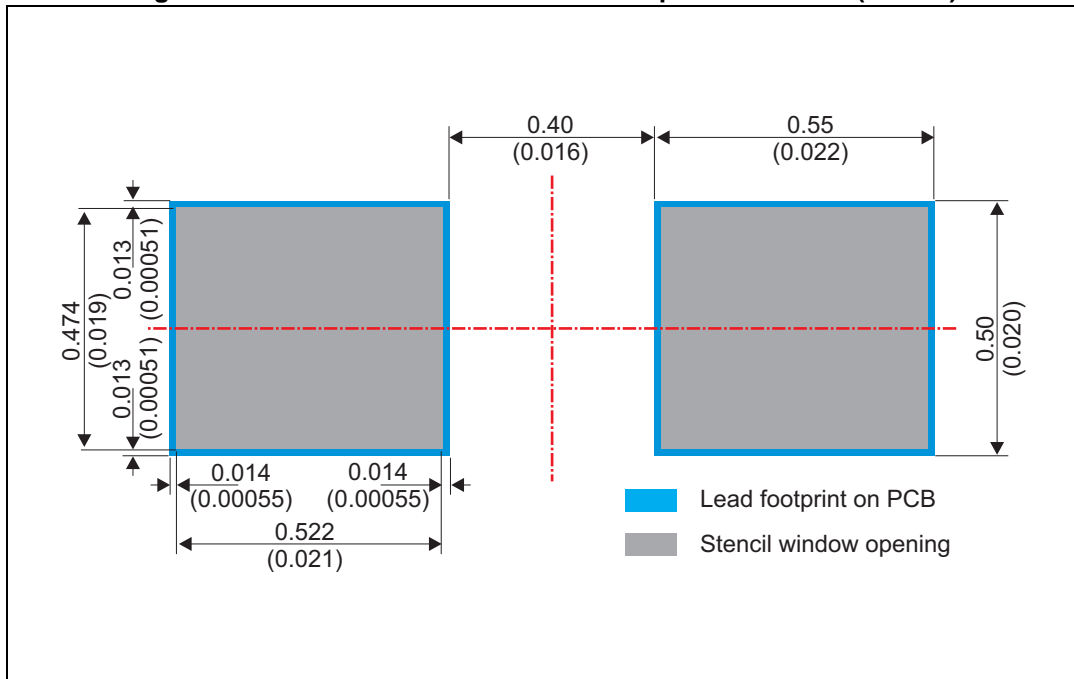



### 3.2 Solder paste

1. Halide-free flux qualification ROL0 according to ANSI/J-STD-004.
2. "No clean" solder paste is recommended.
3. Offers a high tack force to resist component movement during high speed.
4. Solder paste with fine particles: powder particle size is 20-45  $\mu\text{m}$ .

### 3.3 Placement

1. Manual positioning is not recommended.
2. It is recommended to use the lead recognition capabilities of the placement system, not the outline centering.
3. Standard tolerance of  $\pm 0.05$  mm is recommended.
4. 3.5 N placement force is recommended. Too much placement force can lead to squeezed out solder paste and cause solder joints to short. Too low placement force can lead to insufficient contact between package and solder paste that could cause open solder joints or badly centered packages.
5. To improve the package placement accuracy, a bottom side optical control should be performed with a high resolution tool.
6. For assembly, a perfect supporting of the PCB (all the more on flexible PCB) is recommended during solder paste printing, pick and place and reflow soldering by using optimized tools.

### 3.4 PCB design preference

1. To control the solder paste amount, the closed via is recommended instead of open vias.
2. The position of tracks and open vias in the solder area should be well balanced. The symmetrical layout is recommended, in case any tilt phenomena caused by asymmetrical solder paste amount due to the solder flow away.

### 3.5 Reflow profile

Figure 21. ST ECOPACK® recommended soldering reflow profile for PCB mounting

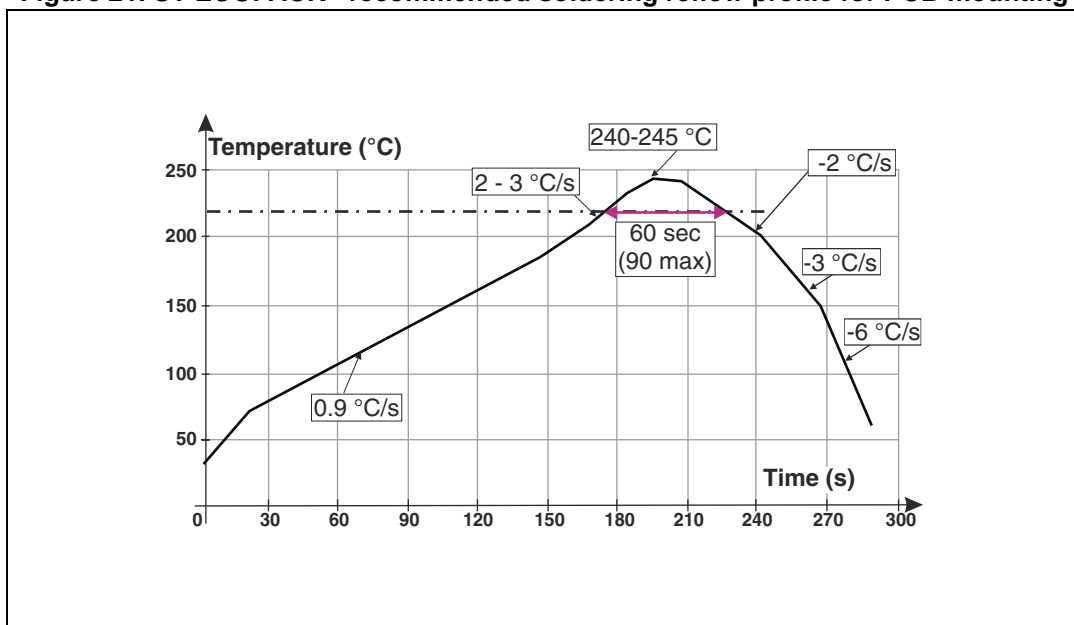

Note: Minimize air convection currents in the reflow oven to avoid component movement.

## 4 Ordering information

Figure 22. Ordering information scheme

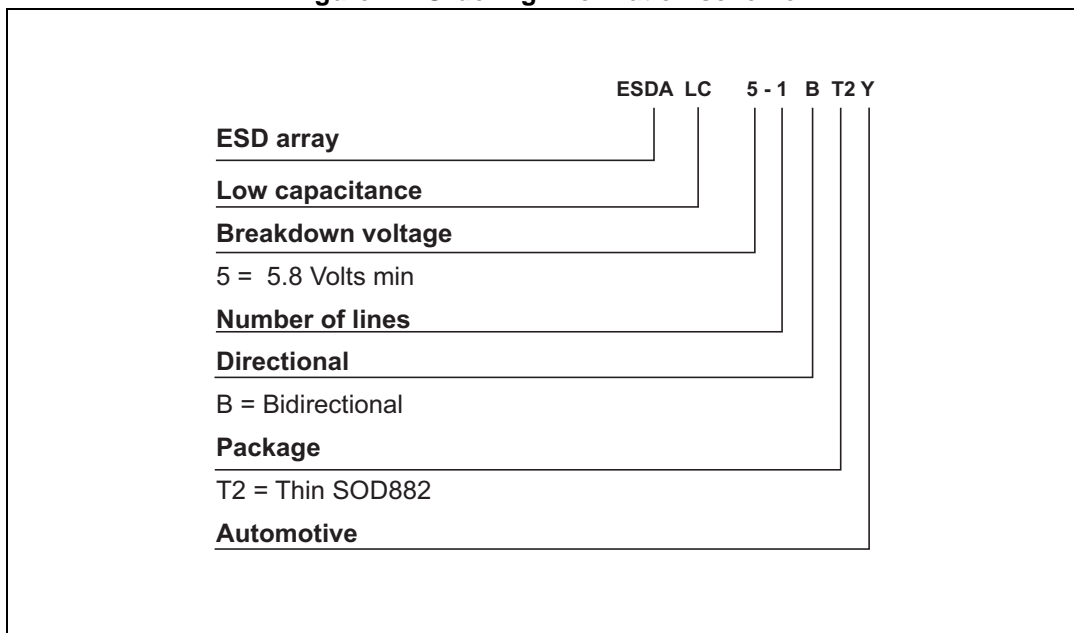

Table 4. Ordering information

Order code	Marking <sup>(1)</sup>	Package	Weight	Base qty	Delivery mode
ESDALC5-1BT2Y	A	SOD882T	0.80 mg	12000	Tape and reel

1. The marking can be rotated by multiples of 90° to differentiate assembly location

## 5 Revision history

Table 5. Document revision history

Date	Revision	Changes
03-Feb-2014	1	Initial release.

**Please Read Carefully:**

Information in this document is provided solely in connection with ST products. STMicroelectronics NV and its subsidiaries ("ST") reserve the right to make changes, corrections, modifications or improvements, to this document, and the products and services described herein at any time, without notice.

All ST products are sold pursuant to ST's terms and conditions of sale.

Purchasers are solely responsible for the choice, selection and use of the ST products and services described herein, and ST assumes no liability whatsoever relating to the choice, selection or use of the ST products and services described herein.

No license, express or implied, by estoppel or otherwise, to any intellectual property rights is granted under this document. If any part of this document refers to any third party products or services it shall not be deemed a license grant by ST for the use of such third party products or services, or any intellectual property contained therein or considered as a warranty covering the use in any manner whatsoever of such third party products or services or any intellectual property contained therein.

**UNLESS OTHERWISE SET FORTH IN ST'S TERMS AND CONDITIONS OF SALE ST DISCLAIMS ANY EXPRESS OR IMPLIED WARRANTY WITH RESPECT TO THE USE AND/OR SALE OF ST PRODUCTS INCLUDING WITHOUT LIMITATION IMPLIED WARRANTIES OF MERCHANTABILITY, FITNESS FOR A PARTICULAR PURPOSE (AND THEIR EQUIVALENTS UNDER THE LAWS OF ANY JURISDICTION), OR INFRINGEMENT OF ANY PATENT, COPYRIGHT OR OTHER INTELLECTUAL PROPERTY RIGHT.**

**ST PRODUCTS ARE NOT DESIGNED OR AUTHORIZED FOR USE IN: (A) SAFETY CRITICAL APPLICATIONS SUCH AS LIFE SUPPORTING, ACTIVE IMPLANTED DEVICES OR SYSTEMS WITH PRODUCT FUNCTIONAL SAFETY REQUIREMENTS; (B) AERONAUTIC APPLICATIONS; (C) AUTOMOTIVE APPLICATIONS OR ENVIRONMENTS, AND/OR (D) AEROSPACE APPLICATIONS OR ENVIRONMENTS. WHERE ST PRODUCTS ARE NOT DESIGNED FOR SUCH USE, THE PURCHASER SHALL USE PRODUCTS AT PURCHASER'S SOLE RISK, EVEN IF ST HAS BEEN INFORMED IN WRITING OF SUCH USAGE, UNLESS A PRODUCT IS EXPRESSLY DESIGNATED BY ST AS BEING INTENDED FOR "AUTOMOTIVE, AUTOMOTIVE SAFETY OR MEDICAL" INDUSTRY DOMAINS ACCORDING TO ST PRODUCT DESIGN SPECIFICATIONS. PRODUCTS FORMALLY ESCC, QML OR JAN QUALIFIED ARE DEEMED SUITABLE FOR USE IN AEROSPACE BY THE CORRESPONDING GOVERNMENTAL AGENCY.**

Resale of ST products with provisions different from the statements and/or technical features set forth in this document shall immediately void any warranty granted by ST for the ST product or service described herein and shall not create or extend in any manner whatsoever, any liability of ST.

ST and the ST logo are trademarks or registered trademarks of ST in various countries.

Information in this document supersedes and replaces all information previously supplied.

The ST logo is a registered trademark of STMicroelectronics. All other names are the property of their respective owners.

© 2014 STMicroelectronics - All rights reserved

STMicroelectronics group of companies

Australia - Belgium - Brazil - Canada - China - Czech Republic - Finland - France - Germany - Hong Kong - India - Israel - Italy - Japan - Malaysia - Malta - Morocco - Philippines - Singapore - Spain - Sweden - Switzerland - United Kingdom - United States of America

[www.st.com](http://www.st.com)

## Данный компонент на территории Российской Федерации

### Вы можете приобрести в компании MosChip.

Для оперативного оформления запроса Вам необходимо перейти по данной ссылке:

<http://moschip.ru/get-element>

Вы можете разместить у нас заказ для любого Вашего проекта, будь то серийное производство или разработка единичного прибора.

В нашем ассортименте представлены ведущие мировые производители активных и пассивных электронных компонентов.

Нашей специализацией является поставка электронной компонентной базы двойного назначения, продукции таких производителей как XILINX, Intel (ex.ALTERA), Vicor, Microchip, Texas Instruments, Analog Devices, Mini-Circuits, Amphenol, Glenair.

Сотрудничество с глобальными дистрибьюторами электронных компонентов, предоставляет возможность заказывать и получать с международных складов практически любой перечень компонентов в оптимальные для Вас сроки.

На всех этапах разработки и производства наши партнеры могут получить квалифицированную поддержку опытных инженеров.

Система менеджмента качества компании отвечает требованиям в соответствии с ГОСТ Р ИСО 9001, ГОСТ РВ 0015-002 и ЭС РД 009

### Офис по работе с юридическими лицами:

105318, г.Москва, ул.Щербаковская д.3, офис 1107, 1118, ДЦ «Щербаковский»

Телефон: +7 495 668-12-70 (многоканальный)

Факс: +7 495 668-12-70 (доб.304)

E-mail: [info@moschip.ru](mailto:info@moschip.ru)

Skype отдела продаж:

moschip.ru

moschip.ru\_4

moschip.ru\_6

moschip.ru\_9