

## Optocoupler, High Speed Phototransistor Output, 1 Mbd, 10 kV/ms CMR, Split Collector Transistor Output

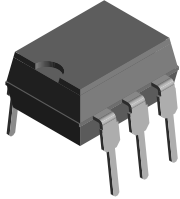

I179064

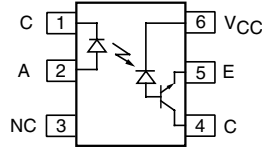

### DESCRIPTION

The SFH636 is an optocoupler with a GaAlAs infrared emitting diode, optically coupled to an integrated photo detector consisting of a photo diode and a high speed transistor in a DIP-6 plastic package. The device is functionally similar to 6N136 except there is no base connection, and the electrical foot print is different. Noise and dv/dt performance is enhanced by not bringing out the base connection.

Signals can be transmitted between two electrically separated circuits up to frequencies of 2.0 MHz. The potential difference between the circuits to be coupled should not exceed the maximum permissible reference.

### FEATURES

- High speed optocoupler without base connection
- Isolation test voltage: 5300 V<sub>RMS</sub>
- GaAlAs emitter
- Integrated detector with photo diode and transistor
- High data transmission rate: 1.0 MBit/s
- TTL compatible
- Open collector output
- CTR at I<sub>F</sub> = 16 mA, V<sub>O</sub> = 0.4 V, V<sub>CC</sub> = 4.5 V, T<sub>amb</sub> = 25 °C: ≥ 19 %
- Good CTR linearity relative to forward current
- Low coupling capacitance
- dV/dt: typ. 10 kV/μs
- Lead (Pb)-free component
- Component in accordance to RoHS 2002/95/EC and WEEE 2002/96/EC

**RoHS**  
COMPLIANT

### APPLICATIONS

- IGBT drivers
- Data communications
- Programmable controllers

### AGENCY APPROVALS

- UL1577, file no. E52744 system code H or J, double protection
- DIN EN 60747-5-2 (VDE 0884)/DIN EN 60747-5-5 pending available with option 1

### ORDER INFORMATION

PART	REMARKS
SFH636	CTR ≥ 19 %, DIP-6
SFH636-X006	CTR ≥ 19 %, DIP-6 400 mil (option 6)
SFH636-X007	CTR ≥ 19 %, SMD-6 (option 7)
SFH636-X009	CTR ≥ 19 %, SMD-6 (option 9)

#### Note

For additional information on the available options refer to option information.

### ABSOLUTE MAXIMUM RATINGS (1)

PARAMETER	TEST CONDITION	SYMBOL	VALUE	UNIT
<b>INPUT</b>				
Reverse voltage		V <sub>R</sub>	3.0	V
DC forward current		I <sub>F</sub>	25	mA
Surge forward current	t <sub>p</sub> ≤ 1.0 μs, 300 pulses/s	I <sub>FSM</sub>	1.0	A
Power dissipation		P <sub>diss</sub>	45	mW

Vishay Semiconductors Optocoupler, High Speed Phototransistor Output,  
1 Mbd,  
10 kV/ms CMR, Split Collector Transistor Output

ABSOLUTE MAXIMUM RATINGS <sup>(1)</sup>				
PARAMETER	TEST CONDITION	SYMBOL	VALUE	UNIT
<b>OUTPUT</b>				
Supply voltage		$V_S$	- 0.5 to 30	V
Output voltage		$V_O$	- 0.5 to 20	V
Output current		$I_O$	8.0	mA
Power dissipation		$P_{diss}$	100	mW
<b>COUPLER</b>				
Isolation test voltage between emitter and detector, refer to climate DIN 40046, part 2, Nov. 74		$V_{ISO}$	5300	$V_{RMS}$
Creepage distance			$\geq 7$	mm
Clearance distance			$\geq 7$	mm
Isolation resistance	$V_{IO} = 500\text{ V}, T_{amb} = 25\text{ }^\circ\text{C}$	$R_{IO}$	$\geq 10^{12}$	$\Omega$
	$V_{IO} = 500\text{ V}, T_{amb} = 100\text{ }^\circ\text{C}$	$R_{IO}$	$\geq 10^{11}$	$\Omega$
Storage temperature range		$T_{stg}$	- 55 to + 150	$^\circ\text{C}$
Ambient temperature range		$T_{amb}$	- 55 to +100	$^\circ\text{C}$
Junction temperature		$T_j$	100	$^\circ\text{C}$
Soldering temperature <sup>(2)</sup>	max. 10 s, dip soldering: distance to seating plane $\geq 1.5$ mm	$T_{sld}$	260	$^\circ\text{C}$

**Notes**

<sup>(1)</sup>  $T_{amb} = 25\text{ }^\circ\text{C}$ , unless otherwise specified.

Stresses in excess of the absolute maximum ratings can cause permanent damage to the device. Functional operation of the device is not implied at these or any other conditions in excess of those given in the operational sections of this document. Exposure to absolute maximum ratings for extended periods of the time can adversely affect reliability.

<sup>(2)</sup> Refer to reflow profile for soldering conditions for surface mounted devices (SMD). Refer to wave profile for soldering conditions for through hole devices (DIP).

ELECTRICAL CHARACTERISTICS						
PARAMETER	TEST CONDITION	SYMBOL	MIN.	TYP.	MAX.	UNIT
<b>INPUT</b>						
Forward voltage	$I_F = 16\text{ mA}$	$V_F$		1.5	1.8	V
Reverse current	$V_R = 3.0\text{ V}$	$I_R$		0.5	10	$\mu\text{A}$
Capacitance	$V_R = 0\text{ V}, f = 1.0\text{ MHz}$	$C_O$		125		pF
Thermal resistance		$R_{thja}$		700		K/W
<b>OUTPUT</b>						
Logic high supply current	$I_F = 0\text{ V}, V_O$ (open), $V_{CC} = 15\text{ V}$	$I_{CCH}$		0.01	1.0	$\mu\text{A}$
	$I_F = 0\text{ V}, V_O$ (open), $V_{CC} = 15\text{ V}$	$I_{CCH}$		0.01	2.0	$\mu\text{A}$
Output current, output high	$I_F = 0\text{ V}, V_O$ (open), $V_{CC} = 5.5\text{ V}$	$I_{OH}$		0.003	0.5	$\mu\text{A}$
	$I_F = 0\text{ V}, V_O$ (open), $V_{CC} = 15\text{ V}$	$I_{OH}$		0.01	1.0	$\mu\text{A}$
		$I_{OH}$				50
Collector emitter capacitance	$V_{CE} = 5.0\text{ V}, f = 1.0\text{ MHz}$	$C_{CE}$		3.0		pF
Thermal resistance		$R_{thja}$		300		K/W
<b>COUPLER</b>						
Coupling capacitance		$C_C$		0.6		pF
Collector emitter saturation voltage	$I_F = 16\text{ mA}, I_O = 2.4\text{ mA}, V_{CC} = 4.5\text{ V}$	$V_{OL}$		0.1	0.4	V
Supply current, logic low	$I_F = 16\text{ mA}, V_O$ open, $V_{CC} = 15\text{ V}$	$I_{DD}$		80		

**Note**

$T_{amb} = 25\text{ }^\circ\text{C}$ , unless otherwise specified.

Minimum and maximum values are testing requirements. Typical values are characteristics of the device and are the result of engineering evaluation. Typical values are for information only and are not part of the testing requirements.

Optocoupler, High Speed Phototransistor Output, Vishay Semiconductors  
1 Mbd,  
10 kV/ms CMR, Split Collector Transistor Output

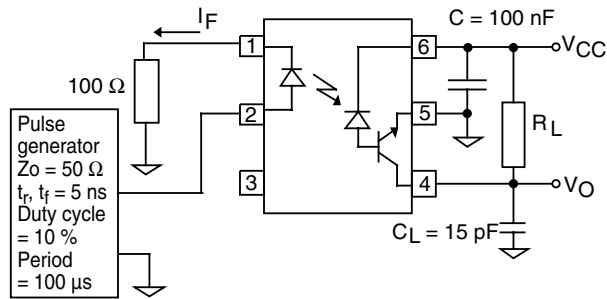

isfh636\_01

Fig. 1 - Test Setup

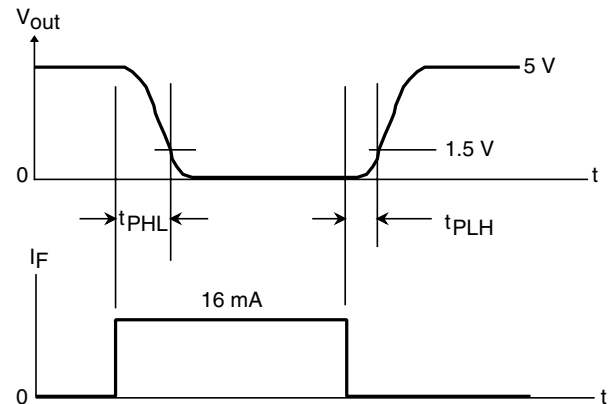

isfh636\_02

Fig. 2 - Switching Time Measurement

**CURRENT TRANSFER RATIO**

PARAMETER	TEST CONDITION	SYMBOL	MIN.	TYP.	MAX.	UNIT
Current Transfer Ratio	$I_F = 16 \text{ mA}, V_O = 0.4 \text{ V}, V_{CC} = 4.5 \text{ V}$	$I_C/I_F$	19	30		%
	$I_F = 16 \text{ mA}, V_O = 0.5 \text{ V}, V_{CC} = 4.5 \text{ V}$	$I_C/I_F$	15			%

**SWITCHING CHARACTERISTICS**

PARAMETER	TEST CONDITION	SYMBOL	MIN.	TYP.	MAX.	UNIT
Propagation delay time (high to low)	$I_F = 16 \text{ mA}, V_{CC} = 5.0 \text{ V}, R_L = 1.9 \text{ k}\Omega$	$t_{PHL}$		0.3	0.8	$\mu\text{s}$
Propagation delay time (low to low)	$I_F = 16 \text{ mA}, V_{CC} = 5.0 \text{ V}, R_L = 1.9 \text{ k}\Omega$	$t_{PLH}$		0.3	0.8	$\mu\text{s}$

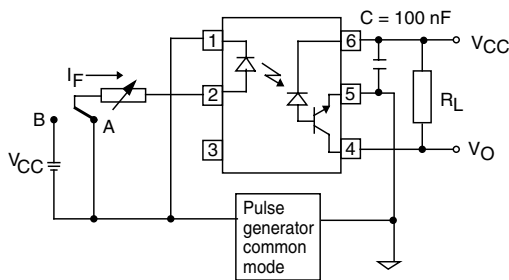

isfh636\_03

Fig. 3 - Common Mode Transient Test

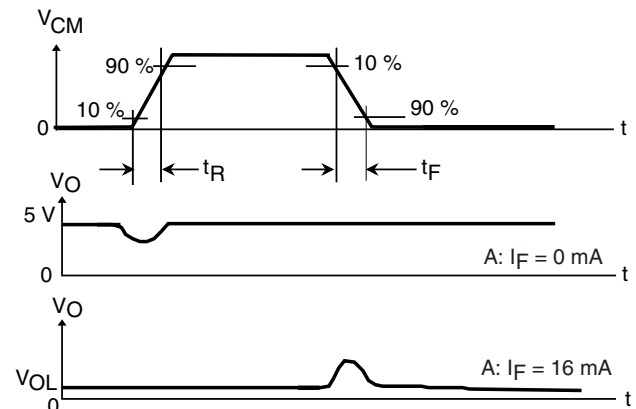

isfh636\_04

Fig. 4 - Measurement Waveform of CMR

**COMMON MODE TRANSIENT IMMUNITY**

PARAMETER	TEST CONDITION	SYMBOL	MIN.	TYP.	MAX.	UNIT
Common mode transient immunity (high)	$I_O = 0 \text{ mA}, V_{CM} = 1500 \text{ V}_{P-P}, R_L = 1.9 \text{ k}\Omega, V_{CC} = 5.0 \text{ V}$	$CM_H$		10		$\text{kV}/\mu\text{s}$
Common mode transient immunity (low)	$I_O = 16 \text{ mA}, V_{CM} = 1500 \text{ V}_{P-P}, R_L = 1.9 \text{ k}\Omega, V_{CC} = 5.0 \text{ V}$	$CM_L$		10		$\text{kV}/\mu\text{s}$

Vishay Semiconductors Optocoupler, High Speed Phototransistor Output,  
1 Mbd,  
10 kV/ms CMR, Split Collector Transistor Output

**TYPICAL CHARACTERISTICS**

$T_{amb} = 25\text{ }^{\circ}\text{C}$ , unless otherwise specified

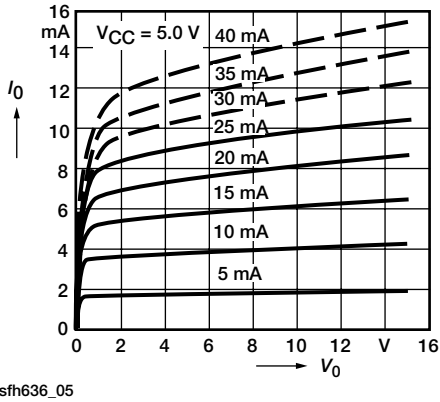

Fig. 5 - Output Characteristics-Output Current vs. Output Voltage

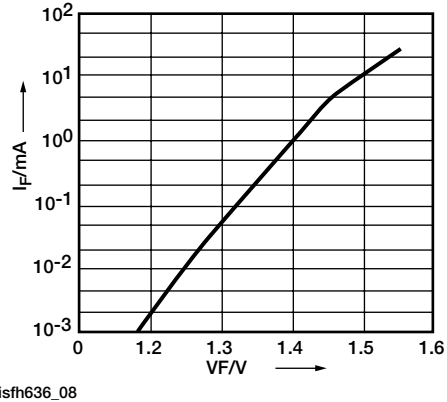

Fig. 8 - Forward Current of Emitting Diode vs. Forward Voltage

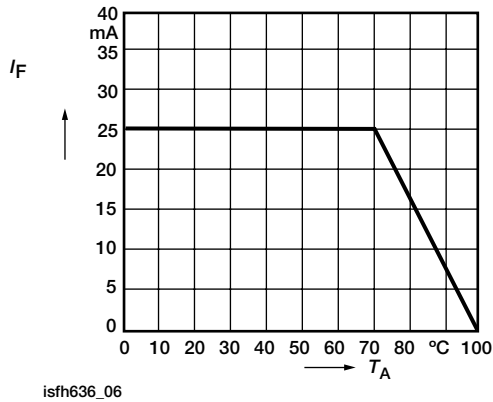

Fig. 6 - Permissible Forward Current of Emitting Diode vs. Ambient Temperature

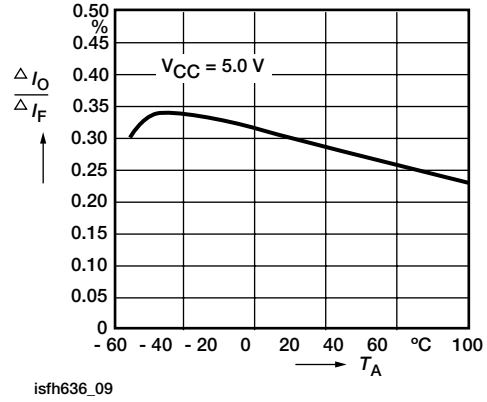

Fig. 9 - Small Signal Transfer Ratio vs. Forward Current

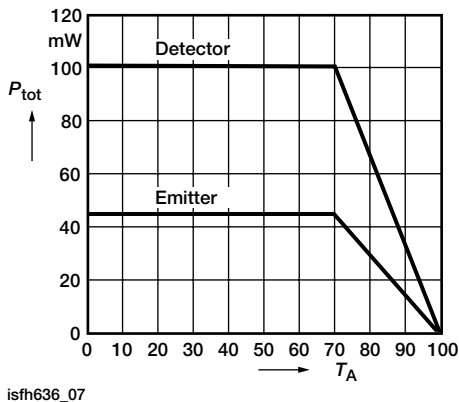

Fig. 7 - Permissible Total Power Dissipation vs. Ambient Temperature

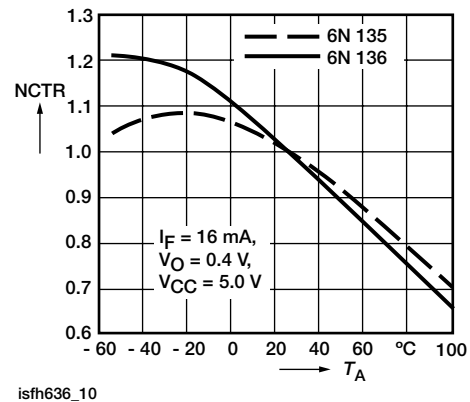
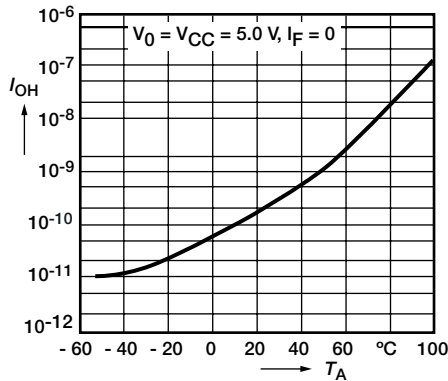

Fig. 10 - Current Transfer Ratio (Normalized) vs. Ambient Temperature

Optocoupler, High Speed Phototransistor Output, Vishay Semiconductors  
 1 Mbd,  
 10 kV/ms CMR, Split Collector Transistor Output



isfh636\_11

Fig. 11 - Output Current (High) vs. Ambient Temperature

Fig. 12 - Delay Times vs. Ambient Temperature

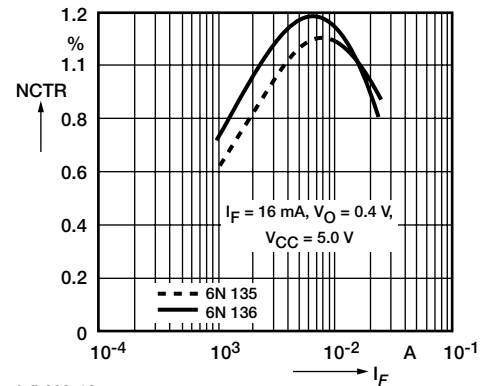

isfh636\_13

Fig. 13 - Current Transfer Ratio (Normalized) vs. Forward Current

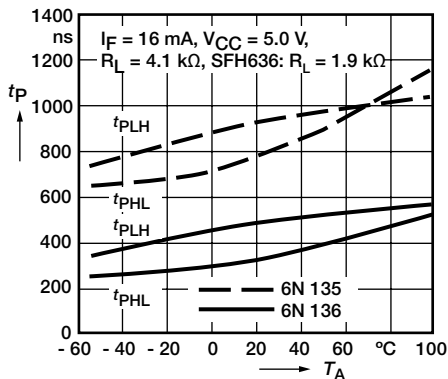

isfh636\_12

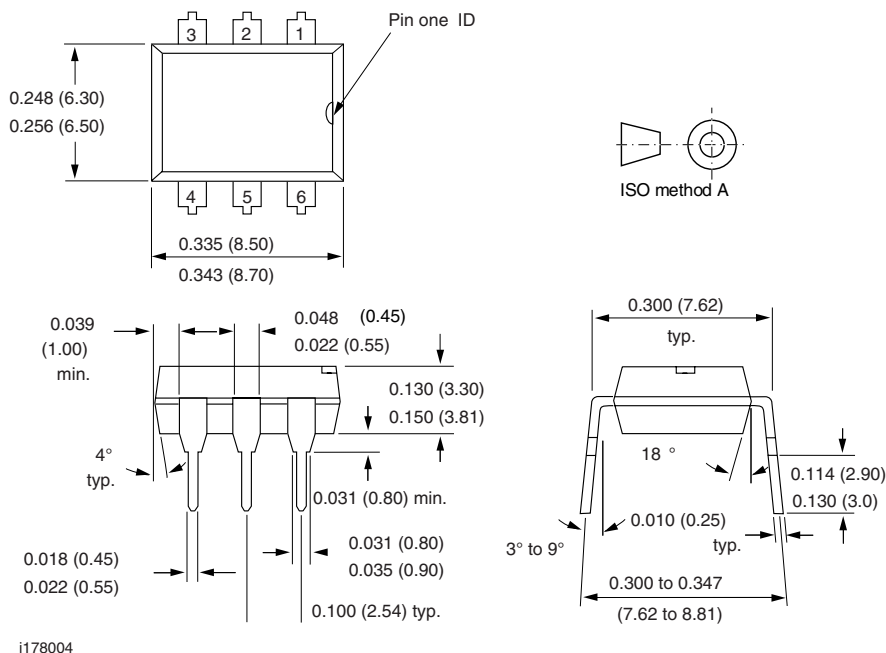
**PACKAGE DIMENSIONS** in inches (millimeters)

i178004

Vishay Semiconductors Optocoupler, High Speed Phototransistor Output,  
1 Mbd,  
10 kV/ms CMR, Split Collector Transistor Output

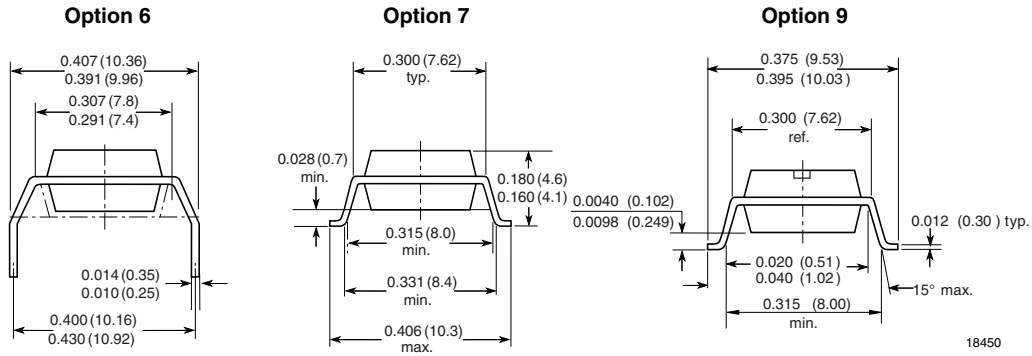



Optocoupler, High Speed Phototransistor Output, Vishay Semiconductors  
1 Mbd,  
10 kV/ms CMR, Split Collector Transistor Output

**OZONE DEPLETING SUBSTANCES POLICY STATEMENT**

It is the policy of Vishay Semiconductor GmbH to

1. Meet all present and future national and international statutory requirements.
2. Regularly and continuously improve the performance of our products, processes, distribution and operating systems with respect to their impact on the health and safety of our employees and the public, as well as their impact on the environment.

It is particular concern to control or eliminate releases of those substances into the atmosphere which are known as ozone depleting substances (ODSs).

The Montreal Protocol (1987) and its London Amendments (1990) intend to severely restrict the use of ODSs and forbid their use within the next ten years. Various national and international initiatives are pressing for an earlier ban on these substances.

Vishay Semiconductor GmbH has been able to use its policy of continuous improvements to eliminate the use of ODSs listed in the following documents.

1. Annex A, B and list of transitional substances of the Montreal Protocol and the London Amendments respectively.
2. Class I and II ozone depleting substances in the Clean Air Act Amendments of 1990 by the Environmental Protection Agency (EPA) in the USA.
3. Council Decision 88/540/EEC and 91/690/EEC Annex A, B and C (transitional substances) respectively.

Vishay Semiconductor GmbH can certify that our semiconductors are not manufactured with ozone depleting substances and do not contain such substances.

We reserve the right to make changes to improve technical design  
and may do so without further notice.

Parameters can vary in different applications. All operating parameters must be validated for each customer application by the customer. Should the buyer use Vishay Semiconductors products for any unintended or unauthorized application, the buyer shall indemnify Vishay Semiconductors against all claims, costs, damages, and expenses, arising out of, directly or indirectly, any claim of personal damage, injury or death associated with such unintended or unauthorized use.

Vishay Semiconductor GmbH, P.O.B. 3535, D-74025 Heilbronn, Germany



## Disclaimer

All product specifications and data are subject to change without notice.

Vishay Intertechnology, Inc., its affiliates, agents, and employees, and all persons acting on its or their behalf (collectively, "Vishay"), disclaim any and all liability for any errors, inaccuracies or incompleteness contained herein or in any other disclosure relating to any product.

Vishay disclaims any and all liability arising out of the use or application of any product described herein or of any information provided herein to the maximum extent permitted by law. The product specifications do not expand or otherwise modify Vishay's terms and conditions of purchase, including but not limited to the warranty expressed therein, which apply to these products.

No license, express or implied, by estoppel or otherwise, to any intellectual property rights is granted by this document or by any conduct of Vishay.

The products shown herein are not designed for use in medical, life-saving, or life-sustaining applications unless otherwise expressly indicated. Customers using or selling Vishay products not expressly indicated for use in such applications do so entirely at their own risk and agree to fully indemnify Vishay for any damages arising or resulting from such use or sale. Please contact authorized Vishay personnel to obtain written terms and conditions regarding products designed for such applications.

Product names and markings noted herein may be trademarks of their respective owners.



## Данный компонент на территории Российской Федерации

### Вы можете приобрести в компании MosChip.

Для оперативного оформления запроса Вам необходимо перейти по данной ссылке:

<http://moschip.ru/get-element>

Вы можете разместить у нас заказ для любого Вашего проекта, будь то серийное производство или разработка единичного прибора.

В нашем ассортименте представлены ведущие мировые производители активных и пассивных электронных компонентов.

Нашей специализацией является поставка электронной компонентной базы двойного назначения, продукции таких производителей как XILINX, Intel (ex.ALTERA), Vicor, Microchip, Texas Instruments, Analog Devices, Mini-Circuits, Amphenol, Glenair.

Сотрудничество с глобальными дистрибьюторами электронных компонентов, предоставляет возможность заказывать и получать с международных складов практически любой перечень компонентов в оптимальные для Вас сроки.

На всех этапах разработки и производства наши партнеры могут получить квалифицированную поддержку опытных инженеров.

Система менеджмента качества компании отвечает требованиям в соответствии с ГОСТ Р ИСО 9001, ГОСТ РВ 0015-002 и ЭС РД 009

### Офис по работе с юридическими лицами:

105318, г.Москва, ул.Щербаковская д.3, офис 1107, 1118, ДЦ «Щербаковский»

Телефон: +7 495 668-12-70 (многоканальный)

Факс: +7 495 668-12-70 (доб.304)

E-mail: [info@moschip.ru](mailto:info@moschip.ru)

Skype отдела продаж:

moschip.ru

moschip.ru\_4

moschip.ru\_6

moschip.ru\_9