

# RDC10 Linear Type

The high accuracy space saving design contributes to reduced weight and size of sets

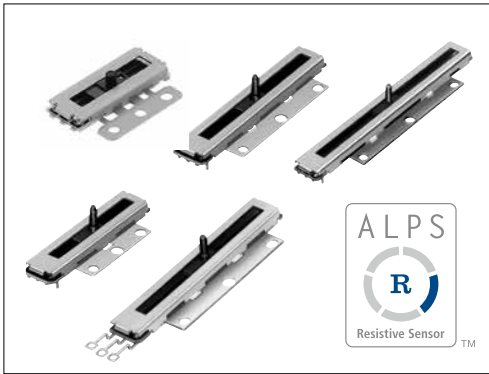

## Typical Specifications

Items	Specifications
Rated Voltage	5V DC
Operating life	50,000 cycles (RDC1010) 200,000 cycles
Total resistance	10kΩ
Operating temperature range	-30°C to +85°C

## Product Line

Travel (mm)	Linearity	Length of lever (mm)	Length of terminal (mm)	Minimum order unit (pcs.)		Model No.	Drawing No.
				Japan	Export		
10	±0.5%	1.3	0.8	980	2,940	<b>RDC1010A12</b>	1
14		4.5	2	2,400	4,800	<b>RDC1014A09</b>	2
22				2,100	4,200	<b>RDC1022A05</b>	
32				900	1,800	<b>RDC10320RB</b>	
47				1,000	2,000	<b>RDC1047A03</b>	
		4.4					

## Notes

1. RDC1014, RDC1022, RDC1032 and RDC1047 Series can be for automotive use.
2. RDC1014, RDC1022, RDC1032 and RDC1047 Series are available in different varieties to the above.  
See Product Varieties (P.463).

## Packing Specifications

### Tray

Model No.	Number of packages (pcs.)		Export package measurements (mm)
	1 case /Japan	1 case /export packing	
<b>RDC1010</b>	980	2,940	360×270×230
<b>RDC1014</b>	2,400	4,800	508×374×272
<b>RDC1022</b>	2,100	4,200	508×374×302
<b>RDC1032</b>	900	1,800	540×360×205
<b>RDC1047</b>	1,000	2,000	508×374×272

Refer to P.463 for product varieties.  
Refer to P.466 for product specifications.  
Refer to P.467 for soldering conditions.

# RDC10 Linear Type

## Dimensions

Unit:mm

No.	Photo	Style																									
1																											
2		 <table border="1" data-bbox="1125 1205 1428 1361"> <thead> <tr> <th>Dimension</th> <th>S</th> <th>A</th> <th>B</th> <th>C</th> </tr> </thead> <tbody> <tr> <td>RDC1014</td> <td>14</td> <td>19</td> <td>15</td> <td>10</td> </tr> <tr> <td>RDC1022</td> <td>22</td> <td>19</td> <td>15</td> <td>14</td> </tr> <tr> <td>RDC1032</td> <td>32</td> <td>29</td> <td>25</td> <td>19</td> </tr> <tr> <td>RDC1047</td> <td>47</td> <td>37</td> <td>33</td> <td>26.5</td> </tr> </tbody> </table> <p>Sizes in ( ) are applicable to RDC1047 only.</p>	Dimension	S	A	B	C	RDC1014	14	19	15	10	RDC1022	22	19	15	14	RDC1032	32	29	25	19	RDC1047	47	37	33	26.5
Dimension	S	A	B	C																							
RDC1014	14	19	15	10																							
RDC1022	22	19	15	14																							
RDC1032	32	29	25	19																							
RDC1047	47	37	33	26.5																							

## Circuit Diagram

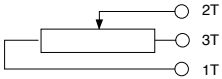
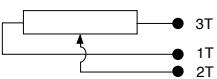
RDC1010	RDC10
	

Resistive Position Sensors

Rotary Type

Linear Type

# Linear Type / Product Varieties

In addition to the products listed, we can accommodate the follow specifications.

Applicable to **RDC1014, RDC1022, RDC1032, RDC1047** only

■ Lever Variety \* Sizes in ( ) are applicable to RDC1047 only Unit:mm

Length	4.5 (4.4)	3.7 (3.6)	3 (2.9)	2.5 (2.4)
Dimensions				

■ Terminal Variety

For printed wiring Unit:mm

Dimensions				
Length L <sub>2</sub>	1.5	2	4	5.5

For lead wiring Unit:mm

Dimensions	
------------	--

Note

Shows the specification recommended by Alps Alpine.

Type	Magnetic Rotary Type	Linear Type			
Series	<b>RDCC0</b>	<b>RDC1010</b>	<b>RDC10</b>	<b>※ RD7</b>	
Photo					
Direction of lever	Vertical			Vertical   Horizontal	
Effective electrical angle (°)	30	—	—	—	
Linearity guarantee range (°)	±15	—	—	—	
Travel	—	10mm	14mm 22mm 32mm 47mm	8mm 12mm   8mm 9mm 12mm	
Operating temperature range	0°C to +50°C	-30°C to +85°C		-40°C to +105°C	
Operating life	10,000,000 cycles	50,000 cycles	200,000 cycles	100,000 cycles	
Available for automotive use	—	—	●	●	
Life cycle (availability)					
Mechanical performance	Operating force	—	0.25N max.		
	Rotational torque	5mN·m max.	—	—	
Electrical performance	Total resistance tolerance	—	±30%		
	Linearity (%)	±2	±0.5		
	Rated voltage (V DC)	5			12
Environmental performance	Cold	-40°C 240h			-40°C 96h
	Dry heat	85°C 240h	80°C 240h	90°C 240h	105°C 96h
	Damp heat	60°C, 90 to 95%RH 240h			40°C, 90 to 95%RH 96h
Terminal style	Connector	Insertion	Lead terminal/Insertion	Insertion	
Page	460	461		464	

Resistive Position Sensors Measurement and Test Methods	466
Resistive Position Sensors Soldering Conditions	467
Resistive Position Sensors Cautions	468

**Notes**

1. ※ The RD7 series are used to detect vehicle headlight angles.
2. ● Indicates applicability to all products in the series.

## Method for Regulating the Linearity

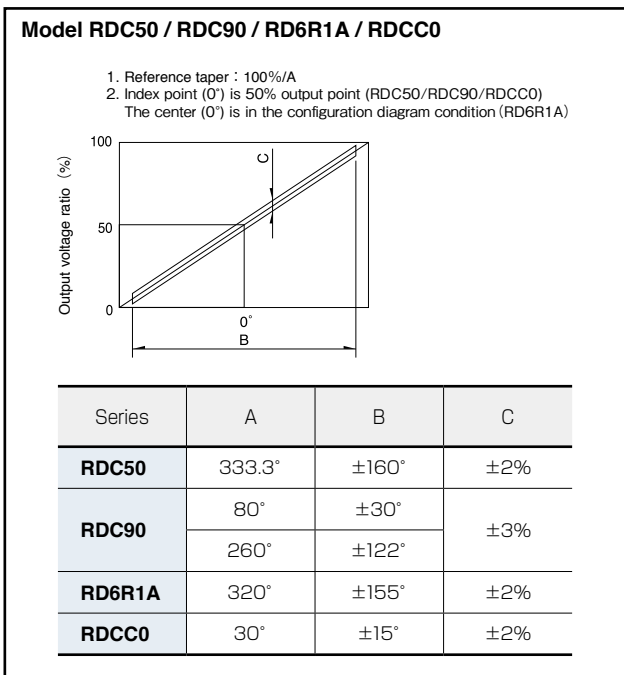
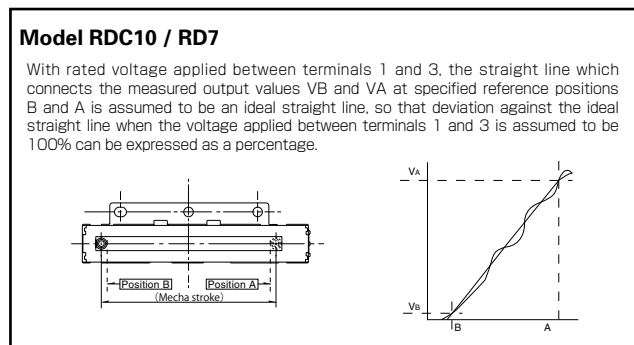
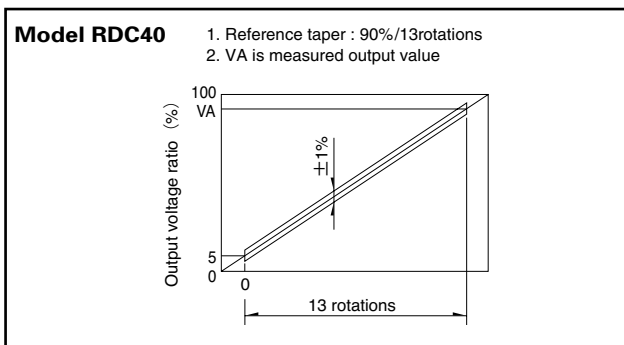

## Resistive Position Sensors / Measurement and Test Methods

### Resistive Position Sensor

#### [Total Resistance]

The total resistance, with the shaft (lever) placed at the end of terminal 1 or 3, shall be determined by measuring the resistance between the resistor terminals 1 and 3 unless otherwise specified.

#### [Rating Voltage]

The rating voltage corresponding to the rated power shall be determined by the following equation. When the resulting rated voltage exceeds the maximum operating voltage of a specific resistor, the maximum operating voltage shall be taken as the rated voltage.

$$E = \sqrt{P \cdot R}$$

**E** : Rated voltage (V)  
**P** : Rated power (W)  
**R** : Total nominal resistance (Ω)

## Reference for Manual Soldering

Series	Tip temperature	Soldering time
<b>RDC50, RDC90</b>	350±5°C	3 <sup>+1</sup> <sub>0</sub> s
<b>RDC10, RD7</b>	350°C max.	3s max.

## Reference for Dip Soldering

Series	Preheating		Dip soldering		No. of solders
	Soldering surface temperature	Heating time	Soldering temperature	Soldering time	
<b>RDC501, RDC502</b>	100 to 150°C	1minute max.	260±5°C	10±1s	1 time
<b>RD7</b>	100°C max.	1minute max.	260°C max.	5s max.	1 time

## Example of Reflow Soldering Condition

1. Cleaning sensors should not be attempted.
2. Type of solder to be used Use cream solder that contains 10 to 15 %wt flux.
3. Number of solder applications - apply solder only once
4. Recommended reflow conditions

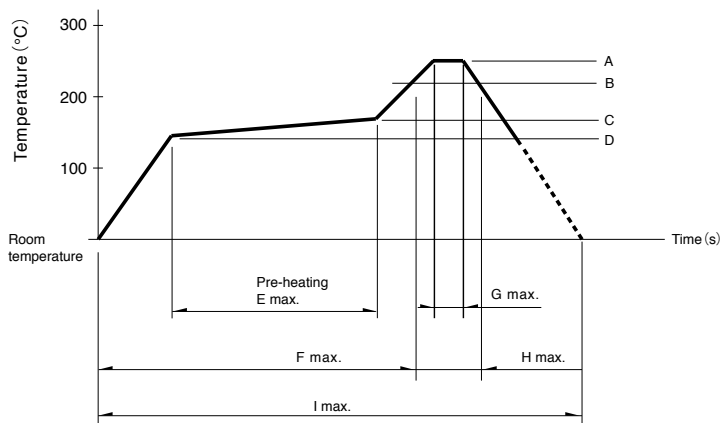

Series	A	B	C	D	E	F	G	H	I	No. of reflows
<b>RDC503 RDC506</b>	250°C	230°C	180°C	150°C	2min.	—	5s	40s	4min.	1 time
<b>RDC90</b>	255°C	230°C	—	—	—	2min.	10s	1min.	4min.	1 time

## Notes

1. When using an infrared reflow oven, solder may not always be applied as intended. Be sure to use a hot air reflow oven or a type that uses infrared rays in combination with hot air.
2. The temperatures given above are the maximum temperatures at the terminals of the sensor when employing a hot air reflow method. The temperature of the PC board and the surface temperature of the sensor may vary greatly depending on the PC board material, its size and thickness. Ensure that the surface temperature of the sensor does not rise to 250°C or greater.
3. Conditions vary to some extent depending on the type of reflow bath used. Be sure to give due consideration to this prior to use.

## Данный компонент на территории Российской Федерации

### Вы можете приобрести в компании MosChip.

Для оперативного оформления запроса Вам необходимо перейти по данной ссылке:

<http://moschip.ru/get-element>

Вы можете разместить у нас заказ для любого Вашего проекта, будь то серийное производство или разработка единичного прибора.

В нашем ассортименте представлены ведущие мировые производители активных и пассивных электронных компонентов.

Нашей специализацией является поставка электронной компонентной базы двойного назначения, продукции таких производителей как XILINX, Intel (ex.ALTERA), Vicor, Microchip, Texas Instruments, Analog Devices, Mini-Circuits, Amphenol, Glenair.

Сотрудничество с глобальными дистрибьюторами электронных компонентов, предоставляет возможность заказывать и получать с международных складов практически любой перечень компонентов в оптимальные для Вас сроки.

На всех этапах разработки и производства наши партнеры могут получить квалифицированную поддержку опытных инженеров.

Система менеджмента качества компании отвечает требованиям в соответствии с ГОСТ Р ИСО 9001, ГОСТ РВ 0015-002 и ЭС РД 009

### Офис по работе с юридическими лицами:

105318, г.Москва, ул.Щербаковская д.3, офис 1107, 1118, ДЦ «Щербаковский»

Телефон: +7 495 668-12-70 (многоканальный)

Факс: +7 495 668-12-70 (доб.304)

E-mail: [info@moschip.ru](mailto:info@moschip.ru)

Skype отдела продаж:

moschip.ru

moschip.ru\_4

moschip.ru\_6

moschip.ru\_9