

Lucida Antenna for LTE applications

Part No. SR4L002

lamiiANT[®]

Product Specification

1. Features

- Antenna for 4G LTE applications including MIMO systems.
- LTE 700, GSM850, GSM900, DCS1800, PCS1900, WCDMA2100, LTE B7 (2500-2690 MHz), LTE B40 (2300 – 2400 MHz).
- Maintains high performance on device: DFI (Designed For Integration)
- Smallest internal LTE antenna including clearance area.
- Low profile innovative design.
- SMD mounting
- Supplied on Tape and Reel

2. Description

Lucida uses a ground plane on the host PCB to radiate effectively. The antenna itself requires a clearance underneath. An external matching circuit is used to optimise the antenna within a device to the required bands. Ideal for 4G single and MIMO antenna systems.

3. Applications

- 4G MiFi routers
- Femto / Pico base stations
- Portable Devices
- Remote monitoring
- Network Devices
- Wearable devices



4. Part Number

Lucida: SR4L002



5. General Data

Product name	Lucida
Part Number	SR4L002
Frequency	698 – 798 MHz 824 – 960MHz 1710 – 2170 MHz 2300 – 2400 MHz 2500 – 2690 MHz
Polarization	Linear
Operating temperature	-40°C to125°C
Impedance with matching	50 Ω
Weight	2.0 g
Antenna type	SMD
Dimensions	35.0 x 8.5 x 3.2 (mm)

6. RF Characteristics

	698 – 798 MHz	824 – 960 MHz
Peak gain	0.50dBi	1.00dBi
Average gain (Linear)	-1.50dBi	-1.5dBi
Average efficiency	>45%	>60%
Maximum return loss	-6dB	-6dB
Maximum VSWR	3.2:1	2.8:1

	1710 - 2170 MHz	2300 – 2400 MHz
Peak gain	2.50dBi	1.60dBi
Average gain (Linear)	-1.50dBi	-2.0dBi
Average efficiency	>65%	>50%
Maximum return loss	-6dB	-10dB
Maximum VSWR	3.1:1	1.7:1

	2500 – 2690 MHz
Peak gain	2.50dBi
Average gain (Linear)	-2.00dBi
Average efficiency	>50%
Maximum return loss	-5dB
Maximum VSWR	3.4:1

All data measured on Antenova's evaluation PCB
Part No. SR4L002-U1

7. RF Performance

7.1 Return Loss

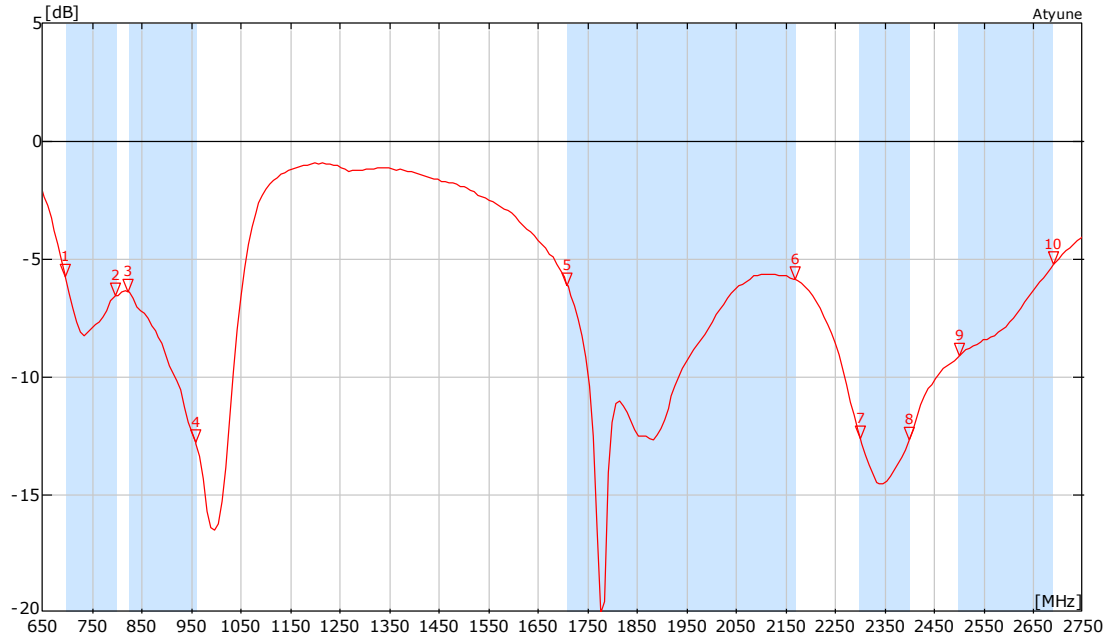

7.2 VSWR

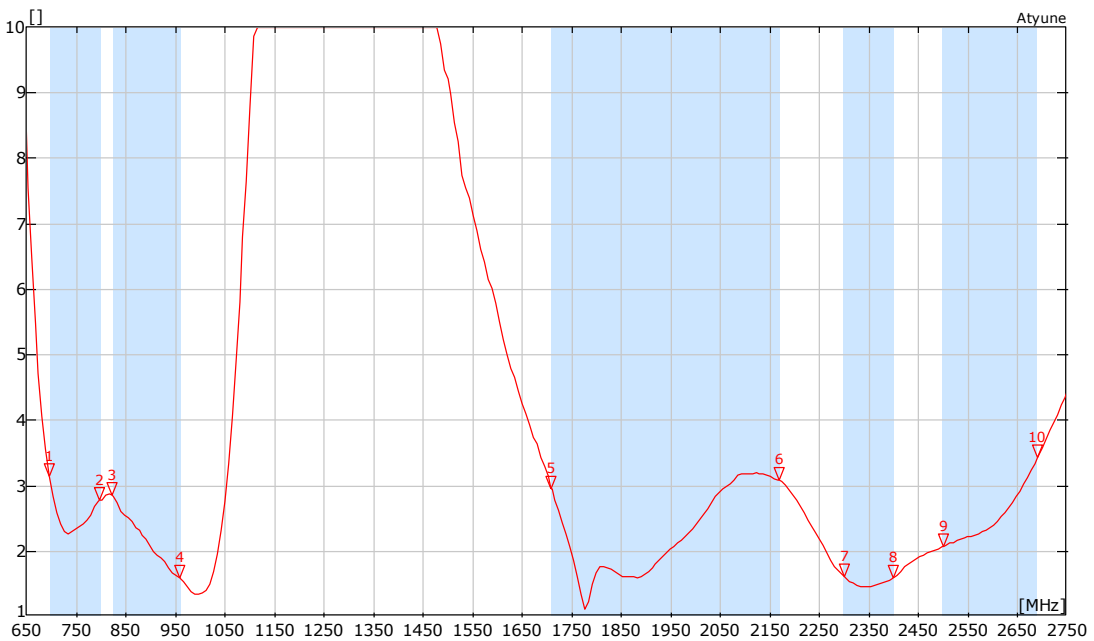

7.3 Antenna pattern

7.3.1 698 MHz – 798 MHz

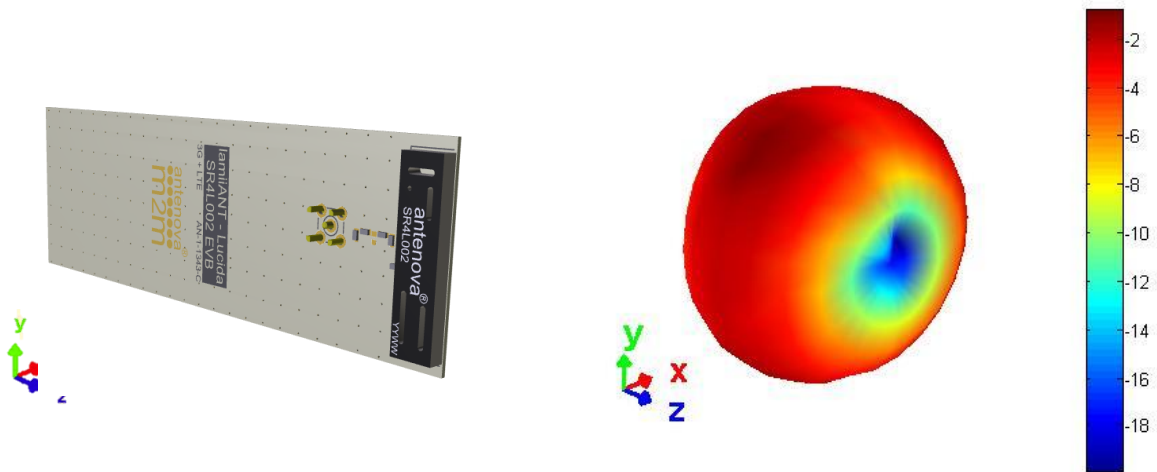

3D pattern at 734 MHz

Drag to rotate pattern and PCB by using Adobe Reader
(Click to Activate)

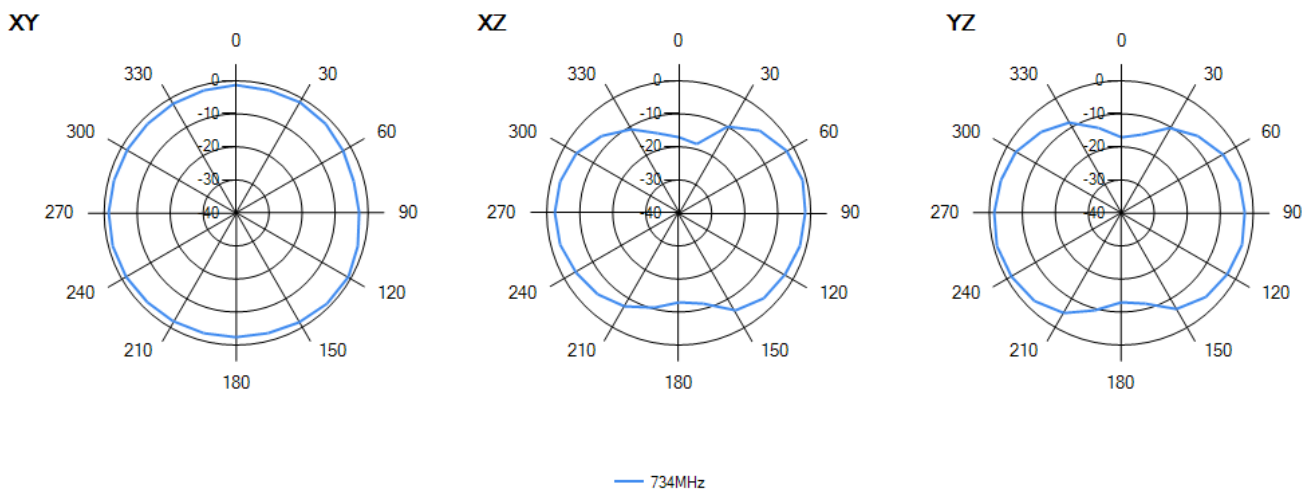

7.3.2 824 MHz – 960 MHz

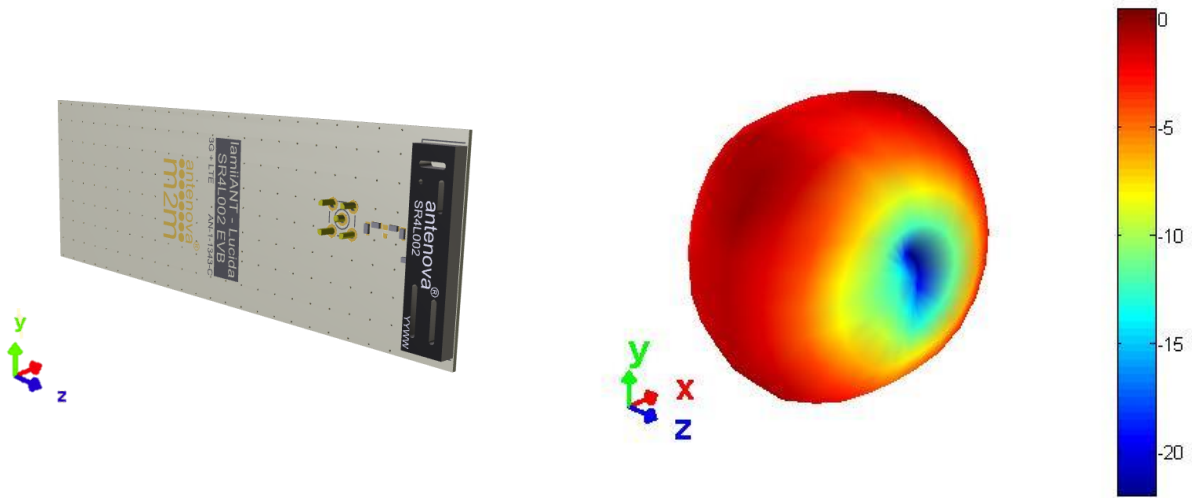

3D pattern at 900 MHz
*Drag to rotate pattern and PCB by using Adobe Reader
(Click to Activate)*

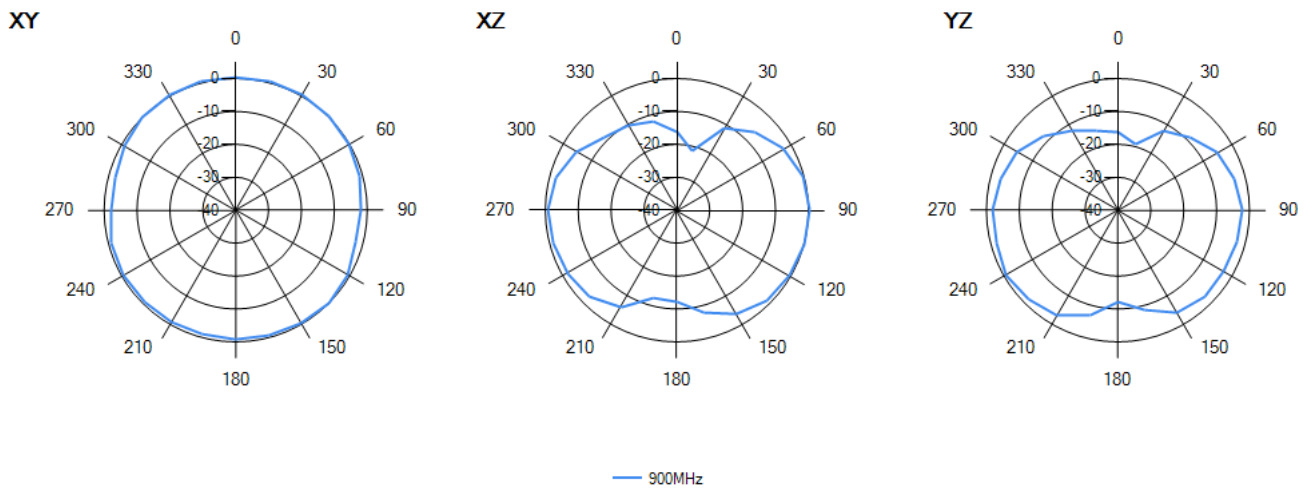

7.3.3 1710 MHz – 2170 MHz

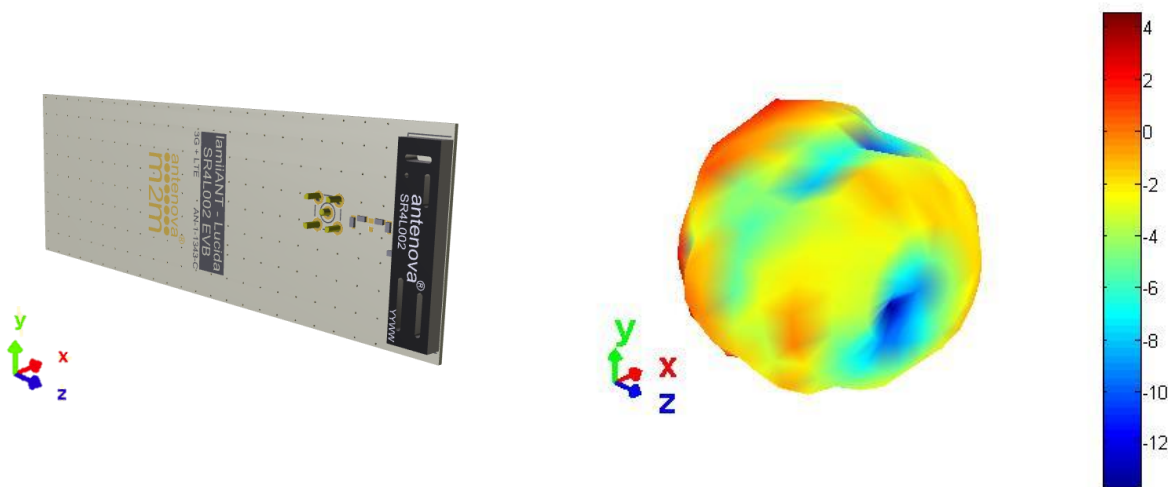

3D pattern at 1930 MHz
*Drag to rotate pattern and PCB by using Adobe Reader
(Click to Activate)*

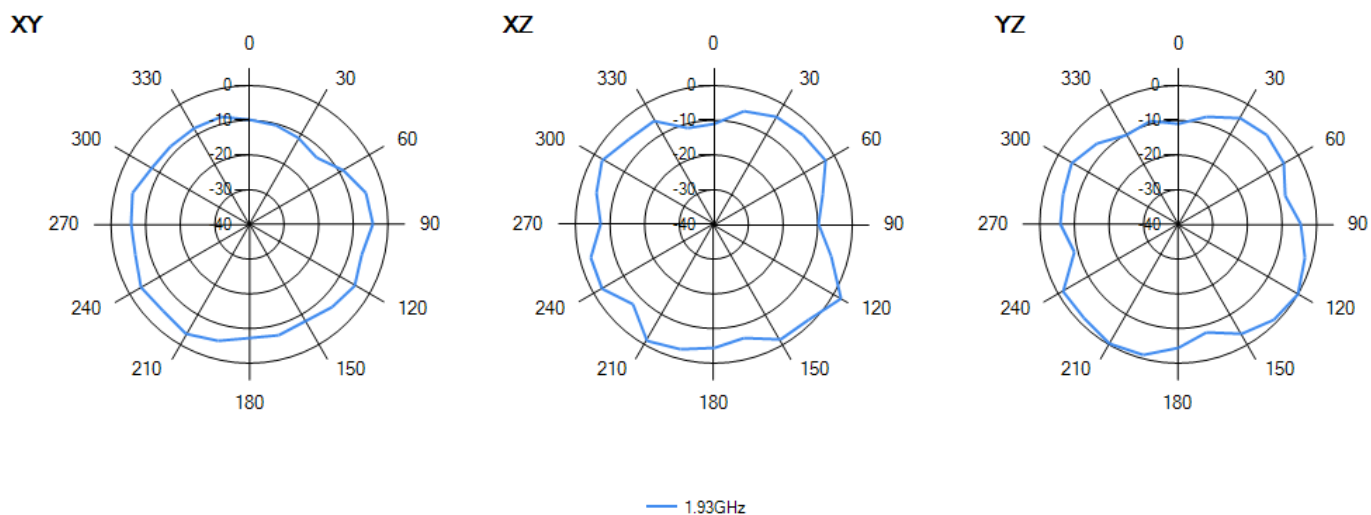

7.3.4 2300 MHz – 2400 MHz

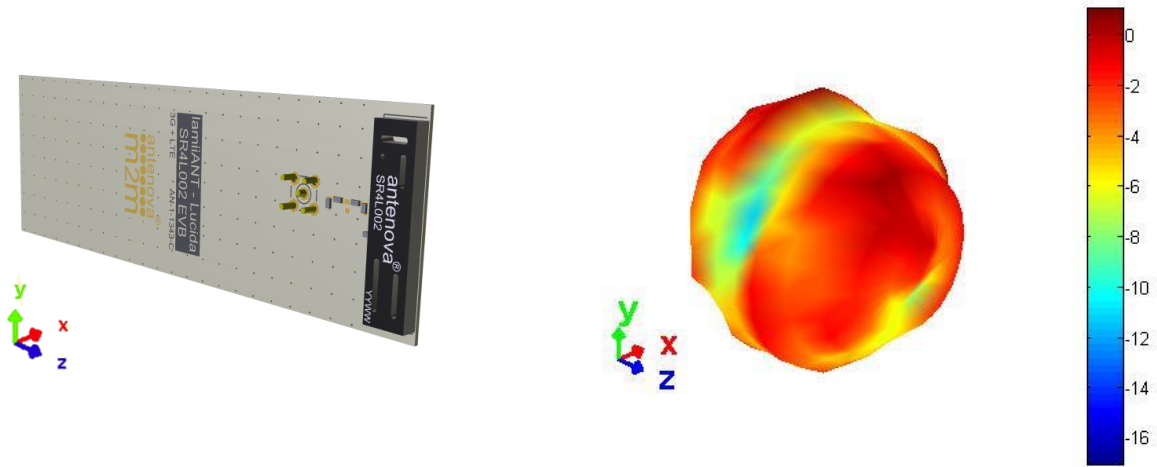

3D pattern at 2340 MHz
*Drag to rotate pattern and PCB by using Adobe Reader
(Click to Activate)*

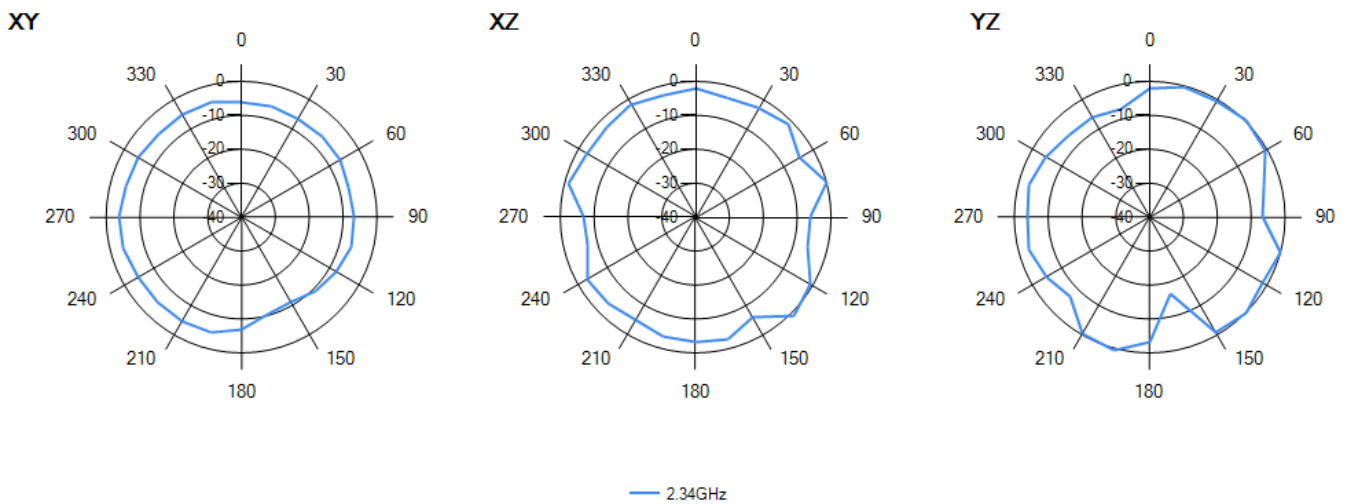

7.3.5 2500 MHz – 2690 MHz

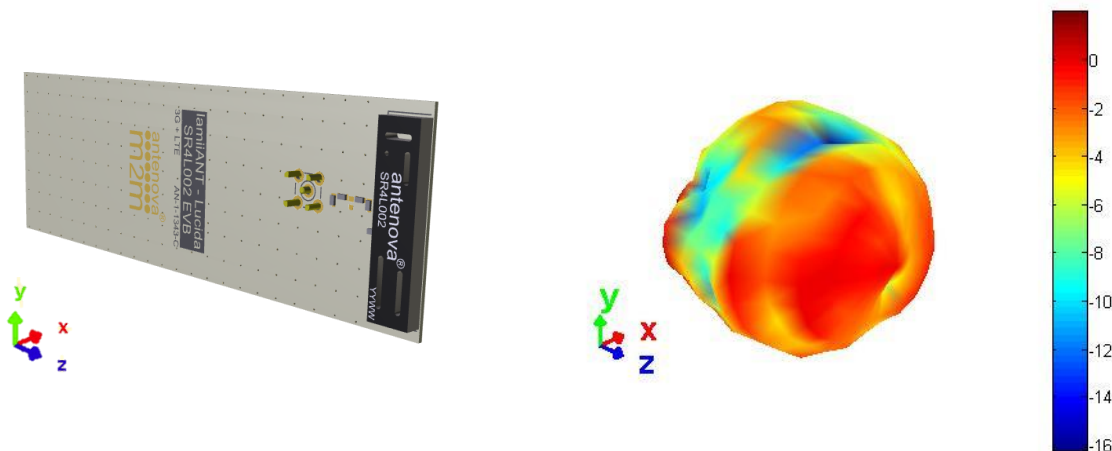

3D pattern at 2600 MHz
*Drag to rotate pattern and PCB by using Adobe Reader
(Click to Activate)*

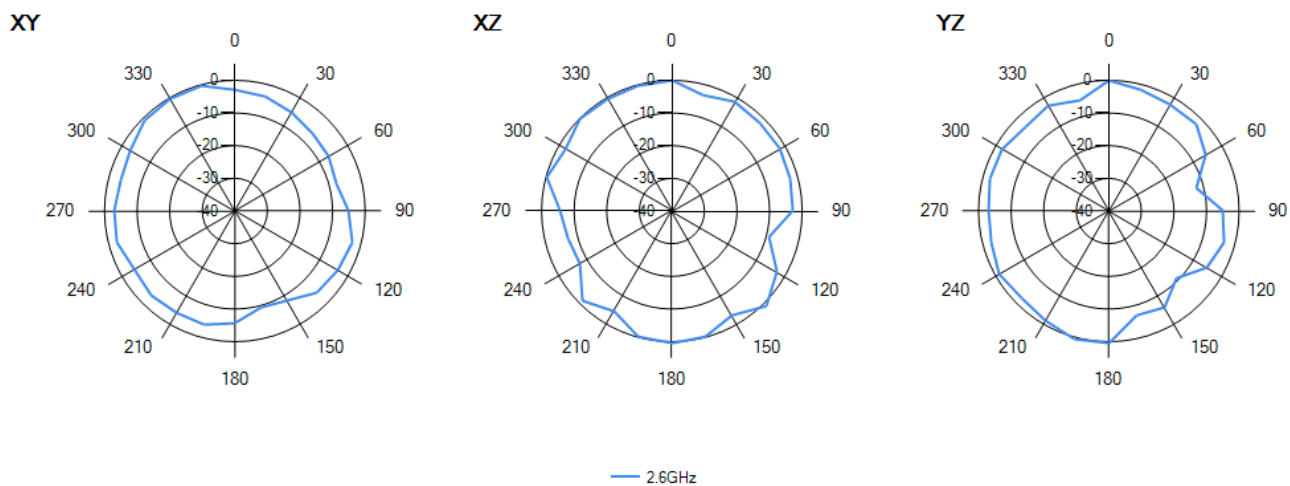

8. Antenna Dimensions



3D rotational
Drag to rotate by using
Adobe Reader
(Click to activate)

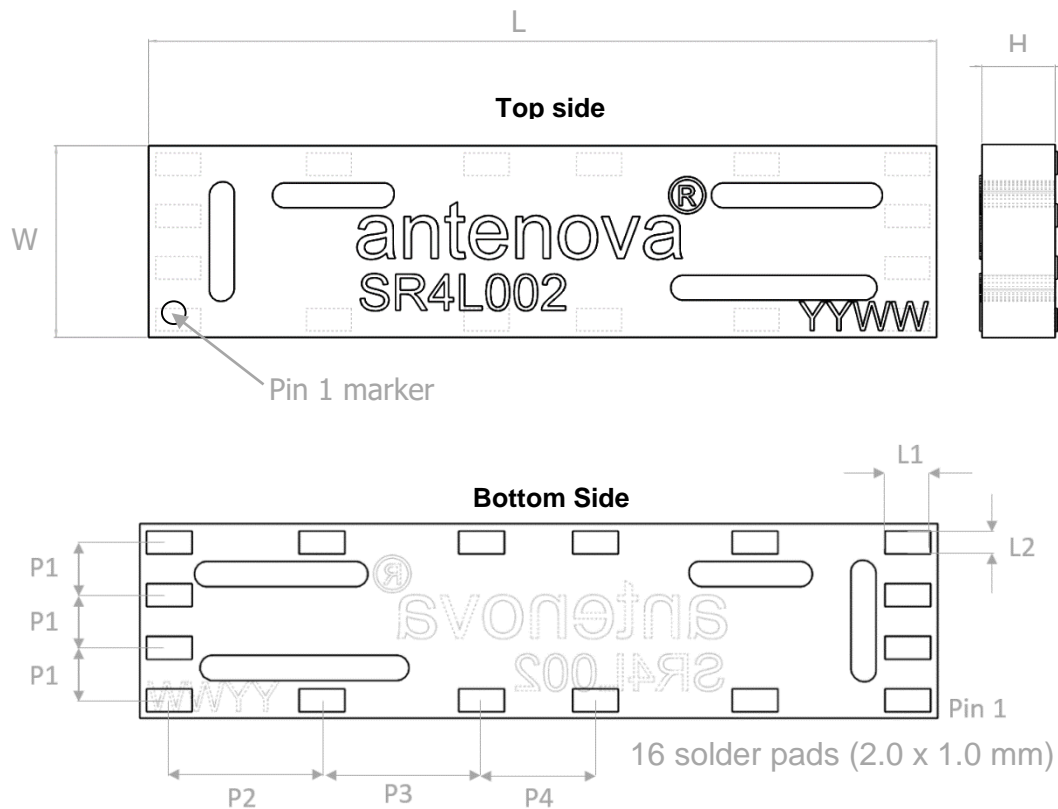

L	W	H
Length	Width	Height
35.0 ±0.1	8.5 ±0.1	3.3 +0.1 -0.0

L1	L2	P1	P2	P3	P4
2.0	1.0	2.3	6.7	7.0	5.0

All Dimensions in (mm)

Antennas for Wireless M2M Applications

10.0 Schematic symbol and Pin definition

The circuit symbol for the antenna is shown below. The antenna has 16 pins with only two as functional. All other pins are for mechanical strength.

Pin	Description
3	Feed
4	Return/GND
1,2,5,6,7,8,9,10,11,12,13,14,15,16	Not used (Mechanical only)

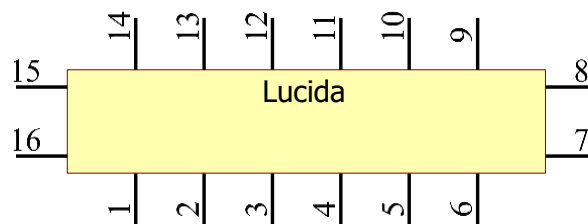

9.0 Antenna footprint

The recommended host PCB footprint is below.

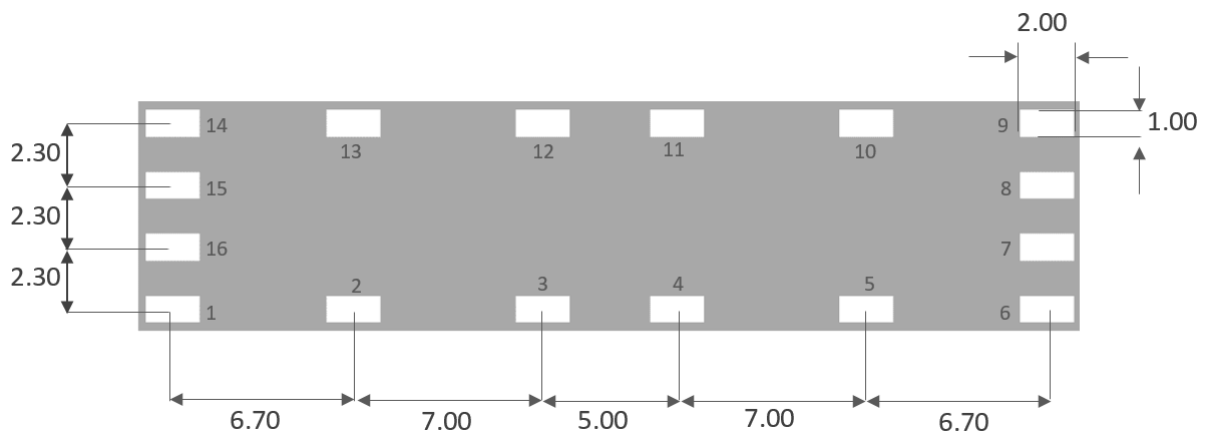

16 copper pads all 2.0 x 1.0 (mm)

11. Electrical Interface

11.1 Transmission Line

All transmission lines should be designed to have a characteristic impedance of 50Ω.

- The length of the transmission lines should be kept to a minimum
- Any other parts of the RF system like transceivers, power amplifiers, etc, should also be designed to have an impedance of 50 Ω

Once the material for the PCB has been chosen (PCB thickness and dielectric constant), a coplanar transmission line can easily be designed using any of the commercial software packages for transmission line design. For the chosen PCB thickness, copper thickness and substrate dielectric constant, the program will calculate the appropriate transmission line width and gaps on either side of the track so the characteristic impedance of the coplanar transmission is 50 Ω.

11.2 Matching Circuit

The antenna requires a matching circuit that must be optimized for each product. The matching circuit will require up to six components and the following circuit should be designed into the host PCB. Not all components may be required but should be included as a precaution. The matching network must be placed close to the antenna feed to ensure it is more effective in tuning the antenna.

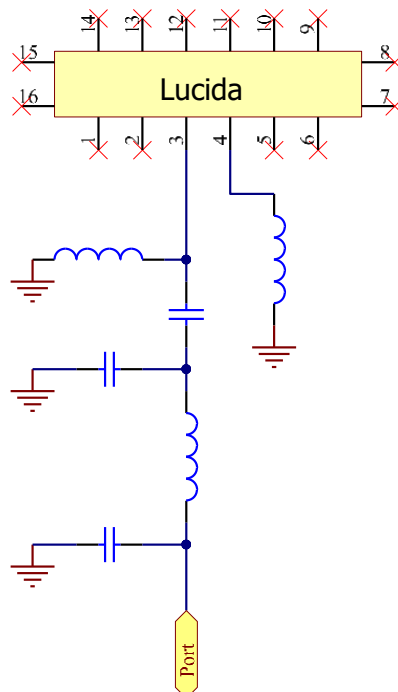

12.0 Antenna Integration Guide

12.1 Antenna Placement

Whichever the host PCB size used, the antenna should be placed ideally on the host PCB's shortest edge with the longest GND

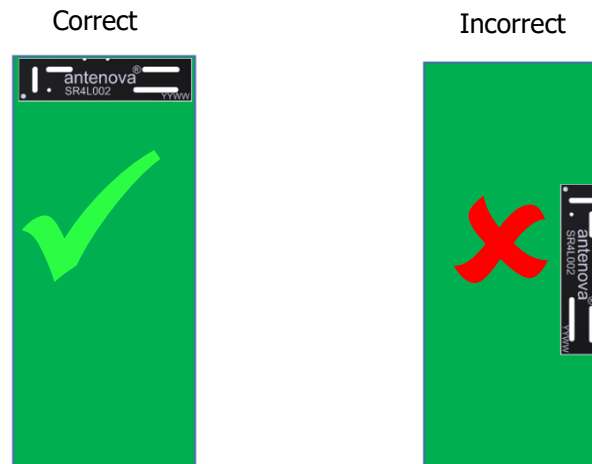

The antenna requires clearance ideally in 5 spatial directions as shown below. Where this cannot be achieved you should keep as many clear as possible to a minimum of 3. Please note performance will degrade with less clearances.

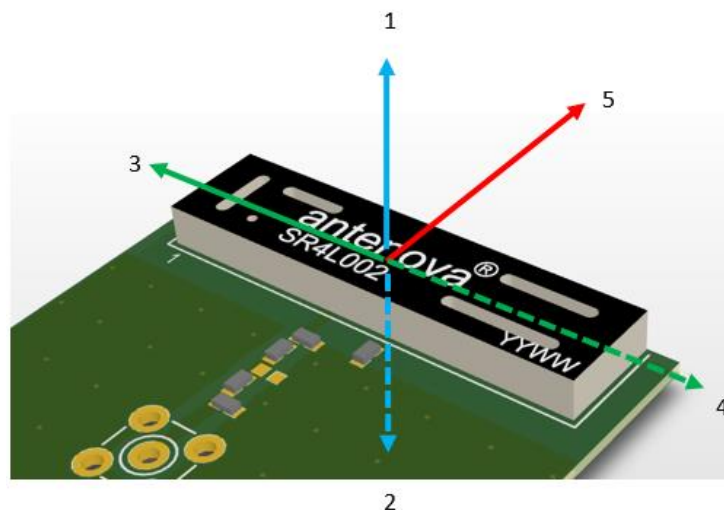

12.2 Host PCB Layout

The host PCB must ensure the footprint and clearance meets the antenna specification. An example of the PCB layout shows the antenna footprint with clearance.

Example host layout

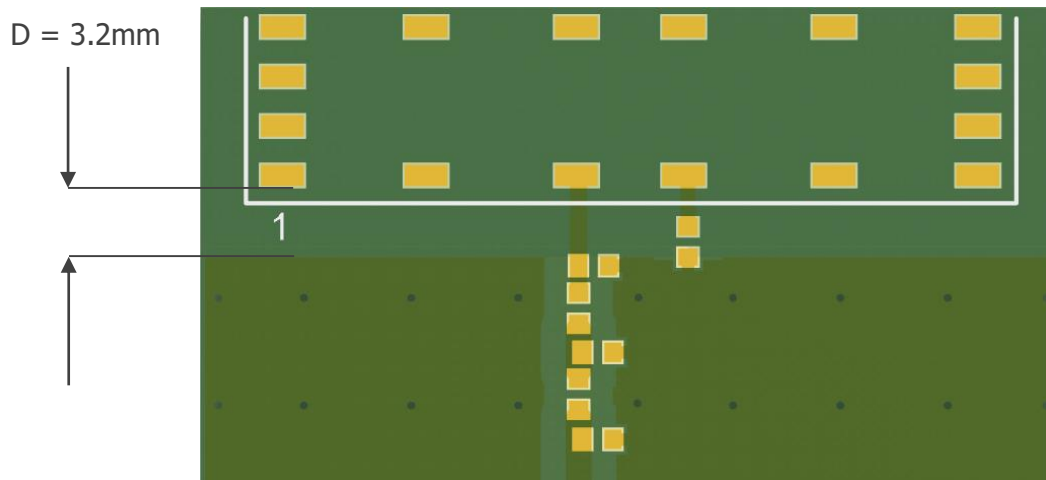

The distance D is the gap required from the antenna SMD pad edge to the ground plane. This should be maintained along the edge the antenna is placed.

12.3 Host PCB Clearance

Below shows the antenna footprint and clearance through all layers on the PCB. Only the antenna pads and connections to feed and GND are present within this clearance area.

Example host layout

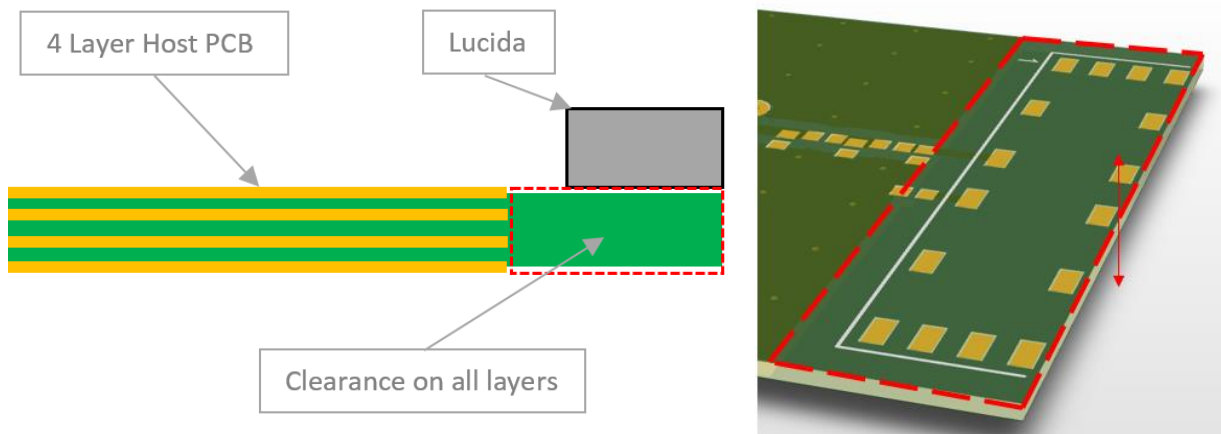

Placement of components and GND with traces adjacent to the antenna should maintain a minimum clearance of 15mm from either side. The antenna should be therefore placed in the corner to only have one side effected.

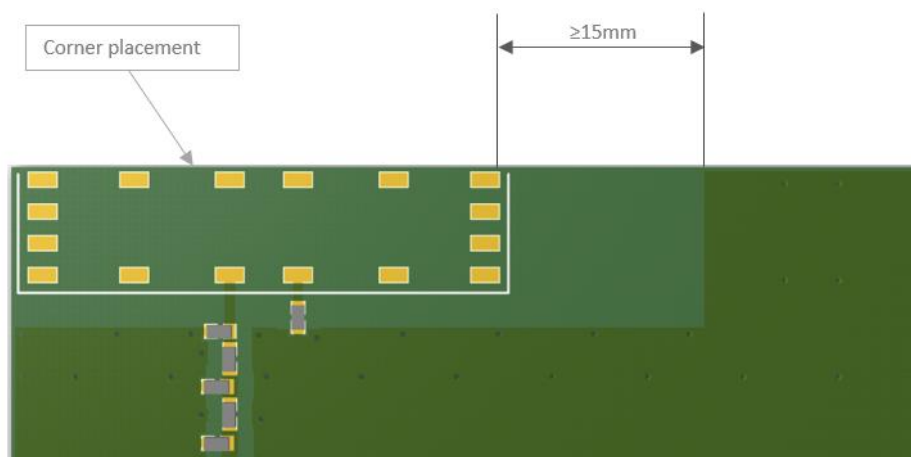

13.0 Diversity Example

For a MIMO system comprising of two LTE antennas. Care must be taken for the placement to ensure that the isolation and cross correlation is within acceptable limits. Below is an example using two Lucida mounted on the same host PCB.

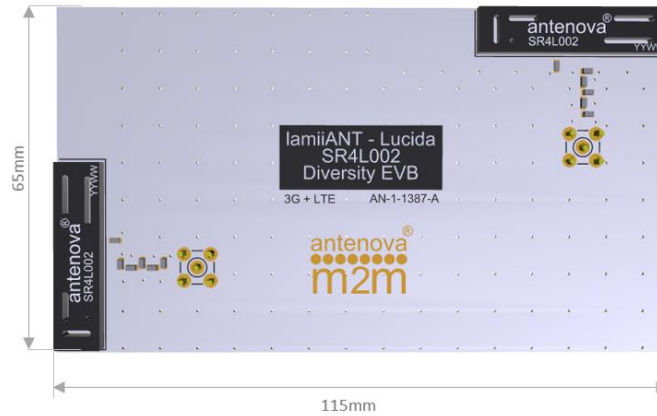

Isolation

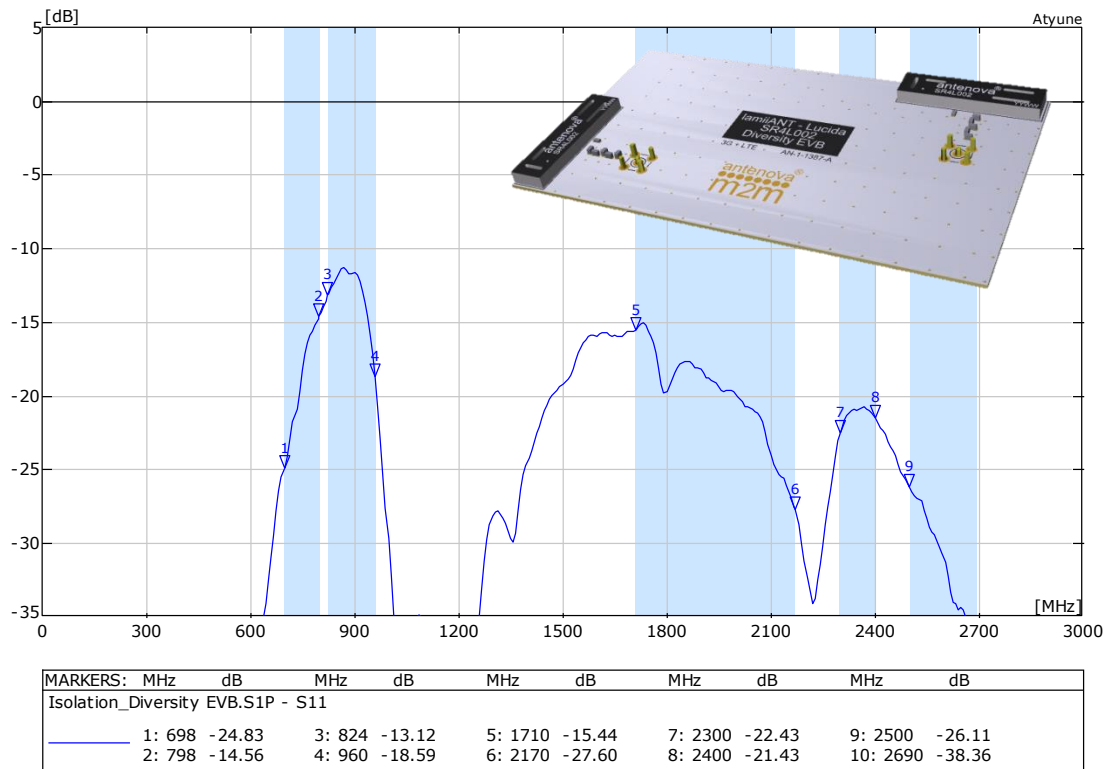

13.0 Host PCB Size

The performance of the low bands is highly dependent on the ground plane length. The host PCB ground needs to be as long as the device allows. Reducing the GND directly relates to the performance of the low bands. As shown below you can see the effect of the GND plane length vs the efficiency.

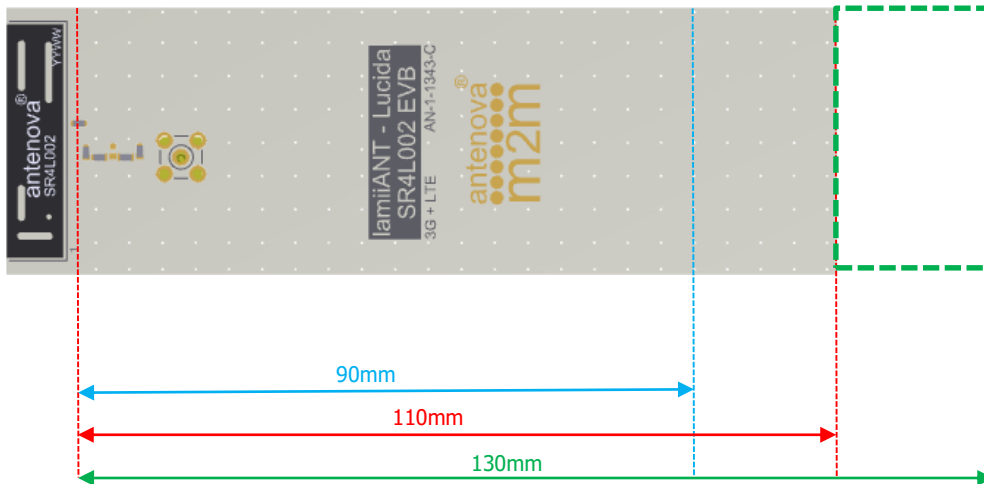

Passive Efficiency vs. PCB length
All results measured in Antenova's anechoic chamber

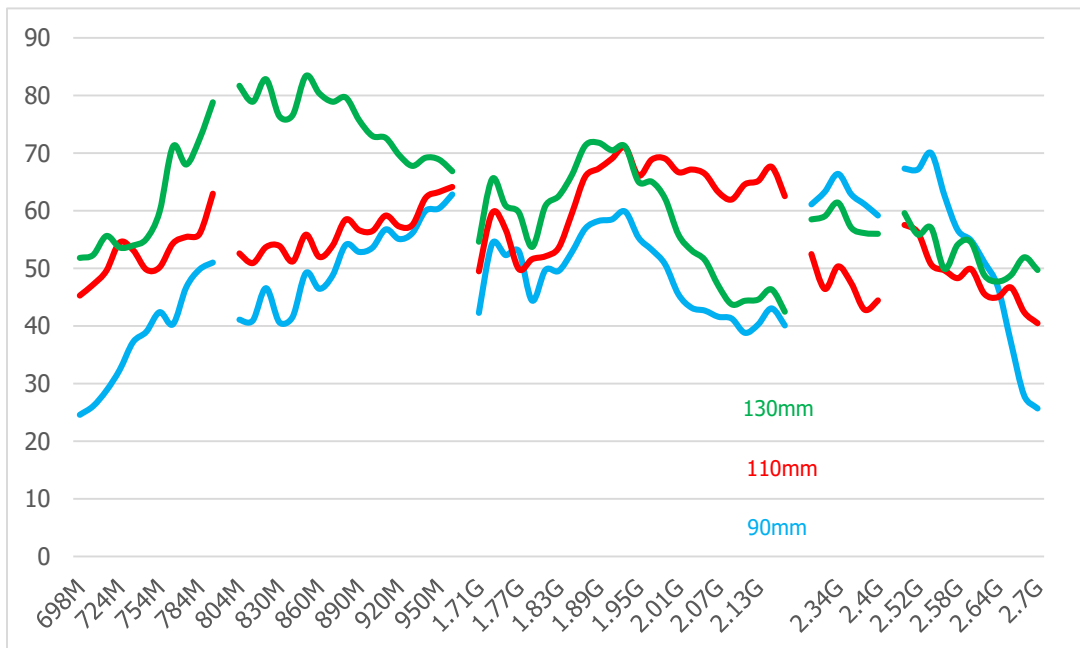

14.0 Reference Board

The reference board has been designed for evaluation purposes of SR4L002 includes a SMA female connector.

SR4L002 Evaluation Board



To order a reference board contact sales@antenna-m2m.com.
Please state if single or two antenna EVB is required.

14.1 Reference Board Matching Circuit

The reference board has been designed for evaluation purposes of SR4L002 includes a SMA female connector.

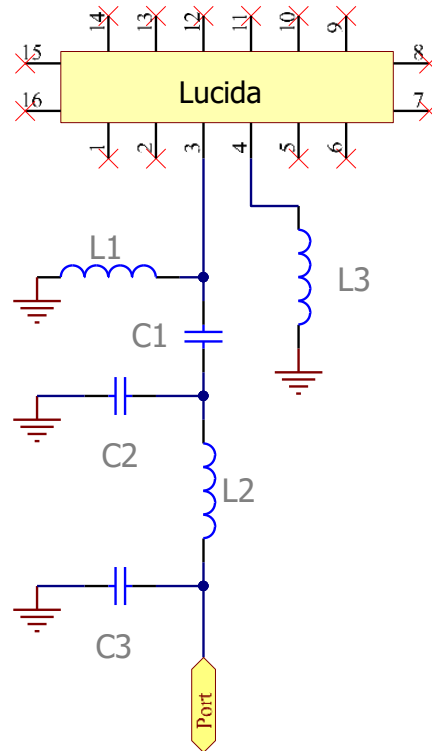

Designator	Type	Value	Description
L1, L3	Inductor	15nH	Murata LQG15HN series
L2	Inductor	3.3nH	Murata LQG15HN series
C1	Capacitor	2.2pF	Murata GJM15 series
C2	Capacitor	Not fitted	Not fitted
C3	Capacitor	0.5pF	Murata GJM15 series

15. Soldering

This antenna is suitable for lead free soldering. The reflow profile should be adjusted to suit the device, oven and solder paste, while observing the following conditions:

- The maximum temperature should not exceed 240 °C
- However for lead free soldering, a maximum temperature of 255 °C for no more than 20 seconds is permitted.
- The antenna should not be exposed to temperatures exceeding 120 °C more than 3 times during the soldering process.

16. Hazardous Material Regulation Conformance

The antenna has been tested to conform to RoHS requirements. A certificate of conformance is available from Antenova M2M's website.

17. Packaging

17.1 Optimal Storage Conditions

Temperature	-10°C to 40°C
Humidity	Less than 75% RH
Shelf life	24 Months
Storage place	Away from corrosive gas and direct sunlight
Packaging	Reels should be stored in unopened sealed manufacturer's plastic packaging.

Note: Storage of open reels of antennas is not recommended due to possible oxidization of pads on antennas. If short term storage is necessary, then it is highly recommended that the bag containing the antenna reel is re-sealed and stored in like storage conditions as in above table.

17.2 Tape Characteristics

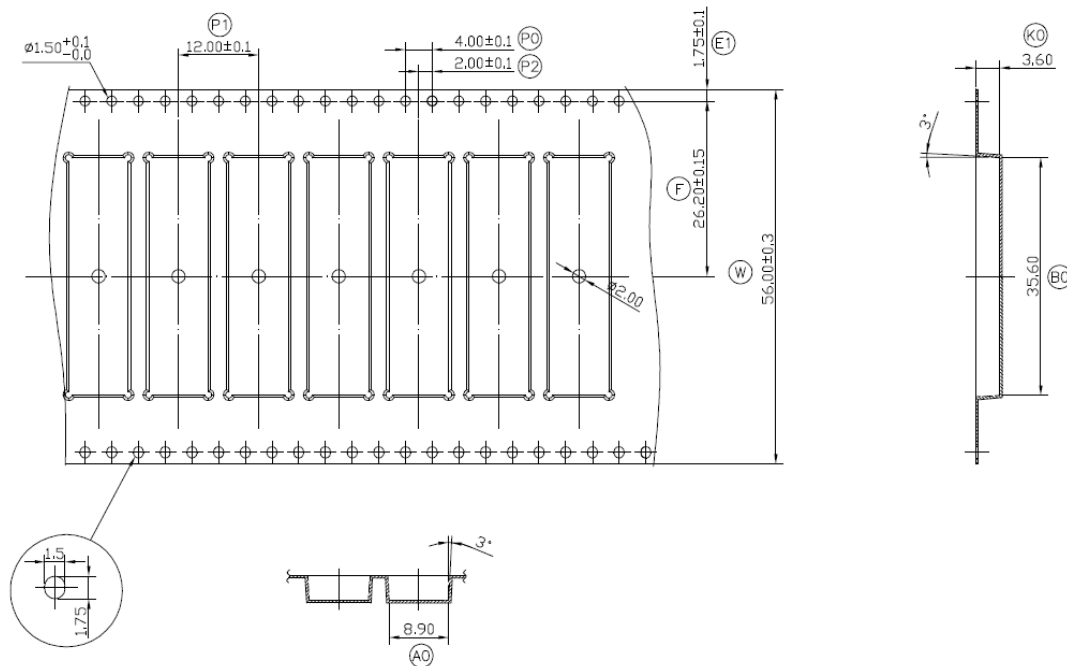

Ko	Ao	Bo	P0	P1	P2
3.60	8.90 ± 0.1	35.60 ± 0.1	4.00 ± 0.1	12.00 ± 0.1	2.00 ± 0.1

E1	F	W
1.75 ± 0.1	26.2 ± 0.15	56.00 ± 0.3

Dimensions in mm

Notes:

- 1) Material: PS Black – Thickness: 0.35 ± 0.05.
- 2) Packaging length per 22" reel: 51 Meters (1:4).
- 3) Component load per 13" reel: 1000pcs

17.3 Reel Dimensions

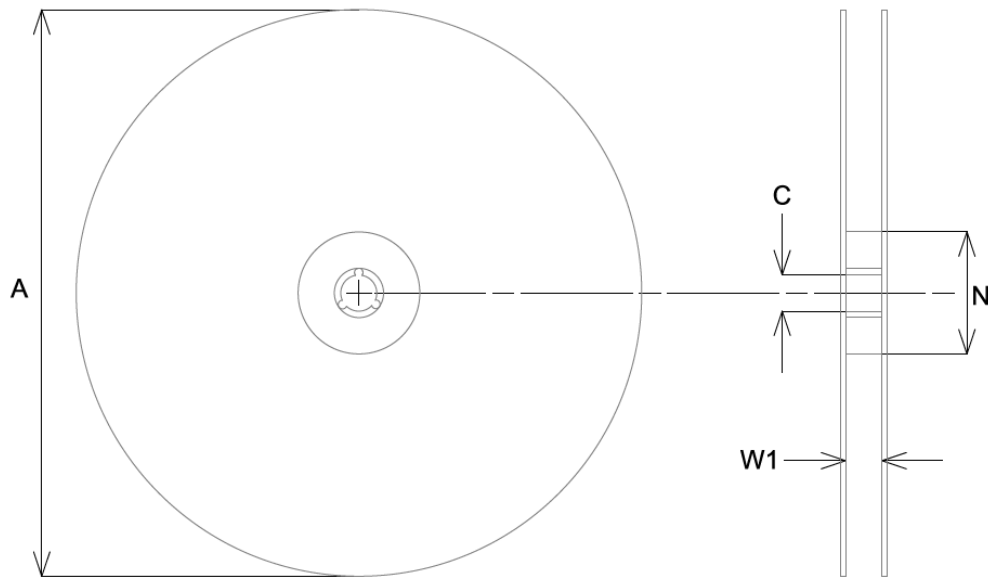

A	C	N	W1
330.0 ± 2.0	13.5 ± 0.5	100.0 ± 0.2	44.4 ± 0.3

All dimensions in mm

17.4 Box Dimensions

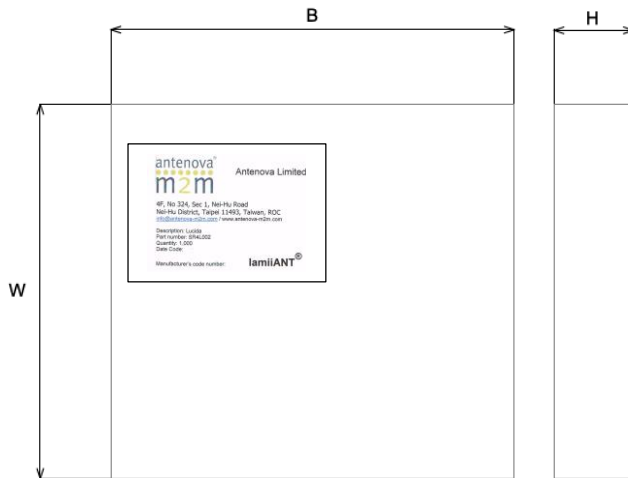

Width (W)	Breadth (B)	Thickness (H)
350mm	355mm	70mm

17.5 Bag Properties

Reels are supplied in protective plastic packaging.

17.6 Reel Label Information

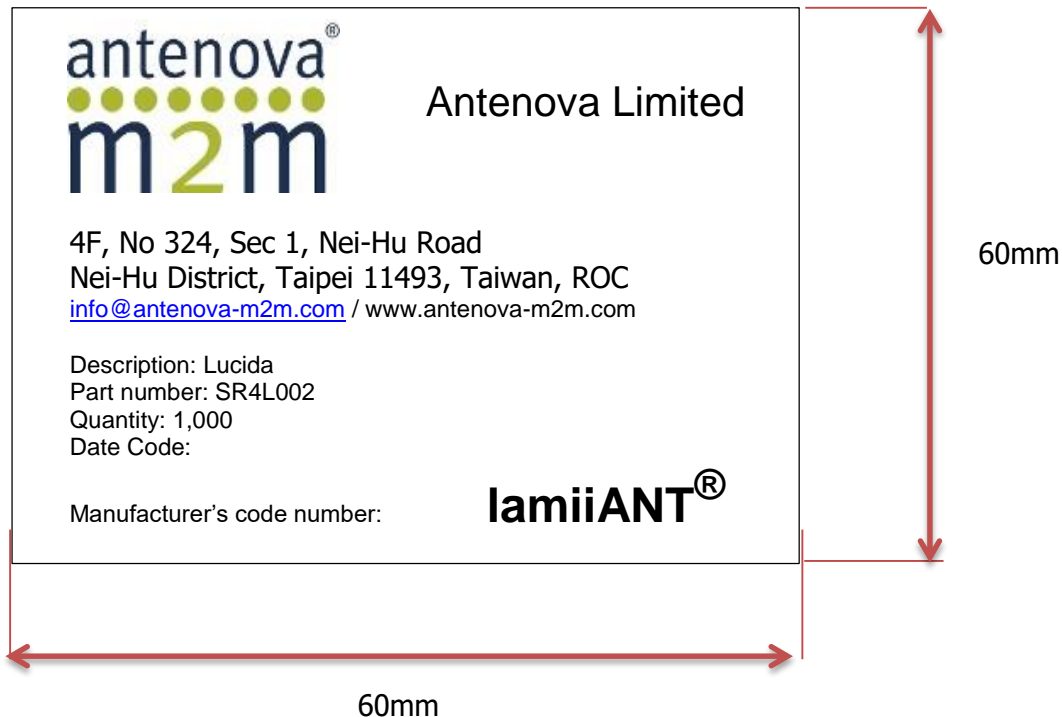



www.antenova-m2m.com

Corporate Headquarters

Antenova Limited
2nd Floor Titan Court
3 Bishop Square
Hatfield
AL10 9NA
UK

Tel: +44 1233 810600

Email: sales@antenova-m2m.com

North America Headquarters

Antenova Limited
100 Brush Creek Road
Suite 103, Santa Rosa
California 95404,
USA

Tel: +1 707 890 5202

Email: sales@antenova-m2m.com

Asia Headquarters

Antenova Asia Limited
4F, No. 324, Sec. 1, Nei-Hu Road
Hei-Hu District
Taipei 11493
Taiwan, ROC

Tel: +886 (0) 2 8797 8630

Fax: +886 (0) 2 8797 6890

Email: sales@antenova-m2m.com

Copyright© Antenova Ltd. All Rights Reserved. Antenova ®, Antenova M2M ®, gigaNOVA ® , the Antenova product family names, and the Antenova and Antenova M2M logos are trademarks and/or registered trademarks of Antenova Ltd. Any other names and/or trademarks belong to their respective companies.

The materials provided herein are believed to be reliable and correct at the time of printing. Antenova does not warrant the accuracy or completeness of the information, text, graphics or other items contained within this information. Antenova further assumes no responsibility for the use of this information, and all such information shall be entirely at the user's risk.



Certificate No: 4598

Antennas for Wireless M2M Applications

Данный компонент на территории Российской Федерации

Вы можете приобрести в компании MosChip.

Для оперативного оформления запроса Вам необходимо перейти по данной ссылке:

<http://moschip.ru/get-element>

Вы можете разместить у нас заказ для любого Вашего проекта, будь то серийное производство или разработка единичного прибора.

В нашем ассортименте представлены ведущие мировые производители активных и пассивных электронных компонентов.

Нашей специализацией является поставка электронной компонентной базы двойного назначения, продукции таких производителей как XILINX, Intel (ex.ALTERA), Vicor, Microchip, Texas Instruments, Analog Devices, Mini-Circuits, Amphenol, Glenair.

Сотрудничество с глобальными дистрибьюторами электронных компонентов, предоставляет возможность заказывать и получать с международных складов практически любой перечень компонентов в оптимальные для Вас сроки.

На всех этапах разработки и производства наши партнеры могут получить квалифицированную поддержку опытных инженеров.

Система менеджмента качества компании отвечает требованиям в соответствии с ГОСТ Р ИСО 9001, ГОСТ РВ 0015-002 и ЭС РД 009

Офис по работе с юридическими лицами:

105318, г.Москва, ул.Щербаковская д.3, офис 1107, 1118, ДЦ «Щербаковский»

Телефон: +7 495 668-12-70 (многоканальный)

Факс: +7 495 668-12-70 (доб.304)

E-mail: info@moschip.ru

Skype отдела продаж:

moschip.ru

moschip.ru_4

moschip.ru_6

moschip.ru_9