

## Backlighting LED in Ø 3 mm Tinted Non-Diffused Package

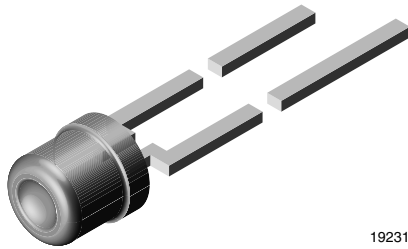

### DESCRIPTION

The TLV.420. series was developed for backlighting. Due to its special shape the spatial distribution of the radiation is qualified for backlighting.

To optimize the brightness of backlighting a custom-built reflector (with scattering) is required. Uniform illumination can be enhanced by covering the front of the reflector with diffusor material.

This is a flexible solution for backlighting different areas.

### PRODUCT GROUP AND PACKAGE DATA

- Product group: LED
- Package: 3 mm backlighting
- Product series: standard
- Angle of half intensity:  $\pm 85^\circ$

### FEATURES

- High light output
- Wide viewing angle
- Categorized for luminous flux
- Tinted clear package
- Low power dissipation
- Low self heating
- Rugged design
- High reliability
- Material categorization: for definitions of compliance please see [www.vishay.com/doc?99912](http://www.vishay.com/doc?99912)



### APPLICATIONS

- Backlighting of display panels, LCD displays, symbols on switches, keyboards, graphic boards, and measuring scales
- Illumination of large areas e.g. dot matrix displays

### PARTS TABLE

| PART     | COLOR       | LUMINOUS FLUX (mIm) |      |      | at I <sub>F</sub> (mA) | WAVELENGTH (nm) |      |      | at I <sub>F</sub> (mA) | FORWARD VOLTAGE (V) |      |      | at I <sub>F</sub> (mA) | TECHNOLOGY   |
|----------|-------------|---------------------|------|------|------------------------|-----------------|------|------|------------------------|---------------------|------|------|------------------------|--------------|
|          |             | MIN.                | TYP. | MAX. |                        | MIN.            | TYP. | MAX. |                        | MIN.                | TYP. | MAX. |                        |              |
| TLVH4200 | Red         | 10                  | 55   | -    | 15                     | 612             | -    | 625  | 10                     | -                   | 2.4  | 3    | 20                     | GaAsP on GaP |
| TLVH4201 | Red         | 40                  | -    | 125  | 15                     | 612             | -    | 625  | 10                     | -                   | 2.4  | 3    | 20                     | GaAsP on GaP |
| TLVS4200 | Soft orange | 10                  | 70   | -    | 15                     | 598             | -    | 611  | 10                     | -                   | 2.4  | 3    | 20                     | GaAsP on GaP |
| TLVY4200 | Yellow      | 10                  | 30   | -    | 15                     | 581             | -    | 594  | 10                     | -                   | 2.4  | 3    | 20                     | GaAsP on GaP |
| TLVG4200 | Green       | 10                  | 30   | -    | 15                     | 562             | -    | 575  | 10                     | -                   | 2.4  | 3    | 20                     | GaP on GaP   |
| TLVP4200 | Pure green  | 4                   | 20   | -    | 15                     | 555             | -    | 565  | 10                     | -                   | 2.4  | 3    | 20                     | GaP on GaP   |
| TLVP4201 | Pure green  | 16                  | 30   | -    | 15                     | 555             | -    | 565  | 10                     | -                   | 2.4  | 3    | 20                     | GaP on GaP   |

### ABSOLUTE MAXIMUM RATINGS (T<sub>amb</sub> = 25 °C, unless otherwise specified)

#### TLVH4200, TLVH4201, TLVS4200, TLVY4200, TLVG4200, TLVP4200, TLVP4201

| PARAMETER                           | TEST CONDITION           | SYMBOL            | VALUE       | UNIT |
|-------------------------------------|--------------------------|-------------------|-------------|------|
| Reverse voltage <sup>(1)</sup>      |                          | V <sub>R</sub>    | 5           | V    |
| DC forward current                  | T <sub>amb</sub> ≤ 60 °C | I <sub>F</sub>    | 30          | mA   |
| Surge forward current               | t <sub>p</sub> ≤ 10 μs   | I <sub>FSM</sub>  | 1           | A    |
| Power dissipation                   |                          | P <sub>V</sub>    | 90          | mW   |
| Junction temperature                |                          | T <sub>j</sub>    | 100         | °C   |
| Operating temperature range         |                          | T <sub>amb</sub>  | -40 to +100 | °C   |
| Storage temperature range           |                          | T <sub>stg</sub>  | -55 to +100 | °C   |
| Soldering temperature               | t ≤ 5 s, 2 mm from body  | T <sub>sd</sub>   | 260         | °C   |
| Thermal resistance junction/ambient |                          | R <sub>thJA</sub> | 400         | K/W  |

#### Note

- <sup>(1)</sup> Driving the LED in reverse direction is suitable for a short term application



| <b>OPTICAL AND ELECTRICAL CHARACTERISTICS</b> ( $T_{amb} = 25\text{ }^{\circ}\text{C}$ , unless otherwise specified) |                                         |          |             |      |          |      |      |
|----------------------------------------------------------------------------------------------------------------------|-----------------------------------------|----------|-------------|------|----------|------|------|
| <b>TLVH4200, TLVH4201, RED</b>                                                                                       |                                         |          |             |      |          |      |      |
| PARAMETER                                                                                                            | TEST CONDITION                          | PART     | SYMBOL      | MIN. | TYP.     | MAX. | UNIT |
| Luminous flux                                                                                                        | $I_F = 15\text{ mA}$                    | TLVH4200 | $\phi_V$    | 10   | 55       | -    | mlm  |
|                                                                                                                      |                                         | TLVH4201 | $\phi_V$    | 40   | -        | 125  | mlm  |
| Dominant wavelength                                                                                                  | $I_F = 10\text{ mA}$                    |          | $\lambda_d$ | 612  | -        | 625  | nm   |
| Peak wavelength                                                                                                      | $I_F = 10\text{ mA}$                    |          | $\lambda_p$ | -    | 635      | -    | nm   |
| Angle of half intensity                                                                                              | $I_F = 10\text{ mA}$                    |          | $\varphi$   | -    | $\pm 85$ | -    | deg  |
| Forward voltage                                                                                                      | $I_F = 20\text{ mA}$                    |          | $V_F$       | -    | 2.4      | 3    | V    |
| Reverse voltage                                                                                                      | $I_R = 10\text{ }\mu\text{A}$           |          | $V_R$       | 6    | 15       | -    | V    |
| Junction capacitance                                                                                                 | $V_R = 0\text{ V}$ , $f = 1\text{ MHz}$ |          | $C_j$       | -    | 50       | -    | pF   |

| <b>OPTICAL AND ELECTRICAL CHARACTERISTICS</b> ( $T_{amb} = 25\text{ }^{\circ}\text{C}$ , unless otherwise specified) |                                         |          |             |      |          |      |      |
|----------------------------------------------------------------------------------------------------------------------|-----------------------------------------|----------|-------------|------|----------|------|------|
| <b>TLVS4200, SOFT ORANGE</b>                                                                                         |                                         |          |             |      |          |      |      |
| PARAMETER                                                                                                            | TEST CONDITION                          | PART     | SYMBOL      | MIN. | TYP.     | MAX. | UNIT |
| Luminous flux                                                                                                        | $I_F = 15\text{ mA}$                    | TLVS4200 | $\phi_V$    | 10   | 70       | -    | mlm  |
| Dominant wavelength                                                                                                  | $I_F = 10\text{ mA}$                    |          | $\lambda_d$ | 598  | -        | 611  | nm   |
| Peak wavelength                                                                                                      | $I_F = 10\text{ mA}$                    |          | $\lambda_p$ | -    | 605      | -    | nm   |
| Angle of half intensity                                                                                              | $I_F = 10\text{ mA}$                    |          | $\varphi$   | -    | $\pm 85$ | -    | deg  |
| Forward voltage                                                                                                      | $I_F = 20\text{ mA}$                    |          | $V_F$       | -    | 2.4      | 3    | V    |
| Reverse voltage                                                                                                      | $I_R = 10\text{ }\mu\text{A}$           |          | $V_R$       | 6    | 15       | -    | V    |
| Junction capacitance                                                                                                 | $V_R = 0\text{ V}$ , $f = 1\text{ MHz}$ |          | $C_j$       | -    | 50       | -    | pF   |

| <b>OPTICAL AND ELECTRICAL CHARACTERISTICS</b> ( $T_{amb} = 25\text{ }^{\circ}\text{C}$ , unless otherwise specified) |                                         |          |             |      |          |      |      |
|----------------------------------------------------------------------------------------------------------------------|-----------------------------------------|----------|-------------|------|----------|------|------|
| <b>TLVY4200, YELLOW</b>                                                                                              |                                         |          |             |      |          |      |      |
| PARAMETER                                                                                                            | TEST CONDITION                          | PART     | SYMBOL      | MIN. | TYP.     | MAX. | UNIT |
| Luminous flux                                                                                                        | $I_F = 15\text{ mA}$                    | TLVY4200 | $\phi_V$    | 10   | 30       | -    | mlm  |
| Dominant wavelength                                                                                                  | $I_F = 10\text{ mA}$                    |          | $\lambda_d$ | 581  | -        | 594  | nm   |
| Peak wavelength                                                                                                      | $I_F = 10\text{ mA}$                    |          | $\lambda_p$ | -    | 585      | -    | nm   |
| Angle of half intensity                                                                                              | $I_F = 10\text{ mA}$                    |          | $\varphi$   | -    | $\pm 85$ | -    | deg  |
| Forward voltage                                                                                                      | $I_F = 20\text{ mA}$                    |          | $V_F$       | -    | 2.4      | 3    | V    |
| Reverse voltage                                                                                                      | $I_R = 10\text{ }\mu\text{A}$           |          | $V_R$       | 6    | 15       | -    | V    |
| Junction capacitance                                                                                                 | $V_R = 0\text{ V}$ , $f = 1\text{ MHz}$ |          | $C_j$       | -    | 50       | -    | pF   |

| <b>OPTICAL AND ELECTRICAL CHARACTERISTICS</b> ( $T_{amb} = 25\text{ }^{\circ}\text{C}$ , unless otherwise specified) |                                         |          |             |      |          |      |      |
|----------------------------------------------------------------------------------------------------------------------|-----------------------------------------|----------|-------------|------|----------|------|------|
| <b>TLVG4200, GREEN</b>                                                                                               |                                         |          |             |      |          |      |      |
| PARAMETER                                                                                                            | TEST CONDITION                          | PART     | SYMBOL      | MIN. | TYP.     | MAX. | UNIT |
| Luminous flux                                                                                                        | $I_F = 15\text{ mA}$                    | TLVG4200 | $\phi_V$    | 10   | 30       | -    | mlm  |
| Dominant wavelength                                                                                                  | $I_F = 10\text{ mA}$                    |          | $\lambda_d$ | 562  | -        | 575  | nm   |
| Peak wavelength                                                                                                      | $I_F = 10\text{ mA}$                    |          | $\lambda_p$ | -    | 555      | -    | nm   |
| Angle of half intensity                                                                                              | $I_F = 10\text{ mA}$                    |          | $\varphi$   | -    | $\pm 85$ | -    | deg  |
| Forward voltage                                                                                                      | $I_F = 20\text{ mA}$                    |          | $V_F$       | -    | 2.4      | 3    | V    |
| Reverse voltage                                                                                                      | $I_R = 10\text{ }\mu\text{A}$           |          | $V_R$       | 6    | 15       | -    | V    |
| Junction capacitance                                                                                                 | $V_R = 0\text{ V}$ , $f = 1\text{ MHz}$ |          | $C_j$       | -    | 50       | -    | pF   |



| <b>OPTICAL AND ELECTRICAL CHARACTERISTICS</b> ( $T_{amb} = 25\text{ }^{\circ}\text{C}$ , unless otherwise specified)<br><b>TLVP4200, TLVP4201, PURE GREEN</b> |                                         |          |             |      |          |      |      |
|---------------------------------------------------------------------------------------------------------------------------------------------------------------|-----------------------------------------|----------|-------------|------|----------|------|------|
| PARAMETER                                                                                                                                                     | TEST CONDITION                          | PART     | SYMBOL      | MIN. | TYP.     | MAX. | UNIT |
| Luminous flux                                                                                                                                                 | $I_F = 15\text{ mA}$                    | TLVP4200 | $\phi_V$    | 4    | 20       | -    | mlm  |
|                                                                                                                                                               |                                         | TLVP4201 | $\phi_V$    | 16   | 30       | -    | mlm  |
| Dominant wavelength                                                                                                                                           | $I_F = 10\text{ mA}$                    |          | $\lambda_d$ | 555  | -        | 565  | nm   |
| Peak wavelength                                                                                                                                               | $I_F = 10\text{ mA}$                    |          | $\lambda_p$ | -    | 555      | -    | nm   |
| Angle of half intensity                                                                                                                                       | $I_F = 10\text{ mA}$                    |          | $\varphi$   | -    | $\pm 85$ | -    | deg  |
| Forward voltage                                                                                                                                               | $I_F = 20\text{ mA}$                    |          | $V_F$       | -    | 2.4      | 3    | V    |
| Reverse voltage                                                                                                                                               | $I_R = 10\text{ }\mu\text{A}$           |          | $V_R$       | 6    | 15       | -    | V    |
| Junction capacitance                                                                                                                                          | $V_R = 0\text{ V}$ , $f = 1\text{ MHz}$ |          | $C_j$       | -    | 50       | -    | pF   |

| <b>LUMINOUS FLUX CLASSIFICATION</b> |                     |      |
|-------------------------------------|---------------------|------|
| GROUP                               | LUMINOUS FLUX (mlm) |      |
| STANDARD                            | MIN.                | MAX. |
| P                                   | 4                   | 8    |
| Q                                   | 6.3                 | 12.5 |
| R                                   | 10                  | 20   |
| S                                   | 16                  | 32   |
| T                                   | 25                  | 50   |
| U                                   | 40                  | 80   |
| V                                   | 63                  | 125  |
| W                                   | 100                 | 200  |
| X                                   | 130                 | 260  |
| Y                                   | 180                 | 360  |
| Z                                   | 240                 | 480  |

**Note**

- Luminous flux is tested at a current pulse duration of 25 ms.  
The above type numbers represent the order groups which include only a few brightness groups. Only one group will be shipped on each bag (there will be no mixing of two groups in each bag).  
In order to ensure availability, single brightness groups will not be orderable.  
In a similar manner for colors where wavelength groups are measured and binned, single wavelength groups will be shipped on any one bag.  
In order to ensure availability, single wavelength groups will not be orderable.

| <b>COLOR CLASSIFICATION</b> |                      |      |       |      |            |      |
|-----------------------------|----------------------|------|-------|------|------------|------|
| GROUP                       | DOM. WAVELENGTH (nm) |      |       |      |            |      |
|                             | YELLOW               |      | GREEN |      | PURE GREEN |      |
|                             | MIN.                 | MAX. | MIN.  | MAX. | MIN.       | MAX. |
| 0                           |                      |      |       |      | 555        | 559  |
| 1                           | 581                  | 584  |       |      | 558        | 561  |
| 2                           | 583                  | 586  |       |      | 560        | 563  |
| 3                           | 585                  | 588  | 562   | 565  | 562        | 565  |
| 4                           | 587                  | 590  | 564   | 567  |            |      |
| 5                           | 589                  | 592  | 566   | 569  |            |      |
| 6                           | 591                  | 594  | 568   | 571  |            |      |
| 7                           |                      |      | 570   | 573  |            |      |
| 8                           |                      |      | 572   | 575  |            |      |

**Note**

- Wavelengths are tested at a current pulse duration of 25 ms.



TYPICAL CHARACTERISTICS (T<sub>amb</sub> = 25 °C, unless otherwise specified)

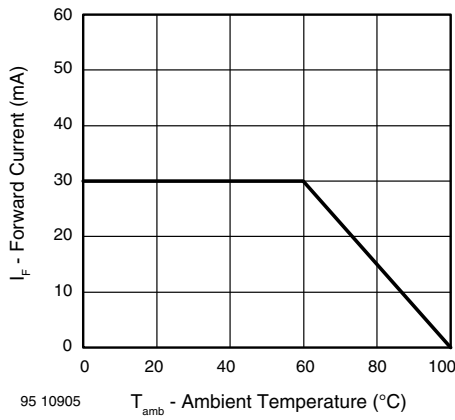

Fig. 1 - Forward Current vs. Ambient Temperature

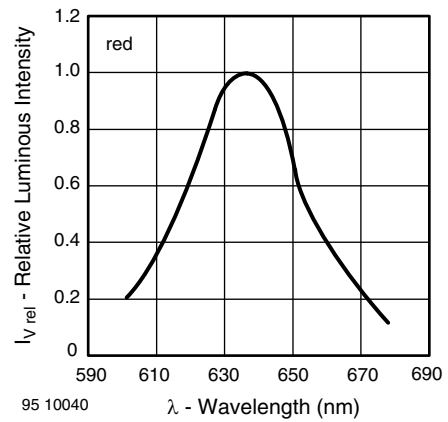

Fig. 4 - Relative Intensity vs. Wavelength

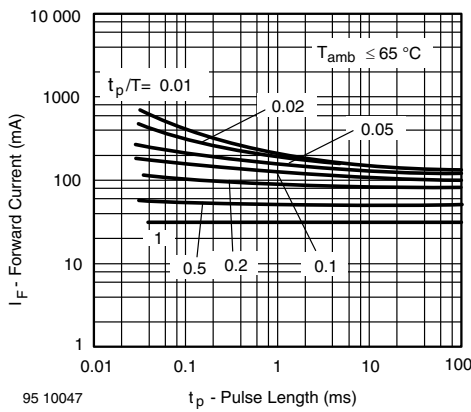

Fig. 2 - Forward Current vs. Pulse Length

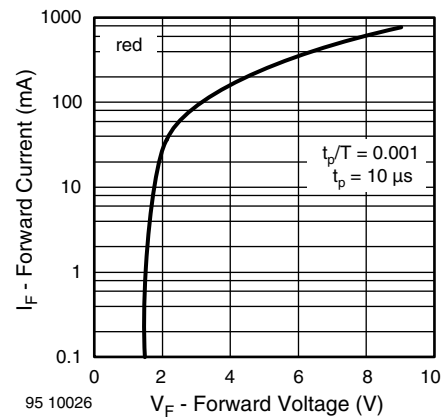

Fig. 5 - Forward Current vs. Forward Voltage

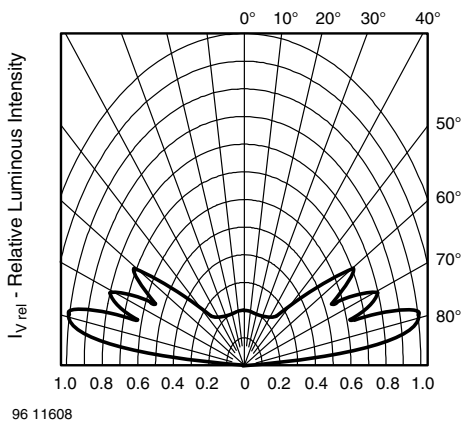

Fig. 3 - Relative Luminous Intensity vs. Angular Displacement for 90 ° Emission Angle

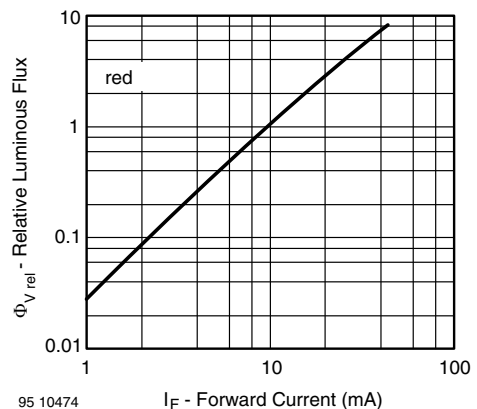

Fig. 6 - Relative Luminous Flux vs. Forward Current

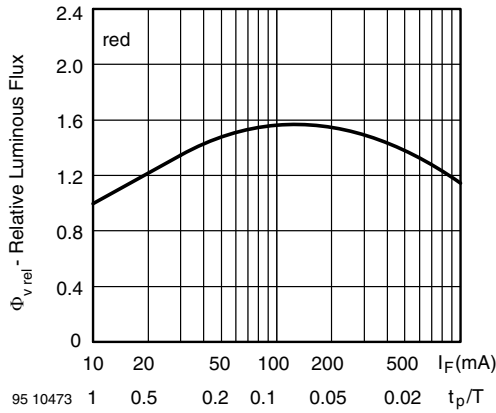

Fig. 7 - Relative Luminous Flux vs. Forward Current/Duty Cycle

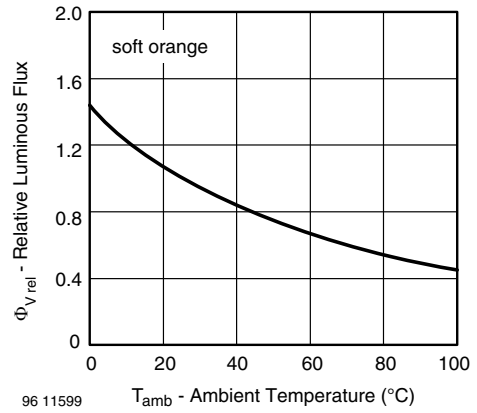

Fig. 10 - Relative Luminous Flux vs. Ambient Temperature

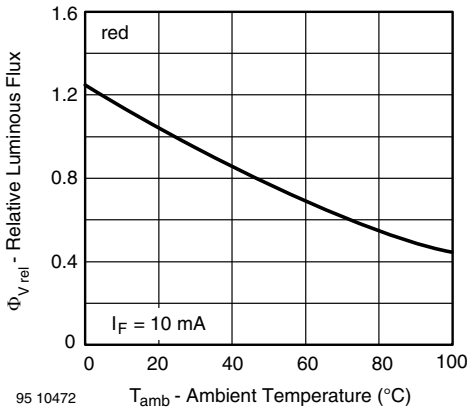

Fig. 8 - Relative Luminous Flux vs. Ambient Temperature

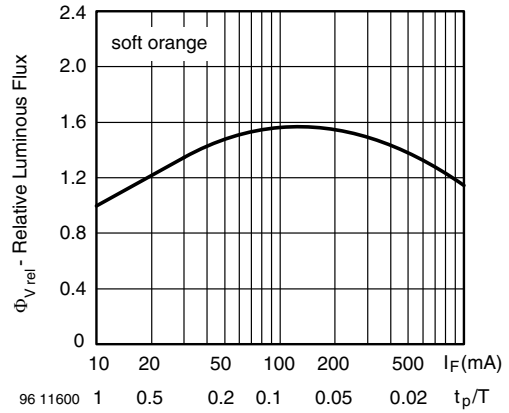

Fig. 11 - Relative Luminous Flux vs. Forward Current/Duty Cycle

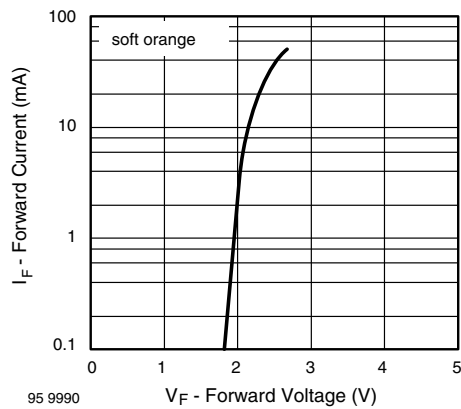

Fig. 9 - Forward Current vs. Forward Voltage

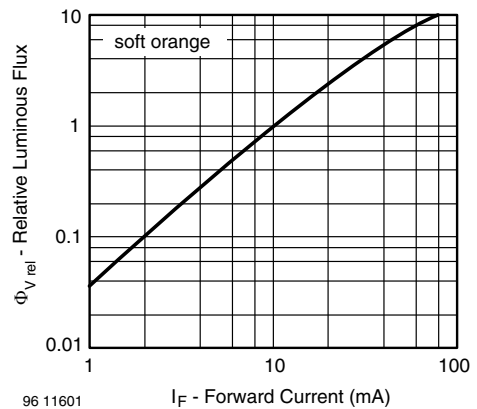

Fig. 12 - Relative Luminous Flux vs. Forward Current

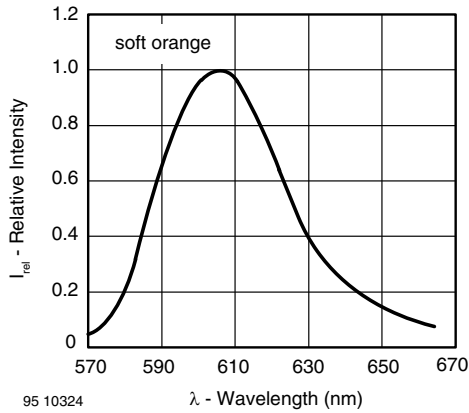

Fig. 13 - Relative Intensity vs. Wavelength

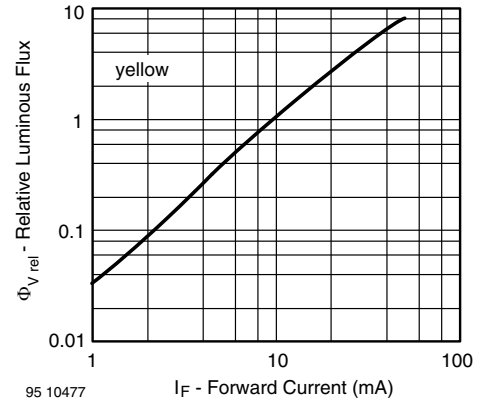

Fig. 16 - Relative Luminous Flux vs. Forward Current

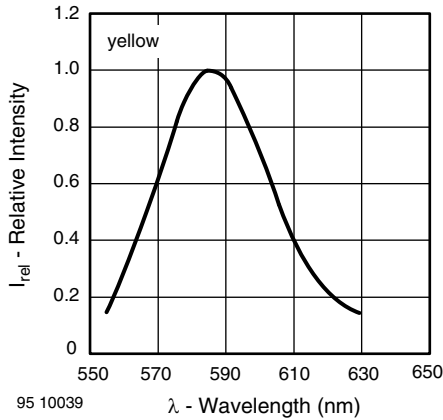

Fig. 14 - Relative Intensity vs. Wavelength

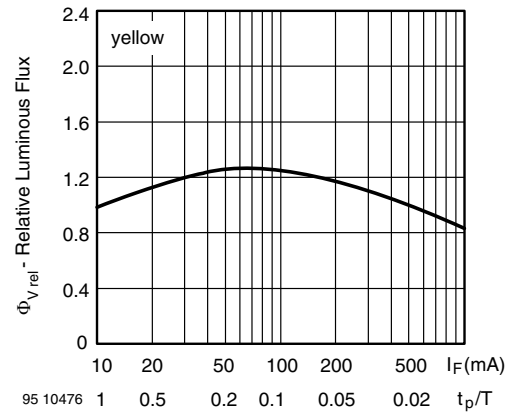

Fig. 17 - Relative Luminous Flux vs. Forward Current/Duty Cycle

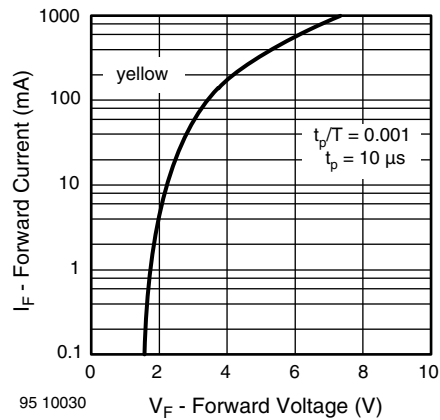

Fig. 15 - Forward Current vs. Forward Voltage

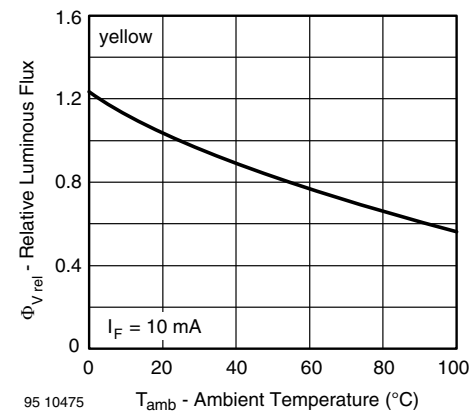

Fig. 18 - Relative Luminous Flux vs. Ambient Temperature

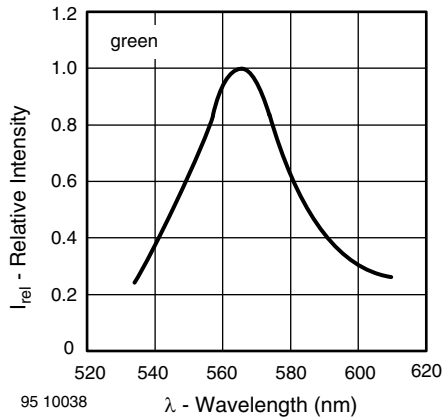

Fig. 19 - Relative Intensity vs. Wavelength

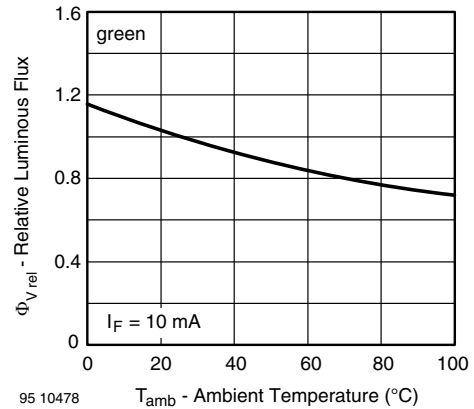

Fig. 22 - Relative Luminous Flux vs. Ambient Temperature

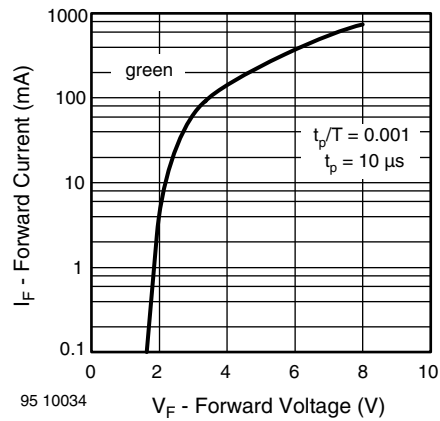

Fig. 20 - Forward Current vs. Forward Voltage

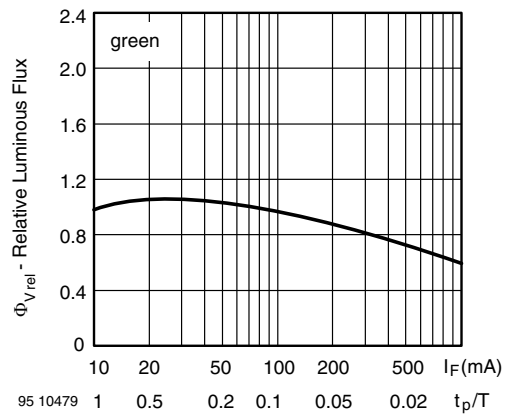

Fig. 23 - Relative Luminous Flux vs. Forward Current/Duty Cycle

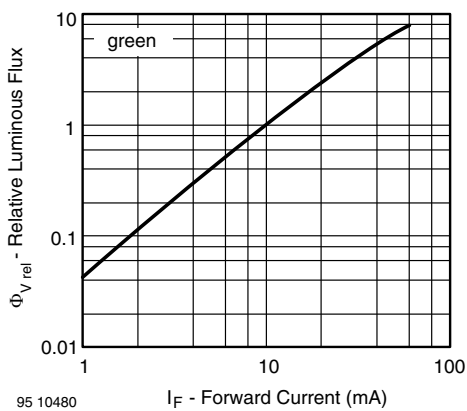

Fig. 21 - Relative Luminous Flux vs. Forward Current

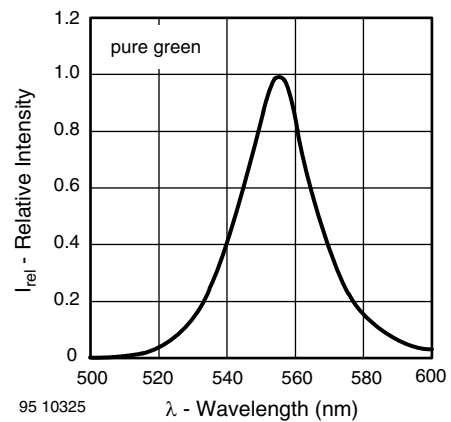

Fig. 24 - Relative Intensity vs. Wavelength

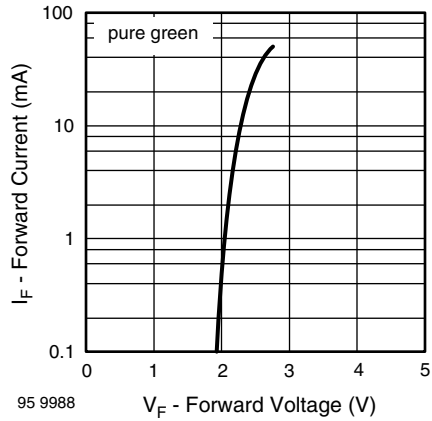

Fig. 25 - Forward Current vs. Forward Voltage

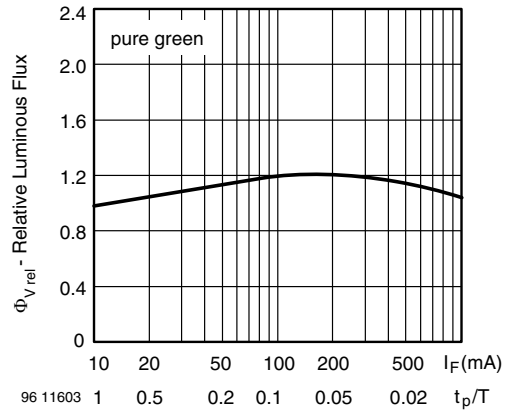

Fig. 27 - Relative Luminous Flux vs. Forward Current/Duty Cycle

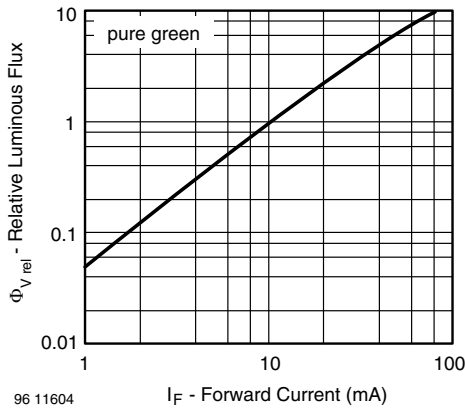

Fig. 26 - Relative Luminous Flux vs. Forward Current

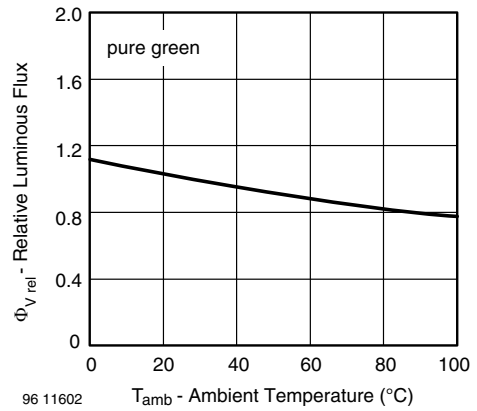
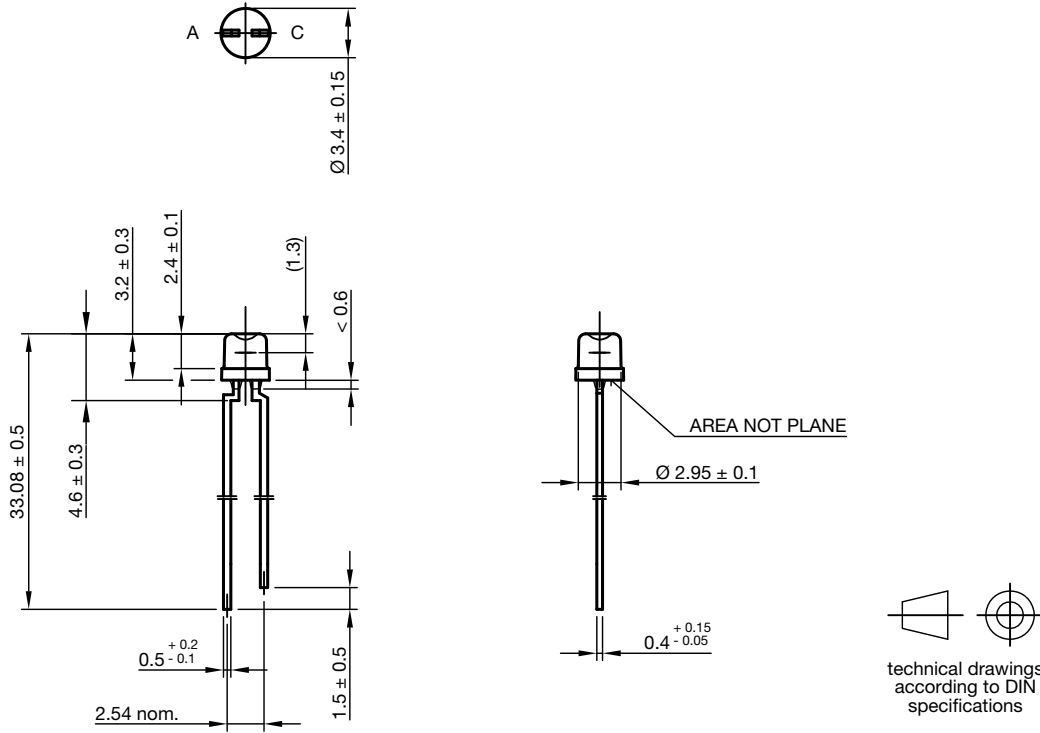

Fig. 28 - Relative Luminous Flux vs. Ambient Temperature





**PACKAGE DIMENSIONS** in millimeters



Drawing-No.: 6.544-5268.01-4  
Issue: 3; 28.07.14



## Disclaimer

ALL PRODUCT, PRODUCT SPECIFICATIONS AND DATA ARE SUBJECT TO CHANGE WITHOUT NOTICE TO IMPROVE RELIABILITY, FUNCTION OR DESIGN OR OTHERWISE.

Vishay Intertechnology, Inc., its affiliates, agents, and employees, and all persons acting on its or their behalf (collectively, "Vishay"), disclaim any and all liability for any errors, inaccuracies or incompleteness contained in any datasheet or in any other disclosure relating to any product.

Vishay makes no warranty, representation or guarantee regarding the suitability of the products for any particular purpose or the continuing production of any product. To the maximum extent permitted by applicable law, Vishay disclaims (i) any and all liability arising out of the application or use of any product, (ii) any and all liability, including without limitation special, consequential or incidental damages, and (iii) any and all implied warranties, including warranties of fitness for particular purpose, non-infringement and merchantability.

Statements regarding the suitability of products for certain types of applications are based on Vishay's knowledge of typical requirements that are often placed on Vishay products in generic applications. Such statements are not binding statements about the suitability of products for a particular application. It is the customer's responsibility to validate that a particular product with the properties described in the product specification is suitable for use in a particular application. Parameters provided in datasheets and/or specifications may vary in different applications and performance may vary over time. All operating parameters, including typical parameters, must be validated for each customer application by the customer's technical experts. Product specifications do not expand or otherwise modify Vishay's terms and conditions of purchase, including but not limited to the warranty expressed therein.

Except as expressly indicated in writing, Vishay products are not designed for use in medical, life-saving, or life-sustaining applications or for any other application in which the failure of the Vishay product could result in personal injury or death. Customers using or selling Vishay products not expressly indicated for use in such applications do so at their own risk. Please contact authorized Vishay personnel to obtain written terms and conditions regarding products designed for such applications.

No license, express or implied, by estoppel or otherwise, to any intellectual property rights is granted by this document or by any conduct of Vishay. Product names and markings noted herein may be trademarks of their respective owners.

## Material Category Policy

**Vishay Intertechnology, Inc. hereby certifies that all its products that are identified as RoHS-Compliant fulfill the definitions and restrictions defined under Directive 2011/65/EU of The European Parliament and of the Council of June 8, 2011 on the restriction of the use of certain hazardous substances in electrical and electronic equipment (EEE) - recast, unless otherwise specified as non-compliant.**

**Please note that some Vishay documentation may still make reference to RoHS Directive 2002/95/EC. We confirm that all the products identified as being compliant to Directive 2002/95/EC conform to Directive 2011/65/EU.**

**Vishay Intertechnology, Inc. hereby certifies that all its products that are identified as Halogen-Free follow Halogen-Free requirements as per JEDEC JS709A standards. Please note that some Vishay documentation may still make reference to the IEC 61249-2-21 definition. We confirm that all the products identified as being compliant to IEC 61249-2-21 conform to JEDEC JS709A standards.**

## Данный компонент на территории Российской Федерации

### Вы можете приобрести в компании MosChip.

Для оперативного оформления запроса Вам необходимо перейти по данной ссылке:

<http://moschip.ru/get-element>

Вы можете разместить у нас заказ для любого Вашего проекта, будь то серийное производство или разработка единичного прибора.

В нашем ассортименте представлены ведущие мировые производители активных и пассивных электронных компонентов.

Нашей специализацией является поставка электронной компонентной базы двойного назначения, продукции таких производителей как XILINX, Intel (ex.ALTERA), Vicor, Microchip, Texas Instruments, Analog Devices, Mini-Circuits, Amphenol, Glenair.

Сотрудничество с глобальными дистрибьюторами электронных компонентов, предоставляет возможность заказывать и получать с международных складов практически любой перечень компонентов в оптимальные для Вас сроки.

На всех этапах разработки и производства наши партнеры могут получить квалифицированную поддержку опытных инженеров.

Система менеджмента качества компании отвечает требованиям в соответствии с ГОСТ Р ИСО 9001, ГОСТ РВ 0015-002 и ЭС РД 009

### Офис по работе с юридическими лицами:

105318, г.Москва, ул.Щербаковская д.3, офис 1107, 1118, ДЦ «Щербаковский»

Телефон: +7 495 668-12-70 (многоканальный)

Факс: +7 495 668-12-70 (доб.304)

E-mail: [info@moschip.ru](mailto:info@moschip.ru)

Skype отдела продаж:

moschip.ru

moschip.ru\_4

moschip.ru\_6

moschip.ru\_9