

# 5th-Order, Lowpass, Elliptic, Switched-Capacitor Filters

## General Description

The MAX7408/MAX7411/MAX7412/MAX7415 5th-order, lowpass, elliptic, switched-capacitor filters (SCFs) operate from a single +5V (MAX7408/MAX7411) or +3V (MAX7412/MAX7415) supply. The devices draw only 1.2mA of supply current and allow corner frequencies from 1Hz to 15kHz, making them ideal for low-power post-DAC filtering and anti-aliasing applications. They can be put into a low-power mode, reducing supply current to 0.2 $\mu$ A.

Two clocking options are available: self-clocking (through the use of an external capacitor) or external clocking for tighter cutoff-frequency control. An offset-adjust pin allows for adjustment of the DC output level.

The MAX7408/MAX7412 deliver 53dB of stopband rejection and a sharp rolloff with a transition ratio of 1.6. The MAX7411/MAX7415 achieve a sharper rolloff with a transition ratio of 1.25 while still providing 37dB of stopband rejection. Their fixed response limits the design task to selecting a clock frequency.

## Applications

ADC Anti-Aliasing                      CT2 Base Stations  
Post-DAC Filtering                      Speech Processing

## Selector Guide

PART	TRANSITION RATIO	OPERATING VOLTAGE (V)
MAX7408	r = 1.6	+5
MAX7411	r = 1.25	+5
MAX7412	r = 1.6	+3
MAX7415	r = 1.25	+3

## Typical Operating Circuit



## Features

- ◆ 5th-Order, Elliptic Lowpass Filters
- ◆ Low Noise and Distortion: -80dB THD + Noise
- ◆ Clock-Tunable Corner Frequency (1Hz to 15kHz)
- ◆ Single-Supply Operation
  - +5V (MAX7408/MAX7411)
  - +3V (MAX7412/MAX7415)
- ◆ Low Power
  - 1.2mA (operating mode)
  - 0.2 $\mu$ A (shutdown mode)
- ◆ Available in 8-Pin  $\mu$ MAX/DIP Packages
- ◆ Low Output Offset:  $\pm$ 4mV

## Ordering Information

PART	TEMP. RANGE	PIN-PACKAGE
MAX7408CPA	0°C to +70°C	8 Plastic DIP
MAX7408CUA	0°C to +70°C	8 $\mu$ MAX
MAX7408EPA	-40°C to +85°C	8 Plastic DIP
MAX7408EUA	-40°C to +85°C	8 $\mu$ MAX
MAX7411CPA	0°C to +70°C	8 Plastic DIP
MAX7411CUA	0°C to +70°C	8 $\mu$ MAX
MAX7411EPA	-40°C to +85°C	8 Plastic DIP
MAX7411EUA	-40°C to +85°C	8 $\mu$ MAX
MAX7412CPA	0°C to +70°C	8 Plastic DIP
MAX7412CUA	0°C to +70°C	8 $\mu$ MAX
MAX7412EPA	-40°C to +85°C	8 Plastic DIP
MAX7412EUA	-40°C to +85°C	8 $\mu$ MAX
MAX7415CPA	0°C to +70°C	8 Plastic DIP
MAX7415CUA	0°C to +70°C	8 $\mu$ MAX
MAX7415EPA	-40°C to +85°C	8 Plastic DIP
MAX7415EUA	-40°C to +85°C	8 $\mu$ MAX

## Pin Configuration



# 5th-Order, Lowpass, Elliptic, Switched-Capacitor Filters

## ABSOLUTE MAXIMUM RATINGS

V <sub>DD</sub> to GND	-0.3V to +6V
IN, OUT, COM, OS, CLK, $\overline{\text{SHDN}}$	-0.3V to (V <sub>DD</sub> + 0.3V)
OUT Short-Circuit Duration	1sec
Continuous Power Dissipation (T <sub>A</sub> = +70°C)	
8-Pin DIP (derate 6.90mW/°C above +70°C)	552mW
8-Pin $\mu$ MAX (derate 4.1mW/°C above +70°C)	330mW

## Operating Temperature Ranges

MAX74_ _C_A	0°C to +70°C
MAX74_ _E_A	-40°C to +85°C
Storage Temperature Range	-65°C to +160°C
Lead Temperature (soldering, 10sec)	+300°C

Stresses beyond those listed under "Absolute Maximum Ratings" may cause permanent damage to the device. These are stress ratings only, and functional operation of the device at these or any other conditions beyond those indicated in the operational sections of the specifications is not implied. Exposure to absolute maximum rating conditions for extended periods may affect device reliability.

## ELECTRICAL CHARACTERISTICS—MAX7408/MAX7411

(V<sub>DD</sub> = +5V; filter output measured at OUT, 10k $\Omega$  || 50pF load to GND at OUT,  $\overline{\text{SHDN}}$  = V<sub>DD</sub>, OS = COM, 0.1 $\mu$ F from COM to GND, f<sub>CLK</sub> = 100kHz, T<sub>A</sub> = T<sub>MIN</sub> to T<sub>MAX</sub>, unless otherwise noted. Typical values are at T<sub>A</sub> = +25°C.)

PARAMETER	SYMBOL	CONDITIONS	MIN	TYP	MAX	UNITS
<b>FILTER</b>						
Corner-Frequency Range	f <sub>C</sub>	(Note 1)		0.001 to 15		kHz
Clock-to-Corner Ratio	f <sub>CLK</sub> /f <sub>C</sub>			100:1		
Clock-to-Corner Tempco				10		ppm/°C
Output Voltage Range			0.25		V <sub>DD</sub> - 0.25	V
Output Offset Voltage	V <sub>OFFSET</sub>	V <sub>IN</sub> = V <sub>COM</sub> = V <sub>DD</sub> / 2		±4	±25	mV
DC Insertion Gain with Output Offset Removed		V <sub>COM</sub> = V <sub>DD</sub> / 2 (Note 2)	0	0.2	0.4	dB
Total Harmonic Distortion plus Noise	THD+N	f <sub>IN</sub> = 200Hz, V <sub>IN</sub> = 4Vp-p, measurement bandwidth = 22kHz		-81		dB
Offset Voltage Gain	A <sub>OS</sub>	OS to OUT		1		V/V
COM Voltage Range	V <sub>COM</sub>	Input, COM externally driven	$\frac{V_{DD}}{2} - 0.5$	$\frac{V_{DD}}{2}$	$\frac{V_{DD}}{2} + 0.5$	V
		Output, COM internally driven	$\frac{V_{DD}}{2} - 0.2$	$\frac{V_{DD}}{2}$	$\frac{V_{DD}}{2} + 0.2$	
Input Voltage Range at OS	V <sub>OS</sub>	Measured with respect to COM		±0.1		V
Input Resistance at COM	R <sub>COM</sub>		110	180		k $\Omega$
Clock Feedthrough		T <sub>A</sub> = +25°C		5		mVp-p
Resistive Output Load Drive	R <sub>L</sub>		10	1		k $\Omega$
Maximum Capacitive Load at OUT	C <sub>L</sub>		50	500		pF
Input Leakage Current at COM		$\overline{\text{SHDN}}$ = GND, V <sub>COM</sub> = 0 to V <sub>DD</sub>		±0.2	±10	$\mu$ A
Input Leakage Current at OS		V <sub>OS</sub> = 0 to V <sub>DD</sub>		±0.2	±10	$\mu$ A
<b>CLOCK</b>						
Internal Oscillator Frequency	f <sub>OSC</sub>	C <sub>OSC</sub> = 1000pF (Note 3)	19	27	34	kHz
Clock Output Current (Internal Oscillator Mode)	I <sub>CLK</sub>			±12	±20	$\mu$ A
Clock Input High	V <sub>IH</sub>		4.5			V
Clock Input Low	V <sub>IL</sub>				0.5	V

# 5th-Order, Lowpass, Elliptic, Switched-Capacitor Filters

MAX7408/MAX7411/MAX7412/MAX7415

## ELECTRICAL CHARACTERISTICS—MAX7408/MAX7411 (continued)

( $V_{DD} = +5V$ ; filter output measured at OUT,  $10k\Omega$  ||  $50pF$  load to GND at OUT,  $\overline{SHDN} = V_{DD}$ , OS = COM,  $0.1\mu F$  from COM to GND,  $f_{CLK} = 100kHz$ ,  $T_A = T_{MIN}$  to  $T_{MAX}$ , unless otherwise noted. Typical values are at  $T_A = +25^\circ C$ .)

PARAMETER	SYMBOL	CONDITIONS	MIN	TYP	MAX	UNITS
<b>POWER REQUIREMENTS</b>						
Supply Voltage	$V_{DD}$		4.5		5.5	V
Supply Current	$I_{DD}$	Operating mode, no load		1.16	1.5	mA
Shutdown Current	$I_{\overline{SHDN}}$	$\overline{SHDN} = GND$		0.2	1	$\mu A$
Power-Supply Rejection Ratio	PSRR	Measured at DC		70		dB
<b>SHUTDOWN</b>						
$\overline{SHDN}$ Input High	$V_{SDH}$		4.5			V
$\overline{SHDN}$ Input Low	$V_{SDL}$				0.5	V
$\overline{SHDN}$ Input Leakage Current		$V_{\overline{SHDN}} = 0$ to $V_{DD}$		$\pm 0.2$	$\pm 10$	$\mu A$

## ELECTRICAL CHARACTERISTICS—MAX7412/MAX7415

( $V_{DD} = +3V$ , filter output measured at OUT pin,  $10k\Omega$  ||  $50pF$  load to GND at OUT,  $\overline{SHDN} = V_{DD}$ , OS = COM,  $0.1\mu F$  from COM to GND,  $f_{CLK} = 100kHz$ ;  $T_A = T_{MIN}$  to  $T_{MAX}$ , unless otherwise noted. Typical values are at  $T_A = +25^\circ C$ .)

PARAMETER	SYMBOL	CONDITIONS	MIN	TYP	MAX	UNITS
<b>FILTER CHARACTERISTICS</b>						
Corner-Frequency Range	$f_C$	(Note 1)		0.001 to 15		kHz
Clock-to-Corner Ratio	$f_{CLK}/f_C$			100:1		
Clock-to-Corner Tempco				10		ppm/ $^\circ C$
Output Voltage Range			0.25		$V_{DD} - 0.25$	V
Output Offset Voltage	$V_{OFFSET}$	$V_{IN} = V_{COM} = V_{DD} / 2$		$\pm 4$	$\pm 25$	mV
DC Insertion Gain with Output Offset Removed		$V_{COM} = V_{DD} / 2$ (Note 2)	0	0.2	0.4	dB
Total Harmonic Distortion plus Noise	THD+N	$f_{IN} = 200Hz$ , $V_{IN} = 2.5Vp-p$ , measurement bandwidth = 22kHz		-79		dB
Offset Voltage Gain	$A_{OS}$	OS to OUT		1		V/V
COM Voltage Range	$V_{COM}$		$\frac{V_{DD}}{2} - 0.1$	$\frac{V_{DD}}{2}$	$\frac{V_{DD}}{2} + 0.1$	V
Input Voltage Range at OS	$V_{OS}$	Measured with respect to COM		$\pm 0.1$		V
Input Resistance at COM	$R_{COM}$		110	180		$k\Omega$
Clock Feedthrough		$T_A = +25^\circ C$		3		mVp-p
Resistance Output Load Drive	$R_L$		10	1		$k\Omega$
Maximum Capacitive Load at OUT	$C_L$		50	500		pF
Input Leakage Current at COM		$\overline{SHDN} = GND$ , $V_{COM} = 0$ to $V_{DD}$		$\pm 0.2$	$\pm 10$	$\mu A$
Input Leakage Current at OS		$V_{OS} = 0$ to $V_{DD}$		$\pm 0.2$	$\pm 10$	$\mu A$

## 5th-Order, Lowpass, Elliptic, Switched-Capacitor Filters

### ELECTRICAL CHARACTERISTICS—MAX7412/MAX7415 (continued)

( $V_{DD} = +3V$ , filter output measured at OUT pin,  $10k\Omega \parallel 50pF$  load to GND at OUT,  $\overline{SHDN} = V_{DD}$ , OS = COM,  $0.1\mu F$  from COM to GND,  $f_{CLK} = 100kHz$ ;  $T_A = T_{MIN}$  to  $T_{MAX}$ , unless otherwise noted. Typical values are at  $T_A = +25^\circ C$ .)

PARAMETER	SYMBOL	CONDITIONS	MIN	TYP	MAX	UNITS
<b>CLOCK</b>						
Internal Oscillator Frequency	$f_{OSC}$	$C_{OSC} = 1000pF$ (Note 3)	19	27	34	kHz
Clock Output Current (Internal Oscillator Mode)	$I_{CLK}$	$V_{CLK} = 0$ or $3V$		$\pm 12$	$\pm 20$	$\mu A$
Clock Input High	$V_{IH}$		2.5			V
Clock Input Low	$V_{IL}$				0.5	V
<b>POWER REQUIREMENTS</b>						
Supply Voltage	$V_{DD}$		2.7		3.6	V
Supply Current	$I_{DD}$	Operating mode, no load		1.13	1.5	mA
Shutdown Current	$I_{\overline{SHDN}}$	$\overline{SHDN} = GND$		0.2	1	$\mu A$
Power-Supply Rejection Ratio	PSRR	Measured at DC		70		dB
<b>SHUTDOWN</b>						
$\overline{SHDN}$ Input High	$V_{SDH}$		2.5			V
$\overline{SHDN}$ Input Low	$V_{SDL}$				0.5	V
$\overline{SHDN}$ Input Leakage Current		$V_{\overline{SHDN}} = 0$ to $V_{DD}$		$\pm 0.2$	$\pm 10$	$\mu A$

### ELLIPTIC FILTER ( $r = 1.6$ ) CHARACTERISTICS—MAX7408/MAX7412

( $V_{DD} = +5V$  for MAX7408,  $V_{DD} = +3V$  for MAX7412; filter output measured at OUT;  $10k\Omega \parallel 50pF$  load to GND at OUT;  $\overline{SHDN} = V_{DD}$ ;  $V_{COM} = V_{OS} = V_{DD} / 2$ ;  $f_{CLK} = 100kHz$ ;  $T_A = T_{MIN}$  to  $T_{MAX}$ ; unless otherwise noted. Typical values are at  $T_A = +25^\circ C$ .) (Note 3)

PARAMETER	CONDITIONS	MIN	TYP	MAX	UNITS
Insertion Gain with DC Gain Error Removed (Note 4)	$f_{IN} = 0.34f_C$	-0.4	-0.2	0.4	dB
	$f_{IN} = 0.63f_C$	-0.4	0.2	0.4	
	$f_{IN} = 0.84f_C$	-0.4	-0.2	0.4	
	$f_{IN} = 0.96f_C$	-0.4	0.2	0.4	
	$f_{IN} = f_C$	-0.7	-0.2	0.2	
	$f_{IN} = 1.60f_C$		-53.4	-50	
	$f_{IN} = 1.90f_C$		-53.4	-50	
	$f_{IN} = 4.62f_C$		-53.4	-50	

# 5th-Order, Lowpass, Elliptic, Switched-Capacitor Filters

MAX7408/MAX7411/MAX7412/MAX7415

## ELLIPTIC FILTER ( $r = 1.25$ ) CHARACTERISTICS—MAX7411/MAX7415

( $V_{DD} = +5V$  for MAX7411,  $V_{DD} = +3V$  for MAX7415; filter output measured at OUT;  $10k\Omega \parallel 50pF$  load to GND at OUT;  $\overline{SHDN} = V_{DD}$ ,  $V_{COM} = V_{OS} = V_{DD} / 2$ ;  $f_{CLK} = 100kHz$ ;  $T_A = T_{MIN}$  to  $T_{MAX}$ ; unless otherwise noted. Typical values are at  $T_A = +25^\circ C$ .) (Note 3)

PARAMETER	CONDITIONS	MIN	TYP	MAX	UNITS
Insertion Gain with DC Gain Error Removed (Note 4)	$f_{IN} = 0.38f_C$	-0.4	-0.2	0.4	dB
	$f_{IN} = 0.68f_C$	-0.4	0.2	0.4	
	$f_{IN} = 0.87f_C$	-0.4	-0.2	0.4	
	$f_{IN} = 0.97f_C$	-0.4	0.2	0.4	
	$f_{IN} = f_C$	-0.7	-0.2	0.2	
	$f_{IN} = 1.25f_C$		-38.5	-34	
	$f_{IN} = 1.43f_C$		-37.2	-35	
	$f_{IN} = 3.25f_C$		-37.2	-35	

**Note 1:** The maximum  $f_C$  is defined as the clock frequency  $f_{CLK} = 100 \cdot f_C$  at which the peak SINAD drops to 68dB with a sinusoidal input at  $0.2f_C$ .

**Note 2:** DC insertion gain is defined as  $\Delta V_{OUT} / \Delta V_{IN}$ .

**Note 3:**  $f_{OSC}$  (kHz)  $\approx 27 \cdot 10^3 / C_{OSC}$  ( $C_{OSC}$  in pF).

**Note 4:** The input frequencies,  $f_{IN}$ , are selected at the peaks and troughs of the ideal elliptic frequency responses.

## Typical Operating Characteristics

( $V_{DD} = +5V$  for MAX7408/MAX7411,  $V_{DD} = +3V$  for MAX7412/MAX7415;  $f_{CLK} = 100kHz$ ;  $\overline{SHDN} = V_{DD}$ ;  $V_{COM} = V_{OS} = V_{DD} / 2$ ;  $T_A = +25^\circ C$ ; unless otherwise noted.)



# 5th-Order, Lowpass, Elliptic, Switched-Capacitor Filters

## Typical Operating Characteristics (continued)

( $V_{DD} = +5V$  for MAX7408/MAX7411,  $V_{DD} = +3V$  for MAX7412/MAX7415;  $f_{CLK} = 100kHz$ ;  $\overline{SHDN} = V_{DD}$ ;  $V_{COM} = V_{OS} = V_{DD} / 2$ ;  $T_A = +25^\circ C$ ; unless otherwise noted.)

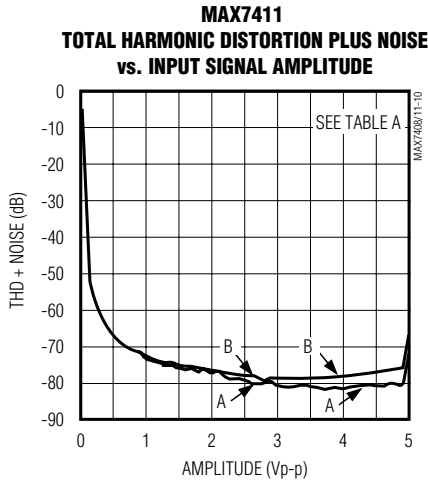
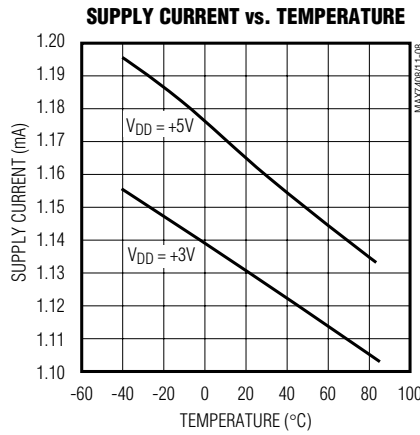
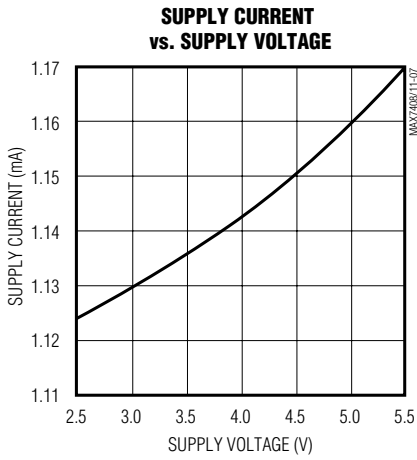

**Table A. THD + Noise Test Conditions**

LABEL	$f_{IN}$ (Hz)	$f_C$ (kHz)	$f_{CLK}$ (kHz)	MEASUREMENT BANDWIDTH (kHz)
A	200	1	100	22
B	1k	5	500	80

# 5th-Order, Lowpass, Elliptic, Switched-Capacitor

## Typical Operating Characteristics (continued)

( $V_{DD} = +5V$  for MAX7408/MAX7411,  $V_{DD} = +3V$  for MAX7412/MAX7415;  $f_{CLK} = 100kHz$ ;  $\overline{SHDN} = V_{DD}$ ;  $V_{COM} = V_{OS} = V_{DD} / 2$ ;  $T_A = +25^\circ C$ ; unless otherwise noted.)

MAX7408/MAX7411/MAX7412/MAX7415

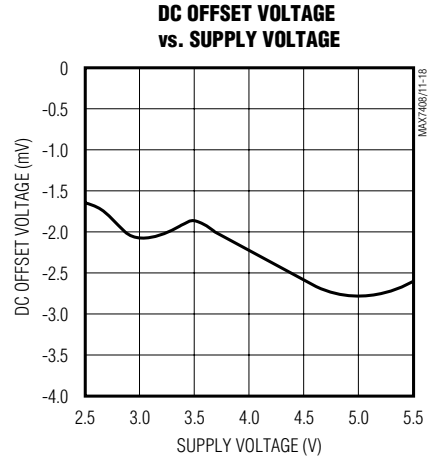
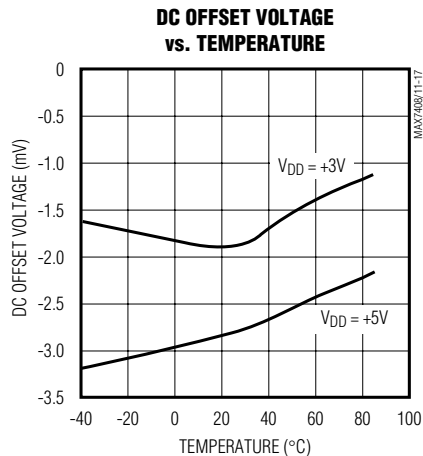
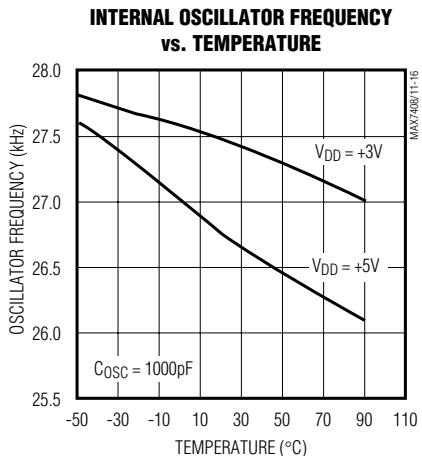
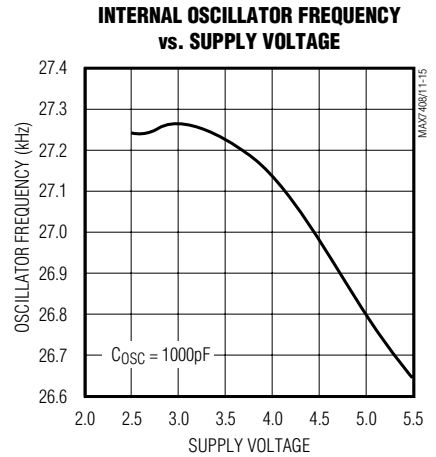
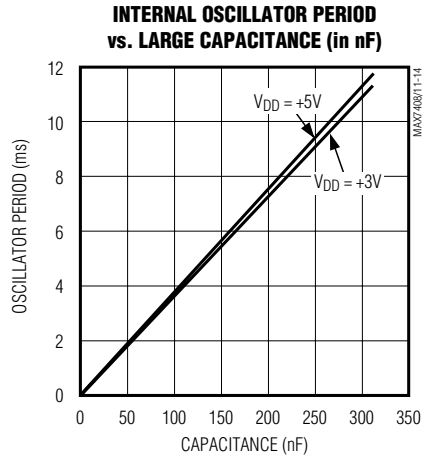
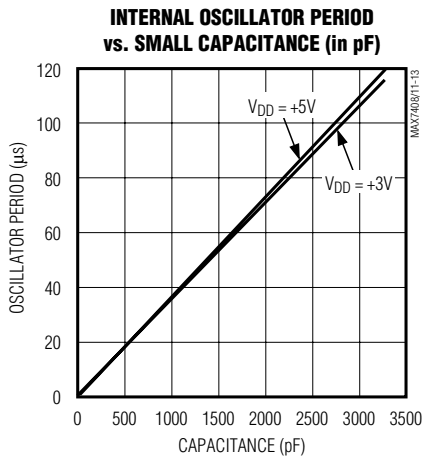
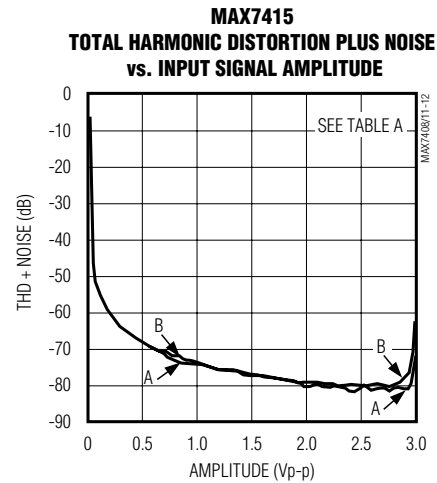
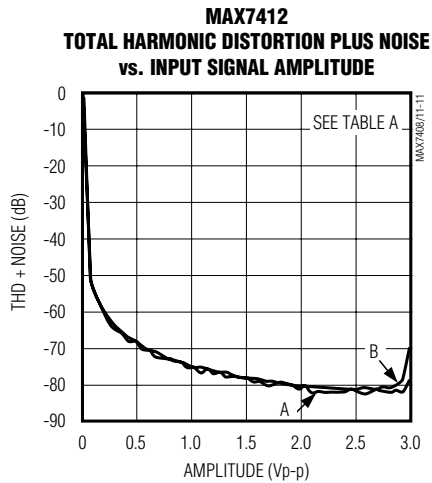

# 5th-Order, Lowpass, Elliptic, Switched-Capacitor Filters

## Pin Description

PIN	NAME	FUNCTION
1	COM	Common Input Pin. Biased internally at mid-supply. Bypass externally to GND with 0.1 $\mu$ F capacitor. To override internal biasing, drive with an external supply.
2	IN	Filter Input
3	GND	Ground
4	V <sub>DD</sub>	Positive Supply Input, +5V for MAX7408/MAX7411 or +3V for MAX7412/MAX7415
5	OUT	Filter Output
6	OS	Offset Adjust Input. To adjust output offset, bias OS with a resistive voltage-divider between an external supply and ground. Connect OS to COM if no offset adjustment is needed.
7	$\overline{\text{SHDN}}$	Shutdown Input. Drive low to enable shutdown mode; drive high or connect to V <sub>DD</sub> for normal operation.
8	CLK	Clock Input. Connect an external capacitor (C <sub>OSC</sub> ) from CLK to GND to set the internal oscillator frequency. To override the internal oscillator, connect to an external clock.

## Detailed Description

The MAX7408/MAX7411/MAX7412/MAX7415 family of 5th-order, elliptic, lowpass filters provides sharp rolloff with good stopband rejection. All parts operate with a 100:1 clock-to-corner frequency ratio and a 15kHz maximum corner frequency.

Most switched-capacitor filters (SCFs) are designed with biquadratic sections. Each section implements two pole-zero pairs, and the sections can be cascaded to produce higher order filters. The advantage to this approach is ease of design. However, this type of design is highly sensitive to component variations if any section's Q is high. The MAX7408/MAX7411/MAX7412/MAX7415 use an alternative approach, which is to emulate a passive network using switched-capacitor integrators with summing and scaling. The passive network may be synthesized using CAD programs, or may be found in many filter books. Figure 1 shows a basic 5th-order ladder elliptic filter structure.

A switched-capacitor filter that emulates a passive ladder filter retains many of the same advantages. The component sensitivity of a passive ladder filter is low when compared to a cascaded biquadratic design,



Figure 1. 5th-Order Ladder Elliptic Filter Network

because each component affects the entire filter shape rather than a single pole-zero pair. In other words, a mismatched component in a biquadratic design has a concentrated error on its respective poles, while the same mismatch in a ladder filter design spreads its error over all poles.

## Elliptic Characteristics

Lowpass elliptic filters such as the MAX7408/MAX7411/MAX7412/MAX7415 provide the steepest possible rolloff with frequency of the four most common filter types (Butterworth, Bessel, Chebyshev, and elliptic). The high Q value of the poles near the passband edge combined with the stopband zeros allows for the sharp attenuation characteristic of elliptic filters, making these devices ideal for anti-aliasing and post-DAC filtering in single-supply systems (see the *Anti-Aliasing and Post-DAC Filtering* section).

In the frequency domain, the first transmission zero causes the filter's amplitude to drop to a minimum level. Beyond this zero, the response rises as the frequency increases until the next transmission zero. The stopband begins at the stopband frequency,  $f_s$ . At frequencies above  $f_s$ , the filter's gain does not exceed the gain at  $f_s$ . The corner frequency,  $f_c$ , is defined as the point where the filter output attenuation falls just below the passband ripple. The transition ratio ( $r$ ) is defined as the ratio of the stopband frequency to the corner frequency:

$$r = f_s / f_c$$

The MAX7408/MAX7412 have a transition ratio of 1.6 and typically 53dB of stopband rejection. The MAX7411/MAX7415 have a transition ratio of 1.25 (providing a steeper rolloff) and typically 37dB of stopband rejection.



# 5th-Order, Lowpass, Elliptic, Switched-Capacitor Filters

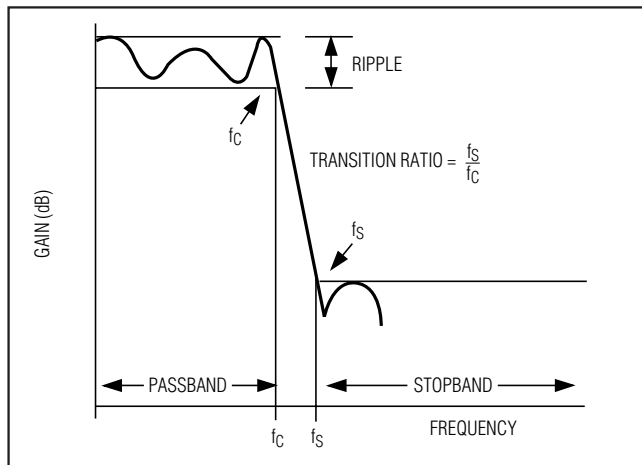

Figure 2. Elliptic Filter Response

## Clock Signal

### External Clock

These SCFs are designed for use with external clocks that have a 40% to 60% duty cycle. When using an external clock, drive the CLK pin with a CMOS gate powered from 0 to V<sub>DD</sub>. Varying the rate of the external clock adjusts the corner frequency of the filter:

$$f_c = \frac{f_{CLK}}{100}$$

### Internal Clock

When using the internal oscillator, the capacitance (C<sub>OSC</sub>) on CLK determines the oscillator frequency:

$$f_{OSC}(kHz) = \frac{k}{C_{OSC}(pF)}$$

Since C<sub>OSC</sub> is in the low picofarads, minimize the stray capacitance at CLK so that it does not affect the internal oscillator frequency. Varying the rate of the internal oscillator adjusts the filter's corner frequency by a 100:1 clock-to-corner frequency ratio. For example, an internal oscillator frequency of 100kHz produces a nominal corner frequency of 1kHz.

### Input Impedance vs. Clock Frequencies

The MAX7408/MAX7411/MAX7412/MAX7415's input impedance is effectively that of a switched-capacitor resistor (see the following equation), and is inversely proportional to frequency. The input impedance values determined by the equation represent the average input impedance, since the input current is not continuous. As a rule, use a driver with an output resistance less than 10% of the filter's input impedance.

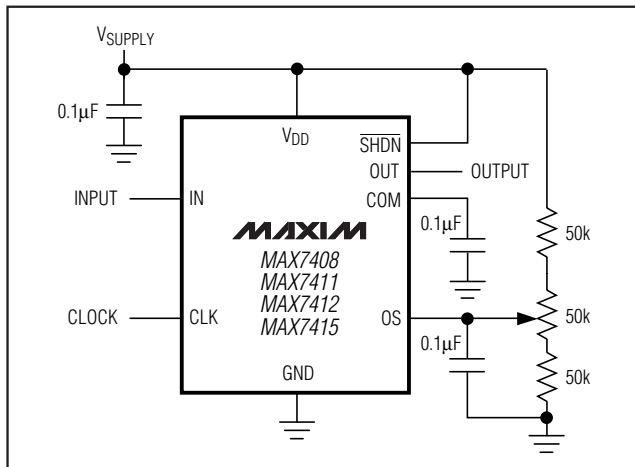

Figure 3. Offset Adjustment Circuit

Estimate the input impedance of the filter by using the following formula:

$$Z_{IN} = \frac{1}{(f_{CLK} \times C_{IN})}$$

where  $f_{CLK}$  = clock frequency and  $C_{IN}$  = 1pF.

### Low-Power Shutdown Mode

The MAX7408/MAX7411/MAX7412/MAX7415 have a shutdown mode that is activated by driving  $\overline{SHDN}$  low. In shutdown mode, the filter supply current reduces to 0.2µA, and the output of the filter becomes high impedance. For normal operation, drive  $\overline{SHDN}$  high or connect to V<sub>DD</sub>.

## Applications Information

### Offset (OS) and Common-Mode (COM) Input Adjustment

COM sets the common-mode input voltage and is biased at mid-supply with an internal resistor-divider. If the application does not require offset adjustment, connect OS to COM. For applications where offset adjustment is required, apply an external bias voltage through a resistor-divider network to OS, as shown in Figure 3. For applications that require DC level shifting, adjust OS with respect to COM. (Note: Do not leave OS unconnected.) The output voltage is represented by these equations:

$$V_{OUT} = (V_{IN} - V_{COM}) + V_{OS}$$

$$V_{COM} = \frac{V_{DD}}{2} \text{ (typical)}$$

where  $(V_{IN} - V_{COM})$  is lowpass filtered by the SCF and OS is added at the output stage. See the *Electrical*

# 5th-Order, Lowpass, Elliptic, Switched-Capacitor Filters

Characteristics table for the input voltage range of COM and OS. Changing the voltage on COM or OS significantly from mid-supply reduces the dynamic range.

### Power Supplies

The MAX7408/MAX7411 operate from a single +5V supply and the MAX7412/MAX7415 operate from a single +3V supply. Bypass  $V_{DD}$  to GND with a 0.1 $\mu$ F capacitor. If dual supplies are required, connect COM to the system ground and GND to the negative supply. Figure 5 shows an example of dual-supply operation. Single-supply and dual-supply performance are equivalent. For either single-supply or dual-supply operation, drive CLK and SHDN from GND ( $V_-$  in dual supply operation) to  $V_{DD}$ . Use the MAX7408/MAX7411 for  $\pm 2.5$ , and use the MAX7412/MAX7415 for  $\pm 1.5$ V. For  $\pm 5$ V dual-supply applications, see the MAX291/MAX292/MAX295/MAX296 and MAX293/MAX294/MAX297 data sheets.

### Input Signal Amplitude Range

The optimal input signal range is determined by observing the voltage level at which the signal-to-noise plus distortion (SINAD) ratio is maximized for a given corner frequency. The *Typical Operating Characteristics* show the THD+Noise response as the input signal's peak-to-peak amplitude is varied.

### Anti-Aliasing and Post-DAC Filtering

When using the MAX7408/MAX7411/MAX7412/MAX7415 for anti-aliasing or post-DAC filtering, synchronize the DAC (or ADC) and the filter clocks. If the



Figure 5. Dual-Supply Operation

clocks are not synchronized, beat frequencies may alias into the desired passband.

### Harmonic Distortion

Harmonic distortion arises from nonlinearities within the filter. These nonlinearities generate harmonics when a pure sine wave is applied to the filter input. Table 1 lists typical harmonic distortion values with a 10k $\Omega$  load at  $T_A = +25^\circ\text{C}$ .

Table 1. Typical Harmonic Distortion

FILTER	f <sub>CLK</sub> (kHz)	f <sub>IN</sub> (Hz)	V <sub>IN</sub> (V <sub>p-p</sub> )	TYPICAL HARMONIC DISTORTION (dB)			
				2nd	3rd	4th	5th
MAX7408	500	1k	4	TBD	TBD	TBD	TBD
	100	200		TBD	TBD	TBD	TBD
MAX7411	500	1k	4	TBD	TBD	TBD	TBD
	100	200		TBD	TBD	TBD	TBD
MAX7412	500	1k	2	TBD	TBD	TBD	TBD
	100	200		TBD	TBD	TBD	TBD
MAX7415	500	1k	2	TBD	TBD	TBD	TBD
	100	200		TBD	TBD	TBD	TBD

# 5th-Order, Lowpass, Elliptic, Switched-Capacitor Filters

## Chip Information

TRANSISTOR COUNT: 1457

## Package Information



MAX7408/MAX7411/MAX7412/MAX7415

# 5th-Order, Lowpass, Elliptic, Switched-Capacitor Filters

## Package Information (continued)

	INCHES		MILLIMETERS	
	MIN	MAX	MIN	MAX
A	---	0.200	---	5.08
A1	0.015	---	0.38	---
A2	0.125	0.175	3.18	4.45
A3	0.055	0.080	1.40	2.03
B	0.016	0.022	0.41	0.56
B1	0.045	0.065	1.14	1.65
C	0.008	0.012	0.20	0.30
D1	0.005	0.080	0.13	2.03
E	0.300	0.325	7.62	8.26
E1	0.240	0.310	6.10	7.87
e	0.100	---	2.54	---
eA	0.300	---	7.62	---
eB	---	0.400	---	10.16
L	0.115	0.150	2.92	3.81

	INCHES		MILLIMETERS		N	MS001
	MIN	MAX	MIN	MAX		
D	0.348	0.390	8.84	9.91	8	AB
D	0.735	0.765	18.67	19.43	14	AC
D	0.745	0.765	18.92	19.43	16	AA
D	0.885	0.915	22.48	23.24	18	AD
D	1.015	1.045	25.78	26.54	20	AE
D	1.14	1.265	28.96	32.13	24	AF
D	1.360	1.380	34.54	35.05	28	*5

NOTES:  
 1. D&E DO NOT INCLUDE MOLD FLASH  
 2. MOLD FLASH OR PROTRUSIONS NOT TO EXCEED .15mm (.006")  
 3. CONTROLLING DIMENSION: MILLIMETER  
 4. MEETS JEDEC MS001-XX AS SHOWN IN ABOVE TABLE  
 5. SIMILAR TO JEDEC MO-058AB  
 6. N = NUMBER OF PINS

**MAXIM** 120 SAN GABRIEL DR. SUNNYVALE CA 94086 TEL: 408 737 7700 PROPRIETARY INFORMATION

PACKAGE FAMILY OUTLINE: PDIP .300" 1/1

21-0043 A DOCUMENT CONTROL NUMBER REV

Maxim cannot assume responsibility for use of any circuitry other than circuitry entirely embodied in a Maxim product. No circuit patent licenses are implied. Maxim reserves the right to change the circuitry and specifications without notice at any time.

12 **Maxim Integrated Products, 120 San Gabriel Drive, Sunnyvale, CA 94086 408-737-7600**

## Данный компонент на территории Российской Федерации

### Вы можете приобрести в компании MosChip.

Для оперативного оформления запроса Вам необходимо перейти по данной ссылке:

<http://moschip.ru/get-element>

Вы можете разместить у нас заказ для любого Вашего проекта, будь то серийное производство или разработка единичного прибора.

В нашем ассортименте представлены ведущие мировые производители активных и пассивных электронных компонентов.

Нашей специализацией является поставка электронной компонентной базы двойного назначения, продукции таких производителей как XILINX, Intel (ex.ALTERA), Vicor, Microchip, Texas Instruments, Analog Devices, Mini-Circuits, Amphenol, Glenair.

Сотрудничество с глобальными дистрибьюторами электронных компонентов, предоставляет возможность заказывать и получать с международных складов практически любой перечень компонентов в оптимальные для Вас сроки.

На всех этапах разработки и производства наши партнеры могут получить квалифицированную поддержку опытных инженеров.

Система менеджмента качества компании отвечает требованиям в соответствии с ГОСТ Р ИСО 9001, ГОСТ РВ 0015-002 и ЭС РД 009

### Офис по работе с юридическими лицами:

105318, г.Москва, ул.Щербаковская д.3, офис 1107, 1118, ДЦ «Щербаковский»

Телефон: +7 495 668-12-70 (многоканальный)

Факс: +7 495 668-12-70 (доб.304)

E-mail: [info@moschip.ru](mailto:info@moschip.ru)

Skype отдела продаж:

moschip.ru

moschip.ru\_4

moschip.ru\_6

moschip.ru\_9