

EasyPIM™ Modul mit Trench/Feldstopp IGBT4 und Emitter Controlled 4 Diode und PressFIT / NTC / TIM
 EasyPIM™ module with Trench/Fieldstop IGBT4 and Emitter Controlled 4 diode and PressFIT / NTC / TIM

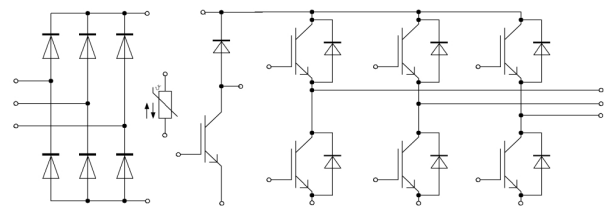
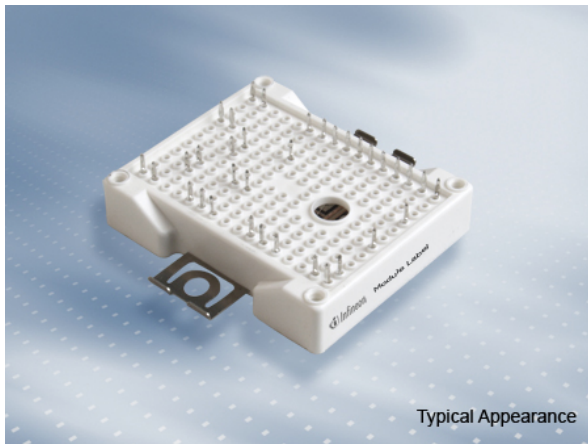

$V_{CES} = 1200V$
 $I_{C\ nom} = 25A / I_{CRM} = 50A$

Typische Anwendungen

- Hilfsumrichter
- Klimaanlage
- Motorantriebe

Elektrische Eigenschaften

- Niedrige Schaltverluste
- Niedriges V_{CEsat}
- Trench IGBT 4
- V_{CEsat} mit positivem Temperaturkoeffizienten

Mechanische Eigenschaften

- Al_2O_3 Substrat mit kleinem thermischen Widerstand
- Kompaktes Design
- PressFIT Verbindungstechnik
- Robuste Montage durch integrierte Befestigungsklammern
- Thermisches Interface Material bereits aufgetragen

Typical Applications

- Auxiliary inverters
- Air conditioning
- Motor drives

Electrical Features

- Low switching losses
- Low V_{CEsat}
- Trench IGBT 4
- V_{CEsat} with positive temperature coefficient

Mechanical Features

- Al_2O_3 substrate with low thermal resistance
- Compact design
- PressFIT contact technology
- Rugged mounting due to integrated mounting clamps
- Pre-applied Thermal Interface Material

Module Label Code

Barcode Code 128



DMX - Code



Content of the Code

| Content of the Code | Digit |
|----------------------------|---------|
| Module Serial Number | 1 - 5 |
| Module Material Number | 6 - 11 |
| Production Order Number | 12 - 19 |
| Datecode (Production Year) | 20 - 21 |
| Datecode (Production Week) | 22 - 23 |

IGBT, Wechselrichter / IGBT, Inverter Höchstzulässige Werte / Maximum Rated Values

| | | | | |
|--|--|-------------------|-------|---|
| Kollektor-Emitter-Sperrspannung Collector-emitter voltage | $T_{vj} = 25^{\circ}\text{C}$ | V_{CES} | 1200 | V |
| Kollektor-Dauergleichstrom Continuous DC collector current | $T_H = 90^{\circ}\text{C}, T_{vj\max} = 175^{\circ}\text{C}$ | $I_{C\text{nom}}$ | 25 | A |
| Periodischer Kollektor-Spitzenstrom Repetitive peak collector current | $t_P = 1\text{ ms}$ | I_{CRM} | 50 | A |
| Gate-Emitter-Spitzenspannung Gate-emitter peak voltage | | V_{GES} | +/-20 | V |

Charakteristische Werte / Characteristic Values

| | | | min. | typ. | max. | | |
|--|---|--------------------------------|--------------------|-------|------|---------------|--------------------|
| Kollektor-Emitter-Sättigungsspannung Collector-emitter saturation voltage | $I_C = 25\text{ A}, V_{GE} = 15\text{ V}$ | $T_{vj} = 25^{\circ}\text{C}$ | $V_{CE\text{sat}}$ | 1,85 | 2,25 | V | |
| | $I_C = 25\text{ A}, V_{GE} = 15\text{ V}$ | $T_{vj} = 125^{\circ}\text{C}$ | | 2,15 | | V | |
| | $I_C = 25\text{ A}, V_{GE} = 15\text{ V}$ | $T_{vj} = 150^{\circ}\text{C}$ | | 2,25 | | V | |
| | | | | | | | |
| Gate-Schwellenspannung Gate threshold voltage | $I_C = 0,80\text{ mA}, V_{CE} = V_{GE}, T_{vj} = 25^{\circ}\text{C}$ | | V_{GEth} | 5,20 | 5,80 | 6,40 | V |
| Gateladung Gate charge | $V_{GE} = -15\text{ V} \dots +15\text{ V}$ | | Q_G | | 0,20 | | μC |
| Interner Gatewiderstand Internal gate resistor | $T_{vj} = 25^{\circ}\text{C}$ | | R_{Gint} | | 0,0 | | Ω |
| Eingangskapazität Input capacitance | $f = 1\text{ MHz}, T_{vj} = 25^{\circ}\text{C}, V_{CE} = 25\text{ V}, V_{GE} = 0\text{ V}$ | | C_{ies} | | 1,45 | | nF |
| Rückwirkungskapazität Reverse transfer capacitance | $f = 1\text{ MHz}, T_{vj} = 25^{\circ}\text{C}, V_{CE} = 25\text{ V}, V_{GE} = 0\text{ V}$ | | C_{res} | | 0,05 | | nF |
| Kollektor-Emitter-Reststrom Collector-emitter cut-off current | $V_{CE} = 1200\text{ V}, V_{GE} = 0\text{ V}, T_{vj} = 25^{\circ}\text{C}$ | | I_{CES} | | | 1,0 | mA |
| Gate-Emitter-Reststrom Gate-emitter leakage current | $V_{CE} = 0\text{ V}, V_{GE} = 20\text{ V}, T_{vj} = 25^{\circ}\text{C}$ | | I_{GES} | | | 100 | nA |
| Einschaltverzögerungszeit, induktive Last Turn-on delay time, inductive load | $I_C = 25\text{ A}, V_{CE} = 600\text{ V}$ $V_{GE} = \pm 15\text{ V}$ $R_{Gon} = 20\ \Omega$ | $T_{vj} = 25^{\circ}\text{C}$ | t_{don} | 0,026 | | μs | |
| | | $T_{vj} = 125^{\circ}\text{C}$ | | 0,026 | | μs | |
| | | $T_{vj} = 150^{\circ}\text{C}$ | | 0,026 | | μs | |
| Anstiegszeit, induktive Last Rise time, inductive load | $I_C = 25\text{ A}, V_{CE} = 600\text{ V}$ $V_{GE} = \pm 15\text{ V}$ $R_{Gon} = 20\ \Omega$ | $T_{vj} = 25^{\circ}\text{C}$ | t_r | 0,016 | | μs | |
| | | $T_{vj} = 125^{\circ}\text{C}$ | | 0,02 | | μs | |
| | | $T_{vj} = 150^{\circ}\text{C}$ | | 0,021 | | μs | |
| Abschaltverzögerungszeit, induktive Last Turn-off delay time, inductive load | $I_C = 25\text{ A}, V_{CE} = 600\text{ V}$ $V_{GE} = \pm 15\text{ V}$ $R_{Goff} = 20\ \Omega$ | $T_{vj} = 25^{\circ}\text{C}$ | t_{doff} | 0,19 | | μs | |
| | | $T_{vj} = 125^{\circ}\text{C}$ | | 0,28 | | μs | |
| | | $T_{vj} = 150^{\circ}\text{C}$ | | 0,30 | | μs | |
| Fallzeit, induktive Last Fall time, inductive load | $I_C = 25\text{ A}, V_{CE} = 600\text{ V}$ $V_{GE} = \pm 15\text{ V}$ $R_{Goff} = 20\ \Omega$ | $T_{vj} = 25^{\circ}\text{C}$ | t_f | 0,18 | | μs | |
| | | $T_{vj} = 125^{\circ}\text{C}$ | | 0,21 | | μs | |
| | | $T_{vj} = 150^{\circ}\text{C}$ | | 0,22 | | μs | |
| Einschaltverlustenergie pro Puls Turn-on energy loss per pulse | $I_C = 25\text{ A}, V_{CE} = 600\text{ V}, L_S = 35\text{ nH}$ $V_{GE} = \pm 15\text{ V}, di/dt = 1700\text{ A}/\mu\text{s} (T_{vj} = 150^{\circ}\text{C})$ $R_{Gon} = 20\ \Omega$ | $T_{vj} = 25^{\circ}\text{C}$ | E_{on} | 1,60 | | mJ | |
| | | $T_{vj} = 125^{\circ}\text{C}$ | | 2,40 | | mJ | |
| | | $T_{vj} = 150^{\circ}\text{C}$ | | 2,60 | | mJ | |
| Abschaltverlustenergie pro Puls Turn-off energy loss per pulse | $I_C = 25\text{ A}, V_{CE} = 600\text{ V}, L_S = 35\text{ nH}$ $V_{GE} = \pm 15\text{ V}, du/dt = 3600\text{ V}/\mu\text{s} (T_{vj} = 150^{\circ}\text{C})$ $R_{Goff} = 20\ \Omega$ | $T_{vj} = 25^{\circ}\text{C}$ | E_{off} | 1,45 | | mJ | |
| | | $T_{vj} = 125^{\circ}\text{C}$ | | 2,15 | | mJ | |
| | | $T_{vj} = 150^{\circ}\text{C}$ | | 2,35 | | mJ | |
| Kurzschlußverhalten SC data | $V_{GE} \leq 15\text{ V}, V_{CC} = 800\text{ V}$ $V_{CEmax} = V_{CES} - L_{SCE} \cdot di/dt$ $t_P \leq 10\ \mu\text{s}, T_{vj} = 150^{\circ}\text{C}$ | | I_{SC} | | 90 | | A |
| Wärmewiderstand, Chip bis Kühlkörper Thermal resistance, junction to heatsink | pro IGBT / per IGBT valid with IFX pre-applied thermal interface material | | R_{thJH} | | | 1,19 | K/W |
| Temperatur im Schaltbetrieb Temperature under switching conditions | | | $T_{vj\text{op}}$ | -40 | | 150 | $^{\circ}\text{C}$ |

Diode, Wechselrichter / Diode, Inverter

Höchstzulässige Werte / Maximum Rated Values

| | | | | |
|---|--|-----------|--------------|--|
| Periodische Spitzensperrspannung Repetitive peak reverse voltage | $T_{vj} = 25^{\circ}\text{C}$ | V_{RRM} | 1200 | V |
| Dauergleichstrom Continuous DC forward current | | I_F | 25 | A |
| Periodischer Spitzenstrom Repetitive peak forward current | $t_p = 1\text{ ms}$ | I_{FRM} | 50 | A |
| Grenzlastintegral I^2t - value | $V_R = 0\text{ V}, t_p = 10\text{ ms}, T_{vj} = 125^{\circ}\text{C}$ $V_R = 0\text{ V}, t_p = 10\text{ ms}, T_{vj} = 150^{\circ}\text{C}$ | I^2t | 90,0 75,0 | A^2s A^2s |

Charakteristische Werte / Characteristic Values

| | | | min. | typ. | max. | |
|--|---|---|--------------------|----------------------|------|---|
| Durchlassspannung Forward voltage | $I_F = 25\text{ A}, V_{GE} = 0\text{ V}$ $I_F = 25\text{ A}, V_{GE} = 0\text{ V}$ $I_F = 25\text{ A}, V_{GE} = 0\text{ V}$ | $T_{vj} = 25^{\circ}\text{C}$ $T_{vj} = 125^{\circ}\text{C}$ $T_{vj} = 150^{\circ}\text{C}$ | V_F | 1,75 1,75 1,75 | 2,25 | V V V |
| Rückstromspitze Peak reverse recovery current | $I_F = 25\text{ A}, -di_F/dt = 1700\text{ A}/\mu\text{s} (T_{vj}=150^{\circ}\text{C})$ $V_R = 600\text{ V}$ $V_{GE} = -15\text{ V}$ | $T_{vj} = 25^{\circ}\text{C}$ $T_{vj} = 125^{\circ}\text{C}$ $T_{vj} = 150^{\circ}\text{C}$ | I_{RM} | 48,0 50,0 52,0 | | A A A |
| Sperrverzögerungsladung Recovered charge | $I_F = 25\text{ A}, -di_F/dt = 1700\text{ A}/\mu\text{s} (T_{vj}=150^{\circ}\text{C})$ $V_R = 600\text{ V}$ $V_{GE} = -15\text{ V}$ | $T_{vj} = 25^{\circ}\text{C}$ $T_{vj} = 125^{\circ}\text{C}$ $T_{vj} = 150^{\circ}\text{C}$ | Q_r | 2,50 4,40 4,90 | | μC μC μC |
| Abschaltenergie pro Puls Reverse recovery energy | $I_F = 25\text{ A}, -di_F/dt = 1700\text{ A}/\mu\text{s} (T_{vj}=150^{\circ}\text{C})$ $V_R = 600\text{ V}$ $V_{GE} = -15\text{ V}$ | $T_{vj} = 25^{\circ}\text{C}$ $T_{vj} = 125^{\circ}\text{C}$ $T_{vj} = 150^{\circ}\text{C}$ | E_{rec} | 0,95 1,75 2,05 | | mJ mJ mJ |
| Wärmewiderstand, Chip bis Kühlkörper Thermal resistance, junction to heatsink | pro Diode / per diode valid with IFX pre-applied thermal interface material | | R_{thJH} | | 1,58 | K/W |
| Temperatur im Schaltbetrieb Temperature under switching conditions | | | $T_{vj\text{ op}}$ | -40 | 150 | $^{\circ}\text{C}$ |

Diode, Gleichrichter / Diode, Rectifier

Höchstzulässige Werte / Maximum Rated Values

| | | | | |
|---|---|-------------|-------------|--|
| Periodische Spitzensperrspannung Repetitive peak reverse voltage | $T_{vj} = 25^{\circ}\text{C}$ | V_{RRM} | 1600 | V |
| Durchlassstrom Grenzeffektivwert pro Chip Maximum RMS forward current per chip | $T_H = 80^{\circ}\text{C}$ | I_{FRMSM} | 50 | A |
| Gleichrichter Ausgang Grenzeffektivstrom Maximum RMS current at rectifier output | $T_H = 80^{\circ}\text{C}$ | I_{RMSM} | 50 | A |
| Stoßstrom Grenzwert Surge forward current | $t_p = 10\text{ ms}, T_{vj} = 25^{\circ}\text{C}$ $t_p = 10\text{ ms}, T_{vj} = 150^{\circ}\text{C}$ | I_{FSM} | 450 370 | A A |
| Grenzlastintegral I^2t - value | $t_p = 10\text{ ms}, T_{vj} = 25^{\circ}\text{C}$ $t_p = 10\text{ ms}, T_{vj} = 150^{\circ}\text{C}$ | I^2t | 1000 685 | A^2s A^2s |

Charakteristische Werte / Characteristic Values

| | | | min. | typ. | max. | |
|--|--|-------|--------------------|------|------|--------------------|
| Durchlassspannung Forward voltage | $T_{vj} = 150^{\circ}\text{C}, I_F = 25\text{ A}$ | V_F | | 0,90 | | V |
| Sperrstrom Reverse current | $T_{vj} = 150^{\circ}\text{C}, V_R = 1600\text{ V}$ | I_R | | 1,00 | | mA |
| Wärmewiderstand, Chip bis Kühlkörper Thermal resistance, junction to heatsink | pro Diode / per diode valid with IFX pre-applied thermal interface material | | R_{thJH} | | 1,42 | K/W |
| Temperatur im Schaltbetrieb Temperature under switching conditions | | | $T_{vj\text{ op}}$ | -40 | 150 | $^{\circ}\text{C}$ |

IGBT, Brems-Chopper / IGBT, Brake-Chopper Höchstzulässige Werte / Maximum Rated Values

| | | | | |
|--|--|-------------------|-------|---|
| Kollektor-Emitter-Sperrspannung Collector-emitter voltage | $T_{vj} = 25^{\circ}\text{C}$ | V_{CES} | 1200 | V |
| Kollektor-Dauergleichstrom Continuous DC collector current | $T_H = 90^{\circ}\text{C}, T_{vj\max} = 175^{\circ}\text{C}$ | $I_{C\text{nom}}$ | 25 | A |
| Periodischer Kollektor-Spitzenstrom Repetitive peak collector current | $t_P = 1\text{ ms}$ | I_{CRM} | 50 | A |
| Gate-Emitter-Spitzenspannung Gate-emitter peak voltage | | V_{GES} | +/-20 | V |

Charakteristische Werte / Characteristic Values

| | | | min. | typ. | max. | | |
|--|---|---|--------------------|-------------------------|------|-------------|---|
| Kollektor-Emitter-Sättigungsspannung Collector-emitter saturation voltage | $I_C = 25\text{ A}, V_{GE} = 15\text{ V}$ $I_C = 25\text{ A}, V_{GE} = 15\text{ V}$ $I_C = 25\text{ A}, V_{GE} = 15\text{ V}$ | $T_{vj} = 25^{\circ}\text{C}$ $T_{vj} = 125^{\circ}\text{C}$ $T_{vj} = 150^{\circ}\text{C}$ | $V_{CE\text{sat}}$ | 1,85 2,15 2,25 | 2,25 | V V V | |
| Gate-Schwellenspannung Gate threshold voltage | $I_C = 0,80\text{ mA}, V_{CE} = V_{GE}, T_{vj} = 25^{\circ}\text{C}$ | | V_{GEth} | 5,20 | 5,80 | 6,40 | V |
| Gateladung Gate charge | $V_{GE} = -15\text{ V} \dots +15\text{ V}$ | | Q_G | 0,20 | | | μC |
| Interner Gatewiderstand Internal gate resistor | $T_{vj} = 25^{\circ}\text{C}$ | | R_{Gint} | 0,0 | | | Ω |
| Eingangskapazität Input capacitance | $f = 1\text{ MHz}, T_{vj} = 25^{\circ}\text{C}, V_{CE} = 25\text{ V}, V_{GE} = 0\text{ V}$ | | C_{ies} | 1,45 | | | nF |
| Rückwirkungskapazität Reverse transfer capacitance | $f = 1\text{ MHz}, T_{vj} = 25^{\circ}\text{C}, V_{CE} = 25\text{ V}, V_{GE} = 0\text{ V}$ | | C_{res} | 0,05 | | | nF |
| Kollektor-Emitter-Reststrom Collector-emitter cut-off current | $V_{CE} = 1200\text{ V}, V_{GE} = 0\text{ V}, T_{vj} = 25^{\circ}\text{C}$ | | I_{CES} | | | 1,0 | mA |
| Gate-Emitter-Reststrom Gate-emitter leakage current | $V_{CE} = 0\text{ V}, V_{GE} = 20\text{ V}, T_{vj} = 25^{\circ}\text{C}$ | | I_{GES} | | | 100 | nA |
| Einschaltverzögerungszeit, induktive Last Turn-on delay time, inductive load | $I_C = 25\text{ A}, V_{CE} = 600\text{ V}$ $V_{GE} = \pm 15\text{ V}$ $R_{Gon} = 68\ \Omega$ | $T_{vj} = 25^{\circ}\text{C}$ $T_{vj} = 125^{\circ}\text{C}$ $T_{vj} = 150^{\circ}\text{C}$ | t_{don} | 0,08 0,08 0,08 | | | μs μs μs |
| Anstiegszeit, induktive Last Rise time, inductive load | $I_C = 25\text{ A}, V_{CE} = 600\text{ V}$ $V_{GE} = \pm 15\text{ V}$ $R_{Gon} = 68\ \Omega$ | $T_{vj} = 25^{\circ}\text{C}$ $T_{vj} = 125^{\circ}\text{C}$ $T_{vj} = 150^{\circ}\text{C}$ | t_r | 0,042 0,051 0,053 | | | μs μs μs |
| Abschaltverzögerungszeit, induktive Last Turn-off delay time, inductive load | $I_C = 25\text{ A}, V_{CE} = 600\text{ V}$ $V_{GE} = \pm 15\text{ V}$ $R_{Goff} = 68\ \Omega$ | $T_{vj} = 25^{\circ}\text{C}$ $T_{vj} = 125^{\circ}\text{C}$ $T_{vj} = 150^{\circ}\text{C}$ | t_{doff} | 0,34 0,44 0,46 | | | μs μs μs |
| Fallzeit, induktive Last Fall time, inductive load | $I_C = 25\text{ A}, V_{CE} = 600\text{ V}$ $V_{GE} = \pm 15\text{ V}$ $R_{Goff} = 68\ \Omega$ | $T_{vj} = 25^{\circ}\text{C}$ $T_{vj} = 125^{\circ}\text{C}$ $T_{vj} = 150^{\circ}\text{C}$ | t_f | 0,18 0,215 0,225 | | | μs μs μs |
| Einschaltverlustenergie pro Puls Turn-on energy loss per pulse | $I_C = 25\text{ A}, V_{CE} = 600\text{ V}, L_S = 35\text{ nH}$ $V_{GE} = \pm 15\text{ V}, di/dt = 500\text{ A}/\mu\text{s} (T_{vj} = 150^{\circ}\text{C})$ $R_{Gon} = 68\ \Omega$ | $T_{vj} = 25^{\circ}\text{C}$ $T_{vj} = 125^{\circ}\text{C}$ $T_{vj} = 150^{\circ}\text{C}$ | E_{on} | 3,90 5,00 5,40 | | | mJ mJ mJ |
| Abschaltverlustenergie pro Puls Turn-off energy loss per pulse | $I_C = 25\text{ A}, V_{CE} = 600\text{ V}, L_S = 35\text{ nH}$ $V_{GE} = \pm 15\text{ V}, du/dt = 3200\text{ V}/\mu\text{s} (T_{vj} = 150^{\circ}\text{C})$ $R_{Goff} = 68\ \Omega$ | $T_{vj} = 25^{\circ}\text{C}$ $T_{vj} = 125^{\circ}\text{C}$ $T_{vj} = 150^{\circ}\text{C}$ | E_{off} | 1,50 2,20 2,40 | | | mJ mJ mJ |
| Kurzschlußverhalten SC data | $V_{GE} \leq 15\text{ V}, V_{CC} = 800\text{ V}$ $V_{CEmax} = V_{CES} - L_{SCE} \cdot di/dt$ $t_P \leq 10\ \mu\text{s}, T_{vj} = 150^{\circ}\text{C}$ | | I_{SC} | 90 | | | A |
| Wärmewiderstand, Chip bis Kühlkörper Thermal resistance, junction to heatsink | pro IGBT / per IGBT valid with IFX pre-applied thermal interface material | | R_{thJH} | | | 1,19 | K/W |
| Temperatur im Schaltbetrieb Temperature under switching conditions | | | $T_{vj\text{op}}$ | -40 | | 150 | $^{\circ}\text{C}$ |

Diode, Brems-Chopper / Diode, Brake-Chopper Höchstzulässige Werte / Maximum Rated Values

| | | | | |
|--|--|-----------|--------------|--|
| Periodische Spitzenspernung Repetitive peak reverse voltage | $T_{vj} = 25^{\circ}\text{C}$ | V_{RRM} | 1200 | V |
| Dauergleichstrom Continuous DC forward current | | I_F | 10 | A |
| Periodischer Spitzenstrom Repetitive peak forward current | $t_p = 1\text{ ms}$ | I_{FRM} | 20 | A |
| Grenzlastintegral I^2t - value | $V_R = 0\text{ V}, t_p = 10\text{ ms}, T_{vj} = 125^{\circ}\text{C}$ $V_R = 0\text{ V}, t_p = 10\text{ ms}, T_{vj} = 150^{\circ}\text{C}$ | I^2t | 16,0 14,0 | A^2s A^2s |

Charakteristische Werte / Characteristic Values

| | | | min. | typ. | max. | |
|--|---|--------------------------------|-----------|------|------|--------------------|
| Durchlassspannung Forward voltage | $I_F = 10\text{ A}, V_{GE} = 0\text{ V}$ | $T_{vj} = 25^{\circ}\text{C}$ | | 1,75 | 2,25 | V |
| | $I_F = 10\text{ A}, V_{GE} = 0\text{ V}$ | $T_{vj} = 125^{\circ}\text{C}$ | V_F | 1,75 | | V |
| | $I_F = 10\text{ A}, V_{GE} = 0\text{ V}$ | $T_{vj} = 150^{\circ}\text{C}$ | | 1,75 | | V |
| Rückstromspitze Peak reverse recovery current | $I_F = 10\text{ A}, -di_F/dt = 500\text{ A}/\mu\text{s} (T_{vj}=150^{\circ}\text{C})$ $V_R = 600\text{ V}$ | $T_{vj} = 25^{\circ}\text{C}$ | | 12,0 | | A |
| | | $T_{vj} = 125^{\circ}\text{C}$ | I_{RM} | 10,0 | | A |
| | | $T_{vj} = 150^{\circ}\text{C}$ | | 8,00 | | A |
| Sperrverzögerungsladung Recovered charge | $I_F = 10\text{ A}, -di_F/dt = 500\text{ A}/\mu\text{s} (T_{vj}=150^{\circ}\text{C})$ $V_R = 600\text{ V}$ | $T_{vj} = 25^{\circ}\text{C}$ | | 0,90 | | μC |
| | | $T_{vj} = 125^{\circ}\text{C}$ | Q_r | 1,70 | | μC |
| | | $T_{vj} = 150^{\circ}\text{C}$ | | 1,90 | | μC |
| Abschaltenergie pro Puls Reverse recovery energy | $I_F = 10\text{ A}, -di_F/dt = 500\text{ A}/\mu\text{s} (T_{vj}=150^{\circ}\text{C})$ $V_R = 600\text{ V}$ | $T_{vj} = 25^{\circ}\text{C}$ | | 0,24 | | mJ |
| | | $T_{vj} = 125^{\circ}\text{C}$ | E_{rec} | 0,52 | | mJ |
| | | $T_{vj} = 150^{\circ}\text{C}$ | | 0,59 | | mJ |
| Wärmewiderstand, Chip bis Kühlkörper Thermal resistance, junction to heatsink | pro Diode / per diode valid with IFX pre-applied thermal interface material | R_{thJH} | | | 2,69 | K/W |
| Temperatur im Schaltbetrieb Temperature under switching conditions | | $T_{vj\text{ op}}$ | -40 | | 150 | $^{\circ}\text{C}$ |

NTC-Widerstand / NTC-Thermistor

Charakteristische Werte / Characteristic Values

| | | | min. | typ. | max. | |
|--|---|--------------|------|------|------|------------------|
| Nennwiderstand Rated resistance | $T_{NTC} = 25^{\circ}\text{C}$ | R_{25} | | 5,00 | | $\text{k}\Omega$ |
| Abweichung von R100 Deviation of R100 | $T_{NTC} = 100^{\circ}\text{C}, R_{100} = 493\ \Omega$ | $\Delta R/R$ | -5 | | 5 | % |
| Verlustleistung Power dissipation | $T_{NTC} = 25^{\circ}\text{C}$ | P_{25} | | | 20,0 | mW |
| B-Wert B-value | $R_2 = R_{25} \exp [B_{25/50}(1/T_2 - 1/(298,15\text{ K}))]$ | $B_{25/50}$ | | 3375 | | K |
| B-Wert B-value | $R_2 = R_{25} \exp [B_{25/80}(1/T_2 - 1/(298,15\text{ K}))]$ | $B_{25/80}$ | | 3411 | | K |
| B-Wert B-value | $R_2 = R_{25} \exp [B_{25/100}(1/T_2 - 1/(298,15\text{ K}))]$ | $B_{25/100}$ | | 3433 | | K |

Angaben gemäß gültiger Application Note.
Specification according to the valid application note.

Modul / Module

| | | | | | | |
|--|---|--|--------------------------------|--------------|------|----|
| Isolations-Prüfspannung Isolation test voltage | RMS, f = 50 Hz, t = 1 min. | V _{ISOL} | 2,5 | | | kV |
| Innere Isolation Internal isolation | Basisisolierung (Schutzklasse 1, EN61140) basic insulation (class 1, IEC 61140) | | Al ₂ O ₃ | | | |
| Kriechstrecke Creepage distance | Kontakt - Kühlkörper / terminal to heatsink Kontakt - Kontakt / terminal to terminal | | 11,5 6,3 | | | mm |
| Luftstrecke Clearance | Kontakt - Kühlkörper / terminal to heatsink Kontakt - Kontakt / terminal to terminal | | 10,0 5,0 | | | mm |
| Vergleichszahl der Kriechwegbildung Comperative tracking index | | CTI | > 200 | | | |
| | | | min. | typ. | max. | |
| Modulstreuintuktivität Stray inductance module | | L _{sCE} | | 30 | | nH |
| Modulleitungswiderstand, Anschlüsse - Chip Module lead resistance, terminals - chip | T _H = 25°C, pro Schalter / per switch | R _{CC'+EE'} R _{AA'+CC'} | | 5,00 6,00 | | mΩ |
| Lagertemperatur Storage temperature | | T _{stg} | -40 | | 125 | °C |
| Höchstzulässige Bodenplattenbetriebstemperatur Maximum baseplate operation temperature | | T _{BPmax} | | | 125 | °C |
| Anpresskraft für mech. Bef. pro Feder mounting force per clamp | | F | 40 | - | 80 | N |
| Gewicht Weight | | G | | 39 | | g |

Der Strom im Dauerbetrieb ist auf 25A effektiv pro Anschlusspin begrenzt.
The current under continuous operation is limited to 25A rms per connector pin.
Lagerung und Transport von Modulen mit TIM => siehe AN2012-07
Storage and shipment of modules with TIM => see AN2012-07

Ausgangskennlinie IGBT, Wechselrichter (typisch)
output characteristic IGBT, Inverter (typical)

$I_C = f(V_{CE})$
 $V_{GE} = 15\text{ V}$

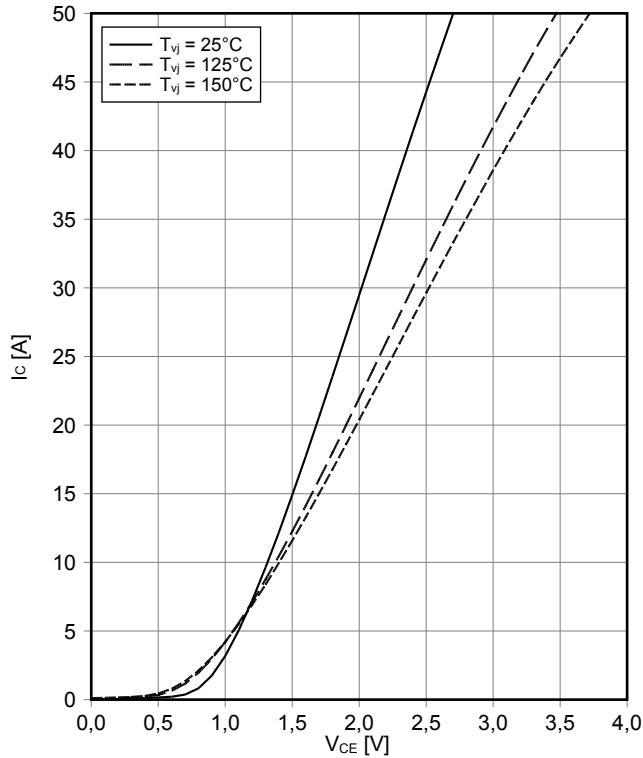

Ausgangskennlinienfeld IGBT, Wechselrichter (typisch)
output characteristic IGBT, Inverter (typical)

$I_C = f(V_{CE})$
 $T_{vj} = 150^\circ\text{C}$

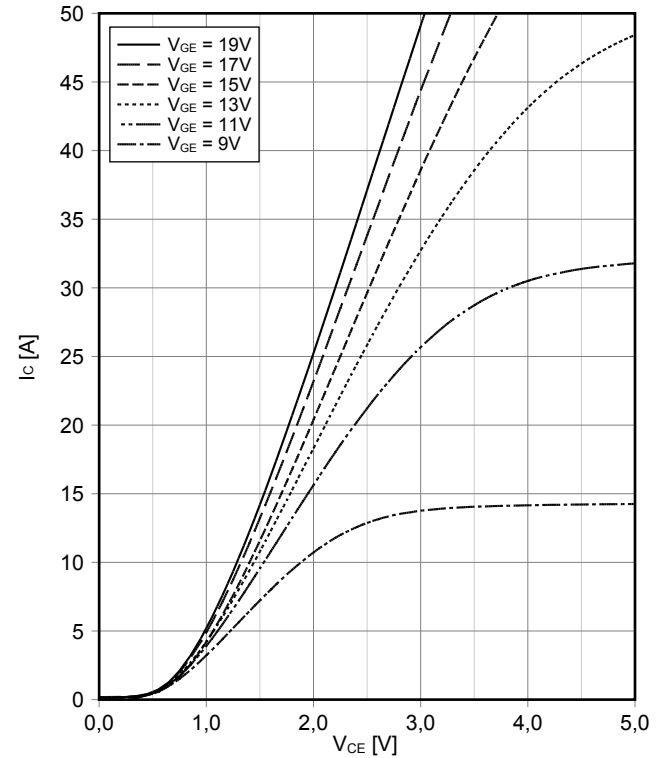

Übertragungscharakteristik IGBT, Wechselrichter (typisch)
transfer characteristic IGBT, Inverter (typical)

$I_C = f(V_{GE})$
 $V_{CE} = 20\text{ V}$

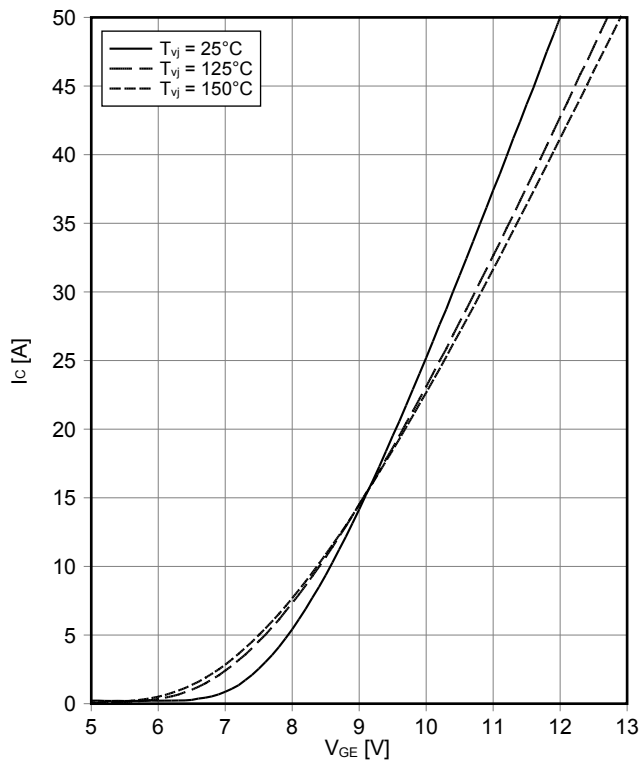

Schaltverluste IGBT, Wechselrichter (typisch)
switching losses IGBT, Inverter (typical)

$E_{on} = f(I_C)$, $E_{off} = f(I_C)$
 $V_{GE} = \pm 15\text{ V}$, $R_{Gon} = 20\ \Omega$, $R_{Goff} = 20\ \Omega$, $V_{CE} = 600\text{ V}$

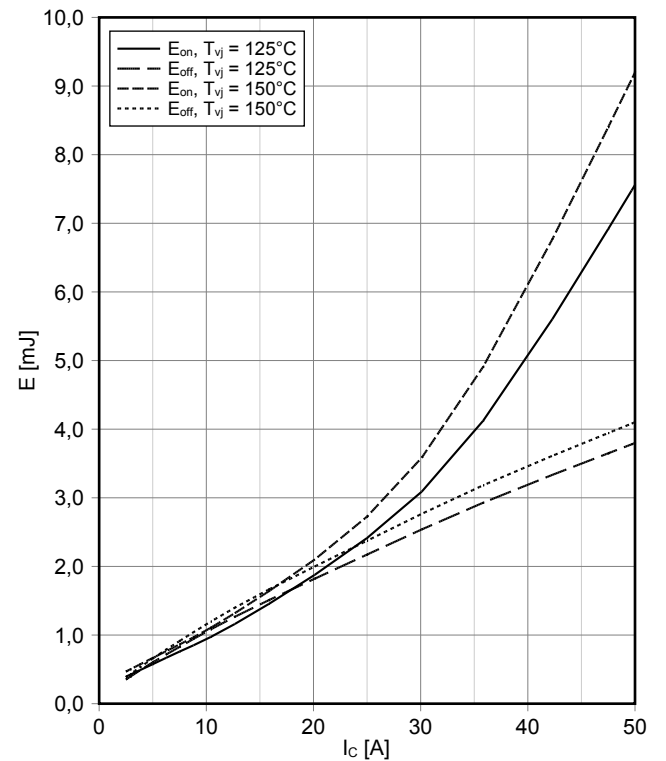

Schaltverluste IGBT, Wechselrichter (typisch) switching losses IGBT, Inverter (typical)

$E_{on} = f(R_G)$, $E_{off} = f(R_G)$
 $V_{GE} = \pm 15\text{ V}$, $I_C = 25\text{ A}$, $V_{CE} = 600\text{ V}$

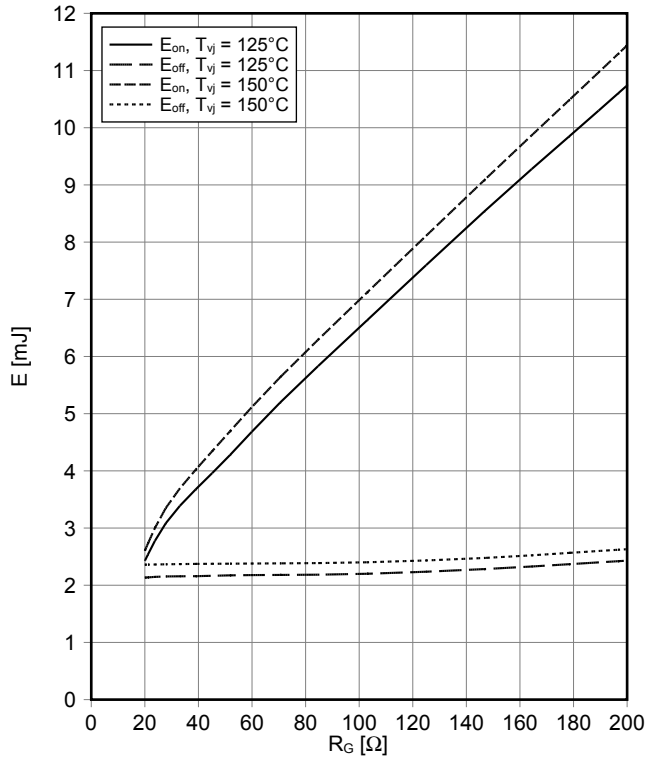

Transienter Wärmewiderstand IGBT, Wechselrichter transient thermal impedance IGBT, Inverter

$Z_{thJH} = f(t)$

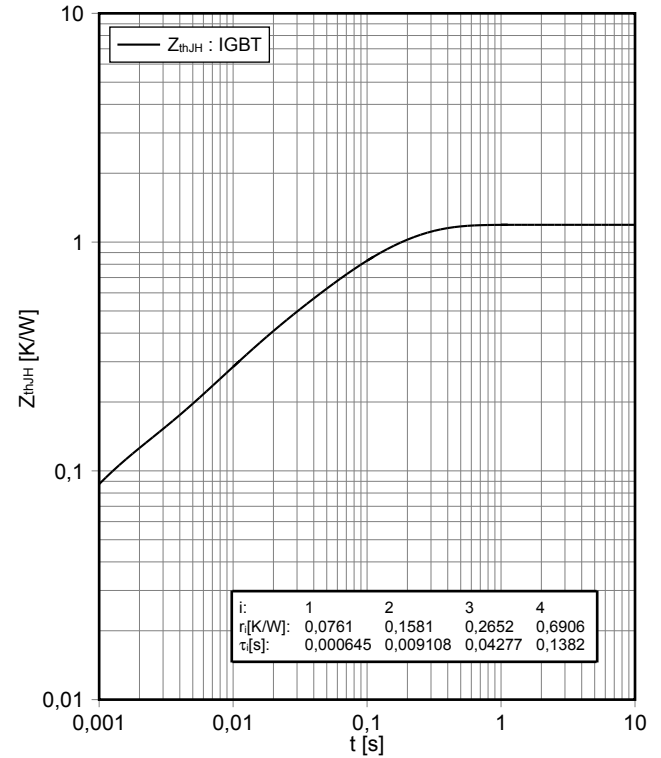

Sicherer Rückwärts-Arbeitsbereich IGBT, Wechselrichter (RBSOA) reverse bias safe operating area IGBT, Inverter (RBSOA)

$I_C = f(V_{CE})$
 $V_{GE} = \pm 15\text{ V}$, $R_{Goff} = 20\ \Omega$, $T_{vj} = 150^\circ\text{C}$

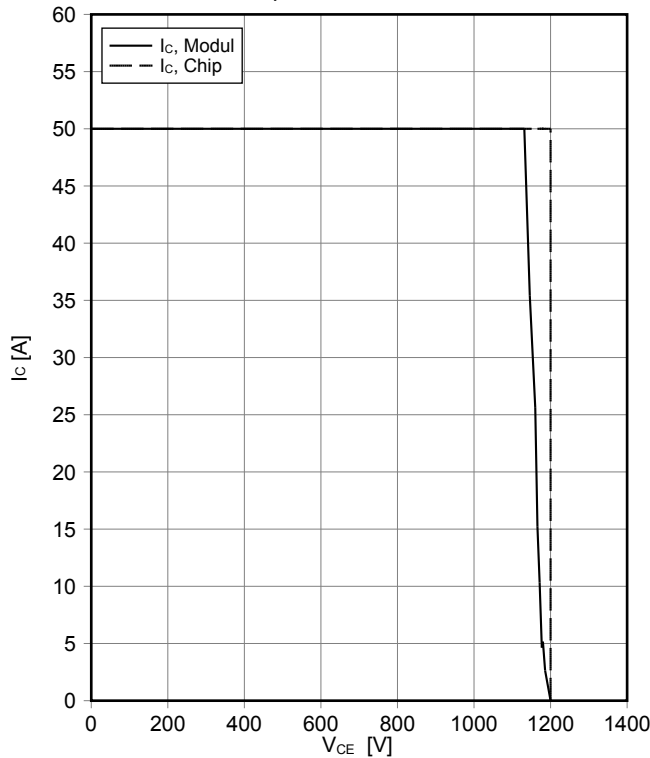

Durchlasskennlinie der Diode, Wechselrichter (typisch) forward characteristic of Diode, Inverter (typical)

$I_F = f(V_F)$

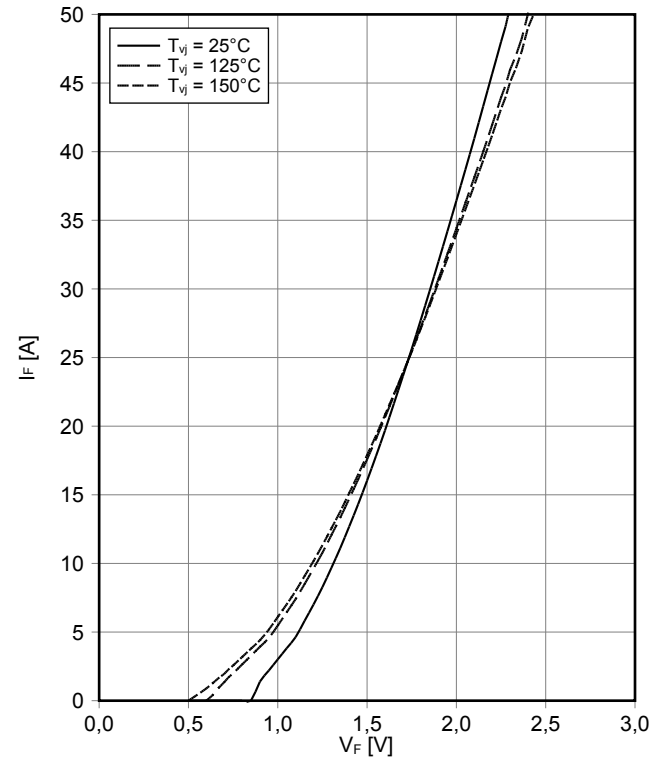

Schaltverluste Diode, Wechselrichter (typisch)
switching losses Diode, Inverter (typical)

$E_{rec} = f(I_F)$
 $R_{Gon} = 20 \Omega, V_{CE} = 600 V$

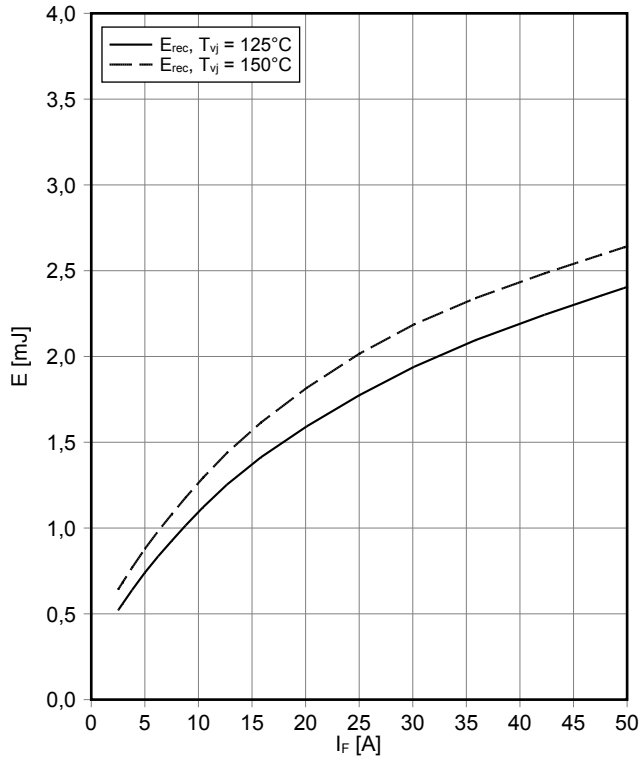

Schaltverluste Diode, Wechselrichter (typisch)
switching losses Diode, Inverter (typical)

$E_{rec} = f(R_G)$
 $I_F = 25 A, V_{CE} = 600 V$

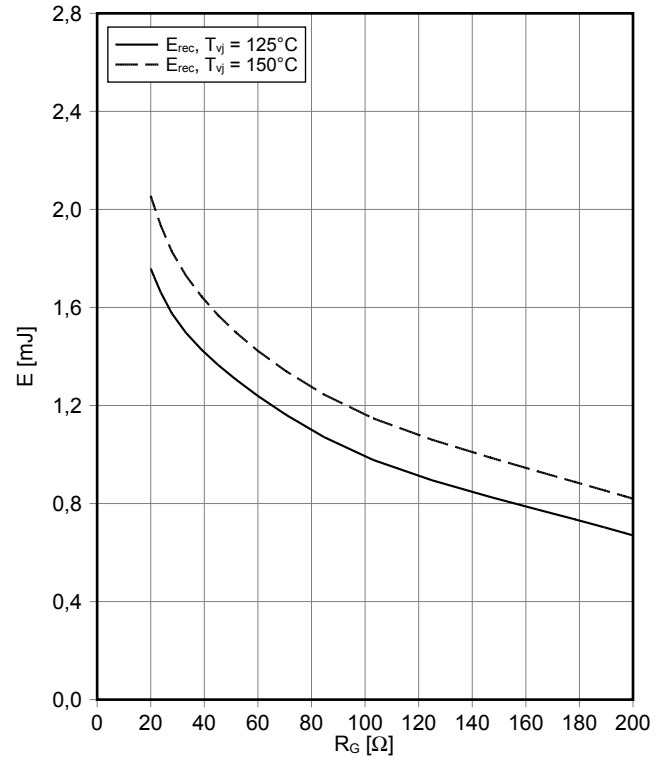

Transienter Wärmewiderstand Diode, Wechselrichter
transient thermal impedance Diode, Inverter

$Z_{thJH} = f(t)$

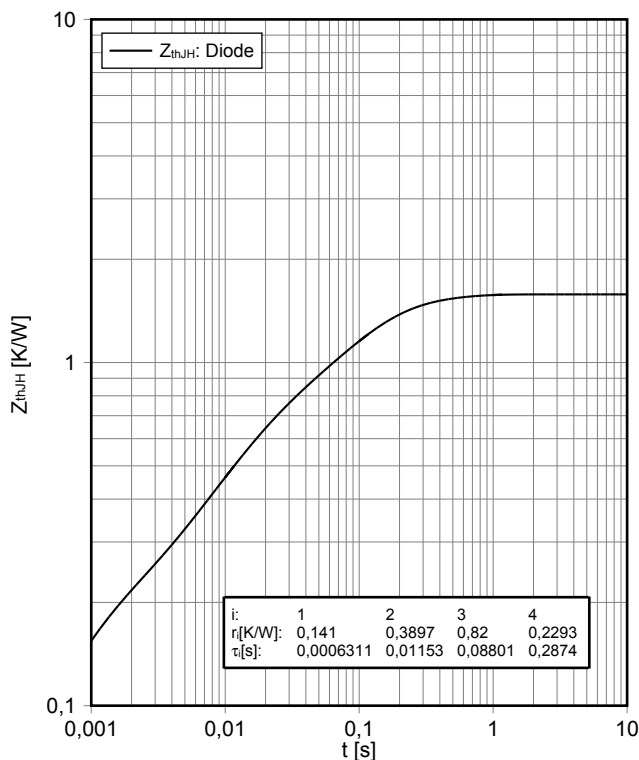

Durchlasskennlinie der Diode, Gleichrichter (typisch)
forward characteristic of Diode, Rectifier (typical)

$I_F = f(V_F)$

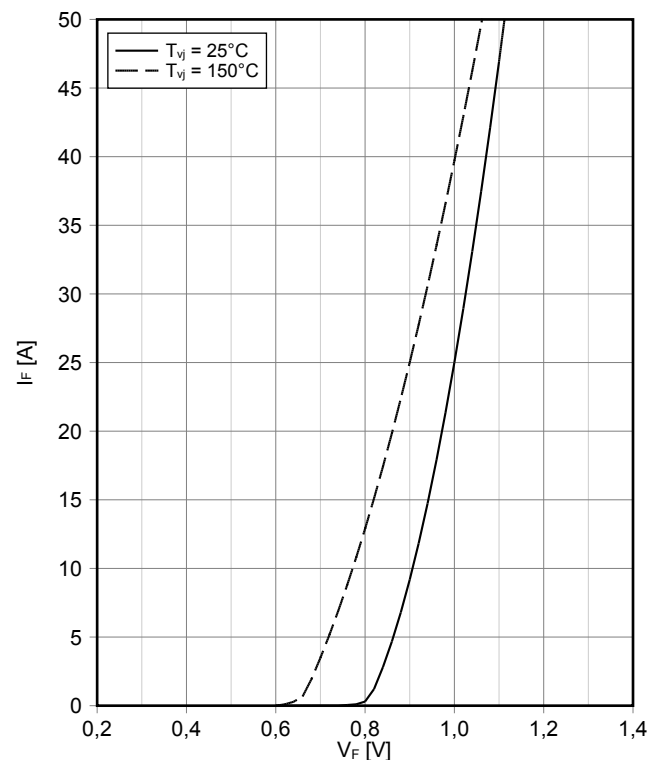

Ausgangskennlinie IGBT, Brems-Chopper (typisch)
output characteristic IGBT, Brake-Chopper (typical)

$I_C = f(V_{CE})$
 $V_{GE} = 15\text{ V}$

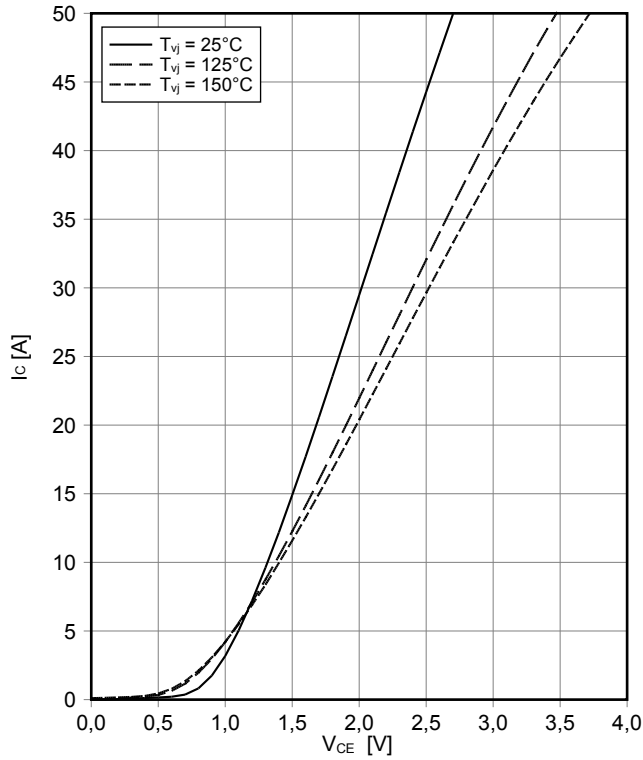

Durchlasskennlinie der Diode, Brems-Chopper (typisch)
forward characteristic of Diode, Brake-Chopper (typical)

$I_F = f(V_F)$

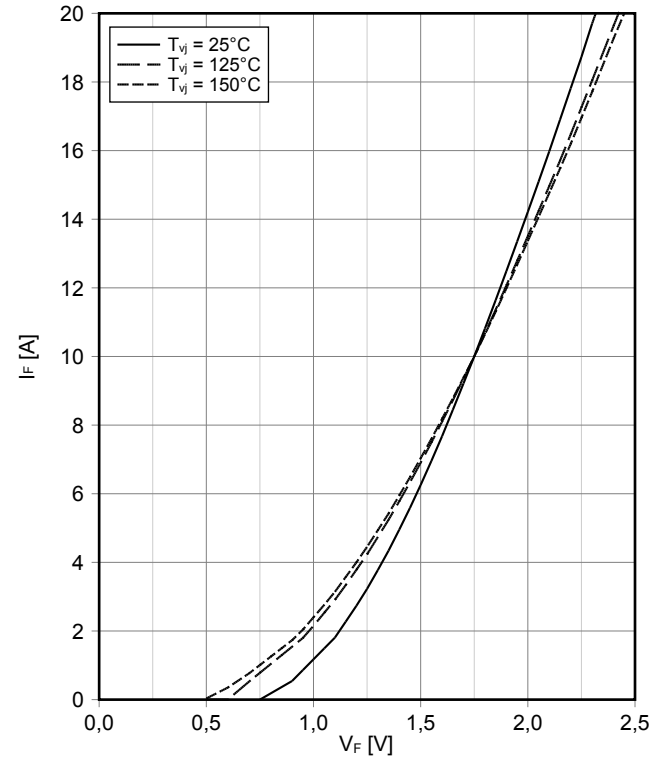

NTC-Widerstand-Temperaturkennlinie (typisch)
NTC-Thermistor-temperature characteristic (typical)

$R = f(T)$

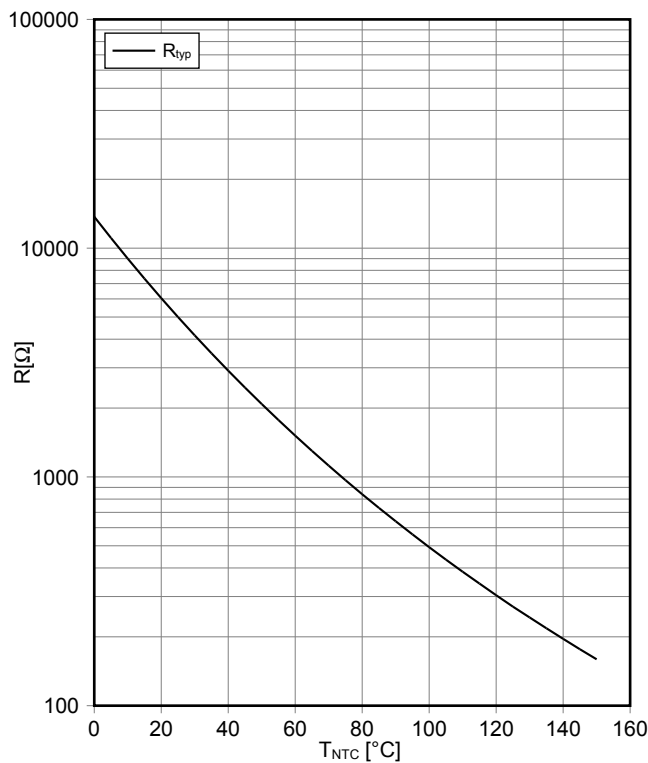

Schaltplan / Circuit diagram

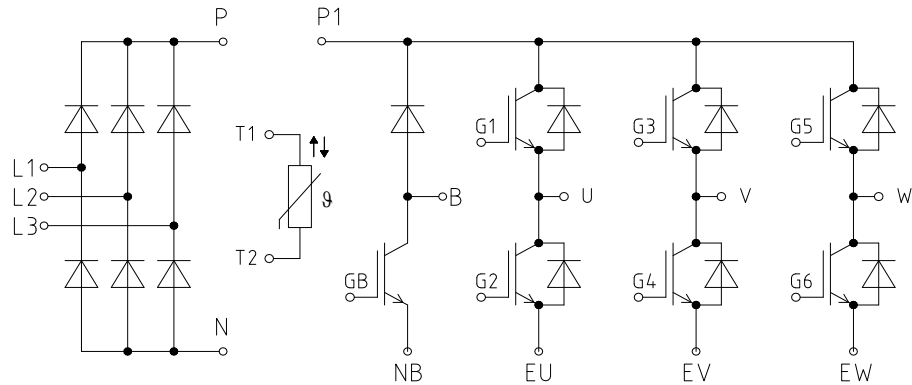

Gehäuseabmessungen / Package outlines

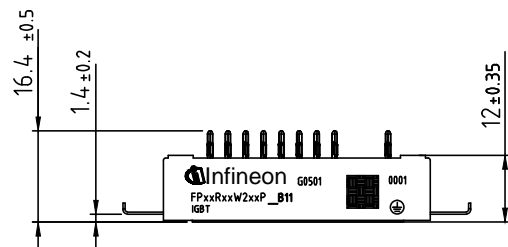
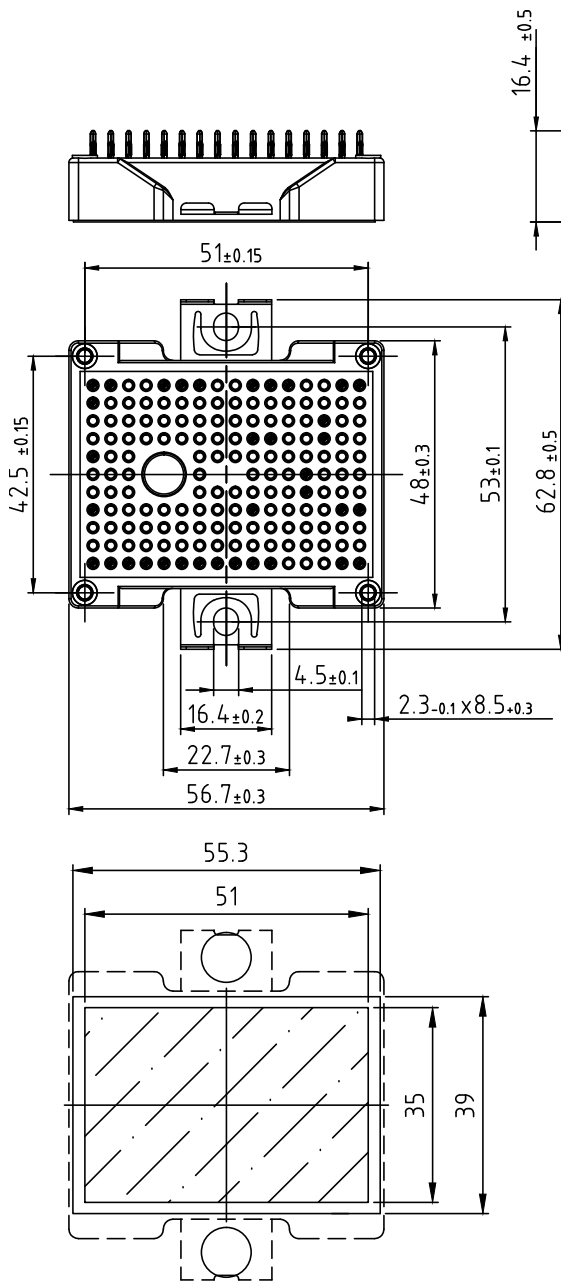

- Pin-Grid 3.2mm
 - Tolerance of PCB hole pattern $\varnothing 0.1$
 - Hole specification for contacts see AN 2009-01:
- Diameters of drill $\varnothing 1.15\text{mm}$
and copper thickness in hole 25-50 μm

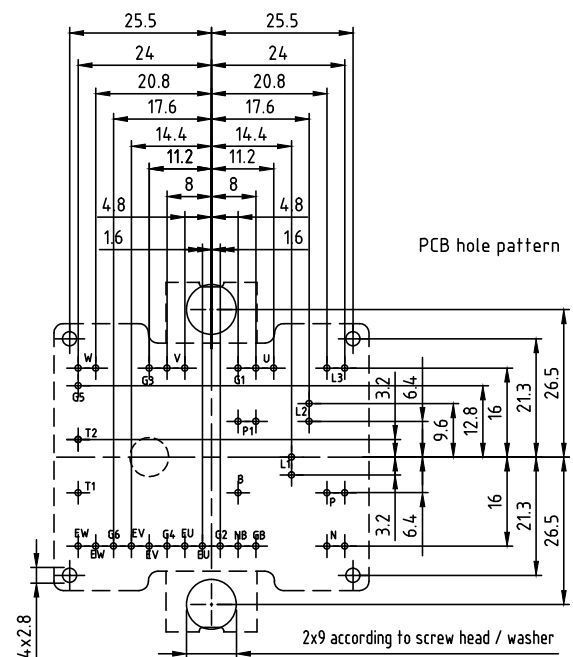

restricted area for Thermal Interface Material

Trademarks of Infineon Technologies AG

μ HVIC™, μ IPM™, μ PFC™, AU-ConvertIR™, AURIX™, C166™, CanPAK™, CIPOS™, CIPURSE™, CoolIDP™, CoolGaN™, COOLiR™, CoolMOS™, CoolSET™, CoolSiC™, DAVE™, DI-POL™, DirectFET™, DrBlade™, EasyPIM™, EconoBRIDGE™, EconoDUAL™, EconoPACK™, EconoPIM™, EiceDRIVER™, eupec™, FCOS™, GaNpowIR™, HEXFET™, HITFET™, HybridPACK™, iMOTION™, IRAM™, ISOFACE™, IsoPACK™, LEDrivIR™, LITIX™, MIPAQ™, ModSTACK™, my-d™, NovalithIC™, OPTIGA™, OptiMOS™, ORIGA™, PowIRaudio™, PowIRstage™, PrimePACK™, PrimeSTACK™, PROFET™, PRO-SIL™, RASIC™, REAL3™, SmartLEWIS™, SOLID FLASH™, SPOC™, StrongIRFET™, SuplIRBuck™, TEMPFET™, TRENCHSTOP™, TriCore™, UHVIC™, XHP™, XMC™

Trademarks updated November 2015

Other Trademarks

All referenced product or service names and trademarks are the property of their respective owners.

Edition 2017-05-04

Published by
Infineon Technologies AG
81726 München, Germany

© 2017 Infineon Technologies AG.
All Rights Reserved.

Do you have a question about this document?
Email: erratum@infineon.com

WICHTIGER HINWEIS

Die in diesem Dokument enthaltenen Angaben stellen keinesfalls Garantien für die Beschaffenheit oder Eigenschaften des Produktes ("Beschaffenhheitsgarantie") dar. Für Beispiele, Hinweise oder typische Werte, die in diesem Dokument enthalten sind, und/oder Angaben, die sich auf die Anwendung des Produktes beziehen, ist jegliche Gewährleistung und Haftung von Infineon Technologies ausgeschlossen, einschließlich, ohne hierauf beschränkt zu sein, die Gewähr dafür, dass kein geistiges Eigentum Dritter verletzt ist.

Des Weiteren stehen sämtliche, in diesem Dokument enthaltenen Informationen, unter dem Vorbehalt der Einhaltung der in diesem Dokument festgelegten Verpflichtungen des Kunden sowie aller im Hinblick auf das Produkt des Kunden sowie die Nutzung des Infineon Produktes in den Anwendungen des Kunden anwendbaren gesetzlichen Anforderungen, Normen und Standards durch den Kunden.

Die in diesem Dokument enthaltenen Daten sind ausschließlich für technisch geschultes Fachpersonal bestimmt. Die Beurteilung der Eignung dieses Produktes für die beabsichtigte Anwendung sowie die Beurteilung der Vollständigkeit der in diesem Dokument enthaltenen Produktdaten für diese Anwendung obliegt den technischen Fachabteilungen des Kunden.

Sollten Sie von uns weitere Informationen im Zusammenhang mit dem Produkt, der Technologie, Lieferbedingungen bzw. Preisen benötigen, wenden Sie sich bitte an das nächste Vertriebsbüro von Infineon Technologies (www.infineon.com).

WARNHINWEIS

Aufgrund der technischen Anforderungen können Produkte gesundheitsgefährdende Substanzen enthalten. Bei Fragen zu den in diesem Produkt enthaltenen Substanzen, setzen Sie sich bitte mit dem nächsten Vertriebsbüro von Infineon Technologies in Verbindung.

Sofern Infineon Technologies nicht ausdrücklich in einem schriftlichen, von vertretungsberechtigten Infineon Mitarbeitern unterzeichneten Dokument zugestimmt hat, dürfen Produkte von Infineon Technologies nicht in Anwendungen eingesetzt werden, in welchen vernünftigerweise erwartet werden kann, dass ein Fehler des Produktes oder die Folgen der Nutzung des Produktes zu Personenverletzungen führen.

IMPORTANT NOTICE

The information given in this document shall in no event be regarded as a guarantee of conditions or characteristics ("Beschaffenhheitsgarantie"). With respect to any examples, hints or any typical values stated herein and/or any information regarding the application of the product, Infineon Technologies hereby disclaims any and all warranties and liabilities of any kind, including without limitation warranties of non-infringement of intellectual property rights of any third party.

In addition, any information given in this document is subject to customer's compliance with its obligations stated in this document and any applicable legal requirements, norms and standards concerning customer's products and any use of the product of Infineon Technologies in customer's applications.

The data contained in this document is exclusively intended for technically trained staff. It is the responsibility of customer's technical departments to evaluate the suitability of the product for the intended application and the completeness of the product information given in this document with respect to such application.

For further information on the product, technology, delivery terms and conditions and prices please contact your nearest Infineon Technologies office (www.infineon.com).

WARNINGS

Due to technical requirements products may contain dangerous substances. For information on the types in question please contact your nearest Infineon Technologies office.

Except as otherwise explicitly approved by Infineon Technologies in a written document signed by authorized representatives of Infineon Technologies, Infineon Technologies' products may not be used in any applications where a failure of the product or any consequences of the use thereof can reasonably be expected to result in personal injury.

Данный компонент на территории Российской Федерации

Вы можете приобрести в компании MosChip.

Для оперативного оформления запроса Вам необходимо перейти по данной ссылке:

<http://moschip.ru/get-element>

Вы можете разместить у нас заказ для любого Вашего проекта, будь то серийное производство или разработка единичного прибора.

В нашем ассортименте представлены ведущие мировые производители активных и пассивных электронных компонентов.

Нашей специализацией является поставка электронной компонентной базы двойного назначения, продукции таких производителей как XILINX, Intel (ex.ALTERA), Vicor, Microchip, Texas Instruments, Analog Devices, Mini-Circuits, Amphenol, Glenair.

Сотрудничество с глобальными дистрибьюторами электронных компонентов, предоставляет возможность заказывать и получать с международных складов практически любой перечень компонентов в оптимальные для Вас сроки.

На всех этапах разработки и производства наши партнеры могут получить квалифицированную поддержку опытных инженеров.

Система менеджмента качества компании отвечает требованиям в соответствии с ГОСТ Р ИСО 9001, ГОСТ РВ 0015-002 и ЭС РД 009

Офис по работе с юридическими лицами:

105318, г.Москва, ул.Щербаковская д.3, офис 1107, 1118, ДЦ «Щербаковский»

Телефон: +7 495 668-12-70 (многоканальный)

Факс: +7 495 668-12-70 (доб.304)

E-mail: info@moschip.ru

Skype отдела продаж:

moschip.ru

moschip.ru_4

moschip.ru_6

moschip.ru_9