

General Specifications

Electrical Capacity (Resistive Load)

Power Level (silver): 3A @ 125V AC or 3A @ 250V AC or 3A @ 30V DC
Logic Level (gold): 0.4VA maximum @ 28V AC/DC maximum
 (Applicable Range 0.1mA ~ 0.1A @ 20mV ~ 28V)
 Note: Find additional explanation of operating range in Supplement section.

Other Ratings

Contact Resistance: 50 milliohms maximum for silver; 100 milliohms maximum for gold
Insulation Resistance: 200 megohms minimum @ 500V DC
Dielectric Strength: 1,000V AC minimum between contacts for 1 minute minimum;
 1,500V AC minimum between contacts & case for 1 minute minimum
Mechanical Life: 1,000,000 operations minimum for momentary circuit
 200,000 operations minimum for maintained circuit
Electrical Life: 100,000 operations minimum
Nominal Operating Force: 4.41N
Contact Timing: Nonshorting (break-before-make)
Travel: Pretravel .059" (1.5mm); Overtravel .059" (1.5mm); Total Travel .118" (3.0mm)

Materials & Finishes

Housing: Glass fiber reinforced polyamide (UL94V-0)
Snap-in Frame: Stainless steel
Movable Contact: Silver alloy or copper with gold plating
Stationary Contacts: Silver alloy or copper with gold plating
Base: Liquid crystal polymer (UL94V-0)
Switch Terminals: Phosphor bronze with silver or gold plating
Lamp Terminals: Brass with silver plating

Environmental Data

Operating Temperature Range: -25°C through +50°C (-13°F through +122°F) for Illuminated
 -25°C through +70°C (-13°F through +158°F) for Nonilluminated
 Note: When used with a polyvinyl chloride splash cover, the lowest limit is 0°C (32°F)
Humidity: 90 ~ 95% humidity for 96 hours @ 40°C (104°F)
Vibration: 10 ~ 55Hz with peak-to-peak amplitude of 1.5mm traversing the frequency range & returning in 1 minute; 3 right angled directions for 2 hours
Shock: 50G (490m/s²) acceleration (tested in 6 right angled directions, with 5 shocks in each direction)
Sealing: Not available for snap-in; see next section for panel seal.

Installation

Cap Installation Force: 3.92N maximum downward force on cap
Quick Connect Force: 52.95N maximum downward force on connector
Soldering Time & Temperature: Manual Soldering: See Profile A in Supplement section.

Standards & Certifications

Flammability Standards: UL94V-0 housing & base
UL: **File No. E44145 - Recognized only when ordered with marking on switch.**
 Add "/U" or "/CUL" before first dash in part number to order UL recognized switch.
 All models recognized at 3A @ 125V or 250V AC or 0.4VA @ 28V AC/DC maximum.
CSA: **File No. 023535_0_000 - Certified only when ordered with marking on switch.**
 Add "/C" before first dash in part number to order CSA certified switch.
 All models certified at 3A @ 125V or 250V AC or 0.4VA @ 28V AC/DC maximum.

Distinctive Characteristics

Carefully designed light diffusion and filtering system produces bright, full surface illumination with front panel relamping.

Spot illumination available in single and bicolor LEDs.

Choice of super bright LEDs in white, green, and blue in addition to standard or bright red, amber, and green LEDs.

Stainless steel clips provide secure mounting with a wide range of panel thicknesses.

Latchdown feature gives indication of circuit status. Audible and tactile feedback with smooth and responsive operation.

Snap-action contact mechanism gives long electrical life and sensitivity of actuation.

Combination solder lug and .110" quick connect terminals are epoxy sealed to prevent entry of flux, dust, and other contaminants.

Panel sealed model meets IP65 of IEC60529 specifications (similar to NEMA 4 & 13).

Compact switch design minimizes behind panel depth.

Matching indicators available.



Actual Size



Snap-in Mount Page D46



Panel Seal Page D57

TYPICAL SWITCH ORDERING EXAMPLE



IMPORTANT:

Switches are supplied without UL, cULus & CSA marking unless specified. **UL, cULus & CSA recognized only when ordered with marking on the switch.** Specific models, ratings, & ordering instructions are noted on General Specifications page.

* Wire harness & cable assemblies offered only in Americas

DESCRIPTION FOR TYPICAL ORDERING EXAMPLE

LB15SKW01-5C12-JC



Lamps		Cap Types & Colors	
Incandescent Lamp Used with Solid Cap		Solid Cap: Lens/Filter Colors	
05	5-volt	BJ	White/Clear
12	12-volt	CJ	Red/Clear
No Code	Nonilluminated	EJ	Yellow/Clear
		FJ	Green/Clear
		GJ	Blue/Clear
Incandescent or Neon Used with Insert Cap		Insert Cap: Lens/Filter Colors	
01	110-volt Neon	JB	Clear/White
05	5-volt Incandescent	JC	Clear/Red
12	12-volt Incandescent	JE	Clear/Yellow
No Code	Nonilluminated	*JF	Clear/Green
		*JG	Clear/Blue
		*JF & JG not suitable with neon.	
Bright LED Used with LED Cap		LED Cap: Lens/Diffuser Colors	
Colors	Resistor	JB	Clear/White
5C	Red	JC	Clear/Red
	No Code	JD	Clear/Amber
	No Resistor	JF	Clear/Green
5D	Amber		
	05		
	12		
5F	Green		
	24		
Super Bright LED Used with LED Cap		LED Cap: Lens/Diffuser Colors	
6B	White	JB	Clear/White
6F	Green		
6G	Blue		
LED in Spot Illuminated Cap		Spot Illuminated Cap Colors	
1C	Red Single Color	A	Black
1D	Amber Single Color	B	White
1F	Green Single Color	C	Red
CF	Red/Green Bicolor	F	Green
		Available in Square and Round only.	
Nonilluminated		Nonilluminated Cap Colors	
No Code	Nonilluminated	A	Black
		B	White
		C	Red
		E	Yellow
		F	Green
		G	Blue
		H	Gray

Toggles

Rockers

Pushbuttons

Illuminated PB

Programmable

Keylocks

Rotaries

Slides

Tactiles

Tilt

Touch

Indicators

Accessories

Supplement

POLES & CIRCUITS

		Plunger Position () = Momentary		Connected Terminals		Throw & Switch/Lamp Schematics
Pole	Model	Normal	Down	Normal	Down	Notes: Switch is marked with NC, NO, COM, L+, L-. Lamp circuit is isolated and requires an external power source.
SP	LB15 *LB16	ON ON	(ON) ON	1-3	1-2	SPDT
DP	LB25 *LB26	ON ON	(ON) ON	1-3 4-6	1-2 4-5	DPDT

* When in latchdown position for the alternate circuit, cap position is .039" (1.0mm) above the built-in bezel.

SHAPES & PANEL CUTOUTS

S .622" (15.8mm)
Square

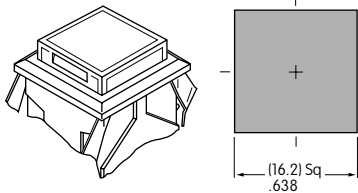

C .854" (21.7mm)
Round

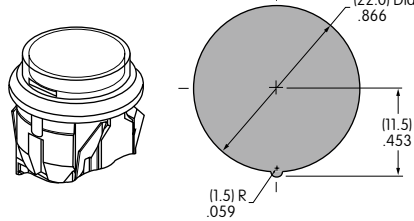

R .622" x .866" (15.8mm x 22.0mm)
Rectangular



Cutout for 1 switch:
.638" x .638" (16.2mm x 16.2mm)
Cutout for 1 switch with barriers:
.638" x .815" (16.2mm x 20.7mm)

Cutout for 1 switch:
.638" x .882" (16.2mm x 22.4mm)
Cutout for 1 switch with barriers:
.638" x 1.059" (16.2mm x 26.9mm)

Panel Thickness for Switches & Barriers: .039" ~ .157" (1.0 ~ 4.0mm)
Panel Thickness for Protective Guards & Splash Covers: .039" ~ .138" (1.0 ~ 3.5mm)

HOUSING

Housing Colors Available:

K Black

G Gray

CONTACT MATERIALS, RATINGS & TERMINALS

W01 Silver Contacts

Power Level
3A @ 125V AC & 250V AC

Solder Lug/Quick Connect

Optional PCB adaptors
AT711 & AT712 available;
illustrated in "Optional
Accessories" immediately following
"Typical Switch Dimensions."

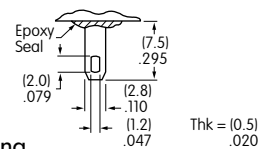

G01 Gold Contacts
Logic Level
0.4VA max. @ 28V AC/DC max.

Complete explanation of operating range in Supplement section.

INCANDESCENT & NEON LAMP CODES & SPECIFICATIONS

AT607 & AT607N



T-1 Bi-pin

		05	12	01 *
	AT607 Incandescent 5-volt or 12-volt; AT607N Neon 110-volt			
Voltage	V	5V AC	12V AC	110V AC
Current	I	115mA	60mA	1.5mA
Endurance	Avg. Hours	10,000		10,000
Ambient Temp. Range		-25°C ~ +50°C		

The electrical specifications shown are determined at a basic temperature of 25°C. Lamp circuit is isolated and requires external power source.

* Recommended Resistors for Neon:
33K ohms for 110V AC;
100K ohms for 220V AC

LED COLORS & SPECIFICATIONS

The electrical specifications shown are determined at a basic temperature of 25°C.
 LED circuit is isolated and requires external power source. Polarity marks are on the switch.
 If the source voltage exceeds the rated voltage, a ballast resistor is required.
 The resistor value can be calculated by using the formula in the Supplement section.
 Additional lamp detail is shown in the Accessories & Hardware section.

Bright LED without Resistor

AT635 LEDs are colored in OFF state.   T-1 1/2 Bi-pin	Color Codes	Red 5C	Amber 5D	Green 5F	No Code No Resistor		
	Forward Peak Current	I_{FM}			Red	Amber	Green
	Typical Forward Current	I_F			30mA	30mA	30mA
	Forward Voltage	V_F			1.9V	2.0V	2.1V
	Reverse Peak Voltage	V_{RM}			5V	5V	5V
	Current Reduction Rate Above 25°C	ΔI_F			0.42mA/°C		
	Ambient Temperature Range				-25° ~ +50°C		

Bright LED with Resistor

AT627 with Resistor  T-1 Bi-pin	Color Codes:	Red 5C	Amber 5D	Green 5F	Resistor Codes		
	Forward Peak Current	I_{FM}			05	12	24
	Typical Forward Current	I_F			52mA	26mA	13mA
	Forward Voltage	V_F			5V	12V	24V
	Reverse Peak Voltage	V_{RM}			4V	8V	16V
	Current Reduction Rate Above 25°C	ΔI_F			0.50mA/°C		
	Ambient Temperature Range				-25° ~ +50°C		

AT627
5-volt
4-element
with Resistor



AT627
12-volt
4-element
with Resistor



AT627
24-volt
4-element
with Resistor



Super Bright Single Element LED

AT625G Blue AT631B White AT632F Green   T-1 Bi-pin				6B	6F	6G	
	Color	White	Green	Blue			
	Forward Peak Current	I_{FM}			30mA	30mA	30mA
	Typical Forward Current	I_F			20mA	20mA	20mA
	Forward Voltage	V_F			3.6V	3.5V	3.6V
	Reverse Peak Voltage	V_{RM}			5V	5V	5V
	Current Reduction Rate Above 25°C	ΔI_F			0.50mA/°C		
	Ambient Temperature Range				-25° ~ +50°C		

No Code

No Lamp

CAP TYPES & COLOR COMBINATIONS

Color Codes: B White C Red D Amber E Yellow F Green G Blue J Clear

Solid Cap for Incandescent Lamp & Nonilluminated

Lens/Filter
Colors Available:

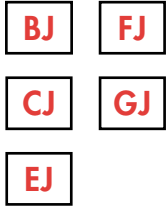

AT476
Square

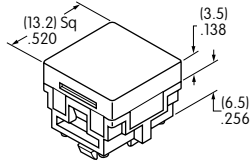

AT4012
Round

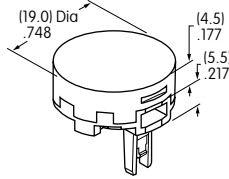

AT4026
Rectangular

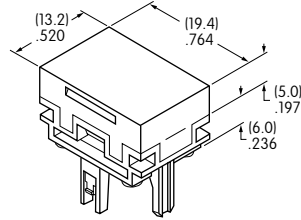

Material: Polycarbonate Finish: Glossy

Insert Cap for Incandescent or Neon Lamp & Nonilluminated

Lens/Filter
Colors Available:



AT477
Square



AT4013
Round

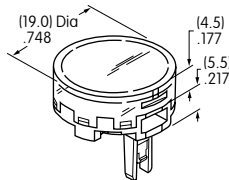

AT4027
Rectangular

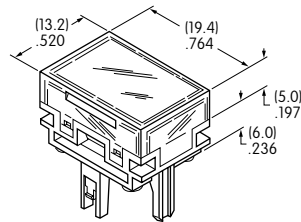

JF and JG not suitable with neon lamp.

Material: Polycarbonate Finish: Glossy

Cap for Bright LED without Resistor

Lens/Diffuser
Colors Available:



AT4176
Square



AT4178
Round



AT4177
Rectangular

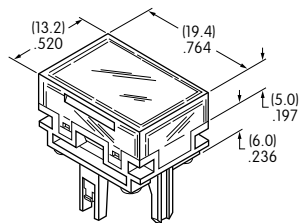

Material: Polycarbonate Finish: Glossy

Cap for Bright LED with Resistor

Lens/Diffuser
Colors Available:



AT4162
Square

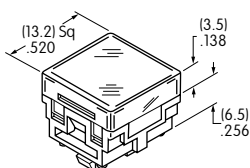

AT4164
Round



AT4163
Rectangular

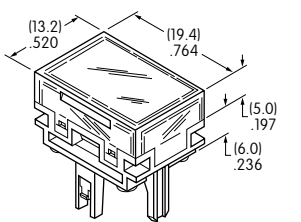

Material: Polycarbonate Finish: Glossy

Toggles
Rocker
Pushbuttons
Illuminated PB
Programmable
Keylocks
Rotaries
Slides
Tactiles
Tilt
Touch
Indicators
Accessories
Supplement

CAP TYPES & COLOR COMBINATIONS

Color Codes: A Black B White C Red D Amber E Yellow F Green G Blue H Gray J Clear

Cap for Super Bright LEDs

JB

Clear Lens
White Diffuser

AT4129
Square

AT4128
Round

AT4130
Rectangular



Transparent
Clear Lens

Material:
Polycarbonate
Finish: Glossy



Translucent
White Diffuser



LEDs AT625
AT631 AT632

Spot Illuminated Cap with LED

The electrical specifications shown are determined at a basic temperature of 25°C. LED circuit is isolated and requires an external power source. Single color LEDs are colored in OFF state; bicolor LEDs are translucent white in OFF state. Polarity marks are on the switch. If the source voltage exceeds the rated voltage, a ballast resistor is required. The resistor value can be calculated by using the formula in the Supplement section. Additional lamp detail is shown in the Accessories & Hardware section.

LED Specifications

LED factory assembled in Spot Illuminated Caps	Single Color LED with 1 Element 	Bicolor LED with 2 Elements 	Single Color			Bicolor
			1C Red	1D Amber	1F Green	CF Red/Green
Not Available Separately	Forward Peak Current	I_{FM}	10mA	30mA	30mA	30/25mA
	Typical Forward Current	I_F	8mA	24mA	24mA	20mA
	Forward Voltage	V_F	1.9V	2.0V	2.1V	2.0/2.2V
	Reverse Peak Voltage	V_{RM}	5V	5V	5V	—
	Current Reduction Rate Above 25°C	ΔI_F	0.13mA/°C	0.40mA/°C	0.40mA/°C	0.43/0.38mA/°C
	Ambient Temperature Range	-25° ~ +50°C				

Cap Colors Available:



Material:
Polycarbonate
Finish: Glossy

AT480
Square

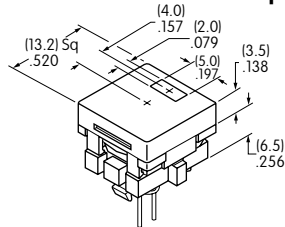

AT4016
Round



Cap with Window



Factory Assembled LED;
Not Available Separately

When ordering spot illuminated cap separately, LED color must be specified.
Examples: AT480CA (red LED, black cap); AT4016CFB (red/green bicolored LED, white cap)

Cap for Nonilluminated

Cap Colors Available:



AT484
Square



AT4017
Round



AT4030
Rectangular



Cap

No Lamp

Material: Polycarbonate Finish: Glossy

TYPICAL SWITCH DIMENSIONS

Square

Single & Double Pole



LB15SKW01-12-CJ

Single pole models do not have terminals 4, 5, & 6.

Round

Single & Double Pole



LB16CKW01-12-CJ

Single pole models do not have terminals 4, 5, & 6.

Rectangular

Single & Double Pole

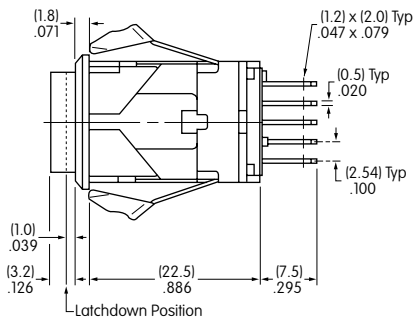

LB26RGW01-12-CJ

Single pole models do not have terminals 4, 5, & 6.

OPTIONAL ACCESSORIES

PCB Adaptors

AT711 Single Pole • Straight PC Terminals

AT712 Double Pole • Straight PC Terminals



Note: Order adaptors separately.

OPTIONAL ACCESSORIES

Barriers



Material: Polyamide



Cutouts for More Than 1 Switch



Square
 $A = .752'' (19.1\text{mm}) \times \text{Number of Switches} + .051'' (1.3\text{mm})$
Rectangular
 $A = .996'' (25.3\text{mm}) \times \text{Number of Switches} + .051'' (1.3\text{mm})$

Protective Guard

AT499 Square Protective Guard

Opens 90°
Closes manually



Material: Polyamide

Protective Guards reduce depth of switch behind panel by .020" (0.5mm).

Spring Loaded Protective Guard

AT4171 Square Protective Guard

Opens 180°
Closes automatically



(N) = Number of switches * Minimum dimension allows opening of cover to 180°

Materials:

Cover: Clear Polycarbonate
 Base: Black GFR Polyamide
 Coil Spring: Stainless Steel

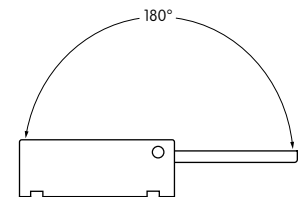

Recommended Panel Thickness:
 .039" ~ .106" (1.0mm ~ 2.7mm)

OPTIONAL ACCESSORIES

AT4057 Rectangular Protective Guard

Opens 90°
Closes manually



Protective Guard

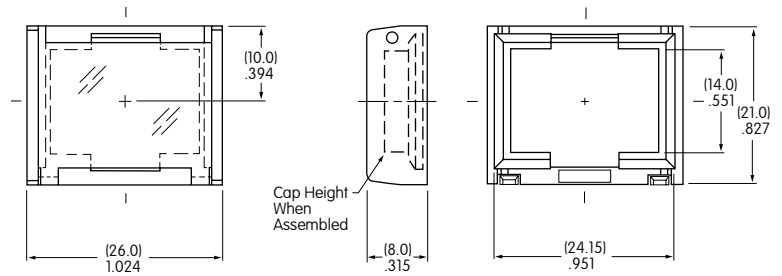

Material: Polyamide

Protective Guards reduce depth of switch behind panel by .020" (0.5mm).

AT4172 Rectangular Protective Guard



Spring Loaded Protective Guard

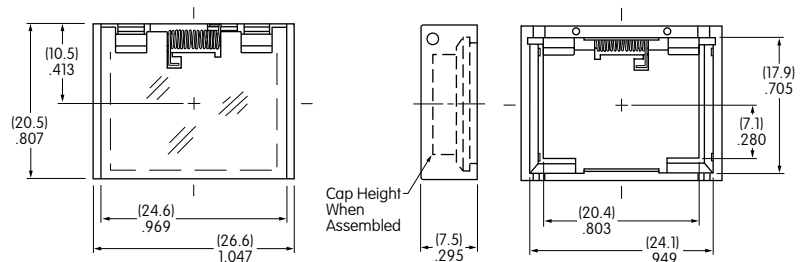

Opens 180°
Closes automatically

Materials:
Cover: Clear Polycarbonate
Base: Black GFR Polyamide
Coil Spring: Stainless Steel

Recommended Panel Thickness:
.039" ~ .106" (1.0mm ~ 2.7mm)

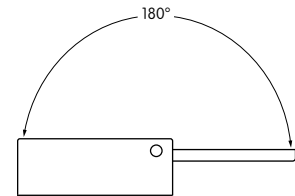

(N) = Number of switches * Minimum dimension allows opening of cover to 180°

Dust Covers

AT4002 Round



AT4001 Square



AT4011 Rectangular

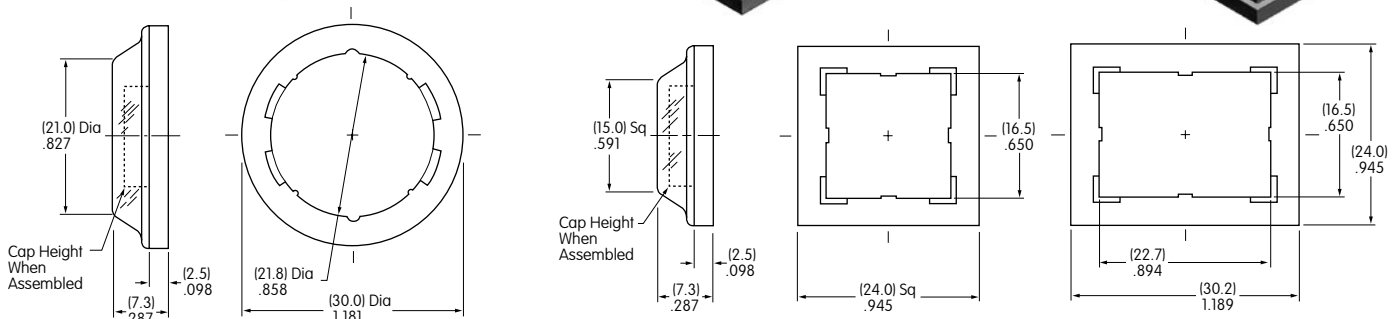
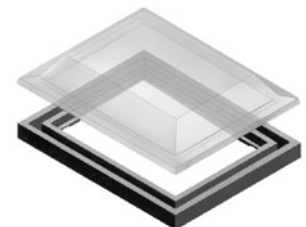

Materials: PVC with polyethylene gasket; PVC loses pliability below 0°C (32°F). Dust Covers reduce depth of switch behind panel by .020" (0.5mm).

ASSEMBLY INSTRUCTIONS

Lamp Installation & LED Orientation

Incandescent & Neon Lamps AT607 & AT607N

Align projections on lamp with grooves (B) in holder when inserting lamp. To correctly join the lamp holder and cap base, match the cut corners (A).



Bright LED AT627

Panel Seal Models

For panel seal models, Bright LED must first be inserted into the lamp socket which is built into the switch. The cap can then be placed on the switch.



Snap-in Models

For snap-in models, Bright LED must be inserted into the cap first. Align cut corners (C) when inserting the LED.



Bright & Super Bright LEDs AT625, AT631, AT632, AT635

Align D-flat on LED with flat (B) in holder when inserting the LED. To correctly join the lamp holder and cap base, match the cut corners (A).

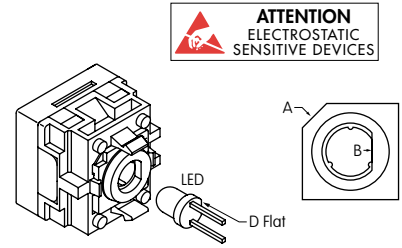

ATTENTION
ELECTROSTATIC
SENSITIVE DEVICES

Switch & Cap Assembly

Round & Rectangular

Match clip on cap assembly with receptacle inside switch. Lamp terminals will then be aligned correctly with lamp socket.

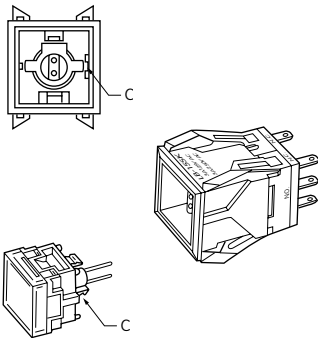
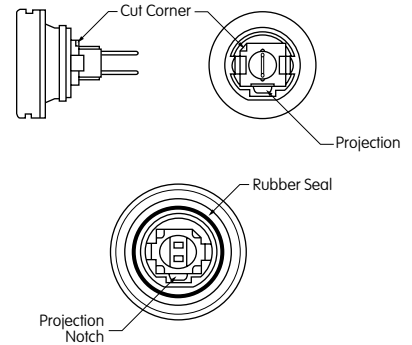

Square

Match projection (C) on cap assembly with groove (C) inside switch. Lamp terminals will then be aligned correctly with lamp socket.

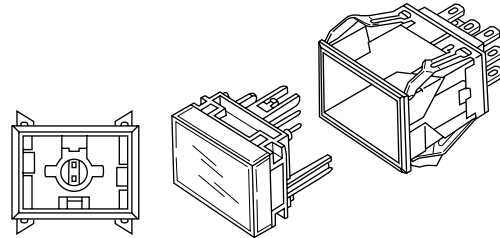

Panel Seal

With Lamps AT607, AT607N, and LEDs AT614, AT625, AT631, AT632: Match projection on cap assembly with notch inside switch. Lamp terminals will then be aligned correctly with lamp socket.

Installation & Maintenance

Snap-in Mount

Snap-in clip holds all switches firmly in place. To mount round switch, match the antirotation projection on switch with guide cut in panel. Snap into panel cutout.



Panel Seal Bushing Mount

Insert switch from the front of the panel with the o-ring between the built-in bezel and the panel. Install mounting nut AT075 (supplied with switch) from the rear of the panel. Overtightening mounting nut may damage the switch housing.



Lamp Replacement

Actuator must be in UP position. Pull off cap with cap extractor AT109. Replace lamp and reassemble as shown above.



AT109
Cap Extractor



AT112
Socket Wrench

Toggles
Rockers
Pushbuttons
Illuminated PB
D
Programmable
Keylocks
Rotaries
Slides
Tactiles
Tilt
Touch
Indicators
Accessories
Supplement

LEGENDS

NKK Switches can provide custom legends for caps. Contact factory for more information.

Suggested Printable Area for Lens

Recommended Methods: Laser Etch on clear lens, Screen Print, or Pad Print on lens.

Epoxy based ink is recommended.



Shaded areas are printable areas.

Suggested Printable Area for Film Insert

Recommended Print Method: Laser Print or Screen Print with Epoxy based ink

Film Insert: Clear Polyester, 4 mil max. thickness



Shaded areas are printable areas.

Данный компонент на территории Российской Федерации

Вы можете приобрести в компании MosChip.

Для оперативного оформления запроса Вам необходимо перейти по данной ссылке:

<http://moschip.ru/get-element>

Вы можете разместить у нас заказ для любого Вашего проекта, будь то серийное производство или разработка единичного прибора.

В нашем ассортименте представлены ведущие мировые производители активных и пассивных электронных компонентов.

Нашей специализацией является поставка электронной компонентной базы двойного назначения, продукции таких производителей как XILINX, Intel (ex.ALTERA), Vicor, Microchip, Texas Instruments, Analog Devices, Mini-Circuits, Amphenol, Glenair.

Сотрудничество с глобальными дистрибьюторами электронных компонентов, предоставляет возможность заказывать и получать с международных складов практически любой перечень компонентов в оптимальные для Вас сроки.

На всех этапах разработки и производства наши партнеры могут получить квалифицированную поддержку опытных инженеров.

Система менеджмента качества компании отвечает требованиям в соответствии с ГОСТ Р ИСО 9001, ГОСТ РВ 0015-002 и ЭС РД 009

Офис по работе с юридическими лицами:

105318, г.Москва, ул.Щербаковская д.3, офис 1107, 1118, ДЦ «Щербаковский»

Телефон: +7 495 668-12-70 (многоканальный)

Факс: +7 495 668-12-70 (доб.304)

E-mail: info@moschip.ru

Skype отдела продаж:

moschip.ru

moschip.ru_4

moschip.ru_6

moschip.ru_9