

# Features

# Regulated Converter

- Wide input range 85-305VAC
- Standby mode optimized (eco design Lot 6)
- High efficiency over the entire load range
- Operating temperature range: -40°C to +90°C
- Class II installations (without FG)
- Overvoltage and overcurrent protected
- EMC compliant without external components

# RECOM

## AC/DC Converter

## RAC3.5-K/277

### 3.5 Watt Single Output

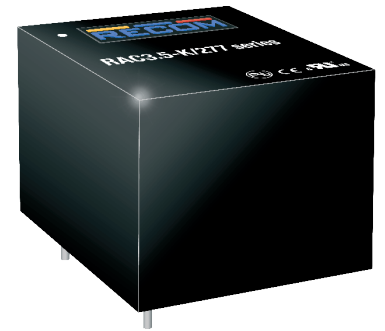

### Description

The RAC3.5-K/277 series are multipurpose 3.5 watt AC/DC power supplies for enhanced mains input conditions from 85VAC up to 305VAC with an extra wide operating temperature range from -40°C to +90°C. These modules are designed to supply worldwide applications in automation, Industry 4.0, IoT, household and smart buildings. For worldwide use they come with international safety certifications for industrial, domestic and ITE as well as household standards. With fully protected outputs, as well as EMC class B emissions compliance without any external components, these are the easiest to use modular power solutions in the industry.

### Selection Guide

Part Number	Input Voltage Range [VAC]	Output Voltage [VDC]	Output Current [mA]	Efficiency typ <sup>(1)</sup> [%]	Max. Capacitive Load <sup>(2)</sup> [µF]
RAC3.5-3.3SK/277	85-305	3.3	1060	77	10000
RAC3.5-05SK/277	85-305	5	700	80	8000
RAC3.5-12SK/277	85-305	12	291	83	1500
RAC3.5-15SK/277	85-305	15	233	83	1000
RAC3.5-24SK/277	85-305	24	146	84	330

#### Notes:

Note1: Efficiency is tested at nominal input and full load at +25°C ambient

Note2: Max Cap Load is tested at nominal input and full resistive load

### Model Numbering



#### Ordering Examples:

RAC3.5-05SK/277	3.5 Watt	5Vout	Single Output
RAC3.5-24SK/277	3.5 Watt	24Vout	Single Output

- UL62368-1 certified
- EN62368-1 certified
- IEC/EN60335-1 certified
- EN62233 certified
- IEC/EN61558-1 certified
- IEC/EN61558-2-16 certified
- EN55032 compliant
- EN55014-1(-2) compliant
- CB Report

**Specifications** (measured @ Ta= 25°C, nom. Vin, full load and after warm-up unless otherwise stated)

**BASIC CHARACTERISTICS**

Parameter	Condition		Min.	Typ.	Max.
Internal Input Filter			Pi type		
Input Voltage Range <sup>(3,4)</sup>	nom. Vin = 277VAC		85VAC 120VDC	277VAC	305VAC 430VDC
Input Current	115VAC 230VAC 277VAC			110mA 80mA 60mA	
Inrush Current	cold start at +25°C	115VAC 230VAC 277VAC			15A 30A 35A
No Load Power Consumption					100mW
ErP Lot 6 Standby Mode Conformity (Output Load Capability)	Input Power= 0.5W 1.0W				0.34W 0.70W
Input Frequency Range			47Hz		63Hz
Minimum Load			0%		
Power Factor	115VAC 230VAC 277VAC		0.50 0.40 0.35		
Start-up Time				20ms	
Rise Time				10ms	
Hold-up Time	115VAC 230VAC 277VAC			20ms 25ms 90ms	
Internal Operating Frequency	100% load at nominal Vin			130kHz	
Output Ripple and Noise <sup>(6)</sup>	20MHz BW	3.3, 5Vout others		60mVp-p 1% of Vout	

**Notes:**

- Note3: The products were submitted for safety files at AC-Input operation
- Note4: Refer to „Line Derating“
- Note5: Measurements are made with a 0.1µF MLCC & 10µF E-cap in parallel across output. (low ESR)

**Efficiency vs. Load**

**RAC3.5-05SK/277**

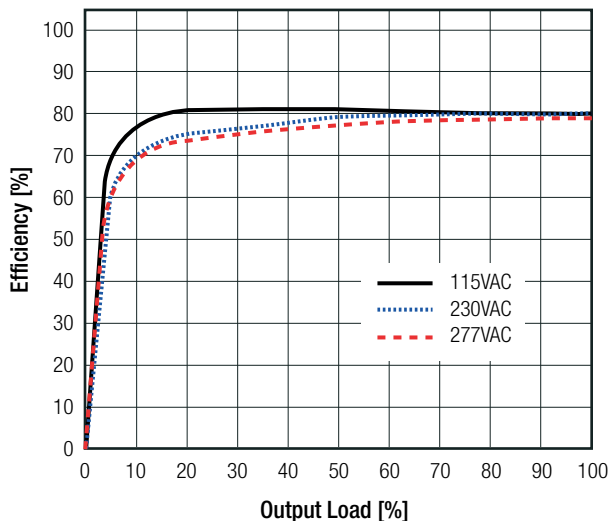

**RAC3.5-12SK/277**

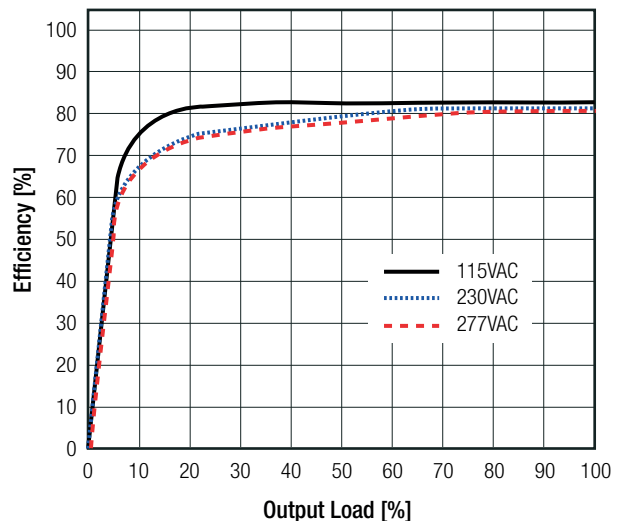

**Specifications** (measured @ Ta= 25°C, nom. Vin, full load and after warm-up unless otherwise stated)

**REGULATIONS**

Parameter	Condition	Value
Output Accuracy		±1.0% typ.
Line Regulation	low line to high line, full load	±0.5% typ.
Load Regulation <sup>(6)</sup>	10% to 100% load	1.0% typ.
Transient Response	25% load step change	4.0% max.
	recovery time	500µs typ.

**Notes:**

Note6: Operation below 10% load will not harm the converter, but specifications may not be met

**Deviation vs. Load**

(at 115VAC, 230VAC, 277VAC)

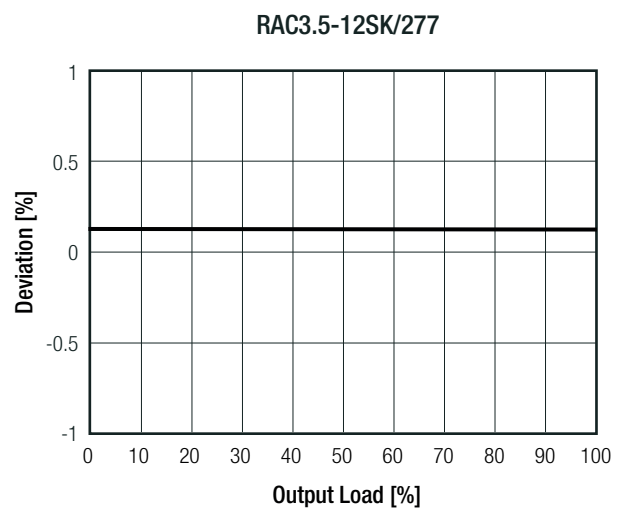
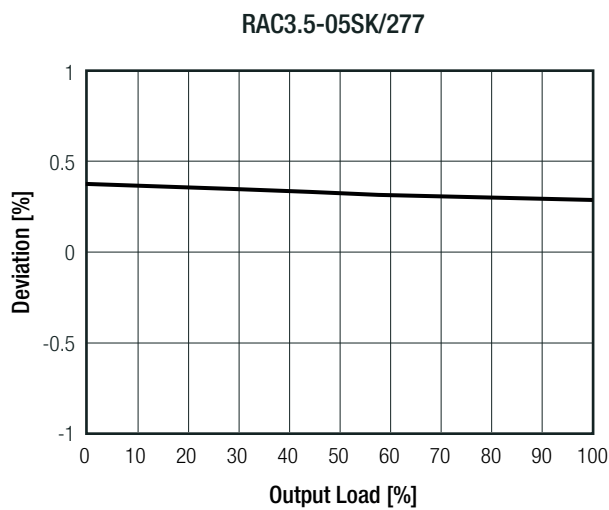

**PROTECTIONS**

Parameter	Type	Value
Input Fuse <sup>(7)</sup>	internal	T1A, slow blow
Short Circuit Protection (SCP)	below 100mΩ	hiccup, automatic restart
Over Voltage Protection (OVP)		125% - 195%, latch of mode
Over Voltage Category		OVCII
Over Current Protection (OCP)		175% - 275%, hiccup mode
Class of Equipment		Class II
Isolation Voltage <sup>(8)</sup>	I/P to O/P	1 minute
Isolation Resistance		Viso= 500VDC
Isolation Capacitance		100pF max.
Insulation Grade		reinforced
Leakage Current		0.25mA max.

**Notes:**

Note7: Refer to local safety regulations if input over-current protection is also required

Note8: For repeat Hi-Pot testing, reduce the time and/or the test voltage

continued on next page

**Specifications** (measured @ Ta= 25°C, nom. Vin, full load and after warm-up unless otherwise stated)

### Peak Load Capability

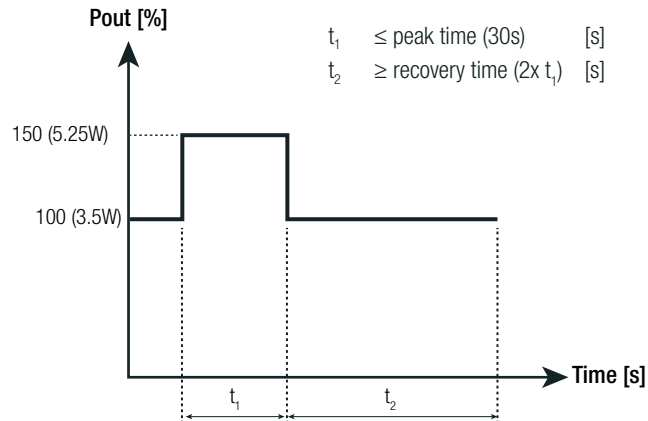

### ENVIRONMENTAL

Parameter	Condition		Value
Operating Temperature Range	@ natural convection 0.1m/s	full load	-40°C to +80°C
		refer to „Derating Graph“	-40°C to +90°C
Maximum Case Temperature			+95°C
Temperature Coefficient			0.05%/K
Operating Altitude <sup>(9)</sup>			5000m
Operating Humidity	non-condensing		5% - 95% RH max.
Pollution Degree			PD2
Vibration	according to MIL-STD-202G		10-500Hz, 2G 10min./1cycle, period 60min. each along x,y,z axis
MTBF	according to MIL-HDBK-217F, G.B.	+25°C	>600 x 10 <sup>3</sup> hours
Design Lifetime	230VAC	+25°C	125 x 10 <sup>3</sup> hours
		+70°C	34 x 10 <sup>3</sup> hours
	277VAC	+25°C	105 x 10 <sup>3</sup> hours
		+70°C	27 x 10 <sup>3</sup> hours

#### Notes:

Note9: Recognized by UL for safe operation up to 5000m. High altitude operation may impact the performance and lifetime. Contact RECOM tech support for advice

### Derating Graph

(@ Chamber and natural convection 0.1m/s)

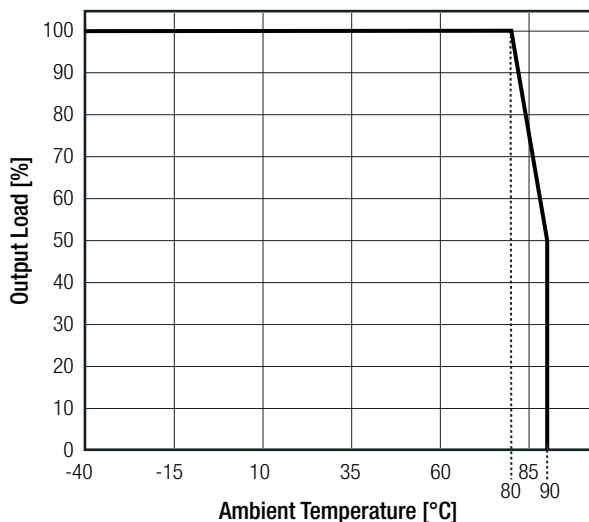

### Line Derating

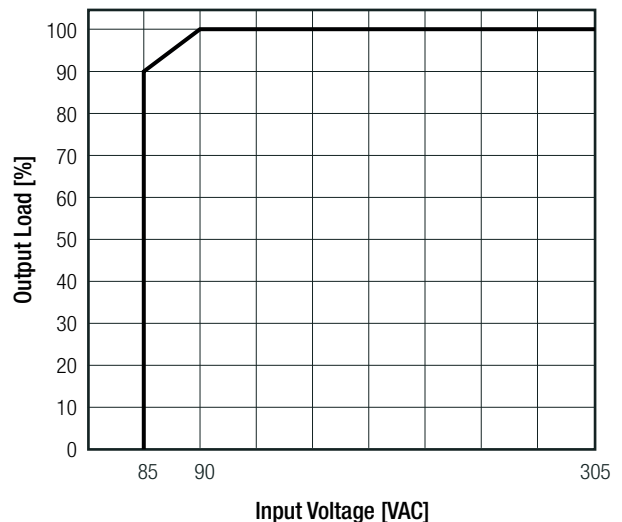

**Specifications** (measured @ Ta= 25°C, nom. Vin, full load and after warm-up unless otherwise stated)

<b>SAFETY AND CERTIFICATIONS</b>		
<b>Certificate Type (Safety)</b>	<b>Report / File Number</b>	<b>Standard</b>
Audio/Video, information and communication technology equipment - Part 1: Safety requirements	E491408-A6004-UL	UL62368-1, 2nd Edition, 2014-12-01 CAN/CSA-C22.2 No. 62368-1-14, 2nd Edt., 2014-12
Audio/Video, information and communication technology equipment - Part 1: Safety requirements (CB Scheme)	E491408-A6007-CB-1	IEC62368-1:2014 2nd Edition
Audio/Video, information and communication technology equipment - Part 1: Safety requirements (LVD)		EN62368-1:2014 + A11:2017
Household and similar electrical appliances - Safety - Part 1: General requirements	LCS190308001CS	IEC60335-1:2010 + A2:2016 + C1:2016, 5th Edt. EN60335-1:2012 + A13:2017
Measurement methods for electromagnetic fields of household appliances and similar apparatus with regard to human exposure		EN62233:2008
Safety of power transformers, power supplies, reactors and similar products for supply voltages up to 1100 V (CB Scheme)	50230493 001	IEC61558-1:2005 2nd Edition + A1:2009
Safety of power transformers, power supplies, reactors and similar products for supply voltages up to 1100 V Part 2: Particular requirements (CB Scheme)		IEC61558-2-16:2009 1st Edition + A1:2013
Safety of power transformers, power supplies, reactors and similar products for supply voltages up to 1100 V		EN61558-1:2005 + A1:2009
Safety of power transformers, power supplies, reactors and similar products for supply voltages up to 1100 V Part 2: Particular requirements		EN61558-2-16:2009 + A1:2013
RoHS2		RoHS-2011/65/EU + AM-2015/863
<b>EMC Compliance</b>		
<b>EMC Compliance</b>	<b>Conditions</b>	<b>Standard / Criterion</b>
Low-voltage power supplies DC output - Part 3: Electromagnetic compatibility		EN61204-3: 2018, Class B
Electromagnetic compatibility of multimedia equipment - Emission requirements <sup>(1)</sup>		EN55032:2015, Class B
Electromagnetic compatibility - Requirements for household appliances, electric tools and similar apparatus - Part 1: Emission		EN55014-1:2006 + A2:2011
Information technology equipment - Immunity characteristics - Limits and methods of measurement		EN55024:2010 + A1:2015
Electromagnetic compatibility - Requirements for household appliances, electric tools and similar apparatus - Part 2: Immunity		EN55014-2:2015
ESD Electrostatic discharge immunity test	Air: ±2, 4, 8kV Contact: ±2, 4kV	EN61000-4-2: 2009, Criteria B
Radiated, radio-frequency, electromagnetic field immunity test	10V/m, 80MHz-1GHz 3V/m, 1.4GHz-2GHz 1V/m, 2GHz-2.7GHz	EN61000-4-3: 2006 + A1, 2009, Criteria A
Fast Transient and Burst Immunity	AC and DC Port: ±2kV	EN61000-4-4: 2012, Criteria B
Surge Immunity	AC In Port (L-N): ±1kV DC Output Port: ±0.5kV	EN61000-4-5: 2014 +A1:2017, Criteria B
Immunity to conducted disturbances, induced by radio-frequency fields	AC and DC Port: 10V	EN61000-4-6: 2014, Criteria A
Power Magnetic Field Immunity	50Hz, 30A/m	EN61000-4-8: 2010, Criteria A
Voltage Dips and Interruptions	Voltage Dips: 30% Voltage Dips: 60% Voltage Dips: 100% Interruptions: >95%	EN61000-4-11:2004 + A1:2017, Criteria C EN61000-4-11:2004 + A1:2017, Criteria C EN61000-4-11:2014 + A1:2017, Criteria B EN61000-4-11: 2014 + A1:2017, Criteria C
Voltage Fluctuations and Flicker in Public Low-Voltage Systems ≤16A per phase		EN61000-3-3: 2013
Limitations on the amount of electromagnetic interference allowed from digital and electronic devices		FCC 47 CFR Part 15 Subpart B, Class B
Methods of Measurement of Radio-Noise Emissions from Low-Voltage Electrical and Electronic Equipment in the Range of 9 kHz to 40 GHz		ANSI C63.4-2014, Class B
<p><b>Notes:</b></p> <p>Note11: If output is connected to GND, please contact RECOM tech support for advice</p>		

**Specifications** (measured @ Ta= 25°C, nom. Vin, full load and after warm-up unless otherwise stated)

### DIMENSION AND PHYSICAL CHARACTERISTICS

Parameter	Type	Value
Material	case, baseplate potting PCB	black plastic, (UL94V-0) silicone, (UL94V-0) FR4, (UL94V-0)
Dimension (LxWxH)		31.7 x 26.7 x 21.8mm
Weight		31.5g typ.

#### Dimension Drawing (mm)

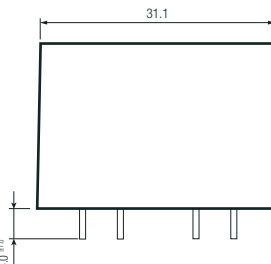
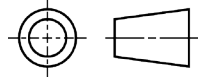
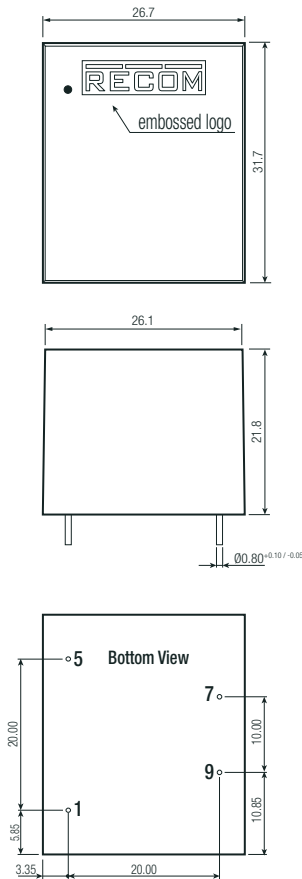

#### Pin Connections

Pin #	Single
1	VAC in (N)
5	VAC in (L)
7	+Vout
9	-Vout

Tolerance: xx.x= ±0.8mm  
xx.xx= ±0.25mm

### PACKAGING INFORMATION

Parameter	Type	Value
Packaging Dimension (LxWxH)	tube	466.0 x 30.4 x 29.3mm
Packaging Quantity	tube	12pcs
Storage Temperature Range		-40°C to +85°C
Storage Humidity	non-condensing	20% to 90% RH max.

The product information and specifications may be subject to changes even without prior written notice. The product has been designed for various applications; its suitability lies in the responsibility of each customer. The products are not authorized for use in safety-critical applications without RECOM's explicit written consent. A safety-critical application is an application where a failure may reasonably be expected to endanger or cause loss of life, inflict bodily harm or damage property. The applicant shall indemnify and hold harmless RECOM, its affiliated companies and its representatives against any damage claims in connection with the unauthorized use of RECOM products in such safety-critical applications.

## Данный компонент на территории Российской Федерации

### Вы можете приобрести в компании MosChip.

Для оперативного оформления запроса Вам необходимо перейти по данной ссылке:

<http://moschip.ru/get-element>

Вы можете разместить у нас заказ для любого Вашего проекта, будь то серийное производство или разработка единичного прибора.

В нашем ассортименте представлены ведущие мировые производители активных и пассивных электронных компонентов.

Нашей специализацией является поставка электронной компонентной базы двойного назначения, продукции таких производителей как XILINX, Intel (ex.ALTERA), Vicor, Microchip, Texas Instruments, Analog Devices, Mini-Circuits, Amphenol, Glenair.

Сотрудничество с глобальными дистрибьюторами электронных компонентов, предоставляет возможность заказывать и получать с международных складов практически любой перечень компонентов в оптимальные для Вас сроки.

На всех этапах разработки и производства наши партнеры могут получить квалифицированную поддержку опытных инженеров.

Система менеджмента качества компании отвечает требованиям в соответствии с ГОСТ Р ИСО 9001, ГОСТ РВ 0015-002 и ЭС РД 009

### Офис по работе с юридическими лицами:

105318, г.Москва, ул.Щербаковская д.3, офис 1107, 1118, ДЦ «Щербаковский»

Телефон: +7 495 668-12-70 (многоканальный)

Факс: +7 495 668-12-70 (доб.304)

E-mail: [info@moschip.ru](mailto:info@moschip.ru)

Skype отдела продаж:

moschip.ru

moschip.ru\_4

moschip.ru\_6

moschip.ru\_9