



# 7000 series

## Industrial Electropneumatic Timing Relay



File E15631



File LR29186



Note: 7032 types and certain models with accessories are not agency approved.

Users should thoroughly review the technical data before selecting a product part number. It is recommended that users also seek out the pertinent approvals files of the agencies/laboratories and review them to confirm the product meets the requirements for a given application.

Consult factory for ordering information.

### Design Features

- Available in on-delay, true off-delay, and on/off-delay.
- Timing from 0.1 seconds to 60 minutes, in linear increments.
- Oversize time-calibrated adjustment knobs, serrated with high-resolution markings visible from all angles makes the timer easy to set.
- Inherent transient immunity.
- Standard voltages from 6-550VAC and 12-550VDC (special voltages available.)
- Available in 2-pole or 4-pole models.
- Numerous enclosure options: explosion proof, dust tight, watertight, hermetically-sealed, NEMA 1.
- Auxiliary timed and instantaneous switches can be added for greater switching flexibility.
- Many mounting options: Surface mount, Panel mount, Octal plug-in mounting.
- Options: quick-connect terminals, dial stops, and transient protection module.
- Easy-to-reach screw terminals, all on the face of the unit, clearly identified.
- Modular assembly - timing head, coil assembly and switchblock are all individual modules, with switches field-replaceable.

### Design & Construction

There are three main components of Series 7000 Timing Relays:

**Calibrated Timing Head** uses no needle valve, recirculates air under controlled pressure through a variable orifice to provide linearly adjustable timing. Patented design provides instant recycling, easy adjustment and long service life under severe operating conditions.

**Precision-Wound Potted Coil** module supplies the initial motive force with minimum current drain. Total sealing without external leads eliminates moisture problems, gives maximum insulation value.

**Snap-Action Switch Assembly** - custom-designed over-center mechanism provides greater contact pressure up to transfer time for positive, no flutter action. Standard switches are DPDT arrangement, with flexible beryllium copper blades and silver-cadmium oxide contacts. Special "timing-duty" design assures positive wiping action, sustained contact pressure and greater heat dissipation during long delay periods.

Each of these subassemblies forms a self-contained module which is then assembled at the factory with the other two to afford a wide choice of operating types, coil voltages, and timing ranges.

The squared design with front terminals and rear mounting permits the grouping of Series 7000 units side-by-side in minimum panel space. Auxiliary switches may be added in the base of the unit, without affecting the overall width or depth.

### Operation

Two basic operating types are available.

"On-Delay" models provide a delay period on energization, at the end of which the switch transfers the load from one set of contacts to another. De-energizing the unit during the delay period immediately recycles the unit, readying it for another full delay period on re-energization.

In "Off-Delay" models the switch transfers the load immediately upon energization, and the delay period does not begin until the unit is de-energized. At the end of the delay period the switch returns to its original position. Re-energizing the unit during the delay period immediately resets the timing, readying it for another full delay period on de-energization. No power is required during the timing period.

In addition to these basic operating types, "Double-Head" models offer sequential delays on pull-in and drop-out in one unit. With the addition of auxiliary switches the basic models provide two-step timing, pulse actuation for interlock circuits, or added circuit capacity.

**NOTE: Seismic & radiation tested E7000 models are available. Consult factory for detailed information.**

### On-delay model 7012 (delay on pickup)

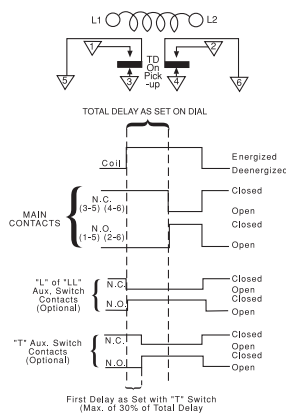

Applying continuous voltage to the coil (L1-L2) starts a time delay lasting for the preset time. During this period the normally closed contacts (3-5 and 4-6) remain closed. At the end of the delay period the normally closed contacts break and the normally open contacts (1-5 and 2-6) make. The contacts remain in this transferred position until the coil is deenergized, at which time the switch instantaneously returns to its original position.

De-energizing the coil, either during or after the delay period, will recycle the unit within 50 msec.

It will then provide a full delay period upon re-energization, regardless of how often the coil voltage is interrupted before the unit has been permitted to "time-out" to its full delay setting.

### Off-delay model 7022 (delay on dropout)

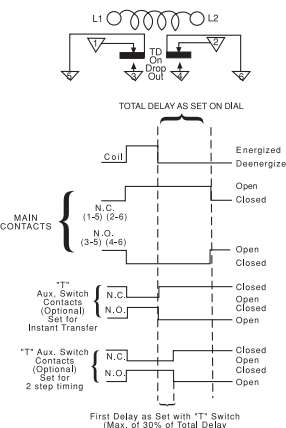

Applying voltage to the coil (for at least 50 msec) will instantaneously transfer the switch, breaking the normally closed contacts (1-5 and 2-6), and making the normally open contacts (3-5 and 4-6). Contacts remain in this transferred position as long as the coil is energized. The time delay begins immediately upon de-energization. At the end of the delay period the switch returns to its normal position.

Re-energizing the coil during the delay period will immediately return the timing mechanism to a point where it will provide a full delay period upon subsequent de-energization. The switch remains in the transferred position.

To increase the versatility of the basic timer models, auxiliary switches may be added to either on-delay or off-delay types. They switch additional circuits, provide two-step timing action, or furnish electrical interlock for sustained coil energization from a momentary impulse, depending on the type selected and its adjustment. Because of their simple attachment and adjustment features, they can be installed at the factory or in the field, by any competent mechanic. All auxiliary switches are SPDT with UL listings of 10A @ 125, 250, or 480 VAC. A maximum of one Code T or two Code L auxiliary switches may be added to each relay. The L or LL switch is available with on-delay relays only. The T switch is available with both the on-delay and off-delay relays.

**Auxiliary Switch Options for On-Delay Instant Transfer (Auxiliary Switch Code L, maximum of 2 per relay.)**

1. Energizing coil begins time delay and transfers auxiliary switch.
2. Main switch transfers after total preset delay.
3. De-energizing coil resets both switches instantly.

Auxiliary switch is nonadjustable.

**Two-Step Timing (Auxiliary Switch Code T, maximum of 1 per relay.)**

**Auxiliary switch options**

To increase the versatility of the basic timer models, auxiliary switches may be added to either on-delay or off-delay types. They switch additional circuits, provide two-step timing action, or furnish electrical interlock for sustained coil energization from a momentary impulse, depending on the type selected and its adjustment. Because of their simple attachment and adjustment features, they can be installed at the factory or in the field, by any competent mechanic. All auxiliary switches are SPDT with UL listings of 10A @ 125, 250, or 480 VAC. A maximum of one Code T or two Code L auxiliary switches may be added to each relay. The L or LL switch is available with on-delay relays only. The T switch is available with both the on-delay and off-delay relays.

**Auxiliary Switch Options for On-Delay**

**Instant Transfer (Auxiliary Switch Code L, maximum of 2 per relay.)**

1. Energizing coil begins time delay and transfers auxiliary switch.
2. Main switch transfers after total preset delay.
3. De-energizing coil resets both switches instantly.

**Two-Step Timing (Auxiliary Switch Code T, maximum of 1 per relay.)**

1. Energizing coil begins time delay.
2. After first delay auxiliary switch transfers.
3. Main switch transfers after total preset delay.

4. De-energizing coil resets both switches instantly. First delay is independently adjustable, up to 30% of overall delay. (Recommended maximum 100 seconds.)

**Auxiliary Switch Options for Off-Delay**

In these models the same auxiliary switch provides either two-step timing or instant transfer action, depending on the adjustment of the actuator.

**Two-Step Timing (Auxiliary Switch Code T, maximum of 1 per relay.)**

1. Energizing coil transfers main and auxiliary switches instantly.
2. De-energizing coil begins time delay.
3. After first delay auxiliary switch transfers.
4. Main switch transfers after total preset delay. First delay is independently adjustable, up to 30% of overall delay. (Recommended maximum 100 seconds.)

**Instant Transfer (Auxiliary Switch Code L, maximum of 1 per relay.)**

1. Energizing coil transfers main and auxiliary switches instantly.
2. De-energizing coil resets auxiliary switch and begins time delay.
3. Main switch transfers after total preset delay.

Auxiliary switch is factory adjusted to give instant transfer operation, but may be easily adjusted in the field to provide two-step timing.

**On-delay, off-delay model 7032 (double head)**

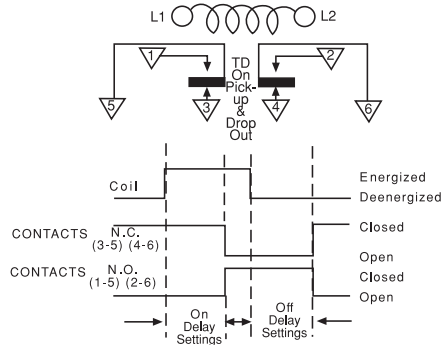

The Double Head model provides delayed switch transfer on energization of its coil, followed by delayed resetting upon coil de-energization. Each delay period is independently adjustable.

In new circuit designs or the improvement of existing controls now using two or more conventional timers, the Double Head unit offers distinct advantages.

Its compact design saves precious panel space, while the simplified wiring reduces costly interconnection.

**Four pole model 7014. 7024**

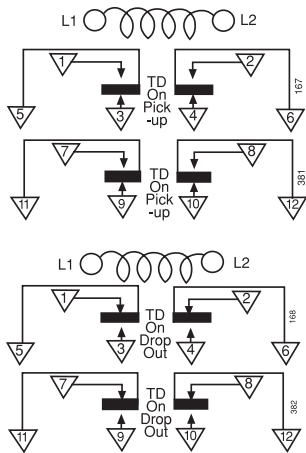

With the addition of an extra switch block at the bottom of the basic unit, this version of the Series 7000 offers four pole switch capacity with simultaneous timing or two-step timing. The two-step operation is achieved by factory adjustment to your specifications.

For two-step operation, a maximum timing ratio between upper and lower switches of 3:2 is recommended. Once adjusted at the factory, this ratio remains constant regardless of changes in dial settings. (Ex: If upper switch transfer is set on dial at 60 sec., minimum time on lower switch should be 40 sec.)

This Series 7000 unit offers many of the performance features found in basic models - voltage ranges, timing and switch capacities are virtually identical.

Four pole models add approximately 1-1/4" to the maximum height of the basic model, approximately 1/8" to the depth. They are designed for vertical operation only.

**Surge/transient protection option**



**Features**

- Protect electronic control circuits from voltage transients generated by the timer coil.
- Fast response to the rapidly rising back E.M.F.
- High performance clamping voltage characteristics.
- UL recognized, (except varistor and coil together).
- Timer NOT polarity sensitive.

The Surge/Transient Protection Option protects electronic control circuits from transients and surges which are generated when the timer coil is activated. Built with a minimum of moving parts, the unit provides a fast response to rapidly rising voltage transients. The accurate, precision-made device is not polarity sensitive and permits the user to initiate, delay, sequence and program equipment actions over a wide range of applications under the most severe operating conditions.

It consists of a specially modified coil case, varistor, varistor cover, terminal extensions and cup washers so that normal terminations can be used. The varistor will not affect the operating characteristics of the 7000 Timer. The varistor has bilateral and symmetrical voltage and current characteristics and therefore can be used in place of the back-to-back zener diodes. This characteristic also means that the coil will not be polarity sensitive.

**Transient Suppressor Option "V"**

Dimensions are shown for reference purposes only.

Dimensions are in inches over (millimeters) unless otherwise specified.

Specifications and availability subject to change.

www.tycoelectronics.com  
Technical support:  
Refer to inside back cover.

**Timing Specifications** (All values shown are at nominal voltage and 25°C unless otherwise specified).

**Operating Modes:**

- Model 7012/7014:** On-delay (delay on pick-up).
- Model 7022/7024:** Off-delay (delay on drop-out).
- Model 7032:** On-delay, off-delay (double head).

**Timing Adjustment:** Timing is set by simply turning the dial to the desired time value. In the zone of approximately 25° separating the high and low end of timing ranges A,D,E, and K, instantaneous operation (no time delay) will occur. All other ranges produce an infinite time delay when the dial is set in this zone.

Models 7014 and 7032 are available with letter-calibrated dials only. The upper end of the time ranges in these models may be twice the values shown.

Linear Timing Ranges:	Code	Models 7012, 7022, 7024	Models 7014, 7032
	A	.1 to 1 Sec.	.2 to 2 Sec.
	B	.5 to 5 Sec.	.7 to 7 Sec.
	C	1.5 to 15 Sec	2 to 20 Sec.
	D	5 to 50 Sec.	10 to 100 Sec.
	E	20 to 200 Sec.	30 to 300 Sec.
	F	1 to 10 Min.	1.5 to 15 Min.
	H	3 to 30 Min.	3 to 30 Min.
	I	6 to 60 Min.	Not Avail.
	J	3 to 120 Cyc.	Not Avail.
	K	1 to 300 Sec.	Not Avail.

**Repeat Accuracy:**

For delays of 200 seconds or less:	7012*, 7022, 7024:	±5%
	7014*:	±10%
	7032:	±15%
For delays greater than 200 seconds:	7012*, 7022, 7014*, 7024:	±10%
	7032:	±15%

\* The first time delay afforded by Model 7012 with H (3 to 30 min.) and I (6 to 60 min.) time ranges or Model 7014 with H time range will be approx. 15% longer than subsequent delays due to coil temperature rise.

**Reset Time:** 50 msec. (except model 7032)

**Relay Release Time:** 50 msec. for on-delay models (7012/7014)

**Relay Operate Time:** 50 msec. for off-delay models (7022/7024)

**Operating Voltage Coil Data (for DPDT)**

Coil Part #	Code Letter	Rated Voltage	Operating* Voltage Range @ 60Hz	Rated Voltage	Operating Voltage Range @50Hz
7000	A	120	102-132	110	93.5-121
	B	240	204-264	220	187-242
	C	480	408-528		
	D	550	468-605		
	E	24	20.5-26.5		
AC	F			127	108-140
	G			240	204-264
	H	12	10.2-13.2		
	I	6	5.1-6.6		
	J	208	178-229		
	K		Dual Voltage Coil (Combines A&B)		
	L		Special AC Coils (L1, L2, etc.)		
7010	M	28	22.4-30.8		
	N	48	38.4-52.8		
	O	24	19.2-26.4		
	P	125	100-137.5		
	Q	12	9.6-13.2		
	R	60	48-66		
	S	250	200-275		
	T	550	440-605		
DC	U	16	12.8-17.6		
	V	32	25.8-35.2		
	W	96	76.8-105.6		
	Y	6	4.8-6.6		
	Z	220	176-242		
	X		Special DC Coils (X1, X2, etc.)		

\*Four pole Models: Operational voltage range 90% to 110% for AC units; 85% to 110% for DC units.

See next column for more coil data.

Minimum operating voltages are based on vertically mounted 7012 units. 7012 horizontally mounted or 7022 vertically or horizontally mounted units will operate satisfactorily at minimum voltages approximately 5% lower than those listed. AC units drop out at approximately 50% of rated voltage. DC units drop out at approximately 10% of rated voltage. All units may be operated on intermittent duty cycles at voltages 10% above the listed maximums (intermittent duty - maximum 50% duty cycle and 30 minutes "on" time.)

**Surge/Transient Protection Option Characteristics (DC Timers Only)**

Coil Voltage Nominal (DC)	Max Excess Energy Capacity (Joule)	Max De-energization Transient Voltage
12 V	0.4 J	48 V
24 V	1.8 J	93 V
28 V	1.8 J	93 V
32 V	2.5 J	135 V
48 V	3.57 J	145 V
60 V	6 J	250 V
96 V	10 J	340 V
110 V	10 J	340 V
125 V	10 J	340 V
220 V	17 J	366 V
250 V	17 J	366 V

**Surge Life**

Applied 100,000 times continuously with the interval of 10 seconds at room temperature. Below 68 VAC: 12A; Above 68 VAC: 35A

**Temperature Range**

Operating: -22°F to +167°F (-30°C to +75°C)

Storage: -40°F to +167°F (-40°C to +75°C)

**Output/Life Contact Ratings:** Contact Capacity in Amps (Resistive Load)

Contact Voltage	Min. 100,000 Operations	Min. 1,000,000 Operations
30 VDC	15.0	7.0
110 VDC	1.0	0.5
120 V 60Hz	20.0	15.0
240 V 60Hz	20.0	15.0
480 V 60Hz	12.0	10.0

10 Amps Resistive, 240 VAC  
1/4 Horsepower, 120 VAC/240VAC (per pole)  
15 Amps 30 VDC (per pole)  
5 Amps, General Purpose, 600VAC (per pole)

**Dielectric:** Withstands 1500 volts RMS 60Hz between terminals and ground. 1,000 volts RMS 60 Hz between non-connected terminals. For dielectric specification on hermetically sealed models consult factory.

**Insulation Resistance:** 500 Megohms with 500VDC applied.

**Temperature Range: Operating:** -20°F to +165°F (-29°C to 74°C)

**Storage:** -67°F to +165°F (-55°C to 74°C)

**Temperature Variation:** Using a fixed time delay which was set and measured when the ambient temperature was 77°F (25°C), the maximum observed shift in the average of three consecutive time delays was -20% at -20°F (-29°C) and +20% at 165°F (74°C).

**Mounting/Terminals:** Normal mounting of the basic unit is in a vertical position, from the back of the panel. A front mounting bracket is also supplied with each basic unit, for installation from the front of the panel.

**All units are calibrated for vertical operation.** Basic models (7012, 7022) may also be horizontally mounted, and will be adjusted accordingly **when Accessory Y1 is specified in your order.**

Standard screw terminals (8-32 truss head screws supplied) are located on the front of the unit, with permanent schematic markings. Barrier isolation is designed to accommodate spade or ring tongue terminals, with spacing to meet all industrial control specifications.

The basic Series 7000 may also be panel mounted with the addition of a panelmount kit that includes all necessary hardware and faceplate. This offers the convenience of "out-front" adjustment, with large calibrated dial skirt knob. The faceplate and knob blend with advanced equipment and console designs, while the body of the unit and its wiring are protected behind the panel.

Other mounting options include plug-in styles and special configurations to meet unusual installation requirements. Contact factory for details.

**Power Consumption:** Approximately 8 watts power at rated voltage .

**Approximate Weights:**

Models 7012, 7022 . . . . .	2 lbs. 4 ozs.
7014, 7024 . . . . .	2 lbs. 10 ozs.
7032 . . . . .	3 lbs. 5 ozs.

Weight may vary slightly with coil voltage.

**Outline Dimensions** (Dimensions in inches).

**Models 7012, 7022**

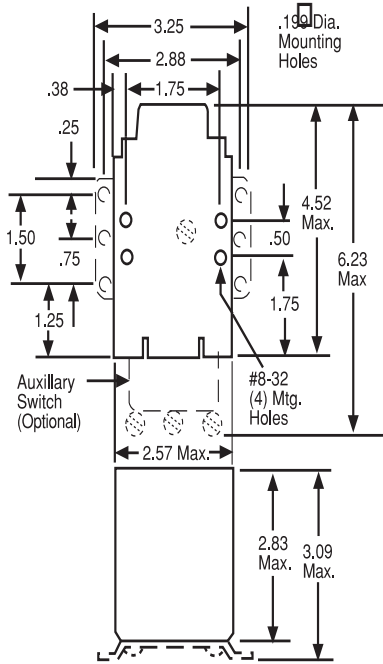

**Models 7014, 7024**

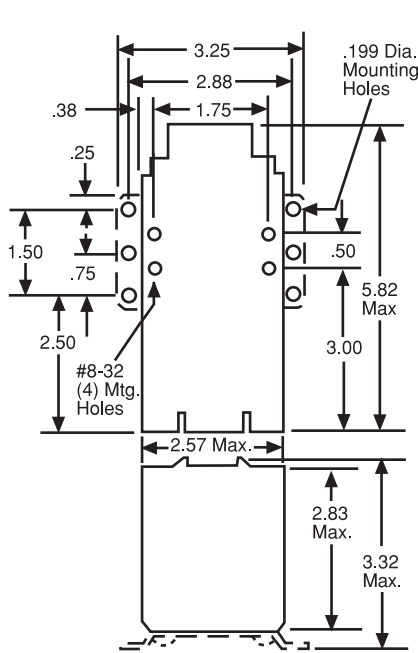

**Model 7032**

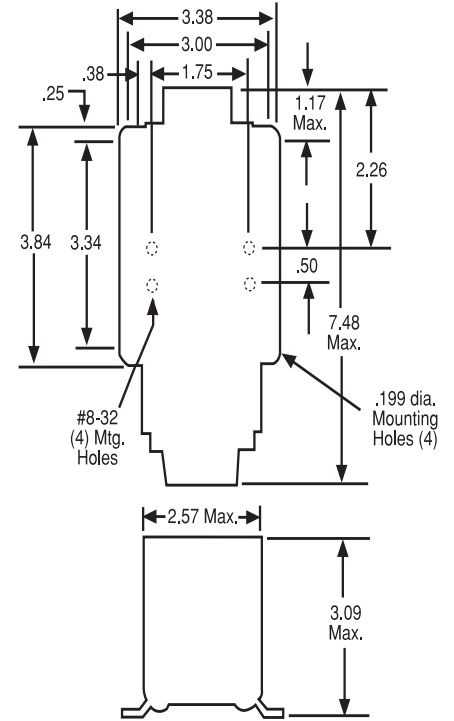

**Panel mount Option "X"**

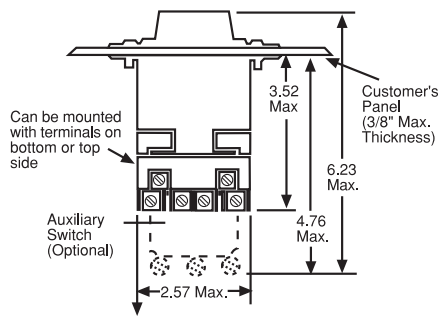

**Surge/Transient Protection Option**

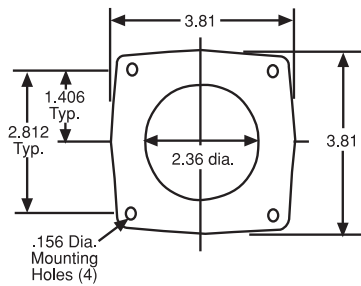
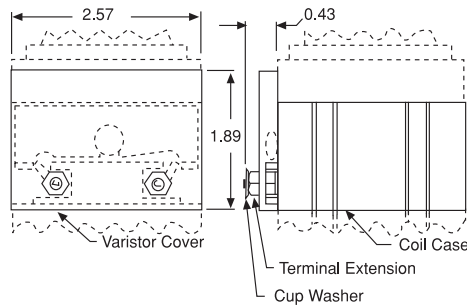

**Ordering Information**

Typical Part No. ▶	70	1	2	A	D	GZ
<b>1. Basic Series:</b> 70 = 7000 series electropneumatic timing relay						
<b>2. Operation:</b> 1 = On-delay                      3 = On-delay, off-delay (double head) 2 = Off-delay						
<b>3. Contact Arrangement:</b> 2 = 2PDT (2 form C)            **4 = 4PDT (4 form C)						
<b>4. Coil Voltage:</b>						
<b>AC Coils</b>			<b>DC Coils</b>			
A = 120VAC, 60 Hz.; 110VAC, 50Hz.			M = 28VDC			
B = 240VAC, 60 Hz.; 220VAC, 50Hz.			N = 48VDC			
C = 480VAC, 60 Hz.			O = 24VDC			
D = 550VAC, 60 Hz.			P = 125VDC			
E = 24VAC, 60 Hz.			Q = 12VDC			
F = 127VAC, 50 Hz.			R = 60VDC			
G = 240VAC, 50Hz.			S = 250VDC			
H = 12VAC, 60 Hz.			T = 550VDC			
K = Dual voltage (combines A & B)			U = 16VDC			
L = Special AC coils (L1, L2, etc.)			V = 32VDC			
			W = 96VDC			
			Y = 6VDC			
			Z = 220VDC			
			X = Special DC coils (X1, X2, etc.)			
<b>5. Timing Range:</b>						
<b>Models 7012, 7022 &amp; 7024</b>			<b>†Models 7014 &amp; 7032</b>			
A = .1 to 1 sec.			For model 7032 specify separate time range code for each head. Example: AB.			
B = .5 to 5 sec.			Any two ranges may be selected.			
C = 1.5 to 15 sec.			A = .2 to 2 sec.			
D = 5 to 50 sec.			B = .7 to 7 sec.			
E = 20 to 200 sec.			C = 2 to 20 sec.			
F = 1 to 10 min.			D = 10 to 100 sec.			
H = 3 to 30 min.			E = 30 to 300 sec.			
I = 6 to 60 min.			F = 1.5 to 15 min.			
J = 3 to 120 cyc.			H = 3 to 30 min.			
K = 1 to 300 sec.						
<b>6. Options:</b>						
A1 = Single quick-connect terminals (note 4).			K = Explosion-proof Enclosure (note 1).			
A2 = Double quick-connect terminals (note 4).			L = Auxiliary Switch, instant transfer. 7012 only (notes 2 & 6).			
B = Plug-in connectors (note 4).			LL = Two Aux. Switches, instant transfer. On Model 7014 Factory Installed Only. (notes 2 & 6)			
GZ = Enclosure with bottom knockouts (note 1).			M = Dust-tight Gasketing (notes 4 & 5).			
H2 = Hermetically sealed enclosure, 8 pin solder (notes 1 & 4).			P = Octal Plug Adapter. Can be combined only with options I1,I2, M, S, X, or Y1. (note 4).			
H3 = Hermetically sealed enclosure, 8 pin octal (notes 1 & 4).			S = Dial Stops.			
H4 = Hermetically sealed enclosure, 8 screw terminal block (notes 1 & 4).			T = Auxiliary Switch, two-step timing (notes 2 & 6).			
*H6 = Hermetically sealed enclosure, 11 pin solder (notes 1 & 4).			V = Transient/Surge Protection (for DC coil voltage only).			
*H7 = Hermetically sealed enclosure, 11 pin octal (notes 1 & 4).			W = Watertight Enclosure (note 1).			
*H8 = Hermetically sealed enclosure, 11 screw terminal block (notes 1 & 4).			X = Panelmount includes hardware and adjustment for horizontal operation (note 4)			
I1 = Tamper-proof Cap, opaque black (Cannot be combined with Option X).			Y1 = Horizontal calibration, for horizontal operation without panelmounting (note 4).			
I2 = Tamper-proof Cap, transparent (Cannot be combined with Option X).			Y2 = Horizontal calibration, with Compensating Spring for vertical operation (note 4).			

**Notes:**

1. Cannot be combined with B, P or X Options
  2. Cannot be combined with B, P or Y2 Options
  3. Cannot be combined with GZ, H, I1, I2, K, W or Y1 Options
  4. Not Avail. on 4-Pole Models
  5. Not Available with L, T or LL options.
  6. Not Available on hermetically sealed units.
- \* Sized to accommodate one L or T Auxiliary Switch  
 \*\* Not available on On-Delay, Off-Delay (Double Head) model.  
 † Available with letter calibrated dials only. Upper end of time range may be twice the value shown  
 †† 120 cycles = 2 sec.

**Our authorized distributors are more likely to maintain the following items in stock for immediate delivery..**

7012AA	7012BC	7012PKX	7022AI
7012AB	7012NC	7012PJX	7022AJ
7012AC	7012PA	7022AA	7022AKT
7012AD	7012PB	7022AB	7022BC
7012AE	7012PC	7022AC	7022BK
7012AF	7012PD	7022AD	7022PA
7012AH	7012PF	7022AE	7022PB
7012AK	7012PJ	7022AF	7022PC
7012ACL	7012PK	7022AH	7022PK

**Ordering options – can only be orderd as factory installed options** (Dimensions, where shown, are in inches.)

**A1 – Single Quick-Connect Terminals**

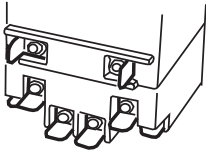

**A2 – Double Quick-Connect Terminals**

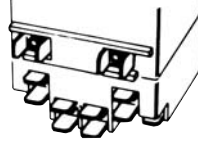

**B – Plug-In Connectors**

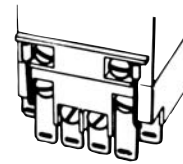

Use with Accessory  
"C" or "D" below.

**GZ – Total Enclosure**

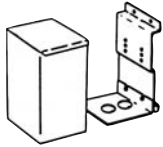

With knockouts for bottom  
connection.  
3.16" W x 3.84" D x 7.63"H

**H – Hermetically Sealed Enclosure**



**I – Tamper-Proof Cover**

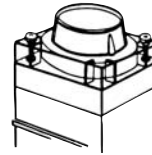

**K – Explosion proof Enclosure**

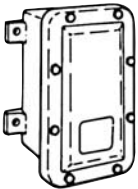

(Meets requirements for  
Class I, Groups C&D  
locations).  
7.50"W x 6.00" D x 10.38" H

**L – Auxiliary Switch**



**LL – Auxiliary Switch**

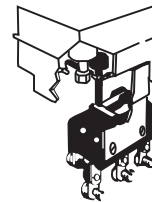

**M – Dusttight**

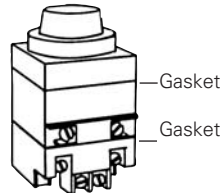

Gasket  
Gasket

**P – Octal Plug Adapter**

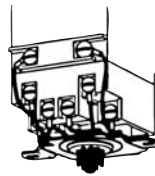

**S – Dial Stops**

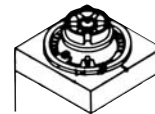

**T – Auxiliary Switch**

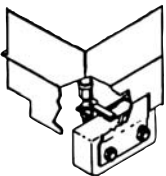

**V – Transient/Surge Protection**

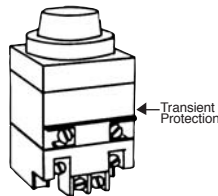

← Transient  
Protection

**W – Watertight Enclosure (NEMA-4)**

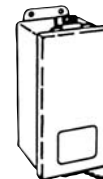

4.75" W x 4.44" D x 9.75" H

**X – Panelmount Kit**

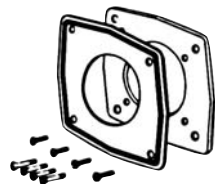

Mounting hardware  
included.

**Accessories** (Not available for 7032 models)

**Plug-In Receptacle (Accessory C)**

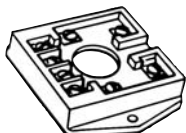

Screw Terminals **Catalog  
No. 700137.** For use with  
"B" Option

**Plug-In Receptacle (Accessory D)**

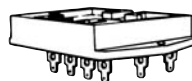

Quick Connect  
Terminals  
**Catalog No. 700141.**  
For use with "B"  
Option.

**Ordering options can only be ordered as factory installed options.**

## Данный компонент на территории Российской Федерации

### Вы можете приобрести в компании MosChip.

Для оперативного оформления запроса Вам необходимо перейти по данной ссылке:

<http://moschip.ru/get-element>

Вы можете разместить у нас заказ для любого Вашего проекта, будь то серийное производство или разработка единичного прибора.

В нашем ассортименте представлены ведущие мировые производители активных и пассивных электронных компонентов.

Нашей специализацией является поставка электронной компонентной базы двойного назначения, продукции таких производителей как XILINX, Intel (ex.ALTERA), Vicor, Microchip, Texas Instruments, Analog Devices, Mini-Circuits, Amphenol, Glenair.

Сотрудничество с глобальными дистрибьюторами электронных компонентов, предоставляет возможность заказывать и получать с международных складов практически любой перечень компонентов в оптимальные для Вас сроки.

На всех этапах разработки и производства наши партнеры могут получить квалифицированную поддержку опытных инженеров.

Система менеджмента качества компании отвечает требованиям в соответствии с ГОСТ Р ИСО 9001, ГОСТ РВ 0015-002 и ЭС РД 009

### Офис по работе с юридическими лицами:

105318, г.Москва, ул.Щербаковская д.3, офис 1107, 1118, ДЦ «Щербаковский»

Телефон: +7 495 668-12-70 (многоканальный)

Факс: +7 495 668-12-70 (доб.304)

E-mail: [info@moschip.ru](mailto:info@moschip.ru)

Skype отдела продаж:

moschip.ru

moschip.ru\_4

moschip.ru\_6

moschip.ru\_9