



# MMBD4448

## Features

- Halogen free available upon request by adding suffix "-HF"
- Fast Switching Speed
- Surface Mount Package Ideally Suited for Automatic Insertion
- For General Purpose Switching Applications
- Lead Free Finish/Rohs Compliant ("P" Suffix designates RoHS Compliant. See ordering information)

## Mechanical Data

- Epoxy meets UL 94 V-0 flammability rating
- Moisture Sensitivity Level 1
- Polarity: See Diagram
- Marking: KA3

## Maximum Ratings @ 25°C Unless Otherwise Specified

Characteristic	Symbol	Value	Unit
Non-Repetitive Peak Reverse Volt.	$V_{RM}$	100	V
Peak Repetitive Reverse Voltage	$V_{RRM}$		
Working Peak Reverse Voltage	$V_{RWM}$	75	V
DC Blocking Voltage	$V_R$		
RMS Reverse Voltage	$V_{R(RMS)}$	53	V
Forward Continuous Current(Note1)	$I_{FM}$	500	mA
Average Rectified Output Current	$I_o$	250	mA
Non-Repetitive Peak @ $t \leq 1.0s$	$I_{FSM}$	2	A
Forward Surge Current @ $t = 1.0us$		4	A
Power Dissipation(Note 1)	$P_d$	350	mW
Thermal Resistance(Note 1)	$R$	357	K/W
Operation/Storage Temp. Range	$T_j, T_{STG}$	-55 to +150	°C

## Electrical Characteristics @ 25°C Unless Otherwise Specified

Charateristic	Symbol	Min	Max	Unit	Test Cond.
Maximum Forward Voltage Drop	$V_{FM}$	0.62	0.72	V	$I_F = 5.0mA$ $I_F = 10mA$ $I_F = 100mA$ $I_F = 150mA$
		-----	0.855		
		-----	1		
		-----	1.25		
Maximum Peak Reverse Current	$I_{RM}$	-----	2.5	uA	$V_R = 75V$
		-----	50	uA	$V_R = 75V T_j = 150^\circ C$
		-----	30	uA	$V_R = 25V T_j = 150^\circ C$
Junction Capacitance	$C_j$	-----	4	pF	$V_R = 0V, f = 1.0MHz$
Reverse Recovery Time	$t_{rr}$	-----	4	ns	

## Surface Mount Switching Diode 350mW

### SOT-23

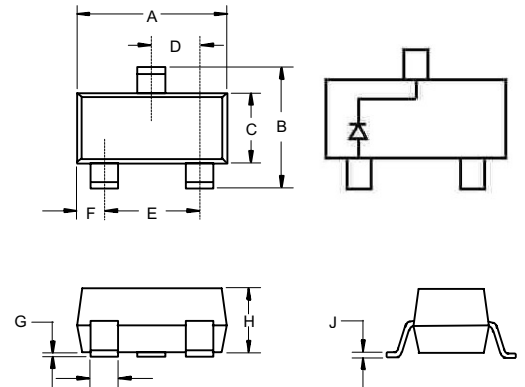

DIM	DIMENSIONS				NOTE
	INCHES		MM		
A	.110	.120	2.80	3.04	
B	.083	.104	2.10	2.64	
C	.047	.055	1.20	1.40	
D	.035	.041	.89	1.03	
E	.070	.081	1.78	2.05	
F	.018	.024	.45	.60	
G	.0005	.0039	.013	.100	
H	.035	.044	.89	1.12	
J	.003	.007	.085	.180	
K	.015	.020	.37	.51	

### Suggested Solder Pad Layout

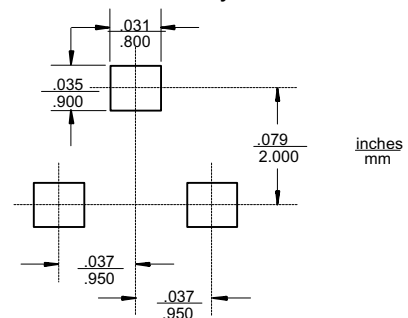

Note: 1. Valid provided that terminals are kept at ambient temperature  
 2.  $T_{rr}$  Test Condition:  $I_F = I_R = 10mA, I_{rr} = 0.1 \cdot I_R, R = 100 \text{ OHM}$

# MMBD4448

Figure 1  
Typical Forward Characteristics

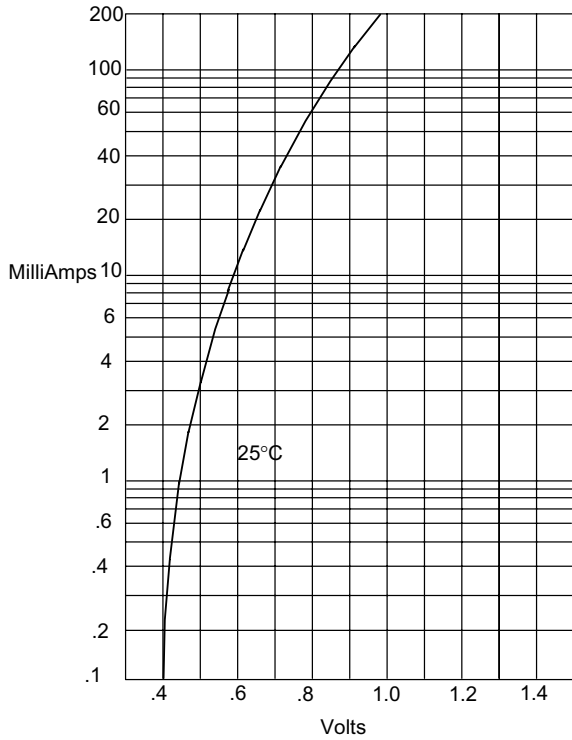

Instantaneous Forward Current - Amperes *versus*  
Instantaneous Forward Voltage - Volts

Figure 2  
Forward Derating Curve

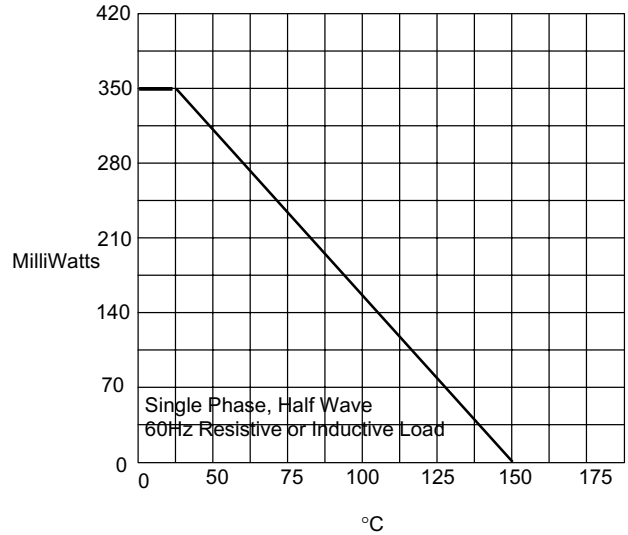

Admissible Power Dissipation - MilliWatts *versus*  
Ambient Temperature - °C

Figure 3  
Junction Capacitance

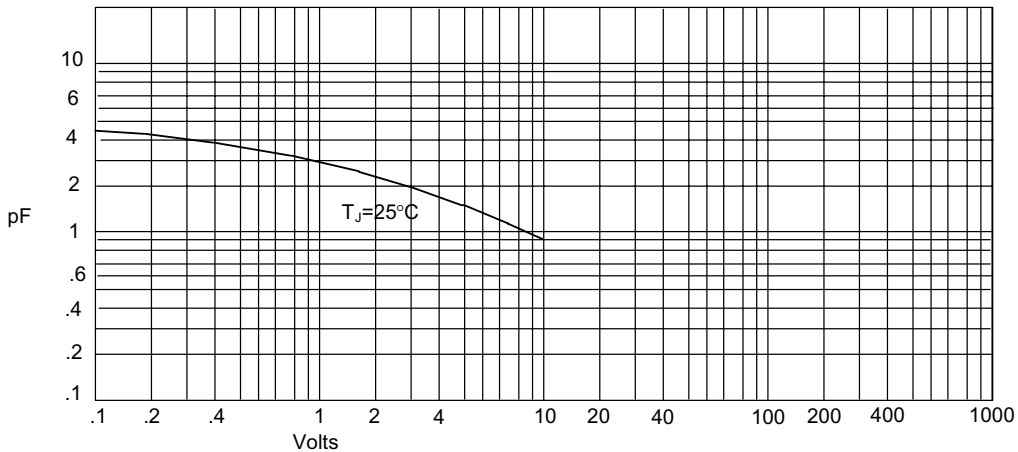

Junction Capacitance - pF *versus*  
Reverse Voltage - Volts

# MMBD4448



Micro Commercial Components

Figure 4  
Typical Reverse Characteristics

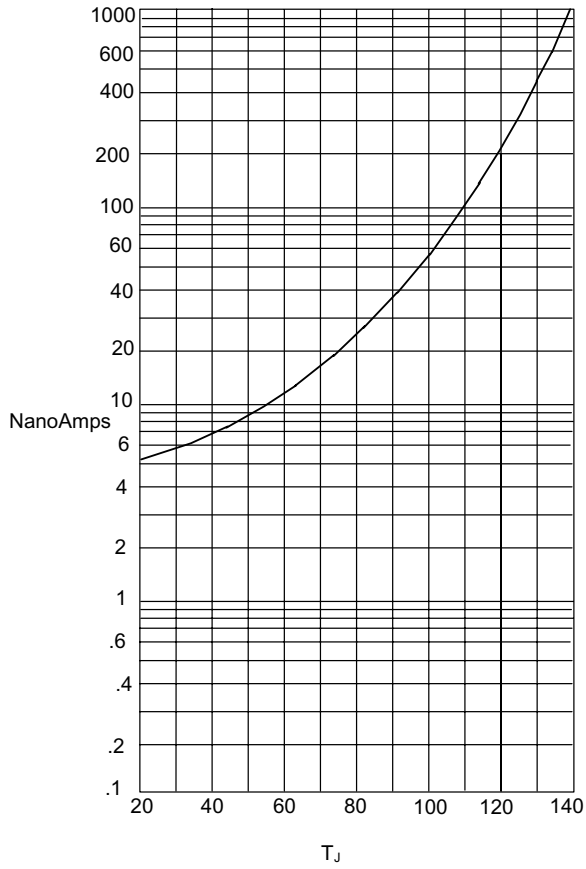

Instantaneous Reverse Leakage Current - NanoAmperes versus Junction Temperature - °C

T<sub>A</sub>=25°C

Figure 5  
Peak Forward Surge Current

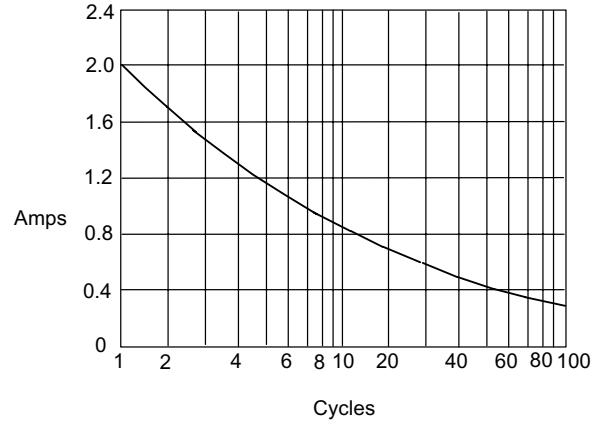

Peak Forward Surge Current - Amperes versus Number Of Cycles At 60Hz - Cycles



Micro Commercial Components

### Ordering Information :

Device	Packing
Part Number-TP	Tape&Reel: 3Kpcs/Reel

Note : Adding "-HF" suffix for halogen free, eg. Part Number-TP-HF

#### \*\*\*IMPORTANT NOTICE\*\*\*

**Micro Commercial Components Corp.** reserves the right to make changes without further notice to any product herein to make corrections, modifications , enhancements , improvements , or other changes . **Micro Commercial Components Corp .** does not assume any liability arising out of the application or use of any product described herein; neither does it convey any license under its patent rights ,nor the rights of others . The user of products in such applications shall assume all risks of such use and will agree to hold **Micro Commercial Components Corp .** and all the companies whose products are represented on our website, harmless against all damages.

#### \*\*\*LIFE SUPPORT\*\*\*

MCC's products are not authorized for use as critical components in life support devices or systems without the express written approval of Micro Commercial Components Corporation.

#### \*\*\*CUSTOMER AWARENESS\*\*\*

Counterfeiting of semiconductor parts is a growing problem in the industry. Micro Commercial Components (MCC) is taking strong measures to protect ourselves and our customers from the proliferation of counterfeit parts. MCC strongly encourages customers to purchase MCC parts either directly from MCC or from Authorized MCC Distributors who are listed by country on our web page cited below. Products customers buy either from MCC directly or from Authorized MCC Distributors are genuine parts, have full traceability, meet MCC's quality standards for handling and storage. **MCC will not provide any warranty coverage or other assistance for parts bought from Unauthorized Sources.** MCC is committed to combat this global problem and encourage our customers to do their part in stopping this practice by buying direct or from authorized distributors.

[www.mccsemi.com](http://www.mccsemi.com)

## Данный компонент на территории Российской Федерации

### Вы можете приобрести в компании MosChip.

Для оперативного оформления запроса Вам необходимо перейти по данной ссылке:

<http://moschip.ru/get-element>

Вы можете разместить у нас заказ для любого Вашего проекта, будь то серийное производство или разработка единичного прибора.

В нашем ассортименте представлены ведущие мировые производители активных и пассивных электронных компонентов.

Нашей специализацией является поставка электронной компонентной базы двойного назначения, продукции таких производителей как XILINX, Intel (ex.ALTERA), Vicor, Microchip, Texas Instruments, Analog Devices, Mini-Circuits, Amphenol, Glenair.

Сотрудничество с глобальными дистрибьюторами электронных компонентов, предоставляет возможность заказывать и получать с международных складов практически любой перечень компонентов в оптимальные для Вас сроки.

На всех этапах разработки и производства наши партнеры могут получить квалифицированную поддержку опытных инженеров.

Система менеджмента качества компании отвечает требованиям в соответствии с ГОСТ Р ИСО 9001, ГОСТ РВ 0015-002 и ЭС РД 009

### Офис по работе с юридическими лицами:

105318, г.Москва, ул.Щербаковская д.3, офис 1107, 1118, ДЦ «Щербаковский»

Телефон: +7 495 668-12-70 (многоканальный)

Факс: +7 495 668-12-70 (доб.304)

E-mail: [info@moschip.ru](mailto:info@moschip.ru)

Skype отдела продаж:

moschip.ru

moschip.ru\_4

moschip.ru\_6

moschip.ru\_9