

Analog Devices Welcomes Hittite Microwave Corporation

NO CONTENT ON THE ATTACHED DOCUMENT HAS CHANGED



THIS PAGE INTENTIONALLY LEFT BLANK

Typical Applications

Prescaler for DC to X Band PLL Applications:

- Satellite Communication Systems
- Fiber Optic
- Point-to-Point and Point-to-Multi-Point Radios
- VSAT

Features

- Ultra Low SSB Phase Noise: -149 dBc/Hz
- Wide Bandwidth
- Output Power: -6 dBm
- Single DC Supply: +5V
- Small Size: 1.30 x 0.69 x 0.1 mm

Functional Diagram

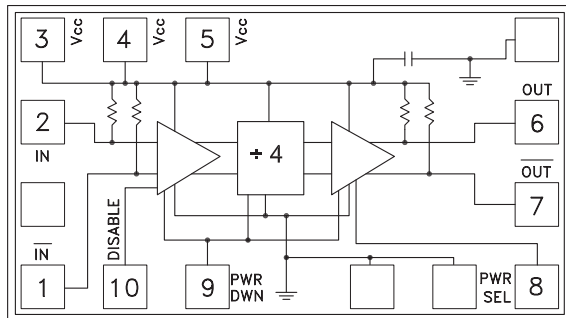

General Description

The HMC362 is a low noise Divide-by-4 Static Divider with InGaP GaAs HBT technology that has a small size of 1.30 x 0.69 mm. This device operates from DC (with a square wave input) to 11 GHz input frequency with a single +5V DC supply. The low additive SSB phase noise of -149 dBc/Hz at 100 kHz offset helps the user maintain good system noise performance.

Electrical Specifications, $T_A = +25^\circ\text{C}$, 50 Ohm System, $V_{CC} = 5V$

| Parameter | Conditions | Min. | Typ. | Max. | Units |
|----------------------------------|---------------------------------------|------|------|------|--------|
| Maximum Input Frequency | | 11 | 12 | | GHz |
| Minimum Input Frequency | Sine Wave Input. [1] | | 0.2 | 0.5 | GHz |
| Input Power Range | $F_{in} = 1$ to 8 GHz | -15 | >-20 | +10 | dBm |
| | $F_{in} = 8$ to 11 GHz | -10 | >-15 | +2 | dBm |
| Output Power [2] | $F_{in} = 11$ GHz | -9 | -6 | | dBm |
| Reverse Leakage | Both RF Outputs Terminated | | 40 | | dB |
| SSB Phase Noise (100 kHz offset) | $P_{in} = 0$ dBm, $F_{in} = 6$ GHz | | -149 | | dBc/Hz |
| Output Transition Time | $P_{in} = 0$ dBm, $F_{out} = 882$ MHz | | 100 | | ps |
| Supply Current (I_{CC}) [2] | | | 68 | | mA |

[1] Divider will operate down to DC for square-wave input signal.

[2] When operated in low power mode (pin 8 floating).

**GaAs HBT MMIC
DIVIDE-BY-4, DC - 11 GHz**

Input Sensitivity Window, $T = 25\text{ }^{\circ}\text{C}$

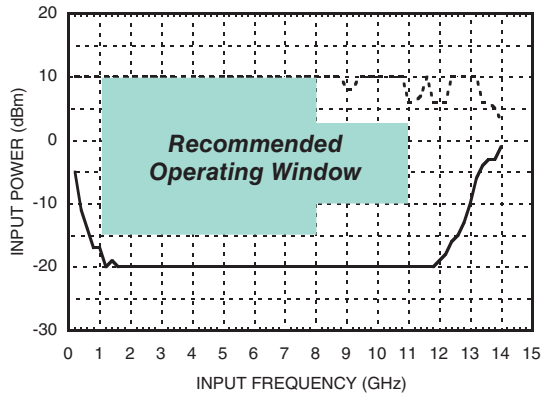

Input Sensitivity Window vs. Temperature

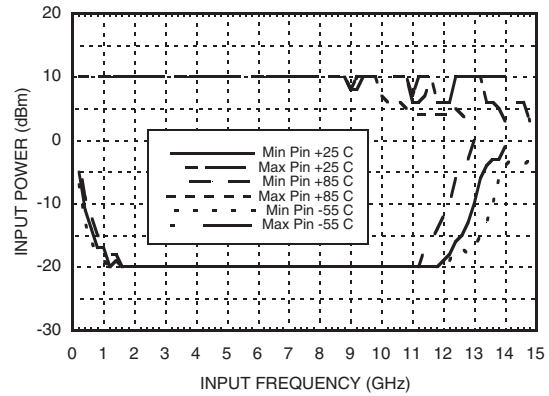

Output Power vs. Temperature

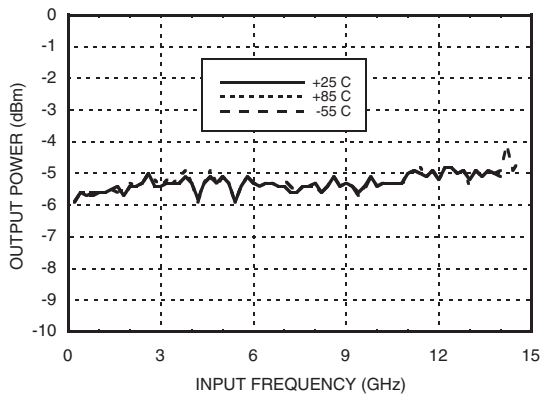

SSB Phase Noise Performance, $P_{in} = 0\text{ dBm}$, $T = 25\text{ }^{\circ}\text{C}$

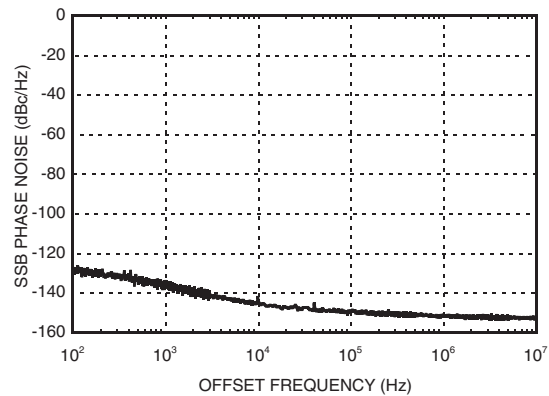

Output Harmonic Content, $P_{in} = 0\text{ dBm}$, $T = 25\text{ }^{\circ}\text{C}$

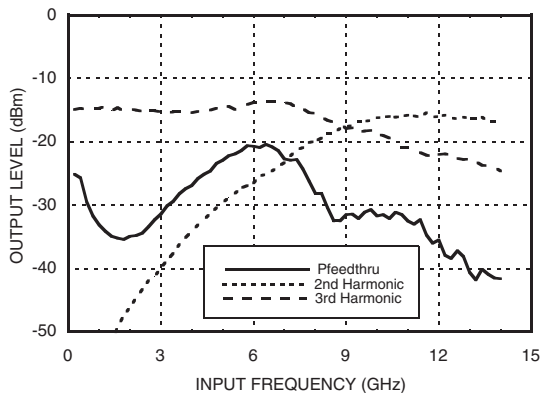

Reverse Leakage, $P_{in} = 0\text{ dBm}$, $T = 25\text{ }^{\circ}\text{C}$

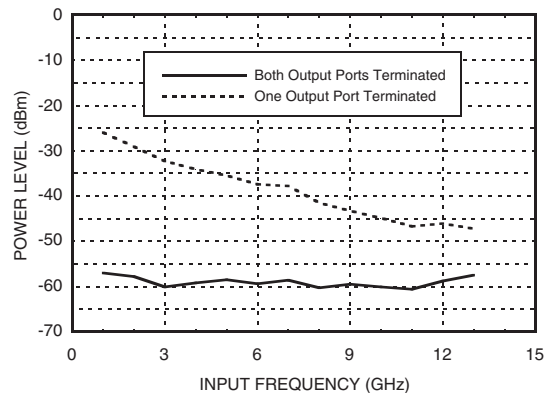

**GaAs HBT MMIC
DIVIDE-BY-4, DC - 11 GHz**

1

FREQUENCY DIVIDERS - CHIP

**Output Voltage Waveform,
Pin= 0 dBm, Fout= 882 MHz, T= 25 °C**

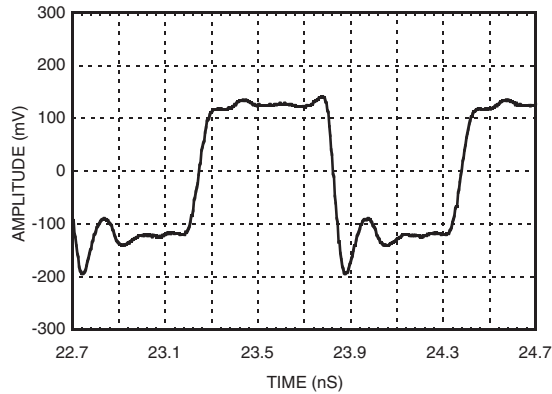

Absolute Maximum Ratings

| | |
|-----------------------|------------------------|
| RF Input (Vcc = +5V) | +13 dBm |
| Vcc | +5.5V |
| VLogic | Vcc -1.6V to Vcc -1.2V |
| Storage Temperature | -65 to +150 °C |
| Operating Temperature | -55 to +85 °C |



**ELECTROSTATIC SENSITIVE DEVICE
OBSERVE HANDLING PRECAUTIONS**

Typical Supply Current vs. Vcc

| Vcc (V) | Icc (mA) |
|---------|----------|
| 4.75 | 61 |
| 5.0 | 68 |
| 5.25 | 74 |

Note: Divider will operate over full voltage range shown above

Outline Drawing

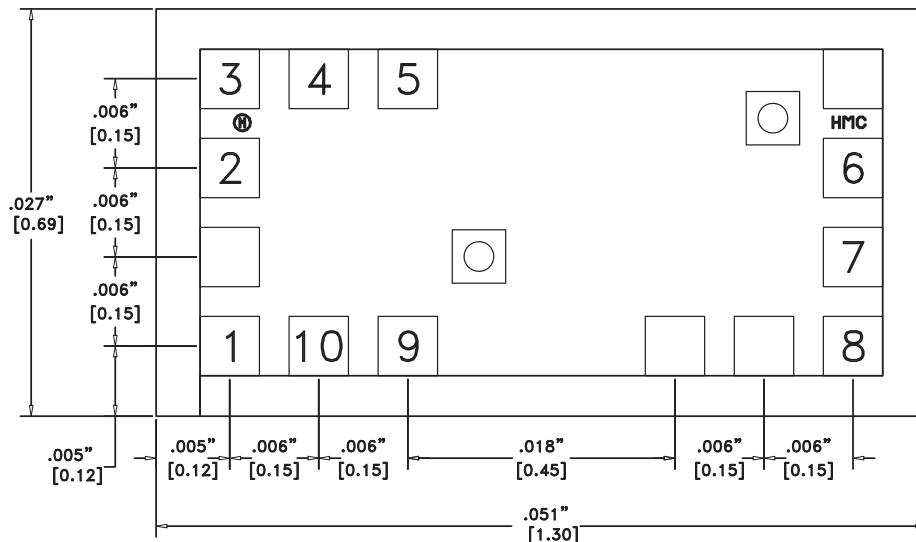

Die Packaging Information [1]

| Standard | Alternate |
|--------------------|-----------|
| WP-8 (Waffle Pack) | [2] |

[1] Refer to the "Packaging Information" section for die packaging dimensions.

[2] For alternate packaging information contact Hittite Microwave Corporation.

NOTES:

- ALL DIMENSIONS IN INCHES (MILLIMETERS)
- ALL TOLERANCES ARE ±0.001 (0.025)
- DIE THICKNESS IS 0.004 (0.100) BACKSIDE IS GROUND
- BOND PADS ARE 0.004 (0.100) SQUARE
- BOND PAD SPACING, CTR-CTR: 0.006 (0.150)
- BACKSIDE METALLIZATION: GOLD
- BOND PAD METALLIZATION: GOLD

For price, delivery, and to place orders, please contact Hittite Microwave Corporation:
20 Alpha Road, Chelmsford, MA 01824 Phone: 978-250-3343 Fax: 978-250-3373
Order On-line at www.hittite.com

**GaAs HBT MMIC
DIVIDE-BY-4, DC - 11 GHz**

Pad Description

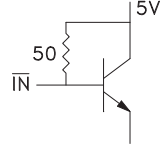
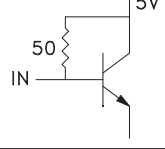
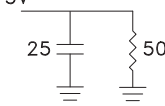
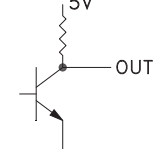
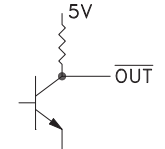
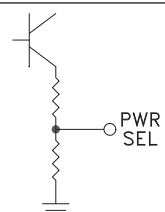
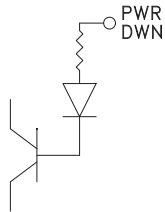
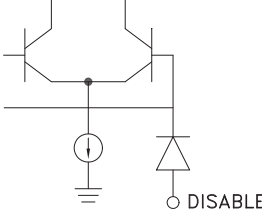
| Pad Number | Function | Description | Interface Schematic |
|------------|------------------|---|---|
| 1 | \overline{IN} | RF Input 180° out of phase with pad 3 for differential operation. AC ground for single ended operation. |  |
| 2 | IN | RF Input must be DC blocked. |  |
| 3, 4, 5 | Vcc | Supply Voltage 5V ±0.25V can be applied to pad 3, 4, or 5. |  |
| 6 | OUT | Divided Output |  |
| 7 | \overline{OUT} | Divided output 180° out of phase with OUT. |  |
| 8 | PWR SEL | In the low power mode, the power select pin is left floating. By grounding this pin, the output power is increased by approximately 10 dB. |  |
| 9 | PWR DWN | The power down pin is grounded for normal operation. Applying 5 volts to this pin will power down this device. |  |
| 10 | DISABLE | The disable pin is grounded for normal operation. Applying 5 volts to this pin will disable the input buffer amplifier. |  |

GaAs HBT MMIC DIVIDE-BY-4, DC - 11 GHz

Truth Table

| Function | Pin | 5V | GND | Float |
|----------|-----|------------|-------------------|------------------|
| DISABLE | 10 | Output Off | Output On | X |
| PWR DWN | 9 | Power Down | Power Up | X |
| PWR SEL | 8 | X | High Power Output | Low Power Output |

X = State not permitted.

Assembly Diagram

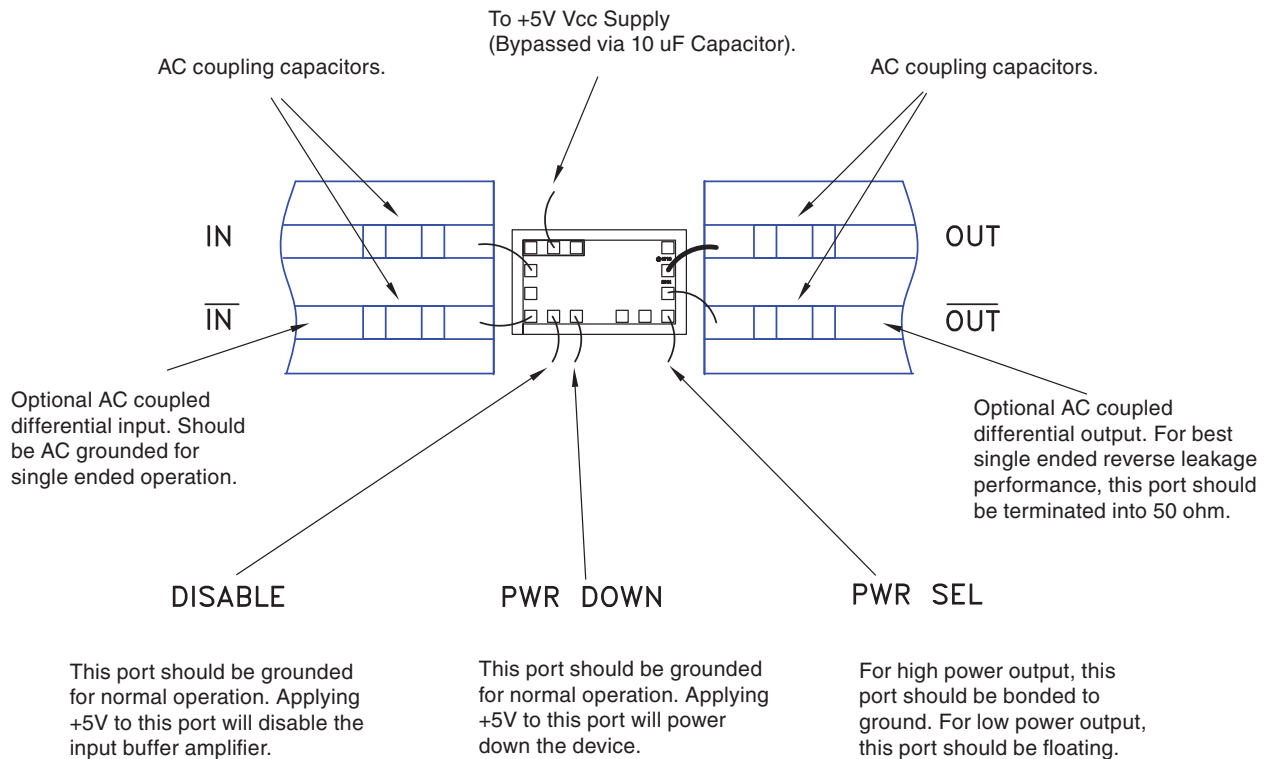

Handling Precautions

Follow these precautions to avoid permanent damage.

Cleanliness: Handle the chips in a clean environment. DO NOT attempt to clean the chip using liquid cleaning systems.

Static Sensitivity: Follow ESD precautions to protect against ESD strikes.

Transients: Suppress instrument and bias supply transients while bias is applied. Use shielded signal and bias cables to minimize inductive pick-up.

General Handling: Handle the chip along the edges with a vacuum collet or with a sharp pair of bent tweezers. The surface of the chip has fragile air bridges and should not be touched with vacuum collet, tweezers, or fingers.

Mounting

The chip is back-metallized and can be die mounted with with electrically conductive epoxy. The mounting surface should be clean and flat.

Epoxy Die Attach: Apply a minimum amount of epoxy to the mounting surface so that a thin epoxy fillet is observed around the perimeter of the chip once it is placed into position. Cure epoxy per the manufacturer's schedule.

Wire Bonding

Ball or wedge bond with 0.025 mm (1 mil) diameter pure gold wire. Thermosonic wirebonding with a nominal stage temperature of 150 °C and a ball bonding force of 40 to 50 grams or wedge bonding force of 18 to 22 grams is recommended. Use the minimum level of ultrasonic energy to achieve reliable wirebonds. Wirebonds should be started on the chip and terminated on the package or substrate. All bonds should be as short as possible <0.31 mm (12 mils).

Данный компонент на территории Российской Федерации

Вы можете приобрести в компании MosChip.

Для оперативного оформления запроса Вам необходимо перейти по данной ссылке:

<http://moschip.ru/get-element>

Вы можете разместить у нас заказ для любого Вашего проекта, будь то серийное производство или разработка единичного прибора.

В нашем ассортименте представлены ведущие мировые производители активных и пассивных электронных компонентов.

Нашей специализацией является поставка электронной компонентной базы двойного назначения, продукции таких производителей как XILINX, Intel (ex.ALTERA), Vicor, Microchip, Texas Instruments, Analog Devices, Mini-Circuits, Amphenol, Glenair.

Сотрудничество с глобальными дистрибьюторами электронных компонентов, предоставляет возможность заказывать и получать с международных складов практически любой перечень компонентов в оптимальные для Вас сроки.

На всех этапах разработки и производства наши партнеры могут получить квалифицированную поддержку опытных инженеров.

Система менеджмента качества компании отвечает требованиям в соответствии с ГОСТ Р ИСО 9001, ГОСТ РВ 0015-002 и ЭС РД 009

Офис по работе с юридическими лицами:

105318, г.Москва, ул.Щербаковская д.3, офис 1107, 1118, ДЦ «Щербаковский»

Телефон: +7 495 668-12-70 (многоканальный)

Факс: +7 495 668-12-70 (доб.304)

E-mail: info@moschip.ru

Skype отдела продаж:

moschip.ru

moschip.ru_4

moschip.ru_6

moschip.ru_9