

Features

- Typical Isolation: 35 dB (2.0 GHz)
- Typical Insertion Loss: 1.2 dB (2.0 GHz)
- Integral ASIC/CMOS Driver
- 50 Ohm Nominal Impedance
- Low DC Power Consumption
- Test Boards Available
- Lead-Free QSOP-24 Package
- 100% Matte Tin Plating over Copper
- Halogen-Free “Green” Mold Compound
- 260°C Reflow Compatible
- RoHS* Compliant Version of SW65-0440

Description

M/A-COM's MASWCC0009 is a GaAs MMIC absorptive SP4T switch with an integral silicon ASIC driver. This device is in a 24-lead plastic package. This switch offers excellent broadband performance and repeatability from DC to 3 GHz, while maintaining low DC power dissipation. The MASWCC0009 is ideally suited for wireless infrastructure applications.

Ordering Information

Part Number	Package
MASWCC0009	Bulk Packaging
MASWCC0009TR	1000 piece reel
MASWCC0009-TB	Sample Test Board

Note: Reference Application Note M513 for reel size information.

Functional Schematic

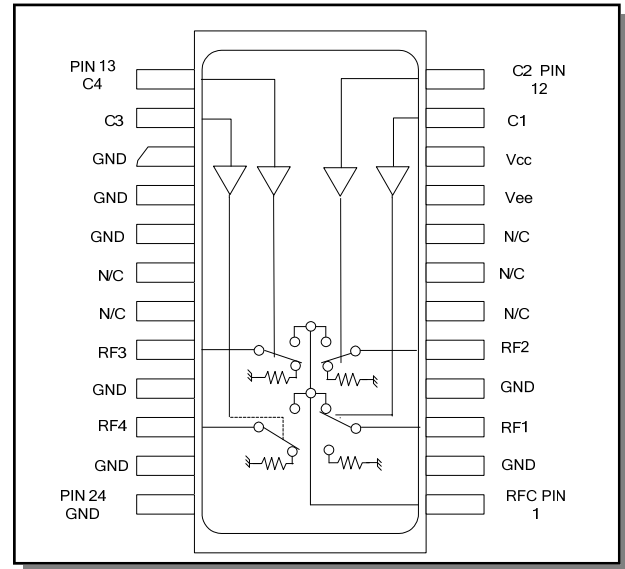

Pin Configuration

Pin No.	Function	Pin No.	Function
1	RFC	13	C4
2	GND	14	C3
3	RF1	15	GND
4	GND	16	GND
5	RF2	17	GND
6	NC	18	NC
7	NC	19	NC
8	NC	20	RF3
9	V _{EE}	21	GND
10	V _{CC}	22	RF4
11	C1	23	GND
12	C2	24	GND

NC = No Connection

* Restrictions on Hazardous Substances, European Union Directive 2002/95/EC.

Electrical Specifications: $T_A = 25^\circ\text{C}$

Parameter	Test Conditions	Units	Min	Typ	Max
Insertion Loss	DC - 2.0 GHz	dB	—	1.2	1.8
	DC - 3.0 GHz	dB	—	1.3	2.5
Isolation	DC - 2.0 GHz	dB	32	35	—
	DC - 3.0 GHz	dB	25	29	—
VSWR	RF1-RF4 On	Ratio	—	1.2:1	1.6:1
	RF1- RF4 Off	Ratio	—	1.4:1	1.8:1
	RFC	Ratio	—	1.2:1	1.5:1
	RFC	Ratio	—	1.6:1	2.2:1
Switching Speed ¹	T_{rise} T_{fall}	ns	—	15	50
	T_{on} T_{off}	ns	—	50	150
	Transients	mV	—	50	150
1 dB Compression	.05 GHz	dBm	—	+20	—
	.5 - 3.0 GHz	dBm	—	+27	—
Input IP_3	Two tone inputs 0.05 GHz	dBm	—	+35	—
	up to +5 dBm 0.5 - 3.0 GHz	dBm	—	+46	—
V_{CC}	—	V	+4.5	+5.0	+5.5
V_{EE}	—	V	-8.0	-5.0	-4.75
V_{IL} V_{IH}	LOW-level input voltage	V	0.0	—	0.8
	HIGH-level input voltage	V	2.0	—	5.0
I_{in} (Input Leakage Current)	$V_{in} = V_{CC}$ or GND	μA	-1.0	—	1.0
I_{cc} (Quiescent Supply Current)	$V_{cntrl} = V_{CC}$ or GND	μA	—	250	400
ΔI_{cc} (Additional Supply Current Per TTL Input Pin)	$V_{CC} = \text{Max}$, $V_{cntrl} = V_{CC} - 2.1 \text{ V}$	mA	—	—	1.0
I_{EE}	V_{EE} min to max, $V_{in} = V_{IL}$ or V_{IH}	mA	-1.0	-0.2	—

Absolute Maximum Ratings ^{2,3,4}

Parameter	Absolute Maximum
Max. Input Power 0.05 GHz 0.5 - 3.0 GHz	+27 dBm +34 dBm
V_{CC}	$-0.5\text{V} \leq V_{CC} \leq +7.0\text{V}$
V_{EE}	$-8.5\text{V} \leq V_{EE} \leq +0.5\text{V}$
$V_{CC} - V_{EE}$	$-0.5\text{V} \leq V_{CC} - V_{EE} \leq 14.5\text{V}$
V_{in}^5	$-0.5\text{V} \leq V_{in} \leq V_{CC} + 0.5\text{V}$
Operating Temperature	-40°C to +85°C
Storage Temperature	-65°C to +125°C

- Exceeding any one or combination of these limits may cause permanent damage to this device.
- M/A-COM does not recommend sustained operation near these survivability limits.
- When the RF input is applied to the terminated port, the absolute maximum power is +30 dBm.
- Standard CMOS TTL interface, latch-up will occur if logic signal is applied prior to power supply.

- Decoupling capacitors (0.1 μF) are required on the power supply lines.

Truth Table (Switch)

TTL				RF Common To:			
C1	C2	C3	C4	RF1	RF2	RF3	RF4
1	0	0	0	On	Off	Off	Off
0	1	0	0	Off	On	Off	Off
0	0	1	0	Off	Off	On	Off
0	0	0	1	Off	Off	Off	On

0 = TTL Low; 1 = TTL High

2

ADVANCED: Data Sheets contain information regarding a product M/A-COM Technology Solutions is considering for development. Performance is based on target specifications, simulated results, and/or prototype measurements. Commitment to develop is not guaranteed.
PRELIMINARY: Data Sheets contain information regarding a product M/A-COM Technology Solutions has under development. Performance is based on engineering tests. Specifications are typical. Mechanical outline has been fixed. Engineering samples and/or test data may be available. Commitment to produce in volume is not guaranteed.

• **North America** Tel: 800.366.2266 • **Europe** Tel: +353.21.244.6400
 • **India** Tel: +91.80.4155721 • **China** Tel: +86.21.2407.1588
 Visit www.macomtech.com for additional data sheets and product information.

M/A-COM Technology Solutions Inc. and its affiliates reserve the right to make changes to the product(s) or information contained herein without notice.

Recommended PCB Layout—SP4T

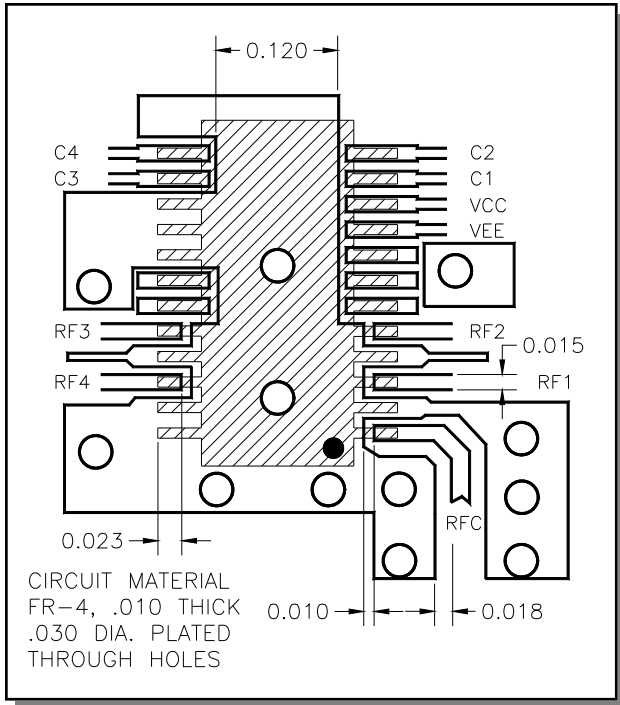

Recommended PCB Layout—SP2T

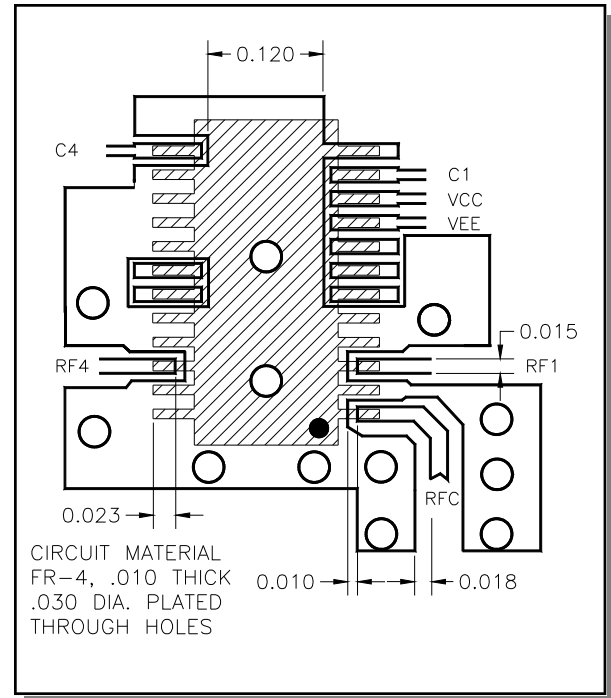

Evaluation Board - SW65-0440-TB

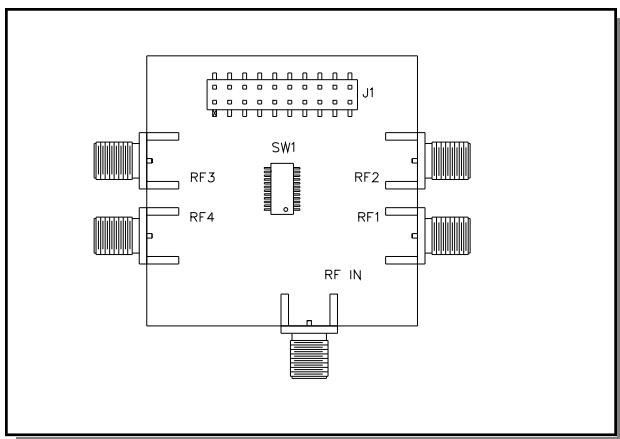

Handling Procedures

Please observe the following precautions to avoid damage:

Static Sensitivity

Gallium Arsenide Integrated Circuits are sensitive to electrostatic discharge (ESD) and can be damaged by static electricity. Proper ESD control techniques should be used when handling these devices.

Typical Performance Curves

Insertion Loss (dB) @ +25°C

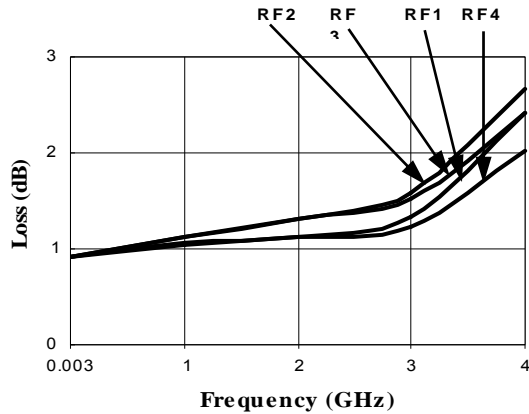

Loss Variation Over Temp. (dB)

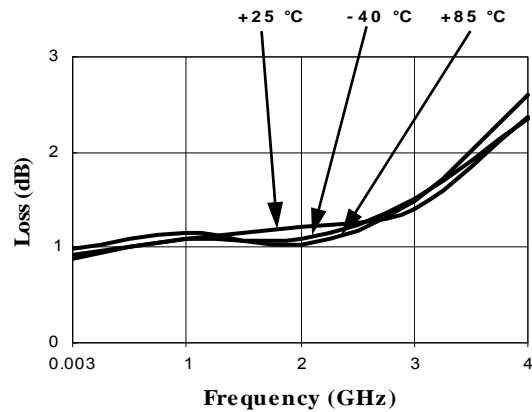

RF1 - RF4 On VSWR @ +25°C

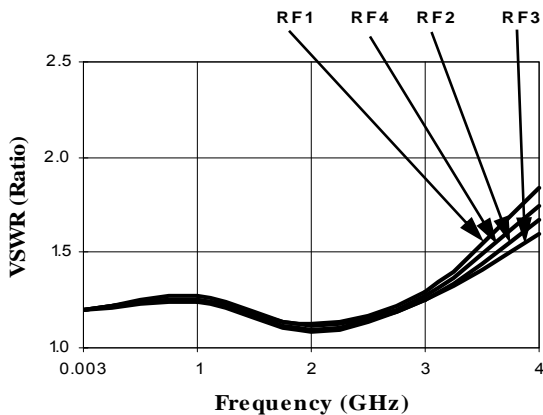

RF1 - RF4 On VSWR Temp. Variation

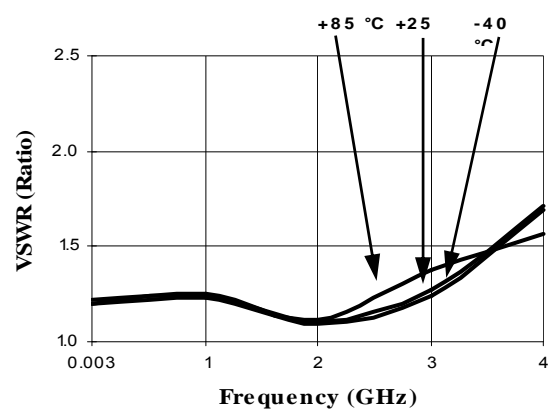

RFC On VSWR @ +25°C

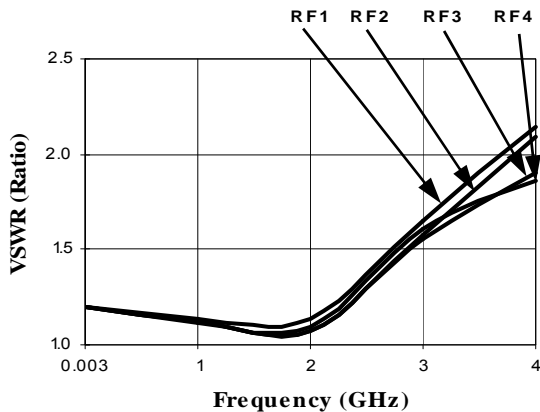

RFC On VSWR Temp. Variation

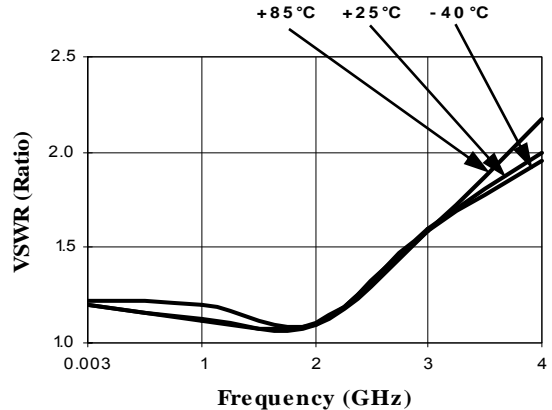

Typical Performance Curves

RF1 - RF4 Off VSWR @ +25°C

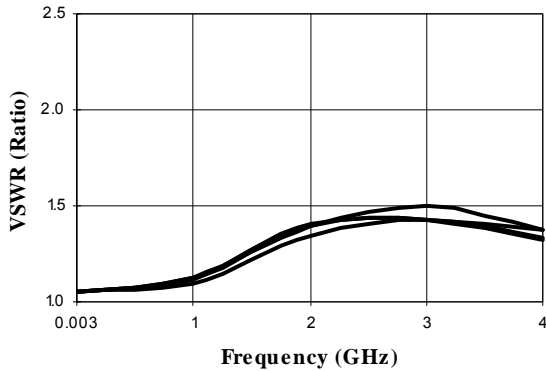

RF1 - RF4 Off VSWR Temp. Variation

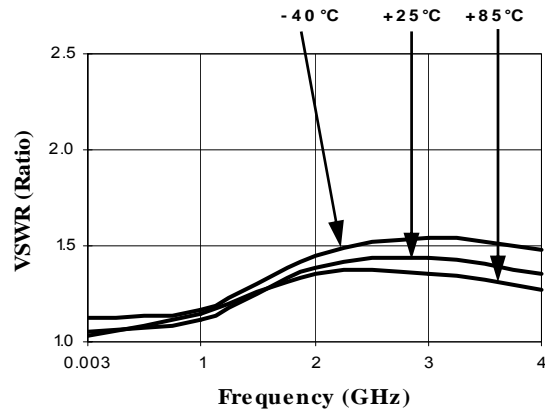

Isolation (dB) @ +25°C

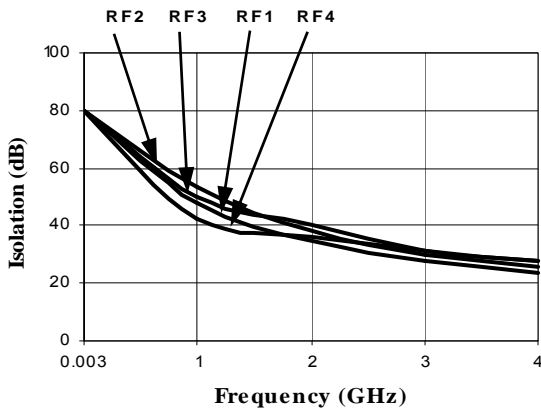

Isolation Temp. Variation (dB)

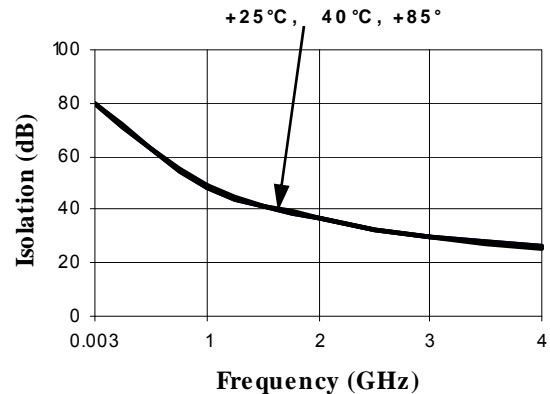

Lead-Free, QSOP-24[†]

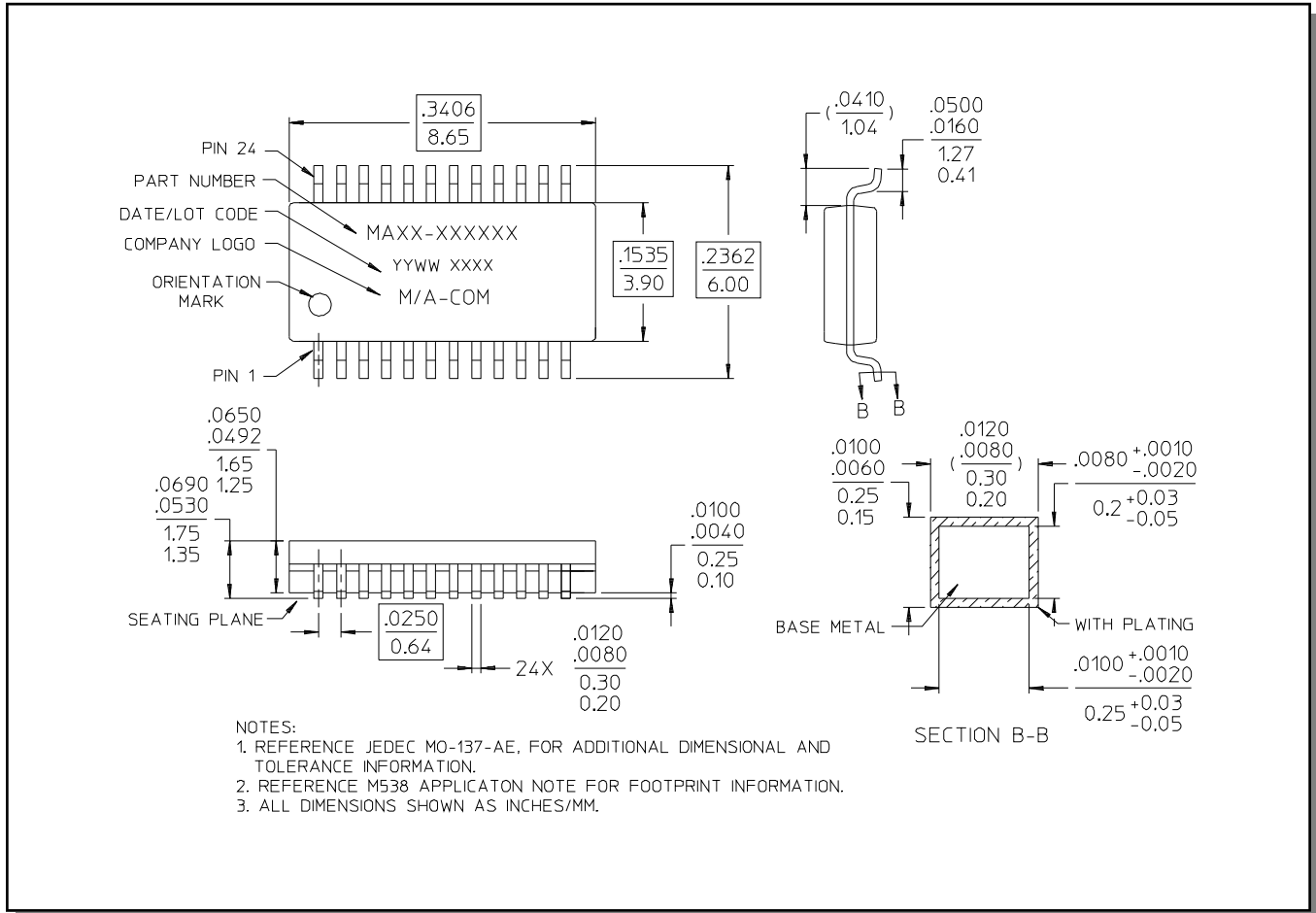

[†] Reference Application Note M538 for lead-free solder reflow recommendations.

Данный компонент на территории Российской Федерации

Вы можете приобрести в компании MosChip.

Для оперативного оформления запроса Вам необходимо перейти по данной ссылке:

<http://moschip.ru/get-element>

Вы можете разместить у нас заказ для любого Вашего проекта, будь то серийное производство или разработка единичного прибора.

В нашем ассортименте представлены ведущие мировые производители активных и пассивных электронных компонентов.

Нашей специализацией является поставка электронной компонентной базы двойного назначения, продукции таких производителей как XILINX, Intel (ex.ALTERA), Vicor, Microchip, Texas Instruments, Analog Devices, Mini-Circuits, Amphenol, Glenair.

Сотрудничество с глобальными дистрибьюторами электронных компонентов, предоставляет возможность заказывать и получать с международных складов практически любой перечень компонентов в оптимальные для Вас сроки.

На всех этапах разработки и производства наши партнеры могут получить квалифицированную поддержку опытных инженеров.

Система менеджмента качества компании отвечает требованиям в соответствии с ГОСТ Р ИСО 9001, ГОСТ РВ 0015-002 и ЭС РД 009

Офис по работе с юридическими лицами:

105318, г.Москва, ул.Щербаковская д.3, офис 1107, 1118, ДЦ «Щербаковский»

Телефон: +7 495 668-12-70 (многоканальный)

Факс: +7 495 668-12-70 (доб.304)

E-mail: info@moschip.ru

Skype отдела продаж:

moschip.ru

moschip.ru_4

moschip.ru_6

moschip.ru_9