

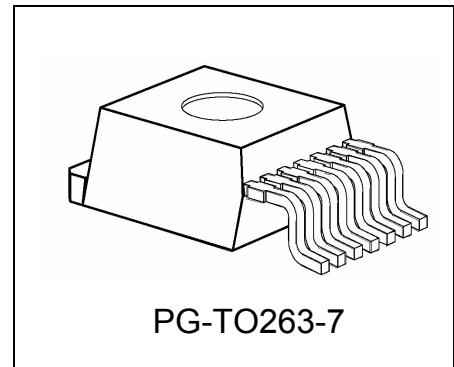

Features

- Adjustable constant current up to 500 mA
- Operating supply voltage range 4.5 V to 24 V
- Maximum supply voltage up to 45 V
- Low dropout voltage
- PWM / ENABLE input
- $\ll 1 \mu\text{A}$ quiescent current when disabled
- Overtemperature protection
- Short circuit proof
- Reverse polarity protection
- Operating junction temperature range: $-40\text{ }^{\circ}\text{C}$ to $150\text{ }^{\circ}\text{C}$
- Suitable for applications up to $85\text{ }^{\circ}\text{C}$ ambient temperature.
- Green Product (RoHS compliant)



Functional Description

The TLE4309 is an integrated adjustable constant current source for driving loads up to 500 mA. The output current level can be adjusted with an external shunt resistor. Supplying high power LEDs with the TLE4309 ensures constant brightness independent from supply voltage or LED forward voltage spread. Therefore, LED lifetime is extended by protecting from overcurrent and overtemperature

The PWM/EN input permits LED brightness regulation by pulse width modulation. Setting the pin to “low” switches off the IC entirely. Due to the high impedance of the PWM/EN input, the TLE4309 can be used as a protected high side switch.

Protection circuits prevent from damage to the IC in case of overload, short circuit, and reverse polarity. A chip temperature monitoring circuit shuts off the power stage and prevents the IC from destruction under fault conditions.

In case of negative input voltage, a leakage current is flowing only from the output to the input, hence the LED are protected against reverse supply. Input voltage peaks up to 45 V are absorbed by the IC, preventing the LEDs from overcurrent.

The TLE4309G is provided in the surface mounted PG-TO-263 package with excellent thermal resistance.

Type	Package	Marking
TLE4309G	PG-TO263-7-1	TLE4309

Circuit Description

An external shunt resistor in the ground path of the connected LEDs senses the LED current. A regulation loop maintains the voltage drop across the shunt resistor at a constant level. Selecting the shunt resistance permits to adjust the appropriate constant current. The output current calculates

$$I_{Q, \text{typ}} = \frac{V_{\text{REF}}}{R_{\text{REF}}} \tag{1}$$

where V_{REF} is the reference voltage. (see “Electrical Characteristics” table). The equation applies in a range of $0.39 \Omega \leq R_{\text{REF}} \leq 1.8 \Omega$. On Page 7, the output current is shown as a function of the reference resistance.

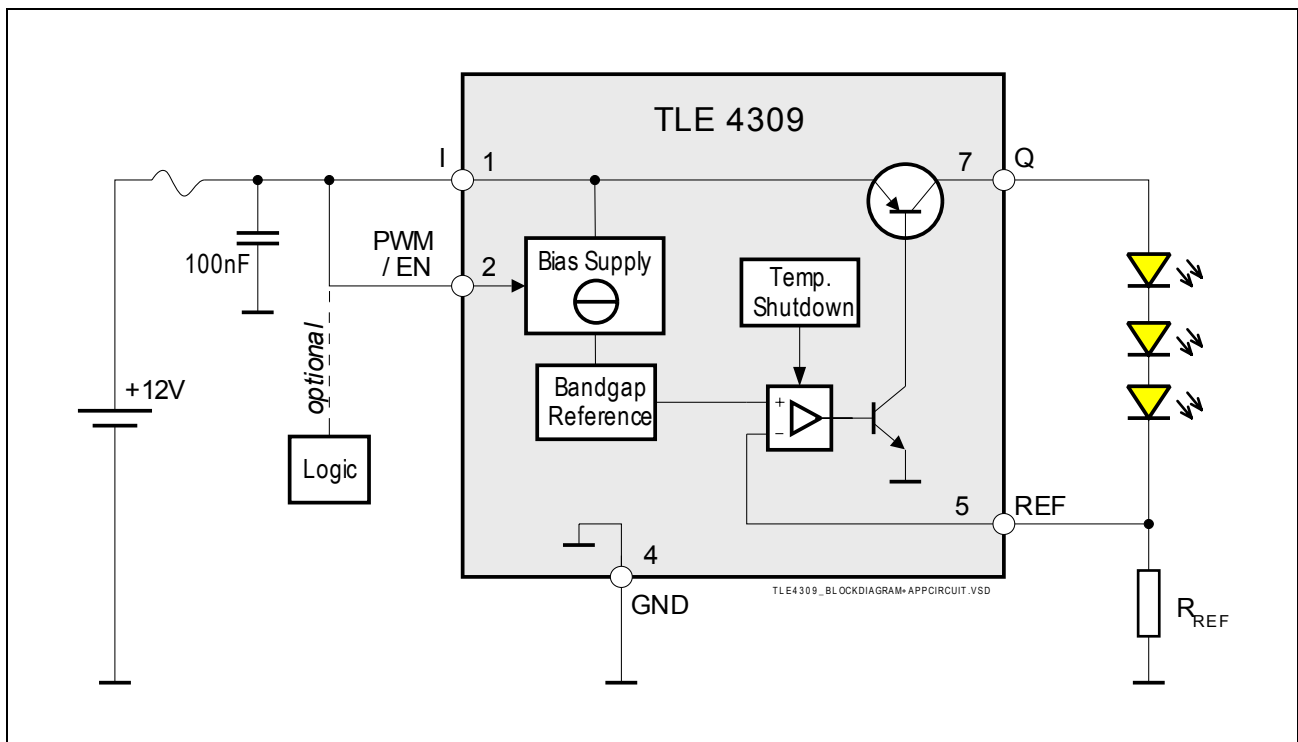

Figure 1 Block Diagram and Typical Application Circuit

During operation, the LED brightness is modifiable by adjusting the duty cycle at the PWM/EN input. This allows to dim the LEDs during operation or adapt the output current to different LED luminosity classes.

A low signal at the PWM/EN input sets the IC into sleep mode consuming less than 1 μA . Due to its high input impedance, the PWM/EN pin can be used as an enable input. Connect the pin directly to the supply line, if its function is not needed.

The minimum supply voltage calculates as the sum of the LED forward voltages, the TLE4309 dropout voltage and the maximum voltage drop across the reference resistor R_{REF} .

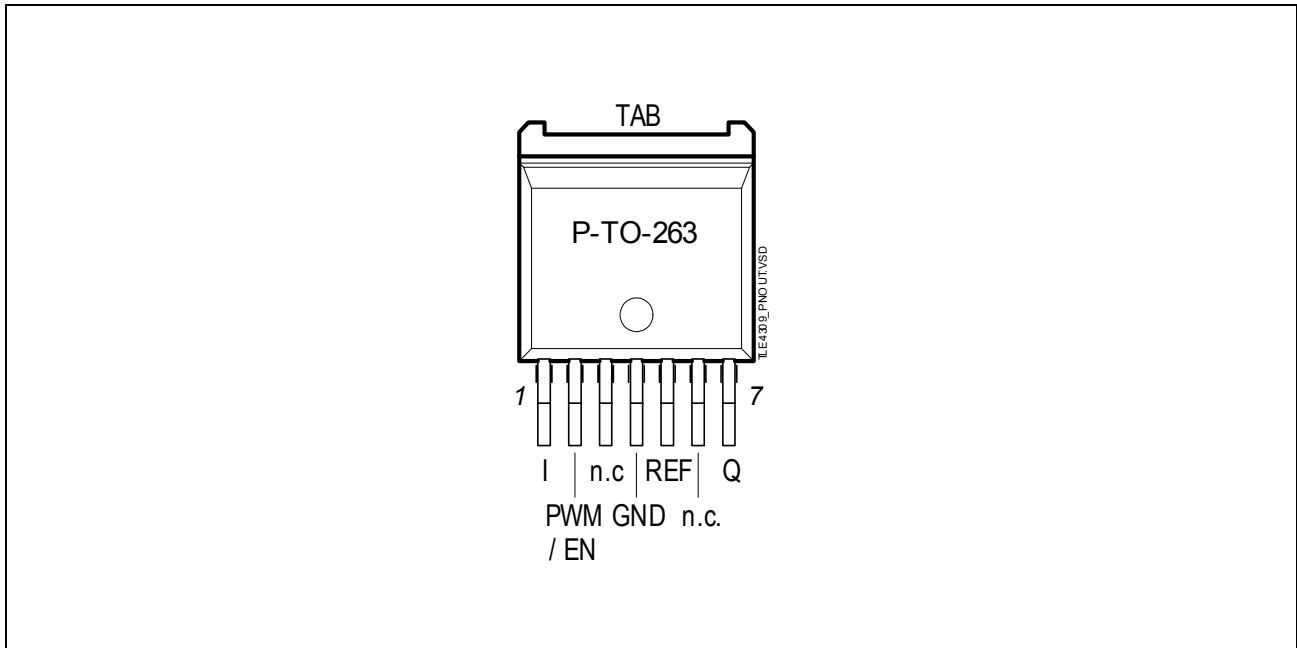

Figure 2 Pin Configuration (top view)

Table 1 Pin Definitions and Functions

Pin No.	Symbol	Function
1	I	Input.
2	PWM / EN	Pulse Width Modulation Input / ENABLE input. If not needed connect to I (pin 1).
3	n. c.	Internally not connected. Leave open.
4	GND	Ground reference; connect to heatsink area and to TAB.
5	REF	Reference Input; connect to shunt resistor.
6	n. c.	Internally not connected. Leave open.
7	Q	Output.
TAB		Connect to heatsink area and to GND pin.

Table 2 Absolute Maximum Ratings

Parameter	Symbol	Limit Values		Unit	Remarks
		Min.	Max.		
Input					
Voltage	V_I	-42	45	V	–
Current	I_I	–	–	mA	internally limited
Output					
Voltage	V_Q	-1	40	V	–
Current	I_Q	–	–	mA	internally limited
Reference Input					
Voltage	V_{REF}	-1	16	V	–
Current	I_{REF}	-2	2	mA	–
Pulse Width Modulation / Enable Input					
Voltage	V_{PWM}	-40	40	V	–
Current	I_{PWM}	-1	1	mA	–
Temperatures					
Junction temperature	T_j	-40	150	°C	–
Storage temperature	T_{stg}	-50	150	°C	–
ESD Susceptibility					
ESD Resistivity	$V_{ESD,HBM}$	-2	2	kV	Human Body Model ¹⁾

1) ESD susceptibility, HBM according to EIA/JESD 22-A114B

Note: Stresses above the ones listed here may cause permanent damage to the device. Exposure to absolute maximum rating conditions for extended periods may affect device reliability.

Note: Integrated protection functions are designed to prevent IC destruction under fault conditions described in the data sheet. Fault conditions are considered as “outside” normal operating range. Protection functions are not designed for continuous repetitive operation.

Table 3 Operating Range

Parameter	Symbol	Limit Values		Unit	Remarks
		Min.	Max.		
Input voltage	V_I	4.5	24	V	–
PWM / ENABLE voltage	V_{PWM}	0	24	V	–
Junction temperature	T_j	-40	150	°C	–
Reference resistor	R_{REF}	0	1.8	Ω	–

Note: Within the functional range the IC operates as described in the circuit description. The electrical characteristics are specified within the conditions given in the related electrical characteristics table

Table 4 Thermal Resistance

Parameter	Symbol	Typical Limit Values	Unit	Remarks
Junction ambient	R_{thja}	78	K/W	Footprint only ¹⁾
		52	K/W	300mm ² heat sink area ¹⁾
		39	K/W	600mm ² heat sink area ¹⁾
Junction case	R_{thjc}	3	K/W	–

1) Worst case regarding peak temperature; mounted on PCB FR4, 80 × 80 × 1.5 mm³, 35 μm Cu, horizontal position, zero airflow.

Table 5 Electrical Characteristics

$V_I = 13.5 \text{ V}$; $V_{\text{PWM}} \geq V_{\text{PWM,H}}$; $-25 \text{ }^\circ\text{C} < T_j < 125 \text{ }^\circ\text{C}$;
all voltages with respect to ground; unless otherwise specified

Parameter	Symbol	Limit Values			Unit	Test Condition
		Min.	Typ.	Max.		
Output						
Output current	I_Q	171	178	185	mA	$(V_Q - V_{\text{REF}})^1 = 6.6 \text{ V}$; $R_{\text{REF}} = 1.0 \text{ } \Omega$
		438	456	474	mA	$(V_Q - V_{\text{REF}})^1 = 6.6 \text{ V}$; $R_{\text{REF}} = 0.39 \text{ } \Omega$
Output current limit	$I_{Q\text{max}}$	–	600	–	mA	$R_{\text{REF}} = 0 \text{ } \Omega$
Dropout voltage	V_{dr}	–	0.35	0.7	V	$I_Q = 300 \text{ mA}$
Reference						
Reference Voltage	V_{REF}	172	178	184	mV	$0.39 < R_{\text{REF}} < 1.0 \text{ } \Omega$ $T_j = 25 \text{ }^\circ\text{C}$
Reference Voltage	V_{REF}	171	178	185	mV	$0.39 < R_{\text{REF}} < 1.0 \text{ } \Omega$
Reference Input Current	I_{REF}	-1	0.1	1	μA	$V_{\text{REF}} = 180 \text{ mV}$
Current Consumption						
Current consumption off mode	$I_{q,\text{OFF}}$	–	0.1	2	μA	PWM/EN = L, $T_j < 85 \text{ }^\circ\text{C}$
Current consumption	I_q	–	12	22	mA	$V_Q = 6.6 \text{ V}$; $R_{\text{REF}} = 0.47 \text{ } \Omega$
PWM / ENABLE						
PWM high level valid	$V_{\text{PWM,H}}$	2.6	–	–	V	–
PWM low level valid	$V_{\text{PWM,L}}$	–	–	0.7	V	–
PWM input current high level	$I_{\text{PWM,H}}$	–	220	500	μA	$V_{\text{PWM}} = 5.0 \text{ V}$
PWM input current low level	$I_{\text{PWM,L}}$	-1	–	1	μA	$V_{\text{PWM}} = 0.0 \text{ V}$
Turn on delay time	$t_{\text{PWM,ON}}$	0	15	40	μs	70% of $I_{Q\text{nom}}$
Turn off delay time	$t_{\text{PWM,OFF}}$	0	15	40	μs	30% of $I_{Q\text{nom}}$

1) $(V_Q - V_{\text{REF}})$ equals the forward voltage sum of the connected LEDs, see figure 1.

Typical Performance Characteristics

Output Current versus Reference Resistor

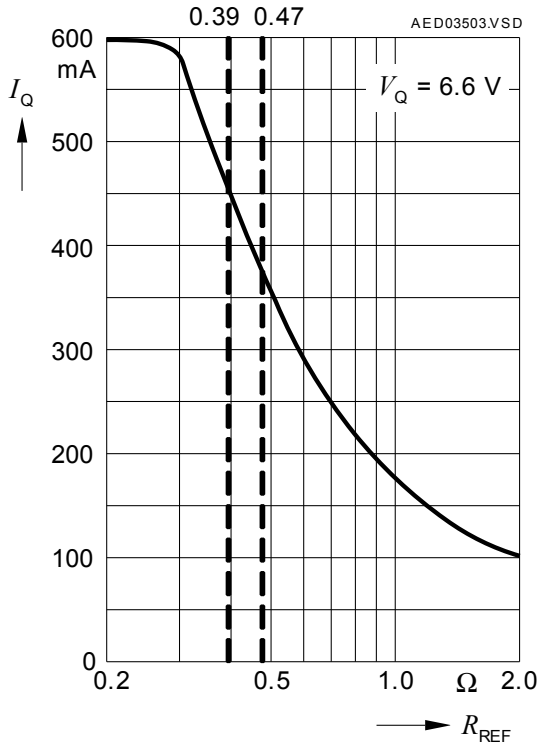

Reference Voltage versus Junction Temperature

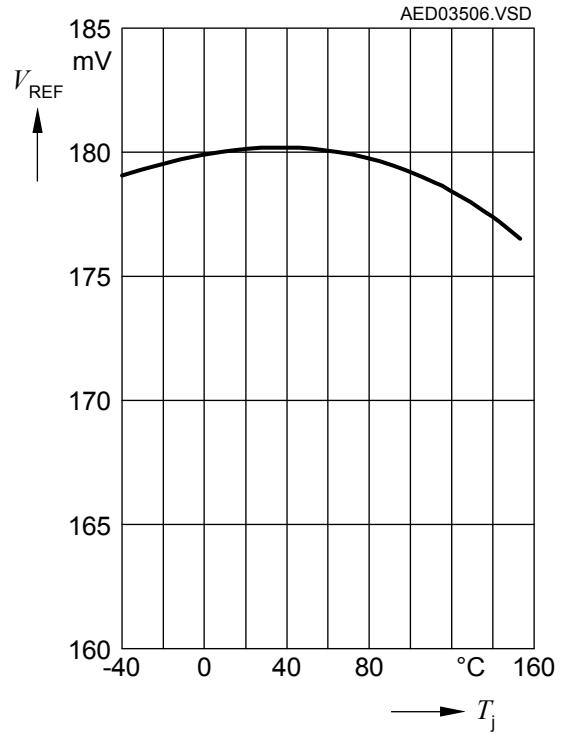

Output Current versus Supply Voltage

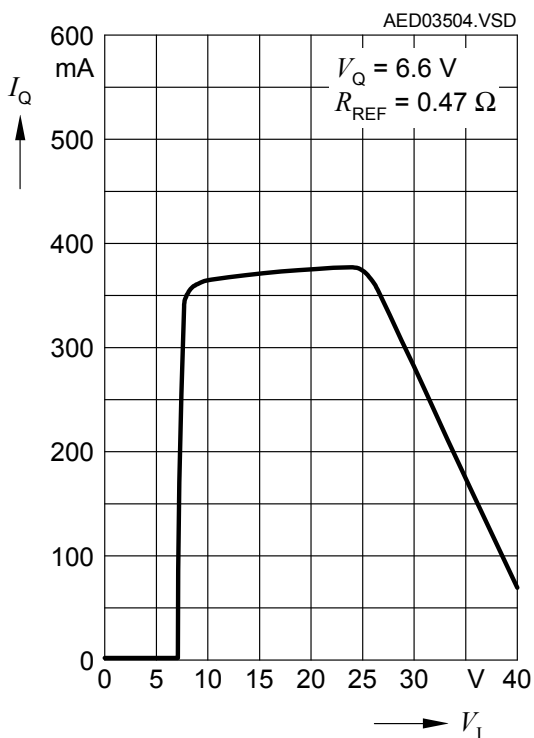

PWM/EN Pin Input Current versus Voltage applied

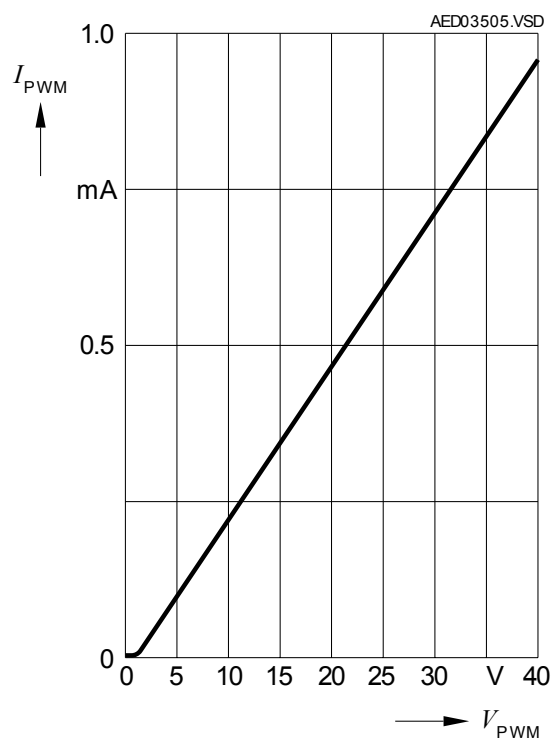

Package Outline

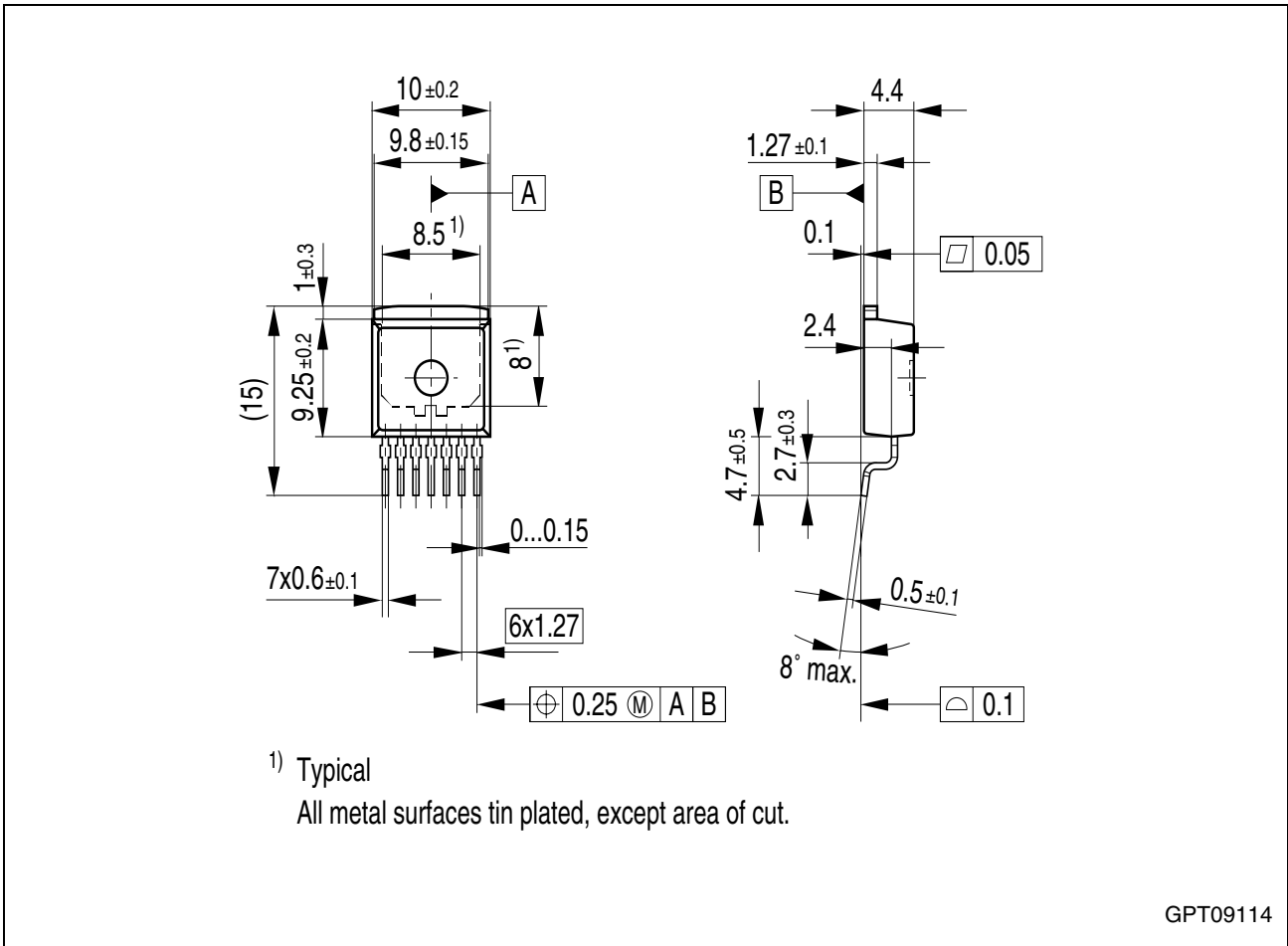

Figure 3 PG-TO263-7-1

Green Product (RoHS compliant)

To meet the world-wide customer requirements for environmentally friendly products and to be compliant with government regulations the device is available as a green product. Green products are RoHS-Compliant (i.e Pb-free finish on leads and suitable for Pb-free soldering according to IPC/JEDEC J-STD-020).

find all packages, sorts of packing and others on the Infineon Internet Page "Packages": <http://www.infineon.com/packages>.

SMD = Surface Mounted Device

Dimensions in mm

Application Note: Thermal Considerations ¹⁾

By describing an example, this section shows how the power dissipation and the needed thermal resistance can be estimated.

For a typical application circuit as shown in Figure 1, the following parameters shall apply:

- Number of LEDs in series: 3
- LED current desired: $I_F = 260 \text{ mA}$
- LED minimum forward voltage: $V_{F,MIN} = 3.0 \text{ V}$
- LED maximum forward voltage: $V_{F,MAX} = 3.4 \text{ V}$
- Supply minimum DC voltage: $V_{I,MIN} = 11.0 \text{ V}$
- Supply maximum DC voltage: $V_{I,MAX} = 13.0 \text{ V}$
- Maximum ambient temperature: $T_{a,max} = 85 \text{ °C}$

1. Selecting the reference resistor:

The reference resistor R_{REF} can be selected by using the formular on page 2 or by taking the value from the typical performance graph “Output Current versus Reference Resistor” on Page 7. In order to obtain a LED forward current of $I_F = 260 \text{ mA}$, the graph shows an reference resistor of $R_{REF} = 0.68 \text{ }\Omega$.

2. Verifying the minimum supply voltage:

In order to be able to drive the LEDs with a constant current, the minimum supply voltage needed is:

$$V_{I,MIN} = V_{F,MAX,total} + V_{dr} + V_{REF}$$

whereas $V_{F,MAX,total}$ is the maximum forward voltage sum of the LEDs connected in series, V_{dr} the dropout voltage and V_{REF} the reference voltage.

Since the power dissipation is low at a small voltage drop across the regulator, $V_{dr} = 0.35 \text{ V}$ is assumed. The maximum reference voltage is $V_{REF} = 185 \text{ mV}$. Therefore, a minimum supply voltage of 11 V is sufficient for the example given above.

3. Determining the minimum and maximum LED forward current:

The TLE4309 has an accuracy of < 4 %. With a reference resistor of $R_{REF} = 0.68 \text{ }\Omega$, the output current I_Q will be between 251 mA and 272 mA.

1) This information is given as a hint for the implementation of the device only and shall not be regarded as a description or warranty of a certain functionality, condition or quality of the device.

4. Calculating the maximum power dissipation:

For calculating the maximum power dissipation, the minimum forward voltage sum of the LEDs connected in series $V_{F,MIN,total}$ (= No. of LEDs * $V_{F,MIN}$), the maximum supply voltage $V_{I,MAX}$, the IC current consumption $I_{Q,MAX}$, as well as the the maximum output current $I_{Q,MAX}$ needs to be considered. Hence, the maximum power dissipation $P_{D,MAX}$ calculates:

$$P_{D,MAX} = (V_{I,MAX} - V_{F,MIN,total}) * I_{Q,MAX} + V_{I,MAX} * I_{Q,MAX}$$

With assuming a maximum current consumption of 15 mA @ $I_Q = 260$ mA, the maximum power dissipation for the example is 1.28 W.

5. Thermal Resistance needed:

The thermal resistance from junction to ambient $R_{th,j-a}$ calculates:

$$R_{th,j-a} = (T_{j,max} - T_{a,max}) / P_{D,MAX}$$

With allowing a junction temperature of 150 °C, the $R_{th,j-a}$ needed in our example would be 50 K/W.

In case some copper area on the PCB is used as a heat sink, the area needed is approximately 6 cm² (board in horizontal position, no airflow). If the area is not available, several via holes to the GND-layer or to a heatsink area on the PCB backside help to distribute the heat.

For additional information on the thermal resistance see Infineon's special subject book "Thermal Resistance - Theory and Practice" including extended package information.

Revision History

Version	Date	Changes
Rev. 1.0	2007-03-20	Final Datasheet and initial version of RoHS-compliant derivate of TLE4309G Page 1 and Page 8 : RoHS compliance statement and green product feature added Page 1 and Page 8 : Package changed to RoHS compliant version Legal Disclaimer updated

Edition 2007-03-20

**Published by
Infineon Technologies AG
81726 Munich, Germany**

**© 2007 Infineon Technologies AG
All Rights Reserved.**

Legal Disclaimer

The information given in this document shall in no event be regarded as a guarantee of conditions or characteristics. With respect to any examples or hints given herein, any typical values stated herein and/or any information regarding the application of the device, Infineon Technologies hereby disclaims any and all warranties and liabilities of any kind, including without limitation, warranties of non-infringement of intellectual property rights of any third party.

Information

For further information on technology, delivery terms and conditions and prices, please contact the nearest Infineon Technologies Office (www.infineon.com).

Warnings

Due to technical requirements, components may contain dangerous substances. For information on the types in question, please contact the nearest Infineon Technologies Office.

Infineon Technologies components may be used in life-support devices or systems only with the express written approval of Infineon Technologies, if a failure of such components can reasonably be expected to cause the failure of that life-support device or system or to affect the safety or effectiveness of that device or system. Life support devices or systems are intended to be implanted in the human body or to support and/or maintain and sustain and/or protect human life. If they fail, it is reasonable to assume that the health of the user or other persons may be endangered.

Данный компонент на территории Российской Федерации

Вы можете приобрести в компании MosChip.

Для оперативного оформления запроса Вам необходимо перейти по данной ссылке:

<http://moschip.ru/get-element>

Вы можете разместить у нас заказ для любого Вашего проекта, будь то серийное производство или разработка единичного прибора.

В нашем ассортименте представлены ведущие мировые производители активных и пассивных электронных компонентов.

Нашей специализацией является поставка электронной компонентной базы двойного назначения, продукции таких производителей как XILINX, Intel (ex.ALTERA), Vicor, Microchip, Texas Instruments, Analog Devices, Mini-Circuits, Amphenol, Glenair.

Сотрудничество с глобальными дистрибьюторами электронных компонентов, предоставляет возможность заказывать и получать с международных складов практически любой перечень компонентов в оптимальные для Вас сроки.

На всех этапах разработки и производства наши партнеры могут получить квалифицированную поддержку опытных инженеров.

Система менеджмента качества компании отвечает требованиям в соответствии с ГОСТ Р ИСО 9001, ГОСТ РВ 0015-002 и ЭС РД 009

Офис по работе с юридическими лицами:

105318, г.Москва, ул.Щербаковская д.3, офис 1107, 1118, ДЦ «Щербаковский»

Телефон: +7 495 668-12-70 (многоканальный)

Факс: +7 495 668-12-70 (доб.304)

E-mail: info@moschip.ru

Skype отдела продаж:

moschip.ru

moschip.ru_4

moschip.ru_6

moschip.ru_9