

Accessories Miniature Connector Zubehör Miniatur Steckverbinder

Spring Locks Federbügelverriegelungen

General Information

All Products of Accessories for D-Sub Connectors are RoHS compliant. A summary of all products and possible exceptions can be found on our internet site www.fctgroup.com, Menu item RoHS product summary.

Spring Locks

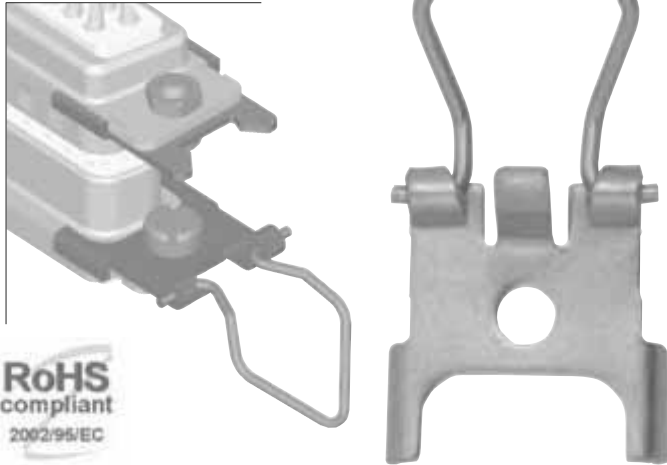

Spring Lock F1045-... with Mounting Screws Federbügel F1045-... mit Befestigungsschraube

Dimensions Abmessungen

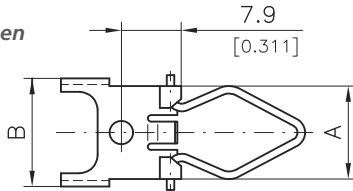

Sizes and Order-Information Größen und Bestell-Informationen

Order Number Bestellnummer	Suitable for Shell Size Passend für Gehäusegröße	A	B
F1045-1	1 - 4	12,3 (0.484)	14,3 (0.563)
F1045-5	5	15,5 (0.610)	17,2 (0.677)

Packing Units

Packing unit
2 reception plates
2 spring locks
2 spring washers
2 nuts
2 screws

Allgemeine Informationen

Alle Erzeugnisse des Zubehörs für D-Sub Steckverbinder sind RoHS konform. Eine Übersicht über alle Erzeugnisse und eventuelle Ausnahmen finden Sie auf unserer Internetseite www.fctgroup.com, Menüpunkt RoHS Artikelübersicht.

Federbügelverriegelung

Advantages and Special Features

- Spring lock is mounted on the front panel and the corresponding D-Sub connector
- Lockplate F1044-1 is screwed on the metal hood
- with Corresponding Mounting Screw
- Packed in Pairs
- Material: Stainless steel

Vorteile und Merkmale im Überblick

- Der Federbügel wird an der Frontplatte bzw. am Gegensteckverbinder montiert
- An der Metallhaube wird die Verschlussplatte F1044-1 angeschraubt.
- mit passender Befestigungsschraube
- paarweise verpackt
- Material: Edelstahl

Accessories for Spring Locks

Locking Plate F1044 Zubehör für die Federbügelverriegelung Verschlussplatte F1044

Dimensions Abmessungen

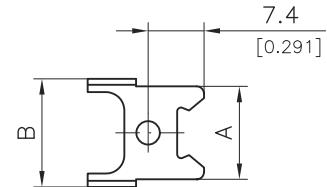

Sizes and Order-Information Größen und Bestell-Informationen

Order Number Bestellnummer	Suitable for Shell Size Passend für Gehäusegröße	A	B
F1044-1	1 - 4	12,3 (0.484)	14,3 (0.563)
F1044-5	5	15,6 (0.614)	17,2 (0.677)

Verpackungseinheiten

Verpackungseinheit
2 St. Aufnahmeplatten
2 St. Federbügel
2 St. Federringe
2 St. Muttern
2 St. Schrauben

Slide Locks F-GV-...



Gleitverriegelungen F-GV-...

Advantages and Special Features

- inclusiv fixing Screw
- wide range of accessories
- for the mounting of appliances
- Locking in place occurs by sliding the locking frame

Vorteile und Merkmale im Überblick

- inklusive Befestigungsschraube
- umfangreiches Montagezubehör
- geeignet für die Gerätemontage
- die Verriegelung erfolgt durch Verschieben des Gleitverriegelungsrahmens

Dimensions
Abmessungen



Shell Size Gehäusegröße	Order Number for Appliance Mounting Bestellnummer bei Gerätemontage	A	B	C	D
1	F-GV-1	35,1	25,0	12,5	4-40 UNC
	F-GV-1M3	(1.382)	(0.984)	(0.492)	M3
2	F-GV-2	43,1	33,3	12,5	4-40 UNC
	F-GV-2M3	(1.697)	(1.311)	(0.492)	M3
3	F-GV-3	56,94	47,0	12,5	4-40 UNC
	F-GV-3M3	(2.242)	(1.852)	(0.492)	M3
4	F-GV-4	73,3	63,5	12,5	4-40 UNC
	F-GV-4M3	(2.886)	(2.500)	(0.492)	M3
5	F-GV-5	72	61,1	14,7	4-40 UNC
	F-GV-5M3	(2.835)	(2.406)	(0.579)	M3

Packing Units

Verpackungseinheiten

Packing Unit

Verpackungseinheit

Appliance Assembly

Gerätemontage

1 frame

1 St. Rahmen

2 short screws

2 St. kurze Schrauben

2 nuts

2 St. Müttern

2 spring washers

2 St. Federringe



Lock Posts F-SGV1/5-...
for Slide Locking

Gegenschrauben F-SGV1/5-...
für Gleitverriegelung

Outer Thread 4-40 UNC Dimensions

Außengewinde 4-40 UNC Abmessungen



Outer Thread M3 Dimensions

Außengewinde M3 Abmessungen

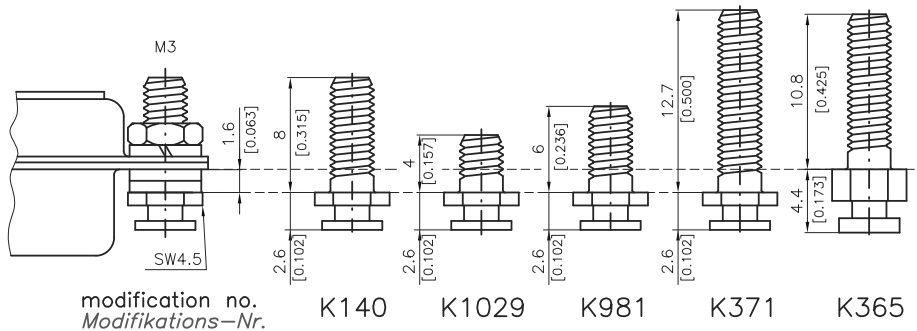

Technical Data

Technische Daten

	Zinc Plated Version Verzinkte Ausführung	Tin Plated Version Verzinnte Ausführung
Order Number Bestellnummer	F-SGV1/5-...	F-SGV1/5-...SN
Material	steel, zinc plated, blue chromate, Stahl verzinkt, blau chromatiert,	steel, tin plated Stahl verzinkt

Packing Units

Verpackungseinheiten

Packing Unit Verpackungseinheit	
Head Height 0.012" Kopfhöhe 2,6 mm	Head Height 0.165" Kopfhöhe 4,2 mm
2 bolts 2 St. Bolzen	2 bolts 2 St. Bolzen
4 washers 4 St. Unterlegscheiben	2 spring washers 2 St. Federringe
2 spring washers 2 St. Federringe	2 nuts 2 Muttern

Ordering Example

Lock post for slide lock, Hex. 4.5 mm (0.177"), head size 2.6 mm (0.102"), outer thread M3, length 8 mm (0.197"), tin plated: **F-SGV1/5-K140SN**

Bestellbeispiel

Gegenschraube für Gleitverriegelung mit Schlüsselweite 4,5 mm, Kopfhöhe 2,6 mm, Außengewinde M3, Länge 8 mm, verzinkt: **F-SGV1/5-K140SN**

Screw Locks F-SCHV...

Schraubverriegelungen F-SCHV...

Dimensions
Abmessungen

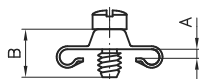
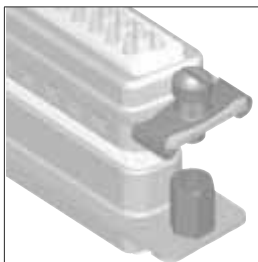

Mounting information

Screw locks F-SCHV-... (thread 4-40 UNC) are mounted on the connector shell. They are packed in pairs.

Montageinformation

Die Schraubverriegelungen F-SCHV-... (Gewinde 4-40 UNC) werden am Steckverbindergehäuse montiert. Sie sind paarweise verpackt.

Order Number <i>Bestellnummer</i>	Suitable for Shell Size 1 - 4 <i>Passend für Gehäusegröße 1 - 4</i>	A	B	Surface <i>Oberfläche</i>
F-SCHV-1	Pin and socket connector <i>Stift- und Buchsensteckverbinder direkt</i>	0,8 (0.031)	6,35 (0.250)	
F-SCHV-2	Pin and socket connector with sheet metal hood <i>Stift- und Buchsensteckverbinder mit Blechhaube</i>	1,2 (0.047)	7,15 (0.281)	Zinc-plated <i>verzinkt</i>
F-SCHV-3	Pin and socket connector <i>Stift- und Buchsensteckverbinder direkt</i>	0,8 (0.031)	7,15 (0.281)	

Dimensions in mm (inch) - Abmessungen in mm (inch)



D-Sub Connector with Accessories

D-Sub Steckverbinder mit Anbauteilen

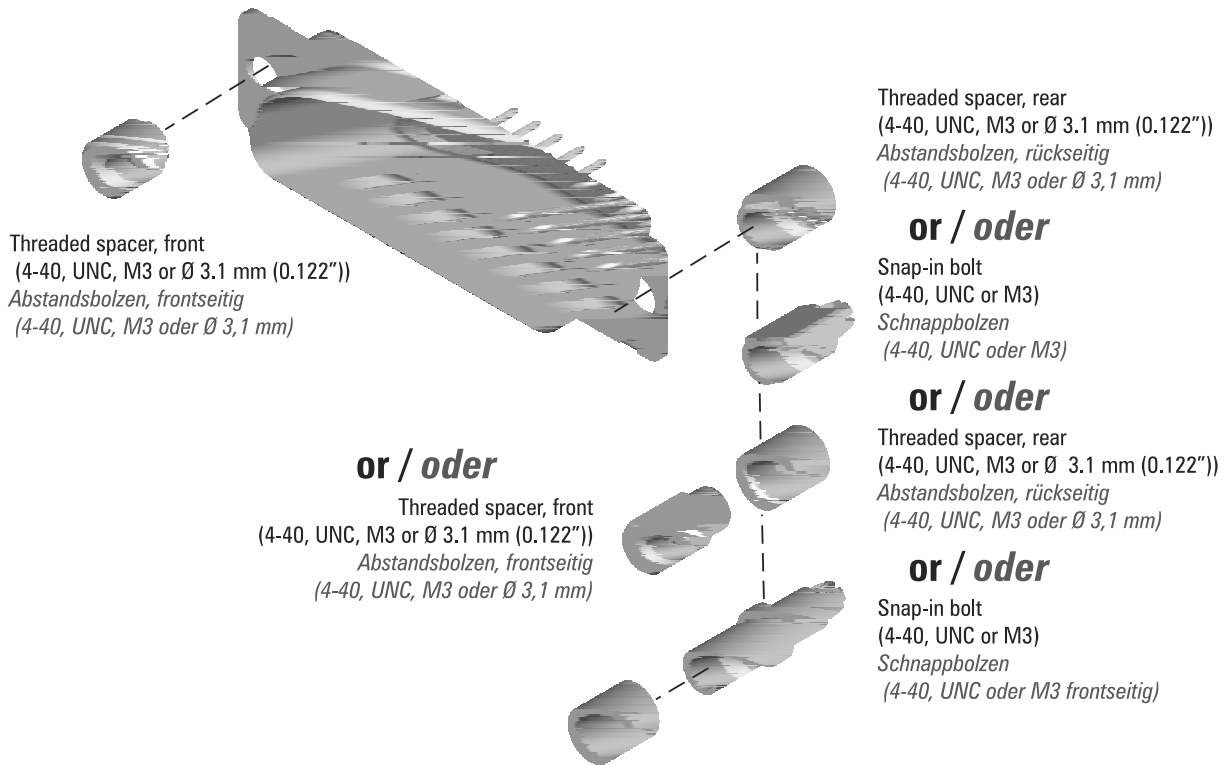

Clinch Nuts
Einnietmuttern

Dimensions
Abmessungen



Mounting Type	Self Locking	Surface
Befestigungsart	Selbstsichernd	Oberfläche
T	—	Tin-plated or zinc-plated
Z	—	
TS	•	verzinkt oder verzinkt
ZS	•	

Ordering Example

Pin connector, clinch nut 4-40 UNC, 9 contacts, solder pot termination, performance class 1: **FT09P0G1**

Bestellbeispiel

Stiftsteckverbinder, Einnietmutter 4-40 UNC, 9-polig, Löttopfkontakt, Gütestufe 1: **FT09P0G1**

Spacers

Abstandsbolzen

Rear Riveted Inner Thread 4-40 UNC

Rückseitig vernietet Innengewinde 4-40 UNC

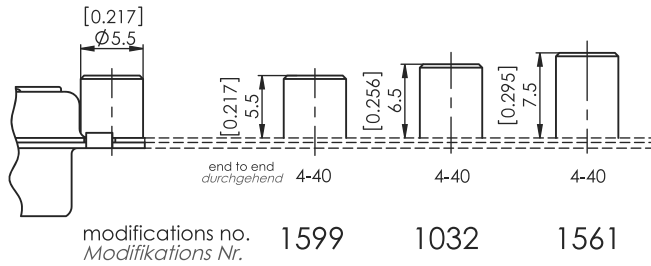

Modification

The modification number for the spacers completes the order number for the connector on which they are mounted. Surface: Tin-plated

Modifikation

Die Modifikationsnummer des Abstandsbolzens ergänzt die Bestellnummer des Steckverbinders, in den der Abstandsbolzen eingebaut ist. Oberfläche: Verzinkt

Inner Thread M3

Innengewinde M3

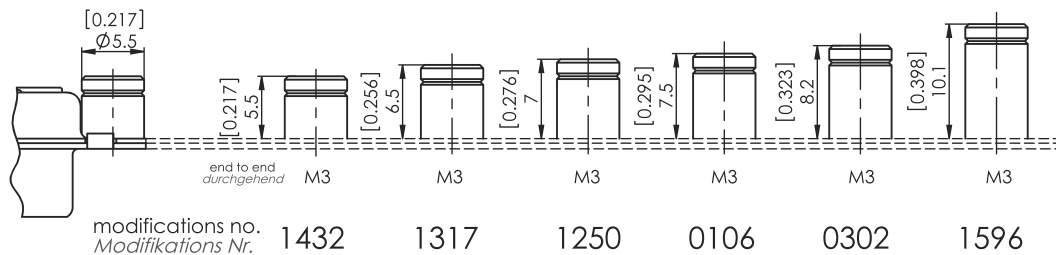

Through Hole Ø 3.1 mm (0.122")
Durchgangsloch Ø 3,1 mm

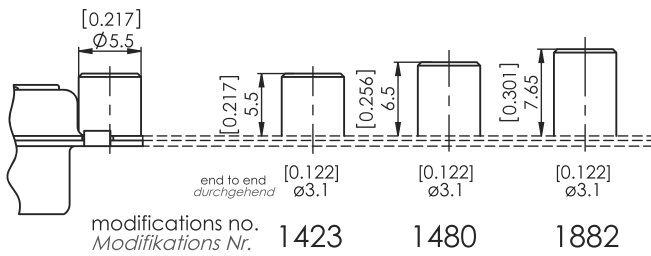

Ordering Example

Pin connector, 15 contacts, straight PCB termination, performance class 1, rear riveted threaded spacer with inner thread M3 and length 5.5 mm (0.217"): **F15P1G1-1432**

Bestellbeispiel

Stiftsteckverbinder, 15-polig, gerader Leiterplattenanschluss, Gütestufe 1, rückseitig vernieteter Abstandsbolzen mit Innengewinde M3 und Länge 5,5 mm: **F15P1G1-1432**

Front Riveted

Frontseitig vernietet

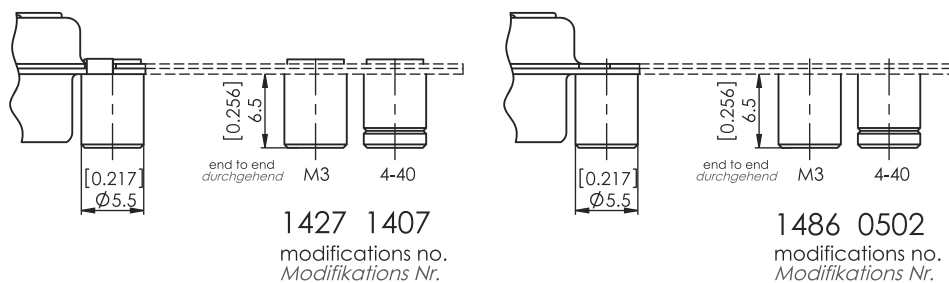

Only 1427 and 1407 are suitable for hood assembly as the rear part is uneven.

1427 und 1407 nur für Haubenmontage geeignet, da Rückteil nicht planeben.



Frontside Spacers and Rearside Spacers
or Snap-in Bolts

Frontseitiger Abstandsbolzen und rücksei-
tiger Abstands- oder Schnappbolzen

Frontside Inner Thread 4-40 UNC

Frontseitiges Innengewinde 4-40 UNC



Frontside Inner Thread M3

Frontseitiges Innengewinde M3

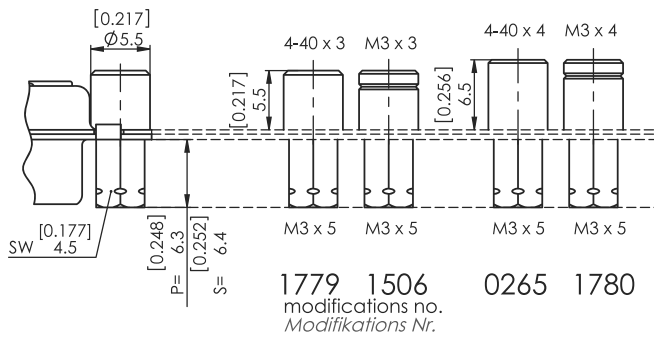

Through Hole Ø 3.1 mm (0.122")

Durchgangsloch Ø 3,1 mm

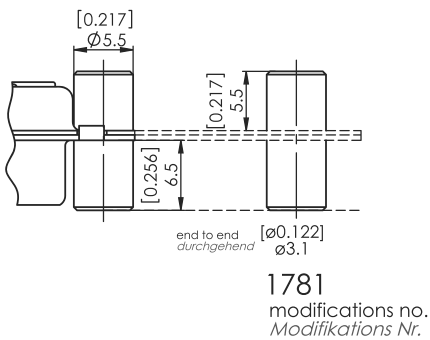

Frontside Inner Thread

Rearside Snap-in Bolt (Recommended Diameter of the Assembly Drilling $\varnothing 3.0 \text{ mm} \pm 0.1$ (0.118" ± 0.004))



Ordering Example

Pin connector, 15 contacts, straight PCB termination, performance class 1, front and rear side spacers with front side inner thread M3 and rear side inner thread 4-40 UNC, length 5.5 mm (0.217"): **F15P1G1-1779**

Frontseitiges Innengewinde

Rückseitiger Schnappbolzen (empfohlener Durchmesser der Montagebohrungen $\varnothing 3,0 \text{ mm} \pm 0,1$)

The modification number for the spacers completes the order number for the connector on which they are mounted.

Die Modifikationsnummer des Abstandsbolzens ergänzt die Bestellnummer des Steckverbinders, in den der Abstandsbolzen eingebaut ist.

Surface: Tin-plated (only when using tin-plated shells)

Oberfläche: Verzinkt (Nur in Verbindung mit verzinntem Gehäuse.)

Bestellbeispiel

Stiftsteckverbinder, 15-polig, gerader Leiterplattenanschluss, Gütestufe 1, front- und rückseitiger Abstandsbolzen mit frontseitigem Innengewinde M3 und rückseitigem Innengewinde 4-40 UNC, Länge 5,5 mm: **F15P1G1-1779**



Snap-In Bolts for PCB Mounting

Schnappbolzen für Leiterplattenmontage

For PCBs with 1.6 mm (0.063") Thickness
(Recommended Diameter of the Assembly
Drilling \varnothing 3.0 mm \pm 0.1 (0.118" \pm 0.004))

Für Leiterplatten mit 1,6 mm Stärke
(empfohlener Durchmesser der
Montagebohrungen \varnothing 3,0 mm \pm 0,1)

The Advantages of This New Design are:

- less snap-in force required for an increased retention strength.
- constant development of power when snapping in
- less sensitivity to the tolerance of the assembly hole.

Die Vorteile der neuen Geometrie sind:

- geringere Einpresskraft bei hoher Haltekraft
- gleichmäßiger Kraftverlauf beim Einpressen
- geringere Empfindlichkeit gegenüber Montagelochtoleranzen.

As a result the required press-in force on to the PCB is lessened without diminishing the retention strength.

Dadurch wird eine weichere Einrastung auf der Leiterplatte ohne Verringerung der Haltekraft erreicht.

Depending on the snap-in rivet, the press in strength per snap-in rivet, with a diameter of 3 mm, lies between 20 - 60 N. In contrast a press in strength of 100 N was required with the previous snap-in geometry.

Abhängig vom Snap-in Niet liegen die Einpresskräfte pro Snap-in Niet bei einem Durchmesser von 3 mm bei 20 - 60 N. Bei der bisherigen Snap-in Geometrie waren dagegen Einpresskräfte bis 100 N erforderlich.



The modification number for the snap-in bolts completes the order number for the connector on which they are mounted. Platings: Tin plated over nickel, only when using tin-plated shells.

Die Modifikationsnummer des Schnappbolzens ergänzt die Bestellnummer des Steckverbinders, in den der Schnappbolzen eingebaut ist. Oberflächen: Verzinkt über Nickel, nur in Verbindung mit verzintem Gehäuse.

Snap-In Bolts for PCB Mounting

Schnappbolzen für Leiterplattenmontage

For PCBs with 2.4 mm (0.094") Thickness
(Recommended Diameter of the Assembly
Drilling \varnothing 3.0 mm \pm 0.1 (0.118" \pm 0.004))

Für Leiterplatten mit 2,4 mm Stärke
(empfohlener Durchmesser der
Montagebohrungen \varnothing 3,0 mm \pm 0,1)

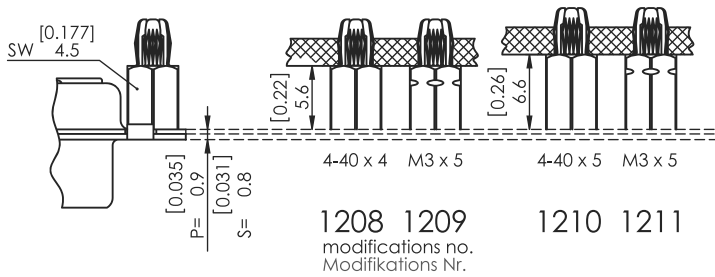

For PCBs with 3.2 mm (0.126") Thickness
(Recommended Diameter of the Assembly
Drilling \varnothing 3.0 mm \pm 0.1 (0.118" \pm 0.004))

Für Leiterplatten mit 3,2 mm Stärke
(empfohlener Durchmesser der
Montagebohrungen \varnothing 3,0 mm \pm 0,1)

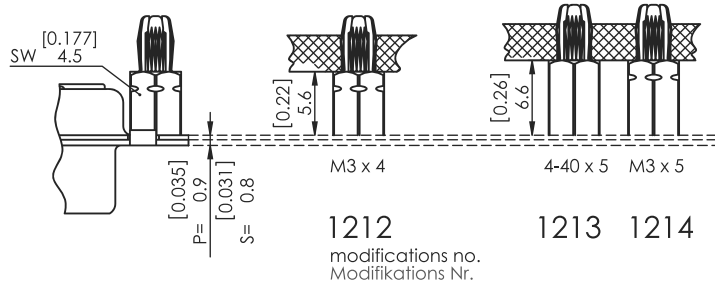

The modification number for the snap-in bolts completes the order number for the connector on which they are mounted. Platings: Tin plated over nickel, only when using tin-plated shells.

For the assembly and positioning of connectors, FCT has modified its well proven snap-in bolts and snap-in rivets.

Die Modifikationsnummer des Schnappbolzens ergänzt die Bestellnummer des Steckverbinders, in den der Schnappbolzen eingebaut ist. Oberflächen: Verzinkt über Nickel, nur in Verbindung mit verzintem Gehäuse.

Für die Montage und Positionierung der Steckverbinder hat FCT electronic die bewährten Schnappbolzen und Snap-in-Nieten modifiziert.



Stamped Latch Locks for PCB Mounting

Dimensions Abmessungen

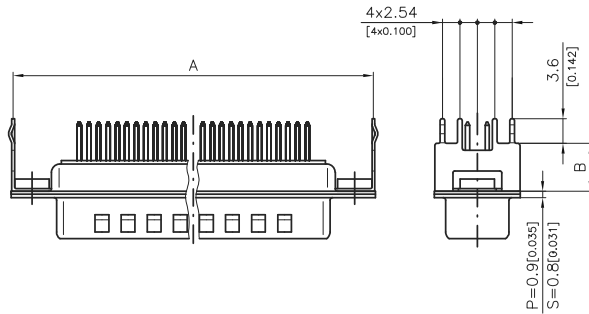

Shell Size Gehäusegröße	A	B
1	30,46 (1.199)	5,6
2	38,76 (1.526)	(0.220) or
3	52,5 (2.067)	oder 7
4	68,96 (2.715)	(0.276)

Dimensions in mm (inch) - Abmessungen in mm (inch)

Gestanzte Rastelemente für Leiterplattenmontage

Fig. 1: Latch lock mounted on connector
Abb. 1: Rastelement am Steckverbinder montiert

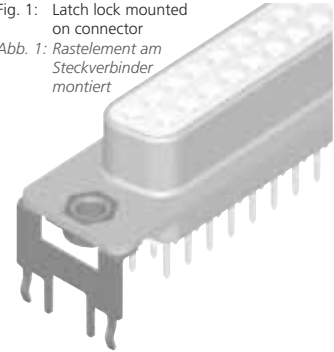

Fig. 2: Detail latch lock
Abb. 2: Detail Rastelement



Technical Data Technische Daten

Technical Data Technische Daten	
Material	Steel
Material	Stahl
Plating	Tin plated over nickel
Oberfläche	Zinn über Nickel
For PCB thickness für Leiterplattenstärke	1,6 mm (0.063")

Modifications Modifikationen

Modification No. Modifikationsnummern	
-0503	Thread 4-40 UNC Gewinde 4-40 UNC
-0348	Thread M3 Gewinde M3
-0504	Through hole Ø 3.1 mm (Ø 0.122") Durchgangsloch Ø 3,1 mm

Ordering Example

9 contact pin connector, performance class 1, straight PCB termination, stamped latch lock for PCB mounting, thread M3: **F09P1G1-0348**

Other heights available on request.

Bestellbeispiel

9-poliger Stiftsteckverbinder, gerader Leiterplattenanschluss, Gütestufe 1, Rastelement mit Gewinde M3: **F09P1G1-0348**

Andere Höhen auf Anfrage.

Female Screw Locks F-GSCH1/5...
Hex. 4.5 mm (0.177")

Sechskantbolzen F-GSCH1/5...
Schlüsselweite 4,5 mm

Outer Thread 4-40 UNC, Inner Thread 4-40 UNC

Außengewinde 4-40 UNC, Innengewinde 4-40 UNC

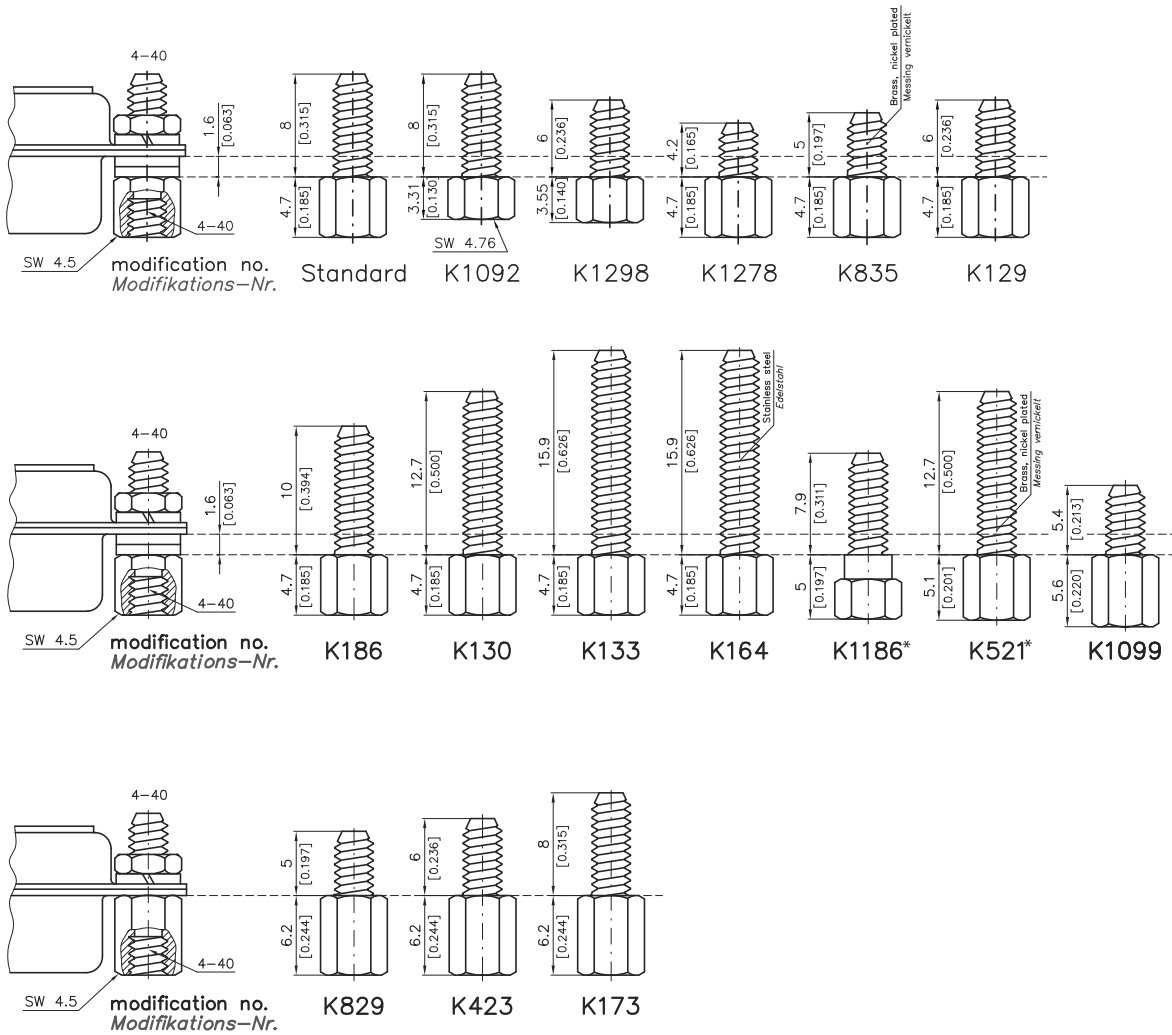

Outer Thread M3, Inner Thread M3

Außengewinde M3, Innengewinde M3

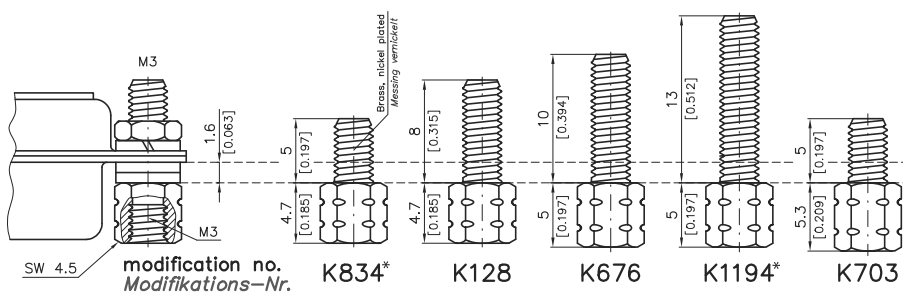

Female Screw Locks F-GSCH1/5...
Hex. 4.5 mm (0.177")

Sechskantbolzen F-GSCH1/5...
Schlüsselweite 4,5 mm

Outer Thread M3, Inner Thread M3

Außengewinde M3, Innengewinde M3

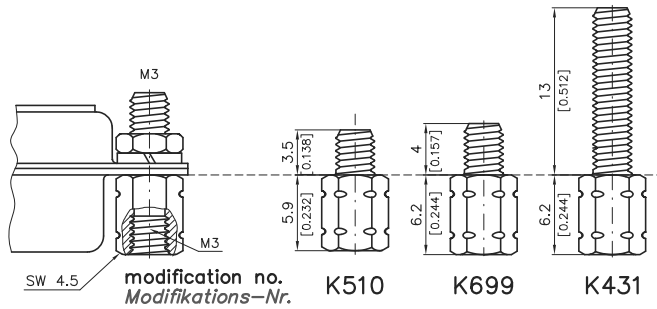

Outer Thread 4-40 UNC, Inner Thread M3

Außengewinde 4-40 UNC, Innengewinde M3

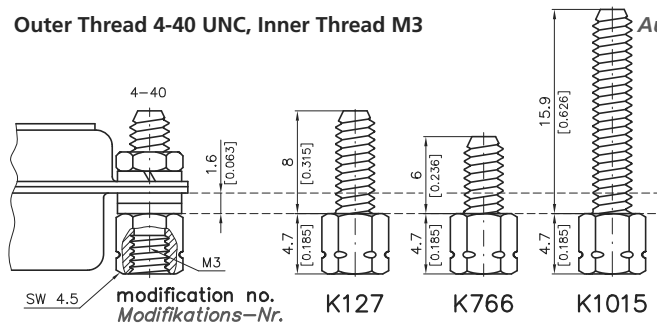

Outer Thread M3, Inner Thread 4-40 UNC

Außengewinde M3, Innengewinde 4-40 UNC

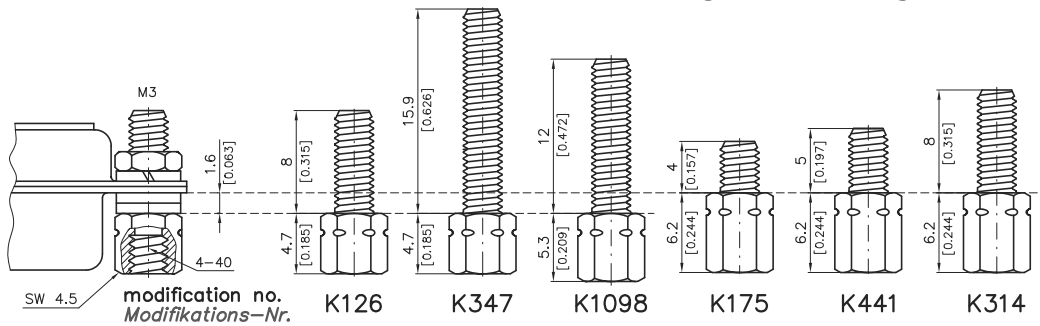

Outer Thread M2,5; Inner Thread 4-40 UNC

Außengewinde M2,5; Innengewinde 4-40 UNC

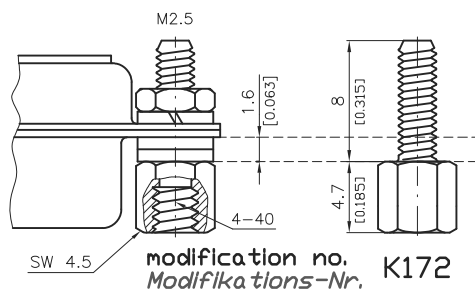

Female Screw Locks F-GSCH1/5...
Hex. 5.0 mm (0.197")

Sechskantbolzen F-GSCH1/5...
Schlüsselweite 5,0 mm

Outer Thread M3, Inner Thread M3

Außengewinde M3, Innengewinde M3



Outer Thread 4-40 UNC,
Inner Thread 4-40 UNC

Außengewinde 4-40 UNC,
Innengewinde 4-40 UNC

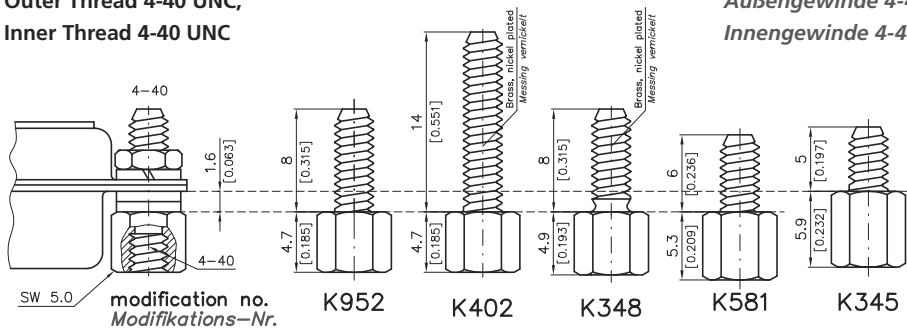

Ordering Example

Female screw lock, spanner size Hex. 4,5 mm (0.177"), outer thread M3, length 5 mm (0.197"), inner thread 4-40 UNC, head size 6.2 mm (0.244"), tin plated:

F-GSCH1/5-K441SN

Bestellbeispiel

Sechskantbolzen mit Schlüsselweite 4,5 mm, Außengewinde M3, Länge 5 mm, Innengewinde 4-40 UNC, Kopfhöhe 6,2 mm, verzinkt: **F-GSCH1/5-K441SN**

Delivery Quantity

Washers are not included for head size 5.9 mm (0.232") or 6.2 mm (0.244"). All female screw locks are packed in pairs (that means 2 bolts, 4 washers, 2 spring washers, 2 nuts). Also available bulk packed on request.

* Please request the number of accessories included.

Lieferumfang

Bei Kopfhöhe 5,9 mm oder 6,2 mm sind im Lieferumfang keine Unterlegscheiben enthalten. Alle Sechskantbolzen sind paarweise (d.h. 2 Bolzen, 4 Unterlegscheiben, 2 Federringe, 2 Muttern) verpackt. Auf Anfrage auch als Schüttware lieferbar.

* Die Anzahl des beigefügten Zubehörs bitte anfragen.

Technical Data

Technische Daten

	Zinc Plated Version Verzinkte Ausführung	Tin Plated Version Verzinnte Ausführung
Material	Steel, zinc plated, blue chromate	Steel, tin plated
Material	Stahl, verzinkt, blau chromatiert	Stahl, verzinnt
Order number Bestellnummer	F-GSCH1/5-...	F-GSCH1/5-...SN
Maximum torque Maximales Anzugsmoment	48Ncm (0.356 ft.lbf) 48Ncm	



Reduction Plates FRP...

Reduzierplatten FRP...

Dimensions

Abmessungen

For mounting D-Sub connectors in larger panel cut-outs.
Other sizes and M3 thread are available on request.

Zum Einbau eines D-Sub Steckverbinders in größere Frontplattenausschnitte. Andere Größen, bzw. Gewinde M3 auf Anfrage lieferbar.

Material Steel, Plating Tin Plated
Material Stahl, Oberfläche verzinkt



Order Number Bestellnummer	From Size von Größe	To Size auf Größe	A	B	C	D
FRP3/1	3	1	53,0 (2.087)	20,0 (0.787)	47,04 (1.852)	25,0 (0.984)
FRP5/3	5	3	67,2 (2.646)	42,2 (1.661)	61,1 (2.406)	47,04 (1.852)

Dimensions in mm (inch) - Abmessungen in mm (inch)

Cover F1049-...

Abdeckplatten F1049-...

Dimensions

Abmessungen

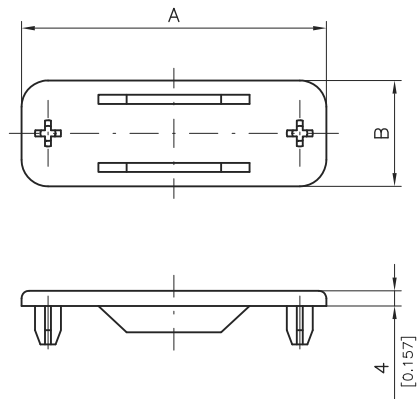

Colour Grey, Material ABS
Farbe Grau, Material ABS

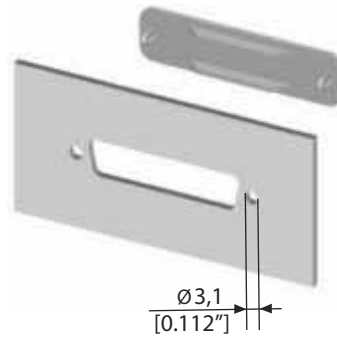

For covering of unused panel cut-outs.
Zur Abdeckung nicht benötigter Montageausschnitte.

Order Number Bestellnummer	For Shell Size Für Gehäusegröße	A	B
F1049-1	1	32,0 (1.260)	14,0 (0.551)
F1049-2	2	40,3 (1.587)	14,0 (0.551)
F1049-3	3	54,0 (2.126)	14,0 (0.004)
F1049-4	4	70,5 (2.776)	14,0 (0.551)
F1049-5	5	68,1 (2.681)	16,6 (0.654)

Dimensions in mm (inch) - Abmessungen in mm (inch)

D-Sub Connectors with Plastic Brackets
and Accessories

Plastic brackets are used to ensure that a conductive electrical connection does not occur between the connector housing and the PCB.

D-Sub Steckverbinder mit Kunststoff-
winkel und Anbauteilen

Kunststoffwinkel werden eingesetzt um zu verhindern, dass eine elektrisch leitende Verbindung zwischen dem Steckverbindergehäuse und der Leiterplatte entsteht.

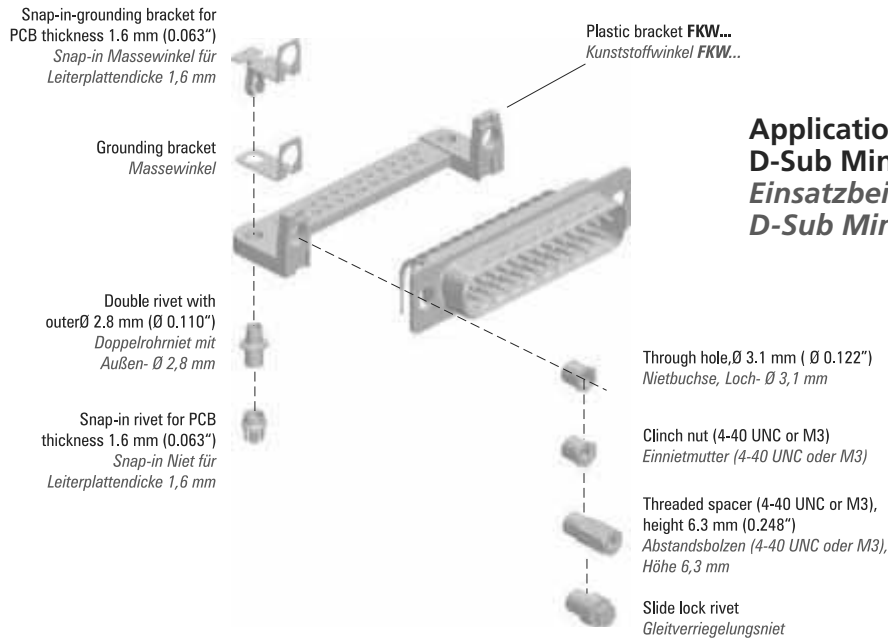

Application Example
D-Sub Miniature
*Einsatzbeispiel
D-Sub Miniatur*

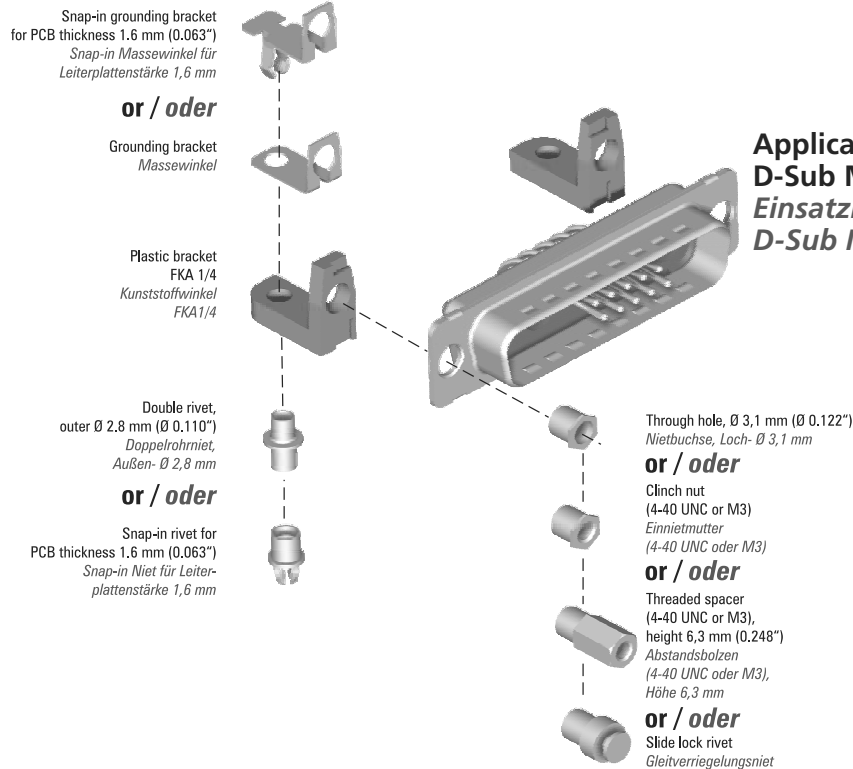

Application Example
D-Sub Mixed Layout
*Einsatzbeispiel
D-Sub Mischpolleiste*



Plastic Brackets FKW...

Kunststoffwinkel FKW...

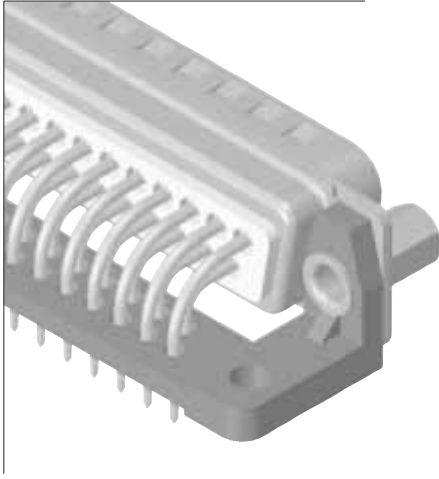

Dimensions
Abmessungen

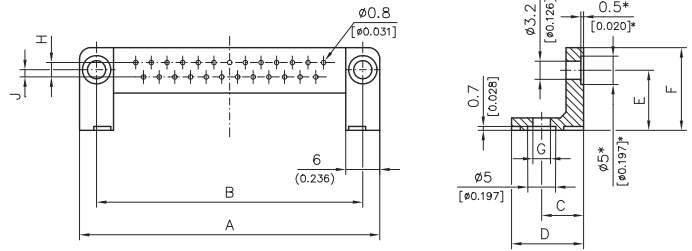

* only for FKW...GS
* nur bei FKW...GS

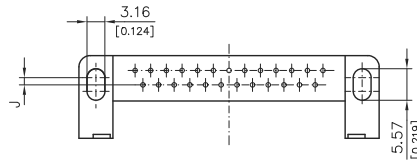

Plastic bracket FKW...GL with oblong hole
Kunststoffwinkel FKW...GL mit Langloch

Order number Bestellnummer	Shell Size Gehäusegröße	Number of Contacts Polzahl	A	B	C	D	E	F	J
			±0,1 (±0.004)	±0,1 (±0.004)	±0,1 (±0.004)	±0,1 (±0.004)	±0,1 (±0.004)	±0,1 (±0.004)	±0,1 (±0.004)
FKW1...	1	9	30,9 (1.217)	25,0 (0.984)	7,4 (0.291)	12,7 (0.500)	10,7 (0.421)	14,6 (0.575)	1,27 (0.050)
FKW2...	2	15	39,2 (1.543)	33,3 (1.311)	7,4 (0.291)	12,7 (0.500)	10,7 (0.421)	14,6 (0.575)	1,27 (0.050)
FKW3...	3	25	53,0 (2.087)	47,04 (1.852)	7,4 (0.291)	12,7 (0.500)	10,7 (0.421)	14,6 (0.575)	1,27 (0.050)
FKW4...	4	37	69,5 (2.736)	63,5 (2.500)	7,4 (0.291)	12,7 (0.500)	10,7 (0.421)	14,6 (0.575)	1,27 (0.050)
FKW5...	5	50	67,1 (2.642)	61,1 (2.406)	8,8 (0.346)	14,0 (0.551)	11,9 (0.469)	17,2 (0.677)	2,54 (0.100)

Dimensions in mm (inch) - Abmessungen in mm (inch)

Order Number Bestellnummer	Shell Size Gehäusegröße	G	H
		± 0,1 (±0.004)	± 0,1 (±0.004)
FKW...	1 - 5	3,1 (0.122)	2,54 (0.100)
FKW...GS	1 - 5	4,3 (0.169)	2,54 (0.100)
FKW...GB	1 - 5	4,3 (0.169)	2,84 (0.112)
FKW...GL	1 - 5	4,3 (0.169)	2,54 (0.100)

Dimensions in mm (inch) - Abmessungen in mm (inch)

Accessories Miniature Connector Zubehör Miniatur Steckverbinder

Material

Material

Plastic brackets are individually available (specified as FKW...) as well as available mounted on D-Sub connectors (modification numbers from page 426f.).

Die Kunststoffwinkel sind sowohl einzeln als FKW..., als auch am D-Sub Steckverbinder montiert erhältlich (Modifikationsnummern siehe ab Seite 426f.).

Technical Data

Technische Daten

Material Polycarbonate according to UL94V-1

Material Polycarbonat entsprechend UL94V-1

Colour Black

Farbe Schwarz

Assemblies Plastic Brackets Anbauteile Kunststoffwinkel

Modifications

Modifikationen

Order Number	Modifications
--------------	---------------

Bestellnummer	Modifikationen
---------------	----------------

	Hole Ø 4.3 mm (Ø 0.169") connector side, countersink PCB side
--	---

FKW...GS	Loch-Ø 4,3 mm steckverbinderseitig, Senkung platinenseitig
----------	--

	Hole Ø 4.3 mm (Ø 0.169") connector side, row spacing 2.84 mm (0.112")
--	---

FKW...GB	Loch-Ø 4,3 mm steckverbinderseitig, Reihenabstand 2,84 mm
----------	---

	Hole Ø 4.3 mm (Ø 0.169") connector side, oblong hole PCB side
--	---

FKW...GL	Loch-Ø 4,3 mm steckverbinderseitig, Langloch platinenseitig
----------	---



<p>Modification numbers for D-Sub connectors with plastic bracket FKW... and accessories</p> <p>Modifikationsnummern für D-Sub Steckverbinder mit Kunststoffwinkel FKW... und Anbauteilen</p> <p>FKW FKW</p>	<p>FKW FKW</p>	<p>FKW with grounding bracket FKW mit Massewinkel</p>	<p>for PCB 1.6 [0.063] thick, recommended hole $\varnothing 3.0 -0.2$ [$\varnothing 0.118 -0.08$] für PCB 1.6 [0.063] dick, empfohlener Bohrungs-$\varnothing 3.0 -0.2$ [$\varnothing 0.118 -0.08$]</p> <p>FKW with snap-in grounding bracket FKW mit Snap-in Massewinkel</p>	<p>bushing Nierbüchse even planen</p> <p>$\varnothing 3.1$ [0.122]</p>				<p>clinch nut 4-40 UNC Einriemutter 4-40 even planen</p>				<p>clinch nut M3 Einriemutter M3 even planen</p>				<p>threaded spacer 4-40 UNC Abstandsbolzen 4-40 UNC</p>				<p>threaded spacer M3 Abstandsbolzen M3</p>				<p>slide lock rivet F-SGV Gleitverriegelungsrivet F-SGV</p>			
--	--------------------	---	---	---	--	--	--	--	--	--	--	--	--	--	--	---	--	--	--	---	--	--	--	---	--	--	--

Dimensions apply only to connectors with 9 to 37 contacts, 50 contacts are available on request /
Maße gelten nur für 9 - 37-polige Steckverbinder, 50-polig auf Anfrage

<p>0993</p> 	<p>0999</p> 	<p>Dimensions apply only to connectors with 9 to 37 contacts, 50 contacts are available on request / Maße gelten nur für 9 - 37-polige Steckverbinder, 50-polig auf Anfrage</p>
<p>0992</p> 	<p>0998</p> 	
<p>0991</p> 	<p>0997</p> 	
<p>0990</p> 	<p>0996</p> 	
<p>0989</p> 	<p>0995</p> 	
<p>0988</p> 	<p>0994</p> 	
<p>for PCB 1.6 [0.063] thick, recommended hole $\varnothing 3.0 - 0.2$ [$\varnothing 0.118 - 0.08$] für PCB 1.6 [0.063] dick, empfohlener Bohrungs- $\varnothing 3.0 - 0.2$ [$\varnothing 0.118 - 0.08$]</p>  <p>FKW with snap-in rivet FKW mit Snap-in Niet</p>	<p>for PCB 1.6 [0.063] thick, recommended hole $\varnothing 3.0 - 0.2$ [$\varnothing 0.118 - 0.08$] für PCB 1.6 [0.063] dick, empfohlener Bohrungs- $\varnothing 3.0 - 0.2$ [$\varnothing 0.118 - 0.08$]</p>  <p>FKW with grounding bracket and snap-in rivet, FKW mit Messerwinkel und Snap-in Niet</p>	



Plastic Mounting Brackets F-BFK-...

Kunststoffbefestigungswinkel F-BFK-...

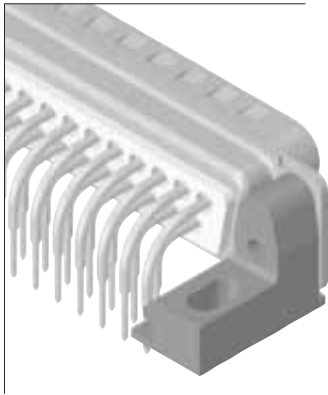

Dimensions
Abmessungen

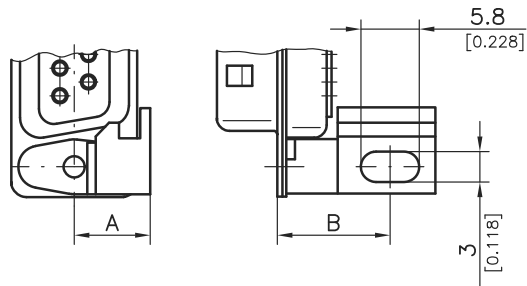

Order Number <i>Bestellnummer</i>	Shell Size <i>Gehäusegröße</i>	A	B	Brackets Only Available in Pairs <i>Winkel nur paarweise lieferbar</i>
F-BFK-1/4	1 - 4	7,55 (0.297)	11,2 (0.441)	Bulk packed without mounting screws <i>ohne Befestigungsschrauben als Schüttware</i>
F-BFK-1/4S	1 - 4	7,55 (0.297)	11,2 (0.441)	With mounting screws, packed in pairs <i>mit Befestigungsschrauben paarweise verpackt</i>
F-BFK-5	5	8,90 (0.350)	12,1 (0.476)	Bulk packed without mounting screws <i>ohne Befestigungsschrauben als Schüttware</i>
F-BFK-5S	5	8,90 (0.350)	12,1 (0.476)	With mounting screws, packed in pairs <i>mit Befestigungsschrauben paarweise verpackt</i>

Dimensions in mm (inch) - Abmessungen in mm (inch)

Order Example

Bulk packed mounting screws for F-BFK-1/4 and F-BFK-5: **FSGK1/5K**

Bestellbeispiel

Befestigungsschraube für F-BFK-1/4 und F-BFK-5 als Schüttware: **FSGK1/5K**

Plastic Brackets F-BFK-...
and FKA... in Comparison

Kunststoffwinkel F-BFK-...
und FKA... im Vergleich

	FKA...	F-BFK...
Oblong hole <i>Langloch</i>	•	—
Connection to connector shell <i>Verbindung zum Steckverbindergehäuse</i>	All add-on parts may be used (see page 423) <i>Alle Anbauteile möglich (siehe Seite 423)</i>	Screwed <i>verschraubt</i>
For use with mixed layout connectors instead of FKW... <i>Einsatz bei Mixed Layout Polbildern statt FKW...</i>	•	•



Assembly of a D-Sub Connectors with
Metal Brackets F1080-... and Accessories

Aufbau eines D-Sub Steckverbinder mit
Metallwinkel F1080-... und Anbauteilen

Application Example
D-Sub Miniature
Einsatzbeispiel
D-Sub Miniatur

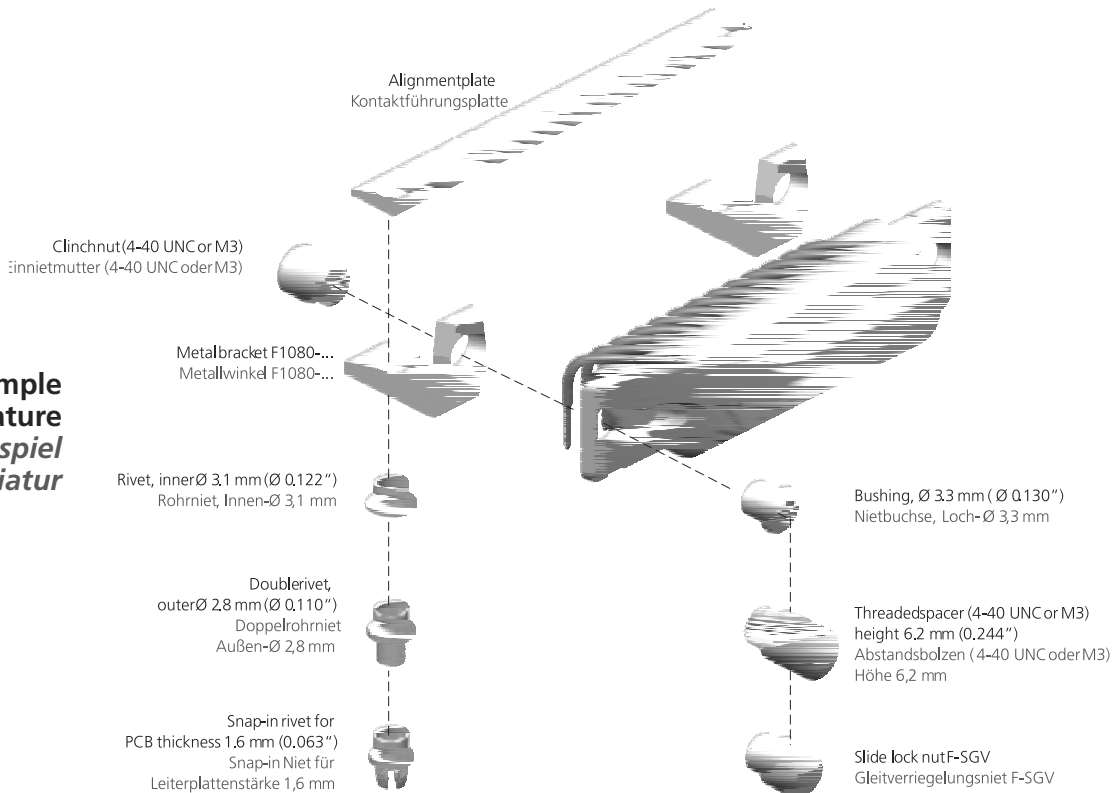

Accessories Miniature Connector Zubehör Miniatur Steckverbinder

Assemblies Metal Brackets Anbauteile Metallwinkel

Threaded Metal Mounting Brackets F1080-...

Material: Steel, zinc-plated, yellow chromate.
For tinned version add suffix SN to the order number.

Dimensions Abmessungen

Metal Brackets for Mounting with Alignment Plate Metallwinkel montierbar mit Kontaktführungsplatte

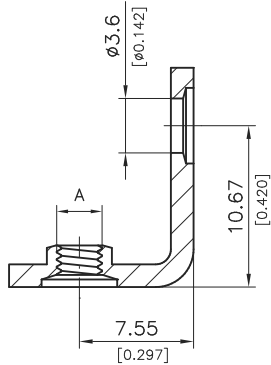

Order Number	A	
Bestellnummer		
F1080-1	Thread M3	Gewinde M3
F1080-2	Thread 4-40 UNC	Gewinde 4-40 UNC
F1080-7	Through hole \varnothing 3.1 mm (\varnothing 0.122")	Durchgangsloch \varnothing 3,1 mm

Verschraubbare Metallwinkel F1080-...

Material: Stahl, verzinkt, gelb chromatiert. Für verzinnzte Ausführung SN an die Bestellnummer anfügen.

Metal Brackets, Through Hole, \varnothing 3.1 mm (\varnothing 0.122") Metallwinkel, Durchgangsloch \varnothing 3,1 mm

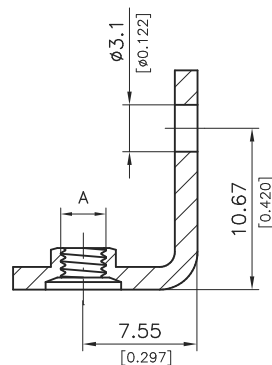

Order Number	A	
Bestellnummer		
F1080-3	Thread M3	Gewinde M3
F1080-4	Thread 4-40 UNC	Gewinde 4-40 UNC
F1080-8	Through hole \varnothing 3.1 mm (\varnothing 0.122")	Durchgangsloch \varnothing 3,1 mm

Mounting Example for Metal Brackets F1080-... Montagebeispiel für Metallwinkel F1080-...

Slotted Screw FSGK1/5... Schlitzschraube FSGK1/5...

Material: Steel, zinc plated, chromate
Material: Stahl, verzinkt, chromatiert

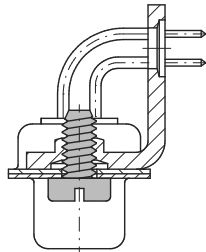

Thread	Order Number
Gewinde	Bestellnummer
4-40 UNC	FSGK1/5
M3	FSGK1/5M3

Lock Posts F-SGSV-1/5... for Slide Locks F-GV-... Gegenschraube F-SGV-1/5... für Gleitverriegelung F-GV-...

Order number: F-SGV-1/5...
Bestellnummer: F-SGV-1/5...

Also see page 410
Siehe auch Seite 410

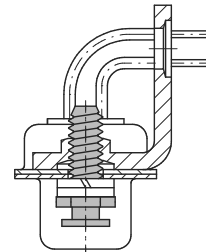

Mounting Example for Metal Brackets F1080-... Montagebeispiel für Metallwinkel F1080-...

Female Screw Lock F-GSCH1/5... Sechskantbolzen F-GSCH1/5...

Order number: F-GSCH-1/5...
Bestellnummer: F-GSCH-1/5...

See page 419 onwards
Siehe Seite 419



Summary of Riveted Metal
Brackets F1080-...

Übersicht angenietete
Metallwinkel F1080-...

Metal Brackets F1080-... for Shell Sizes 1 - 4
(Continuation)

Metallwinkel F1080-... für Gehäusegrößen 1 - 4
(Fortsetzung)

Metal Bracket F1080-17

Metallwinkel F1080-17

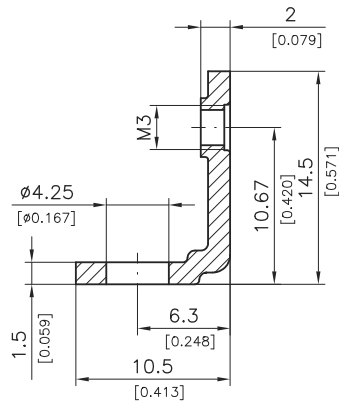

Metal Bracket F1080-29

Metallwinkel F1080-29

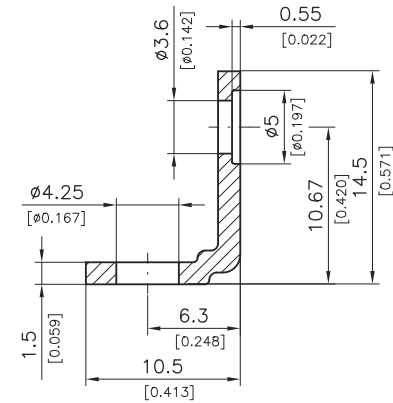

Metal Bracket F1080-19

Metallwinkel F1080-19

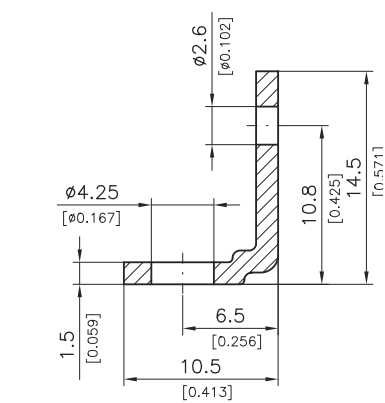

Metal Bracket F1080-24

Metallwinkel F1080-24

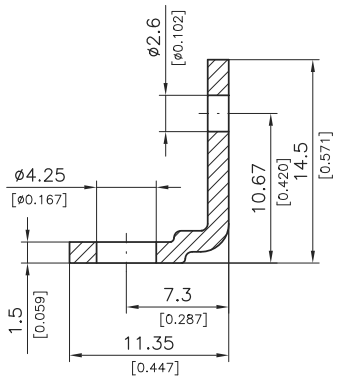

Metal Bracket F1080-13B

Metallwinkel F1080-13B

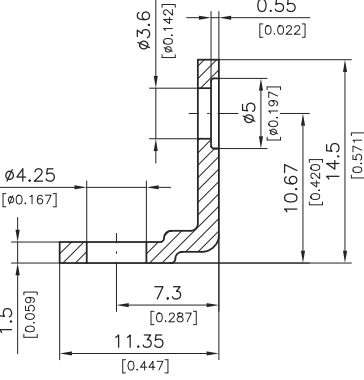

Metal Bracket F1080-26

Metallwinkel F1080-26

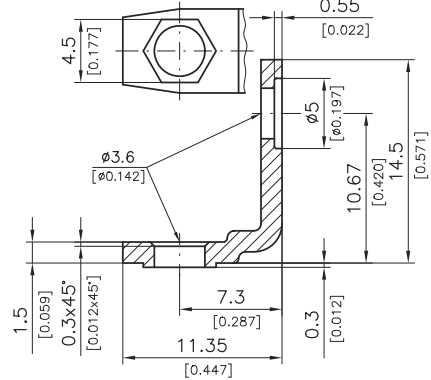

Metal Bracket F1080-14

Metallwinkel F1080-14

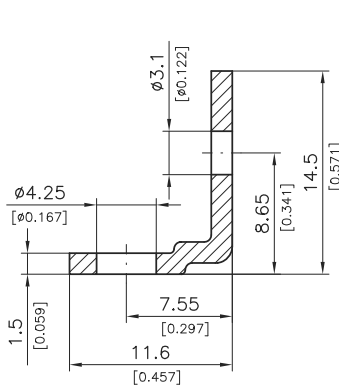

Metal Bracket F1080-61

Metallwinkel F1080-61

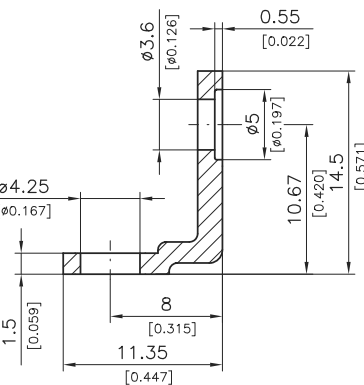

Summary of Riveted Metal Brackets F1080-...

Übersicht angenietete Metallwinkel F1080-...

Metal Brackets F1080-... for Shell Size 5

Metallwinkel F1080-... für Gehäusegröße 5

Metal Bracket F1080-22

Metallwinkel F1080-22



Metal Bracket F1080-18

Metallwinkel F1080-18



Metal Bracket F1080-23

Metallwinkel F1080-23

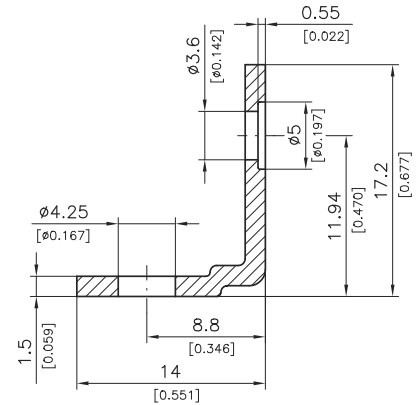

Compatibility Table of Metal Brackets F1080-...

Kompatibilitätstabelle für Metallwinkel F1080-...



The accessories listed in the summary of accessories on page 435/436 cannot be used for all metal brackets. The following table provides a guide to the combinations available.

Die Anbauteile in der Übersicht Seite 435/436 sind nicht mit allen Metallwinkeln verwendbar. Die folgende Tabelle gibt einen Überblick, welche Kombinationen möglich sind.

• = Possible

• = Möglich

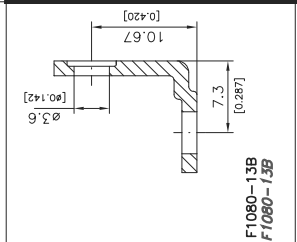
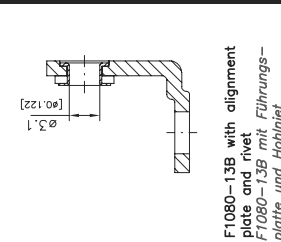
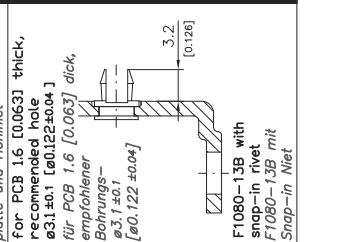
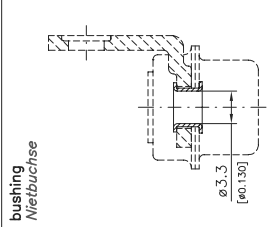
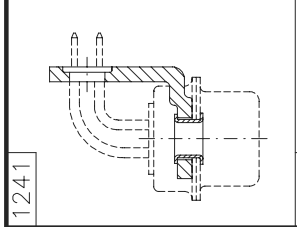
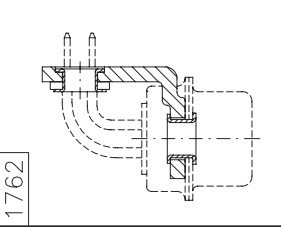
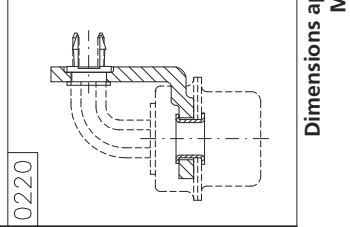
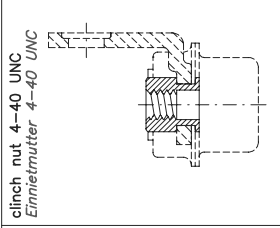
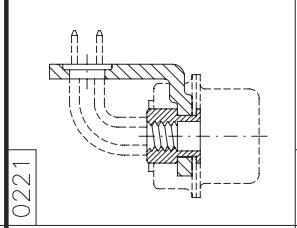
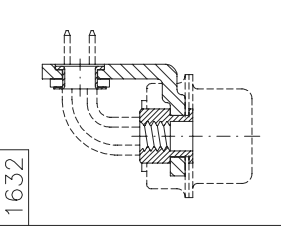
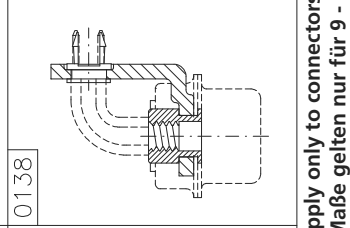
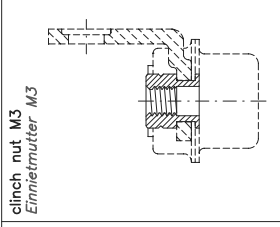
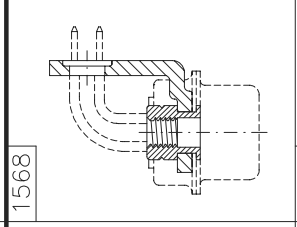
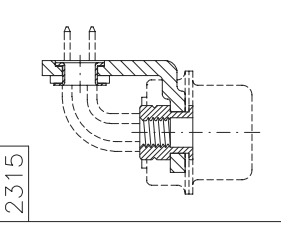
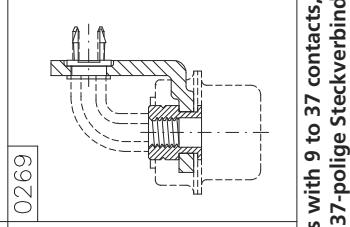
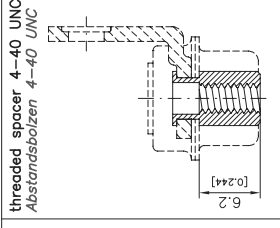
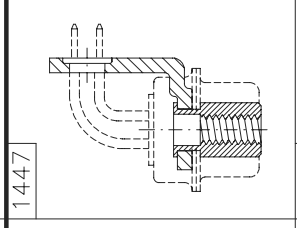
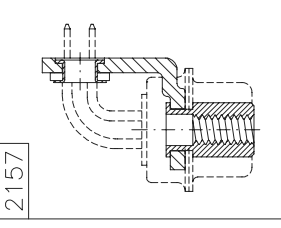
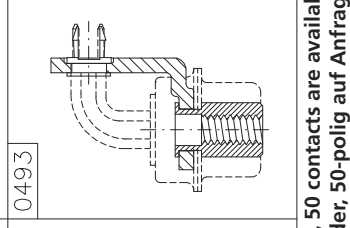
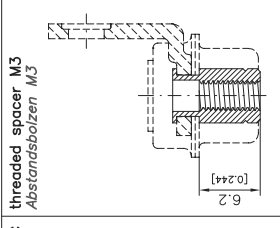
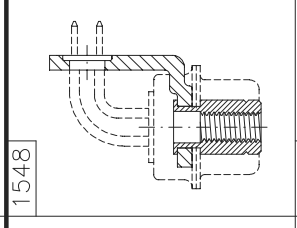
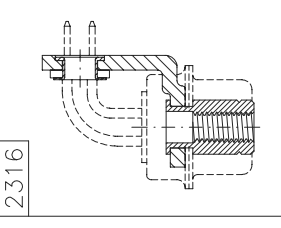
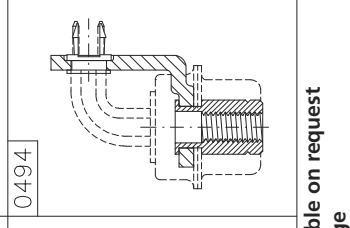
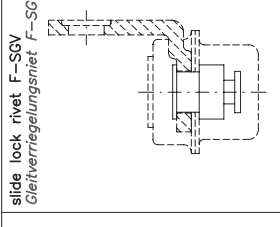
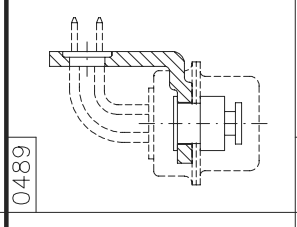
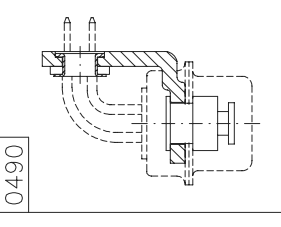
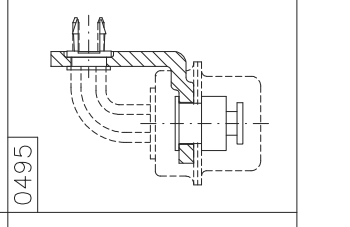
Suitable for Shell Size	Connector Side Steckverbinderseitig					PCB Side Platinenseitig			
	Metal Bracket F1080-...	Bushing	Clinch Nut	Spacer	Fixing Plate and Rivet	Double Rivet	Fixing Plate and Double Rivet	Snap-in-rivet	Fixing Plate and Snap-in rivet
Passend für Gehäusegröße F1080-...	Metallwinkel	Nietbuchse	Einnietmutter	Abstandsbolzen	Führungsplatte und Hohlriet	Doppelrohrniet	Führungsplatte und Doppelrohrniet	Snap-In-Niet	Führungsplatte und Snap-In-Niet
1 - 4	1				•	•	•	•	•
1 - 4	2				•	•	•	•	•
1 - 4	3								
1 - 4	4								
1 - 4	13B	•	•	•	•	•	•	•	•
1 - 4	14	•	•	•					
1 - 4	15	•	•	•					
1 - 4	16	•	•	•					
1 - 4	17	•	•	•					
5	18	•	•	•	•	•	•	•	•
1 - 4	19	•	•	•					
5	22	•	•	•					
5	23	•	•	•	•	•	•	•	•
1 - 4	24	•	•	•					
1 - 4	26				•	•	•	•	•
1 - 4	27	•	•	•	•	•	•	•	•
1 - 4	29	•	•	•	•	•	•	•	•
1 - 4	45	•	•	•	•	•	•	•	•
1 - 5	61	•	•	•	•	•	•	•	•

<p>Modification numbers for D-Sub connectors with metal brackets F1080-13B and accessories</p> <p>Modifikationsnummern für D-Sub Steckverbinder mit Metallwinkel F1080-13B und Anbauteilen</p>	 <p>F1080-13B F1080-13B</p>	 <p>F1080-13B with alignment plate and rivet F1080-13B mit Führungsplatte und Hohlriet</p> <p>For PCB 1.6 [0.0631] thick, recommended hole $\varnothing 3.1 \pm 0.1$ [$\varnothing 0.122 \pm 0.04$] für PCB 1.6 [0.063] dick, empfohlener Bohrungs-$\varnothing 3.1 \pm 0.1$ [$\varnothing 0.122 \pm 0.04$]</p>	 <p>F1080-13B with snap-in rivet F1080-13B mit Snap-in Niet</p>	<p>bushing Nietbuchse</p>  <p>1241</p>	 <p>1762</p>	 <p>0220</p>	 <p>0220</p>	<p>clinch nut 4-40 UNC Einriemutter M3</p>  <p>0221</p>	 <p>1632</p>	 <p>1632</p>	 <p>0138</p>	<p>clinch nut M3 Einriemutter M3</p>  <p>1568</p>	 <p>1568</p>	 <p>2315</p>	 <p>0269</p>	<p>threaded spacer 4-40 UNC Abstandsbolzen 4-40 UNC</p>  <p>1447</p>	 <p>1447</p>	 <p>2157</p>	 <p>0493</p>	<p>threaded spacer M3 Abstandsbolzen M3</p>  <p>1548</p>	 <p>1548</p>	 <p>2316</p>	 <p>0494</p>	<p>slide lock rivet F-SGV Gleitverriegelungsriet F-SGV</p>  <p>0489</p>	 <p>0489</p>	 <p>0490</p>	 <p>0495</p>
<p>Dimensions apply only to connectors with 9 to 37 contacts, 50 contacts are available on request Maße gelten nur für 9 - 37-polige Steckverbinder, 50-polig auf Anfrage</p>																											

<p>for PCB 1.6 [0.063] thick, recommended hole $\varnothing 3.0 \pm 0.1$ [$\varnothing 0.118 \pm 0.04$] für PCB 1.6 [0.063] dick, empfohlener Bohrungs- maß [$\varnothing 0.118 \pm 0.04$]</p>  <p>3.3 [0.130]</p> <p>F1080-13B with snap-in rivet F1080-13B mit Snap-in Niet</p>	<p>1001</p> 	<p>1002</p> 	<p>1003</p> 	<p>1004</p> 	<p>1005</p> 	<p>1006</p> 	<p>for PCB 1.6 [0.063] thick, recommended hole $\varnothing 3.0 \pm 0.1$ [$\varnothing 0.118 \pm 0.04$] für PCB 1.6 [0.063] dick, empfohlener Bohrungs- maß [$\varnothing 0.118 \pm 0.04$]</p>  <p>3.3 [0.130]</p> <p>F1080-13B with alignment plate and snap-in rivet F1080-13B mit Führungs- platte und Snap-in Niet</p>	<p>1007</p> 	<p>1008</p> 	<p>1009</p> 	<p>1010</p> 	<p>1011</p> 	<p>1012</p> 
<p>Modification numbers for connectors with other metal brackets and accessories, e. g. self locking clinch nuts, available on request. Modifikations-Nr. für Steckverbinder mit anderen Metallwinkeln und Anbauteilen, z. B. selbstsichernden Einriemuttern, auf Anfrage.</p>													
<p>Dimensions apply only to connectors with 9 to 37 contacts, 50 contacts are available on request Maße gelten nur für 9 - 37-polige Steckverbinder, 50-polig auf Anfrage</p>													

Plastic Dust Caps/
Plastic Protection Caps F1042-...

Kunststoff-Staubkappen/
-Abschirmkappen F1042-...



Dimensions
Abmessungen

Plastic Dust Cap
Kunststoff-Staubkappe



Advantages and special Features

The antistatic plastic dust cap F1042-...AH can be used with connectors which are mounted in a hood. Recesses have been formed in the plastic cap to match the geometry of the hoods. The standard plastic dust cap is suitable for mounting on hoods with socket connectors. The Plastic Dust Caps are equipped with Clip and Chain for Mounting on Hoods with Pin Connector.

Vorteile und Merkmale im Überblick

Die antistatische Kunststoff-Staubkappe F1042-...AH kann auf Steckverbindergehäuse, die in einer Haube montiert sind, aufgesetzt werden. Es sind Aussparungen in der Kunststoffkappe entsprechend der Haubengeometrie eingebaut. Für die Montage an Hauben mit Buchsensteckverbindern ist die Standard Kunststoff-Staubkappe verwendbar. Die Kunststoff-Staubkappen sind mit Lasche und Kette für die Montage an Hauben mit Stiftsteckverbinder ausgestattet.

Plastic Dust Cap with Clip and Chain
Kunststoff-Staubkappe mit Lasche und Kette

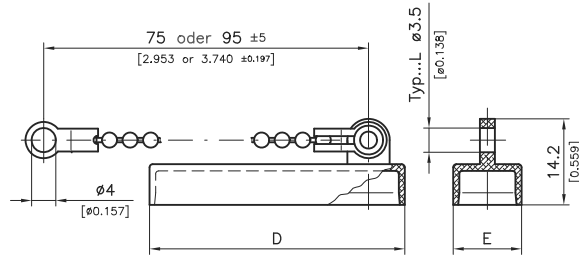

Order number chain length 95 mm (3.740"): **F1042-...K1...**
Bestellnummer Kettenlänge 95 mm: **F1042-...K1...**

Shell Size Gehäusegr.	Order-No. Bestellnr.	For Pin Connectors Für Stiftsteckverbinder			For Socket Connectors Für Buchsensteckverbinder		
		A	B	C	A	B	C
1	F1042-1...	±0,3 (±0.012)	±0,3 (±0.012)	±0,2 (±0.008)	±0,3 (±0.012)	±0,3 (±0.012)	±0,2 (±0.008)
2	F1042-2...	21,8 (0.858)	13,2 (0.520)	7,4 (0.291)	20,0 (0.787)	11,8 (0.465)	7,6 (0.299)
3	F1042-3...	30,0 (1.181)	13,2 (0.520)	7,4 (0.291)	28,5 (1.122)	11,8 (0.465)	7,6 (0.299)
4	F1042-4...	44,2 (1.740)	13,2 (0.520)	7,4 (0.291)	42,3 (1.665)	11,8 (0.465)	7,6 (0.299)
5	F1042-5...	59,8 (2.354)	13,2 (0.520)	7,4 (0.291)	58,8 (2.315)	11,8 (0.465)	7,6 (0.299)

Dimensions in mm (inch) - Abmessungen in mm (inch)

D	E	For Pin Connectors Für Stiftsteckverbinder		For Socket Connectors Für Buchsensteckverbinder		Order-No. Bestellnr.	Shell Size Gehäusegr.
		D	E	D	E		
±0,3 (±0.012)	±0,2 (±0.008)	±0,3 (±0.012)	±0,2 (±0.008)	±0,3 (±0.012)	±0,2 (±0.008)	F1042-1...K...	1
19,6 (0.772)	11,1 (0.437)	17,8 (0.701)	9,6 (0.378)	27,8 (1.094)	11,1 (0.437)	F1042-2...K...	2
27,8 (1.094)	11,1 (0.437)	26,2 (1.031)	9,6 (0.378)	41,8 (1.646)	11,1 (0.437)	F1042-3...K...	3
41,8 (1.646)	11,1 (0.437)	39,9 (1.571)	9,6 (0.378)	57,4 (2.260)	11,1 (0.437)	F1042-4...K...	4
57,4 (2.260)	11,1 (0.437)	56,2 (2.213)	9,6 (0.378)	55,3 (2.177)	13,8 (0.543)	F1042-5...K...	5

Dimensions in mm (inch) - Abmessungen in mm (inch)



Plastic Dust Cap with Clip and Chain for Mounting on Hoods with Pin Connector

Kunststoff-Staubkappe mit Lasche und Kette für Montage an Hauben mit Stiftsteckverbinder

Dimensions
Abmessungen



Order number chain length 95 mm (3.740"): **F1042-...K1...**

Bestellnummer Kettenlänge 95 mm: **F1042-...K1...**

For Pin Connectors
Für Stiftsteckverbinder

Order Number Bestellnummer	Shell Size Gehäusegröße	A ±0,3 (±0.012)	B ±0,3 (±0.012)	C ±0,2 (±0.008)	F ±0,2 (±0.008)
F1042-1PLAH	1	21,8 (0.858)	13,2 (0.520)	7,4 (0.291)	16,0 (0.630)
F1042-1PK...AH*					
F1042-2PLAH	2	30,0 (1.181)	13,2 (0.520)	7,4 (0.291)	16,0 (0.630)
F1042-2PK...AH*					
F1042-3PLAH	3	44,2 (1.740)	13,2 (0.520)	7,4 (0.291)	31,0 (1.220)
F1042-3PK...AH*					
F1042-4P...AH*	4	59,8 (2.354)	13,2 (0.520)	7,4 (0.291)	46,0 (1.811)
F1042-5P...AH*	5	57,8 (2.276)	15,9 (0.626)	7,4 (0.291)	44,0 (1.732)

* On request / auf Anfrage



Order Code

Bestellschlüssel

F1042 | 5 | S | K | A

Series Prefix

Serienbezeichnung

Series (Insulator)

Baureihe (Isolierkörper)

No. of Contacts/Polzahl	09	15	25	37	50
Shell Size/Gehäusegröße	1	2	3	4	5

For Connector Type

Für Steckverbinderart

- P** Pin contact/*Stiftkontakt*
- S** Socket contact/*Buchsenkontakt*

- Without Chain, without Clip
Ohne Kette, ohne Lasche
- L** Without Chain, with Clip with hole
Ohne Kette, mit Lasche mit Loch
- LR** Without Chain, with Clip without hole
Ohne Kette, mit Lasche ohne Loch
- K** With Chain 75mm (2.95") length and Clip
Mit Kette 75mm Länge und Lasche
- K1** With Chain 95mm (3.74") length and Clip
Mit Kette 95mm Länge und Lasche
- K2** With Chain 120mm (4.72") length and Clip
Mit Kette 120mm Länge und Lasche
- K3** With Chain 37mm (1.46") length and Clip
Mit Kette 37mm Länge und Lasche
- K4** With Chain 25mm (0.98") length and Clip
Mit Kette 25mm Länge und Lasche

Modifications

Modifikationen

- Standard Version/*Standard Ausführung*
- A** Antistatic Version/*Antistatische Ausführung*
- B** Flame retardant according to UL94V-0/*Selbstverlöschend nach UL94V-0*
- M** Plastic Protection Caps, metallized version, flame retardant according to UL94V-0, shielding against electromagnetic radiation, protection against electrostatic discharge.
Abschirmkappe, metallisierte Ausführung, selbstverlöschend nach UL94V-0, Abschirmung elektromagnetischer Einstrahlung, Schutz vor elektrostatischer Entladung.
- AH** Antistatic Version for Hood Mounting/*Antistatische Ausführung für Haubenmontage*

Protection Level/Schutzgrad

All variations of dust cap meet protection level IP 50 requirements, DIN 40050.

Die Staubkappen entsprechen in allen Ausführungen dem Schutzgrad IP50, DIN 40050.



**An Example of Use for Plastic
 Dust Cap F1042-...AH**

**Einsatzbeispiel für Kunststoff-
 Staubkappe F1042-...AH**

Material

Material

Chain

Kette

Material

Material

Brass, nickel plated

Messing, vernickelt



Dust Cap

Staubkappe

Material

Material

Polyethylene

Polyethylen

Polypropylene (antistatic)

Polypropylen (antistatisch)

ABS, self-extinguishing (UL94V-0)

ABS, selbstverlöschend (UL94V-0)

ABS, self-extinguishing (UL94V-0), metallized, nickel plating over Cu

ABS, selbstverlöschend (UL94V-0), metallisiert: Ni über Cu

Colour

Farbe

Red

Rot

Black

Schwarz

Grey

Grau

Nickel

Nickel

Ordering Example

Bestellbeispiel

F1042-3P

F1042-3PA

F1042-3PB

F1042-3PM

Shielded Dust Cap FSSK,
Screwable

*Geschirmte Staubkappe FSSK,
verschraubbar*



Shielding dust cap FSSK2P
Geschirmte Staubkappe FSSK2P



Rear view shielding dust cap FSSK2P-1426, with front seal.
Rückansicht geschirmte Staubkappe FSSK2P-1426, mit Frontdichtung

Features of Shielding Dust Cap FSSK

- Solid metal
- Simple mounting - push on and screw in place
- Contacts are protected from dust
- Version K1426 meet protection level IP 67 requirements, DIN 40050
- Captive screws

Eigenschaften der geschirmten Staubkappe FSSK

- Vollmetall
- einfachste Montage durch Aufstecken und Verschrauben
- Kontakte werden vor Staub geschützt
- Version K 1426 entspricht dem Schutzgrad IP 67, DIN 40050
- Schrauben unverlierbar



Dimension of Dust Cap for the Sealing
of Pin Connectors

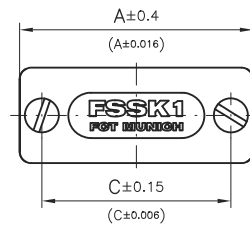
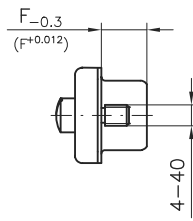
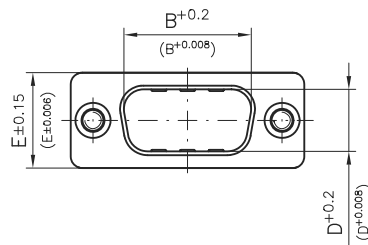

Order No.	Shell Size	A	B	C	D	E	F
Bestellnr.	Gehäusegr.	$\pm 0,4$	$+0,2$	$\pm 0,15$	$+0,2$	$\pm 0,15$	$-0,3$
		(± 0.016)	(± 0.008)	(± 0.006)	(± 0.008)	(± 0.006)	(± 0.012)
FSSK1P	1	30,8 (1.213)	16,9 (0.665)	25,0 (0.984)	8,2 (0.323)	12,5 (0.492)	6,1 (0.240)
FSSK2P	2	39,1 (1.539)	25,2 (0.992)	33,3 (1.311)	8,2 (0.323)	12,5 (0.492)	6,1 (0.240)
FSSK3P	3	53,0 (2.087)	38,9 (1.531)	47,0 (1.852)	8,2 (0.323)	12,5 (0.492)	6,0 (0.236)
FSSK4P*	4	69,3 (2.728)	55,3 (2.177)	63,5 (2.500)	8,2 (0.323)	12,5 (0.492)	6,0 (0.236)
FSSK5P*	5	66,9 (2.634)	52,8 (2.079)	61,1 (2.406)	11,0 (0.433)	15,4 (0.606)	6,0 (0.236)

*On request / auf Anfrage

Dimensions in mm (inch) - Abmessungen in mm (inch)

Dimension of Dust Cap for the Sealing
of Socket Connectors

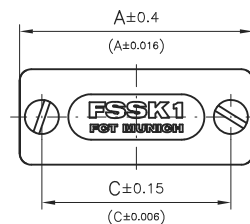
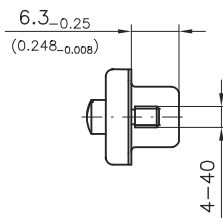
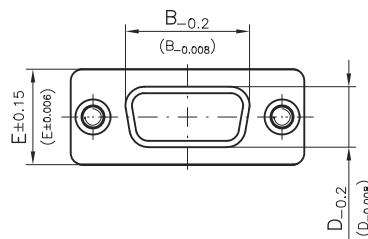

Order-No	Shell Size	A	B	C	D	E
Bestellnr.	Gehäusegr.	$\pm 0,4$	$-0,2$	$\pm 0,15$	$-0,2$	$\pm 0,15$
		(± 0.016)	(± 0.008)	(± 0.006)	(± 0.008)	(± 0.006)
FSSK1S	1	30,8 (1.213)	16,4 (0.646)	25,0 (0.984)	8,0 (0.315)	12,5 (0.492)
FSSK2S	2	39,1 (1.539)	24,7 (0.972)	33,3 (1.311)	8,0 (0.315)	12,5 (0.492)
FSSK3S	3	53,0 (2.087)	38,5 (1.516)	47,0 (1.852)	8,0 (0.315)	12,5 (0.492)
FSSK4S	4	69,3 (2.728)	54,9 (2.161)	63,5 (2.500)	8,0 (0.315)	12,5 (0.492)
FSSK5S	5	66,9 (2.634)	52,5 (2.067)	61,1 (2.406)	10,8 (0.425)	15,4 (0.606)

* On request / auf Anfrage

Dimensions in mm (inch) - Abmessungen in mm (inch)



Order Code
Bestellschlüssel

					FSSK	2	P	M3	1426
Series Prefix <i>Serienbezeichnung</i>									
D-Sub Shell Size <i>D-Sub Gehäusegröße</i>					1	2	3	4	5
Contact Type <i>Kontaktart</i>									
P	Pin contact <i>Stiftkontakt</i>								
S	Socket contact <i>Buchsenkontakt</i>								
Screw Thread <i>Schraubengewinde</i>									
--	Standard 4-40 / <i>Standardausführung 4-40</i>								
M3	M3 / <i>M3</i>								
Modifications <i>Modifikationen</i>									

K1462 With Front Seal Waterproof
(for Contact Type P pre-mounted, for Contact Type S in a separate Package)
Mit Frontdichtung, wasserdicht.
(bei Kontaktart P vormontiert, bei Kontaktart S im Beipack)

Size 1-3 are available, other sizes on request.
Gehäusegrößen 1-3 verfügbar, andere Größen auf Anfrage.



Accessories Miniature Connector Zubehör Miniatur Steckverbinder

Shielded Dust Caps Geschirmte Staubkappen

Material and Plating

Material und Oberfläche

Shell	Brass, tin plated / Messing, verzinkt
Gehäuse	K1426 brass, tin plated / K1426 Messing, verzinkt
Shielding flange / Schirmflansch	Zinc die-cast, nickel plated / Zink-Druckguss, vernickelt
Screws / Schrauben	Brass, tin plated / Messing, verzinkt
Front Seal (only for K1426) / Frontdichtung (nur bei K1426)	Silicone / Silikon
Maximum torque / maximales Anzugsmoment	40Ncm (0.295ft.lb)

Mounting Instructions

Montagehinweise

Front Seal (F1043-1-5) is mounted in male connector
Frontdichtung (F1043-1-5) wird im Stiftstecker montiert

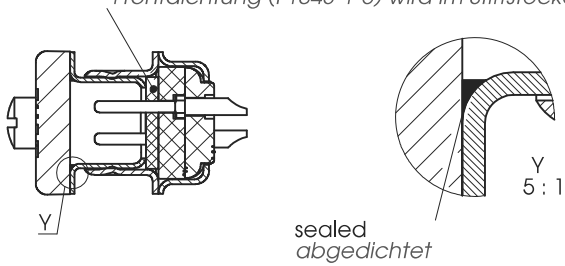

Front Seal glued to shielding dust cap
Frontdichtung mit geschirmter Staubkappe verklebt

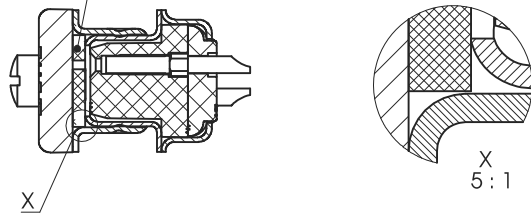

Application Example Cable to Cable Connections Einsatzbeispiel fliegende Verbindung



Application Example of a Housing Seal Einsatzbeispiel Gehäuseabdichtung



Данный компонент на территории Российской Федерации

Вы можете приобрести в компании MosChip.

Для оперативного оформления запроса Вам необходимо перейти по данной ссылке:

<http://moschip.ru/get-element>

Вы можете разместить у нас заказ для любого Вашего проекта, будь то серийное производство или разработка единичного прибора.

В нашем ассортименте представлены ведущие мировые производители активных и пассивных электронных компонентов.

Нашей специализацией является поставка электронной компонентной базы двойного назначения, продукции таких производителей как XILINX, Intel (ex.ALTERA), Vicor, Microchip, Texas Instruments, Analog Devices, Mini-Circuits, Amphenol, Glenair.

Сотрудничество с глобальными дистрибьюторами электронных компонентов, предоставляет возможность заказывать и получать с международных складов практически любой перечень компонентов в оптимальные для Вас сроки.

На всех этапах разработки и производства наши партнеры могут получить квалифицированную поддержку опытных инженеров.

Система менеджмента качества компании отвечает требованиям в соответствии с ГОСТ Р ИСО 9001, ГОСТ РВ 0015-002 и ЭС РД 009

Офис по работе с юридическими лицами:

105318, г.Москва, ул.Щербаковская д.3, офис 1107, 1118, ДЦ «Щербаковский»

Телефон: +7 495 668-12-70 (многоканальный)

Факс: +7 495 668-12-70 (доб.304)

E-mail: info@moschip.ru

Skype отдела продаж:

moschip.ru

moschip.ru_4

moschip.ru_6

moschip.ru_9