

New

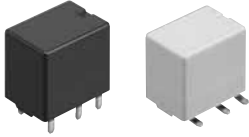

Compliance with RoHS Directive

## FEATURES

1. Best space savings in its class.
2. Compact and high-capacity 30A load switching.
3. Full line up (High heat-resistant type and SMD type)
4. Terminals for PC board pattern designs are easily allocated.

## TYPICAL APPLICATIONS

Defogger, Seat heater, Head lamp, Fog lamp, Fan motor, etc.

## ORDERING INFORMATION

ACNM					
CN-M relay					
Contact arrangement*1					
1: 1 Form C					
3: 1 Form A					
5: 1 Form C high heat-resistant type					
7: 1 Form A high heat-resistant type					
Pick-up voltage					
1: Max. 7.2V DC					
Coil voltage (DC)					
12: 12V					
Terminal shape					
Nil: PC board terminal					
SA: Surface-mount terminal					
Packing style*2					
Nil: Tube packing					
X: Tape and reel packing (Reverse NO terminal direction in pull-out direction)					
Z: Tape and reel packing (Normal NO terminal direction in pull-out direction)					

Notes: \*1. Surface-mount terminal type is available in high heat-resistant type only.

\*2. Tube packing: PC board terminal type only  
Tape and reel packing: Surface-mount type only

## TYPES

### 1. PC board terminal type

Contact arrangement	Nominal coil voltage	Part No.	
		Standard type	High heat-resistant type
1 Form A	12V DC	ACNM3112	ACNM7112
1 Form C		ACNM1112	ACNM5112

Standard packing; Carton (tube): 50 pcs.; Case: 1,500 pcs.

### 2. Surface-mount terminal type

Contact arrangement	Nominal coil voltage	Part No.
		High heat-resistant type
1 Form A	12V DC	ACNM7112SAX
		ACNM7112SAZ
1 Form C		ACNM5112SAX
		ACNM5112SAZ

Standard packing; Carton (tape and reel): 200 pcs.; Case: 600 pcs.

Notes: \*1. Surface-mount terminal type is available in high heat-resistant type only.

\*2. An "X" at the end of the part number indicates, for tape and reel packing, reverse NO terminal direction in pull-out direction.  
A "Z" at the end of the part number indicates, for tape and reel packing, normal NO terminal direction in pull-out direction.

# CN-M (ACNM)

## RATING

### 1. Coil data

Nominal coil voltage	Pick-up voltage (at 20°C 68°F)	Drop-out voltage (at 20°C 68°F)	Nominal operating current [ $\pm 10\%$ ] (at 20°C 68°F)	Coil resistance [ $\pm 10\%$ ] (at 20°C 68°F)	Nominal operating power (at 20°C 68°F)	Usable voltage range
12 V DC	Max. 7.2 V DC (Initial)	Min. 1.0 V DC (Initial)	53.3 mA	225 $\Omega$	640 mW	10 to 16 V DC

### 2. Specifications

Characteristics	Item	Specifications	
Contact	Arrangement	1 Form A, 1 Form C	
	Contact resistance (Initial)	Typical 5m $\Omega$ (By voltage drop 6 V DC 1 A)	
	Contact material	Ag alloy (Cadmium free)	
Rating	Nominal switching capacity (resistive load)	N.O.: 30A 14V DC, N.C.: 15A 14V DC	
	Max. carrying current (at 14V DC)	N.O. 30A/1 h, 40A/2 min. at 20°C 68°F 25A/1 h, 35A/2 min. at 85°C 185°F 20A/1 h, 30A/2 min. at 110°C 230°F (High heat-resistant type)	
		N.C. 25A/1 h, 30A/2 min. at 20°C 68°F 20A/1 h, 25A/2 min. at 85°C 185°F 15A/1 h, 20A/2 min. at 110°C 230°F (High heat-resistant type)	
		Nominal operating power	640 mW
	Min. switching capacity (resistive load)*	1A 12V DC	
Electrical characteristics	Insulation resistance (Initial)	Min. 100 M $\Omega$ (at 500 V DC)	
	Breakdown voltage (Initial)	Between open contacts	500 Vrms for 1 min. (Detection current: 10mA)
		Between contacts and coil	500 Vrms for 1 min. (Detection current: 10mA)
	Operate time (at nominal voltage)	Max. 10ms (at 20°C 68°F, excluding contact bounce time) (Initial)	
Release time (at nominal voltage)	Max. 10ms (at 20°C 68°F, excluding contact bounce time) (Initial) (without diode)		
Mechanical characteristics	Shock resistance	Functional	Min. 100 m/s <sup>2</sup> {10G} (Half-wave pulse of sine wave: 11ms; detection time: 10 $\mu$ s)
		Destructive	Min. 1,000 m/s <sup>2</sup> {100G} (Half-wave pulse of sine wave: 6ms)
	Vibration resistance	Functional	10 Hz to 100 Hz, Min. 44.1m/s <sup>2</sup> {4.5G} (Detection time: 10 $\mu$ s)
		Destructive	10 Hz to 500 Hz, Min. 44.1m/s <sup>2</sup> {4.5G} Time of vibration for each direction; X, Y direction: 2 hours, Z direction: 4 hours
Expected life	Mechanical	Min. 10 <sup>7</sup> (at 120 cpm)	
		<Resistive load> Min. 10 <sup>5</sup> (At nominal switching capacity, operating frequency: 1s ON, 2s OFF)	
		<Motor load> Min. 2 $\times$ 10 <sup>5</sup> : at 80 A (inrush), 16 A (steady), 14 V DC (Operating frequency: 2s ON, 6s OFF)	
		<Lamp load> Min. 10 <sup>5</sup> : at 84 A (inrush), 12 A (steady), 14 V DC (Operating frequency: 1s ON, 14s OFF)	
Conditions	Conditions for operation, transport and storage	Standard type; Ambient temp: -40°C to +85°C -40°F to +185°F, Humidity: 5 to 85% R.H.	
		High heat-resistant type; Ambient temp: -40°C to +110°C -40°F to +230°F, Humidity: 2 to 85% R.H. (Not freezing and condensing at low temperature)	
Unit weight		Approx. 5.5 g .19 oz	

Note: \*This value can change due to the switching frequency, environmental conditions, and desired reliability level, therefore it is recommended to check this with the actual load.

## REFERENCE DATA

### 1-(1). Coil temperature rise

Sample: ACNM1112, 3pcs  
Measured portion: Inside the coil  
Contact carrying current: 10A, 20A, 30A  
Ambient temperature: 26°C 78.8°F

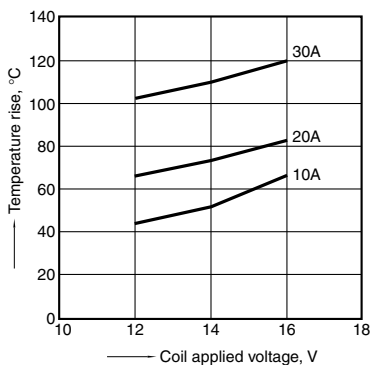

### 1-(2). Coil temperature rise

Sample: ACNM7112, 3pcs  
Measured portion: Inside the coil  
Contact carrying current: 10A, 20A  
Ambient temperature: 110°C 230°F

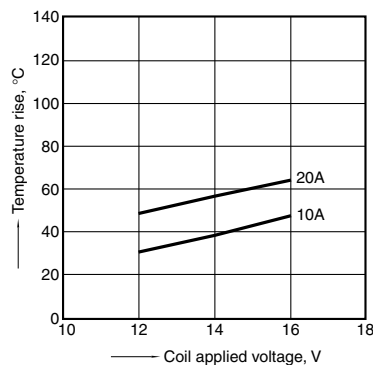

### 2. Ambient temperature and operating voltage range

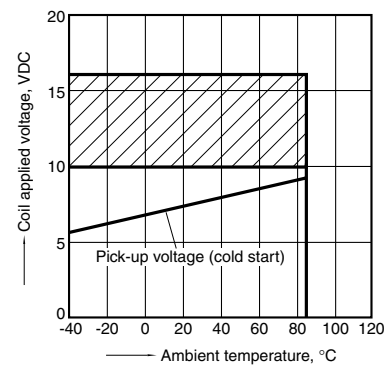

### 3. Distribution of pick-up and drop-out voltage

Sample: ACNM1112, 20pcs.

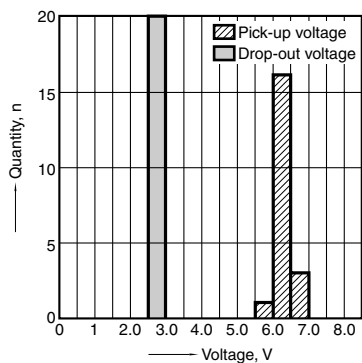

### 4. Distribution of operate and release time

Sample: ACNM1112, 20pcs.

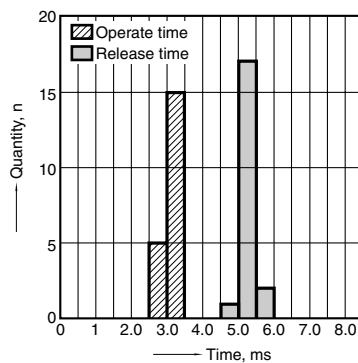

### 5-(1). Electrical life test (Resistive load)

Sample: ACNM1112, 3pcs.

Load: Resistive load (NO side: 30A 14V DC)

Operating frequency: (ON:OFF = 1s:1s)

Ambient temperature: Room temperature

Circuit:

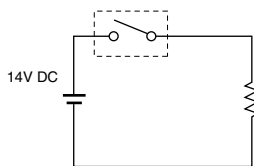

### Change of pick-up and drop-out voltage

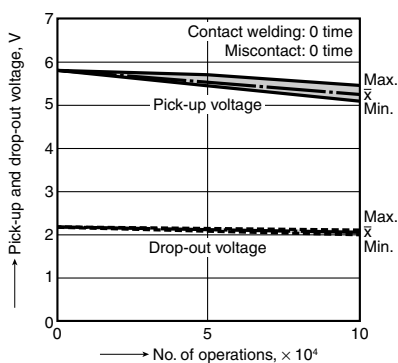

### Change of contact resistance

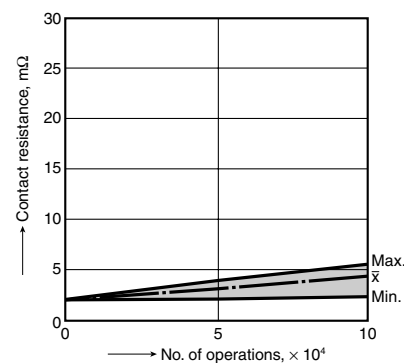

### 5-(2). Electrical life test (Motor load)

Sample: ACNM7112, 3pcs.

Load: inrush: 80A/steady: 16A, radiator fan actual load (motor free)

Switching frequency: (ON:OFF = 2s:6s)

Ambient temperature: 110°C 230°F

Circuit:

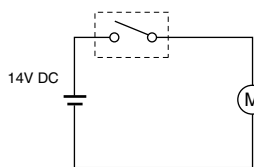

### Change of pick-up and drop-out voltage

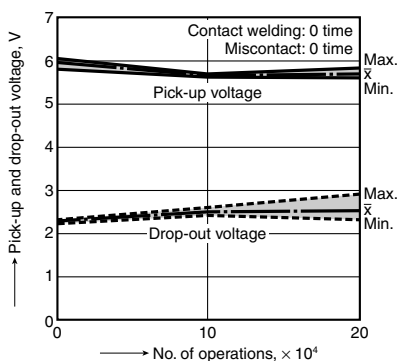

### Change of contact resistance

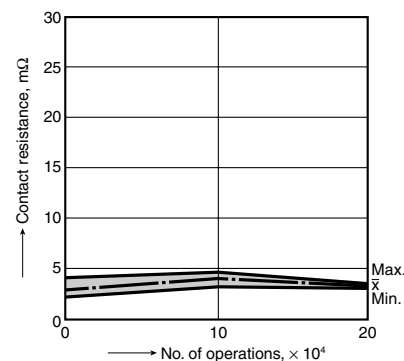

### 5-(3). Electrical life test (Lamp load)

Sample: ACNM3112, 3pcs.

Load: inrush: 84A/steady: 12A

Switching frequency: (ON:OFF = 1s:14s)

Ambient temperature: Room temperature

Circuit:

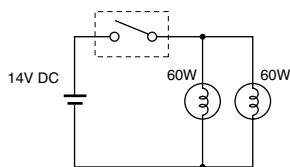

### Change of pick-up and drop-out voltage

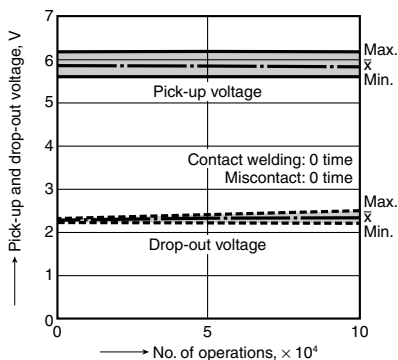

### Change of contact resistance

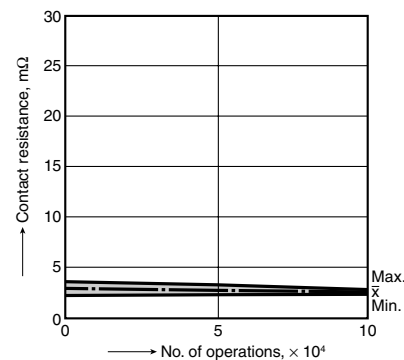

# CN-M (ACNM)

## DIMENSIONS (Unit: mm inch)

### 1. PC board terminal type



External dimensions

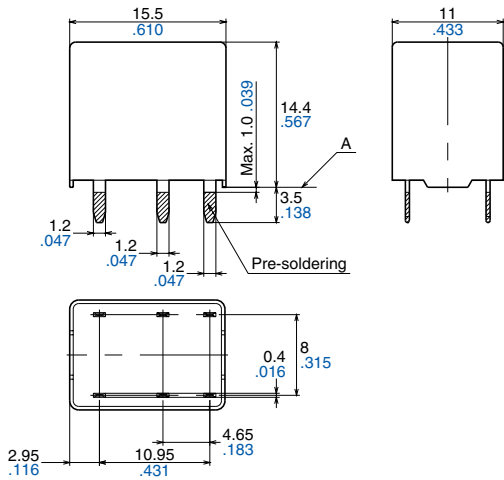

Dimension:	General tolerance
Max. 1mm .039 inch:	$\pm 0.1 \pm 0.04$
1 to 3mm .039 to .118 inch:	$\pm 0.2 \pm 0.08$
Min. 3mm .118 inch:	$\pm 0.3 \pm 0.12$

PC board pattern (Bottom view)

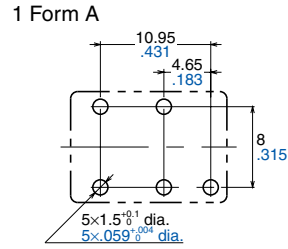

Schematic (Bottom view)

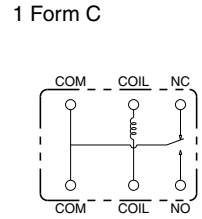
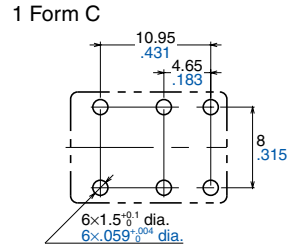
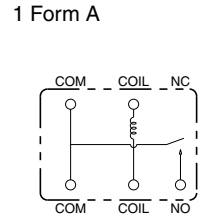

\* Dimensions (thickness and width) of terminal specified in this catalog is measured before pre-soldering. Intervals between terminals is measured at A surface level.

Tolerance:  $\pm 0.1 \pm 0.04$

### 2. Surface-mount terminal type



External dimensions

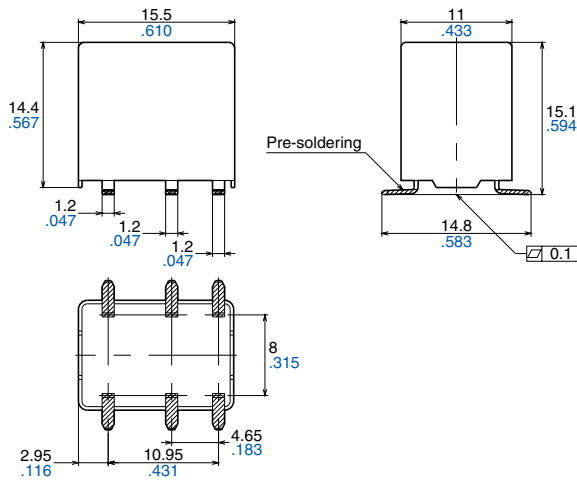

Dimension:	General tolerance
Max. 1mm .039 inch:	$\pm 0.1 \pm 0.04$
1 to 3mm .039 to .118 inch:	$\pm 0.2 \pm 0.08$
Min. 3mm .118 inch:	$\pm 0.3 \pm 0.12$

Recommended mounting pad (Top view)

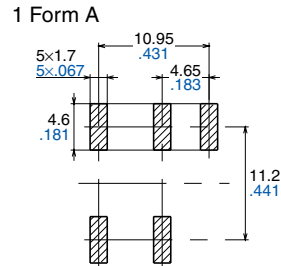

Schematic (Top view)

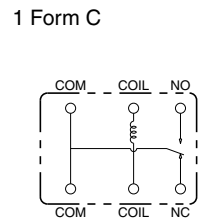
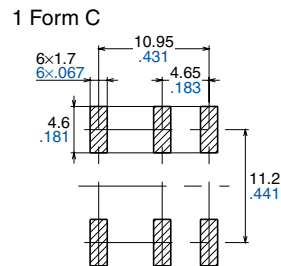
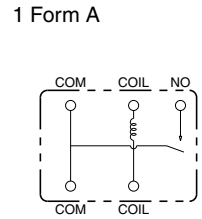

Tolerance:  $\pm 0.1 \pm 0.04$

## NOTES

### 1. Coil operating power

Pure DC current should be applied to the coil. The wave form should be rectangular. If it includes ripple, the ripple factor should be less than 5%. However, check it with the actual circuit since the characteristics may be slightly different.

### 2. Coil applied voltage

To ensure proper operation, the voltage applied to the coil should be the rated operating voltage of the coil. Also, be aware that the pick-up and drop-out voltages will fluctuate depending on the ambient temperature and operating conditions.

### 3. Cycle lifetime

Check this with the real device as it is affected by coil driving circuit, load type, activation frequency, activation phase, ambient conditions and other factors.

### 4. Soldering

When soldering the relays, ensure conformance with the conditions listed below.

#### 1) Automatic soldering

- Preheating: less than 100°C 212°F (solder target surface of PC board) for less than 120 sec

- Soldering: less than 260°C 500°F (solder temperature) for less than 5 sec (soldering time)

#### 2) Manual soldering

- Soldering tip temperature: less than 280 to 300°C 536 to 572°F
- Soldering iron: 30 to 60 W
- Soldering time: less than 5 sec

### 5. Usage, transport and storage conditions

1) Ambient temperature, humidity, and atmospheric pressure during usage, transport, and storage of the relay:

(1) Temperature:  
-40 to +85°C -40 to +185°F

(Standard type)  
-40 to +110°C -40 to +230°F  
(High heat-resistant type)

(2) Humidity: 2 to 85% RH  
(Avoid freezing and condensation.)

(3) Atmospheric pressure: 86 to 106 kPa  
The humidity range varies with the temperature. Use within the range indicated in the graph below.

(Temperature and humidity range for usage, transport, and storage)

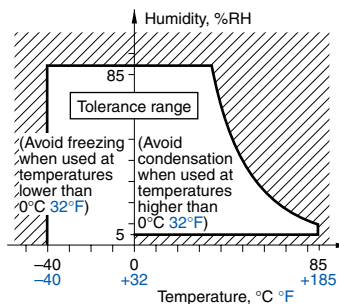
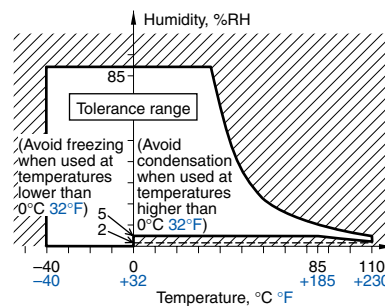

### 2) Condensation

Condensation forms when there is a sudden change in temperature under high temperature and high humidity conditions. Condensation will cause deterioration of the relay insulation.

### 3) Freezing

Condensation or other moisture may freeze on the relay when the temperatures is lower than 0°C 32°F. This causes problems such as sticking of movable parts or operational time lags.

### 4) Low temperature, low humidity environments

The plastic becomes brittle if the relay is exposed to a low temperature, low humidity environment for long periods of time.

### 6. Others

If the relay has been dropped, the appearance and characteristics should always be checked before use.

## Данный компонент на территории Российской Федерации

### Вы можете приобрести в компании MosChip.

Для оперативного оформления запроса Вам необходимо перейти по данной ссылке:

<http://moschip.ru/get-element>

Вы можете разместить у нас заказ для любого Вашего проекта, будь то серийное производство или разработка единичного прибора.

В нашем ассортименте представлены ведущие мировые производители активных и пассивных электронных компонентов.

Нашей специализацией является поставка электронной компонентной базы двойного назначения, продукции таких производителей как XILINX, Intel (ex.ALTERA), Vicor, Microchip, Texas Instruments, Analog Devices, Mini-Circuits, Amphenol, Glenair.

Сотрудничество с глобальными дистрибьюторами электронных компонентов, предоставляет возможность заказывать и получать с международных складов практически любой перечень компонентов в оптимальные для Вас сроки.

На всех этапах разработки и производства наши партнеры могут получить квалифицированную поддержку опытных инженеров.

Система менеджмента качества компании отвечает требованиям в соответствии с ГОСТ Р ИСО 9001, ГОСТ РВ 0015-002 и ЭС РД 009

### Офис по работе с юридическими лицами:

105318, г.Москва, ул.Щербаковская д.3, офис 1107, 1118, ДЦ «Щербаковский»

Телефон: +7 495 668-12-70 (многоканальный)

Факс: +7 495 668-12-70 (доб.304)

E-mail: [info@moschip.ru](mailto:info@moschip.ru)

Skype отдела продаж:

moschip.ru

moschip.ru\_4

moschip.ru\_6

moschip.ru\_9