

Optocoupler, Phototriac Output, Non-Zero Crossing, 1.5 kV/ μ s dV/dt, 600 V

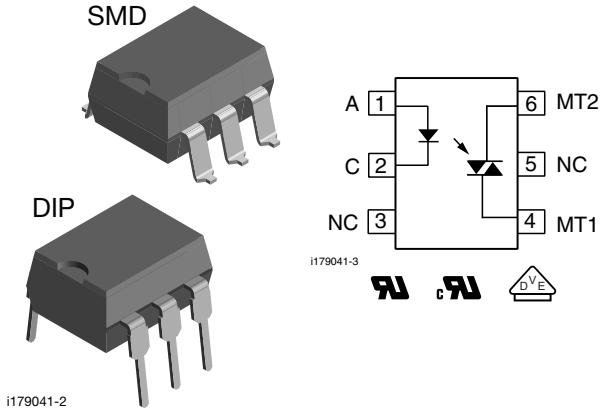

FEATURES

- 1500 V/ μ s dV/dt minimum 2000 V/ μ s typical
- 600 V blocking voltage
- 100 mA on-state current
- Low input trigger current
- 6 pin DIP package
- Material categorization: For definitions of compliance please see www.vishay.com/doc?99912



RoHS
COMPLIANT

APPLICATIONS

- Household appliances
- Triac drive/AC motor drives
- Solenoid/valve controls
- Office automation equipment/machine
- Temperature (HVAC)/lighting controls
- Switching power supply

DESCRIPTION

The VO3052 and VO3053 triac driver family consists of a GaAs infrared LED optically coupled to a monolithic photosensitive non-zero crossing triac detector chip.

The 600 V blocking voltage permits control of off-line voltages up to 240 V_{AC}, with a safety factor or more than two, and is sufficient for as much as 380 V.

AGENCY APPROVALS

- UL-file E52744 system code H or J
- cUL - file no. E52744, equivalent to CSA bulletin 5A
- DIN EN 60747-5-2 (VDE 0884) available with option 1

ORDERING INFORMATION	
<div style="display: flex; justify-content: space-around; align-items: center;"> <div style="border: 1px solid black; padding: 2px 5px; margin: 2px;">V</div> <div style="border: 1px solid black; padding: 2px 5px; margin: 2px;">O</div> <div style="border: 1px solid black; padding: 2px 5px; margin: 2px;">3</div> <div style="border: 1px solid black; padding: 2px 5px; margin: 2px;">0</div> <div style="border: 1px solid black; padding: 2px 5px; margin: 2px;">5</div> <div style="border: 1px solid black; padding: 2px 5px; margin: 2px;">#</div> <div style="border: 1px solid black; padding: 2px 5px; margin: 2px;">-</div> <div style="border: 1px solid black; padding: 2px 5px; margin: 2px;">X</div> <div style="border: 1px solid black; padding: 2px 5px; margin: 2px;">0</div> <div style="border: 1px solid black; padding: 2px 5px; margin: 2px;">#</div> <div style="border: 1px solid black; padding: 2px 5px; margin: 2px;">#</div> <div style="border: 1px solid black; padding: 2px 5px; margin: 2px;">T</div> </div> <p style="text-align: center; margin-top: 5px;"> PART NUMBER PACKAGE OPTION TAPE AND REEL </p>	<p style="font-size: small; text-align: center;"> DIP: 7.62 mm Option 6: 10.16 mm Option 7: > 0.7 mm Option 9: > 0.1 mm </p>
AGENCY CERTIFIED/PACKAGE	TRIGGER, CURRENT I _{FT} (mA)
UL, cUL	5 10
DIP-6	VO3053 VO3052
DIP-6, 400 mil, option 6	VO3053-X006 VO3052-X006
SMD-6, option 7	VO3053-X007T VO3052-X007T
SMD-6, option 9	VO3053-X009T -
VDE, UL, cUL	5 10
DIP-6, 400 mil, option 6	- VO3052-X016

ABSOLUTE MAXIMUM RATINGS ($T_{amb} = 25\text{ }^{\circ}\text{C}$, unless otherwise specified)					
PARAMETER	TEST CONDITION	PART	SYMBOL	VALUE	UNIT
INPUT					
Reverse voltage			V_R	6	V
Forward current - continuous			I_F	60	mA
Power dissipation			P_{diss}	100	mW
OUTPUT					
Off state output terminal voltage		VO3052, VO3053	V_{DRM}	600	V
Peak non-repetitive surge current	PW = 100 ms, 120 pps		I_{TSM}	1	A
Power dissipation			P_{diss}	200	mW
On-state RMS current			$I_{T(RMS)}$	100	mA
COUPLER					
Isolation test voltage	t = 1 s		V_{ISO}	5300	V_{RMS}
Total power dissipation			P_{tot}	300	mW
Operating temperature			T_{amb}	- 55 to + 100	$^{\circ}\text{C}$
Storage temperature			T_{stg}	- 55 to + 150	$^{\circ}\text{C}$
Soldering temperature ⁽¹⁾	10 s		T_{slid}	260	$^{\circ}\text{C}$

Notes

- Stresses in excess of the absolute maximum ratings can cause permanent damage to the device. Functional operation of the device is not implied at these or any other conditions in excess of those given in the operational sections of this document. Exposure to absolute maximum ratings for extended periods of the time can adversely affect reliability.

⁽¹⁾ Refer to reflow profile for soldering conditions for surface mounted devices (SMD). Refer to wave profile for soldering conditions for through hole devices (DIP) "Assembly Instructions" (www.vishay.com/doc?80054).

THERMAL CHARACTERISTICS				
PARAMETER	SYMBOL	VALUE	UNIT	
Maximum LED junction temperature	$T_{jmax.}$	125	$^{\circ}\text{C}$	
Maximum output die junction temperature	$T_{jmax.}$	125	$^{\circ}\text{C}$	
Thermal resistance, junction emitter to board	θ_{JEB}	150	$^{\circ}\text{C}/\text{W}$	
Thermal resistance, junction emitter to case	θ_{JEC}	139	$^{\circ}\text{C}/\text{W}$	
Thermal resistance, junction detector to board	θ_{JDB}	78	$^{\circ}\text{C}/\text{W}$	
Thermal resistance, junction detector to case	θ_{JDC}	103	$^{\circ}\text{C}/\text{W}$	
Thermal resistance, junction emitter to junction detector	θ_{JED}	496	$^{\circ}\text{C}/\text{W}$	
Thermal resistance, case to ambient	θ_{CA}	3563	$^{\circ}\text{C}/\text{W}$	

Note

- The thermal model is represented in the thermal network below. Each resistance value given in this model can be used to calculate the temperatures at each node for a given operating condition. The thermal resistance from board to ambient will be dependent on the type of PCB, layout and thickness of copper traces. For a detailed explanation of the thermal model, please reference Vishay's Thermal Characteristics of Optocouplers application note.



ELECTRICAL CHARACTERISTICS ($T_{amb} = 25\text{ }^{\circ}\text{C}$, unless otherwise specified)							
PARAMETER	TEST CONDITION	PART	SYMBOL	MIN.	TYP.	MAX.	UNIT
INPUT							
Reverse current	$V_R = 6\text{ V}$		I_R			10	μA
Forward voltage	$I_F = 30\text{ mA}$		V_F		1.2	1.5	V
OUTPUT							
Leakage with LED off, either direction	$V_{DRM} = 600\text{ V}$		I_{DRM}		10	500	nA
Critical rate of rise off-state voltage	$V_D = 400\text{ V}$		dV/dt_{cr}	1500	2000		V/ μs
COUPLER							
LED trigger current, current required to latch output		VO3053	I_{FT}			5	mA
		VO3052	I_{FT}			10	mA
Peak on-state voltage, either direction	$I_{TM} = 100\text{ mA peak}$, $I_F = \text{rated } I_{FT}$		V_{TM}		1.7	3	V
Holding current, either direction			I_H		200		μA
Coupling capacitance	10 KHz		C_{IO}		0.4		pF

Note

- Typical values are characteristics of the device and are the result of engineering evaluations. Typical values are for information only and are not part of the testing requirements.

SAFETY AND INSULATION RATINGS						
PARAMETER	SYMBOL	MIN.	TYP.	MAX.	UNIT	
Climatic classification (according to IEC 68 part 1)			55/100/21			
Pollution degree (DIN VDE 0109)			2			
Comparative tracking index	CTI	175				
Peak transient overvoltage	V_{IOTM}	8000			V_{peak}	
Peak working insulation voltage	V_{IORM}	890			V_{peak}	
Isolation resistance at $T_{amb} = 100\text{ }^{\circ}\text{C}$, $V_{DC} = 500\text{ V}$	R_{IO}	10^{11}			Ω	
Isolation resistance at $T_{amb} = 25\text{ }^{\circ}\text{C}$, $V_{DC} = 500\text{ V}$	R_{IO}	10^{12}			Ω	
Partial discharge test voltage (method a, $V_{pd} = V_{IORM} \times 1.875$)	V_{pd}	1669			V_{peak}	
Safety rating - power	P_{SO}			500	mW	
Safety rating - input current	I_{SI}			250	mA	
Safety rating - temperature	T_{SI}			175	$^{\circ}\text{C}$	
Clearance distance (Standard DIP-6)		7			mm	
Creepage distance (Standard DIP-6)		7			mm	
Clearance distance (400 mil DIP-6)		8			mm	
Creepage distance (400 mil DIP-6)		8			mm	

Note

- According to DIN EN60747-5-5 (see figure 4). This optocoupler is suitable for safe electrical isolation only within the safety ratings. Compliance with the safety ratings shall be ensured by means of suitable protective circuits.

TYPICAL CHARACTERISTICS ($T_{amb} = 25\text{ }^{\circ}\text{C}$, unless otherwise specified)

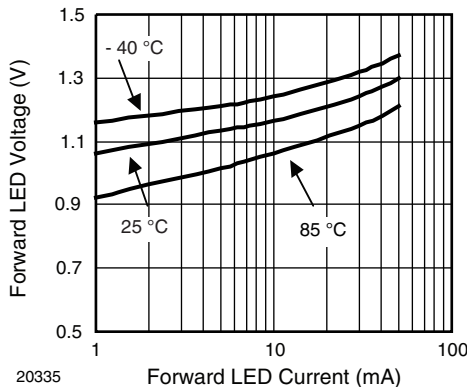

Fig. 1 - Forward Voltage vs. Forward Current

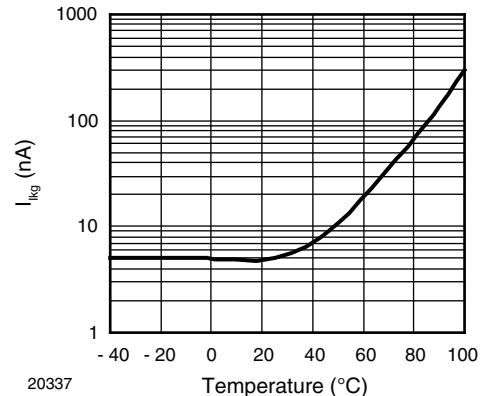

Fig. 2 - Off-State Leakage Current vs. Temperature

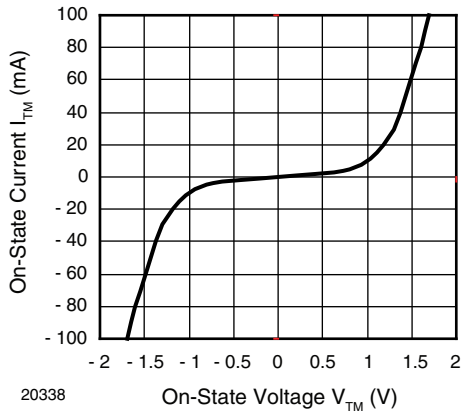

Fig. 3 - On-State Current vs. V_{TM}

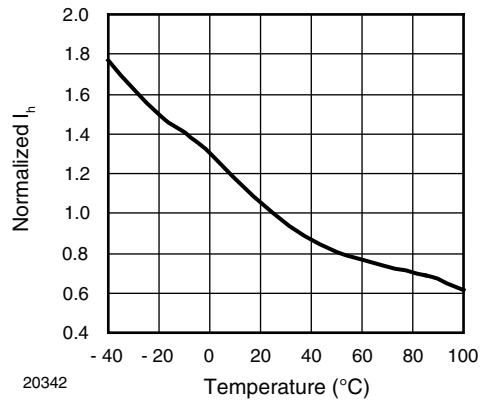

Fig. 6 - Normalized Holding Current vs. Temperature

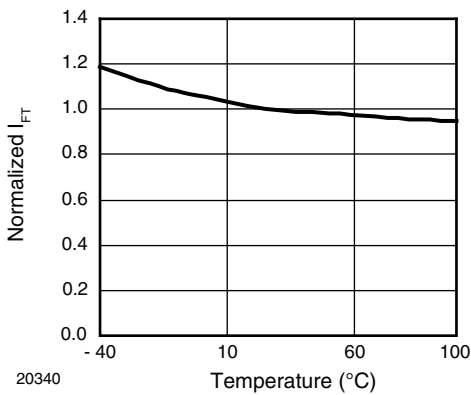

Fig. 4 - Normalized Trigger Current vs. Temperature

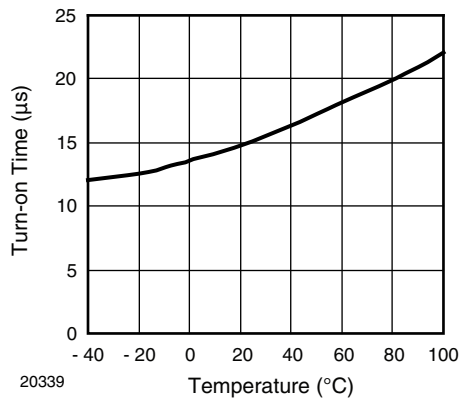

Fig. 7 - Turn-on Time vs. Temperature

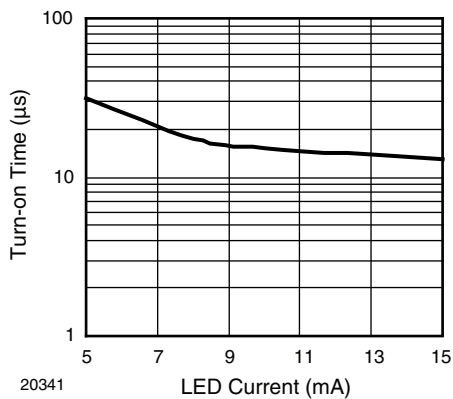

Fig. 5 - Turn-on Time vs. LED Current

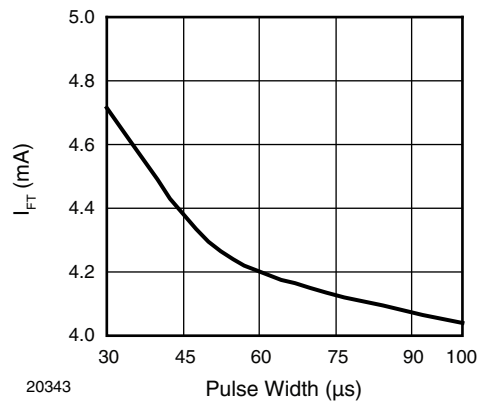
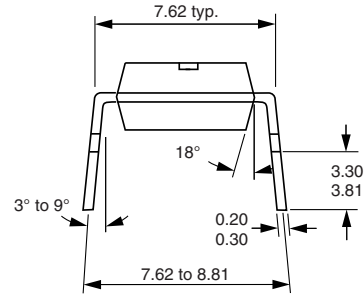
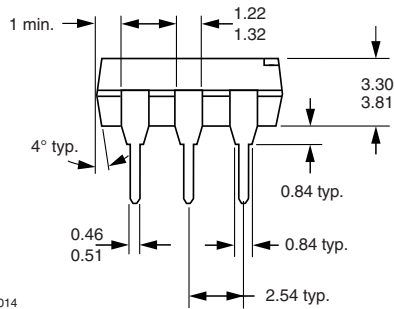
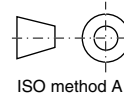
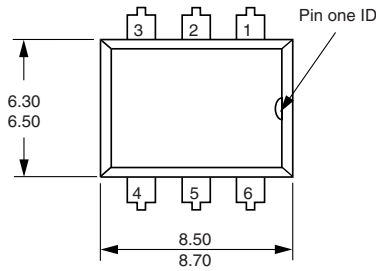

Fig. 8 - Trigger Current vs. Pulse Width

PACKAGE DIMENSIONS in millimeters



i178014

Option 6

Option 7

Option 9

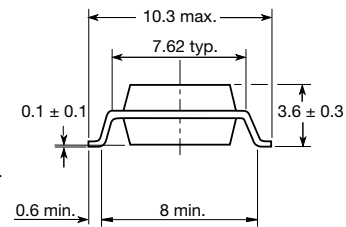
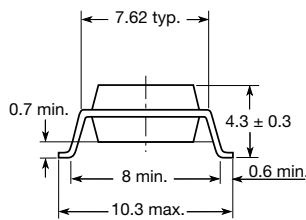
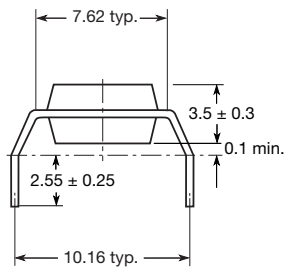

20802-24

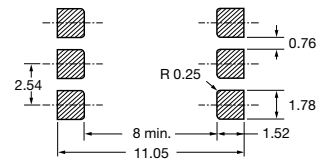
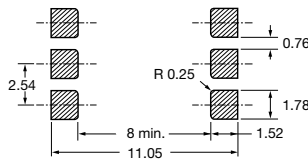

PACKAGE MARKING

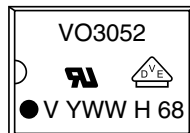

Notes

- The VDE logo is only marked on option1 parts.
- Tape and reel suffix (T) is not part of the package marking.



Disclaimer

ALL PRODUCT, PRODUCT SPECIFICATIONS AND DATA ARE SUBJECT TO CHANGE WITHOUT NOTICE TO IMPROVE RELIABILITY, FUNCTION OR DESIGN OR OTHERWISE.

Vishay Intertechnology, Inc., its affiliates, agents, and employees, and all persons acting on its or their behalf (collectively, "Vishay"), disclaim any and all liability for any errors, inaccuracies or incompleteness contained in any datasheet or in any other disclosure relating to any product.

Vishay makes no warranty, representation or guarantee regarding the suitability of the products for any particular purpose or the continuing production of any product. To the maximum extent permitted by applicable law, Vishay disclaims (i) any and all liability arising out of the application or use of any product, (ii) any and all liability, including without limitation special, consequential or incidental damages, and (iii) any and all implied warranties, including warranties of fitness for particular purpose, non-infringement and merchantability.

Statements regarding the suitability of products for certain types of applications are based on Vishay's knowledge of typical requirements that are often placed on Vishay products in generic applications. Such statements are not binding statements about the suitability of products for a particular application. It is the customer's responsibility to validate that a particular product with the properties described in the product specification is suitable for use in a particular application. Parameters provided in datasheets and/or specifications may vary in different applications and performance may vary over time. All operating parameters, including typical parameters, must be validated for each customer application by the customer's technical experts. Product specifications do not expand or otherwise modify Vishay's terms and conditions of purchase, including but not limited to the warranty expressed therein.

Except as expressly indicated in writing, Vishay products are not designed for use in medical, life-saving, or life-sustaining applications or for any other application in which the failure of the Vishay product could result in personal injury or death. Customers using or selling Vishay products not expressly indicated for use in such applications do so at their own risk. Please contact authorized Vishay personnel to obtain written terms and conditions regarding products designed for such applications.

No license, express or implied, by estoppel or otherwise, to any intellectual property rights is granted by this document or by any conduct of Vishay. Product names and markings noted herein may be trademarks of their respective owners.

Material Category Policy

Vishay Intertechnology, Inc. hereby certifies that all its products that are identified as RoHS-Compliant fulfill the definitions and restrictions defined under Directive 2011/65/EU of The European Parliament and of the Council of June 8, 2011 on the restriction of the use of certain hazardous substances in electrical and electronic equipment (EEE) - recast, unless otherwise specified as non-compliant.

Please note that some Vishay documentation may still make reference to RoHS Directive 2002/95/EC. We confirm that all the products identified as being compliant to Directive 2002/95/EC conform to Directive 2011/65/EU.

Vishay Intertechnology, Inc. hereby certifies that all its products that are identified as Halogen-Free follow Halogen-Free requirements as per JEDEC JS709A standards. Please note that some Vishay documentation may still make reference to the IEC 61249-2-21 definition. We confirm that all the products identified as being compliant to IEC 61249-2-21 conform to JEDEC JS709A standards.

Данный компонент на территории Российской Федерации

Вы можете приобрести в компании MosChip.

Для оперативного оформления запроса Вам необходимо перейти по данной ссылке:

<http://moschip.ru/get-element>

Вы можете разместить у нас заказ для любого Вашего проекта, будь то серийное производство или разработка единичного прибора.

В нашем ассортименте представлены ведущие мировые производители активных и пассивных электронных компонентов.

Нашей специализацией является поставка электронной компонентной базы двойного назначения, продукции таких производителей как XILINX, Intel (ex.ALTERA), Vicor, Microchip, Texas Instruments, Analog Devices, Mini-Circuits, Amphenol, Glenair.

Сотрудничество с глобальными дистрибьюторами электронных компонентов, предоставляет возможность заказывать и получать с международных складов практически любой перечень компонентов в оптимальные для Вас сроки.

На всех этапах разработки и производства наши партнеры могут получить квалифицированную поддержку опытных инженеров.

Система менеджмента качества компании отвечает требованиям в соответствии с ГОСТ Р ИСО 9001, ГОСТ РВ 0015-002 и ЭС РД 009

Офис по работе с юридическими лицами:

105318, г.Москва, ул.Щербаковская д.3, офис 1107, 1118, ДЦ «Щербаковский»

Телефон: +7 495 668-12-70 (многоканальный)

Факс: +7 495 668-12-70 (доб.304)

E-mail: info@moschip.ru

Skype отдела продаж:

moschip.ru

moschip.ru_4

moschip.ru_6

moschip.ru_9