

POWER

LCM300

310 Watt Bulk Front End

Data Sheet

Total Power: 310 W
of Outputs: Single
Outputs: 12 to 60 V
Optional 5.0 V standby

SPECIAL FEATURES

- 310 W output power (350 W at 45 °C for 24 V and 36 V models)
- Low cost
- 1.61" x 4.0" x 7.0"
- 7.1 Watts per cubic inch
- Industrial/Medical safety
- 40 °C to 70 °C with derating
- Optional 5 V @ 2 A housekeeping
- High efficiency: 91% @ 230 Vac
- Variable speed "Smart Fans"
- DSP controlled
- PMBus compliant
- Conformal coat option
- Wide adjustment range
- Margin programming
- OR-ing FET

COMPLIANCE

- EMI Class B
- EN61000 Immunity
- RoHS 2
- PMBUS

SAFETY

- UL 62368-1
508/1598/1433
60601-1 Ed 3
- CSA 62368-1
- VDE 62368-1
60601
- China CCC
- CB Scheme Report/Cert

** LCM300 tested according to the medical standard IEC 60601-1-2 4th Edition.



Electrical Specifications

Input	
Input range	90 - 264 Vac (Operating) 115/230 Vac (Nominal) TERMINAL BLOCK
Frequency	47 - 63 Hz, Nominal 50/60
Input fusing	Internal 8 A fuses, both lines fused
Inrush current	< 20 A peak, cold start at 25 °C
Power factor	0.98 typical, meets EN61000-3-2
Harmonics	Meets IEC 1000-3-2 requirements
Input current	5 Arms max input current, at 90 Vac
Hold up time	20 ms minimum for main O/P, at full rated load
Efficiency	> 91% typical at full load / 230 Vac nominal
Leakage current	< 300 µA @ 240 Vac
ON/OFF power switch	N/A
Power line transient	MOV directly after the fuse
Isolation	Isolation: PRI-Chassis 2500 Vdc Basic PRI-SEC 4000 Vac Reinforced 2xMOPP SEC-Chassis 500 Vdc

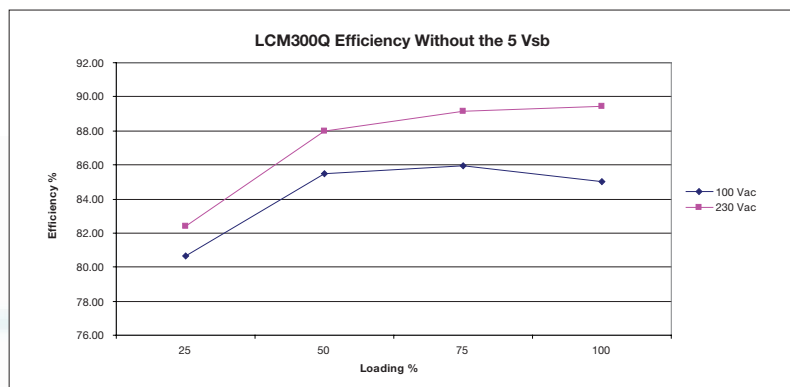

Electrical Specifications

Output		
Output rating	See table 1	90 - 264 Vac
Set point	±0.5%	90 - 264 Vac
Total regulation range	Main output ±2% 5 Vsb ±1%	Combined line/load/transient when measured at output terminal
Rated load	310 W (360 W for current Q and U variants)	Derate linear to 50% from 50 °C to 70 °C
Minimum load	Main output @ 0.0 A 5 Vsb @ 0.0 A	No loss of regulation
Output noise (PARD)	1% max p-p 100 mV max p-p	Main output 5 Vsb output Measured with a 0.1 µF Ceramic and 10 µF Tantalum Capacitor on any output, 20 MHz
Output voltage overshoot		No overshoot/undershoot outside the regulation band during on or off cycle
Transient response	< 300 µSec	50% load step @ 1 A/µs Step load valid between 10% to 100% of output rating Recovery time to within 1% of set point at onset of transient
Max units in parallel		Up to 10
Short circuit protection	Protected, no damage to occur	Bounce mode
Remote sense		Compensation up to 500 mV
Output isolation		Standard per safety requirements
Forced load sharing	To within 10% of all shared outputs	Analog sharing control
Overload protection (OCP)	105% to 125% 120% to 170%	Main output 5 Vsb output
Overvoltage protection (OVP)	125% to 145% 110% to 125%	12 V output 5 Vsb output

Environmental Specifications

Operating temperature	-40 °C to +70 °C, linear derating to 50% from 50 °C to 70 °C
Storage temperature	-40 °C to +85 °C
Humidity	10 to 90%, non-condensing. Operating. Conformal coat option available.
Fan noise	< 45 dBA, 80% load at 40 °C; Fan Off when unit is inhibited
Altitude	Operating - 16,405 feet (5000m) Storage - 30,000 feet
Shock	MIL-STD-810F 516.5, Procedure I, VI. Storage
Vibration	MIL-STD-810F 514.5, Cat. 4, 10. Storage

Ordering Information

Model Number*	Output	Nominal Output Voltage Set Point	Set Point Tolerance	Adjustment Range	Current		Output Ripple P/P (0-50 °C)	Max Continuous Power	Combined Line/Load Regulation
					Min	Max			
LCM300L	12 V	12 V	±0.5%	9.6 - 14.4 V	0 A	25.0 A	120 mV	310 W	2%
LCM300N	15 V	15 V	±0.5%	14.25 - 19.5 V	0 A	20.0 A	150 mV	310 W	2%
LCM300Q	24 V	24 V	±0.5%	19.2 - 28.8 V	0 A	12.5 A*	240 mV	310 W	2%
LCM300U	36 V	36 V	±0.5%	28.8 - 43.2 V	0 A	8.4 A*	360 mV	310 W	2%
LCM300W	50 V	48 V	±0.5%	43.0 - 60.0 V	0 A	6.3 A	480 mV	310 W	2%

* 14.5 A rating on LCM300Q-T and 9.7 A on LCM300U-T when max temp does not exceed 45C (Total Power = 350 W)

Pin Assignment

Signals	Name Description	Pin Number(s)	
+Vout	Power rail	SK4	
GND	Power GND	SK5	
Signals	Name Description	Amps per pin	SK2 Pin Number
A2	EEPROM Address		1
-VPROG	Return connection of external supply for Margin Programming		2
A1	EEPROM Address		3
-Vsense	Remote Sense Return		4
ISHARE	Load share voltage		5
A0	EEPROM Address		6
SDA1	Serial Data Signal (I ² C)		7
+VPROG	Positive connection of external supply for Margin Programming		8
SCL1	Serial Clock Signal (I ² C)		9
+Vsense	Remote Sense Positive		10
5VSB	5 V standby	2 A	11
GND	5 V standby Return	2 A	12
5VSB	5 V standby	N/A	13
G_DCOK_C	Global DCOK Collector		14
GPIOA6	EEPROM Write Protect		15
G_DCOK_E	Global DCOK Emitter (GND)		16
GND	Return Ground for output signal and I2C communication		17
G_ACOK_C	Global ACOK Collector		18
INH_EN	Turn Off Main Output		19
G_ACOK_E	Global ACOK Emitter (GND)		20

Note: Mating connector for SK2 is:

LANDWIN: PN 2050S2000 Housing and PN 2053T021V Contact
 CIVILUX: PN C10120SD000 Housing and PN C101TD21PE0 Contact

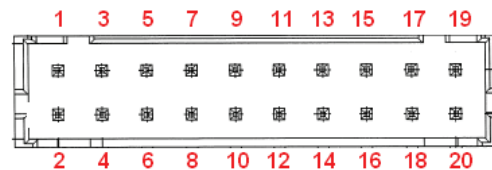
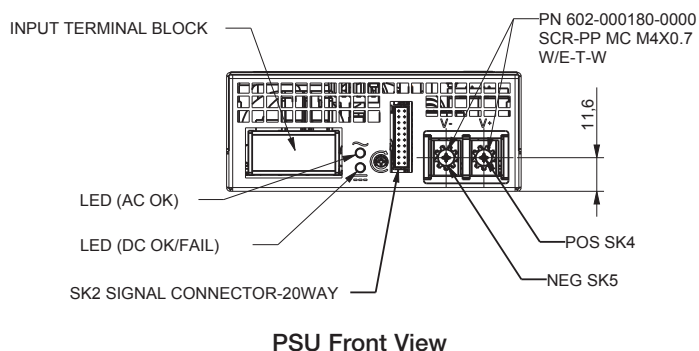

Signal Output Signal Connectors (SK2)
 SK2 Mating Connector: JST Part Number PHDR-20VS;
 Contact Pins: JST Part Number SPHD-001T-P0.5

LED INDICATORS

2 provided are clearly visible up to a 45 degree offset from vertical with office environment ambient lighting. The status is reflected in the indicator color.

The DC_OK LED LED shall light green if the DC output is within specification, and should be off if the output falls out of specification.

The AC_OK LED LED is green if the AC is within specification and off when out of specification. Note: With 5 V standby, Green also indicates that PSU is in standby mode/output off.

CONTROL SIGNALS

AC_OK Open collector 0.5 V maximum at 10 mA. Both emitter and collector access provided.

DC_OK Open collector 0.5 V maximum at 10 mA. Both emitter and collector access provided.

PS_INHIBIT/ENABLE Signal 0.0 - 0.5 V contact closure, output OFF (output ON for LCM300U-T-4-401)

Ordering Information Table 2

LCMXXXXY		-	A	-	B	-	C	-	###
Case Size			Input Termination		Acoustic Noise		Option Codes		Hardware Code
1-Phase input where XXXX =									
300 = 1.61" x 4.0" x 7.0", 300 W					Blank = Standard		Blank = No Options		Factory Assigned for Modified standards
Voltage Code Y =			T = Terminal Block				1 = Conformal Coat		
Code							4 = 5 V Standby		
							5 = Opt 1 + 4		
L	12								
N	15								
Q	24								
U	36								
W	48								

Mechanical Drawings

Weight: 1.76 lbs (0.8 Kg)

MOUNTING LOCATIONS SCREW PENETRATION DEPTH IS 3.0 mm MAX.

RECOMMENDED SCREW TORQUE:

M3.5 x 0.6P = 6 - 8kgf-cm

M4.0 x 0.7P = 8 - 10kgf-cm

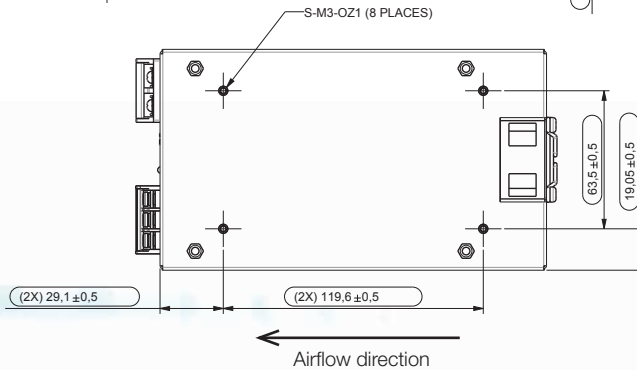
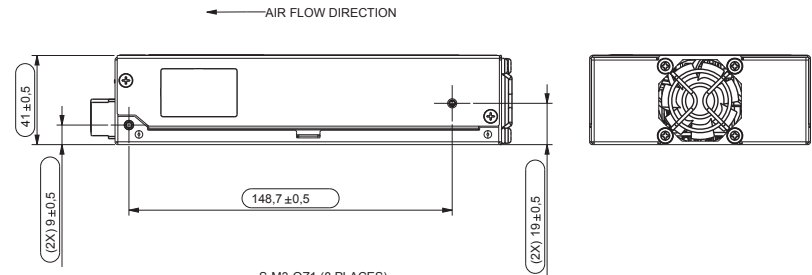
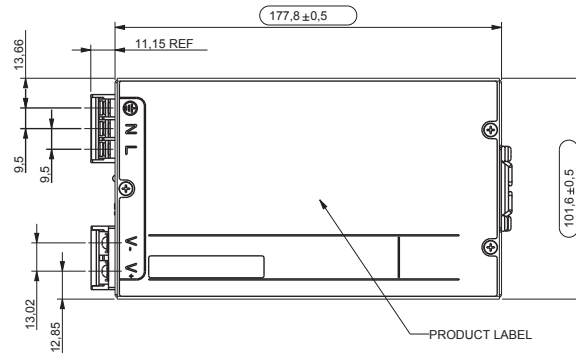
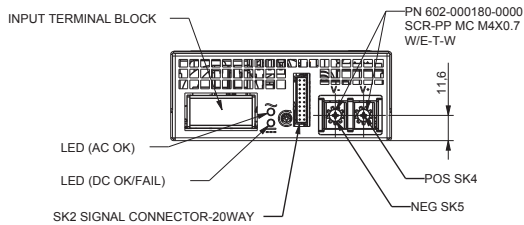

Accessories

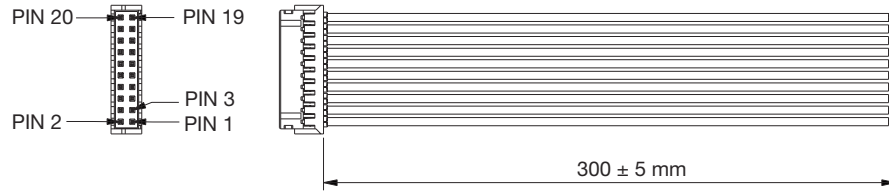

Order kit part number 73-788-001 for control connector interface with .3m wires attached

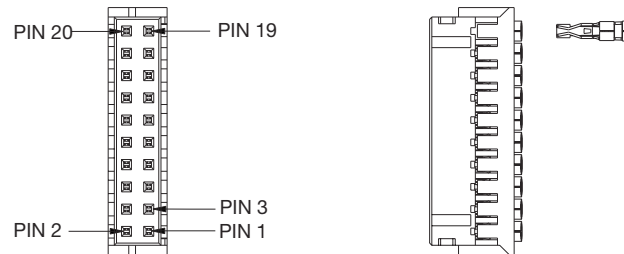

Order kit part number 73-788-002 for control connector interface with unloaded housing and 20 pins

Miscellaneous Specifications

BURN-IN

100% Burn-in at 45 °C, at 80 - 90 % load. Duration of burn-in determined by Quality Assurance Procedures.

MTBF

The power supply has a minimum MTBF of 300K hours using the Bell core 332, issue 6 specification @ 25 °C and 40 °C, ambient, at full load. With the power supply installed in a system in a 25 °C ambient environment and operating at full load, capacitor life shall be 5 years at 50 °C, minimum for ALL electrolytic capacitors contained within this power supply. The power supply shall demonstrate a MTBF level of > 500,000 hours.

QUALITY ASSURANCE

Full QAV testing shall be conducted in accordance with Artesyn Embedded Power Standards with reports available upon request.

WARRANTY

Artesyn Embedded Power shall warrant the power supply to be free of defects in materials and workmanship for a minimum period of three years from the date of shipment, when operated within specifications. The warranty shall be fully transferable to the end owner of the equipment powered by the supply.

WORLDWIDE OFFICES

Americas

2900 South Diablo Way
Suite B100
Tempe, AZ 85282, USA
+1 888 412 7832

Europe (UK)

Ground Floor Offices, Barberry House
4 Harbour Buildings, Waterfront West
Brierley Hill, West Midlands
DY5 1LN, UK
+44 (0) 1384 842 211

Asia (HK)

14/F, Lu Plaza
2 Wing Yip Street
Kwun Tong, Kowloon
Hong Kong
+852 2176 3333

ARTESYNTM
An Advanced Energy Company

www.artesyn.com

Artesyn Embedded Technologies, Artesyn Embedded Power, Artesyn, and all Artesyn related logos are trademarks and service marks of Artesyn Embedded Technologies, Inc. All other names and logos referred to are trade names, trademarks, or registered trademarks of their respective owners. Specifications are subject to change without notice. © 2020 Artesyn Embedded Technologies, Inc. All rights reserved. For full legal terms and conditions, please visit www.artesyn.com/legal.

For more information: www.artesyn.com
For support: productsupport.ep@artesyn.com

Данный компонент на территории Российской Федерации

Вы можете приобрести в компании MosChip.

Для оперативного оформления запроса Вам необходимо перейти по данной ссылке:

<http://moschip.ru/get-element>

Вы можете разместить у нас заказ для любого Вашего проекта, будь то серийное производство или разработка единичного прибора.

В нашем ассортименте представлены ведущие мировые производители активных и пассивных электронных компонентов.

Нашей специализацией является поставка электронной компонентной базы двойного назначения, продукции таких производителей как XILINX, Intel (ex.ALTERA), Vicor, Microchip, Texas Instruments, Analog Devices, Mini-Circuits, Amphenol, Glenair.

Сотрудничество с глобальными дистрибьюторами электронных компонентов, предоставляет возможность заказывать и получать с международных складов практически любой перечень компонентов в оптимальные для Вас сроки.

На всех этапах разработки и производства наши партнеры могут получить квалифицированную поддержку опытных инженеров.

Система менеджмента качества компании отвечает требованиям в соответствии с ГОСТ Р ИСО 9001, ГОСТ РВ 0015-002 и ЭС РД 009

Офис по работе с юридическими лицами:

105318, г.Москва, ул.Щербаковская д.3, офис 1107, 1118, ДЦ «Щербаковский»

Телефон: +7 495 668-12-70 (многоканальный)

Факс: +7 495 668-12-70 (доб.304)

E-mail: info@moschip.ru

Skype отдела продаж:

moschip.ru

moschip.ru_4

moschip.ru_6

moschip.ru_9