

High Speed Infrared Emitting Diodes, 850 nm, GaAlAs, DH

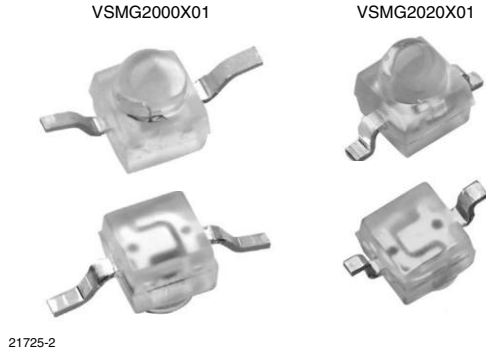

DESCRIPTION

VSMG2000X01 series are infrared, 850 nm emitting diodes in GaAlAs (DH) technology with high radiant power and high speed, molded in clear, untinted plastic packages (with lens) for surface mounting (SMD).

FEATURES

- Package type: surface mount
- Package form: GW, RGW
- Dimensions (L x W x H in mm): 2.3 x 2.3 x 2.8
- AEC-Q101 qualified
- Peak wavelength: $\lambda_p = 850$ nm
- High reliability
- High radiant power
- High radiant intensity
- Angle of half intensity: $\phi = \pm 12^\circ$
- Low forward voltage
- Suitable for high pulse current operation
- Terminal configurations: gullwing or reserve gullwing
- Package matches with detector VEMD2000X01 series
- Floor life: 4 weeks, MSL 2a, acc. J-STD-020
- Compliant to RoHS directive 2002/95/EC and in accordance to WEEE 2002/96/EC
- Halogen-free according to IEC 61249-2-21 definition
- Find out more about Vishay's Automotive Grade Product requirements at: www.vishay.com/applications

AUTOMOTIVE
GRADE



RoHS
COMPLIANT
HALOGEN
FREE

APPLICATIONS

- IrDA compatible data transmission
- IR-illumination (CCTV)
- Miniature light barrier
- Photointerrupters
- Optical switch
- Shaft encoders
- IR emitter source for proximity applications

PRODUCT SUMMARY

COMPONENT	I_e (mW/sr)	ϕ (deg)	λ_p (nm)	t_r (ns)
VSMG2000X01	40	± 12	850	20
VSMG2020X01	40	± 12	850	20

Note

Test conditions see table "Basic Characteristics"

ORDERING INFORMATION

ORDERING CODE	PACKAGING	REMARKS	PACKAGE FORM
VSMG2000X01	Tape and reel	MOQ: 6000 pcs, 6000 pcs/reel	Reverse gullwing
VSMG2020X01	Tape and reel	MOQ: 6000 pcs, 6000 pcs/reel	Gullwing

Note

MOQ: minimum order quantity

ABSOLUTE MAXIMUM RATINGS

PARAMETER	TEST CONDITION	SYMBOL	VALUE	UNIT
Reverse voltage		V_R	5	V
Forward current		I_F	100	mA

ABSOLUTE MAXIMUM RATINGS				
PARAMETER	TEST CONDITION	SYMBOL	VALUE	UNIT
Peak forward current	$t_p/T = 0.5$, $t_p = 100 \mu s$	I_{FM}	200	mA
Surge forward current	$t_p = 100 \mu s$	I_{FSM}	1	A
Power dissipation		P_V	170	mW
Junction temperature		T_j	100	$^{\circ}C$
Operating temperature range		T_{amb}	- 40 to + 85	$^{\circ}C$
Storage temperature range		T_{stg}	- 40 to + 100	$^{\circ}C$
Soldering temperature	Acc. figure 9, J-STD-020	T_{sd}	260	$^{\circ}C$
Thermal resistance junction/ambient	J-STD-051, leads 7 mm, soldered on PCB	R_{thJA}	250	K/W

Note

$T_{amb} = 25 \text{ }^{\circ}C$, unless otherwise specified

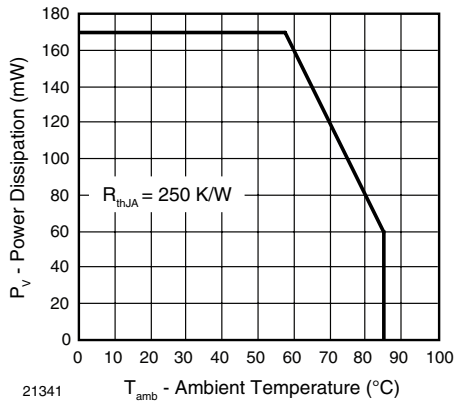

Fig. 1 - Power Dissipation Limit vs. Ambient Temperature

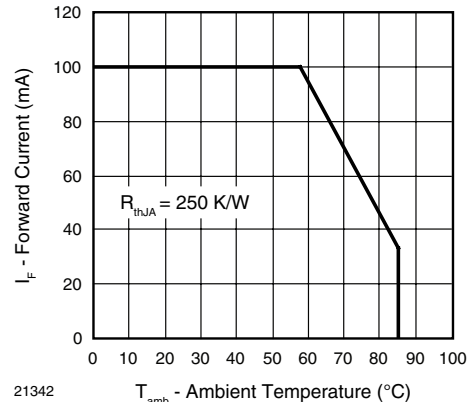

Fig. 2 - Forward Current Limit vs. Ambient Temperature

BASIC CHARACTERISTICS						
PARAMETER	TEST CONDITION	SYMBOL	MIN.	TYP.	MAX.	UNIT
Forward voltage	$I_F = 100 \text{ mA}$, $t_p = 20 \text{ ms}$	V_F	1.25	1.45	1.7	V
	$I_F = 1 \text{ A}$, $t_p = 100 \mu s$	V_F		2.3		V
Temperature coefficient of V_F	$I_F = 1 \text{ mA}$	TK_{V_F}		- 1.8		mV/K
	$I_F = 100 \text{ mA}$	TK_{V_F}		- 1.1		mV/K
Reverse current	$V_R = 5 \text{ V}$	I_R			10	μA
Junction capacitance	$V_R = 0 \text{ V}$, $f = 1 \text{ MHz}$, $E = 0 \text{ mW/cm}^2$	C_J		125		pF
Radiant intensity	$I_F = 100 \text{ mA}$, $t_p = 20 \text{ ms}$	I_e	20	40	60	mW/sr
	$I_F = 1 \text{ A}$, $t_p = 100 \mu s$	I_e		350		mW/sr
Radiant power	$I_F = 100 \text{ mA}$, $t_p = 20 \text{ ms}$	ϕ_e		40		mW
Temperature coefficient of ϕ_e	$I_F = 100 \text{ mA}$	TK_{ϕ_e}		- 0.35		%/K
Angle of half intensity		φ		± 12		deg
Peak wavelength	$I_F = 30 \text{ mA}$	λ_p	830	850	870	nm
Spectral bandwidth	$I_F = 30 \text{ mA}$	$\Delta\lambda$		35		nm
Temperature coefficient of λ_p	$I_F = 30 \text{ mA}$	TK_{λ_p}		0.25		nm/K
Rise time	$I_F = 100 \text{ mA}$, 20 % to 80 %	t_r		20		ns
Fall time	$I_F = 100 \text{ mA}$, 20 % to 80 %	t_f		20		ns
Cut-off frequency	$I_{DC} = 70 \text{ mA}$, $I_{AC} = 30 \text{ mA pp}$	f_c		23		MHz
Virtual source diameter		d		1.5		mm

Note

$T_{amb} = 25 \text{ }^{\circ}C$, unless otherwise specified

BASIC CHARACTERISTICS

$T_{amb} = 25\text{ }^{\circ}\text{C}$, unless otherwise specified

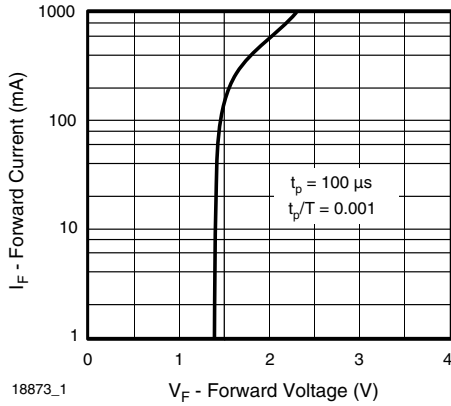

Fig. 3 - Forward Current vs. Forward Voltage

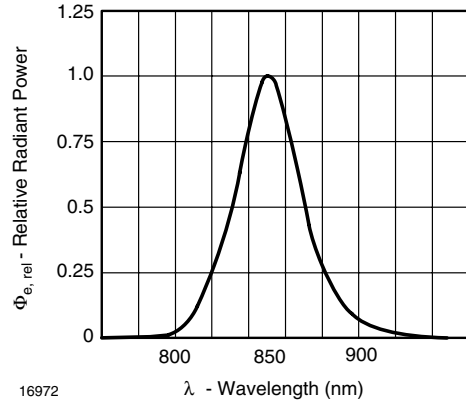

Fig. 6 - Relative Radiant Power vs. Wavelength

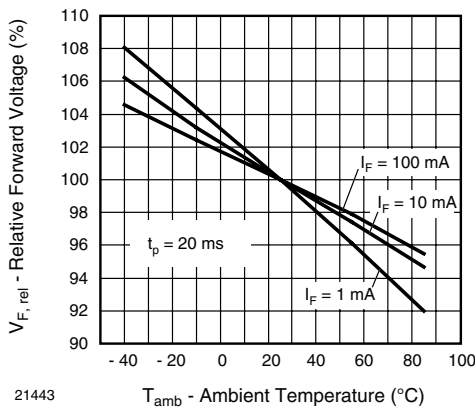

Fig. 4 - Relative Forward Voltage vs. Ambient Temperature

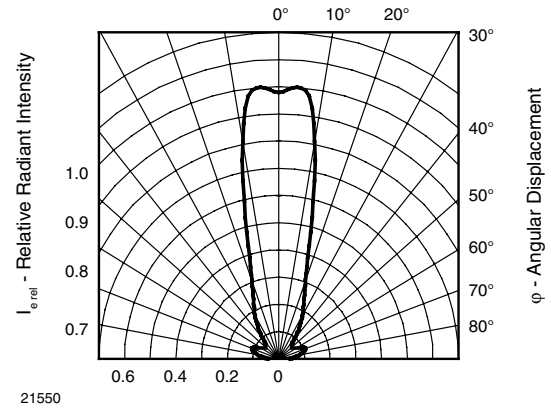

Fig. 7 - Relative Radiant Intensity vs. Angular Displacement

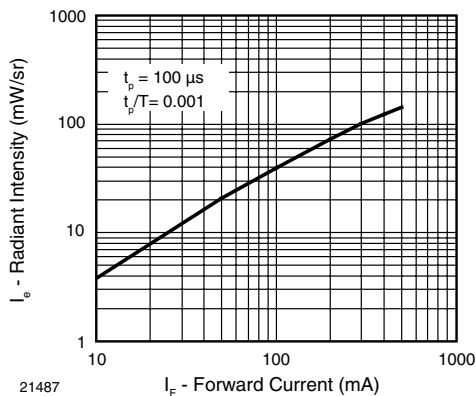

Fig. 5 - Radiant Intensity vs. Forward Current

VSMG2000X01, VSMG2020X01



Vishay Semiconductors High Speed Infrared Emitting Diodes,
850 nm, GaAlAs, DH

SOLDER PROFILE

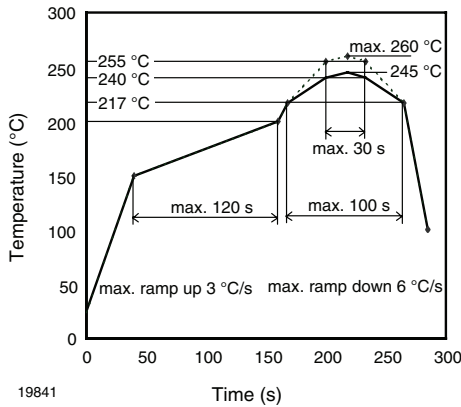

Fig. 8 - Lead (Pb)-free Reflow Solder Profile acc. J-STD-020

DRYPACK

Devices are packed in moisture barrier bags (MBB) to prevent the products from moisture absorption during transportation and storage. Each bag contains a desiccant.

FLOOR LIFE

Floor life (time between soldering and removing from MBB) must not exceed the time indicated on MBB label:

Floor life: 4 weeks

Conditions: $T_{amb} < 30\text{ °C}$, $RH < 60\%$

Moisture sensitivity level 2a, acc. to J-STD-020.

DRYING

In case of moisture absorption devices should be baked before soldering. Conditions see J-STD-020 or label. Devices taped on reel dry using recommended conditions 192 h at 40 °C ($+ 5\text{ °C}$), $RH < 5\%$.

PACKAGE DIMENSIONS in millimeters: VSMG2000

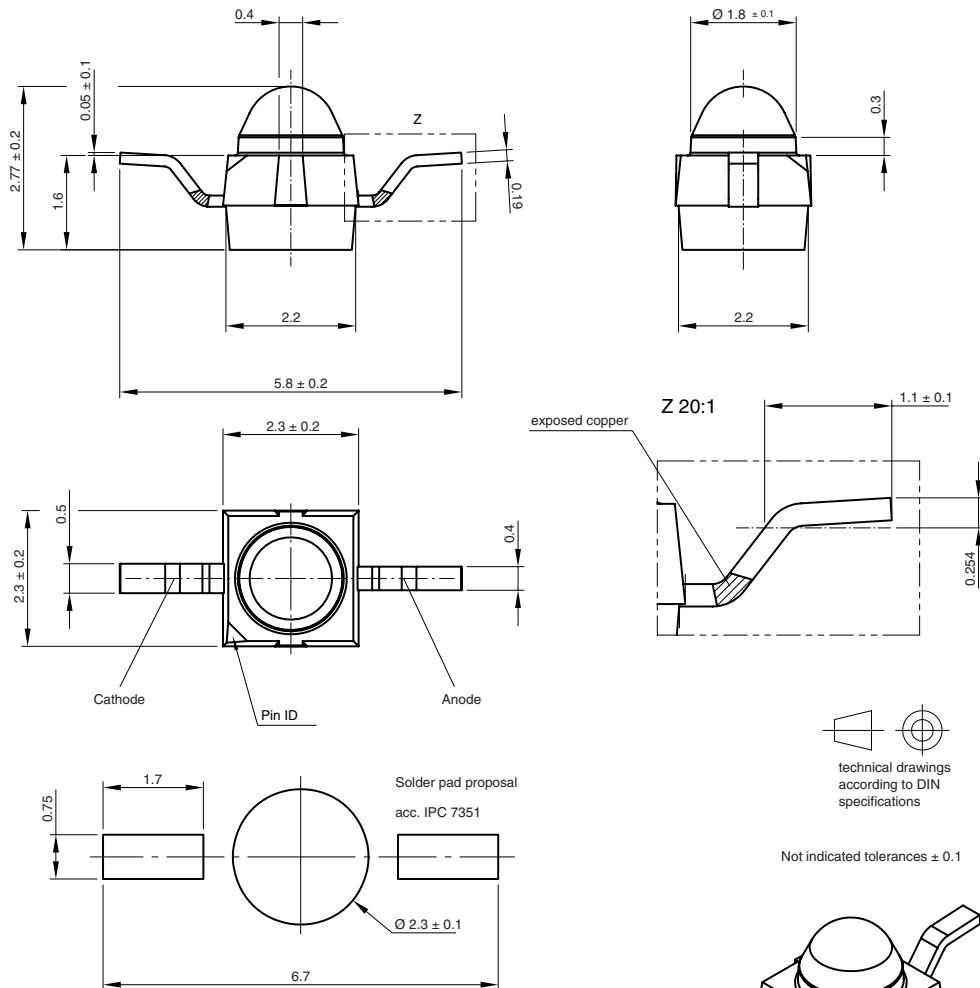

Drawing-No.: 6.544-5391.02-4
Issue: 1; 26.09.08
21517

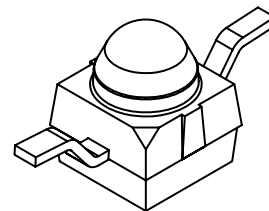



VSMG2000X01, VSMG2020X01

High Speed Infrared Emitting Diodes, Vishay Semiconductors
850 nm, GaAlAs, DH

PACKAGE DIMENSIONS in millimeters: VSMG2020

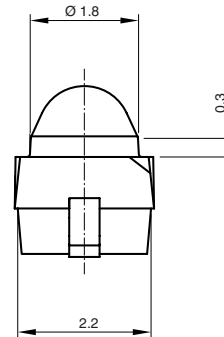
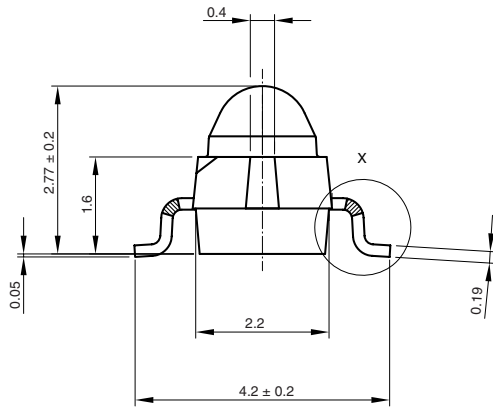

X 20:1

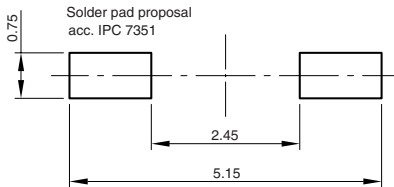
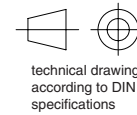
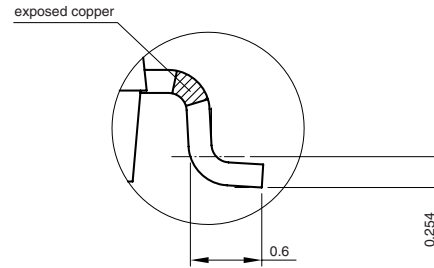
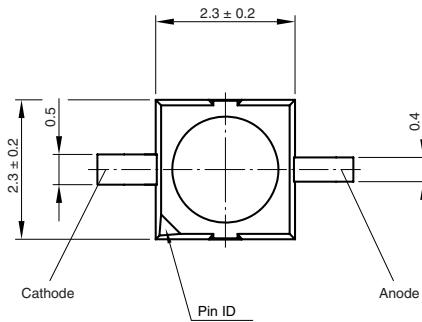

Not indicated tolerances ± 0.1

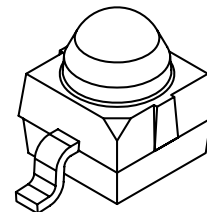

Drawing-No.: 6.544-5383.02-4
Issue: 3; 26.09.08
21488

VSMG2000X01, VSMG2020X01



Vishay Semiconductors High Speed Infrared Emitting Diodes,
850 nm, GaAlAs, DH

TAPING AND REEL DIMENSIONS in millimeters: VSMG2000

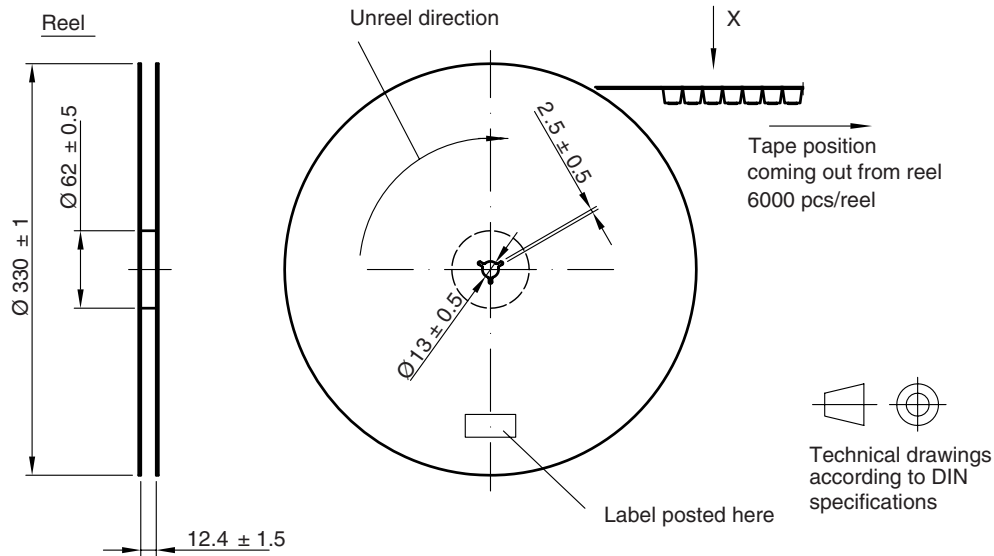

Leader and trailer tape:

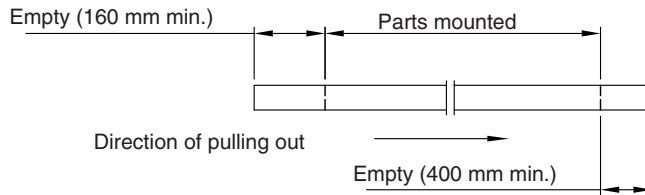

Terminal position in tape

Device	Lead I	Lead II
VEMT2000	Collector	Emitter
VEMT2500		
VEMD2000	Cathode	Anode
VSMB2000		

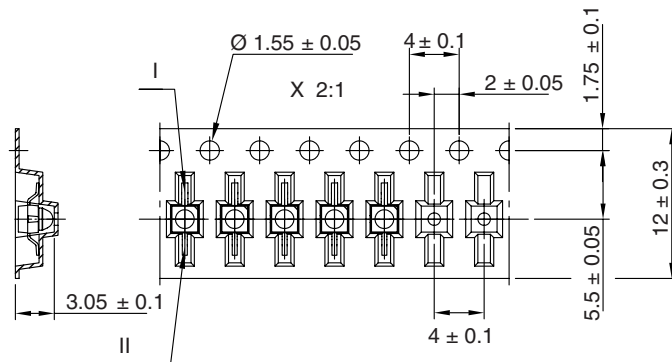

Drawing-No.: 9.800-5100.01-4
Issue: X; 29.04.09
21572



VSMG2000X01, VSMG2020X01

High Speed Infrared Emitting Diodes, Vishay Semiconductors
850 nm, GaAlAs, DH

TAPING AND REEL DIMENSIONS in millimeters: VSMG2020

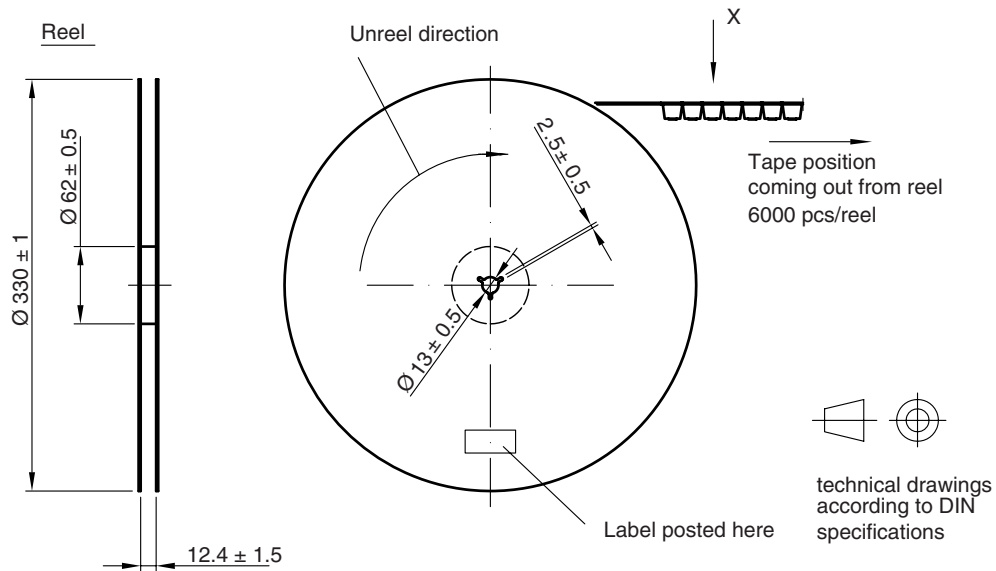

Leader and trailer tape:

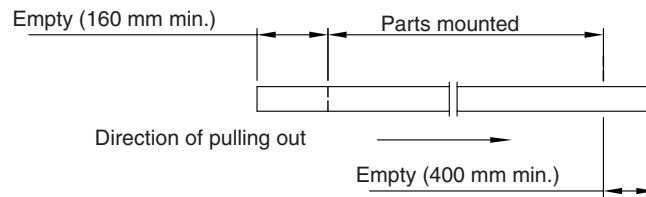

Terminal position in tape

Device	Lead I	Lead II
VEMT2020	Collector	Emitter
VEMT2520		
VSMB2020	Cathode	Anode
VEMD2020		

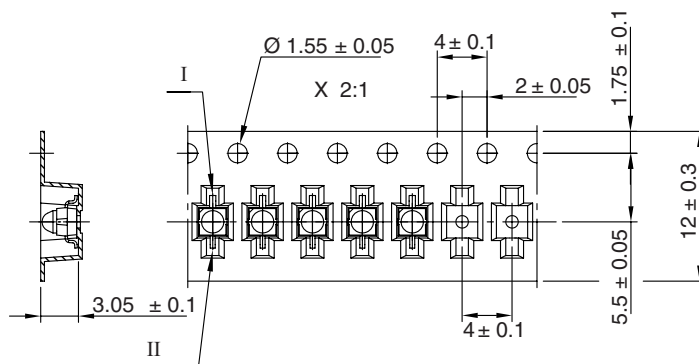

Drawing-No.: 9.800-5091.01-4

Issue: X; 29.04.09

21571



Disclaimer

ALL PRODUCT, PRODUCT SPECIFICATIONS AND DATA ARE SUBJECT TO CHANGE WITHOUT NOTICE TO IMPROVE RELIABILITY, FUNCTION OR DESIGN OR OTHERWISE.

Vishay Intertechnology, Inc., its affiliates, agents, and employees, and all persons acting on its or their behalf (collectively, "Vishay"), disclaim any and all liability for any errors, inaccuracies or incompleteness contained in any datasheet or in any other disclosure relating to any product.

Vishay makes no warranty, representation or guarantee regarding the suitability of the products for any particular purpose or the continuing production of any product. To the maximum extent permitted by applicable law, Vishay disclaims (i) any and all liability arising out of the application or use of any product, (ii) any and all liability, including without limitation special, consequential or incidental damages, and (iii) any and all implied warranties, including warranties of fitness for particular purpose, non-infringement and merchantability.

Statements regarding the suitability of products for certain types of applications are based on Vishay's knowledge of typical requirements that are often placed on Vishay products in generic applications. Such statements are not binding statements about the suitability of products for a particular application. It is the customer's responsibility to validate that a particular product with the properties described in the product specification is suitable for use in a particular application. Parameters provided in datasheets and/or specifications may vary in different applications and performance may vary over time. All operating parameters, including typical parameters, must be validated for each customer application by the customer's technical experts. Product specifications do not expand or otherwise modify Vishay's terms and conditions of purchase, including but not limited to the warranty expressed therein.

Except as expressly indicated in writing, Vishay products are not designed for use in medical, life-saving, or life-sustaining applications or for any other application in which the failure of the Vishay product could result in personal injury or death. Customers using or selling Vishay products not expressly indicated for use in such applications do so at their own risk and agree to fully indemnify and hold Vishay and its distributors harmless from and against any and all claims, liabilities, expenses and damages arising or resulting in connection with such use or sale, including attorneys fees, even if such claim alleges that Vishay or its distributor was negligent regarding the design or manufacture of the part. Please contact authorized Vishay personnel to obtain written terms and conditions regarding products designed for such applications.

No license, express or implied, by estoppel or otherwise, to any intellectual property rights is granted by this document or by any conduct of Vishay. Product names and markings noted herein may be trademarks of their respective owners.

Данный компонент на территории Российской Федерации

Вы можете приобрести в компании MosChip.

Для оперативного оформления запроса Вам необходимо перейти по данной ссылке:

<http://moschip.ru/get-element>

Вы можете разместить у нас заказ для любого Вашего проекта, будь то серийное производство или разработка единичного прибора.

В нашем ассортименте представлены ведущие мировые производители активных и пассивных электронных компонентов.

Нашей специализацией является поставка электронной компонентной базы двойного назначения, продукции таких производителей как XILINX, Intel (ex.ALTERA), Vicor, Microchip, Texas Instruments, Analog Devices, Mini-Circuits, Amphenol, Glenair.

Сотрудничество с глобальными дистрибьюторами электронных компонентов, предоставляет возможность заказывать и получать с международных складов практически любой перечень компонентов в оптимальные для Вас сроки.

На всех этапах разработки и производства наши партнеры могут получить квалифицированную поддержку опытных инженеров.

Система менеджмента качества компании отвечает требованиям в соответствии с ГОСТ Р ИСО 9001, ГОСТ РВ 0015-002 и ЭС РД 009

Офис по работе с юридическими лицами:

105318, г.Москва, ул.Щербаковская д.3, офис 1107, 1118, ДЦ «Щербаковский»

Телефон: +7 495 668-12-70 (многоканальный)

Факс: +7 495 668-12-70 (доб.304)

E-mail: info@moschip.ru

Skype отдела продаж:

moschip.ru

moschip.ru_4

moschip.ru_6

moschip.ru_9