

HF RoHS Fixed Voltage Series - DO-214



Agency Approvals

Agency	Agency File Number
	E133083

Pinout Designation

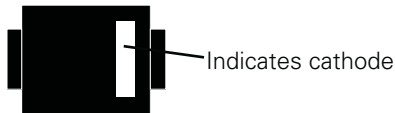

Schematic Symbol

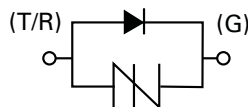

Description

Fixed Voltage Series DO-214 are uni-directional SIDACTor® devices designed to protect SLICs (Subscriber Line Interface Circuit) from damaging overvoltage transients.

The series provides single line protection using a fixed voltage switching device for negative surges. All positive surges are routed through an internal diode to a ground reference.

Features and Benefits

- Low voltage overshoot
- Low on-state voltage
- Does not degrade with use
- Fails short circuit when surged in excess of ratings
- Integrated diode for positive voltage surges

Applicable Global Standards

- TIA-968-A
- TIA-968-B
- ITU K.20/21 Enhanced Level
- ITU K.20/21 Basic Level
- GR 1089 Inter-building*
- GR 1089 Intra-building*
- IEC 61000-4-5
- YD/T 1082
- YD/T 993
- YD/T 950

*A-rated parts require series resistance

Electrical Characteristics

Part Number	Marking	V_{DRM}	V_S	I_H	I_S	I_T	V_T	V_F	Capacitance @ 1MHz, -2V bias	
		@ $I_{DRM} = 5\mu A$	@ 100V/ μs				@ $I_T = 2.2$ Amps		pF	
		V min	V max	mA min	mA max	A max	V max		V max	pF min
P0641SALRP	P61A	58	77	120	800	2.2	4	5	50	90
P0721SALRP	P71A	65	88	120	800	2.2	4	5	45	85
P0901SALRP	P91A	75	98	120	800	2.2	4	5	45	80
P1101SALRP	P01A	95	130	120	800	2.2	4	5	40	70
P1301SALRP	P131A	120	160	120	800	2.2	4	5	40	70
P1701SALRP	P17A	160	200	120	800	2.2	4	5	30	55
P0641SCLRP	P61C	58	77	120	800	2.2	4	5	65	200
P0721SCLRP	P71C	65	88	120	800	2.2	4	5	60	190
P0901SCLRP	P91C	75	98	120	800	2.2	4	5	60	180
P1101SCLRP	P01C	95	130	120	800	2.2	4	5	50	160
P1301SCLRP	P131C	120	160	120	800	2.2	4	5	50	160
P1701SCLRP	P17C	160	200	120	800	2.2	4	5	40	130

Notes:
- Absolute maximum ratings measured at $T_A = 25^\circ C$ (unless otherwise noted).
- Devices are uni-directional

Surge Ratings

Series	I_{PP}									I_{TSM} 50/60 Hz	di/dt
	0.2x310 ¹ 0.5x700 ²	2x10 ¹ 2x10 ²	8x20 ¹ 1.2x50 ²	10x160 ¹ 10x160 ²	10x560 ¹ 10x560 ²	5x320 ¹ 9x720 ²	10x360 ¹ 10x360 ²	10x1000 ¹ 10x1000 ²	5x310 ¹ 10x700 ²		
	A min	A min	A min	A min	A min	A min	A min	A min	A min		
A	20	150	150	90	50	75	75	45	75	20	500
C	50	500	400	200	150	200	175	100	200	30	500

Notes:

- 1 Current waveform in μs
- 2 Voltage waveform in μs
- Peak pulse current rating (I_{pp}) is repetitive and guaranteed for the life of the product.
- I_{pp} ratings applicable over temperature range of -40°C to +85°C
- The device must initially be in thermal equilibrium with -40°C $\leq T_J \leq$ +150°C

Thermal Considerations

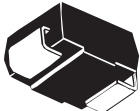
Package	Symbol	Parameter	Value	Unit
 DO-214AA	T_J	Operating Junction Temperature Range	-40 to +150	°C
	T_S	Storage Temperature Range	-65 to +150	°C
	$R_{\theta JA}$	Thermal Resistance: Junction to Ambient	90	°C/W

V-I Characteristics

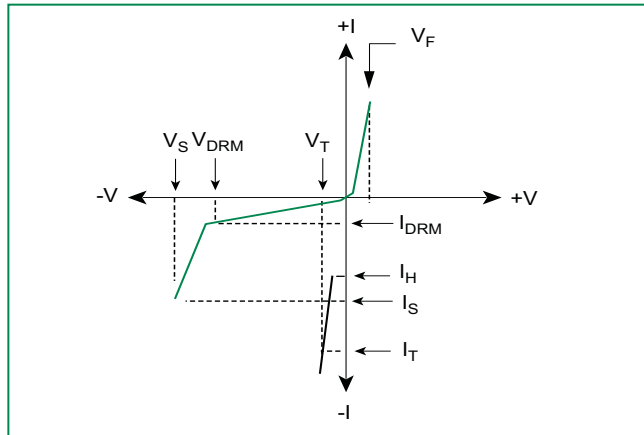

$t_r \times t_d$ Pulse Waveform

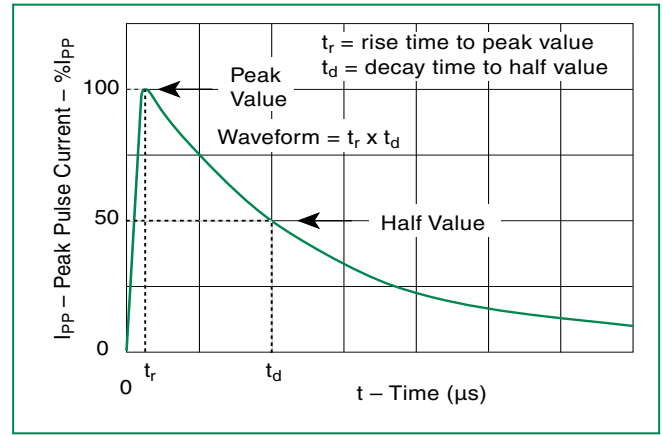

Normalized V_S Change vs. Junction Temperature

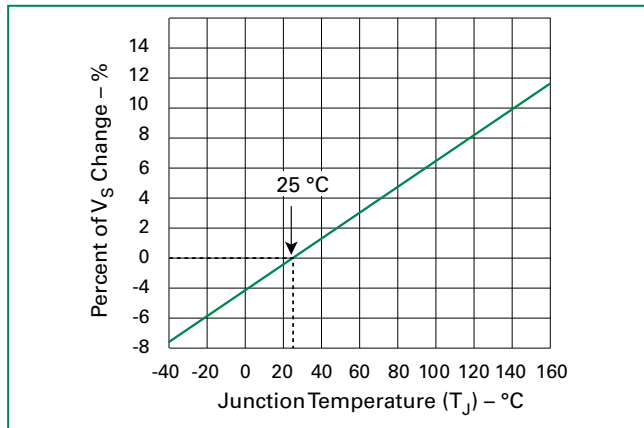

Normalized DC Holding Current vs. Case Temperature

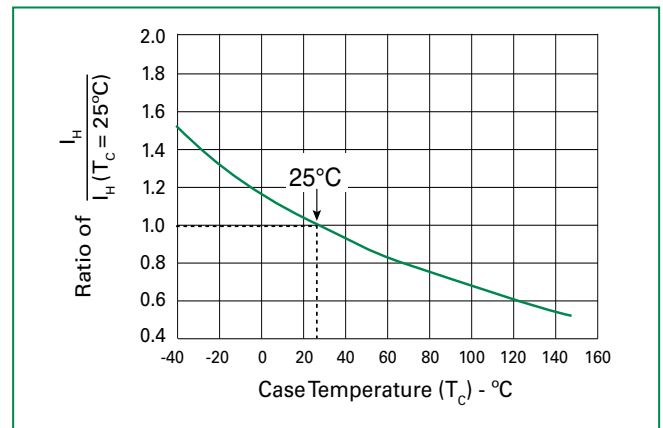

Soldering Parameters

Reflow Condition		Pb-Free assembly (see Fig. 1)
Pre Heat	-Temperature Min ($T_{s(min)}$)	+150°C
	-Temperature Max ($T_{s(max)}$)	+200°C
	-Time (Min to Max) (t_s)	60-180 secs.
Average ramp up rate (Liquidus Temp (T_L) to peak)		3°C/sec. Max.
$T_{s(max)}$ to T_L - Ramp-up Rate		3°C/sec. Max.
Reflow	-Temperature (T_L) (Liquidus)	+217°C
	-Temperature (t_L)	60-150 secs.
Peak Temp (T_p)		+260(+0/-5)°C
Time within 5°C of actual Peak Temp (t_p)		30 secs. Max.
Ramp-down Rate		6°C/sec. Max.
Time 25°C to Peak Temp (T_p)		8 min. Max.
Do not exceed		+260°C

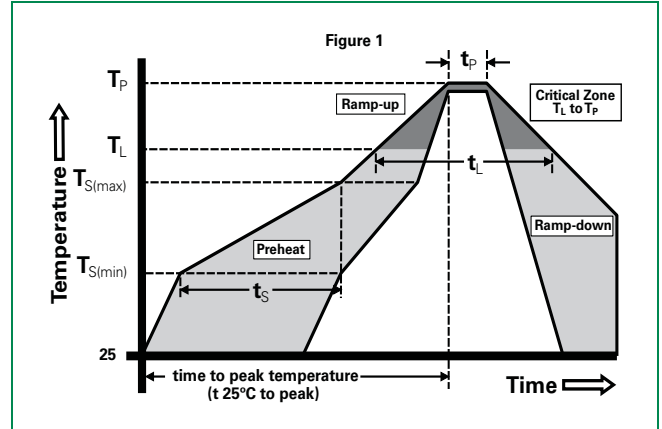

Physical Specifications

Lead Material	Copper Alloy
Terminal Finish	100% Matte-Tin Plated
Body Material	UL recognized epoxy meeting flammability classification 94V-0

Environmental Specifications

High Temp Voltage Blocking	80% Rated V_{DRM} (V_{AC} Peak) +125°C or +150°C, 504 or 1008 hrs. MIL-STD-750 (Method 1040) JEDEC, JESD22-A-101
Temp Cycling	-65°C to +150°C, 15 min. dwell, 10 up to 100 cycles. MIL-STD-750 (Method 1051) EIA/JEDEC, JESD22-A-104
Biased Temp & Humidity	52 V_{DC} (+85°C) 85%RH, 504 up to 1008 hrs. EIA/JEDEC, JESD22-A-101
High Temp Storage	+150°C 1008 hrs. MIL-STD-750 (Method 1031) JEDEC, JESD22-A-101
Low Temp Storage	-65°C, 1008 hrs.
Thermal Shock	0°C to +100°C, 5 min. dwell, 10 sec. transfer, 10 cycles. MIL-STD-750 (Method 1056) JEDEC, JESD22-A-106
Autoclave (Pressure Cooker Test)	+121°C, 100%RH, 2atm, 24 up to 168 hrs. EIA/JEDEC, JESD22-A-102
Resistance to Solder Heat	+260°C, 30 secs. MIL-STD-750 (Method 2031)
Moisture Sensitivity Level	85%RH, +85°C, 168 hrs., 3 reflow cycles (+260°C Peak). JEDEC-J-STD-020, Level 1

Part Numbering

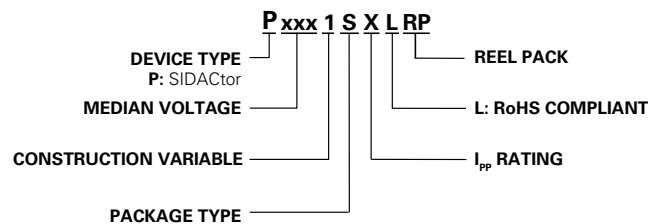

Part Marking

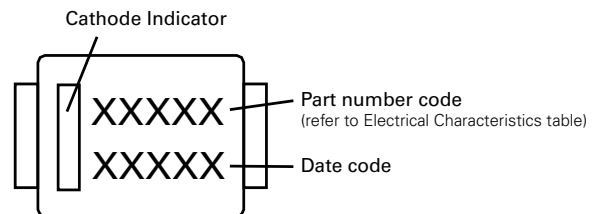

Dimensions — DO-214AA

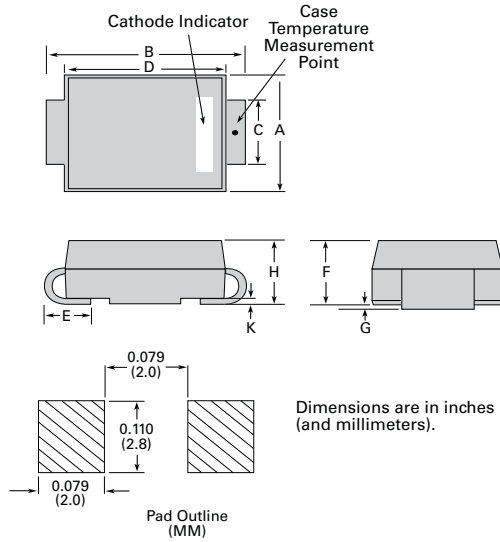

Dimensions	Inches		Millimeters	
	Min	Max	Min	Max
A	0.130	0.156	3.30	3.95
B	0.201	0.220	5.10	5.60
C	0.077	0.087	1.95	2.20
D	0.159	0.181	4.05	4.60
E	0.030	0.063	0.75	1.60
F	0.075	0.096	1.90	2.45
G	0.002	0.008	0.05	0.20
H	0.077	0.104	1.95	2.65
K	0.006	0.016	0.15	0.41

Dimensions are in inches (and millimeters).

Packing Options

Package Type	Description	Quantity	Added Suffix	Industry Standard
S	DO-214AA Tape & Reel Pack	2500	RP	EIA-481-D

Tape and Reel Specification — DO-214AA

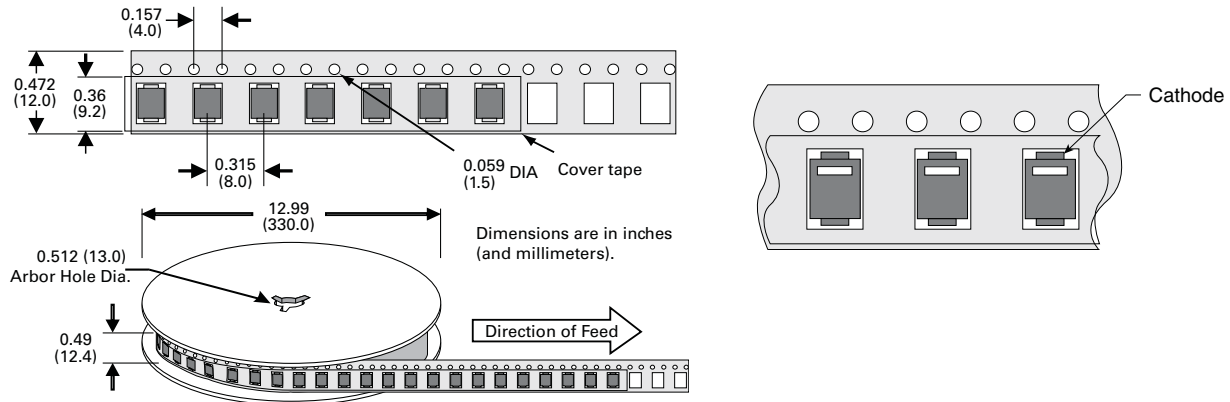

Данный компонент на территории Российской Федерации

Вы можете приобрести в компании MosChip.

Для оперативного оформления запроса Вам необходимо перейти по данной ссылке:

<http://moschip.ru/get-element>

Вы можете разместить у нас заказ для любого Вашего проекта, будь то серийное производство или разработка единичного прибора.

В нашем ассортименте представлены ведущие мировые производители активных и пассивных электронных компонентов.

Нашей специализацией является поставка электронной компонентной базы двойного назначения, продукции таких производителей как XILINX, Intel (ex.ALTERA), Vicor, Microchip, Texas Instruments, Analog Devices, Mini-Circuits, Amphenol, Glenair.

Сотрудничество с глобальными дистрибьюторами электронных компонентов, предоставляет возможность заказывать и получать с международных складов практически любой перечень компонентов в оптимальные для Вас сроки.

На всех этапах разработки и производства наши партнеры могут получить квалифицированную поддержку опытных инженеров.

Система менеджмента качества компании отвечает требованиям в соответствии с ГОСТ Р ИСО 9001, ГОСТ РВ 0015-002 и ЭС РД 009

Офис по работе с юридическими лицами:

105318, г.Москва, ул.Щербаковская д.3, офис 1107, 1118, ДЦ «Щербаковский»

Телефон: +7 495 668-12-70 (многоканальный)

Факс: +7 495 668-12-70 (доб.304)

E-mail: info@moschip.ru

Skype отдела продаж:

moschip.ru

moschip.ru_4

moschip.ru_6

moschip.ru_9