

300 mA low quiescent current very low noise LDO (automotive for SOT23-5L package)

Datasheet - production data

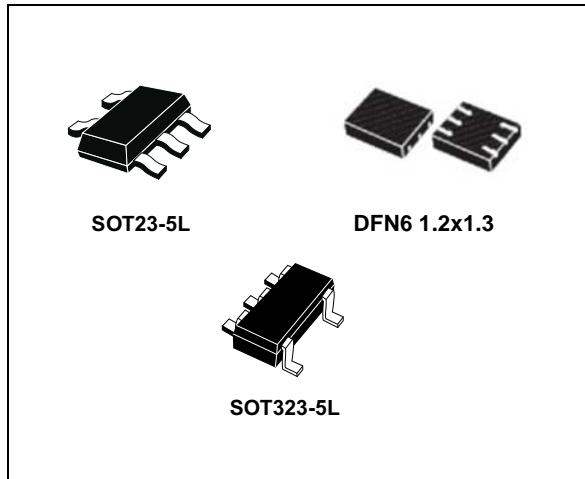

Applications

- Mobile phones
- Portable consumer and industrial devices
- Cordless phones and similar battery-powered systems
- Automotive P.O.L.
- A.D.A.S.

Description

The LDK130 low drop voltage regulator provides 300 mA of maximum current from an input supply voltage in the range of 1.9 V to 5.5 V, with a typical dropout voltage of 100 mV.

It is stabilized with a ceramic capacitor on the output.

The very low drop voltage, low quiescent current and low-noise features make it suitable for low-power battery-powered applications.

An enable logic control function puts the LDK130 in shutdown mode allowing a total current consumption lower than 1 μ A.

The device also includes short-circuit constant current limiting and thermal protection.

Features



- AEC-Q100 qualified (automotive grade 1, SOT23-5L package)
- Input voltage from 1.9 to 5.5 V
- Very low-dropout voltage (100 mV typ. at 100 mA load)
- Low quiescent current (typ. 30 μ A, 1 μ A in OFF mode)
- Very low noise
- Output voltage tolerance: $\pm 2.0\%$ at 25 $^{\circ}$ C
- 300 mA guaranteed output current
- Wide range of fixed output voltages available on request: from 0.8 V to 3.5 V with 100 mV step
- Adjustable version: from 0.8 V to $V_{IN} - V_{drop}$
- Logic-controlled electronic shutdown
- Compatible with ceramic capacitor $C_{OUT} = 1 \mu$ F
- Internal current and thermal limit
- Available in SOT23-5L, SOT323-5L and DFN6 1.2x1.3 packages
- Temperature range: -40 $^{\circ}$ C to 125 $^{\circ}$ C

Contents

1	Block diagram	5
2	Pin configuration	6
3	Typical application	7
4	Maximum ratings	8
5	Electrical characteristics	9
6	Typical performance characteristics	11
7	Package information	17
	7.1 SOT23-5L package information	17
	7.2 DFN6 1.2 x 1.3 package information	19
	7.3 SOT323-5L package information	21
	7.4 Packing information	23
	7.5 SOT23-5L and SOT323-5L packing information	23
8	Order code	25
9	Revision history	26

List of tables

Table 1.	Pin description (SOT23-5L, SOT323-5L)	6
Table 2.	Absolute maximum ratings	8
Table 3.	Thermal data	8
Table 4.	Electrical characteristics for LDK130 (fixed version).	9
Table 5.	Electrical characteristics for LDK130 (adjustable version)	10
Table 6.	SOT23-5L package mechanical data	18
Table 7.	DFN6 1.2 x 1.3 package mechanical data	20
Table 8.	SOT323-5L mechanical data	22
Table 9.	SOT23-5L tape and reel mechanical data	24
Table 10.	SOT323-5L tape and reel mechanical data	24
Table 11.	Order code	25
Table 12.	Marking	25
Table 13.	Document revision history	26

List of figures

Figure 1.	Block diagram	5
Figure 2.	Pin connections (top view)	6
Figure 3.	Typical application circuits for fixed version	7
Figure 4.	Typical application circuits for adjustable version	7
Figure 5.	Output voltage vs. temp. for adjustable ($I_O = 1 \text{ mA}$)	11
Figure 6.	Output voltage vs. temp. for adjustable version ($I_O = 300 \text{ mA}$)	11
Figure 7.	Output voltage vs. temp. for fixed version ($I_O = 1 \text{ mA}$)	11
Figure 8.	Output voltage vs. temp. for fixed version ($I_O = 300 \text{ mA}$)	11
Figure 9.	Line regulation vs. temp. for adjustable version	12
Figure 10.	Short-circuit current vs. temp. for adjustable version	12
Figure 11.	Load regulation vs. temp. for adjustable version	12
Figure 12.	Load regulation vs. temp. for fixed version	12
Figure 13.	Enable pin thresholds vs. temp. ($V_{IN} = 1.9 \text{ V}$)	12
Figure 14.	Enable pin thresholds vs. temp.	12
Figure 15.	Quiescent current vs. temp. for adjustable version ($I_O = 0 \text{ mA}$)	13
Figure 16.	Quiescent current vs. temp. for adjustable version ($I_O = 300 \text{ mA}$)	13
Figure 17.	Quiescent current vs. temp. for fixed version ($I_O = 0 \text{ mA}$)	13
Figure 18.	Quiescent current vs. temp. for fixed version ($I_O = 300 \text{ mA}$)	13
Figure 19.	Shutdown current vs. temperature	13
Figure 20.	SVR vs. frequency ($V_O = 2.5 \text{ V}$)	13
Figure 21.	SVR vs. frequency ($V_O = V_{ADJ}$)	14
Figure 22.	Output noise vs. frequency ($V_O = 3.3 \text{ V}$)	14
Figure 23.	Output noise vs. frequency ($V_O = V_{ADJ}$)	14
Figure 24.	Stability region vs. C_{OUT} (fixed)	14
Figure 25.	Stability region vs C_{OUT} (adjust.)	14
Figure 26.	Line transient ($V_{OUT} = V_{ADJ}$)	14
Figure 27.	Line transient ($V_{OUT} = 3 \text{ V}$)	15
Figure 28.	Load transient ($V_{OUT} = 3 \text{ V}$)	15
Figure 29.	Load transient ($V_{OUT} = V_{ADJ}$)	15
Figure 30.	Startup transient	15
Figure 31.	Enable transient ($V_{OUT} = V_{ADJ}$)	16
Figure 32.	Enable transient ($V_{OUT} = 3 \text{ V}$)	16
Figure 33.	Dropout voltage vs. temperature ($I_{OUT} = 100 \text{ mA}$)	16
Figure 34.	Dropout voltage vs. temperature ($I_{OUT} = 300 \text{ mA}$)	16
Figure 35.	SOT23-5L package outline	17
Figure 36.	SOT23-5L footprint (dimensions in mm)	18
Figure 37.	DFN6 1.2 x 1.3 package outline	19
Figure 38.	DFN6 1.2 x 1.3 recommended footprint (dimensions in mm)	20
Figure 39.	SOT323-5L package outline	21
Figure 40.	SOT23-5L and SOT323-5L tape and reel outline	23

1 Block diagram

Figure 1. Block diagram

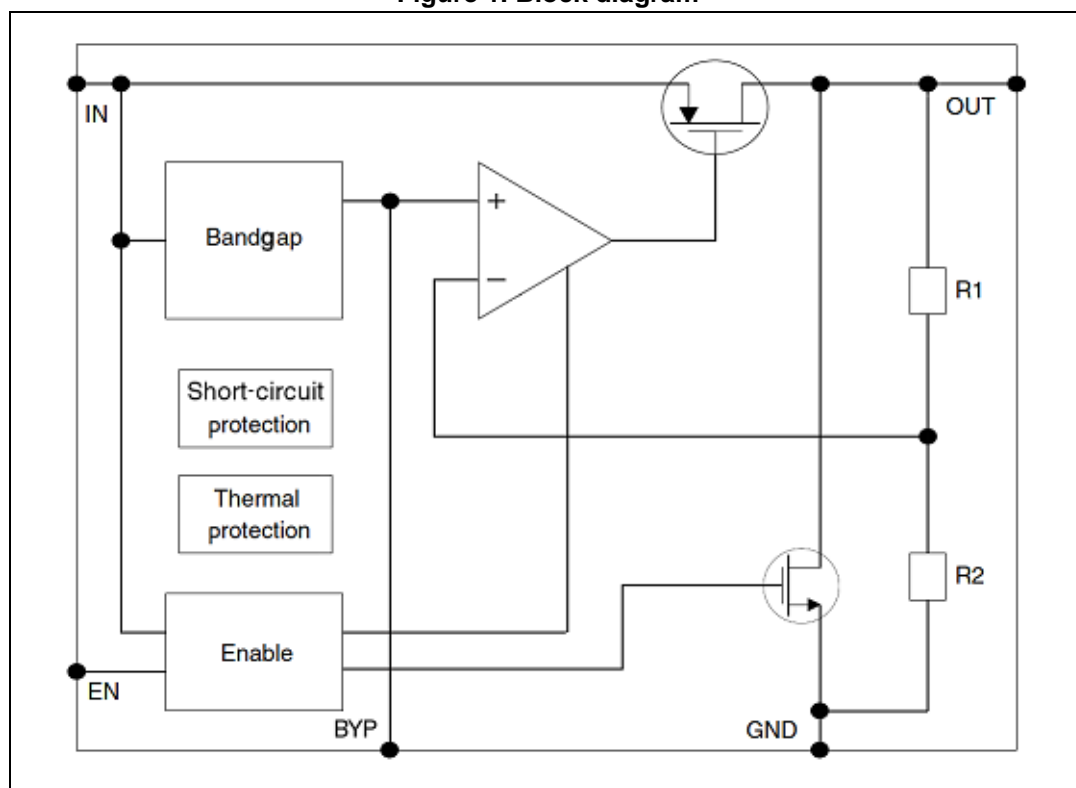

2 Pin configuration

Figure 2. Pin connections (top view)

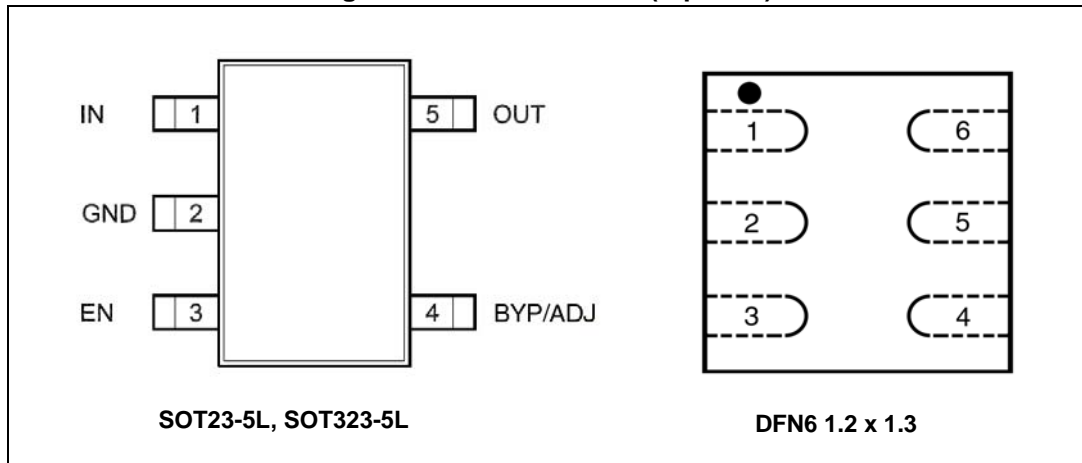

Table 1. Pin description (SOT23-5L, SOT323-5L)

Pin		Symbol	Function
SOT23/ SOT323	DFN6		
1	6	IN	Input voltage of the LDO
2	2	GND	Common ground
3	4	EN	Enable pin logic input: low = shutdown, high = active
4	3	BYP ⁽¹⁾ /ADJ	Bypass capacitor on fixed versions, adjustable pin on ADJ versions
5	1	OUT	Output voltage of the LDO
-	5	N/C	Not connected. This pin should be connected to GND

1. Bypass capacitor for noise reduction on fixed version is optional, if not used the relevant pin must be left floating with no routing on the board.

3 Typical application

Figure 3. Typical application circuits for fixed version

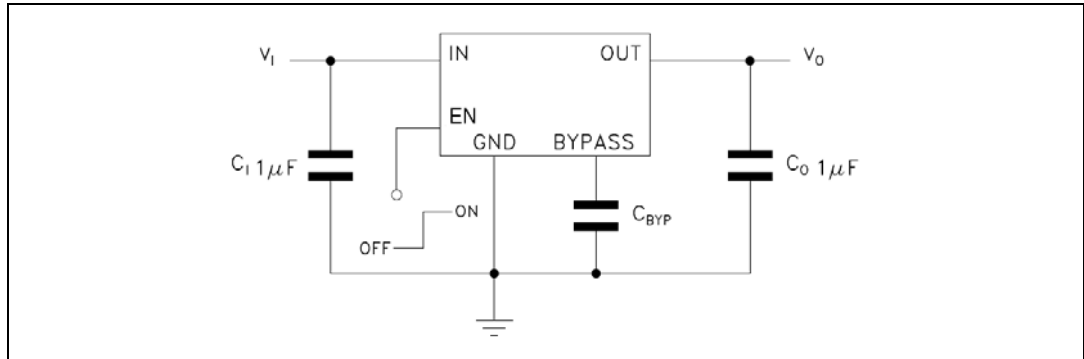
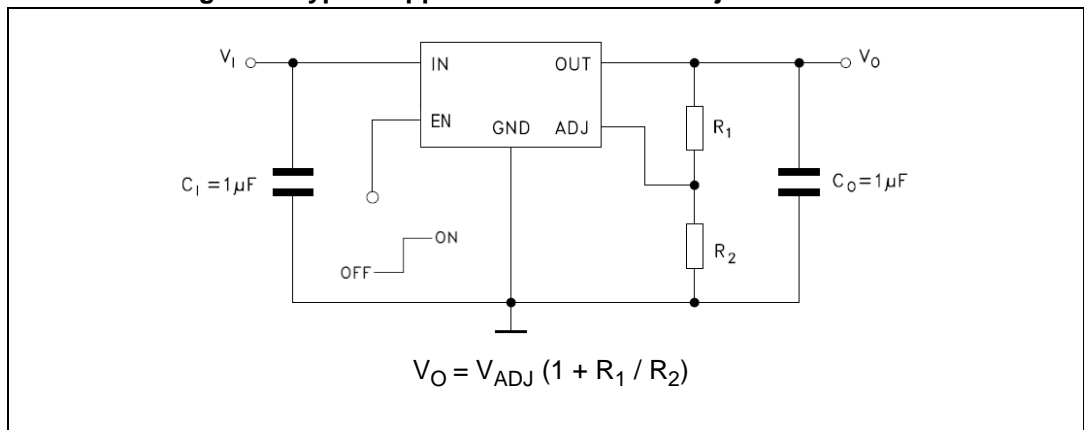

Figure 4. Typical application circuits for adjustable version



4 Maximum ratings

Table 2. Absolute maximum ratings

Symbol	Parameter	Value	Unit
V_{IN}	DC input voltage	- 0.3 to 7	V
V_{OUT}	DC output voltage	- 0.3 to $V_I + 0.3$	V
V_{EN}	Enable input voltage	- 0.3 to $V_I + 0.3$	V
$V_{BYP/ADJ}$	ADJ/bypass pin voltage	2	V
I_{OUT}	Output current	Internally limited	mA
P_D	Power dissipation	Internally limited	mW
T_{STG}	Storage temperature range	- 65 to 150	°C
T_{OP}	Operating junction temperature range	- 40 to 125	°C

Note: Absolute maximum ratings are those values beyond which damage to the device may occur. Functional operation under these conditions is not implied. All values are referred to GND.

Table 3. Thermal data

Symbol	Parameter	SOT23-5L	SOT323-5L	DFN6	Unit
R_{thJA}	Thermal resistance junction ambient	160	246	237	°C/W
R_{thJC}	Thermal resistance junction case	68	134	104	°C/W

5 Electrical characteristics

$T_J = 25\text{ °C}$, $V_{IN} = V_{OUT(NOM)} + 1\text{ V}$, $C_{IN} = C_{OUT} = 1\text{ }\mu\text{F}$, $I_{OUT} = 1\text{ mA}$, $V_{EN} = V_{IN}$, unless otherwise specified.

Table 4. Electrical characteristics for LDK130 (fixed version)

Symbol	Parameter	Test conditions	Min.	Typ.	Max.	Unit
V_{IN}	Operating input voltage	-	1.9	-	5.5	V
V_{OUT}	V_{OUT} accuracy	$I_{OUT} = 1\text{ mA}$, $T_J = 25\text{ °C}$	-2.0	-	2.0	%
		$I_{OUT} = 1\text{ mA}$, $-40\text{ °C} < T_J < 125\text{ °C}$	-3.0	-	3.0	%
ΔV_{OUT}	Static line regulation	$V_{OUT} + 1\text{ V} \leq V_{IN} \leq 5.5\text{ V}$, $I_{OUT} = 1\text{ mA}$	-	0.05	-	%/V
ΔV_{OUT}	Static load regulation	$I_{OUT} = 1\text{ mA}$ to 300 mA	-	0.006	-	%/mA
V_{DROP}	Dropout voltage ⁽¹⁾	$I_{OUT} = 100\text{ mA}$, $V_{OUT} = 2.5\text{ V}$	-	100	-	mV
		$I_{OUT} = 300\text{ mA}$, $V_{OUT} = 2.5\text{ V}$ $40\text{ °C} < T_J < 125\text{ °C}$	-	200	400	
e_N	Output noise voltage	10 Hz to 100 kHz, $I_{OUT} = 10\text{ mA}$, $V_{OUT} = 2.5\text{ V}$, $C_{BYP} = 10\text{ nF}$	-	51	-	$\mu\text{V}_{RMS}/\text{V}$
SVR	Supply voltage rejection	$V_{IN} = V_{OUTNOM} + 0.5\text{ V} \pm V_{RIPPLE}$ $V_{RIPPLE} = 0.1\text{ V}$ freq. = 120 Hz to 10 kHz $I_{OUT} = 10\text{ mA}$	-	55	-	dB
I_Q	Quiescent current	$I_{OUT} = 0\text{ mA}$, $-40\text{ °C} < T_J < 125\text{ °C}$	-	30	60	μA
		$I_{OUT} = 300\text{ mA}$, $-40\text{ °C} < T_J < 125\text{ °C}$	-	70	120	
		V_{IN} input current in OFF mode: $V_{EN} = \text{GND}$	-	-	1	
I_{SC}	Short-circuit current	$R_L = 0$	-	450	-	mA
V_{EN}	Enable input logic low	$V_{IN} = 1.9\text{ V}$ to 5.5 V , $-40\text{ °C} < T_J < 125\text{ °C}$	-	-	0.4	V
	Enable input logic high	$V_{IN} = 1.9\text{ V}$ to 5.5 V , $-40\text{ °C} < T_J < 125\text{ °C}$	1.2	-		
I_{EN}	Enable pin input current	$V_{SHDN} = V_{IN}$	-	-	100	nA
T_{SHDN}	Thermal shutdown	-	-	160	-	$^{\circ}\text{C}$
	Hysteresis	-	-	20	-	
C_{OUT}	Output capacitor	Capacitance (see Section 6: Typical performance characteristics)	1	-	22	μF

1. Dropout voltage is the input-to-output voltage difference at which the output voltage is 100 mV below its nominal value.

$T_J = 25\text{ °C}$, $V_{IN} = V_{OUT(NOM)} + 1\text{ V}$, $C_{IN} = C_{OUT} = 1\text{ }\mu\text{F}$, $I_{OUT} = 1\text{ mA}$, $V_{EN} = V_{IN}$, unless otherwise specified.

Table 5. Electrical characteristics for LDK130 (adjustable version)

Symbol	Parameter	Test conditions	Min.	Typ.	Max.	Unit
V_{IN}	Operating input voltage		1.9	-	5.5	V
V_{ADJ}	V_{ADJ} accuracy	$I_{OUT} = 1\text{ mA}$, $T_J = 25\text{ °C}$	784	800	816	mV
		$I_{OUT} = 1\text{ mA}$, $-40\text{ °C} < T_J < 125\text{ °C}$	-3.0		3.0	%
ΔV_{OUT}	Static line regulation	$V_{OUT} + 1\text{ V} \leq V_{IN} \leq 5.5\text{ V}$, $I_{OUT} = 1\text{ mA}$	-	0.05	-	%/V
ΔV_{OUT}	Static load regulation	$I_{OUT} = 1\text{ mA}$ to 300 mA	-	0.006	-	%/mA
V_{DROP}	Dropout voltage ⁽¹⁾	$I_{OUT} = 100\text{ mA}$, $V_{OUT} = 2.5\text{ V}$	-	100	-	mV
		$I_{OUT} = 300\text{ mA}$, $V_{OUT} = 2.5\text{ V}$ $40\text{ °C} < T_J < 125\text{ °C}$	-	200	400	
e_N	Output noise voltage	10 Hz to 100 kHz, $I_{OUT} = 10\text{ mA}$	-	130	-	$\mu\text{V}_{RMS}/\text{V}$
I_{ADJ}	Adjust pin current	-	-		1	μA
SVR	Supply voltage rejection	$V_{IN} = V_{OUTNOM} + 0.5\text{ V} \pm V_{RIPPLE}$ $V_{RIPPLE} = 0.1\text{ V}$ freq. = 120 Hz to 10 kHz $I_{OUT} = 10\text{ mA}$	-	55		dB
I_Q	Quiescent current	$I_{OUT} = 0\text{ mA}$, $-40\text{ °C} < T_J < 125\text{ °C}$	-	30	60	μA
		$I_{OUT} = 300\text{ mA}$, $-40\text{ °C} < T_J < 125\text{ °C}$	-	70	120	
		V_{IN} input current in OFF mode: $V_{EN} = \text{GND}$	-	-	1	
I_{SC}	Short-circuit current	$R_L = 0$	-	450	-	mA
V_{EN}	Enable input logic low	$V_{IN} = 1.9\text{ V}$ to 5.5 V, $-40\text{ °C} < T_J < 125\text{ °C}$	-	-	0.4	V
	Enable input logic high	$V_{IN} = 1.9\text{ V}$ to 5.5 V, $-40\text{ °C} < T_J < 125\text{ °C}$	1.2	-	-	
I_{EN}	Enable pin input current	$V_{SHDN} = V_{IN}$	-		100	nA
T_{SHDN}	Thermal shutdown	-	-	160	-	$^{\circ}\text{C}$
	Hysteresis	-	-	20	-	
C_{OUT}	Output capacitor	Capacitance (see Section 6: Typical performance characteristics)	1		22	μF

1. Dropout voltage is the input-to-output voltage difference at which the output voltage is 100 mV below its nominal value.

6 Typical performance characteristics

$C_{IN} = C_{OUT} = 1 \mu F$, V_{EN} to V_{IN} , unless otherwise specified.

Figure 5. Output voltage vs. temp. for adjustable ($I_O = 1 \text{ mA}$)

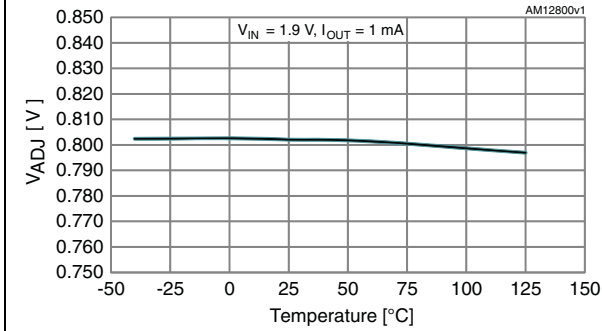

Figure 6. Output voltage vs. temp. for adjustable version ($I_O = 300 \text{ mA}$)

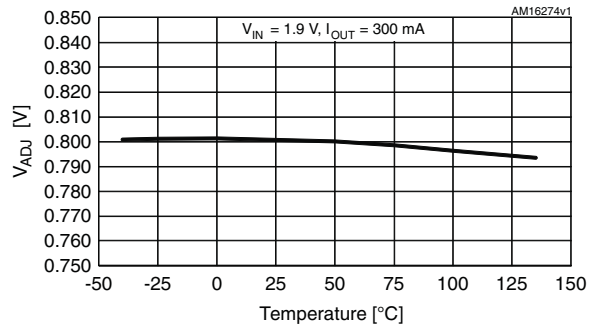

Figure 7. Output voltage vs. temp. for fixed version ($I_O = 1 \text{ mA}$)

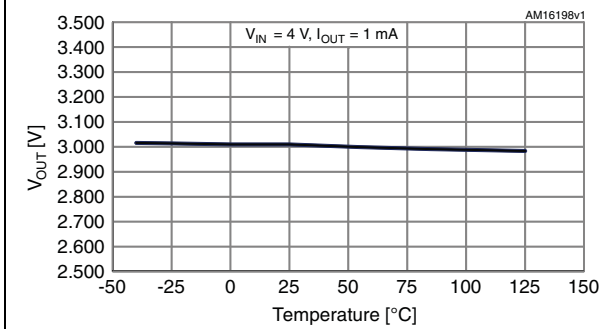
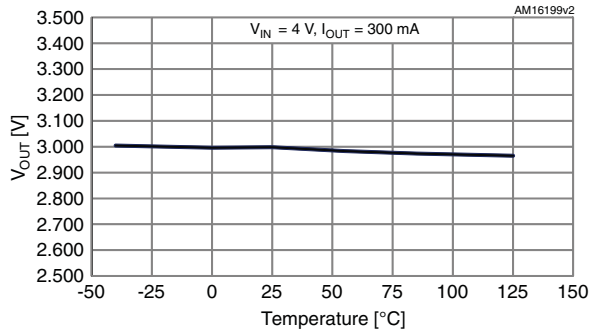

Figure 8. Output voltage vs. temp. for fixed version ($I_O = 300 \text{ mA}$)



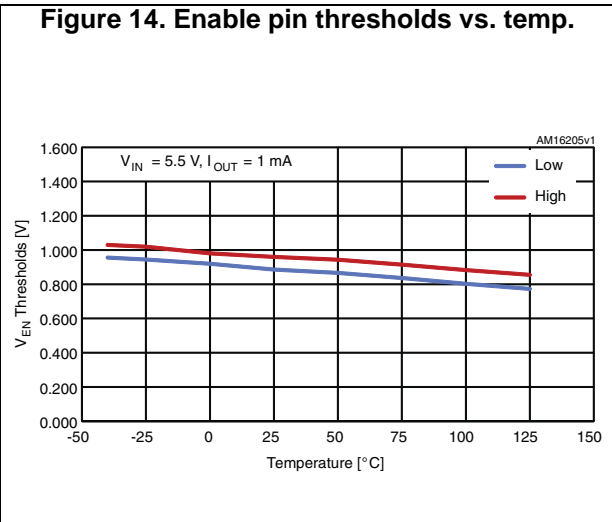
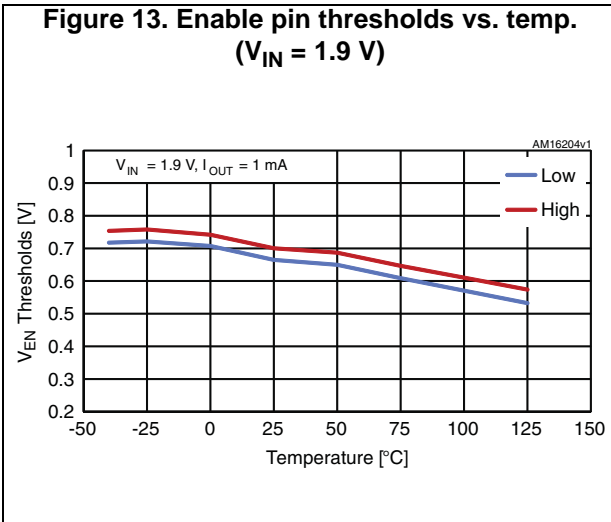
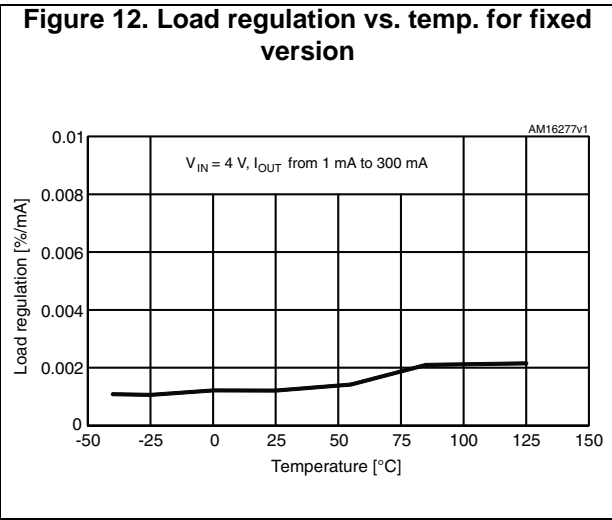
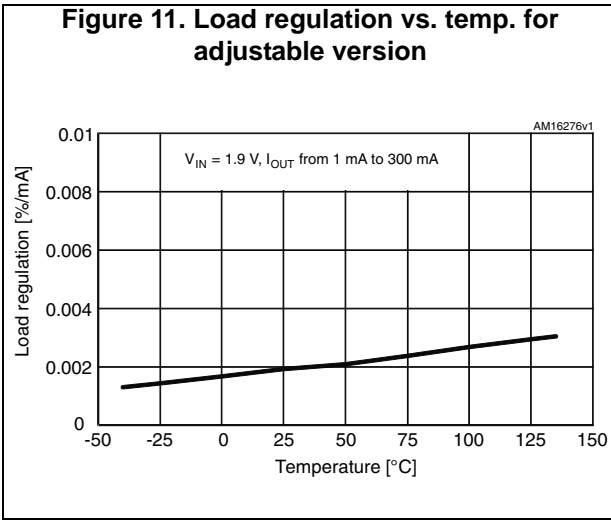
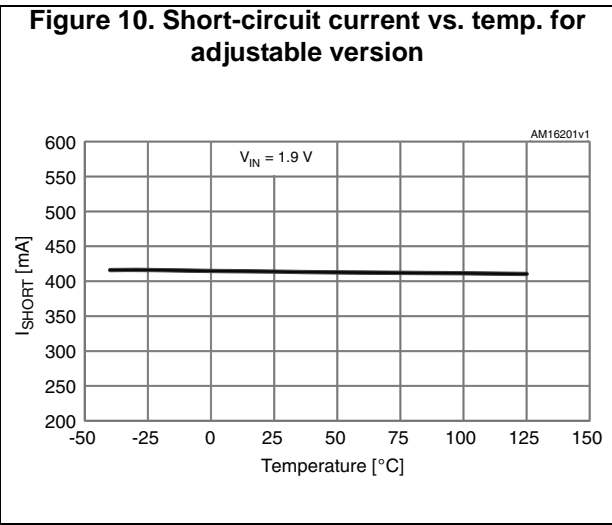
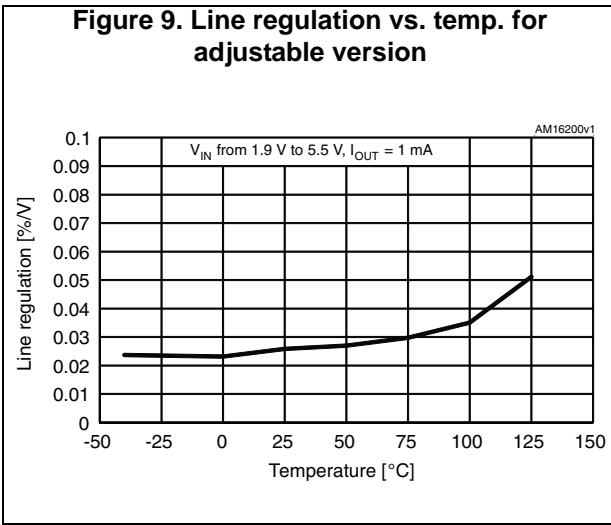

Figure 15. Quiescent current vs. temp. for adjustable version ($I_O = 0$ mA)

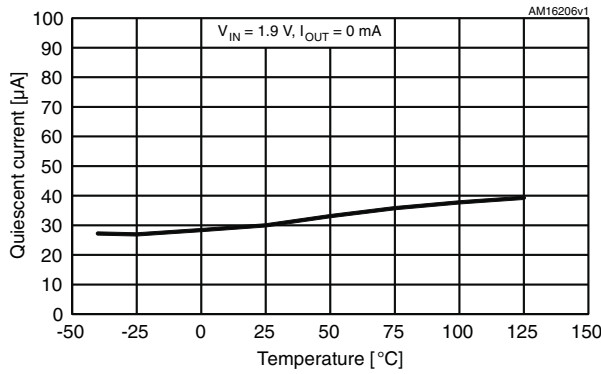

Figure 16. Quiescent current vs. temp. for adjustable version ($I_O = 300$ mA)

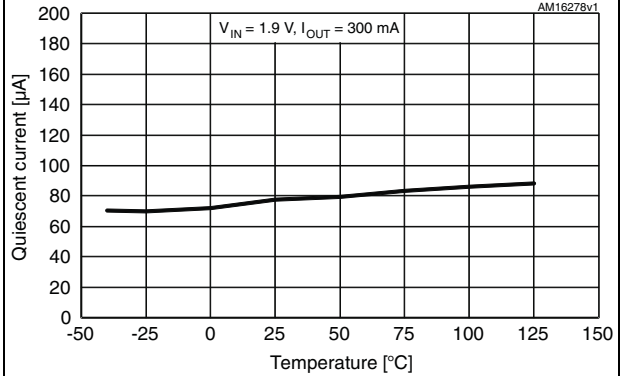

Figure 17. Quiescent current vs. temp. for fixed version ($I_O = 0$ mA)

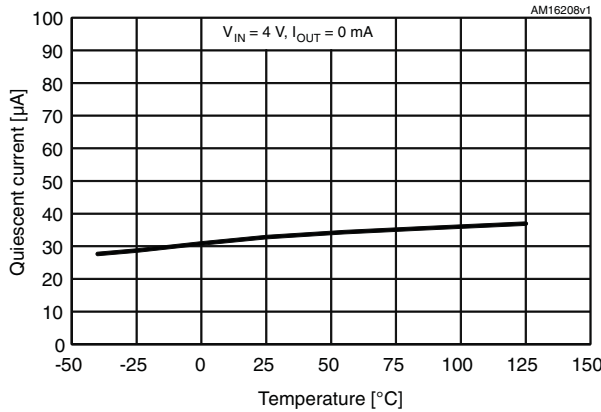

Figure 18. Quiescent current vs. temp. for fixed version ($I_O = 300$ mA)

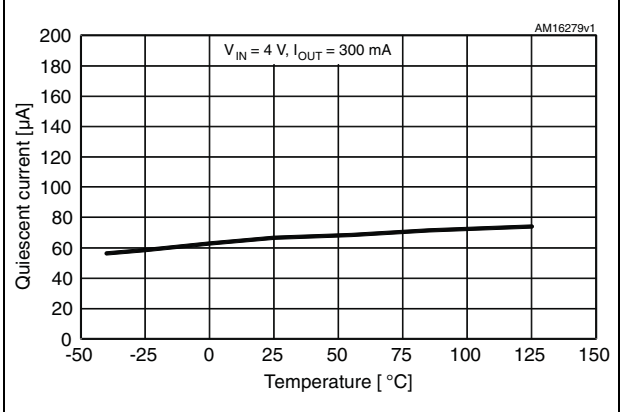

Figure 19. Shutdown current vs. temperature

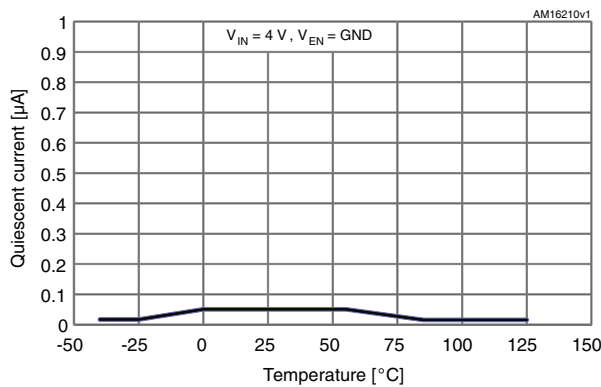
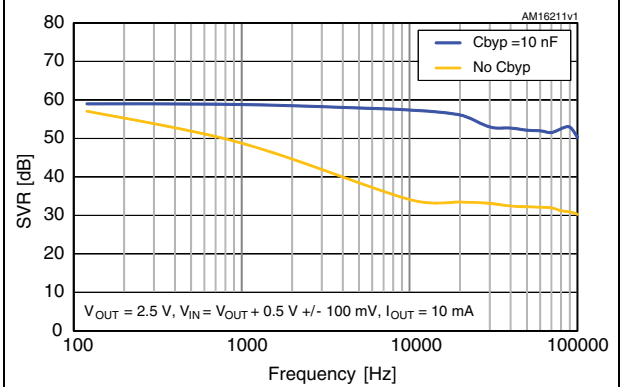

Figure 20. SVR vs. frequency ($V_O = 2.5$ V)



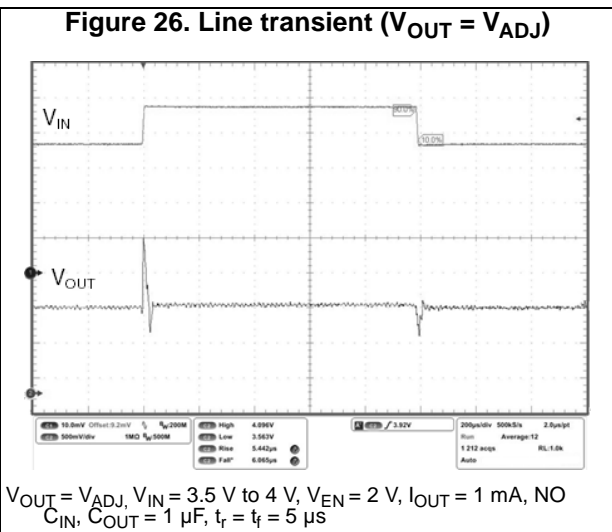
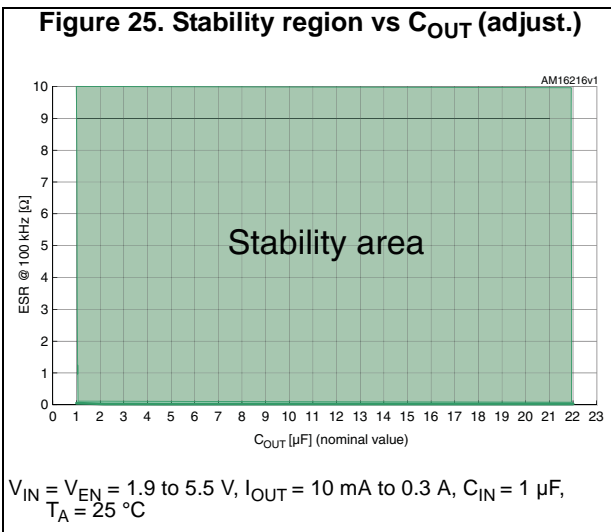
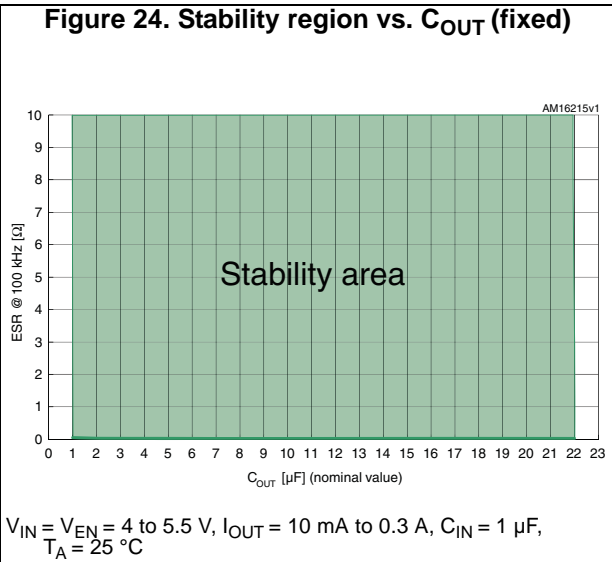
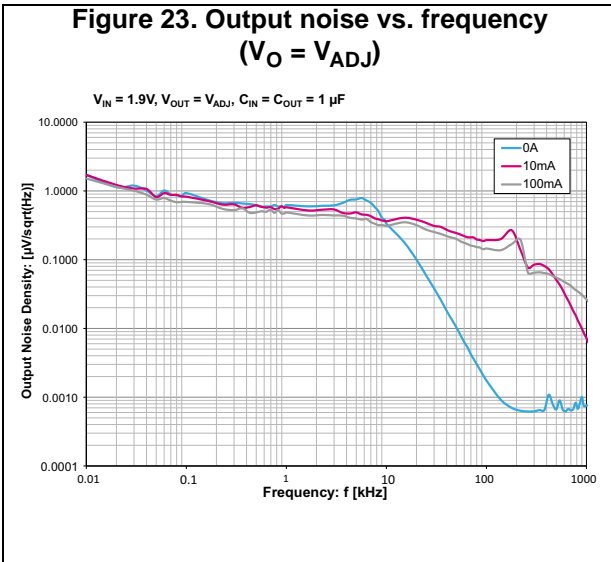
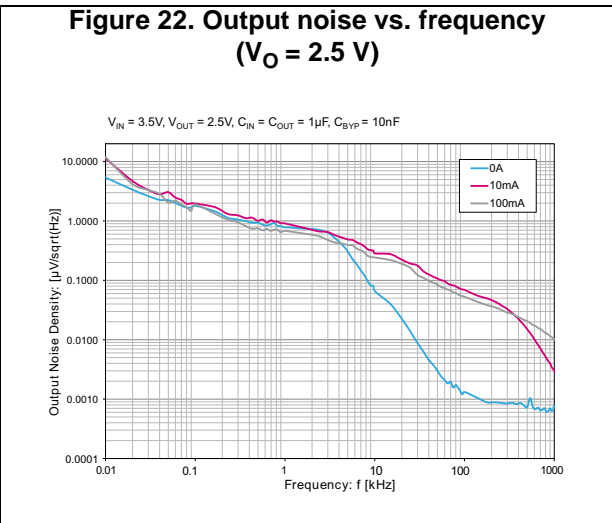
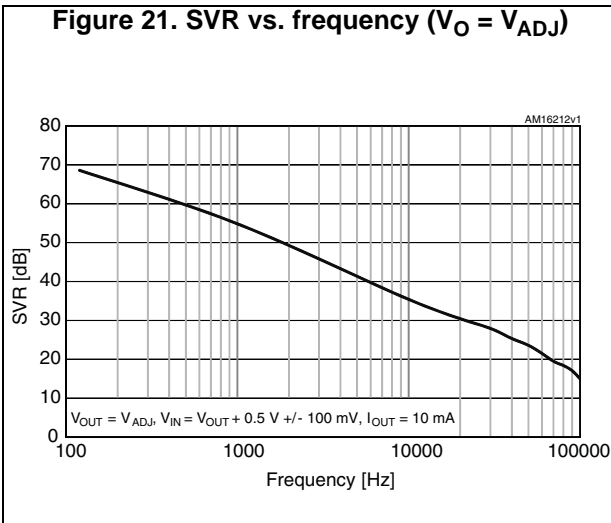
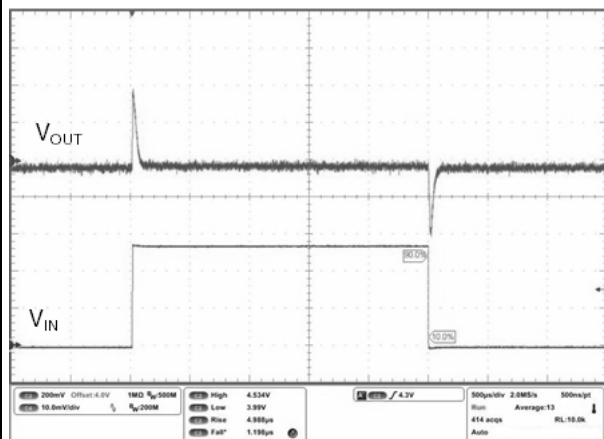
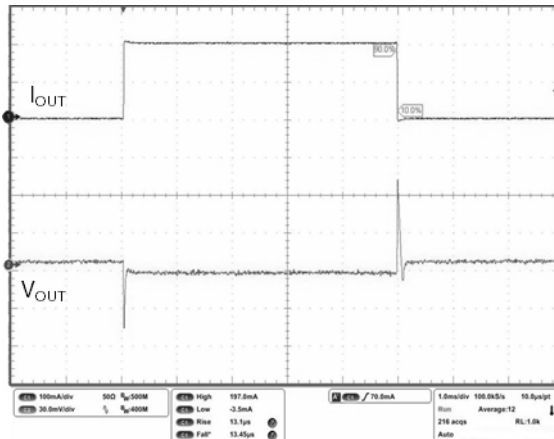

Figure 27. Line transient ($V_{OUT} = 3\text{ V}$)



$V_{OUT} = 3\text{ V}$, $V_{IN} = 4\text{ V}$ to 4.5 V , $V_{EN} = 2\text{ V}$, $I_{OUT} = 1\text{ mA}$, NO C_{IN} , $C_{OUT} = 1\text{ }\mu\text{F}$, $t_r = t_f = 5\text{ }\mu\text{s}$

Figure 28. Load transient ($V_{OUT} = 3\text{ V}$)



$V_{OUT} = 3\text{ V}$, $V_{IN} = V_{EN} = 3.5\text{ V}$, $I_{OUT} = 1\text{ mA}$ to 200 mA , $C_{OUT} = 1\text{ }\mu\text{F}$, $t_r = t_f = 5\text{ }\mu\text{s}$

Figure 29. Load transient ($V_{OUT} = V_{ADJ}$)

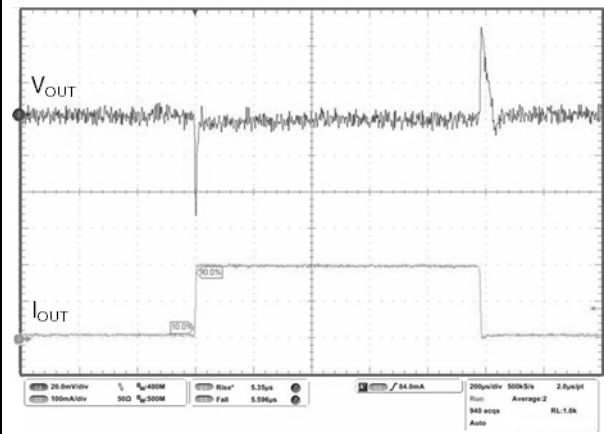

$V_{OUT} = V_{ADJ}$, $V_{IN} = V_{EN} = 3.5\text{ V}$, $I_{OUT} = 1\text{ mA}$ to 200 mA , $C_{OUT} = 1\text{ }\mu\text{F}$, $t_r = t_f = 5\text{ }\mu\text{s}$

Figure 30. Startup transient

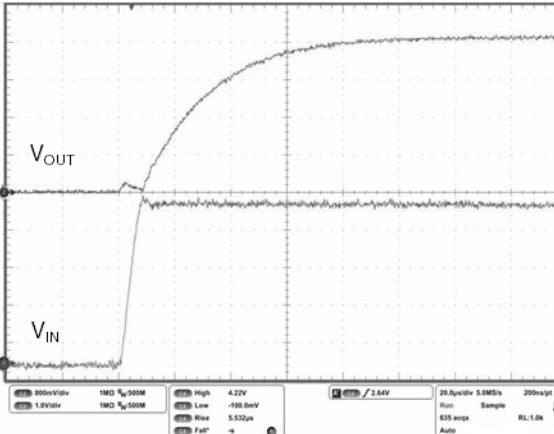

$V_{OUT} = 3\text{ V}$, $V_{IN} = V_{EN} = 0$ to 4.2 V , $I_{OUT} = 1\text{ mA}$, $C_{IN} = C_{OUT} = 1\text{ }\mu\text{F}$, $t_r = t_f = 5\text{ }\mu\text{s}$

Figure 31. Enable transient ($V_{OUT} = V_{ADJ}$)

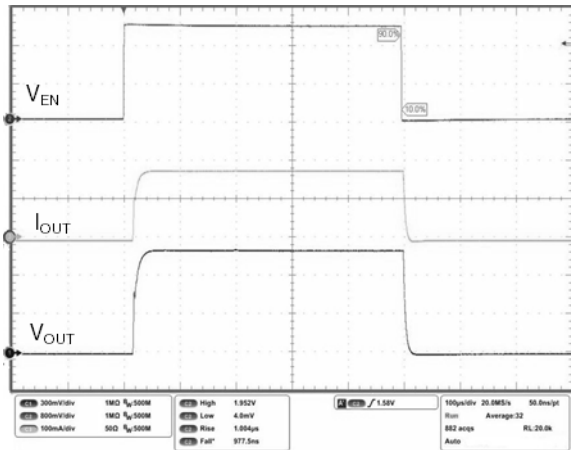

V_{OUT} at 0.8 V, $V_{IN} = 1.9$, $V_{EN} = 0$ to V_{IN} , $I_{OUT} = 200$ mA, $C_{OUT} = 1 \mu\text{F}$, $t_r = t_f = 1 \mu\text{s}$

Figure 32. Enable transient ($V_{OUT} = 3$ V)

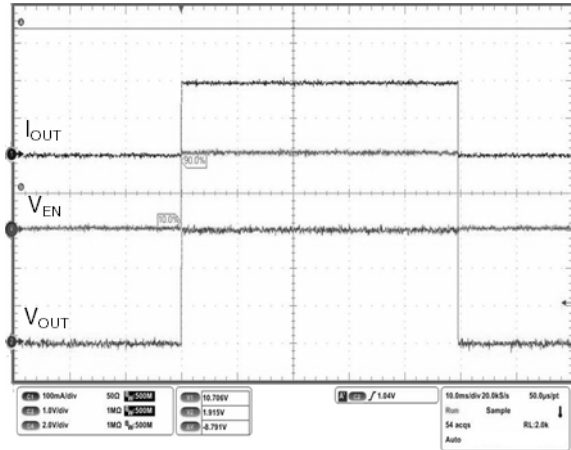

$V_{IN} = 4$ V, $V_{EN} = 0$ to V_{IN} , $I_{OUT} = 200$ mA, $C_{IN} = C_{OUT} = 1 \mu\text{F}$, $t_r = t_f = 1 \mu\text{s}$

Figure 33. Dropout voltage vs. temperature ($I_{OUT} = 100$ mA)

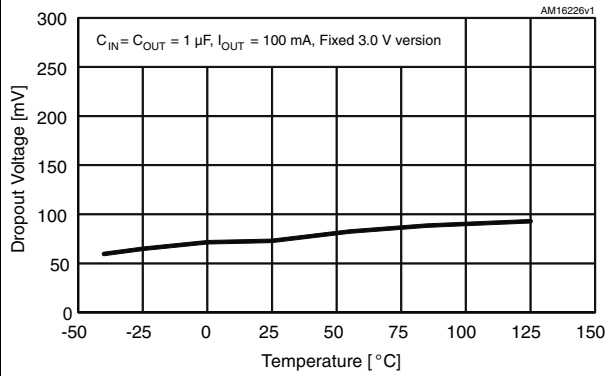
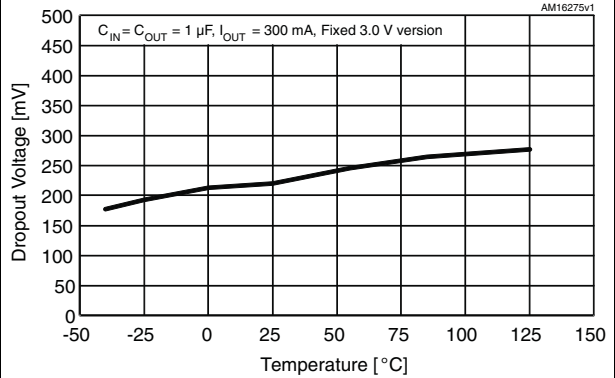

Figure 34. Dropout voltage vs. temperature ($I_{OUT} = 300$ mA)



7 Package information

In order to meet environmental requirements, ST offers these devices in different grades of ECOPACK[®] packages, depending on their level of environmental compliance. ECOPACK specifications, grade definitions and product status are available at: www.st.com. ECOPACK is an ST trademark.

7.1 SOT23-5L package information

Figure 35. SOT23-5L package outline

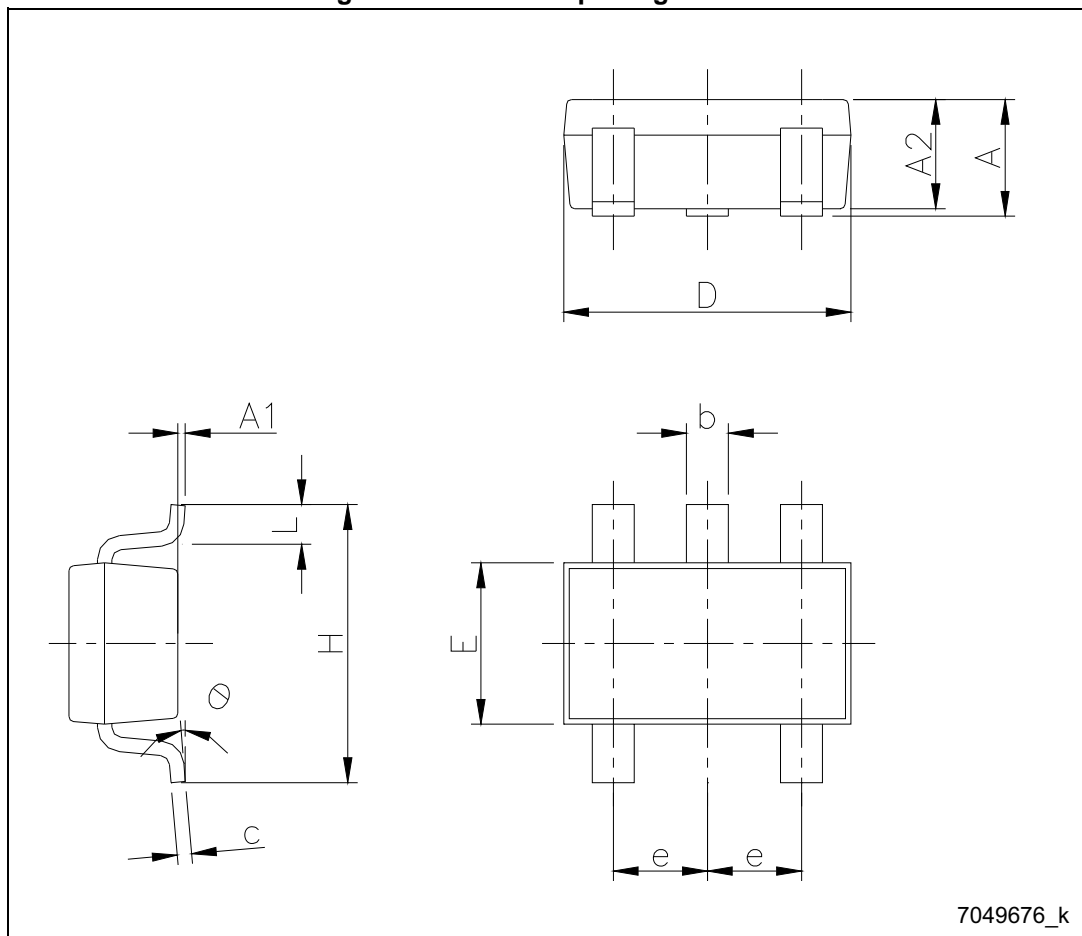
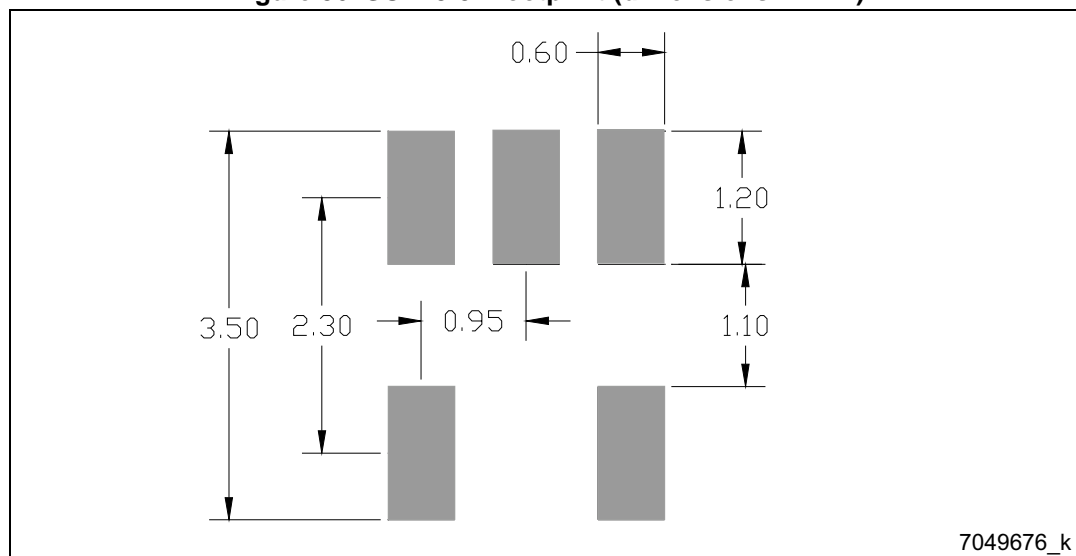

Table 6. SOT23-5L package mechanical data

Symbol	Dimensions (mm)		
	Min.	Typ.	Max.
A	0.90	-	1.45
A1	0	-	0.15
A2	0.90	-	1.30
b	0.30	-	0.50
c	2.09	-	0.20
D	-	2.95	-
E	-	1.60	-
e	-	0.95	-
H	-	2.80	-
L	0.30	-	0.60
θ	0	-	8

Figure 36. SOT23-5L footprint (dimensions in mm)



7.2 DFN6 1.2 x 1.3 package information

Figure 37. DFN6 1.2 x 1.3 package outline

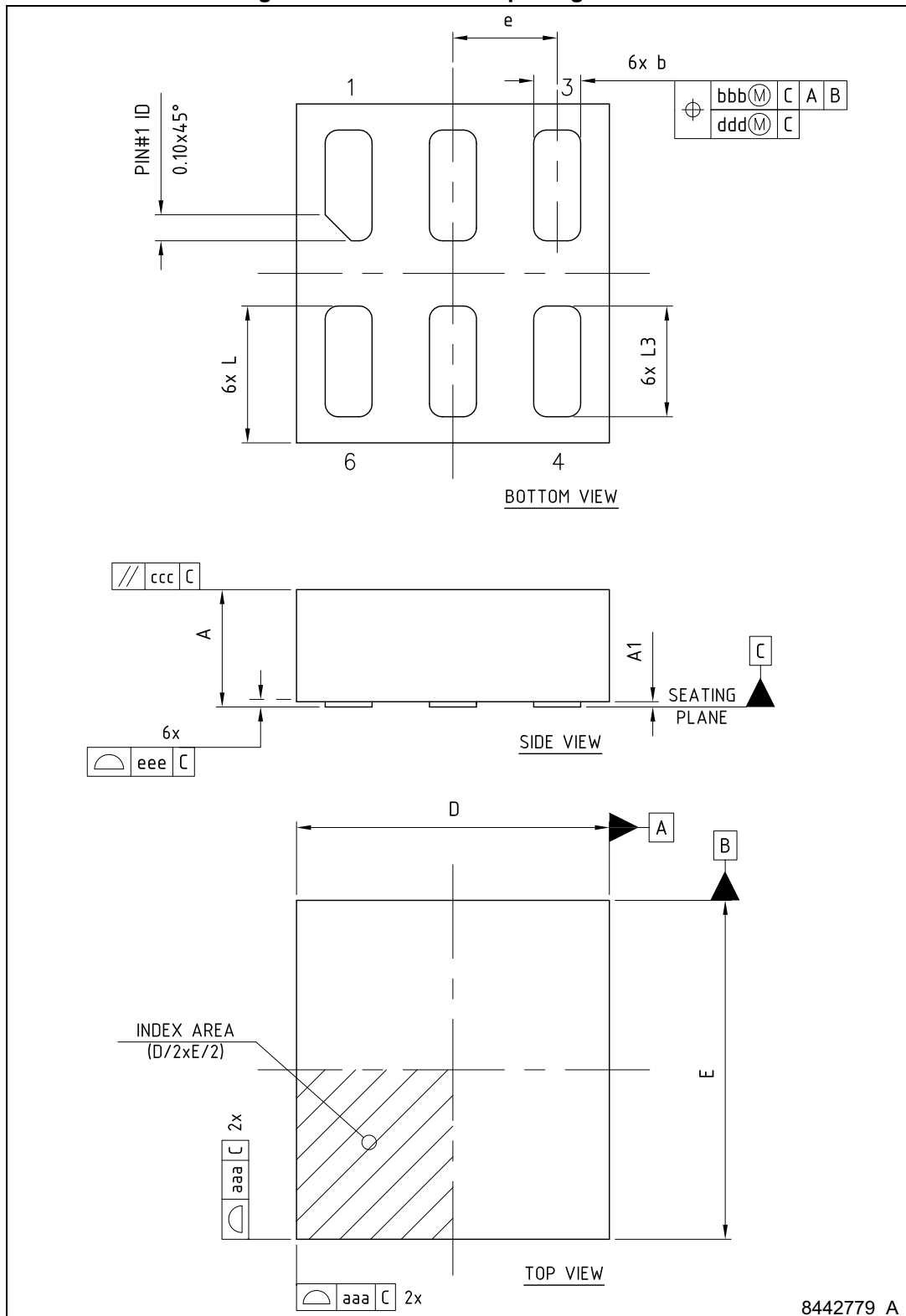

8442779 A

Table 7. DFN6 1.2 x 1.3 package mechanical data

Symbol	Dimensions (mm)		
	Min.	Typ.	Max.
A	0.41	0.45	0.50
A1	0.00	0.02	0.05
D	-	1.20	-
E	-	1.30	-
e	-	0.40	-
b	0.15	0.18	0.25
L	0.475	0.525	0.575
L3	0.375	0.425	0.475
aaa	-	0.05	-

Figure 38. DFN6 1.2 x 1.3 recommended footprint (dimensions in mm)

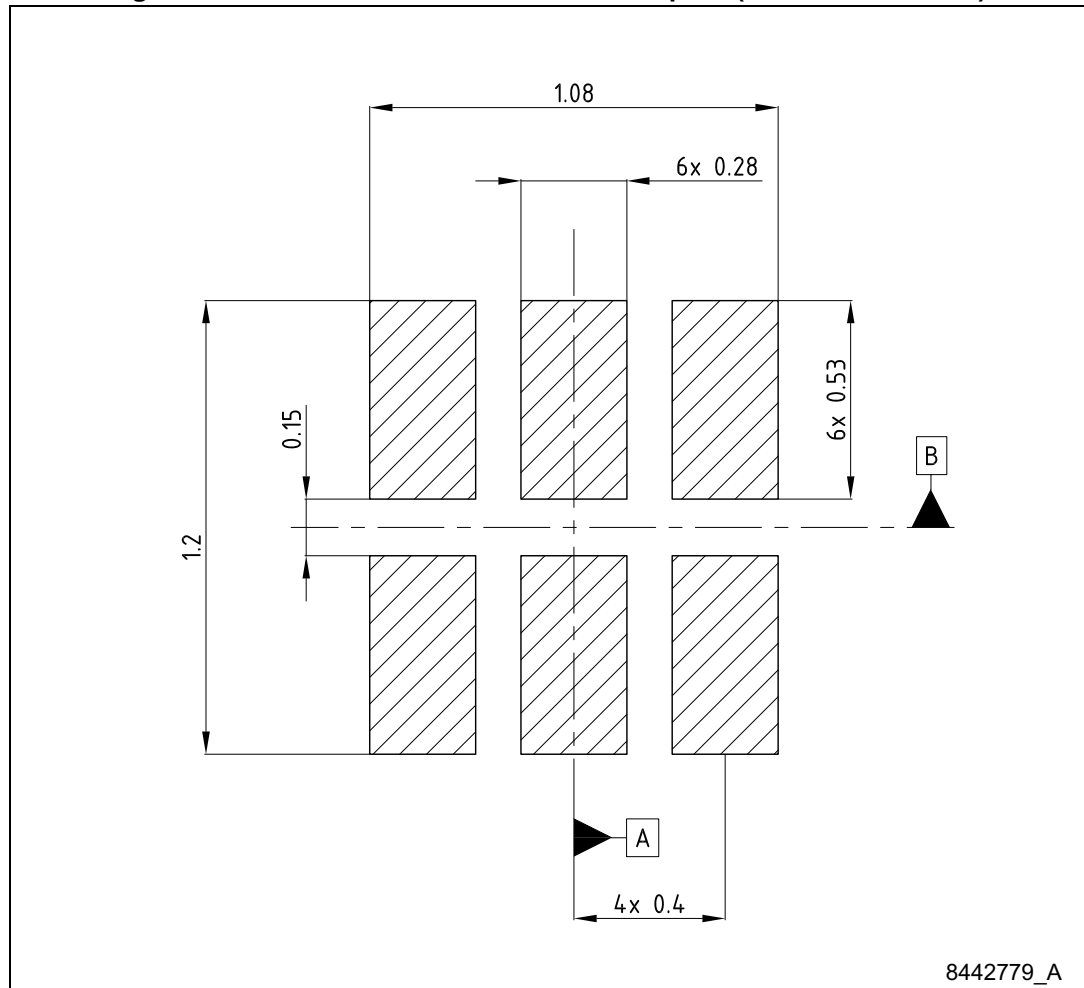

7.3 SOT323-5L package information

Figure 39. SOT323-5L package outline

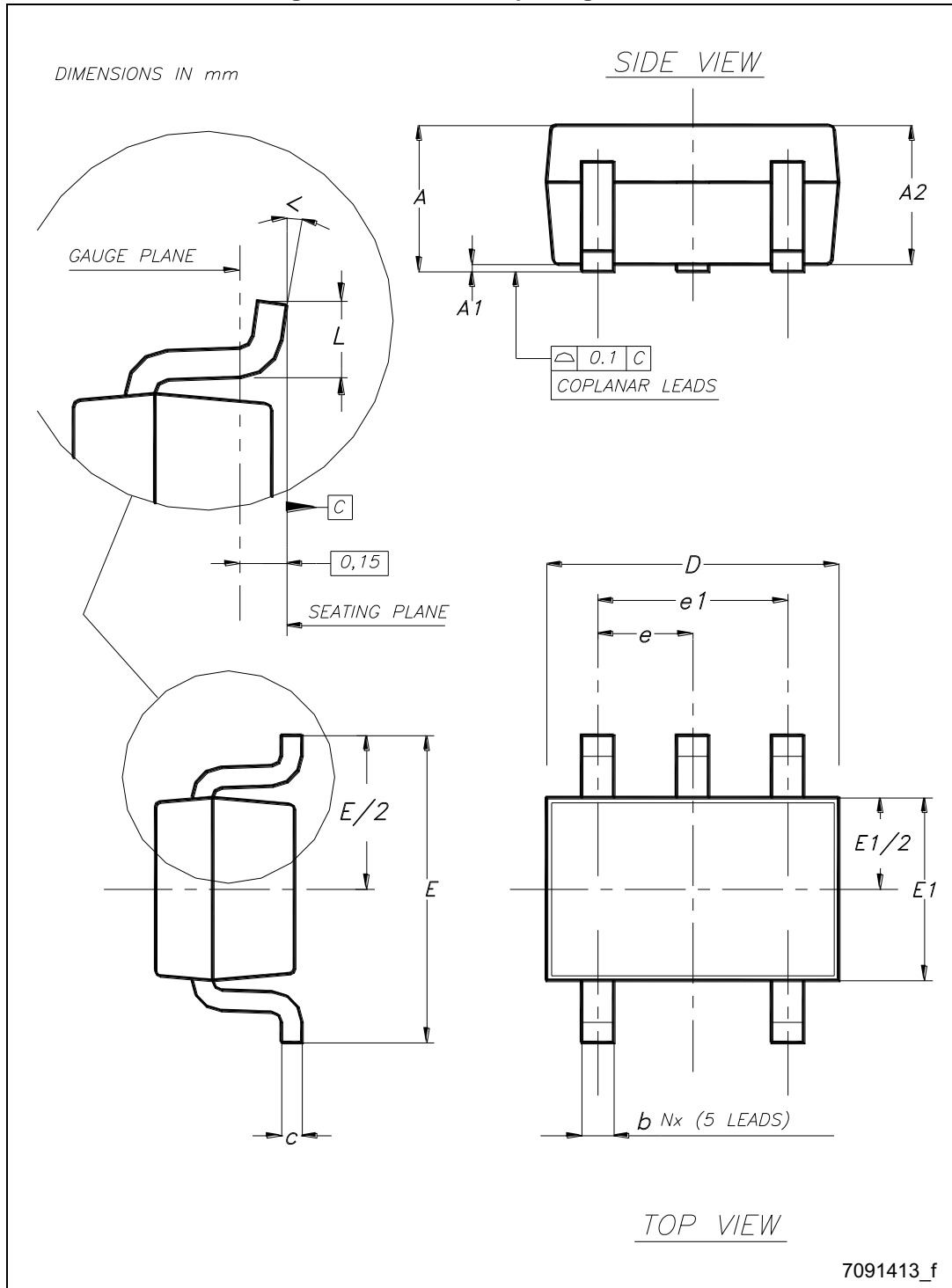

Table 8. SOT323-5L mechanical data

Symbol	Dimensions (mm)		
	Min.	Typ.	Max.
A	0.80	-	1.10
A1	0	-	0.10
A2	0.80	0.90	1
b	0.15	-	0.30
c	0.10	-	0.22
D	1.80	2	2.20
E	1.80	2.10	2.40
E1	1.15	1.25	1.35
e	-	0.65	-
e1	-	1.30	-
L	0.26	0.36	0.46
<	0°	-	8°

7.4 Packing information

7.5 SOT23-5L and SOT323-5L packing information

Figure 40. SOT23-5L and SOT323-5L tape and reel outline

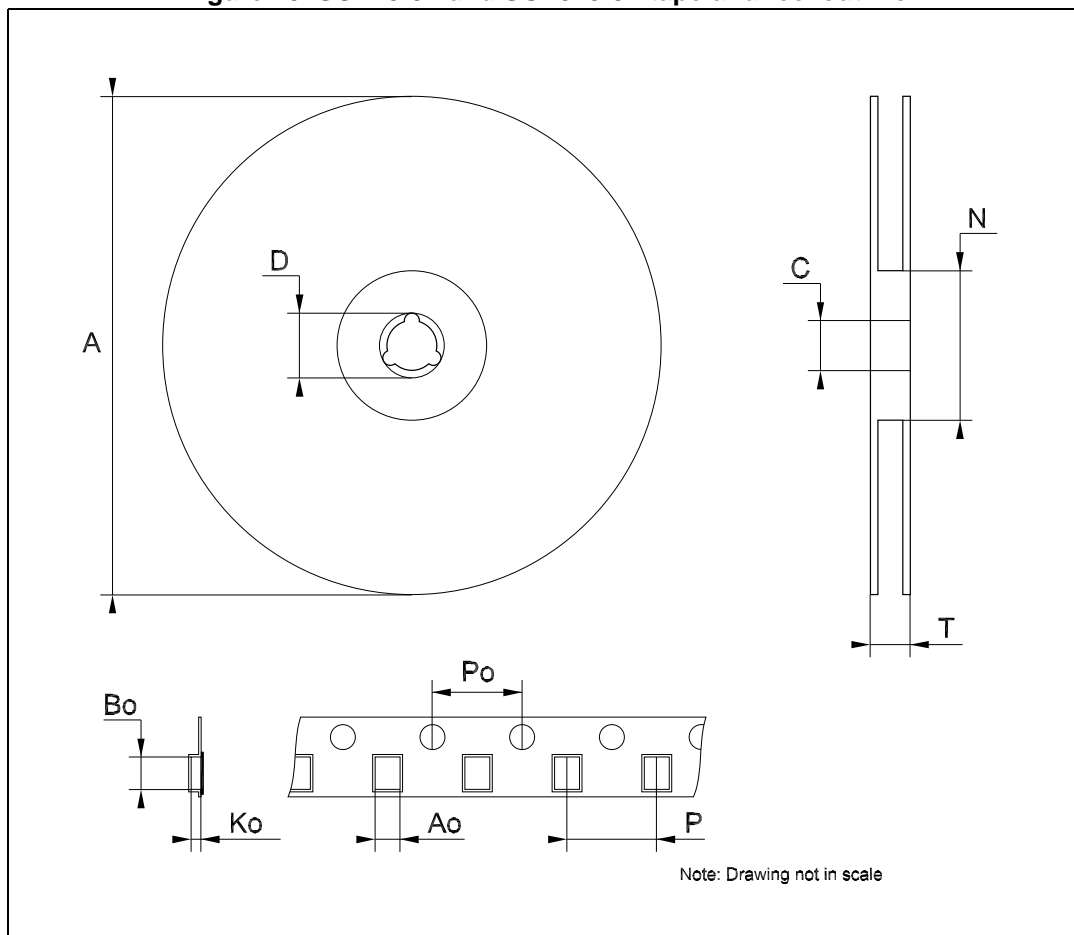

Table 9. SOT23-5L tape and reel mechanical data

Symbol	Dimensions (mm)		
	Min.	Typ.	Max.
A	-	-	180
C	12.8	13.0	13.2
D	20.2	-	-
N	60	-	-
T	-	-	14.4
Ao	3.13	3.23	3.33
Bo	3.07	3.17	3.27
Ko	1.27	1.37	1.47
Po	3.9	4.0	4.1
P	3.9	4.0	4.1

Table 10. SOT323-5L tape and reel mechanical data

Symbol	Dimensions (mm)		
	Min.	Typ.	Max.
A	175	180	185
C	12.8	13	13.2
D	20.2	-	-
N	59.5	60	60.5
T	-	-	14.4
Ao	-	2.25	-
Bo	-	3.17	-
Ko	-	1.2	-
Po	3.9	4.0	4.1
P	3.9	4.0	4.2

8 Order code

Table 11. Order code

Packages				Output voltages
SOT323-5L	SOT23-5L	SOT23-5L ⁽¹⁾	DFN6L	
LDK130C-R	LDK130M-R	-	LDK130PU-R	ADJ
LDK130C08R	LDK130M08R	-	LDK130PU08R	0.8 V
LDK130C10R	LDK130M10R	-	LDK130PU10R	1 V
LDK130C12R	LDK130M12R	-	LDK130PU12R	1.2 V
LDK130C15R	LDK130M15R	LDK130M15RY	LDK130PU15R	1.5 V
LDK130C18R	LDK130M18R	LDK130M18RY	LDK130PU18R	1.8 V
-	LDK130M25R	-	LDK130PU25R	2.5 V
-	-	LDK130M28RY	-	2.8 V
LDK130C29R	LDK130M29R	-	LDK130PU29R	2.9 V
-	-	-	LDK130PU30R	3 V
LDK130C32R	LDK130M32R	-	LDK130PU32R	3.2 V
LDK130C33R	LDK130M33R	LDK130M33RY	LDK130PU33R	3.3 V

1. Automotive grade according to AEC-Q100 level 1.

Table 12. Marking

Order code	Package	Output voltage	Marking
LDK130MxxR	SOT23-5L	x.x V	Kxx
LDK130CxxR	SOT323-5L	x.x V	Kxx
LDK130PUxxR	DFN-6L	x.x V	xx
LDK130M-R	SOT23-5L	Adj	KAD
LDK130C-R	SOT323-5L	Adj	KAD
LDK130PU-R	DFN-6L	Adj	AD
LDK130MxxRY	SOT23-5L	x.x V	KxxY

9 Revision history

Table 13. Document revision history

Date	Revision	Changes
31-Jan-2013	1	Initial release
25-Oct-2013	2	RPN LDK130xx changed to LDK130. Updated the Features and the Description in cover page. Canceled Table1: Device summary. Updated <i>Section 7: Package mechanical data</i> , <i>Table 2: Absolute maximum ratings</i> and <i>Table 11: Order codes</i> . Added <i>Section 8: Packaging mechanical data</i> . Minor text changes.
10-Mar-2014	3	Updated <i>Table 11: Order codes</i> .
07-Sep-2017	4	Updated main title <i>on page 1</i> , <i>Section : Features on page 1</i> , <i>Table 11 on page 25</i> and <i>Table 12 on page 25</i> (added "automotive grade level 1" - AEC-Q100 qualified). Updated <i>Features</i> (replaced "max. 120 μ A" by "typ. 30 μ A"). Updated <i>Section : Applications on page 1</i> . Minor modifications throughout document.
26-Oct-2017	5	Updated LDK130M28RY in <i>Table 11: Order codes</i>
17-Jan-2018	6	Updated Figure 22 and Figure 23 .

IMPORTANT NOTICE – PLEASE READ CAREFULLY

STMicroelectronics NV and its subsidiaries ("ST") reserve the right to make changes, corrections, enhancements, modifications, and improvements to ST products and/or to this document at any time without notice. Purchasers should obtain the latest relevant information on ST products before placing orders. ST products are sold pursuant to ST's terms and conditions of sale in place at the time of order acknowledgement.

Purchasers are solely responsible for the choice, selection, and use of ST products and ST assumes no liability for application assistance or the design of Purchasers' products.

No license, express or implied, to any intellectual property right is granted by ST herein.

Resale of ST products with provisions different from the information set forth herein shall void any warranty granted by ST for such product.

ST and the ST logo are trademarks of ST. All other product or service names are the property of their respective owners.

Information in this document supersedes and replaces information previously supplied in any prior versions of this document.

© 2018 STMicroelectronics – All rights reserved

Данный компонент на территории Российской Федерации

Вы можете приобрести в компании MosChip.

Для оперативного оформления запроса Вам необходимо перейти по данной ссылке:

<http://moschip.ru/get-element>

Вы можете разместить у нас заказ для любого Вашего проекта, будь то серийное производство или разработка единичного прибора.

В нашем ассортименте представлены ведущие мировые производители активных и пассивных электронных компонентов.

Нашей специализацией является поставка электронной компонентной базы двойного назначения, продукции таких производителей как XILINX, Intel (ex.ALTERA), Vicor, Microchip, Texas Instruments, Analog Devices, Mini-Circuits, Amphenol, Glenair.

Сотрудничество с глобальными дистрибьюторами электронных компонентов, предоставляет возможность заказывать и получать с международных складов практически любой перечень компонентов в оптимальные для Вас сроки.

На всех этапах разработки и производства наши партнеры могут получить квалифицированную поддержку опытных инженеров.

Система менеджмента качества компании отвечает требованиям в соответствии с ГОСТ Р ИСО 9001, ГОСТ РВ 0015-002 и ЭС РД 009

Офис по работе с юридическими лицами:

105318, г.Москва, ул.Щербаковская д.3, офис 1107, 1118, ДЦ «Щербаковский»

Телефон: +7 495 668-12-70 (многоканальный)

Факс: +7 495 668-12-70 (доб.304)

E-mail: info@moschip.ru

Skype отдела продаж:

moschip.ru

moschip.ru_4

moschip.ru_6

moschip.ru_9