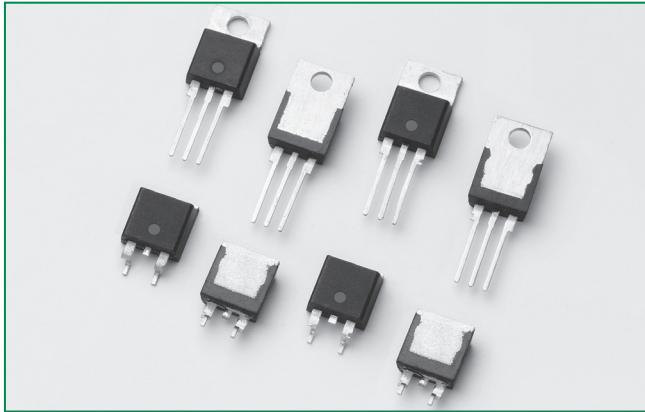


## S4040xQx Series

RoHS



### Main Features

Symbol	Value	Unit
$I_{T(RMS)}$	40	A
$V_{DRM}/V_{RRM}$	400	V
$I_{GT}$	15 to 65	mA

### Description

The S4040xQx series of SCRs offer fast turn-off time ( $t_q$ ) characteristics required for applications such as power inverters, switching regulator, and high frequency pulse circuits.

These fast turn-off time SCRs offer high  $dv/dt$  and high  $di/dt$  characteristics required in higher frequency (>1000 PPS) switching circuits.

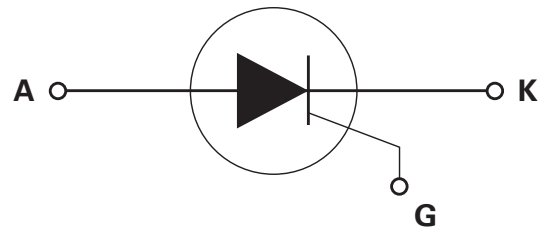
### Features & Benefits

- RoHS compliant
- Glass – passivated junctions
- Voltage capability up to 400 V
- Surge capability up to 520 A
- TO-220 and TO-263 packages

### Applications

Fast turn-off time SCRs are ideal for multi phase voltage regulator circuits, DC/AC inverters, and higher frequency pulsing power supplies.

### Schematic Symbol



### Absolute Maximum Ratings

Symbol	Parameter	Test Conditions	Value	Unit
$I_{T(RMS)}$	RMS on-state current	$T_c = 100^\circ\text{C}$	40	A
$I_{T(AV)}$	Average on-state current	$T_c = 100^\circ\text{C}$	25.0	A
$I_{TSM}$	Peak non-repetitive surge current	single half cycle; $f = 50\text{Hz}$ ; $T_j$ (initial) = $25^\circ\text{C}$	430	A
		single half cycle; $f = 60\text{Hz}$ ; $T_j$ (initial) = $25^\circ\text{C}$	520	
$I^2t$	$I^2t$ Value for fusing	$t_p = 8.3\text{ ms}$	1122	$\text{A}^2\text{s}$
$di/dt$	Critical rate of rise of on-state current	$f = 60\text{Hz}$ ; $T_j = 125^\circ\text{C}$	175	$\text{A}/\mu\text{s}$
$I_{GM}$	Peak gate current	$T_j = 125^\circ\text{C}$	3.5	A
$P_{G(AV)}$	Average gate power dissipation	$T_j = 125^\circ\text{C}$	0.8	W
$T_{stg}$	Storage temperature range		-40 to 150	$^\circ\text{C}$
$T_j$	Operating junction temperature range		-40 to 125	$^\circ\text{C}$

**Electrical Characteristics ( $T_J = 25^\circ\text{C}$ , unless otherwise specified)**

Symbol	Test Conditions		Sxx40xQ	Sxx40xQ2	Sxx40xQ3	Unit
$I_{GT}$	$V_D = 12\text{V}; R_L = 30\ \Omega$	MAX.	35	45	65	mA
		MIN.	15	30	38	
$V_{GT}$		MAX.	1.5			V
$I_{GT}$	$V_D = 12\text{V}; R_L = 30\ \Omega; T_J = -40^\circ\text{C}$	MAX.	75	95	160	mA
dv/dt	$V_D = V_{DRM};$ gate open; $T_J = 100^\circ\text{C}$	MIN.	650			V/ $\mu\text{s}$
	$V_D = V_{DRM};$ gate open; $T_J = 125^\circ\text{C}$		550			
$V_{GD}$	$V_D = V_{DRM}; R_L = 3.3\ \text{k}\Omega; T_J = 125^\circ\text{C}$	MIN.	0.2			V
$I_H$	$I_T = 400\text{mA}$ (initial)	MAX.	70	120	200	mA
$t_q$	(1)	MAX.	15	12	5	$\mu\text{s}$
$t_{gt}$	$I_G = 2 \times I_{GT}; PW = 15\ \mu\text{s}; I_T = 80\text{A}$	TYP.	3.0		3.5	$\mu\text{s}$

Note :

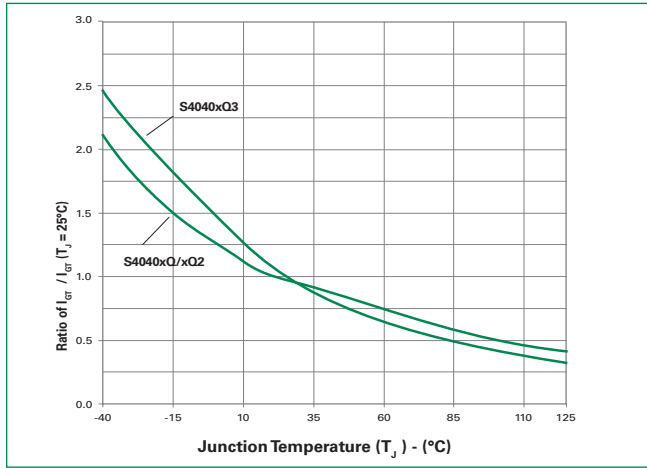
 (1)  $I_T=0.5\text{A}; t_p=50\ \mu\text{s}; dv/dt=5\text{V}/\mu\text{s}; di/dt=30\text{A}/\mu\text{s}$ 
**Static Characteristics**

Symbol	Test Conditions		S4040xQ	S4040xQ2	S4040xQ3	Unit
$V_{TM}$	$I_T = 80\text{A}; t_p = 380\ \mu\text{s}$	MAX.	1.8		2.2	V
$I_{DRM} / I_{RRM}$	$V_{DRM} / V_{RRM}$	$T_J = 25^\circ\text{C}$	10			$\mu\text{A}$
		$T_J = 100^\circ\text{C}$	1000			
		$T_J = 125^\circ\text{C}$	2000			

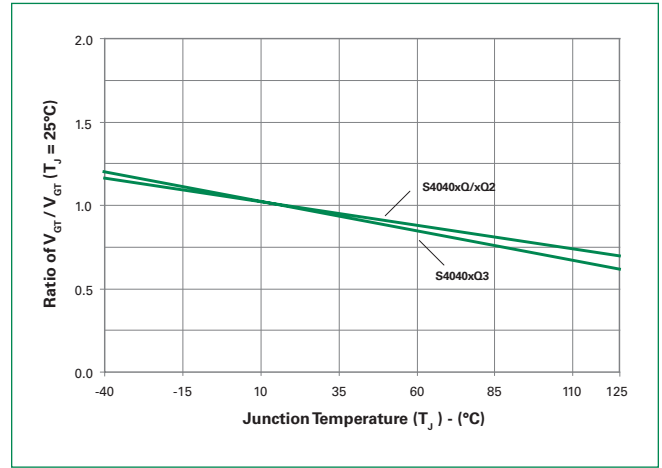
**Thermal Resistances**

Symbol	Parameter	Value	Unit
$R_{\theta(J-C)}$	Junction to case (AC)	0.6	$^\circ\text{C}/\text{W}$
$R_{\theta(J-A)}$	Junction to ambient	40	$^\circ\text{C}/\text{W}$

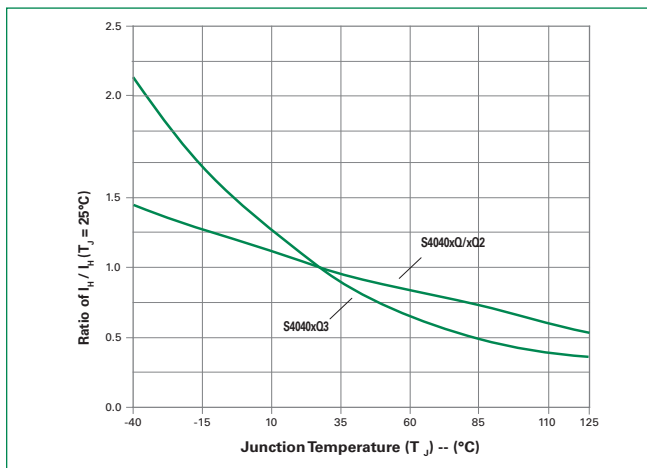
**Figure 1: Normalized DC Gate Trigger Current vs. Junction Temperature**



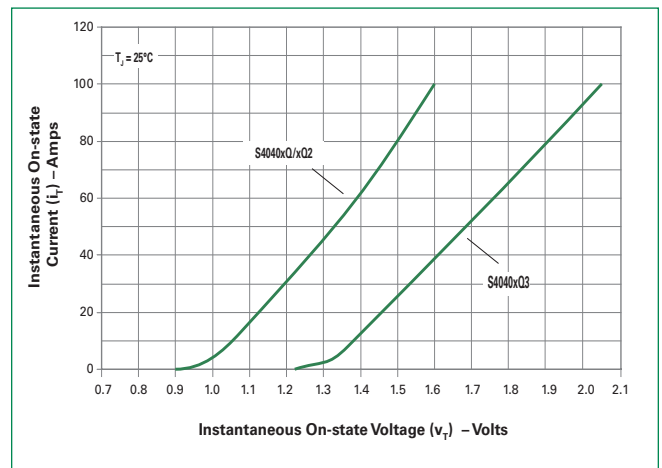
**Figure 2: Normalized DC Gate Trigger Voltage vs. Junction Temperature**



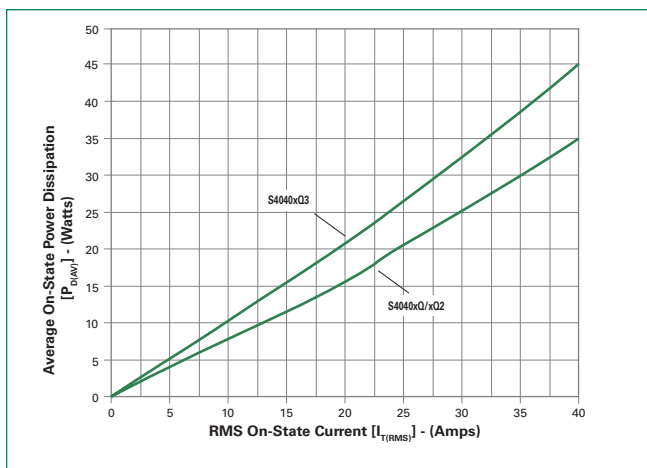
**Figure 3: Normalized DC Holding Current vs. Junction Temperature**



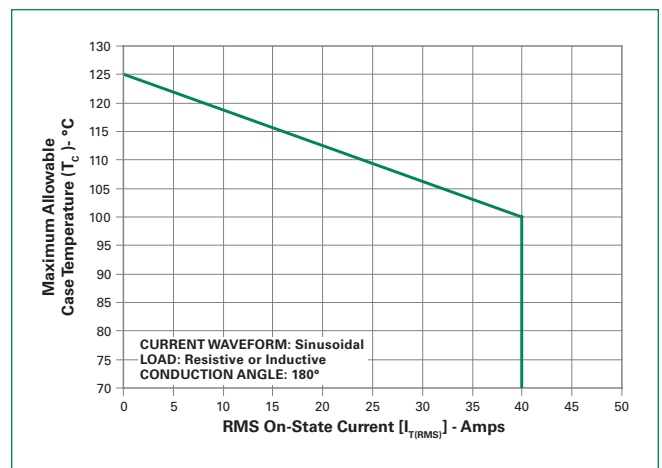
**Figure 4: On-State Current vs. On-State Voltage (Typical)**



**Figure 5: Power Dissipation (Typical) vs. RMS On-State Current**



**Figure 6: Maximum Allowable Case Temperature vs. RMS On-State Current**



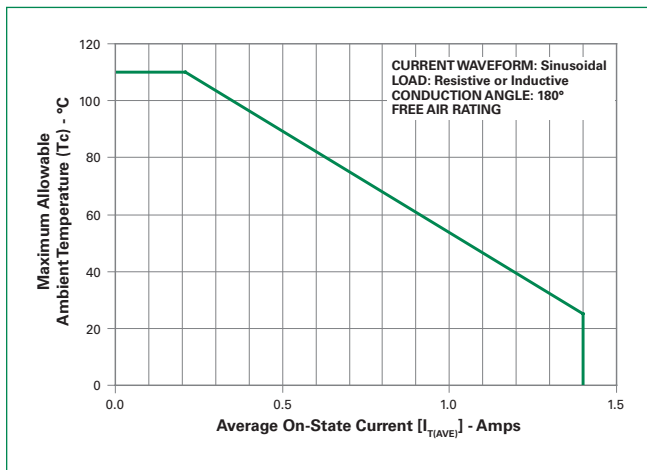
**Figure 7: Maximum Allowable Case Temperature vs. Average On-State Current**



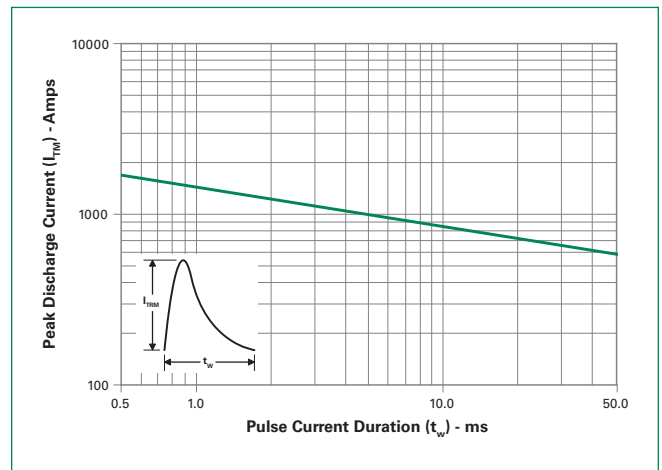
**Figure 8: Maximum Allowable Ambient Temperature vs. RMS On-State Current**



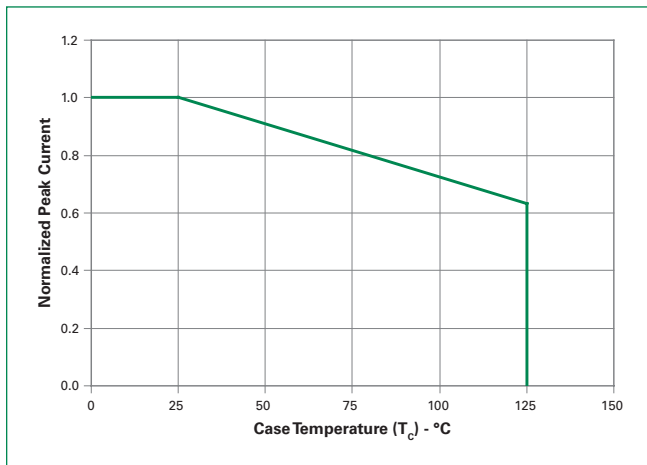
**Figure 9: Maximum Allowable Ambient Temperature vs. Average On-State Current**



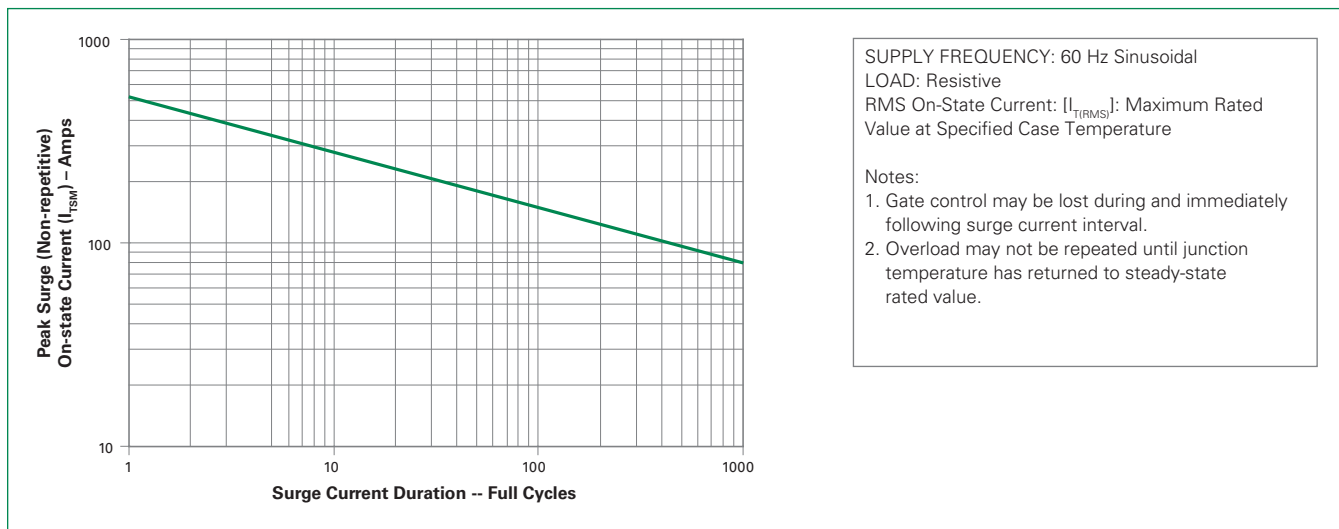
**Figure 10: Peak Capacitor Discharge Current**



**Figure 11: Peak Capacitor Discharge Current Derating**

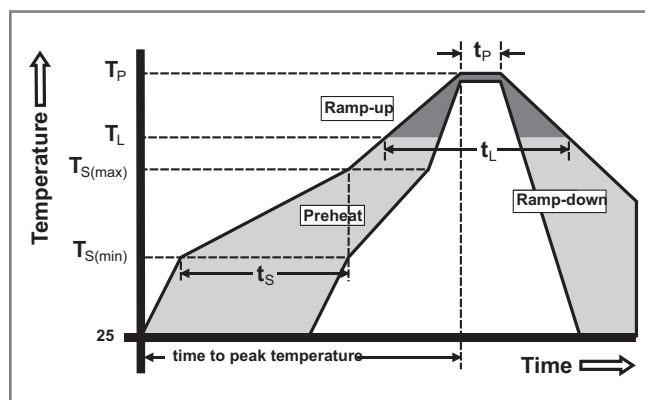


**Figure 12: Surge Peak On-State Current vs. Number of Cycles**



**Soldering Parameters**

Reflow Condition		Pb – Free assembly
Pre Heat	- Temperature Min ( $T_{s(min)}$ )	150°C
	- Temperature Max ( $T_{s(max)}$ )	200°C
	- Time (min to max) ( $t_s$ )	60 – 180 secs
Average ramp up rate (Liquidus Temp) ( $T_L$ ) to peak		5°C/second max
$T_{s(max)}$ to $T_L$ - Ramp-up Rate		5°C/second max
Reflow	- Temperature ( $T_L$ ) (Liquidus)	217°C
	- Temperature ( $t_L$ )	60 – 150 seconds
Peak Temperature ( $T_p$ )		260 <sup>+0/-5</sup> °C
Time within 5°C of actual peak Temperature ( $t_p$ )		20 – 40 seconds
Ramp-down Rate		5°C/second max
Time 25°C to peak Temperature ( $T_p$ )		8 minutes Max.
Do not exceed		280°C



**Physical Specifications**

<b>Terminal Finish</b>	100% Matte Tin-plated
<b>Body Material</b>	UL recognized epoxy meeting flammability classification 94V-0
<b>Lead Material</b>	Copper Alloy

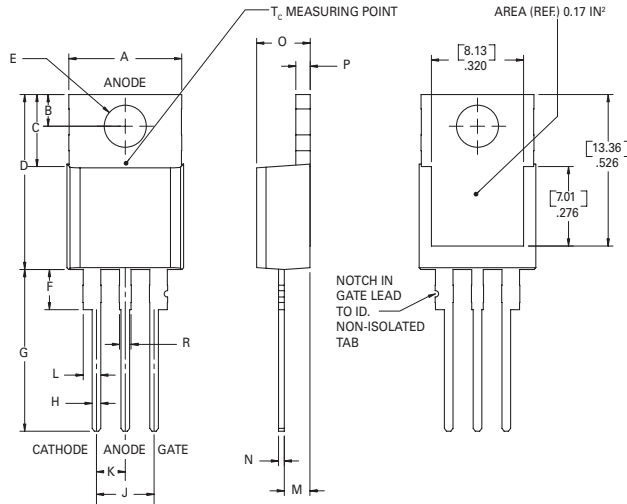
**Design Considerations**

Careful selection of the correct device for the application's operating parameters and environment will go a long way toward extending the operating life of the Thyristor. Good design practice should limit the maximum continuous current through the main terminals to 75% of the device rating. Other ways to ensure long life for a power discrete semiconductor are proper heat sinking and selection of voltage ratings for worst case conditions. Overheating, overvoltage (including dv/dt), and surge currents are the main killers of semiconductors. Correct mounting, soldering, and forming of the leads also help protect against component damage.

**Environmental Specifications**

Test	Specifications and Conditions
<b>AC Blocking</b>	MIL-STD-750, M-1040, Cond A Applied Peak AC voltage @ 125°C for 1008 hours
<b>Temperature Cycling</b>	MIL-STD-750, M-1051, 100 cycles; -40°C to +150°C; 15-min dwell-time
<b>Temperature/Humidity</b>	EIA / JEDEC, JESD22-A101 1008 hours; 320V - DC: 85°C; 85% rel humidity
<b>High Temp Storage</b>	MIL-STD-750, M-1031, 1008 hours; 150°C
<b>Low-Temp Storage</b>	1008 hours; -40°C
<b>Resistance to Solder Heat</b>	MIL-STD-750 Method 2031
<b>Solderability</b>	ANSI/J-STD-002, category 3, Test A
<b>Lead Bend</b>	MIL-STD-750, M-2036 Cond E

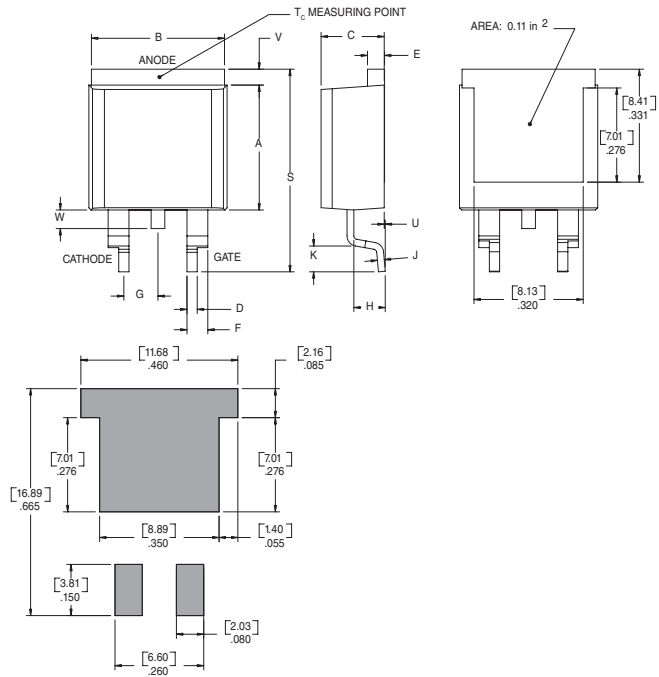
**Dimensions — TO-220AB (R-Package) — Non-Isolated Mounting Tab Common with Center Lead**



Note: Maximum torque to be applied to mounting tab is 8 in-lbs. (0.904 Nm).

Dimension	Inches		Millimeters	
	Min	Max	Min	Max
A	0.380	0.420	9.65	10.67
B	0.105	0.115	2.67	2.92
C	0.230	0.250	5.84	6.35
D	0.590	0.620	14.99	15.75
E	0.142	0.147	3.61	3.73
F	0.110	0.130	2.79	3.30
G	0.540	0.575	13.72	14.61
H	0.025	0.035	0.64	0.89
J	0.195	0.205	4.95	5.21
K	0.095	0.105	2.41	2.67
L	0.060	0.075	1.52	1.91
M	0.085	0.095	2.16	2.41
N	0.018	0.024	0.46	0.61
O	0.178	0.188	4.52	4.78
P	0.045	0.060	1.14	1.52
R	0.038	0.048	0.97	1.22

**Dimensions – TO- 263 (N-package) – D<sup>2</sup>-Pak Surface Mount**



Dimension	Inches		Millimeters	
	Min	Max	Min	Max
A	0.360	0.370	9.14	9.40
B	0.380	0.420	9.65	10.67
C	0.178	0.188	4.52	4.78
D	0.025	0.035	0.63	0.89
E	0.048	0.055	1.22	1.40
F	0.060	0.075	1.52	1.91
G	0.095	0.105	2.41	2.67
H	0.083	0.093	2.11	2.36
J	0.018	0.024	0.46	0.61
K	0.090	0.110	2.29	2.79
S	0.590	0.625	14.99	15.87
V	0.035	0.045	0.89	1.14
U	0.002	0.010	0.05	0.25
W	0.040	0.070	1.02	1.78

**Part Numbering System**



**Part Marking System**

TO-220 AB - (R Package)  
TO-263 (N Package)



**Date Code Marking**  
Y: Year Code  
M: Month Code  
XXX: Lot Trace Code

**Product Selector**

Part Number	Voltage	Gate Sensitivity	Type	Package
	400V			
S4040RQ	X	15-35	Standard SCR	TO-220AB
S4040NQ	X	15-35	Standard SCR	TO-263
S4040RQ2	X	30-45	Standard SCR	TO-220AB
S4040NQ2	X	30-45	Standard SCR	TO-263
S4040RQ3	X	38-65	Standard SCR	TO-220AB
S4040NQ3	X	38-65	Standard SCR	TO-263

**Packing Options**

Part Number	Marking	Weight	Packing Mode	Base Quantity
S4040RQTP	S4040RQ	2.2g	Tube	500 (50 per tube)
S4040RQ2TP	S4040RQ2	2.2g	Tube	500 (50 per tube)
S4040RQ3TP	S4040RQ3	2.2g	Tube	500 (50 per tube)
S4040NQRP	S4040NQ	1.6g	Embossed Carrier	500
S4040NQ2RP	S4040NQ2	1.6g	Embossed Carrier	500
S4040NQ3RP	S4040NQ3	1.6g	Embossed Carrier	500

**Reel Pack (RP) for TO-263 Embossed Carrier Specifications**

Meets all EIA-481-2 Standards





## Данный компонент на территории Российской Федерации

### Вы можете приобрести в компании MosChip.

Для оперативного оформления запроса Вам необходимо перейти по данной ссылке:

<http://moschip.ru/get-element>

Вы можете разместить у нас заказ для любого Вашего проекта, будь то серийное производство или разработка единичного прибора.

В нашем ассортименте представлены ведущие мировые производители активных и пассивных электронных компонентов.

Нашей специализацией является поставка электронной компонентной базы двойного назначения, продукции таких производителей как XILINX, Intel (ex.ALTERA), Vicor, Microchip, Texas Instruments, Analog Devices, Mini-Circuits, Amphenol, Glenair.

Сотрудничество с глобальными дистрибьюторами электронных компонентов, предоставляет возможность заказывать и получать с международных складов практически любой перечень компонентов в оптимальные для Вас сроки.

На всех этапах разработки и производства наши партнеры могут получить квалифицированную поддержку опытных инженеров.

Система менеджмента качества компании отвечает требованиям в соответствии с ГОСТ Р ИСО 9001, ГОСТ РВ 0015-002 и ЭС РД 009

### Офис по работе с юридическими лицами:

105318, г.Москва, ул.Щербаковская д.3, офис 1107, 1118, ДЦ «Щербаковский»

Телефон: +7 495 668-12-70 (многоканальный)

Факс: +7 495 668-12-70 (доб.304)

E-mail: [info@moschip.ru](mailto:info@moschip.ru)

Skype отдела продаж:

moschip.ru

moschip.ru\_4

moschip.ru\_6

moschip.ru\_9