

HBT DIGITAL PHASE-FREQUENCY DETECTOR, 10 - 1300 MHz



Typical Applications

This Phase Frequency Detector is a key component in low phase noise frequency synthesis applications such as:

- Point-to-Point Radios
- Satellite Communication Systems
- Military Applications
- Sonet Clock Generation

Functional Diagram



Features

- Ultra Low SSB Phase Noise Floor:
 - 153 dBc/Hz @ 10 kHz offset @ 100 MHz
 - Input up to 1300 MHz Fin.
- Differential Input/Single Ended Output
- Open Collector Output Buffer Amplifiers
- QSOP16G SMT Package: 29.4 mm²

General Description

The HMC439QS16G & HMC439QS16GE are digital phase-frequency detectors intended for use in low noise phase-locked loop applications for inputs from 10 to 1300 MHz. Its combination of high frequency of operation along with its ultra low phase noise floor make possible synthesizers with wide loop bandwidth and low N resulting in fast switching and very low phase noise. When used in conjunction with a differential loop amplifier, the HMC439QS16G & HMC439QS16GE generate output voltages that can be used to phase lock a VCO to a reference oscillator. The device is packaged in a low cost, surface mount 16 lead QSOP package with an exposed base for improved RF and thermal performance.

Electrical Specifications, $T_A = +25^\circ C$, $V_{CC} = 5V$

| Parameter | Conditions | Min. | Typ. | Max. | Units |
|-------------------------|--|------|------|------|----------------|
| Maximum Input Frequency | | 1300 | | | MHz |
| Minimum Input Frequency | Sine Wave Input | | | 10 | MHz |
| Input Power Range | Fin= 10 to 1300 MHz | -10 | | +10 | dBm |
| Output Voltage | | | 2000 | | mV, Pk - Pk |
| SSB Phase Noise | @ 10 kHz Offset with 100 MHz Input & Pin= 0 dBm | | -153 | | dBc/Hz |
| Supply Current (Icc) | | | 96 | | mA |



**HBT DIGITAL PHASE-FREQUENCY
DETECTOR, 10 - 1300 MHz**

Error Voltage vs. Frequency, Pin= 0 dBm*

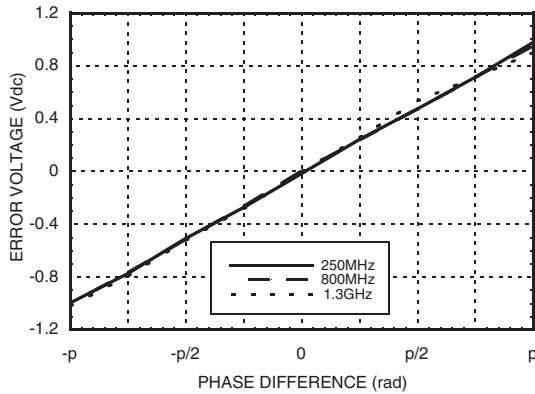

Error Voltage vs. Supply Voltage, Pin= 0 dBm, Fin= 250 MHz*

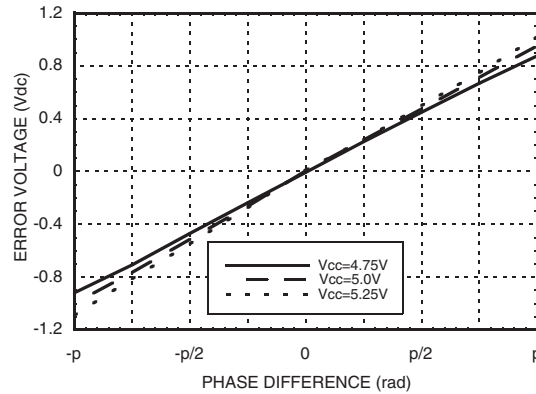

Error Voltage vs. Temperature, Pin= 0 dBm, Fin= 250 MHz*

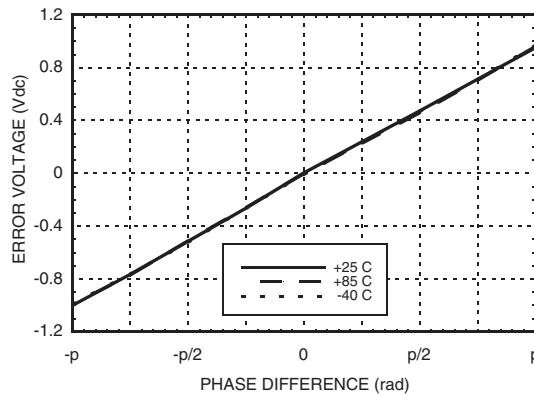

SSB Phase Noise Performance, Pin= 0 dBm, T= 25 °C

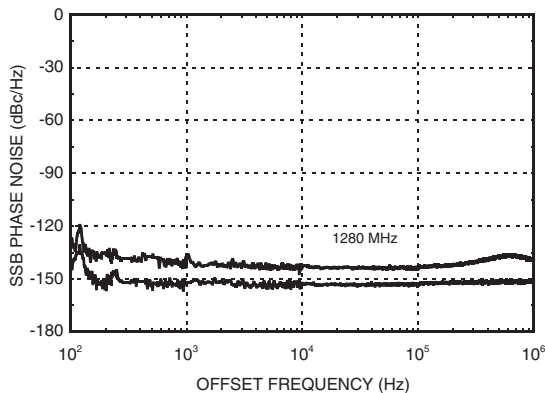

SSB Phase Noise Performance, Pin= 0 dBm, Fin= 100 MHz

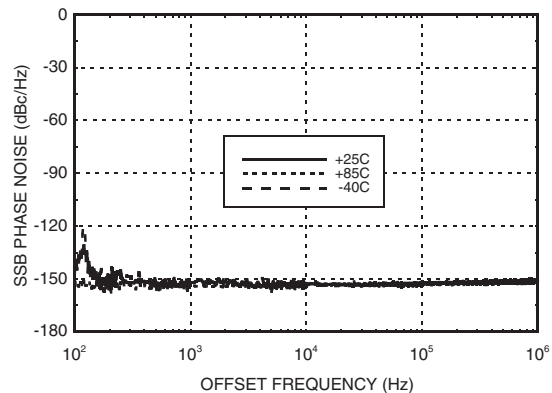

* See Gain & Error Voltage Test Circuit herein.

Information furnished by Analog Devices is believed to be accurate and reliable. However, no responsibility is assumed by Analog Devices for its use, nor for any infringements of patents or other rights of third parties that may result from its use. Specifications subject to change without notice. No license is granted by implication or otherwise under any patent or patent rights of Analog Devices. Trademarks and registered trademarks are the property of their respective owners.

For price, delivery, and to place orders: Analog Devices, Inc., One Technology Way, P.O. Box 9106, Norwood, MA 02062-9106 Phone: 781-329-4700 • Order online at www.analog.com Application Support: Phone: 1-800-ANALOG-D



HBT DIGITAL PHASE-FREQUENCY DETECTOR, 10 - 1300 MHz

Absolute Maximum Ratings

| | |
|--|----------------|
| RF Input (Vcc= +5V) | +13 dBm |
| Supply Voltage (Vcc) | +5.5V |
| Channel Temperature (Tc) | 135 °C |
| Continuous Pdiss (T = 85 °C) (derate 47.2 mW/° C above 85 °C) | 4.25 W |
| Storage Temperature | -65 to +150 °C |
| Operating Temperature | -40 to +85 °C |



**ELECTROSTATIC SENSITIVE DEVICE
OBSERVE HANDLING PRECAUTIONS**

Typical Supply Current vs. Vcc

| Vcc (Vdc) | Icc (mA) |
|-----------|----------|
| 4.8 | 90 |
| 5.0 | 96 |
| 5.2 | 102 |

Note: Detector will work over full voltage range above.

Typical DC Characteristics @ Vcc = +5V

| Symbol | Characteristics | +25C | | | Units |
|--------|----------------------|------|------|------|-------|
| | | Min. | Typ. | Max. | |
| Icc | Power Supply Current | 90 | 96 | 102 | mA |
| Voh | Output High Voltage | 5.0 | 5.0 | 5.0 | V |
| Vol | Output Low Voltage | 2.9 | 3 | 3.1 | V |

Outline Drawing



NOTES:

1. LEADFRAME MATERIAL: COPPER ALLOY
2. DIMENSIONS ARE IN INCHES [MILLIMETERS]
3. DIMENSION DOES NOT INCLUDE MOLDFLASH OF 0.15mm PER SIDE.
4. DIMENSION DOES NOT INCLUDE MOLDFLASH OF 0.25mm PER SIDE.
5. ALL GROUND LEADS AND GROUND PADDLE MUST BE SOLDERED TO PCB RF GROUND.

Package Information

| Part Number | Package Body Material | Lead Finish | MSL Rating | Package Marking [3] |
|--------------|---|---------------|------------|---------------------|
| HMC439QS16G | Low Stress Injection Molding Plastic | Sn/Pb Solder | MSL1 [1] | H439 XXXX |
| HMC439QS16GE | RoHS-compliant Low Stress Injection Molding Plastic | 100% matte Sn | MSL1 [2] | H439 XXXX |

[1] Max peak reflow temperature of 235 °C

[2] Max peak reflow temperature of 260 °C

[3] 4-Digit lot number XXXX

Information furnished by Analog Devices is believed to be accurate and reliable. However, no responsibility is assumed by Analog Devices for its use, nor for any infringements of patents or other rights of third parties that may result from its use. Specifications subject to change without notice. No license is granted by implication or otherwise under any patent or patent rights of Analog Devices. Trademarks and registered trademarks are the property of their respective owners.

For price, delivery, and to place orders: Analog Devices, Inc., One Technology Way, P.O. Box 9106, Norwood, MA 02062-9106 Phone: 781-329-4700 • Order online at www.analog.com Application Support: Phone: 1-800-ANALOG-D

HBT DIGITAL PHASE-FREQUENCY DETECTOR, 10 - 1300 MHz



Pin Description

| Pin Number | Function | Description | Interface Schematic |
|-----------------|----------|---|---------------------|
| 1 | Vcc | Supply voltage 5V ± 0.2V | |
| 2, 8, 9, 11, 16 | GND | All ground leads and ground paddle must be connected to PCB RF/DC ground. | |
| 3 | REF | (These pins are AC coupled and must be DC blocked externally.) Reference Input | |
| 4 | NREF | Reference Input Compliment | |
| 5 | N/C | Not Connected | |
| 6 | VCO | (These pins are AC coupled and must be DC blocked externally.) VCO Input | |
| 7 | NVCO | VCO Input Compliment | |
| 10 | Vcc3V | 3.0 Volt Reference Voltage for Internal 10mA Current Source | |
| 12 | ND | Down Output Compliment | |
| 13 | D | | |
| 14 | NU | Up Output Compliment | |
| 15 | U | | |

Information furnished by Analog Devices is believed to be accurate and reliable. However, no responsibility is assumed by Analog Devices for its use, nor for any infringements of patents or other rights of third parties that may result from its use. Specifications subject to change without notice. No license is granted by implication or otherwise under any patent or patent rights of Analog Devices. Trademarks and registered trademarks are the property of their respective owners.

For price, delivery, and to place orders: Analog Devices, Inc., One Technology Way, P.O. Box 9106, Norwood, MA 02062-9106
Phone: 781-329-4700 • Order online at www.analog.com
Application Support: Phone: 1-800-ANALOG-D



**HBT DIGITAL PHASE-FREQUENCY
DETECTOR, 10 - 1300 MHz**

Gain & Error Voltage Test Circuit:

Gain & Error Voltage data taken using test circuit below. Loop filter gain has been subtracted from the result.



Typical PLL Application Circuit using HMC439QS16G

PLL application shown for a 12.8 GHz Fout. Contact HMC to discuss your specific application.



Information furnished by Analog Devices is believed to be accurate and reliable. However, no responsibility is assumed by Analog Devices for its use, nor for any infringements of patents or other rights of third parties that may result from its use. Specifications subject to change without notice. No license is granted by implication or otherwise under any patent or patent rights of Analog Devices. Trademarks and registered trademarks are the property of their respective owners.

For price, delivery, and to place orders: Analog Devices, Inc., One Technology Way, P.O. Box 9106, Norwood, MA 02062-9106 Phone: 781-329-4700 • Order online at www.analog.com Application Support: Phone: 1-800-ANALOG-D



Evaluation PCB

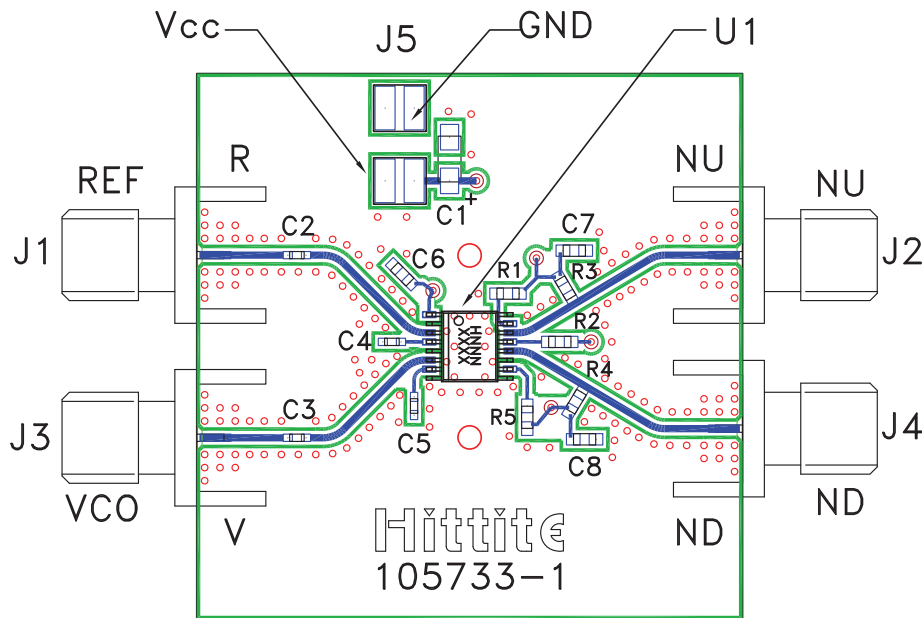

The circuit board used in the final application should use RF circuit design techniques. Signal lines should have 50 ohm impedance while the package ground leads and backside ground slug should be connected directly to the ground plane similar to that shown. A sufficient number of via holes should be used to connect the top and bottom ground planes. The evaluation circuit board shown is available from Hittite upon request.

**List of Materials for
Evaluation PCB 105809 [1]**

| Item | Description |
|---------------------------------------|------------------------------|
| J1 - J4 | PCB Mount SMA RF Connector |
| J5 | 2 mm DC Header |
| C1 | 4.7 μ F Capacitor |
| C2, C5 - C7 | 100 pF Capacitor, 0402 Pkg. |
| C3, C4, C8 | 1000 pF Capacitor, 0603 Pkg. |
| R1 ^[3] , R2 ^[3] | 4.3 Ohm Resistor, 0603 Pkg. |
| R3, R4, R5 | 200 Ohm Resistor, 0603 Pkg. |
| U1 | HMC439QS16G / HMC439QS16GE |
| PCB ^[2] | 105733 Eval Board |

[1] Reference this number when ordering complete evaluation PCB

[2] Circuit Board Material: Rogers 4350

[3] Choose values of R1 & R2 between 4.3 and 20 Ohms for best noise performance

Evaluation PCB Circuit

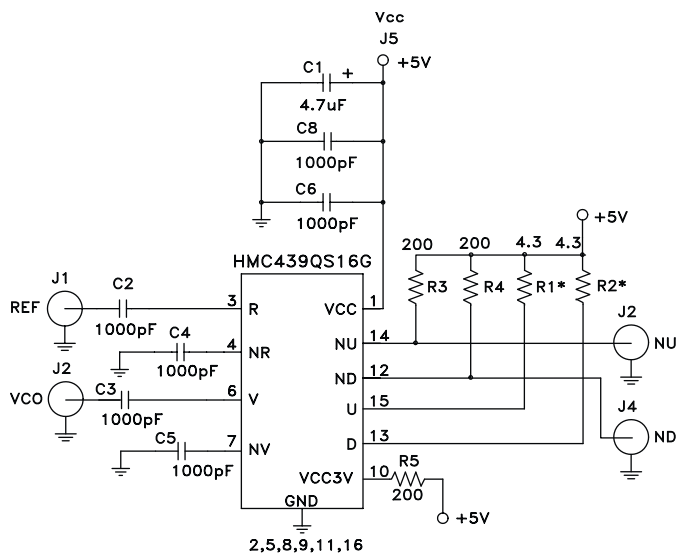

Information furnished by Analog Devices is believed to be accurate and reliable. However, no responsibility is assumed by Analog Devices for its use, nor for any infringements of patents or other rights of third parties that may result from its use. Specifications subject to change without notice. No license is granted by implication or otherwise under any patent or patent rights of Analog Devices. Trademarks and registered trademarks are the property of their respective owners.

For price, delivery, and to place orders: Analog Devices, Inc., One Technology Way, P.O. Box 9106, Norwood, MA 02062-9106 Phone: 781-329-4700 • Order online at www.analog.com Application Support: Phone: 1-800-ANALOG-D

Данный компонент на территории Российской Федерации

Вы можете приобрести в компании MosChip.

Для оперативного оформления запроса Вам необходимо перейти по данной ссылке:

<http://moschip.ru/get-element>

Вы можете разместить у нас заказ для любого Вашего проекта, будь то серийное производство или разработка единичного прибора.

В нашем ассортименте представлены ведущие мировые производители активных и пассивных электронных компонентов.

Нашей специализацией является поставка электронной компонентной базы двойного назначения, продукции таких производителей как XILINX, Intel (ex.ALTERA), Vicor, Microchip, Texas Instruments, Analog Devices, Mini-Circuits, Amphenol, Glenair.

Сотрудничество с глобальными дистрибьюторами электронных компонентов, предоставляет возможность заказывать и получать с международных складов практически любой перечень компонентов в оптимальные для Вас сроки.

На всех этапах разработки и производства наши партнеры могут получить квалифицированную поддержку опытных инженеров.

Система менеджмента качества компании отвечает требованиям в соответствии с ГОСТ Р ИСО 9001, ГОСТ РВ 0015-002 и ЭС РД 009

Офис по работе с юридическими лицами:

105318, г.Москва, ул.Щербаковская д.3, офис 1107, 1118, ДЦ «Щербаковский»

Телефон: +7 495 668-12-70 (многоканальный)

Факс: +7 495 668-12-70 (доб.304)

E-mail: info@moschip.ru

Skype отдела продаж:

moschip.ru

moschip.ru_4

moschip.ru_6

moschip.ru_9