

AS3728

8A Power Stage

General Description

The AS3728 is a companion power stage, intended to be used with AS372x products.

It cannot be used without a DCDC controller. It contains the power FETs for 2 phases and is capable to handle output currents up of 4A per phase.

Ordering Information and Content Guide appear at end of datasheet.

Key Benefits & Features

The benefits and features of AS3728, 8A Power Stage are listed below:

Figure 1:
Added Value of Using AS3728

Benefits	Features
<ul style="list-style-type: none"> • Support for single or dual phase operation 	<ul style="list-style-type: none"> • 2 phases with separate control input
<ul style="list-style-type: none"> • 2 x 4A output stages are running on 1.3MHz 	<ul style="list-style-type: none"> • Separate power low-side NMOS & high-side NMOS for 4A per phase • Separate coil current feedback per phase • Stand-alone zero-crossing operation
<ul style="list-style-type: none"> • Over – temperature protection 	<ul style="list-style-type: none"> • Integrated temperature monitoring
<ul style="list-style-type: none"> • Cost effective, small package 	<ul style="list-style-type: none"> • WL-CSP24 with 0.4mm pitch

Applications

The device is a high current dual-phase DCDC and ideal for:

- Mobile phones
- Tablets
- Notebooks

Block Diagram

The functional blocks of this device for reference are shown below:

Figure 2:
AS3728 Block Diagram

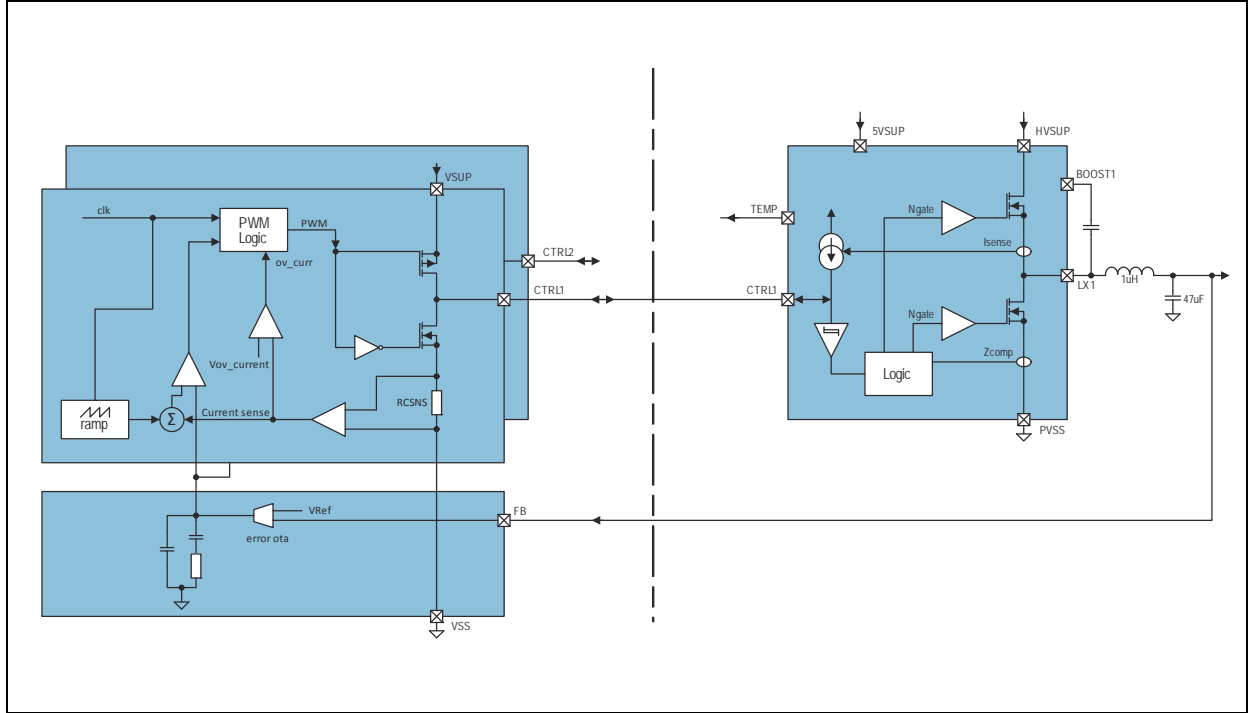

AS3728 – Block Diagram: This figure shows the block diagram of the DCDC controller inside the Main PMIC and the AS3728 Power Stage with all relevant system components.

Pin Assignment

Figure 3:
Pin Diagram - 24 Balls WL-CSP with 0.4mm Pitch

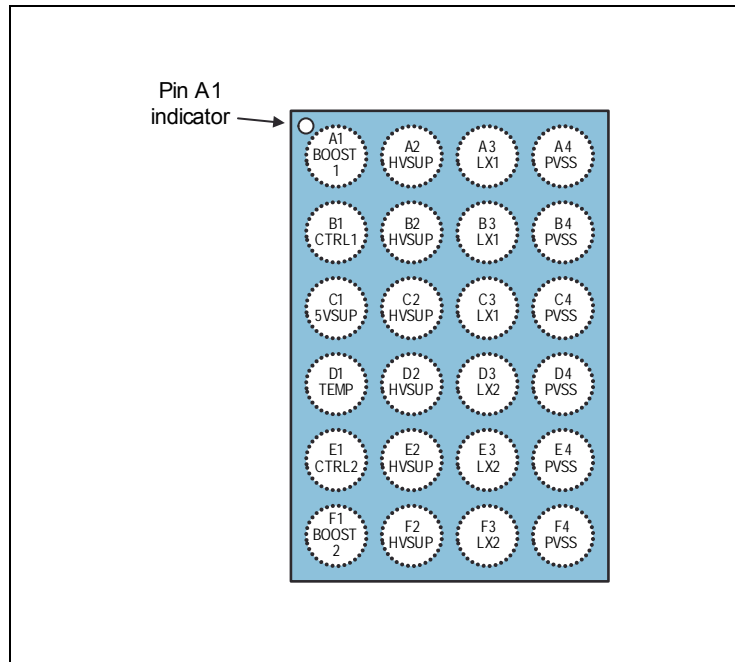

Figure 4:
Pin Description

Pin Number	Pin Name	Pin Type	Description
A1	BOOST1	AI	Supply pin for phase 1 high-side NMOS driver
B1	CTRL1	AIO	Control IO for phase 1
C1	5VSUP	S	5V supply pin
D1	TEMP	AIO	ON/OFF control and temperature feedback
E1	CTRL2	AIO	Control IO for phase 2
F1	BOOST2	AI	Supply pin for phase 2 high-side NMOS driver
A2, B2, C2	HVSUP	S	Phase 1 positive supply terminal
D2, E2, F2	HVSUP	S	Phase 2 positive supply terminal
A3, B3, C3	LX1	AIO	Phase 1 switching output to coil
D3, E3, F3	LX2	AIO	Phase 2 switching output to coil
A4, B4, C4	PVSS		Phase 1 negative supply terminal
D4, E4, F4	PVSS		Phase 2 negative supply terminal

Pin Description: Shows the pin number, type, name and description of every pin.

Absolute Maximum Ratings

Stresses beyond those listed under Absolute Maximum Ratings may cause permanent damage to the device. These are stress ratings only. Functional operation of the device at these or any other conditions beyond those indicated under [Electrical Characteristics](#) is not implied. Exposure to absolute maximum rating conditions for extended periods may affect device reliability.

Figure 5:
Absolute Maximum Ratings

Symbol	Parameter	Min	Max	Units	Comments
Electrical Parameters					
V _{GND}	Supply Voltage to Ground 14V pins	-0.5	16	V	Applicable for pins HVSUP, LX1, LX2
V _{GND}	Supply Voltage to Ground 20V pins	-0.5	22	V	Applicable for pins BOOST1, BOOST2
V _{GND}	Supply Voltage to Ground 5V pins	-0.5	7.0	V	Applicable for pins 5VSUP, CTRL1, CTRL2
V _{GND}	Supply Voltage to Ground 3V pins	-0.5	5.0	V	Applicable for pin TEMP
	Voltage Difference between Ground Terminals	-0.5	0.5	V	Applicable for pins PVSS
I _{SCR}	Input Current (latch-up immunity)	-100	100	mA	Norm: JEDEC JESD78
Continuous Power Dissipation (T_A = 70°C)					
P _T	Continuous power dissipation		1.3	mW	P _T ⁽¹⁾ for WL-CSP24 package (R _{THJA} ~ 42K/W)
Electrostatic Discharge					
ESD	Electrostatic Discharge HBM		±2	kV	Norm: JEDEC JESD22-A114F

Symbol	Parameter	Min	Max	Units	Comments
Temperature Ranges and Storage Conditions					
T_A	Operating Temperature	-40	85	°C	
R_{THJA}	Junction to Ambient Thermal Resistance			°C/W	$R_{THJA} \sim 42K/W$ (typ)
T_J	Junction Temperature		125	°C	
T_{STRG}	Storage Temperature Range	-55	125	°C	
T_{BODY}	Package Body Temperature		260	°C	Norm IPC/JEDEC J-STD-020 ⁽²⁾
RH_{NC}	Relative Humidity (non-condensing)	5	85	%	
MSL	Moisture Sensitivity Level	1			Represents an unlimited floor life time

Note(s) and/or Footnote(s):

1. Depending on actual PCB layout and PCB used
2. The reflow peak soldering temperature (body temperature) is specified according IPC/JEDEC J-STD-020 "Moisture/Reflow Sensitivity Classification for Nonhermetic Solid State Surface Mount Devices".

Electrical Characteristics

All limits are guaranteed. The parameters with min and max values are guaranteed with production tests or SQC (Statistical Quality Control) methods.

Figure 6:
Electrical Characteristics

Symbol	Parameter	Min	Typ	Max	Units	Note
V_{IN}	Input Voltage	4.5	12	14	V	Pin HVSUP
		4.5		5.5	V	Pin 5VSUP
		0		5.5	V	Pin CTRLx
		0		3.6	V	Pin TEMP
I_{LIMIT}	Peak coil current limit			5.6	A	Single phase
I_{LOAD}	Load current Single phase	0		3	A	Continuous load current
				4 ⁽¹⁾		Peak load current
$R_{HS-NMOS}$	N-switch ON resistance ⁽²⁾		115	180	mΩ	Single phase
$R_{LS-NMOS}$	N-switch ON resistance ⁽²⁾		30	40	mΩ	Single phase
f_{SW}	Switching frequency		1.3	3	MHz	Supplied by DCDC controller
I_{Q_HVSUP}	Quiescent current into HVSUP			2	μA	TEMP pin high, CTRLx pin high
I_{Q_5VSUP}	Quiescent current into 5VSUP	20		60	μA	TEMP pin high, CTRLx pin high
I_{power_off}	Power-Off current into HVSUP or 5VSUP			1	μA	No current into pin TEMP
$R_{discharge}$	Active discharge		28		Ω	Single phase

Electrical Characteristics: Shows the Electrical Characteristics of the Step Down DCDC Power Stage.
HVSUP = 5VSUP = 5.0V, $T_A = 25^\circ\text{C}$ (unless otherwise specified)

Note(s) and/or Footnote(s):

1. Maximum value only for pulsed peak current
2. MOS transistor and package parasitic

Typical Operating Characteristics

AS3728 Step Down DCDC: Shows the Efficiency vs. Output Current for various V_{IN}/V_{OUT} conditions, 1.35MHz operation, $T_{AMB} = 25^{\circ}\text{C}$

Figure 7:
Efficiency vs. Output Current

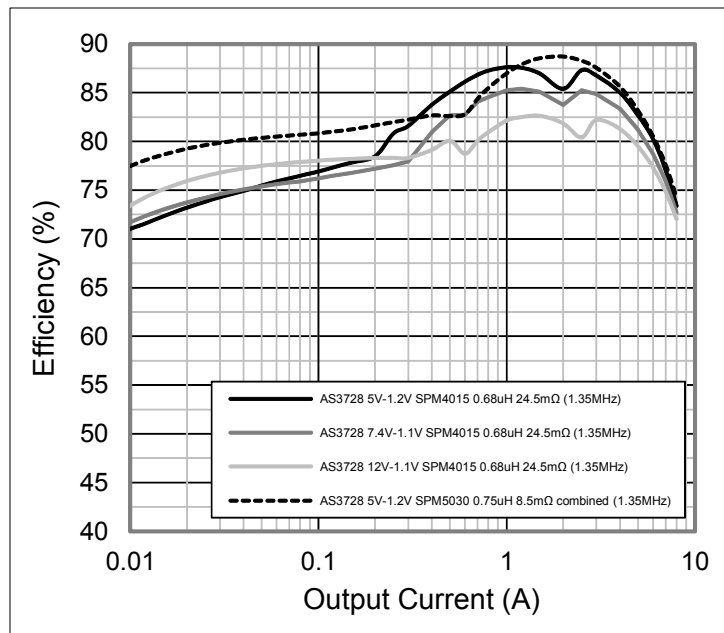

Figure 8:
Efficiency vs. Output Current

AS3728 Step Down DCDC: Shows the Efficiency vs. Output Current for various switching frequencies with $V_{OUT} = 1.2\text{V}$, $V_{IN} = 5\text{V}$, $T_{AMB} = 25^{\circ}\text{C}$ and TDK coil SPM4015 and Coilcraft coil XFL4015

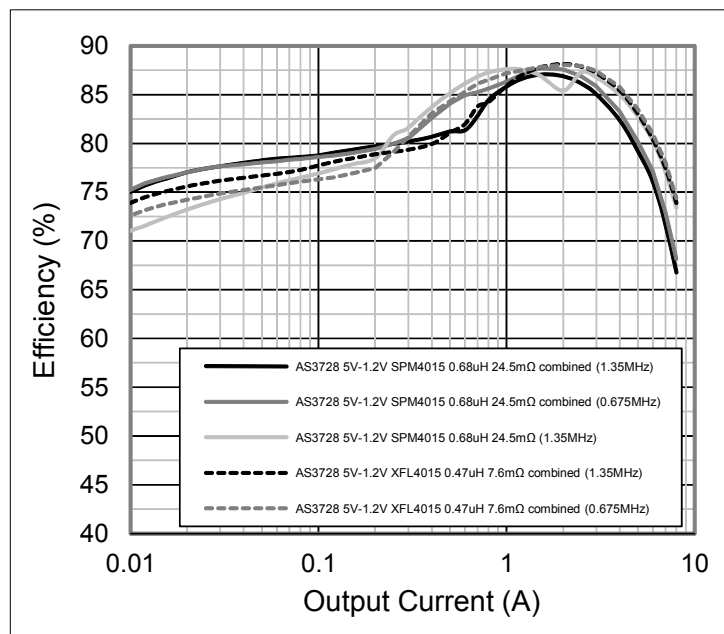

Figure 9:
Efficiency vs. Output Current

AS3728 Step Down DCDC: Shows the Efficiency vs. Output Current for various switching frequencies with $V_{OUT} = 1.2V$, $V_{IN} = 5V$, $T_{AMB} = 25^{\circ}C$ and TDK coil SPM5030

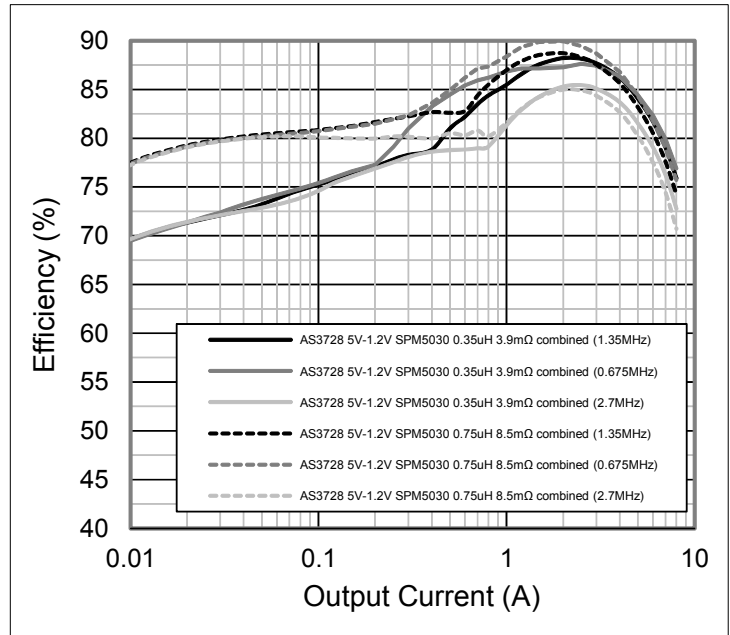
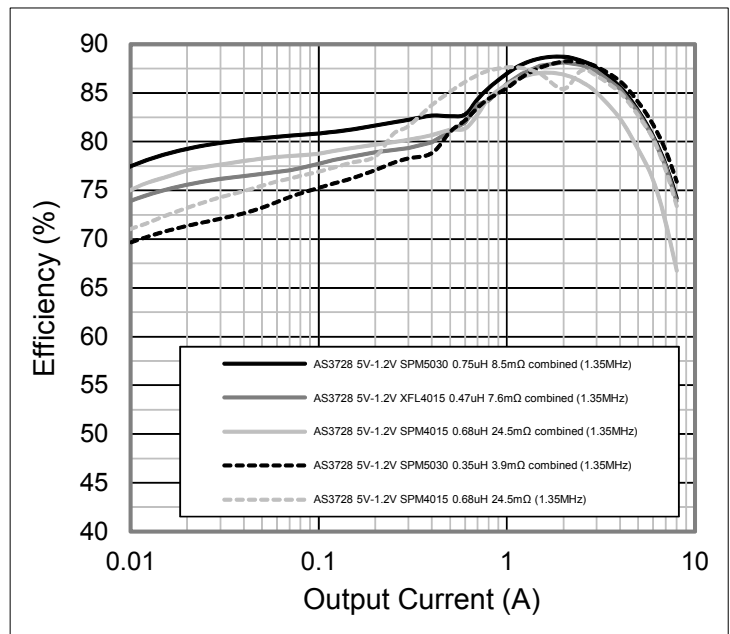

Figure 10:
Efficiency vs. Output Current

AS3728 Step Down DCDC: Shows the Efficiency vs. Output Current for various coil types with a switching frequency of 1.35MHz, $V_{OUT} = 1.2V$, $V_{IN} = 5V$, $T_{AMB} = 25^{\circ}C$



Application Information

Figure 11:
Typical Application Circuit

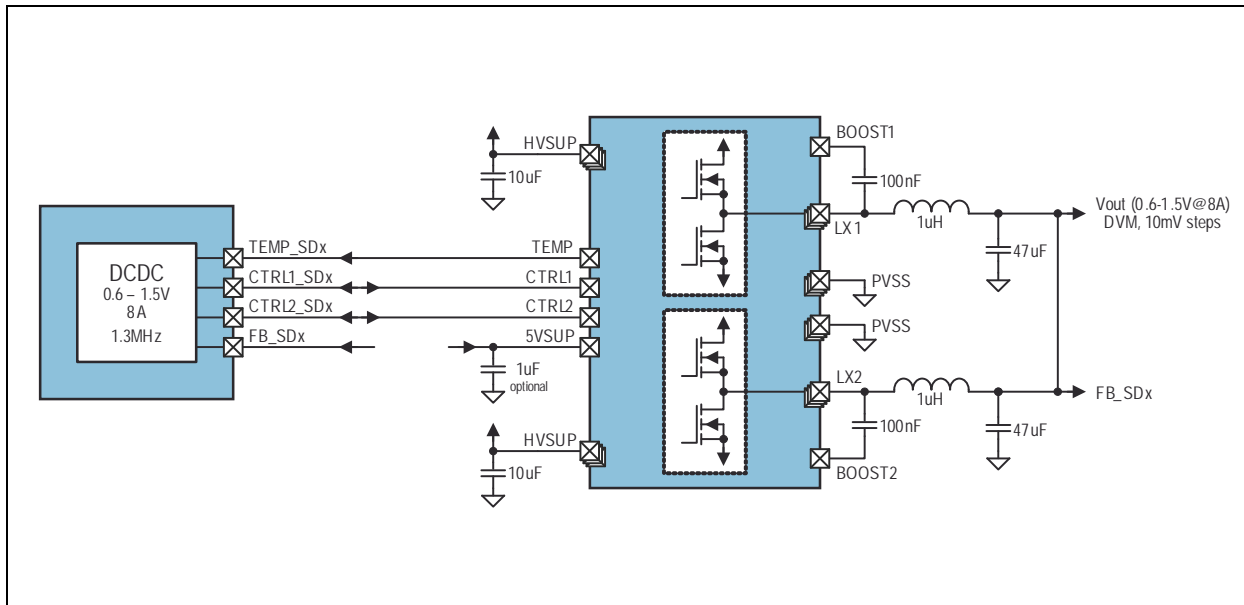

Typical Application: This figure shows the connection of the DCDC controller and the AS3728 Power Stage.

External Components

Figure 12:
Step Down DCDC Power Stage External Components

Symbol	Parameter	Min	Typ	Max	Units	Note
External Components Per Phase						
C_{FB}	Output Capacitor	64	82		μF	Ceramic X5R or X7R / 6.3V high performance
		32	47		μF	Ceramic X5R or X7R / 6.3V cost optimized
C_{HVSUP}	HV Input Capacitor	6	10		μF	Ceramic X5R or X7R / 25V
C_{BOOST}	Boost Capacitor		100		nF	Ceramic X5R or X7R / 6.3V
C_{5VSUP}	5V Supply Capacitor		1		μF	Ceramic X5R or X7R / 6.3V
L	Inductor	0.5	1		μH	5A rated, 1MHz operation, low R_{ON}

External Components: Shows the recommended values of the needed external components of the Step Down DCDC Power Stage.

PCB Layout

Figure 13:
Layout Guidelines

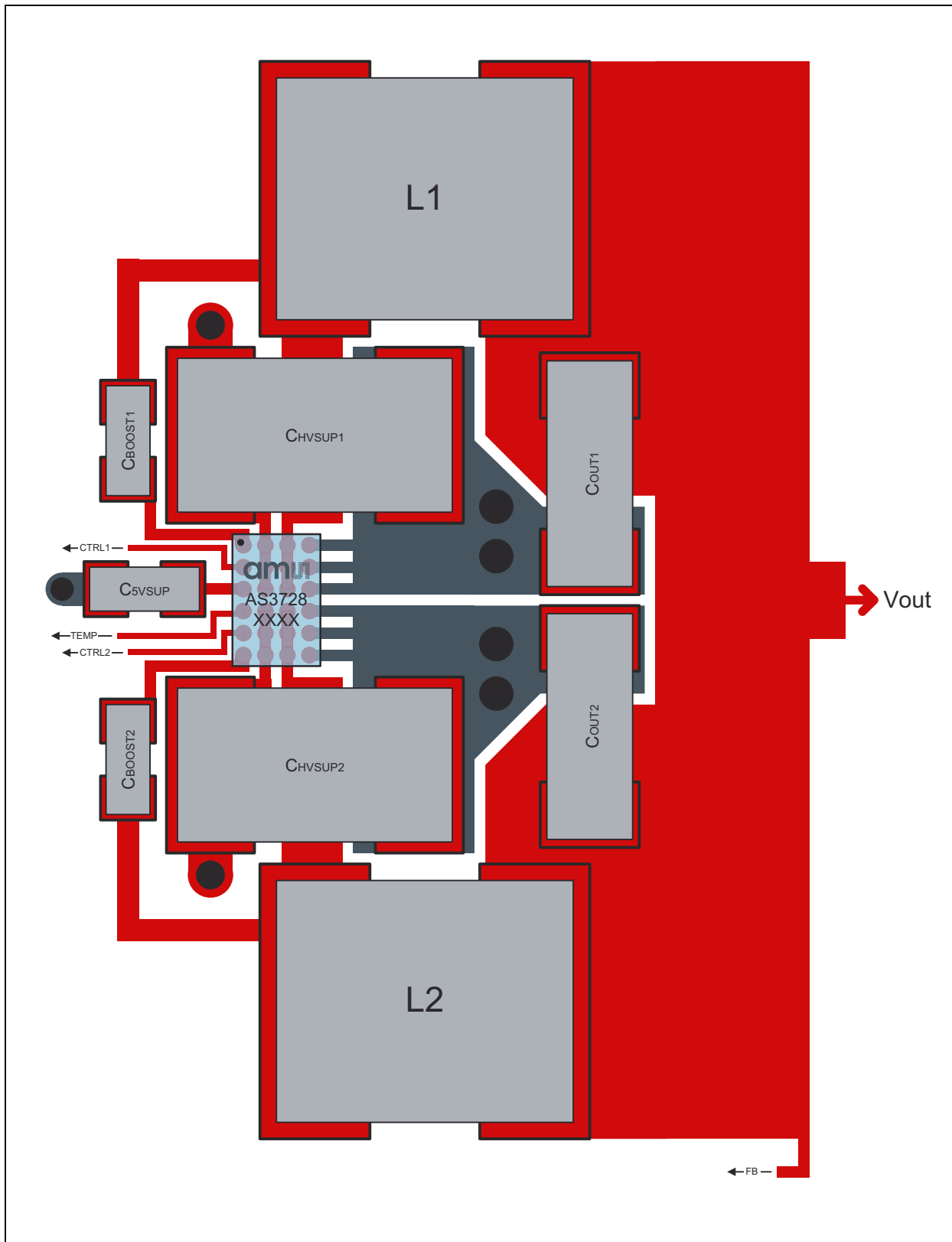

AS3728 – Layout Guidelines: This figure shows the recommended layout and placement of the external components for the 2-phase AS3728 Power Stage.

Package Drawings & Markings

Figure 14:
24 Balls WL-CSP With 0.4mm Pitch & Marking

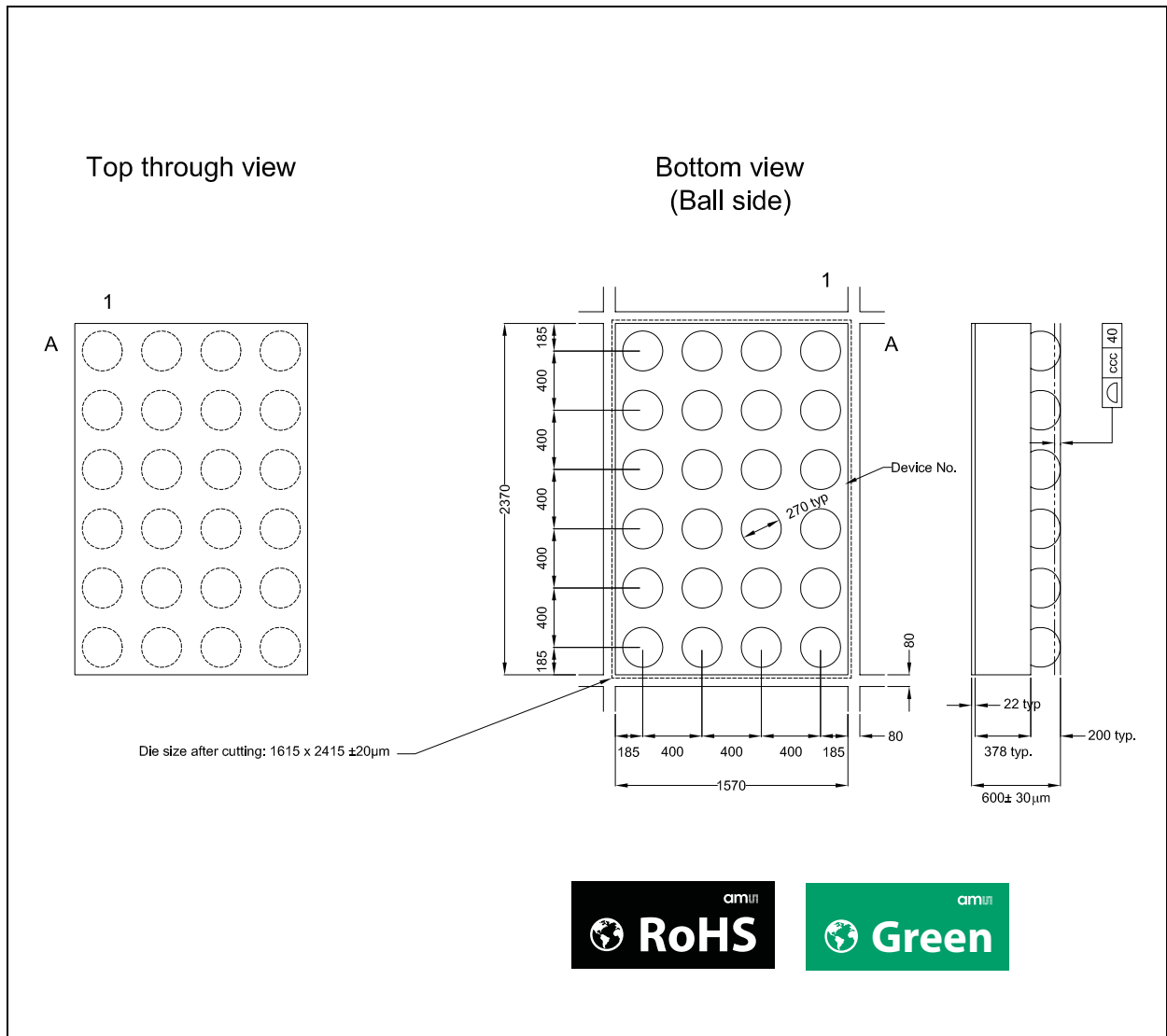

Note(s) and/or Footnote(s):

1. Pin1 = A1.
2. ccc Coplanarity.
3. All dimensions are in μm.

Figure 15:
AS3728 Marking

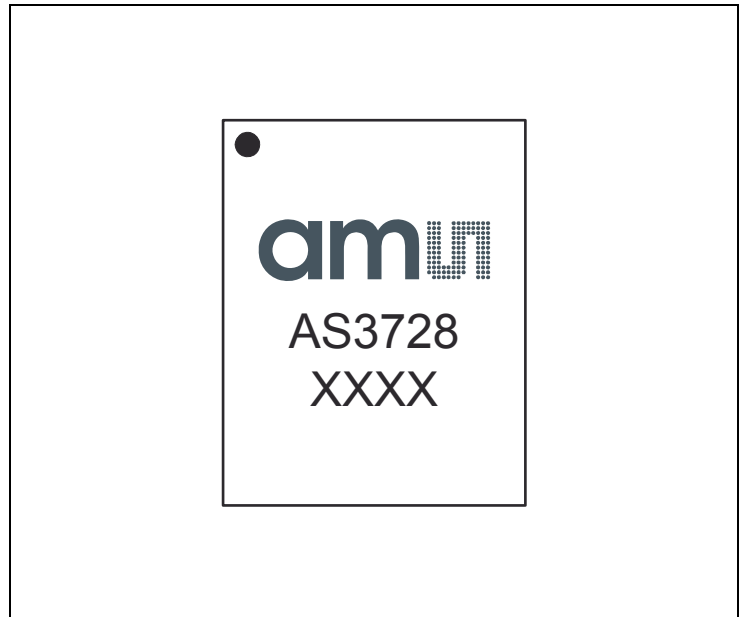

Figure 16:
AS3728 Package Code

XXXX
Tracecode

Ordering & Contact Information

Figure 17:
Ordering Information

Ordering Code	Description	Package	Delivery Form	Delivery Quantity
AS3728-BWLT	Power Stage for Multi-Phase DCDC	24-pin WL-CSP	Tape & Reel	12000 pcs/reel
AS3728-BWLM	Power Stage for Multi-Phase DCDC	24-pin WL-CSP	Mini T & R	500 pcs/reel

Buy our products or get free samples online at:
www.ams.com/ICdirect

Technical Support is available at:
www.ams.com/Technical-Support

Provide feedback about this document at:
www.ams.com/Document-Feedback

For further information and requests, e-mail us at:
ams_sales@ams.com

For sales offices, distributors and representatives, please visit:
www.ams.com/contact

Headquarters

ams AG
Tobelbaderstrasse 30
8141 Unterpremstaetten
Austria, Europe

Tel: +43 (0) 3136 500 0

Website: www.ams.com

RoHS Compliant & ams Green Statement

RoHS: The term RoHS compliant means that ams AG products fully comply with current RoHS directives. Our semiconductor products do not contain any chemicals for all 6 substance categories, including the requirement that lead not exceed 0.1% by weight in homogeneous materials. Where designed to be soldered at high temperatures, RoHS compliant products are suitable for use in specified lead-free processes.

ams Green (RoHS compliant and no Sb/Br): ams Green defines that in addition to RoHS compliance, our products are free of Bromine (Br) and Antimony (Sb) based flame retardants (Br or Sb do not exceed 0.1% by weight in homogeneous material).

Important Information: The information provided in this statement represents ams AG knowledge and belief as of the date that it is provided. ams AG bases its knowledge and belief on information provided by third parties, and makes no representation or warranty as to the accuracy of such information. Efforts are underway to better integrate information from third parties. ams AG has taken and continues to take reasonable steps to provide representative and accurate information but may not have conducted destructive testing or chemical analysis on incoming materials and chemicals. ams AG and ams AG suppliers consider certain information to be proprietary, and thus CAS numbers and other limited information may not be available for release.

Copyrights & Disclaimer

Copyright ams AG, Tobelbader Strasse 30, 8141 Unterpremstaetten, Austria-Europe. Trademarks Registered. All rights reserved. The material herein may not be reproduced, adapted, merged, translated, stored, or used without the prior written consent of the copyright owner.

Devices sold by ams AG are covered by the warranty and patent indemnification provisions appearing in its General Terms of Trade. ams AG makes no warranty, express, statutory, implied, or by description regarding the information set forth herein. ams AG reserves the right to change specifications and prices at any time and without notice. Therefore, prior to designing this product into a system, it is necessary to check with ams AG for current information. This product is intended for use in commercial applications. Applications requiring extended temperature range, unusual environmental requirements, or high reliability applications, such as military, medical life-support or life-sustaining equipment are specifically not recommended without additional processing by ams AG for each application. This product is provided by ams AG "AS IS" and any express or implied warranties, including, but not limited to the implied warranties of merchantability and fitness for a particular purpose are disclaimed.

ams AG shall not be liable to recipient or any third party for any damages, including but not limited to personal injury, property damage, loss of profits, loss of use, interruption of business or indirect, special, incidental or consequential damages, of any kind, in connection with or arising out of the furnishing, performance or use of the technical data herein. No obligation or liability to recipient or any third party shall arise or flow out of ams AG rendering of technical or other services.

Document Status

Document Status	Product Status	Definition
Product Preview	Pre-Development	Information in this datasheet is based on product ideas in the planning phase of development. All specifications are design goals without any warranty and are subject to change without notice
Preliminary Datasheet	Pre-Production	Information in this datasheet is based on products in the design, validation or qualification phase of development. The performance and parameters shown in this document are preliminary without any warranty and are subject to change without notice
Datasheet	Production	Information in this datasheet is based on products in ramp-up to full production or full production which conform to specifications in accordance with the terms of ams AG standard warranty as given in the General Terms of Trade
Datasheet (discontinued)	Discontinued	Information in this datasheet is based on products which conform to specifications in accordance with the terms of ams AG standard warranty as given in the General Terms of Trade, but these products have been superseded and should not be used for new designs

Revision Information

Changes from 1-02 (2014-Dec-16) to current revision 1-03 (2015-Aug-31)	Page
Updated Package Drawings & Markings section	11
Updated Figure 17	13

Note(s) and/or Footnote(s):

1. Page and figure numbers for the previous version may differ from page and figure numbers in the current revision.
2. Correction of typographical errors is not explicitly mentioned.

Content Guide

1	General Description
1	Key Benefits & Features
1	Applications
2	Block Diagram
3	Pin Assignment
4	Absolute Maximum Ratings
6	Electrical Characteristics
7	Typical Operating Characteristics
9	Application Information
9	External Components
10	PCB Layout
11	Package Drawings & Markings
13	Ordering & Contact Information
14	RoHS Compliant & ams Green Statement
15	Copyrights & Disclaimer
16	Document Status
17	Revision Information

Данный компонент на территории Российской Федерации

Вы можете приобрести в компании MosChip.

Для оперативного оформления запроса Вам необходимо перейти по данной ссылке:

<http://moschip.ru/get-element>

Вы можете разместить у нас заказ для любого Вашего проекта, будь то серийное производство или разработка единичного прибора.

В нашем ассортименте представлены ведущие мировые производители активных и пассивных электронных компонентов.

Нашей специализацией является поставка электронной компонентной базы двойного назначения, продукции таких производителей как XILINX, Intel (ex.ALTERA), Vicor, Microchip, Texas Instruments, Analog Devices, Mini-Circuits, Amphenol, Glenair.

Сотрудничество с глобальными дистрибьюторами электронных компонентов, предоставляет возможность заказывать и получать с международных складов практически любой перечень компонентов в оптимальные для Вас сроки.

На всех этапах разработки и производства наши партнеры могут получить квалифицированную поддержку опытных инженеров.

Система менеджмента качества компании отвечает требованиям в соответствии с ГОСТ Р ИСО 9001, ГОСТ РВ 0015-002 и ЭС РД 009

Офис по работе с юридическими лицами:

105318, г.Москва, ул.Щербаковская д.3, офис 1107, 1118, ДЦ «Щербаковский»

Телефон: +7 495 668-12-70 (многоканальный)

Факс: +7 495 668-12-70 (доб.304)

E-mail: info@moschip.ru

Skype отдела продаж:

moschip.ru

moschip.ru_4

moschip.ru_6

moschip.ru_9