

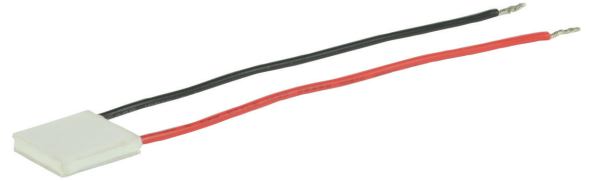

SERIES: CP60H | **DESCRIPTION:** PELTIER MODULE

FEATURES

- arcTEC™ structure on select models
- enhanced reliability for high thermal cycling
- superior thermal performance
- silicon sealed
- wide ΔT max
- low profile
- precise temperature control
- solid state construction

MODEL

| MODEL | input voltage ¹ max (Vdc) | input current ² max (A) | internal resistance ³ typ ($\Omega \pm 10\%$) | output Qmax ⁴ | | output ΔT max ⁵ | |
|---------------------------|--|--|--|-----------------------------|-----------------------------|------------------------------------|------------------------------|
| | | | | T _h =27°C (W) | T _h =50°C (W) | T _h =27°C (°C) | T _h =50°C (°C) |
| CP60131H | 3.8 | 6.0 | 0.45 | 13 | 14.3 | 70 | 77 |
| CP60139H | 2.1 | 6.0 | 0.30 | 7.4 | 8.2 | 70 | 77 |
| CP60231H | 8.8 | 6.0 | 1.05 | 29.7 | 32.7 | 70 | 77 |
| CP60239H | 3.8 | 6.0 | 0.55 | 13.6 | 14.9 | 70 | 77 |
| CP602040395H ⁶ | 7.6 | 6.0 | 1.09 | 27.5 | 30.2 | 70 | 77 |
| CP60301233H | 5.6 | 6.0 | 0.76 | 19.7 | 21.7 | 70 | 77 |
| CP60301531H | 7.6 | 6.0 | 0.93 | 26.3 | 28.9 | 70 | 77 |
| CP603315H ⁶ | 15.7 | 6.0 | 1.90 | 53.1 | 59.1 | 70 | 77 |
| CP603395H ⁶ | 8.8 | 6.0 | 1.25 | 31.1 | 34.2 | 70 | 77 |
| CP604020395H ⁶ | 7.6 | 6.0 | 1.09 | 27.5 | 30.2 | 70 | 77 |
| CP60433H ⁶ | 19.5 | 6.0 | 2.54 | 67.6 | 74.3 | 68 | 75 |
| CP604395H ⁶ | 15.7 | 6.0 | 2.2 | 55.6 | 61.0 | 70 | 77 |

- Notes:
1. Maximum voltage at ΔT max and T_h=27°C
 2. Maximum current to achieve ΔT max
 3. Measured by AC 4-terminal method at 25°C
 4. Maximum heat absorbed at cold side occurs at I_{max}, V_{max}, and $\Delta T=0^\circ\text{C}$
 5. Maximum temperature difference occurs at I_{max}, V_{max}, and Q=0W (ΔT max measured in a vacuum at 1.3 Pa)
 6. Designed with arcTEC™ structure.

SPECIFICATIONS

| parameter | conditions/description | min | typ | max | units |
|----------------------------|---|-----|-----|-----|-------|
| solder melting temperature | connection between thermoelectric pairs | 235 | | | °C |
| assembly compression | | | | 1 | MPa |
| hot side plate | | | | 80 | °C |
| RoHS | 2011/65/EU | | | | |

MECHANICAL DRAWING

units: mm

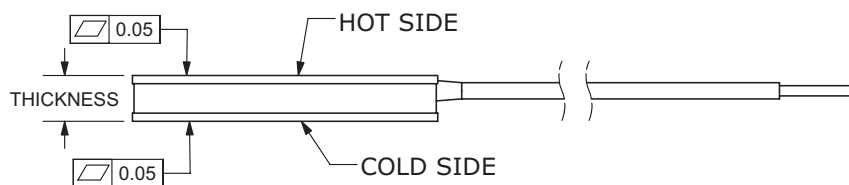

| | MATERIAL | PLATING |
|---|--|---------|
| ceramic plate | 96% AL ₂ O ₃ | |
| wire leads (CP60131H, CP60231H, CP60301233H, CP60301531H, CP603315H) | 22 AWG | tin |
| wire leads (all other models) | 20 AWG | tin |
| sealer | silicon rubber 703 RTV (between cold and hot side plates) | |
| joint cover | silicon rubber 703 RTV | |
| marking | P/N & S/N printed on cold side surface | |

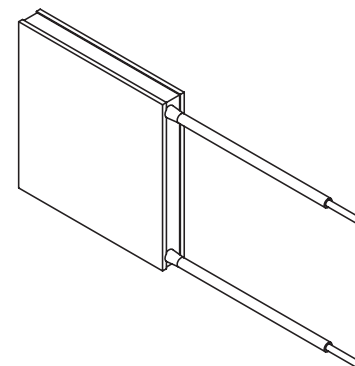
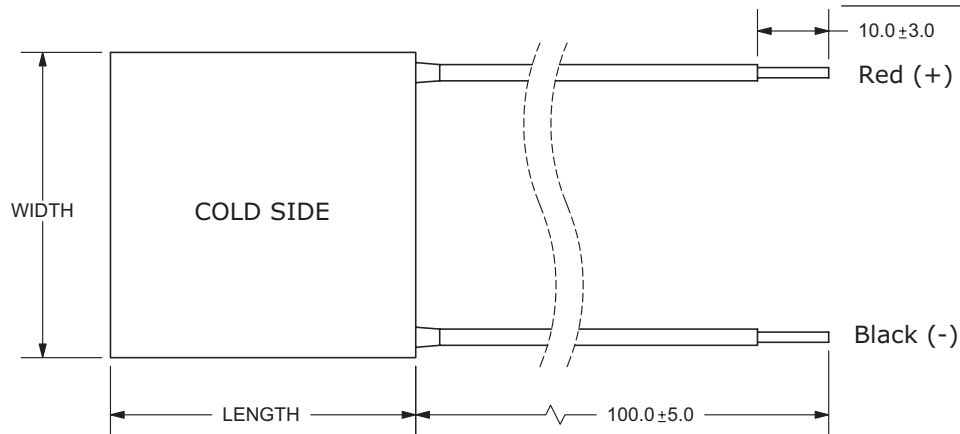

| MODEL NO. | LENGTH (mm) | WIDTH (mm) | THICKNESS (mm) |
|--------------|-------------|------------|----------------|
| CP60131H | 15 ±0.3 | 15 ±0.3 | 3.1 ±0.025 |
| CP60139H | 15 ±0.3 | 15 ±0.3 | 3.9 ±0.025 |
| CP60231H | 20 ±0.3 | 20 ±0.3 | 3.1 ±0.025 |
| CP60239H | 20 ±0.3 | 20 ±0.3 | 3.9 ±0.025 |
| CP602040395H | 20 ±0.3 | 40 ±0.3 | 3.95 ±0.025 |
| CP60301233H | 30 ±0.1 | 12 ±0.1 | 3.3 ±0.1 |
| CP60301531H | 30 ±0.3 | 15 ±0.3 | 3.1 ±0.025 |
| CP603315H | 30 ±0.3 | 30 ±0.3 | 3.15 ±0.025 |
| CP603395H | 30 ±0.3 | 30 ±0.3 | 3.95 ±0.025 |
| CP604020395H | 40 ±0.3 | 20 ±0.3 | 3.95 ±0.025 |
| CP60433H | 40 ±0.3 | 40 ±0.3 | 3.3 ±0.03 |
| CP604395H | 40 ±0.3 | 40 ±0.3 | 3.95 ±0.025 |

CP60131H PERFORMANCE (Th=27°C)

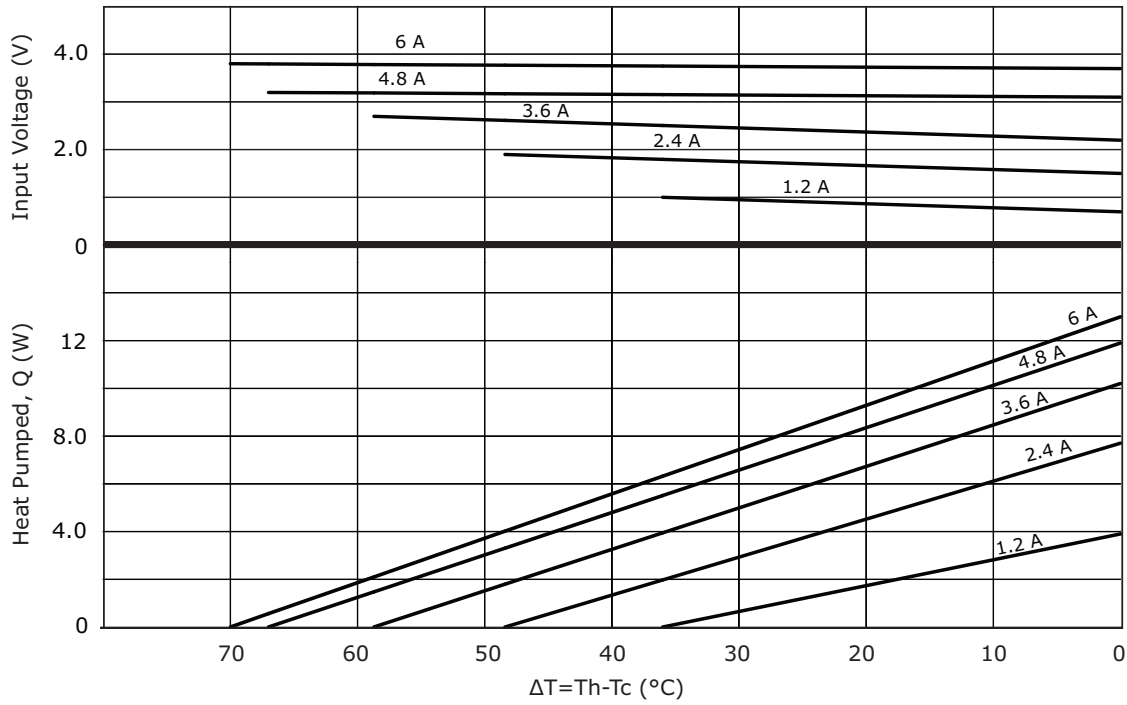

CP60131H PERFORMANCE (Th=50°C)

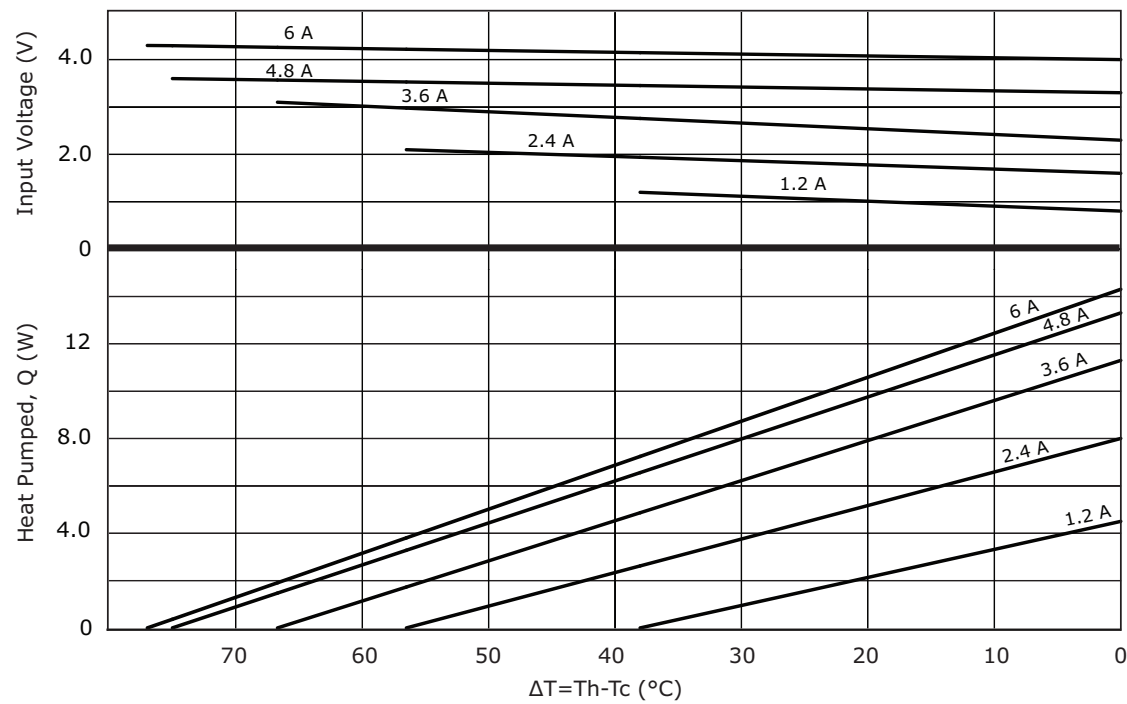

CP60139H PERFORMANCE (Th=27°C)

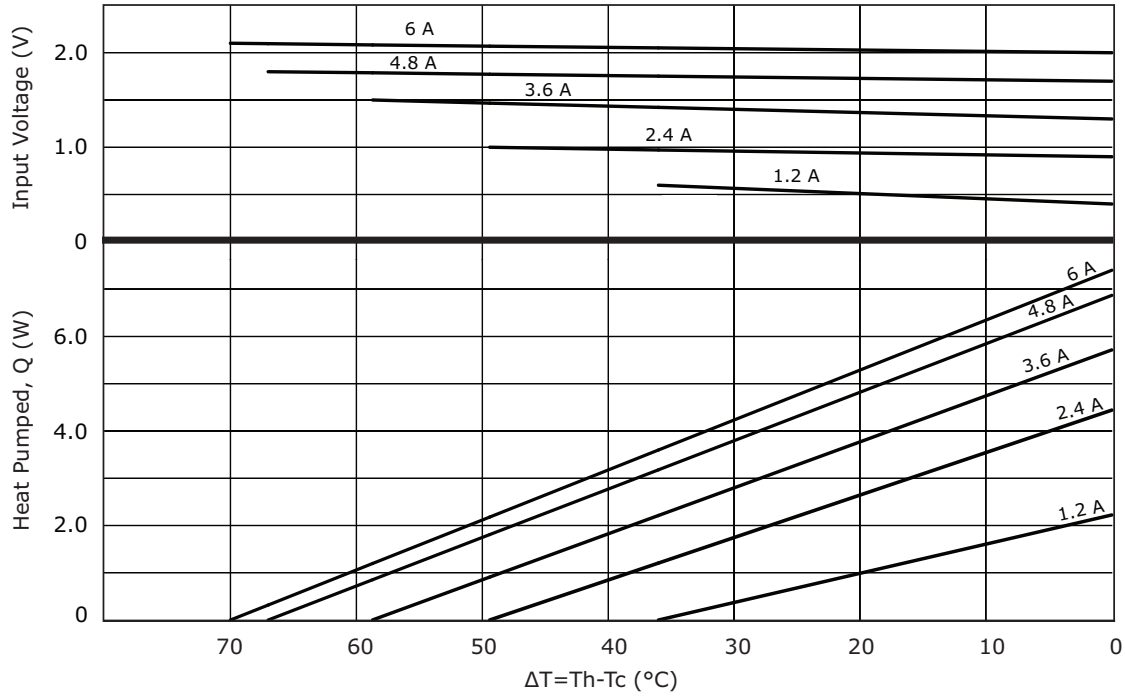

CP60139H PERFORMANCE (Th=50°C)

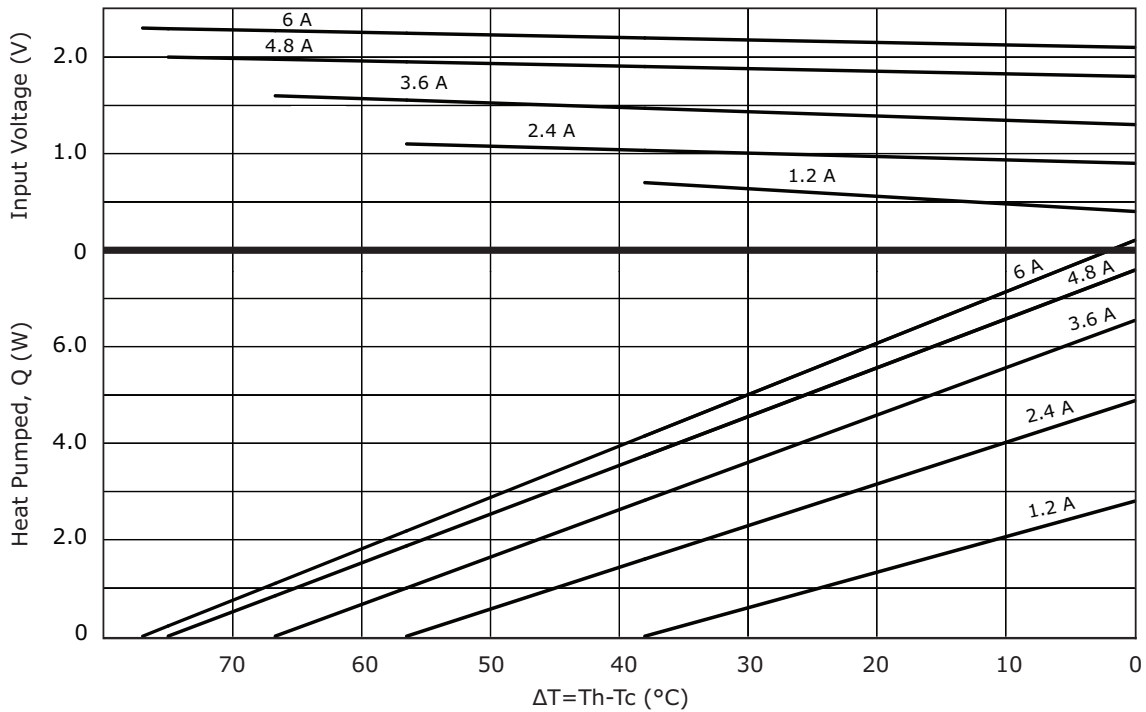

CP60231H PERFORMANCE (Th=27°C)

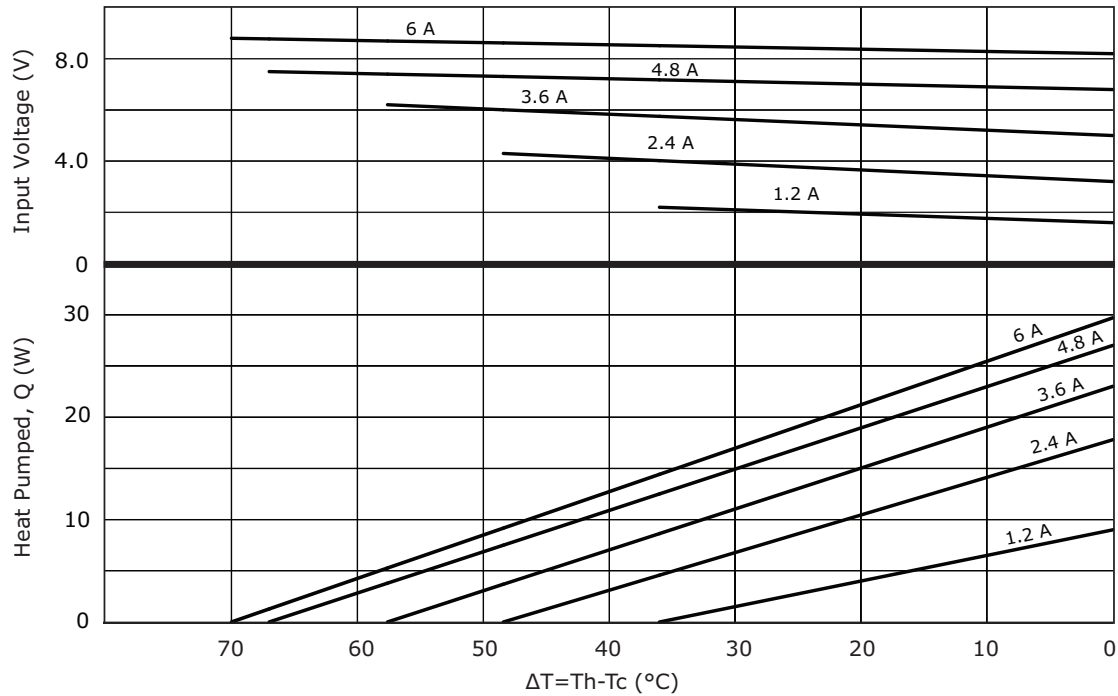

CP60231H PERFORMANCE (Th=50°C)

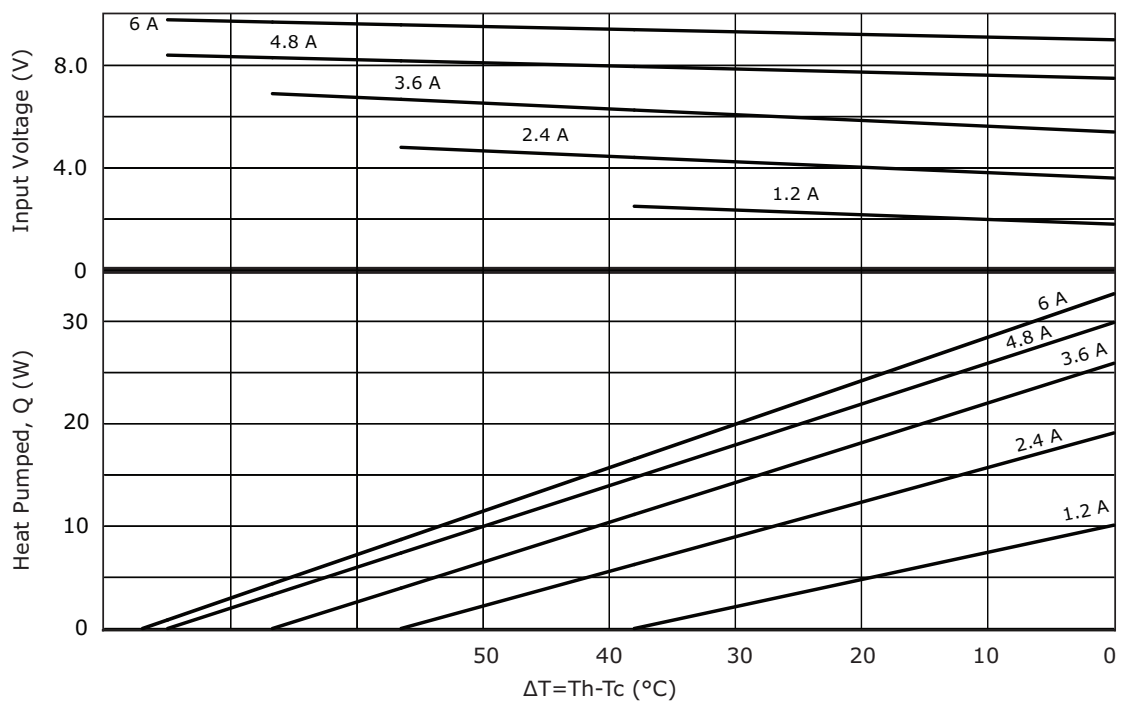

CP60239H PERFORMANCE (Th=27°C)

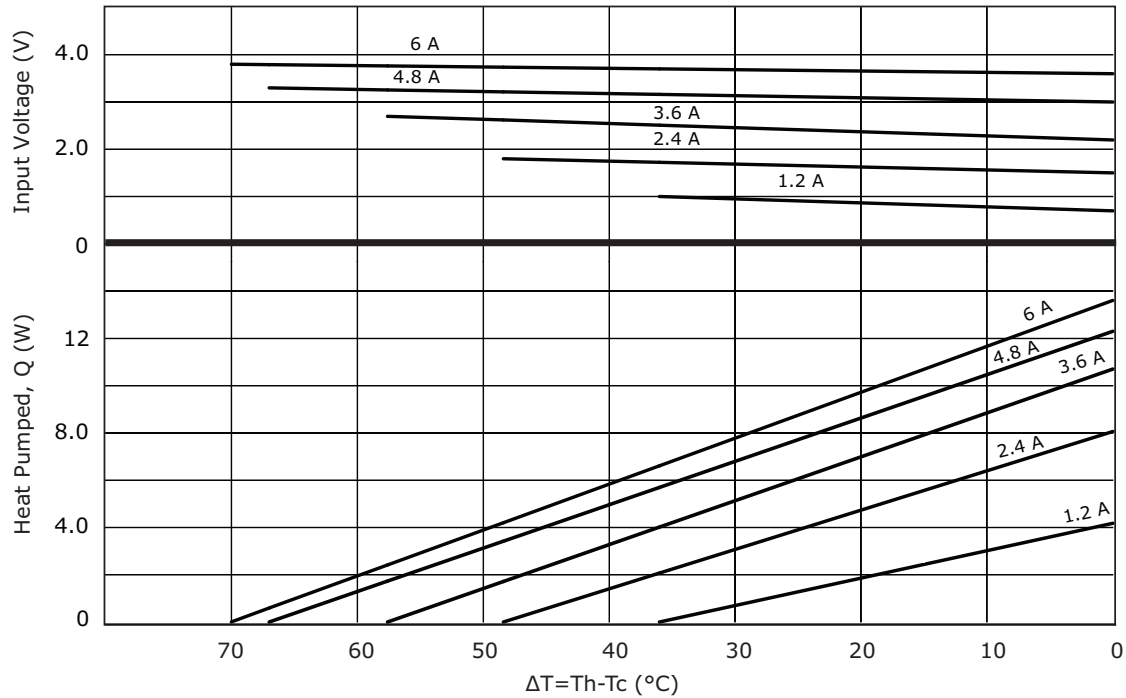

CP60239H PERFORMANCE (Th=50°C)

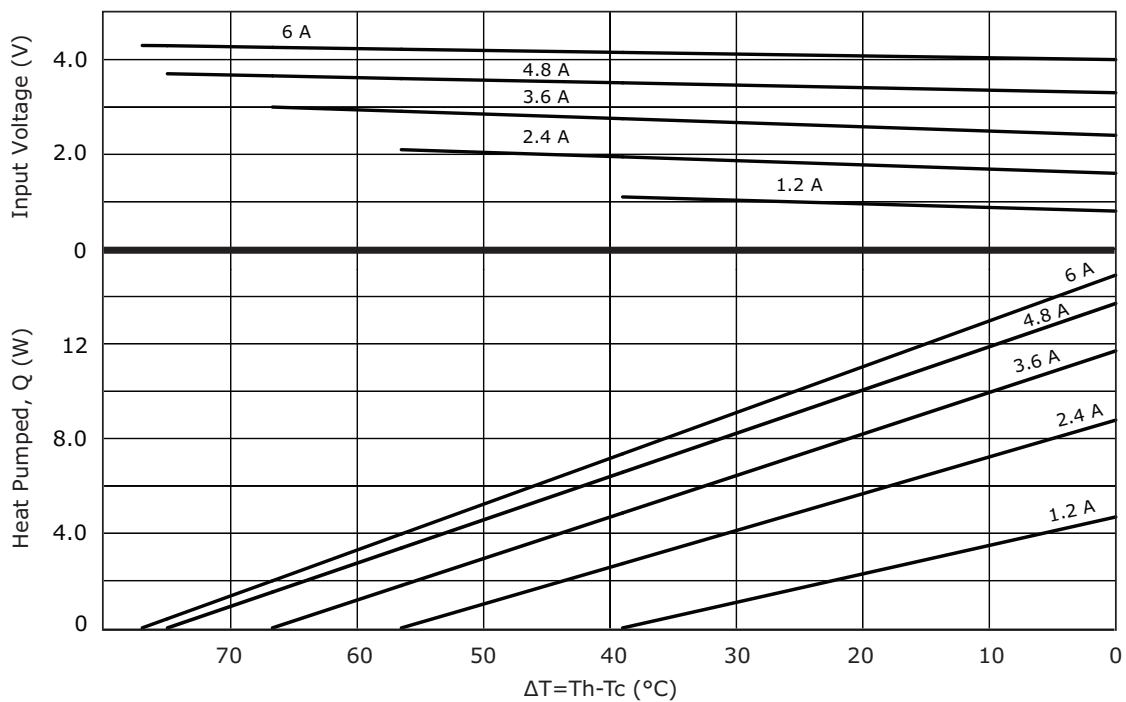

CP602040395H PERFORMANCE (Th=27°C)

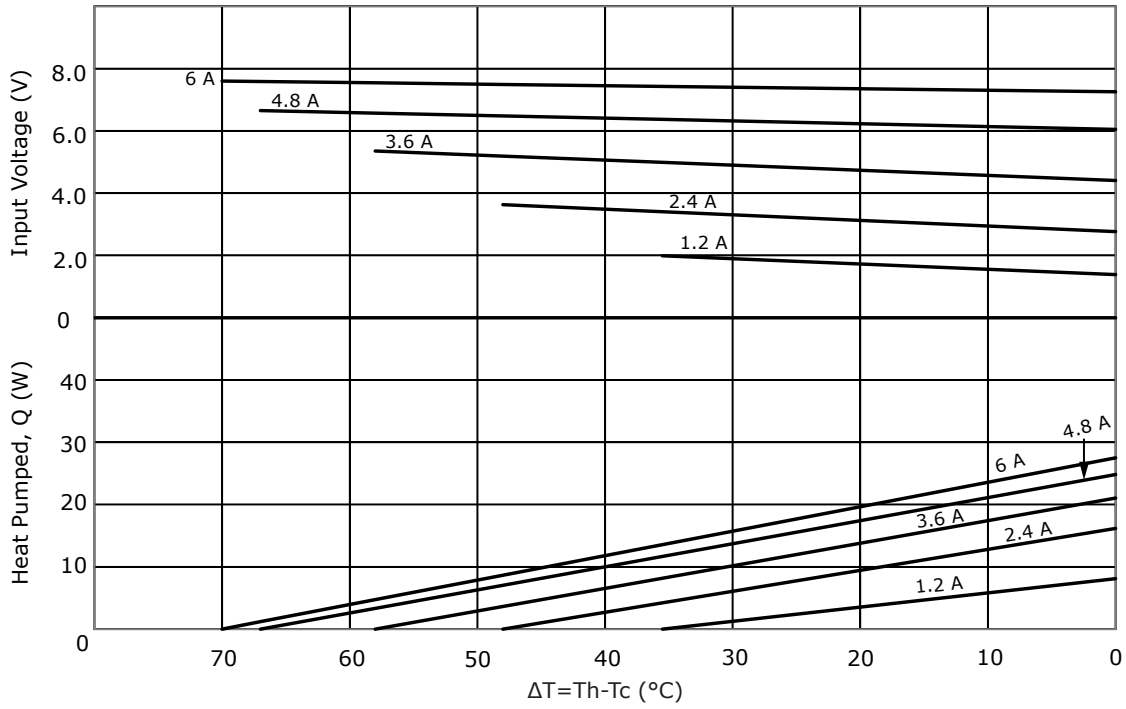

CP602040395H PERFORMANCE (Th=50°C)

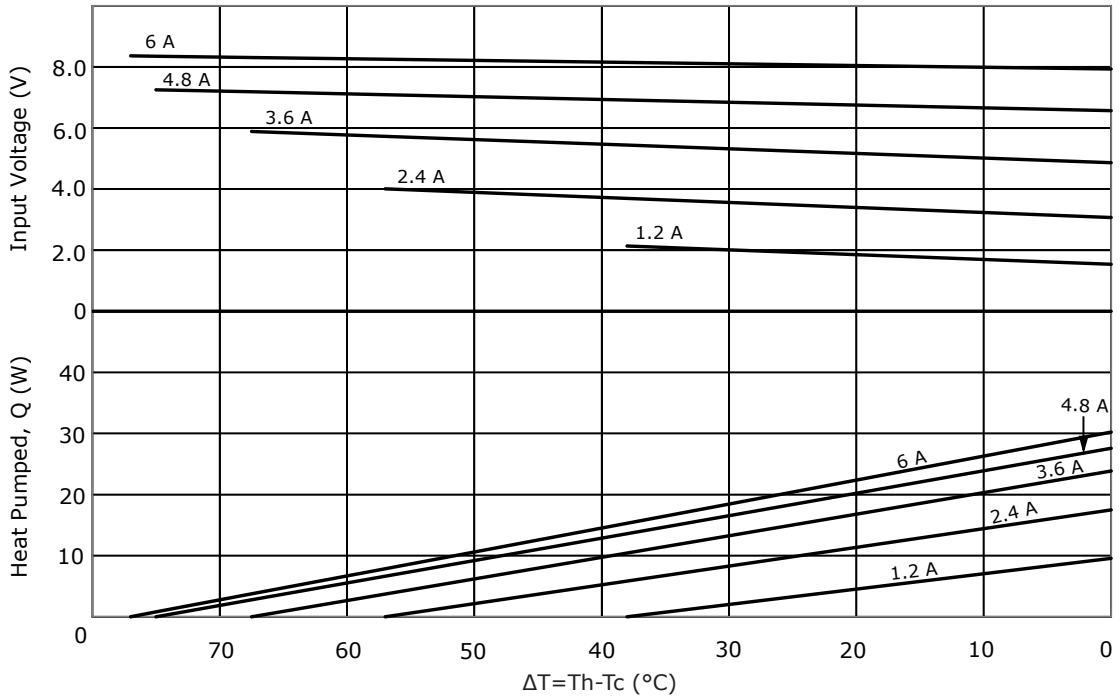

CP60301233H PERFORMANCE (Th=27°C)

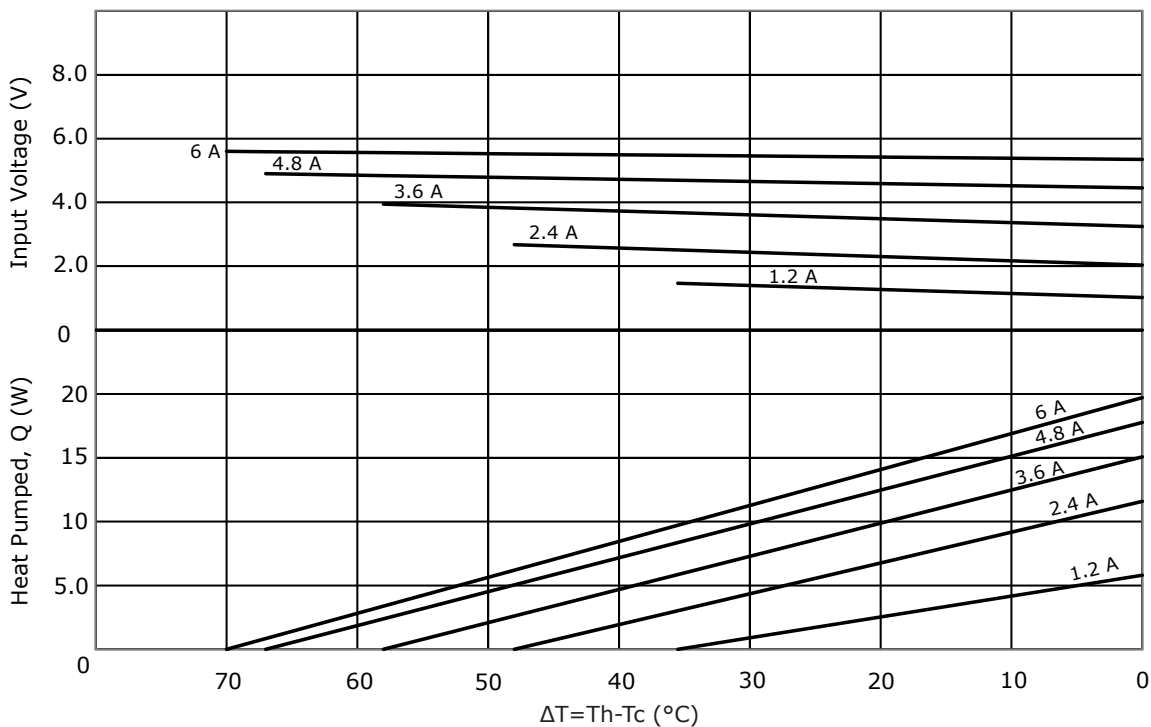

CP60301233H PERFORMANCE (Th=50°C)

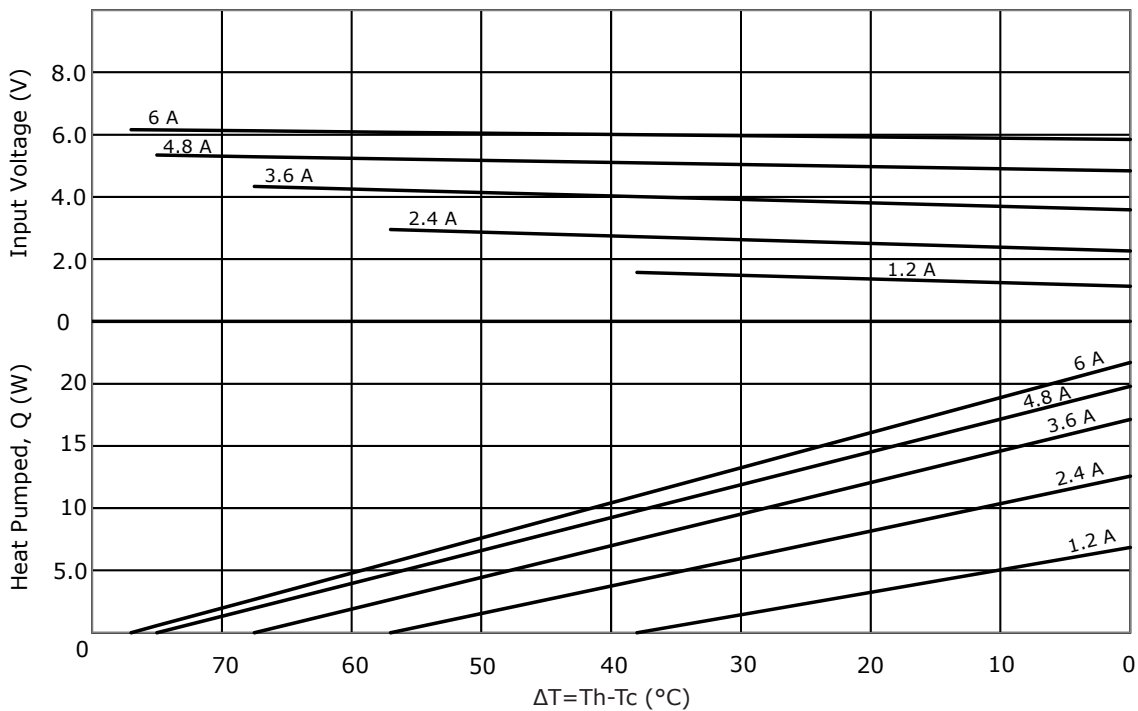

CP60301531H PERFORMANCE (Th=27°C)

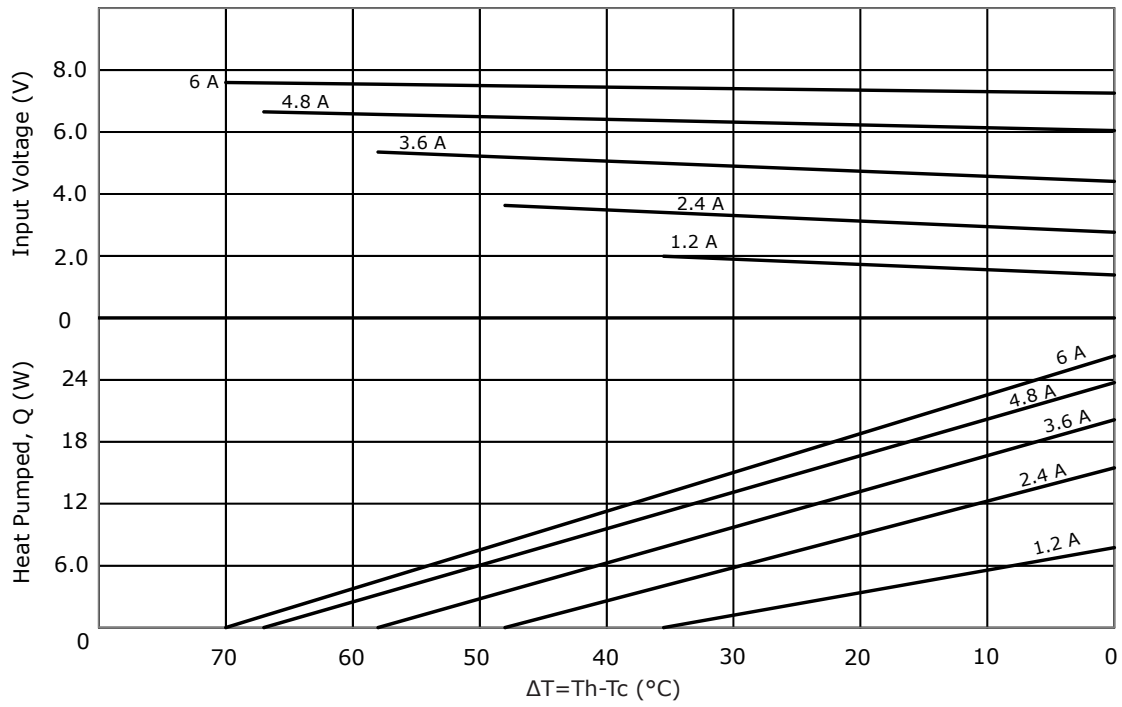

CP60301531H PERFORMANCE (Th=50°C)

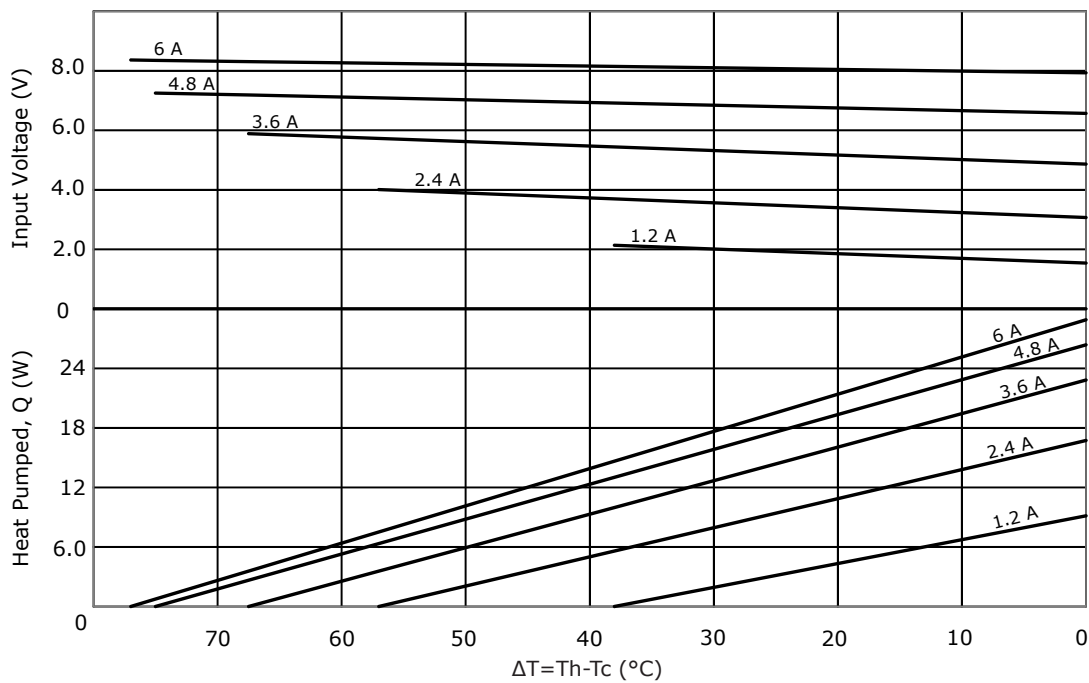

CP603315H PERFORMANCE (Th=27°C)

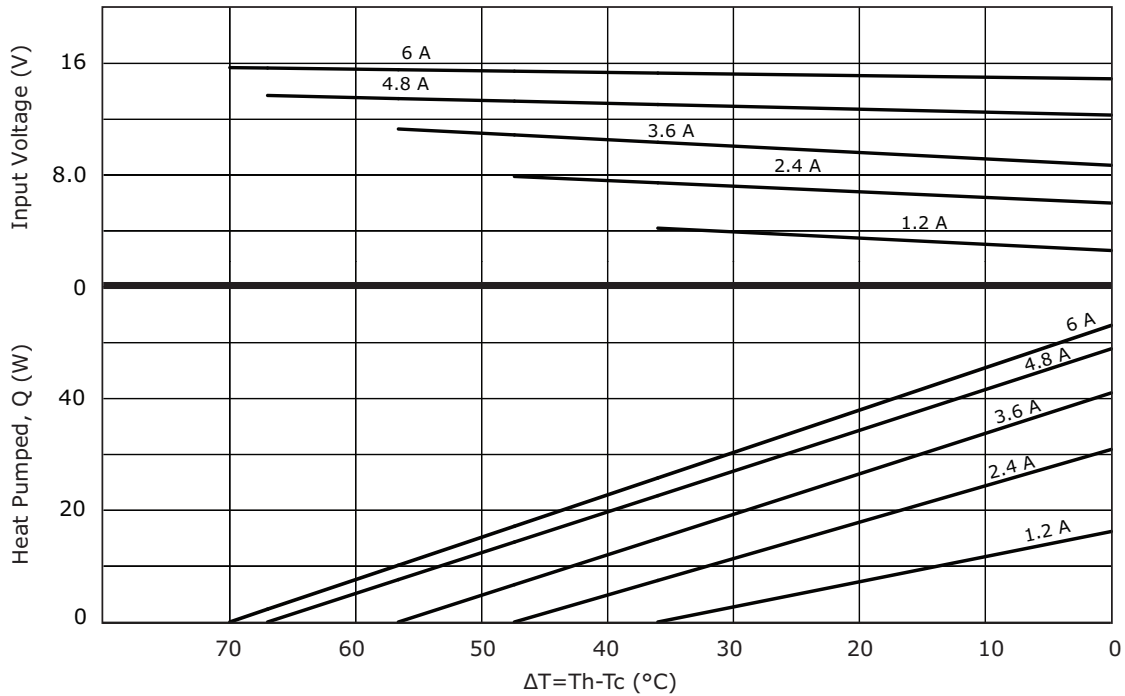

CP603315H PERFORMANCE (Th=50°C)

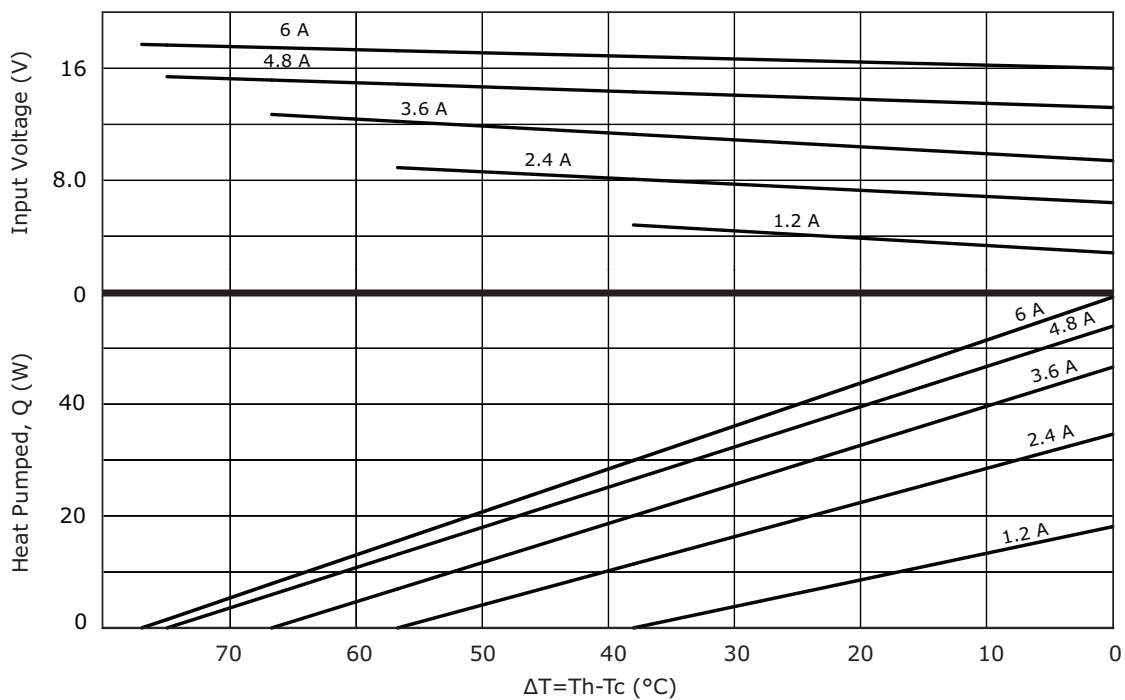

CP603395H PERFORMANCE (Th=27°C)

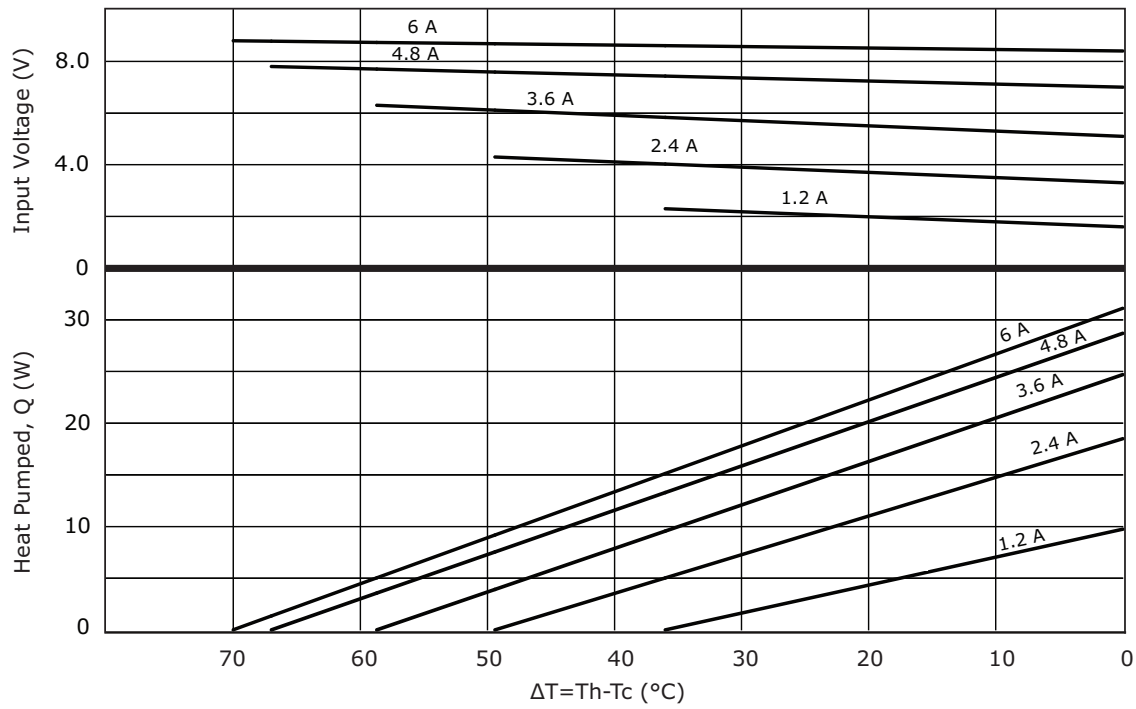

CP603395H PERFORMANCE (Th=50°C)

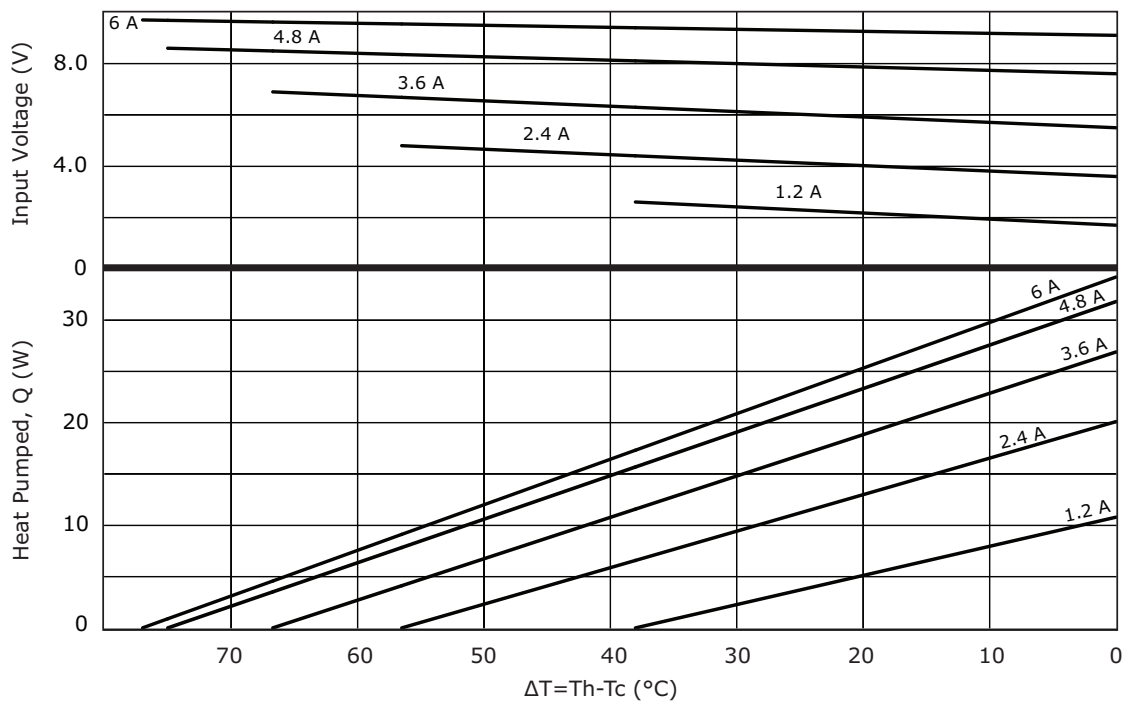

CP604020395H PERFORMANCE (Th=27°C)

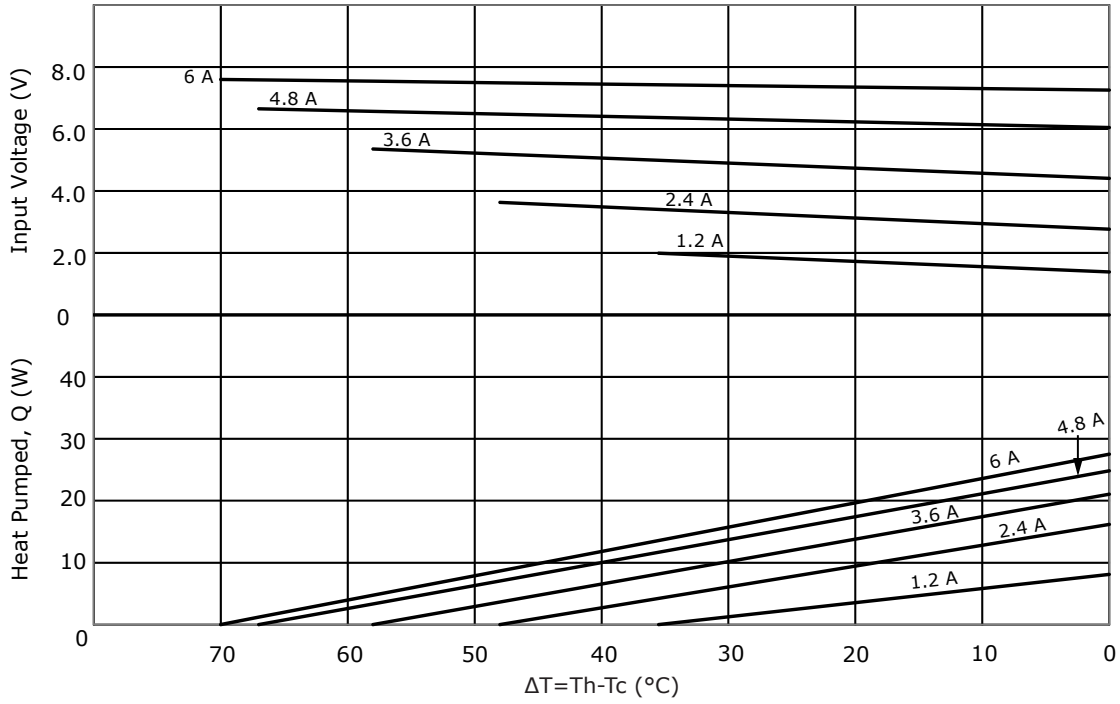

CP604020395H PERFORMANCE (Th=50°C)

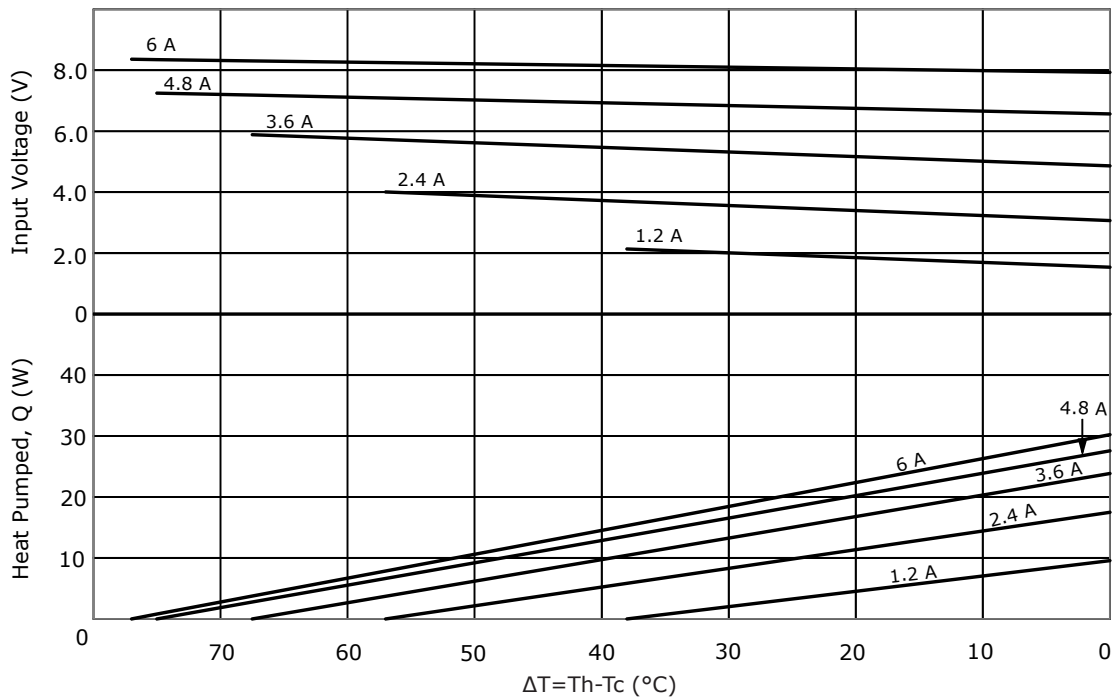

CP60433H PERFORMANCE (Th=27°C)

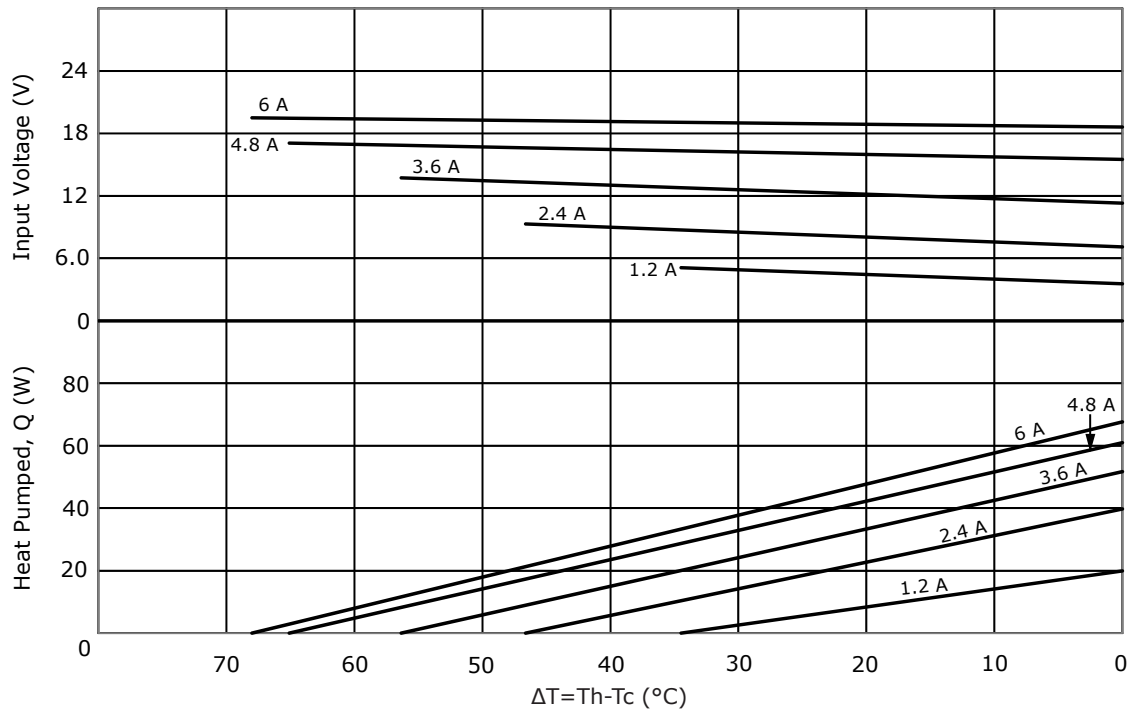

CP60433H PERFORMANCE (Th=50°C)

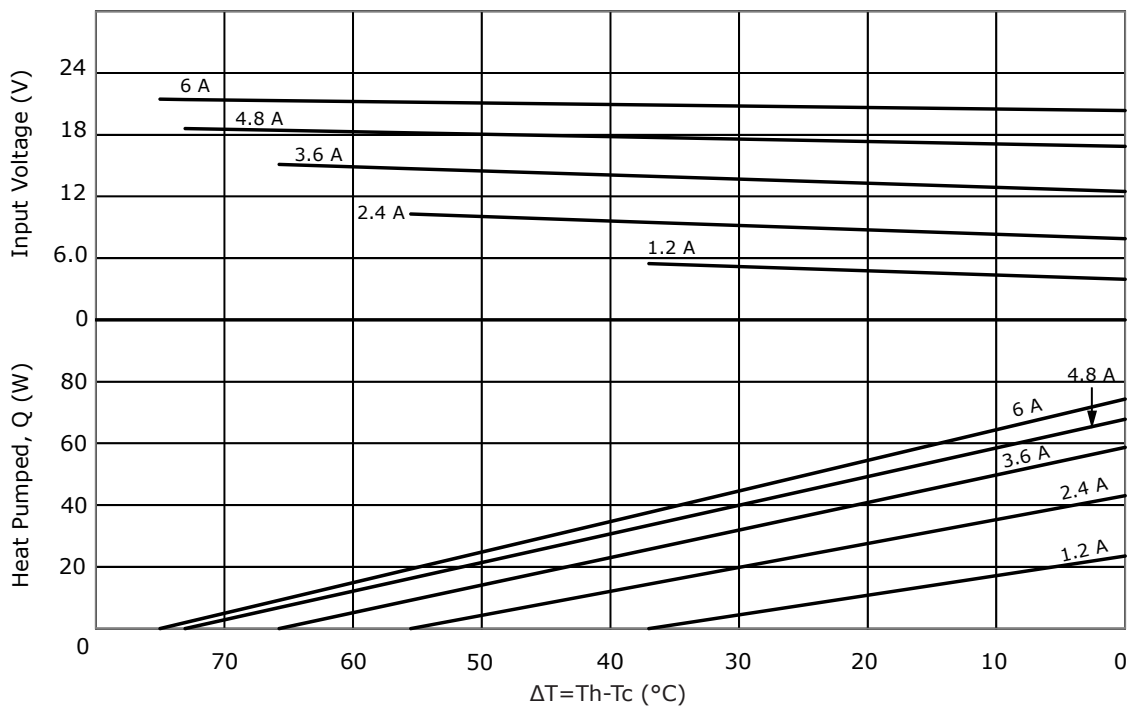

CP604395H PERFORMANCE (Th=27°C)

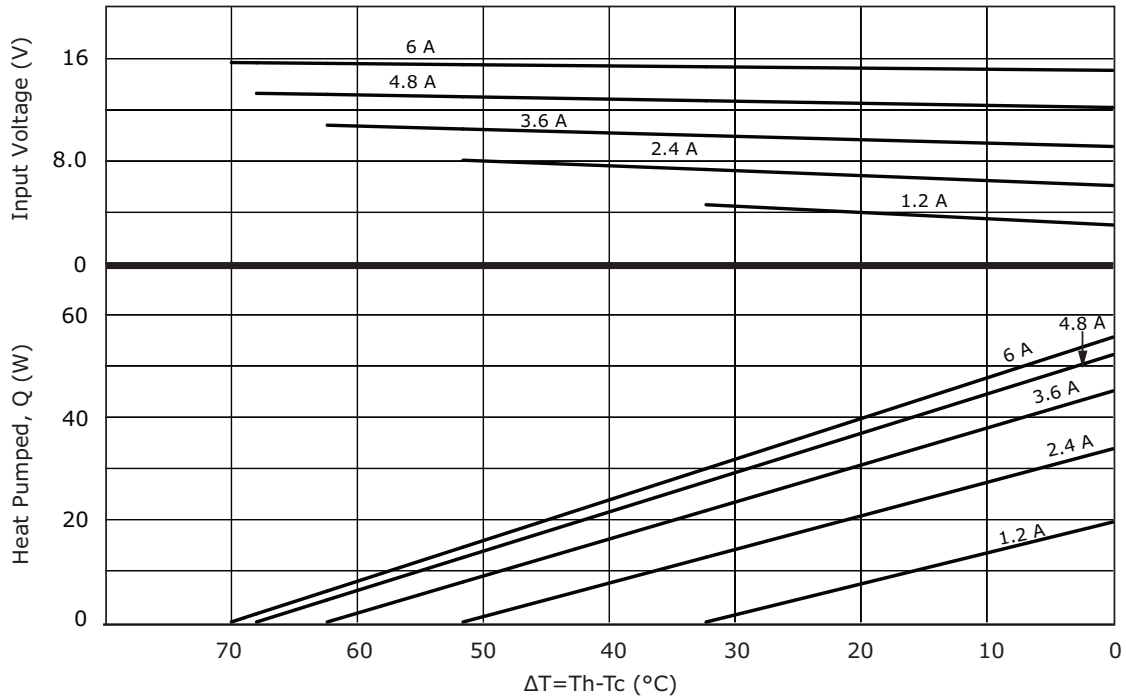

CP604395H PERFORMANCE (Th=50°C)

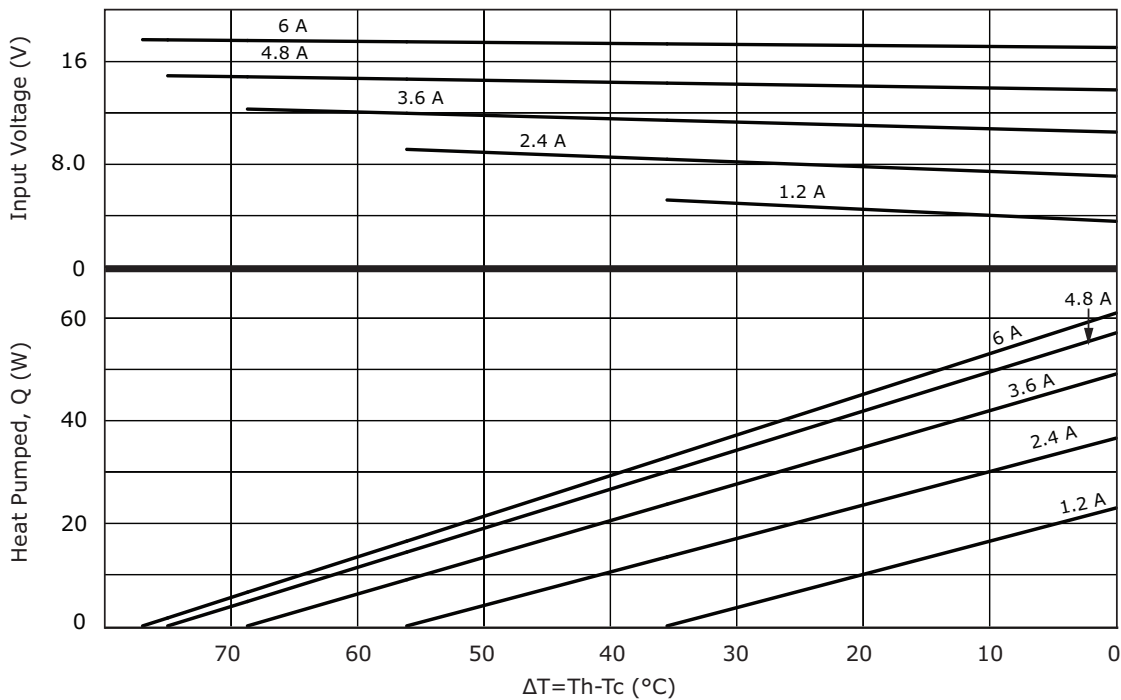

REVISION HISTORY

| rev. | description | date |
|------|-------------------|------------|
| 1.0 | initial release | 09/08/2016 |
| 1.01 | updated datasheet | 09/25/2017 |
| 1.02 | added new models | 05/21/2018 |

The revision history provided is for informational purposes only and is believed to be accurate.

**CUI INC**[®]

Headquarters
20050 SW 112th Ave.
Tualatin, OR 97062
800.275.4899

Fax 503.612.2383
cui.com
techsupport@cui.com

CUI offers a one (1) year limited warranty. Complete warranty information is listed on our website.

CUI reserves the right to make changes to the product at any time without notice. Information provided by CUI is believed to be accurate and reliable. However, no responsibility is assumed by CUI for its use, nor for any infringements of patents or other rights of third parties which may result from its use.

CUI products are not authorized or warranted for use as critical components in equipment that requires an extremely high level of reliability. A critical component is any component of a life support device or system whose failure to perform can be reasonably expected to cause the failure of the life support device or system, or to affect its safety or effectiveness.

Данный компонент на территории Российской Федерации

Вы можете приобрести в компании MosChip.

Для оперативного оформления запроса Вам необходимо перейти по данной ссылке:

<http://moschip.ru/get-element>

Вы можете разместить у нас заказ для любого Вашего проекта, будь то серийное производство или разработка единичного прибора.

В нашем ассортименте представлены ведущие мировые производители активных и пассивных электронных компонентов.

Нашей специализацией является поставка электронной компонентной базы двойного назначения, продукции таких производителей как XILINX, Intel (ex.ALTERA), Vicor, Microchip, Texas Instruments, Analog Devices, Mini-Circuits, Amphenol, Glenair.

Сотрудничество с глобальными дистрибьюторами электронных компонентов, предоставляет возможность заказывать и получать с международных складов практически любой перечень компонентов в оптимальные для Вас сроки.

На всех этапах разработки и производства наши партнеры могут получить квалифицированную поддержку опытных инженеров.

Система менеджмента качества компании отвечает требованиям в соответствии с ГОСТ Р ИСО 9001, ГОСТ РВ 0015-002 и ЭС РД 009

Офис по работе с юридическими лицами:

105318, г.Москва, ул.Щербаковская д.3, офис 1107, 1118, ДЦ «Щербаковский»

Телефон: +7 495 668-12-70 (многоканальный)

Факс: +7 495 668-12-70 (доб.304)

E-mail: info@moschip.ru

Skype отдела продаж:

moschip.ru

moschip.ru_4

moschip.ru_6

moschip.ru_9