

Analog Devices Welcomes Hittite Microwave Corporation

NO CONTENT ON THE ATTACHED DOCUMENT HAS CHANGED



THIS PAGE INTENTIONALLY LEFT BLANK

HMC995LP5GE

GaAs pHEMT MMIC 3 WATT POWER AMPLIFIER SMT WITH POWER DETECTOR, 12 - 16 GHz

Typical Applications

The HMC995LP5GE is ideal for:

- Point-to-Point Radios
- Point-to-Multi-Point Radios
- VSAT & SATCOM
- Military & Space

Features

- Integrated Power Detector
- Saturated Output Power: 35.5 dBm @ 24% PAE
- High Output IP3: 41 dBm
- High Gain: 27 dB
- DC Supply: +5V to +7V @ 1200 mA
- No External Matching Required

Functional Diagram

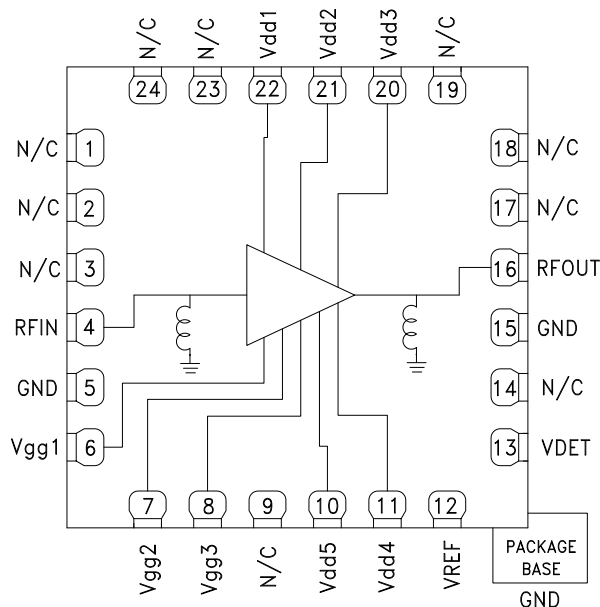

General Description

The HMC995LP5GE is a 4 stage GaAs pHEMT MMIC 2 Watt Power Amplifier with an integrated temperature compensated on-chip power detector which operates between 12 and 16 GHz. The HMC995LP5GE provides 27 dB of gain, 35.5 dBm of saturated output power, and 24% PAE from a +7V supply. The HMC995LP5GE exhibits excellent linearity and is optimized for high capacity digital microwave radio. It is also ideal for 13.75 to 14.5 GHz Ku Band VSAT transmitters as well as SATCOM applications. The HMC995LP5GE amplifier I/Os are internally matched to 50 Ohms and is packaged in a leadless QFN 5x5 mm surface mount package and requires no external matching components.

Electrical Specifications

$T_A = +25^\circ \text{C}$, $V_{dd} = V_{dd1} = V_{dd2} = V_{dd3} = V_{dd4} = V_{dd5} = +7\text{V}$, $I_{dd} = 1200 \text{mA}$ [1]

Parameter	Min.	Typ.	Max.	Units
Frequency Range		12 - 16		GHz
Gain [3]	24	27		dB
Gain Variation Over Temperature		0.03		dB/°C
Input Return Loss		9		dB
Output Return Loss		15		dB
Output Power for 1 dB Compression (P1dB)	32	34.5		dBm
Saturated Output Power (P _{sat})		35.5		dBm
Output Third Order Intercept (IP3) ^[2]		41		dBm
Total Supply Current (I _{dd})		1200		mA

[1] Adjust (V_{gg1}=V_{gg2}=V_{gg3}) between -2 to 0V to achieve I_{dd} = 1200mA typical.

[2] Measurement taken at +7V @ 1200mA, P_{out} / Tone = +22 dBm

[3] Board loss subtracted out



GaAs pHEMT MMIC 3 WATT POWER AMPLIFIER SMT WITH POWER DETECTOR, 12 - 16 GHz

Broadband Gain & Return Loss vs. Frequency

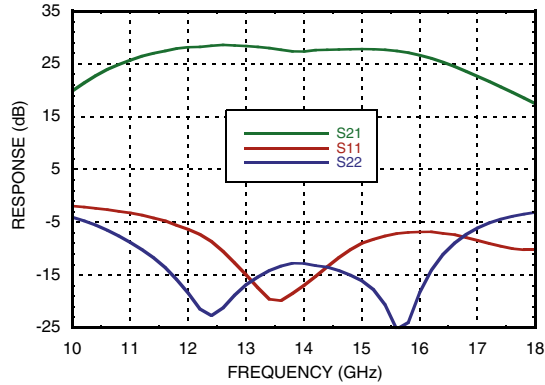

Gain vs. Temperature [1]

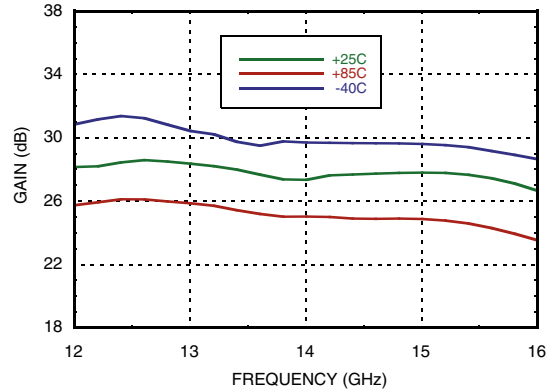

Input Return Loss vs. Temperature

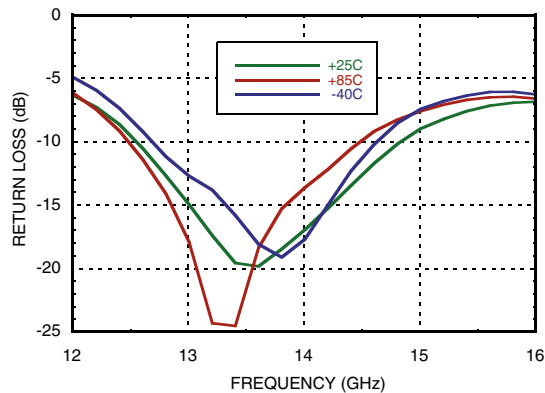

Output Return Loss vs. Temperature

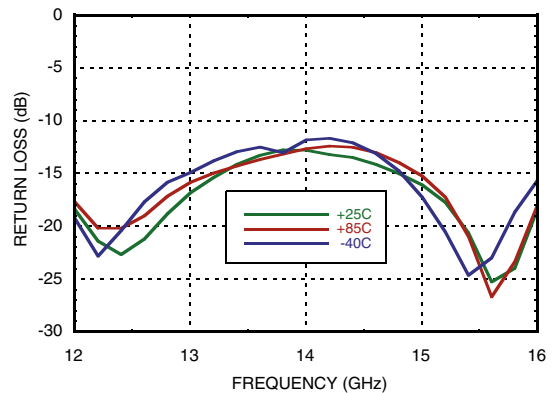

P1dB vs. Temperature

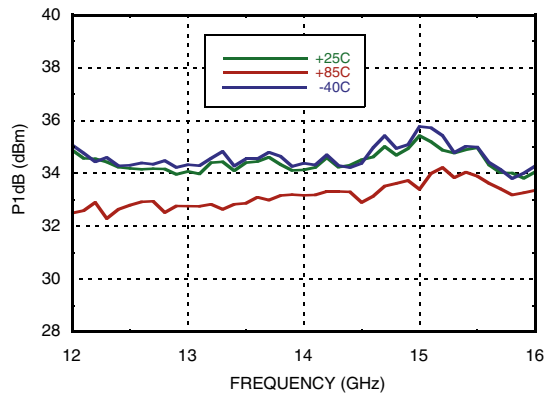

P1dB vs. Supply Voltage

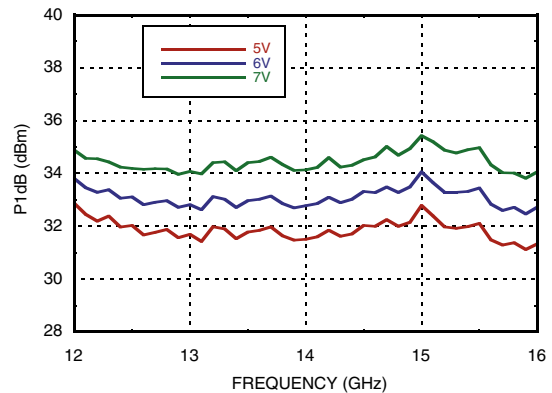

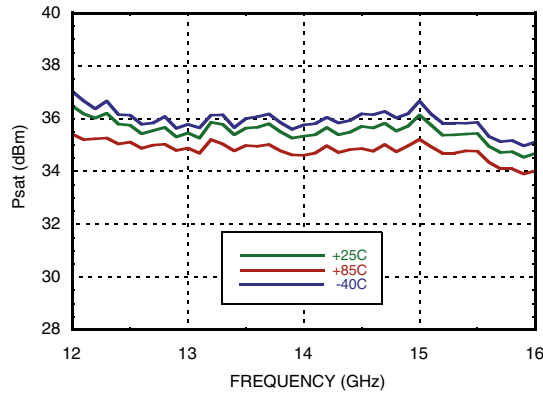
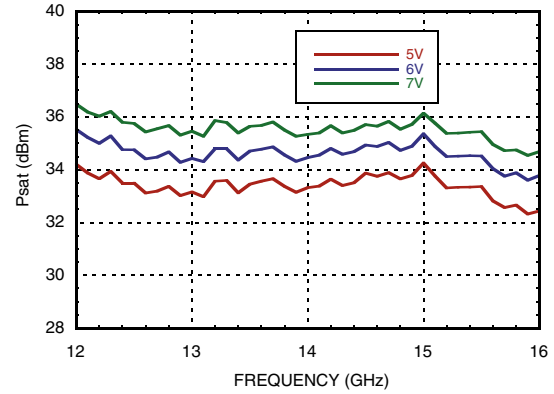
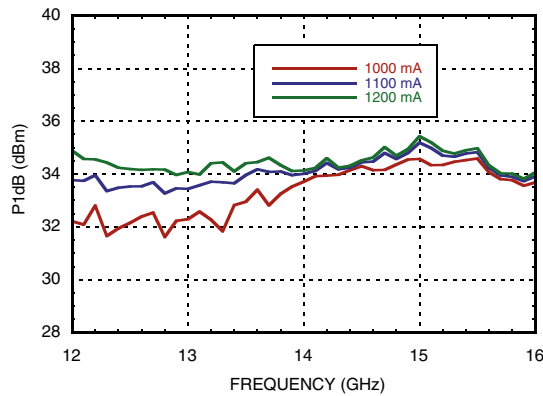
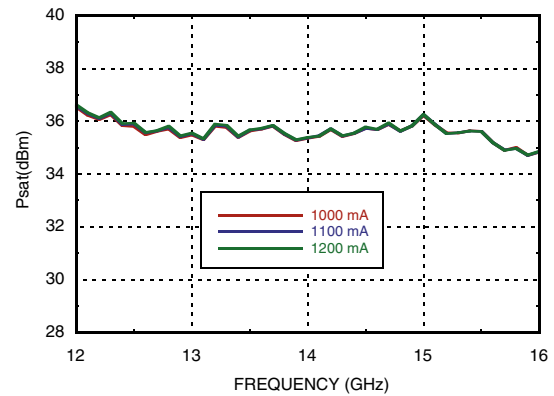
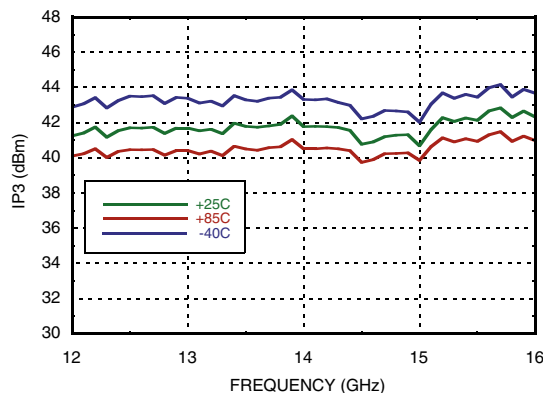
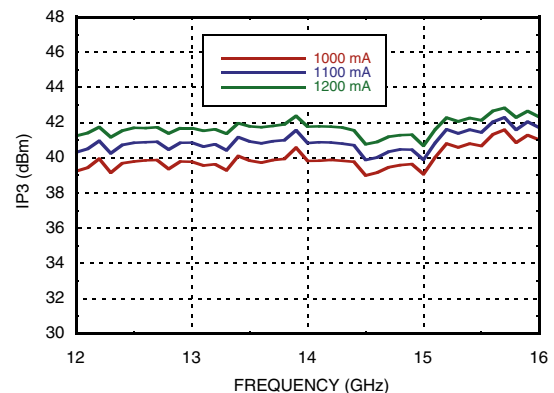

**GaAs pHEMT MMIC 3 WATT POWER AMPLIFIER SMT
WITH POWER DETECTOR, 12 - 16 GHz**
AMPLIFIERS - LINEAR & POWER - SMT
Psat vs. Temperature

Psat vs. Supply Voltage

P1dB vs. Supply Current (Idd)

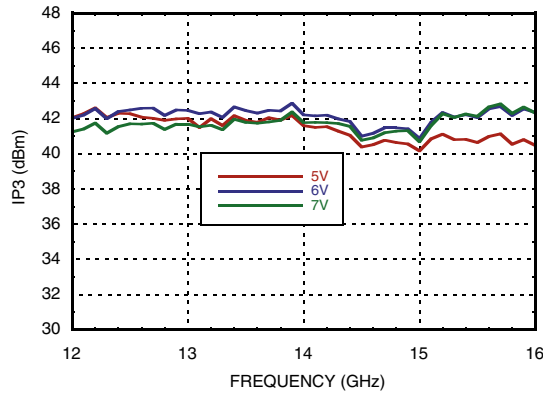
Psat vs. Supply Current (Idd)

Output IP3 vs. Temperature, Pout/Tone = +22 dBm

Output IP3 vs. Supply Current, Pout/Tone = +22 dBm



GaAs pHEMT MMIC 3 WATT POWER AMPLIFIER SMT WITH POWER DETECTOR, 12 - 16 GHz

Output IP3 vs. Supply Voltage, Pout/Tone = +22 dBm



Output IM3 @ Vdd = +5V

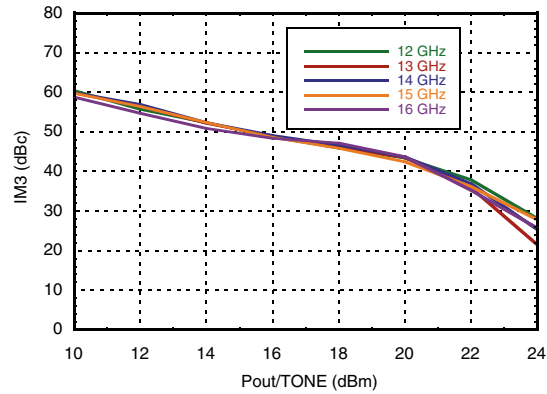

Output IM3 @ Vdd = +6V

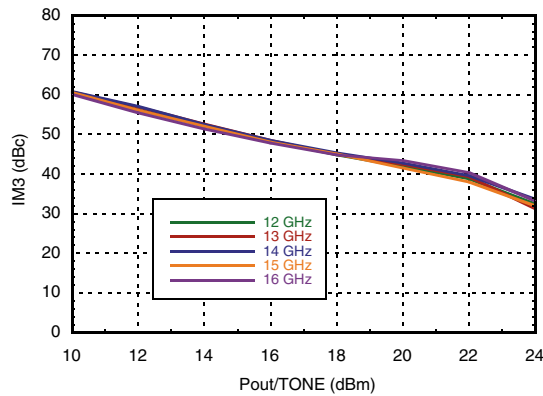

Output IM3 @ Vdd = +7V

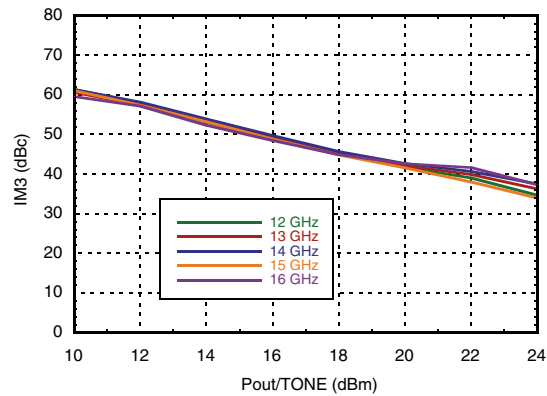

Power Compression @ 13 GHz

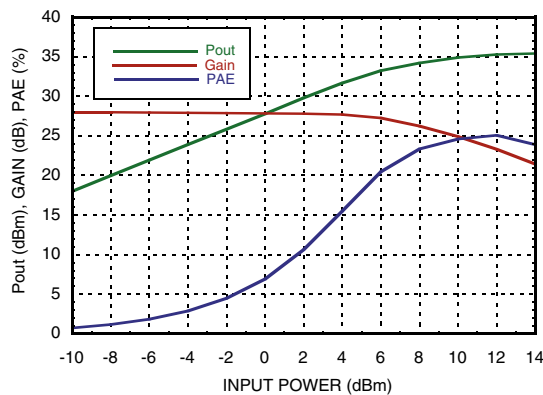

Power Compression @ 15 GHz

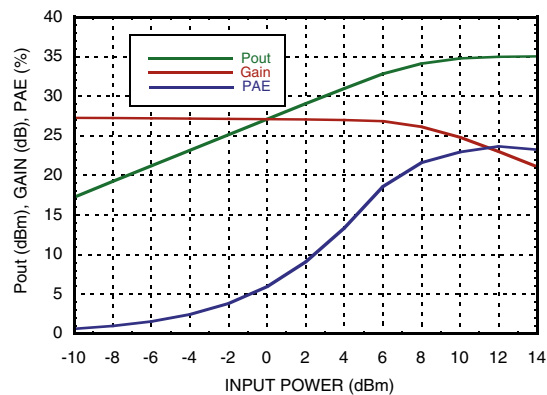



GaAs pHEMT MMIC 3 WATT POWER AMPLIFIER SMT WITH POWER DETECTOR, 12 - 16 GHz

Detector Voltage vs. Frequency & Temperature

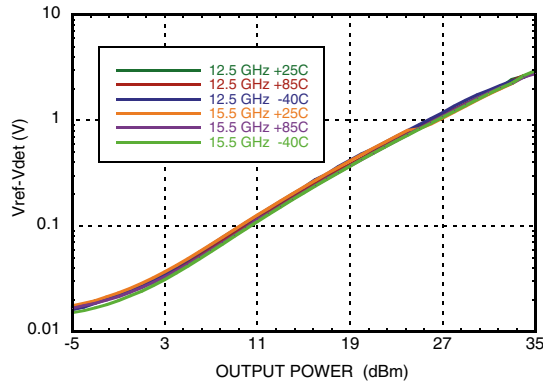

Reverse isolation vs. Temperature

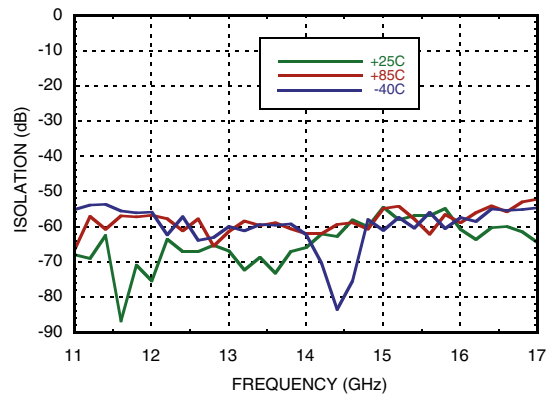

Gain & Power vs. Supply Current @ 14 GHz

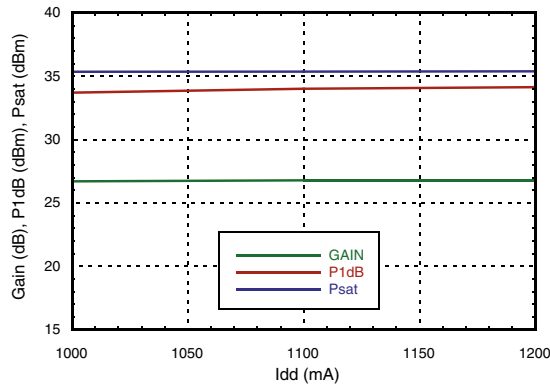

Gain & Power vs. Supply Voltage @ 14 GHz

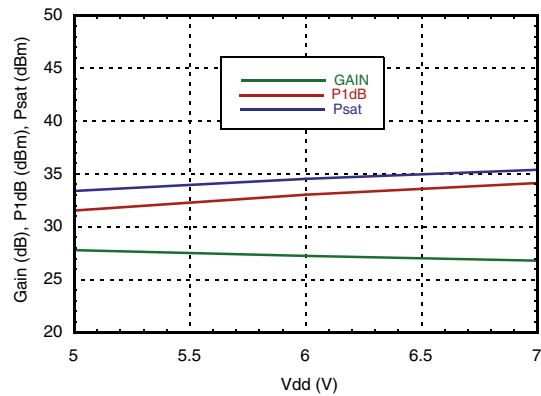

Power Dissipation

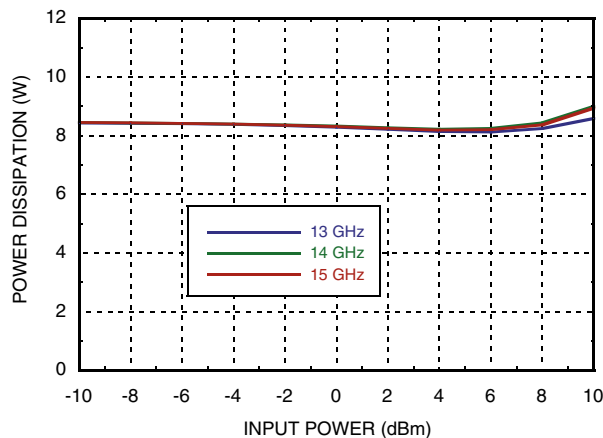

**GaAs pHEMT MMIC 3 WATT POWER AMPLIFIER SMT
WITH POWER DETECTOR, 12 - 16 GHz****Absolute Maximum Ratings**

Drain Bias Voltage (Vdd1-5)	+8V
RF Input Power (RFIN)	+24 dBm
Channel Temperature	150 °C
Continuous Pdiss (T= 85 °C) (derate 137 mW/°C above 85 °C)	8.9 W
Thermal Resistance (channel to gnd paddle)	7.3 °C/W
Storage Temperature	-65 to +150 °C
Operating Temperature	-40 to +85 °C
ESD Sensitivity (HBM)	Class 1A

Typical Supply Current vs. Vdd

Vdd (V)	Idd (mA)
5	1200
6	1200
7	1200

Note: Amplifier will operate over full voltage ranges shown above Vgg adjusted to achieve Idd = 1200 mA



**ELECTROSTATIC SENSITIVE DEVICE
OBSERVE HANDLING PRECAUTIONS**



GaAs pHEMT MMIC 3 WATT POWER AMPLIFIER SMT WITH POWER DETECTOR, 12 - 16 GHz

Outline Drawing

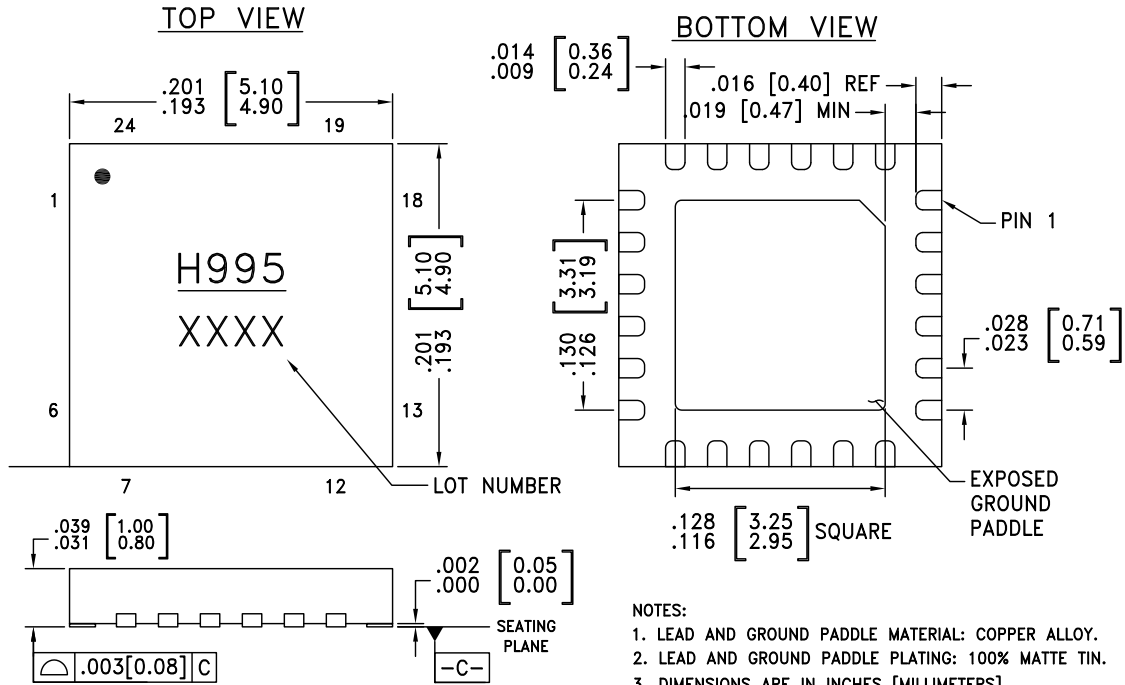

- NOTES:
1. LEAD AND GROUND PADDLE MATERIAL: COPPER ALLOY.
 2. LEAD AND GROUND PADDLE PLATING: 100% MATTE TIN.
 3. DIMENSIONS ARE IN INCHES [MILLIMETERS].
 4. LEAD SPACING TOLERANCE IS NON-CUMULATIVE.
 5. PAD BURR LENGTH SHALL BE 0.15mm MAX. PAD BURR HEIGHT SHALL BE 0.25mm MAX.
 6. PACKAGE WARP SHALL NOT EXCEED 0.05mm
 7. ALL GROUND LEADS AND GROUND PADDLE MUST BE SOLDERED TO PCB RF GROUND.

Package Information

Part Number	Package Body Material	Lead Finish	MSL Rating	Package Marking ^[1]
HMC995LP5GE	RoHS-compliant Low Stress Injection Molded Plastic	100% matte Sn	MSL3 ^[2]	H995 XXXX



[1] 4-Digit lot number XXXX

[2] Max peak reflow temperature of 260 °C

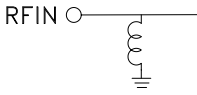

GaAs pHEMT MMIC 3 WATT POWER AMPLIFIER SMT WITH POWER DETECTOR, 12 - 16 GHz

Pin Descriptions

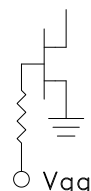
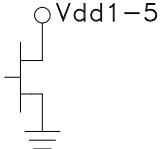
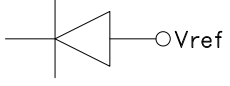
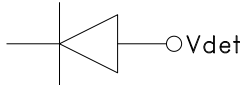
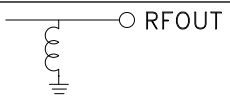
Pin Number	Function	Description	Interface Schematic
1-3, 9, 14 17-19, 23, 24	N/C	These pins are not connected internally, however all data shown herein was measured with these pins connected to RF/DC ground externally.	
4	RFIN	This pad is DC coupled and matched to 50 Ohms.	
5, 15	GND	These pins and package bottom must be connected to RF/DC ground.	
6-8	Vgg1, Vgg2 Vgg3	Gate control for amplifier. External bypass capacitors of 100pF, 10nF and 4.7uF are required. Please follow "MMIC Amplifier Biasing Procedure" App Note.	
10, 11 20-22	Vdd1, Vdd2, Vdd3, Vdd4, Vdd5	Drain bias voltage for the amplifier. External bypass capacitors of 100pF, 10nF and 4.7uF capacitors are required.	
12	Vref	DC voltage of diode biased through external resistor, used for temperature compensation of Vdet. See Application Circuit.	
13	Vdet	DC voltage representing RF output power rectified by diode which is biased through an external resistor. See Application Circuit.	
16	RFOUT	This pin is DC coupled and matched to 50 Ohms.	



GaAs pHEMT MMIC 3 WATT POWER AMPLIFIER SMT WITH POWER DETECTOR, 12 - 16 GHz

Application Circuit

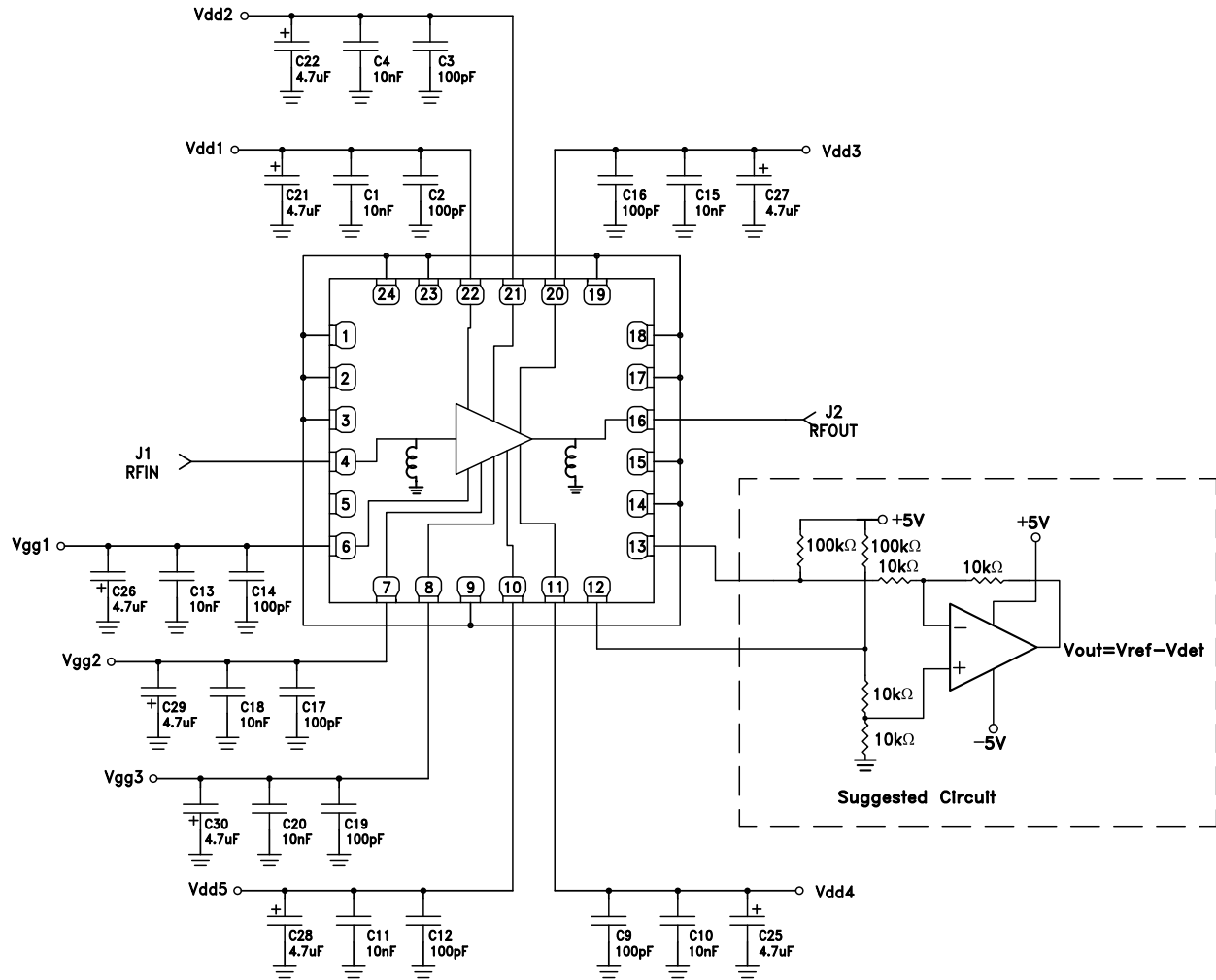

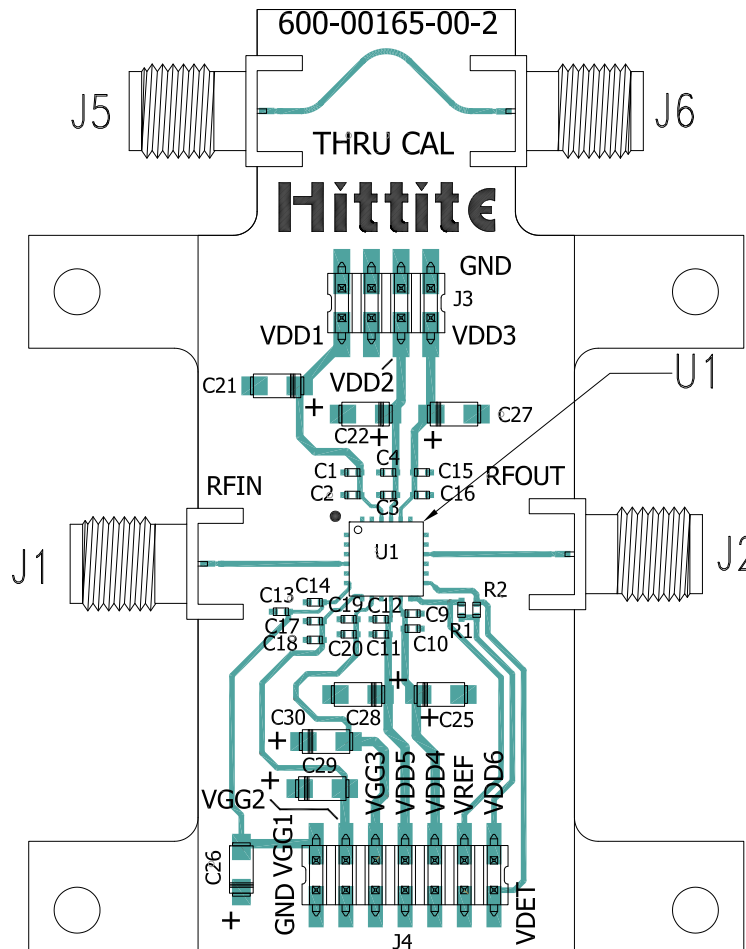
**GaAs pHEMT MMIC 3 WATT POWER AMPLIFIER SMT
WITH POWER DETECTOR, 12 - 16 GHz**
Evaluation PCB

List of Materials for Evaluation PCB EVAL01-HMC995LP5GE [1]

Item	Description
J1, J2, J5, J6	K Connector SRI
J3, J4	DC Pin
C2, C3, C9, C12, C14, C16, C17, C19	100 pF Capacitor, 0402 Pkg.
C1, C4, C10, C11, C13, C15, C18, C20	10 nF Capacitor, 0402 Pkg.
C21, C22, C25 - C30	4.7uF Capacitor, Case A.
U1	HMC995LP5GE Power Amplifier
PCB	600-00163-00 Evaluation PCB

[1] Reference this number when ordering complete evaluation PCB

[2] Circuit Board Material: Rogers 4350 or Arlon FR4

The circuit board used in the application should use RF circuit design techniques. Signal lines should have 50 Ohm impedance while the package ground leads and exposed paddle should be connected directly to the ground plane similar to that shown. A sufficient number of via holes should be used to connect the top and bottom ground planes. The evaluation board should be mounted to an appropriate heat sink. The evaluation circuit board shown is available from Hittite upon request.

Данный компонент на территории Российской Федерации

Вы можете приобрести в компании MosChip.

Для оперативного оформления запроса Вам необходимо перейти по данной ссылке:

<http://moschip.ru/get-element>

Вы можете разместить у нас заказ для любого Вашего проекта, будь то серийное производство или разработка единичного прибора.

В нашем ассортименте представлены ведущие мировые производители активных и пассивных электронных компонентов.

Нашей специализацией является поставка электронной компонентной базы двойного назначения, продукции таких производителей как XILINX, Intel (ex.ALTERA), Vicor, Microchip, Texas Instruments, Analog Devices, Mini-Circuits, Amphenol, Glenair.

Сотрудничество с глобальными дистрибьюторами электронных компонентов, предоставляет возможность заказывать и получать с международных складов практически любой перечень компонентов в оптимальные для Вас сроки.

На всех этапах разработки и производства наши партнеры могут получить квалифицированную поддержку опытных инженеров.

Система менеджмента качества компании отвечает требованиям в соответствии с ГОСТ Р ИСО 9001, ГОСТ РВ 0015-002 и ЭС РД 009

Офис по работе с юридическими лицами:

105318, г.Москва, ул.Щербаковская д.3, офис 1107, 1118, ДЦ «Щербаковский»

Телефон: +7 495 668-12-70 (многоканальный)

Факс: +7 495 668-12-70 (доб.304)

E-mail: info@moschip.ru

Skype отдела продаж:

moschip.ru

moschip.ru_4

moschip.ru_6

moschip.ru_9