

481 Series Alarm Indicating Fuse





Description

481 Series alarm indicating fuses are designed to reduce down time by immediately pinpointing the blown (open) circuit while triggering an LED or audio alarm. This item requires 482 Series mating fuse holder.

All ranges of 481 Series fuses are available as our original design, and the 2-20 amp range is now available as a RoHS compliant option (use the "P" designator when ordering). See the part numbering section of this data sheet for related ordering instructions.

Agency Approvals

Agency	Agency File Number
	E71611
	LR 29862

Electrical Characteristics

% of Ampere Rating	Opening Time
100%	10 Minutes, Minimum
150%	5 Minutes, Maximum



Features

- Color-coded indicator flags indicate ampere rating.
- Clear plastic lens option available for additional safety.
- Body is constructed of black polyphenylene sulfide with UL94V0 flammability rating.
- Contacts made of bright alloy-plated beryllium copper.

Applications

Ideal for telecommunications and control panel circuits

Electrical Characteristics

Ampere Rating (A)	Amp Code	Max Voltage Rating (V)	Interrupting Rating	Body Color Code	Nominal Cold Resistance (Ohms)	Nominal Melting I ² t (A ² Sec.)	Agency Approvals	
								
0.180*	.180	125 VAC & 125 VDC	450A @ 60 VDC 300A @ 125 VAC (up to 20A) 300A @ 125 VDC (up to 15A) 200A @ 125 VDC (up to 20A)	Yellow	6.25	0.00808	x	x
0.200*	.200			Red/Black	5.70	0.0140	x	x
0.250*	.250			Violet	4.20	0.0356	x	x
0.375*	.375			Gray/White	2.00	0.028	x	x
0.500*	.500			Red	1.52	0.139	x	x
0.650*	.650			Black	1.25	0.278	x	x
0.750*	.750			Brown	.980	0.363	x	x
1.00*	.001			Gray	.665	0.733	x	x
1.33*	1.33			White	.480	1.58	x	x
1.50*	01.5			Yellow/White	.385	2.55	x	x
2.00	002.			Orange	.120	5.29	x	x
2.50	02.5			Orange/White	.0904	9.46	x	x
3.00	003.			Blue	.0670	11.2	x	x
3.50	03.5			Blue/White	.0415	10.5	x	x
4.00	004.			Brown/White	.0350	15.4	x	x
5.00	005.			Green	.0285	26.2	x	x
7.50	07.5			Black/White	.0113	42.8	x	x
10.0	010.			Red/White	.00840	115.3	x	x
12.0	012.			Green/Yellow	.00660	222.5	x	x
15.0	015.			Red/Blue	.00580	294.22	x	x
20.0**	020.	Green/White	.00394	570.0	x	x		

* 0.180A thru 1.5A items are not available for sale as a RoHS compliant "P" option
 **20A Fuseholder must be used. Fuse is keyed to prevent insertion in lower rated holders.
 20A Fuseholder is designed to accept all ratings up to 20 amperes.

Additional Information



Datasheet



Resources



Samples

Product Characteristics

Material	Body: Polyphenylene Sulfide (UL 94VO)
	Terminations: Beryllium Copper/Tin Plated
	Optional Lens: Nylon
Vibration	Per MIL-STD-202F

Operating Temperature	- 55°C to 125°C.
Thermal Shock	Withstands 5 cycles of - 55°C to 125°C
Insulation Resistance (After Opening)	Greater than 10,000 ohms.

Dimensions

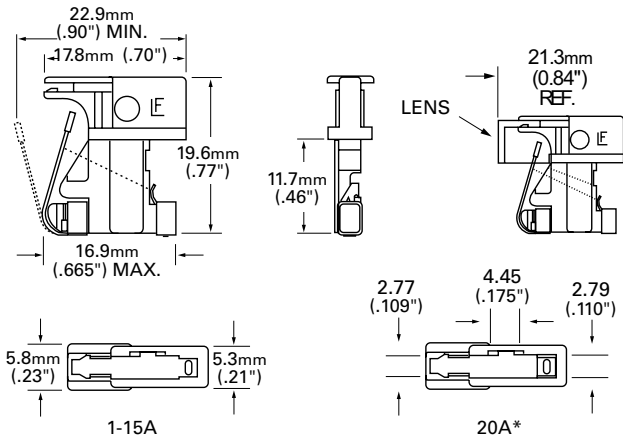

*20A Fuseholder must be used. Fuse is keyed to prevent insertion in lower rated holders. 20A Fuseholder is designed to accept all ratings up to 20 amperes.

Average Time Current Curves

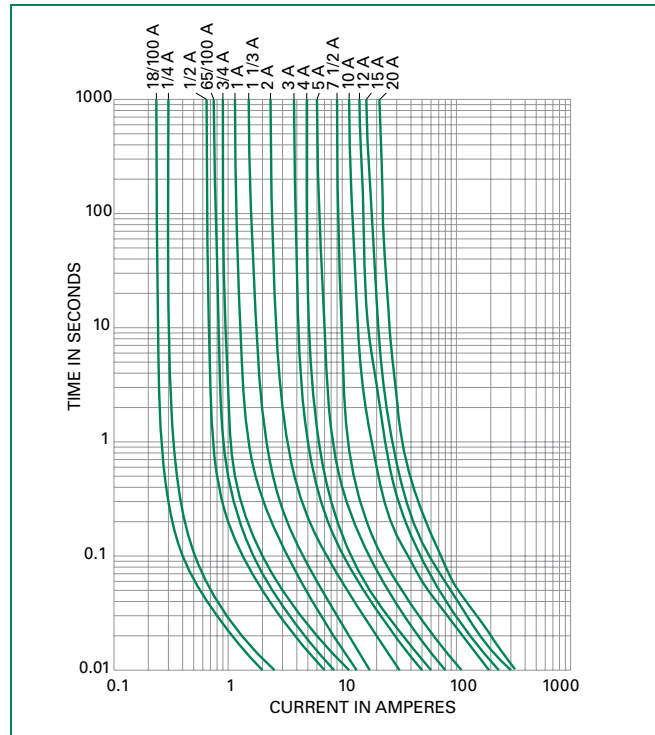

Part Numbering System

0481 .180 H XL P

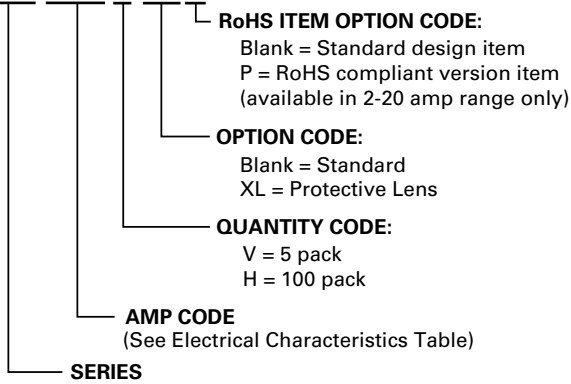

Данный компонент на территории Российской Федерации

Вы можете приобрести в компании MosChip.

Для оперативного оформления запроса Вам необходимо перейти по данной ссылке:

<http://moschip.ru/get-element>

Вы можете разместить у нас заказ для любого Вашего проекта, будь то серийное производство или разработка единичного прибора.

В нашем ассортименте представлены ведущие мировые производители активных и пассивных электронных компонентов.

Распределительные склады, находящиеся в России, Европе и в Китае, позволяют нам оперативно поставить необходимые компоненты в оптимальные для Вас сроки.

На всех этапах разработки и производства наши партнеры могут получить квалифицированную поддержку опытных инженеров.

Система менеджмента качества компании отвечает требованиям ISO 9001:2011

Офис по работе с юридическими лицами:

107023, г.Москва, Семеновский переулок, д.6, Бизнес-центр «АВС»

Телефон: +7 495 668-12-70 (многоканальный)

Факс: +7 495 668-12-70 (доб.304)

E-mail: info@moschip.ru

Skype отдела продаж:

moschip.ru_3	moschip.ru_6
moschip.ru_4	moschip.ru_7
moschip.ru_11	moschip.ru_8
moschip.ru_12	moschip.ru_9