

UR SERIES VOLTAGE CONTROL RELAY

UL listed CSA recognized

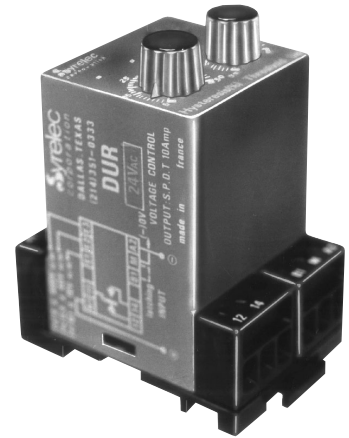

- AC or DC Voltage Control
- Manual or Automatic Operation
- Adjustable Threshold
- 5 to 50% Hysteresis Range
- LED Relay Status Indicator

1. AC/DC voltage control without latching:

The output relay is energized when the voltage (AC peak voltage) exceeds the selected threshold. It de-energizes when the voltage falls below the hysteresis setting (5 to 50%) or when supply breaks. The hysteresis is controlled by a potentiometer and its selection does not change the chosen threshold.

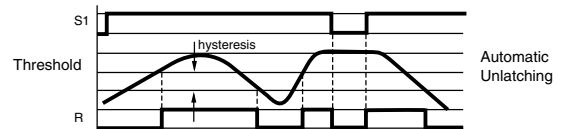

2. AC/DC voltage control with latching:

The output relay is energized when the voltage reaches the selected threshold and stays latched in this position. The contact between terminal B1 and M (or 8 or 9) should be opened or the input power of the device interrupted to reset.

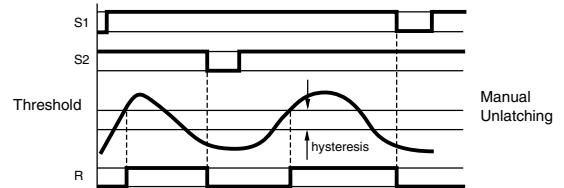

SPECIFICATIONS:

Input	24 VDC, 24, 48, 110, 220 VAC		
	±15%, 50/60 Hz		
Power consumption	24 VAC: 1 VA		
	48 VAC: 1.2 VA		
	110 VAC: 3.5 VA		
	220 VAC: 7 VA		
Control Range	Input Resistance	Acceptance load (input)	
AC or DC		Permanent (max)	Less than 10ms peak max.
0.1 to 10 V	10 kΩ	50 V	100 V
0.4 to 40 V	40 kΩ	100 V	300 V
4 to 400 V	400 kΩ	440 V	750 V
Hysteresis selection	5 to 50% of set point		
Repeat accuracy	±2% at a constant ambient		
Output Relay	SPDT Relay		
Contact material	AgCdO		
Maximum loading	10 A AC resistive 8 A DC inductive		
Maximum switching voltage	250 VAC		250 VDC
Relay maximum power rating	2200 VA		
Transient protection	2500 volts		30 W
Mechanical life of relay	30 x 10 ⁶ operations		
Electrical life of relay	2 x 10 ⁵ at 2400 VA resistive load		
Repetition accuracy	±0.5% at a constant ambient		
Response time	100 ms on make		
	200 ms on break		
Operating temperature	-4°F to +140°F		-20°C to +60°C
Weight	7 oz. (200g)		

Option: 24 VDC power – the voltage and the measured current must be from separate sources.

ORDERING INFORMATION:



Products and specifications subject to change without notice.

Order/Technical Support – Tel: (800) 677-5311 / FAX: (800) 677-3865 / www.crouzet-usa.com

SR SERIES UNDER VOLTAGE RELAY

UL listed CSA recognized

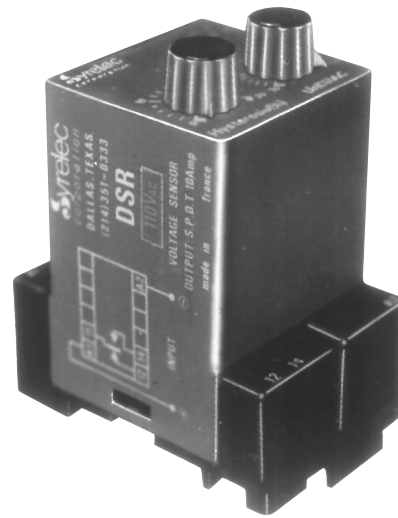

- Multiple AC/DC Voltages
- 5 to 20% Hysteresis Adjustment
- Automatic Operation
- Adjustable Threshold

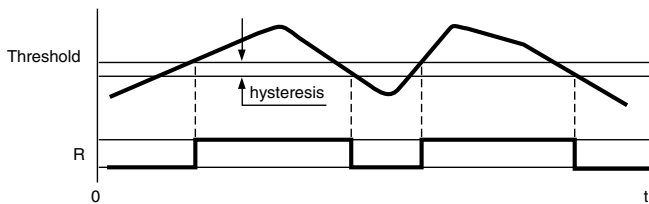

The voltage threshold SR Relay controls a voltage supply which is its own supply. The output relay is energized when the supply (effective for AC) exceeds the selected threshold. It de-energizes when the controlled supply falls below (5 to 20% Hysteresis) of the supply voltage or when the input power breaks. Hysteresis is controlled by a potentiometer and its selection does not change the chosen threshold. Pulses or drops of 100ms or less are ignored.

SPECIFICATIONS:

Input12 VDC, 24 VAC, 24 VDC, 48 VAC
	48 VDC, 110 VAC, 220 VAC, 50/60 Hz
	-20% to +30% DC,
	-30% to +15% AC
Maximum power consumption ..	.24 VAC: 1.5 VA 24 VDC: .6 W
	48 VAC: 2 VA 24 VDC: .8 W
	110 VAC: 5 VA 48 VDC: 1.8 W
	220 VAC: 11 VA
Residual ripple	<Hysteresis value
Output relaySPDT Relay
Contact material	AgCdO
Maximum loading10 A AC resistive 8 A DC inductive
Maximum switching voltage250 VAC 250 VDC
Maximum power rating2200 VA 80 W
Mechanical life of relay30 x 10 ⁶ operations
Electrical life of relay2 x 10 ⁶ at 2200 VA resistive load
Operating temperature	+14°F to 140°F -10°C to +60°C
Weight2.8 oz. (100g)

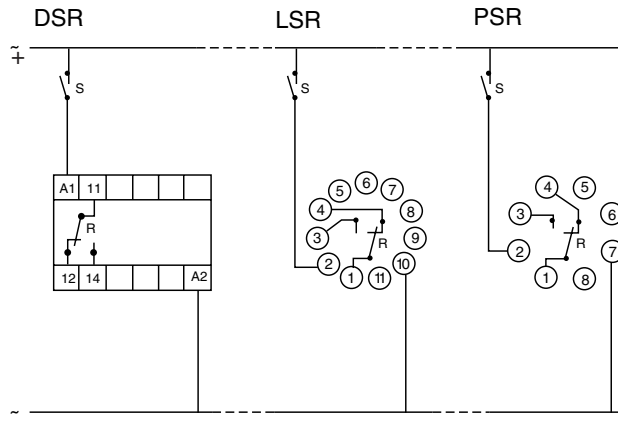

ORDERING INFORMATION:

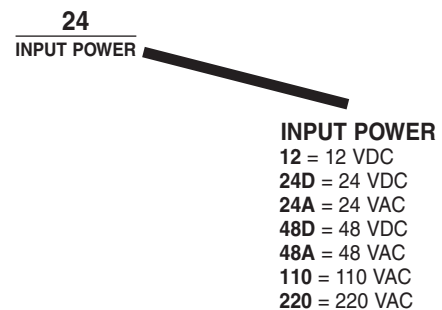
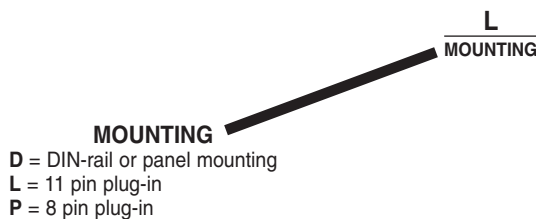

Products and specifications subject to change without notice.

Order/Technical Support – Tel: (800) 677-5311 / FAX: (800) 677-3865 / www.crouzet-usa.com

Данный компонент на территории Российской Федерации

Вы можете приобрести в компании MosChip.

Для оперативного оформления запроса Вам необходимо перейти по данной ссылке:

<http://moschip.ru/get-element>

Вы можете разместить у нас заказ для любого Вашего проекта, будь то серийное производство или разработка единичного прибора.

В нашем ассортименте представлены ведущие мировые производители активных и пассивных электронных компонентов.

Нашей специализацией является поставка электронной компонентной базы двойного назначения, продукции таких производителей как XILINX, Intel (ex.ALTERA), Vicor, Microchip, Texas Instruments, Analog Devices, Mini-Circuits, Amphenol, Glenair.

Сотрудничество с глобальными дистрибьюторами электронных компонентов, предоставляет возможность заказывать и получать с международных складов практически любой перечень компонентов в оптимальные для Вас сроки.

На всех этапах разработки и производства наши партнеры могут получить квалифицированную поддержку опытных инженеров.

Система менеджмента качества компании отвечает требованиям в соответствии с ГОСТ Р ИСО 9001, ГОСТ РВ 0015-002 и ЭС РД 009

Офис по работе с юридическими лицами:

105318, г.Москва, ул.Щербаковская д.3, офис 1107, 1118, ДЦ «Щербаковский»

Телефон: +7 495 668-12-70 (многоканальный)

Факс: +7 495 668-12-70 (доб.304)

E-mail: info@moschip.ru

Skype отдела продаж:

moschip.ru

moschip.ru_4

moschip.ru_6

moschip.ru_9