

Atmel®

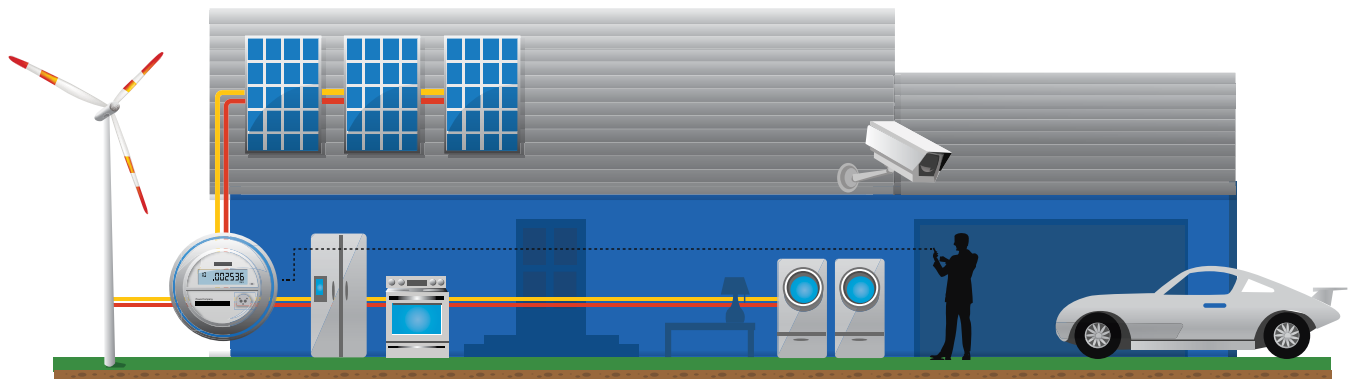

Atmel Smart Energy Solution Guide



Smart Energy Applications

It's all about energy management

- Smart Grid
- Industrial Lighting and Automation
- Home Automation
- Street Lighting
- Solar Energy
- PHEV Charging Stations

The market for energy, water, and gas metering systems is rapidly changing, driven by new environmental and conservation concerns and regulations. Traditional standalone meters are now being replaced by complex networked systems that utilize a variety of communication methods. To meet the needs of this evolving smart grid, metering developers need solutions that can provide:

- Leading-edge Connectivity
- Best-in-class Metrology
- Integration & Flexibility
- Advanced Security



Atmel Smart Energy Solutions

Not just a Chip, but a Platform

Atmel® addresses the needs of the smart energy market with application-specific, as well as standard microcontroller, microprocessor, security, memory, wireless and power-line connectivity devices. The application-specific portfolio is defined from the ground up to offer designers best-in-class feature sets and performance in various classes of equipment used in the smart grid. Many of the devices in the Smart Energy Platform are part of the Atmel | SMART line of ARM®-based microcontrollers.

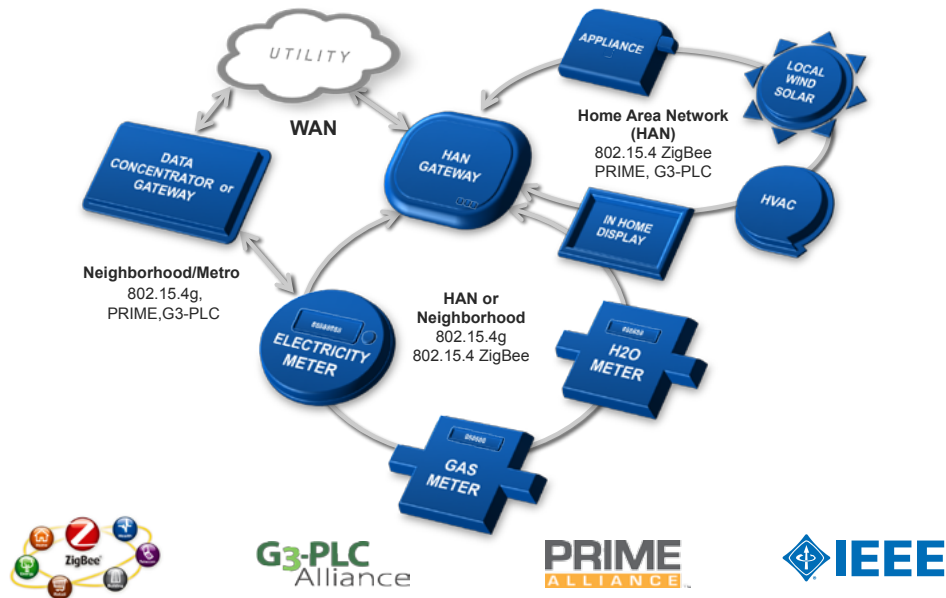

Figure 1. Smart Grid Equipment and Governing Communications Standards

	Home Area Network Equipment	Energy Gateway	Data Concentrator	Electricity Meter	Gas & Water Meter
M90E32/36	✓	--	✓	✓	--
M90E26	--	--	--	✓	--
ATSENSE	--	--	✓	✓	--
PL230	✓	--	--	✓	--
PL250	✓	--	--	✓	--
RF212B	✓	✓	--	✓	✓
RF233	✓	✓	--	✓	✓
RF215	✓	✓	✓	✓	✓
RF215M	✓	✓	✓	✓	✓
SAM4C	✓	✓	✓	✓	✓
SAM4CM	✓	--	✓	✓	--
SAM4CP	✓	✓	✓	✓	--
SAMD	--	--	--	--	✓
SAM4L	✓	--	--	✓	✓
SAMA5	--	✓	✓	--	--

Table 1. Atmel Platform Products by Equipment Type

Atmel Smart Metering Platform

Today's smart meter architect demands various levels of integration depending on system architecture partitioning, project timelines, and the level of flexibility needed to address various utility and geographical requirements. The Atmel platform provides a unique multi-level architecture built around the same multi-core architecture as outlined below. Various devices integrate the building blocks of the smart meter, namely, metrology sensing (ADC), metrology DSP, application, communication, and security processing, as well as connectivity to home area and neighborhood area networks.

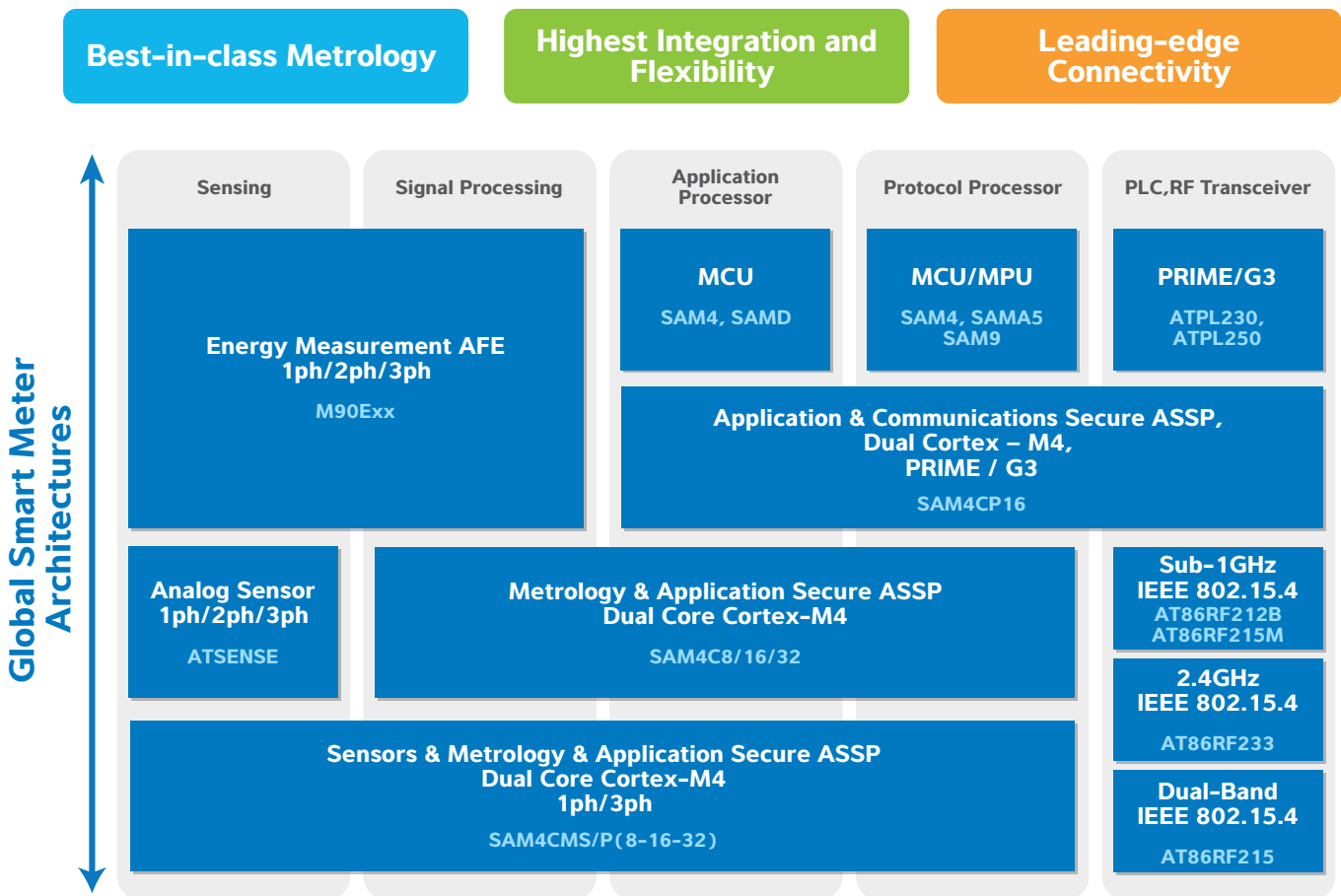

Figure 2. Atmel Smart Metering Platform

Atmel Smart Energy Solutions Guide

Atmel Value Proposition

The broadest portfolio targeting at metering market.

- Leading-edge Connectivity
 - Low power 802.15.4 wireless devices
 - Field proven, Low power PLC (PRIME / G3)
- Integration and Flexibility
 - Flexible (SW or HW) metrology
 - Multi-standard Wireless and PLC solutions
 - Advanced cryptography
- Best-in-class Metrology
 - Standalone Sensing AFE and SOC with integrated AFE offering
 - Dynamic range of up to 6000:1
 - 25M units shipped since 90's
- Broad Atmel | SMART ARM-based Portfolio
 - Large array of SAMD, SAM4 and SAMA5 solutions
 - Best-in-class tools from Atmel, IAR, Keil

Newest Smart Energy Platform Core: SAM4C

At the core of Atmel's smart energy platform is the Atmel | SMART SAM4C series of products. The SAM4C8/16/32 system-on-chip solutions for smart energy applications are built around two high-performance 32-bit ARM Cortex®-M4 RISC processors. These devices operate at a maximum speed of 120 MHz and feature up to 2Mbyte of embedded Flash, 304 Kbytes of SRAM, and on-chip cache for each core.

The dual ARM Cortex-M4 architecture allows for integration of application layer, communications layers, and metrology functions in a single device. It has options for integrated software metrology or external hardware metrology AFE (analog front end) as well as integrated or external power-line carrier (PLC) physical layer solution. It's a modular approach that is sure to meet various design needs.

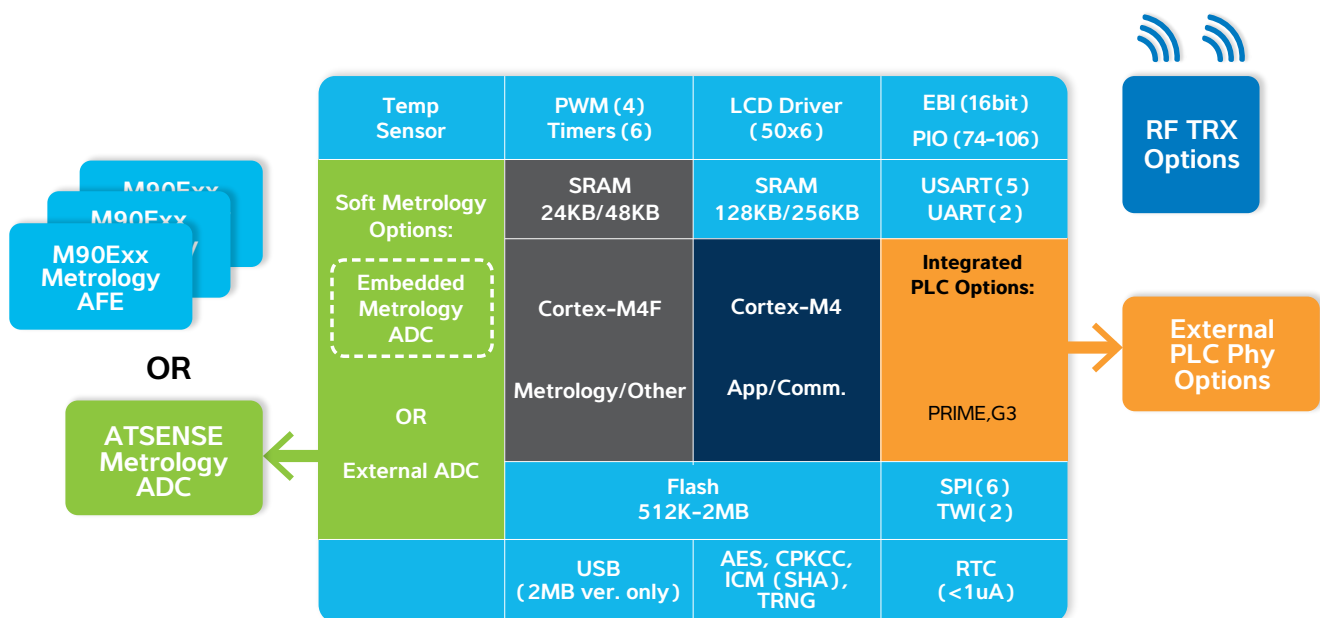
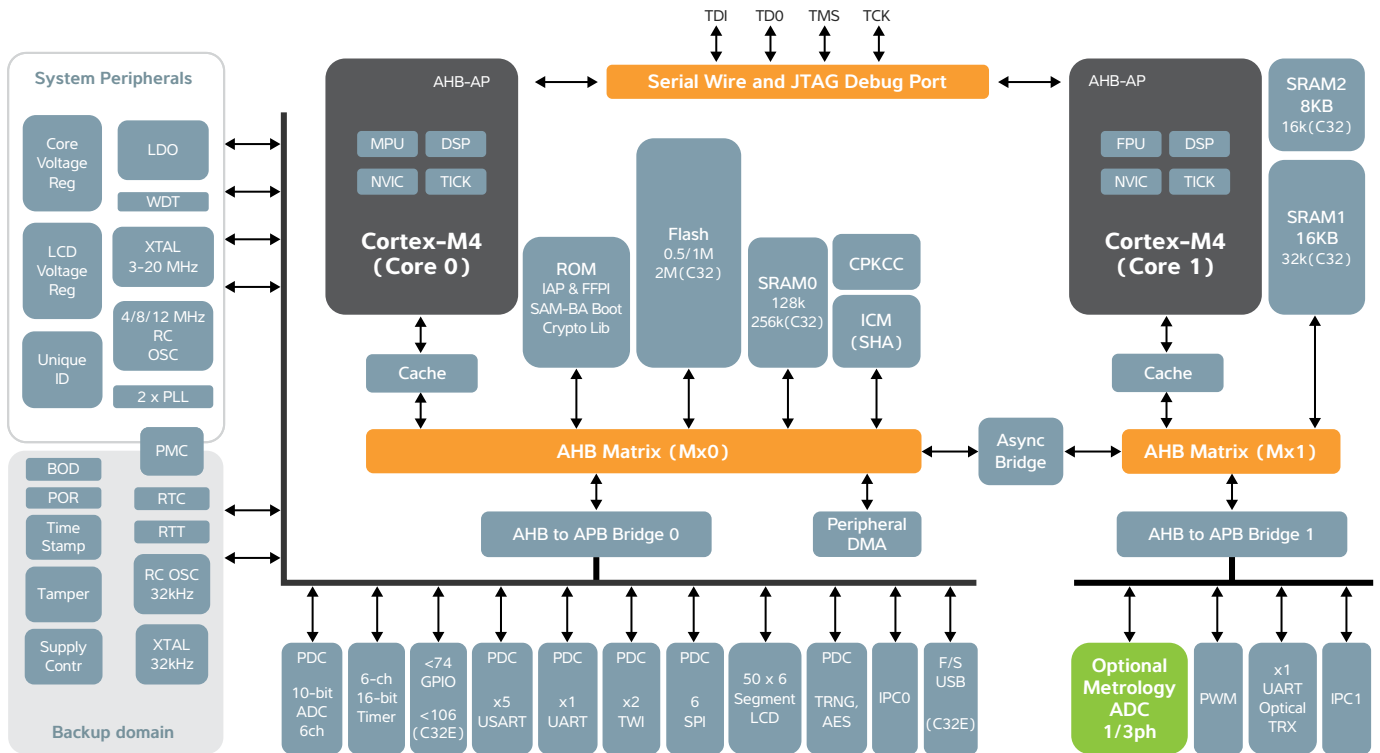

Figure 3. SAM4C Platform



C32 devices have 2M flash, full speed USB, more GPIO, more RAM

Figure 4. SAM4C Block Diagram

	SAM4C8	SAM4C16	SAM4C32C	SAM4C32E	SAM4CMP8/ SAM4CMS8	SAM4CMP16/ SAM4CMS16	SAM4CMP32/ SAM4CMS32
Flash	512KB	1MB	2MB		512KB	1MB	2MB
SRAM	128 + 16 + 8KB		256 + 32 + 16KB		128 + 16 + 8KB		256 + 32 + 16KB
Package	100 LQFP			144 LQFP	100 LQFP		
GPIO	74			106	52 / 57		
PWM	4				3		
UART+USART	7				5/6		
SPI	2 Controllers - 8 CS, + 5 USARTs in SPI Mode				1 Controller - 4 CS + 3/4 USARTs in SPI Mode		
ADC	10bit, 6 x Externals + 2 x Internals				10bit, 4 x Externals + 2 x Internals		
Metrology AFE	-				7 x Channels / 4 x Channels		
Segment LCD	50 x 6				33 x 6 / 38 x 6		
USB FS	-			Host/ Device	-		
Timer	6 Channels						
TWI	2						

Table 2. SAM4C Metering SOC Feature Comparison

SAM4Cx Software Metrology

Flexibility to support various country-specific requirements

Atmel's software metrology library provides unprecedented level of performance, scalability, and flexibility which supports the integration of proprietary advanced metrology and signal processing algorithms. Atmel's standard library enables residential, commercial, and industrial meter design up to class 0.2 accuracy, dynamic range of 3000:1, supports shunt, current transformer and Rogowski coil current sensing and is compliant with IEC 62052-11, 62053-22/23, ANSI C12.1, C12.20 and MID.

The ATSENSE-301, ATSENSE-201 and ATSENSE-101 are analog front end (AFE) devices targeting metrology applications. They feature up to 7 channels of high-precision sigma-delta analog to digital converters (ADCs) with a 16ksps sample rate and a highly accurate, integrated voltage reference with 10 ppm/°C temperature stability. They also include programmable current signal amplification, a temperature sensor and a SPI (serial peripheral interface).

ATSENSE Features

- 0.1% accuracy over 3000:1 range
- Shunt, CT and Rogowski coil support
- 50ppm/°C reference, 10ppm/°C (H version)
- Works with Atmel Metrology library
- Ultra-low-power: < 2.5mW/channel @ 3.3V
- 8 MHz Serial Peripheral Interface (SPI) compatible mode 1 (8-bit) for ADC data and AFE controls.
- ATSENSE-301(H)
 - 32-pin TQFP package
 - 7 synchronous $\Sigma\Delta$ ADCs, < 16Ks/s
 - 3-V, 4-I channels with 8x PGA
- ATSENSE-201(H)
 - 32-pin TQFP package
 - 4 synchronous $\Sigma\Delta$ ADCs, < 16Ks/s
 - 2-V, 2-I channels with 8x PGA
- ATSENSE-101
 - 20-pin SOIC package
 - 3 synchronous $\Sigma\Delta$ ADCs, < 16Ks/s
 - 1-V, 2-I channels with 8x PGA

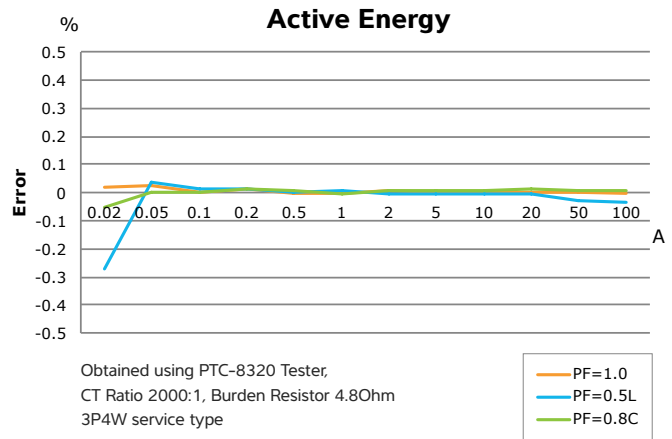

Figure 5. SAM4CM Linear Curve

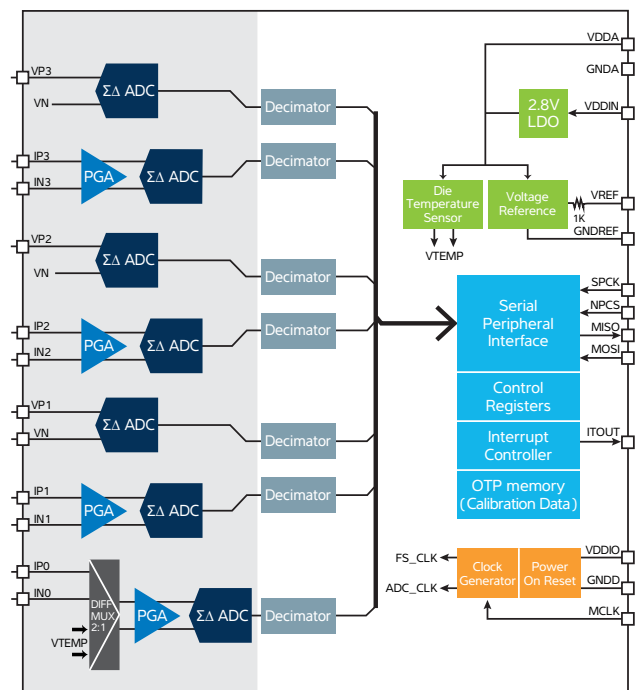
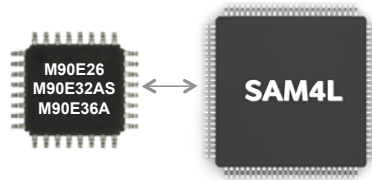

Figure 6. ATSENSE Block Diagram

Hardware Metrology AFE

Out of the box solution for basic metering



- Ideal for basic meter designs
 - Up to class 0.2 accuracy
 - Exceeds IEC, ANSI standards
 - Best-in-class temperature drift
- Best-in-class dynamic range (up to 6000:1)
 - Improves performance
 - Reduces OEM's cost of manufacturing
- Great fit with SAM4L
 - picoPower® Technology
 - Active mode @ 90µA/MHz
 - Full RAM retention @ 1.5µA
 - SleepWalking™
 - 4x40 Segment LCD Controller
 - Hardware Crypto block

Active Energy Error

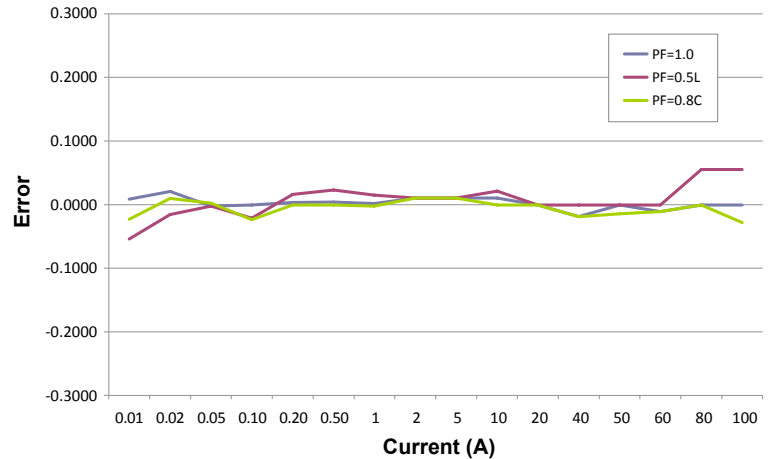

Figure 7. M90E36A Linearity

	Service Type	Dynamic Range	Active Energy Accuracy	Reactive Energy Accuracy	Key Features
SAM4CMS8/16	1 phase	3000:1	0.1%	0.2%	High End Metrology SOC
SAM4CMP8/16	3 phase	3000:1	0.1%	0.2%	
SAM4C8/16	-	-	-	-	Security SOC
SAM4CMS32	1 phase	3000:1	0.1%	0.2%	High End Metrology SOC
SAM4CMP32	3 phase	3000:1	0.1%	0.2%	
SAM4C32	-	-	-	-	Security SOC
ATSENSE101	1 phase	3000:1	1%	1%	Software Metrology ADC
ATSENSE201	2 phase	3000:1	0.2%	0.2%	Software Metrology ADC
ATSENSE301	3 phase	3000:1	0.2%	0.2%	Software Metrology ADC
M90E26	1 phase	5000:1	0.1%	0.2%	AFE, active, reactive energy, instantaneous and anti-tamper
M90E32AS	3 phase	6000:1	0.1%	0.2%	AFE, active, reactive energy, instantaneous, fundamental & harmonics measurement, piece-wise compensation, event detection
M90E36A	3 phase	6000:1	0.1%	0.2%	AFE, active, reactive energy, instantaneous, fundamental & harmonics measurement, Discrete Fourier Transform (DFT) Function, raw data capture

Table 3. Atmel Metrology Solutions

Atmel Smart Energy Solutions Guide

PLC Connectivity Products

Atmel offers PLC solutions designed specifically for narrowband communications using the low-voltage electric grid. Drawing on our deep expertise in PLC modem technology and extensive collaboration with utilities and metering OEMs, we've created solutions offering an unprecedented level of integration and performance. Our solutions support various standards such as PRIME (PoweRline Intelligent Metering Evolution) and G3-PLC. Thanks to the communications software provided by our solution, the management of PLC networks turns into a transparent process. Users can focus on top-level applications and access the Atmel PLC software stack via user-friendly application programming interfaces (APIs).

- Best-in-class sensitivity and high-temperature stability
- Improved analog front end (AFE) providing outstanding efficiency
- Price-competitive, high-performance solutions
- Free software stacks for PLC

Flexible Architecture

Atmel PLC solutions are offered in single chip (SOC) and two-chip (PHY modem + MCU) configuration, respectively. Both configurations are available for PRIME and G3 solutions. Atmel PRIME devices comply with state-of-the-art specification and include enhanced PRIME features such as additional robust modes and frequency band extension up to 500 kHz. Atmel G3 devices support all modulation schemes and modes (coherent, differential) defined in the G3-PLC specification.

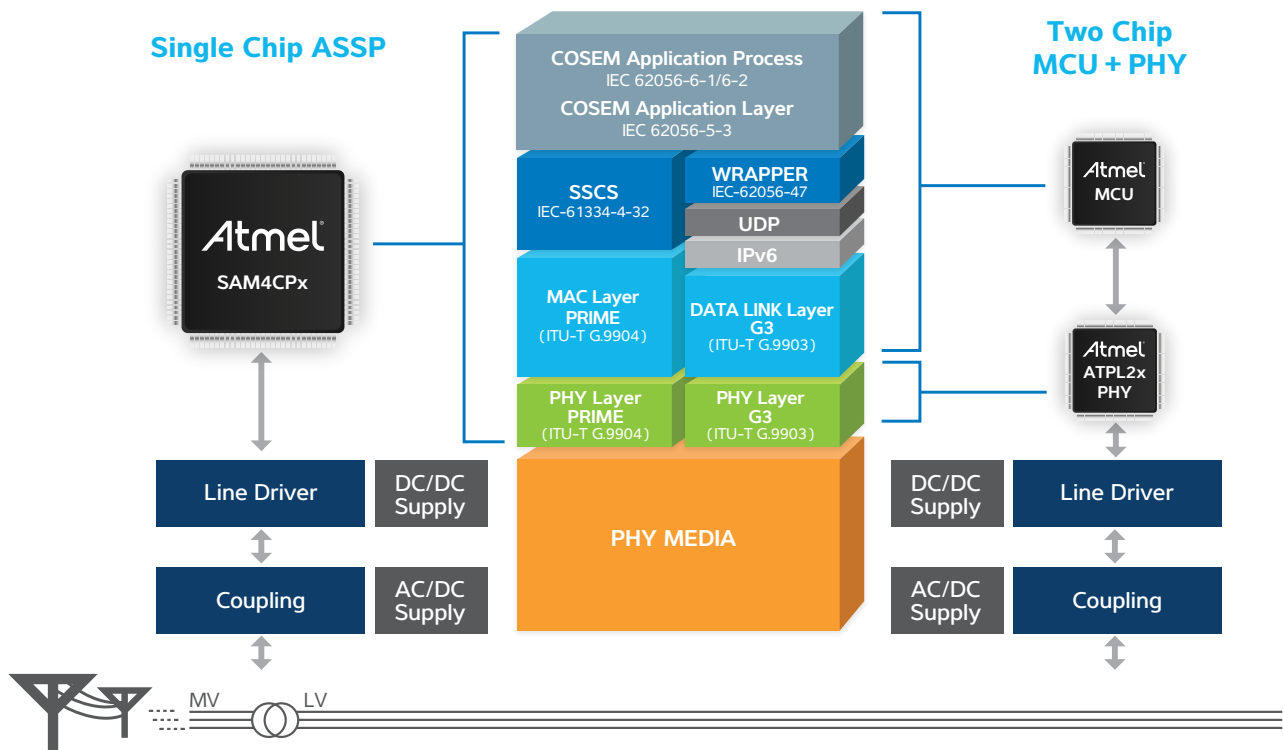

Figure 8. Atmel PLC Solutions. Flexible Architecture

A built in class-D amplifier architecture is up to 30% more efficient than competing solutions with only a handful of external discrete components, reducing power waste due to heat dissipation and increasing long-term reliability due to better thermal behavior.

An extensive array of system I/O, LCD, memory, RTC, DMA and cryptographic resources available in the Atmel | SMART SAM4CP series allow integration of application, communication and metrology software (using external Atmel metrology devices) to achieve highly reliable, flexible and cost effective smart meter designs.

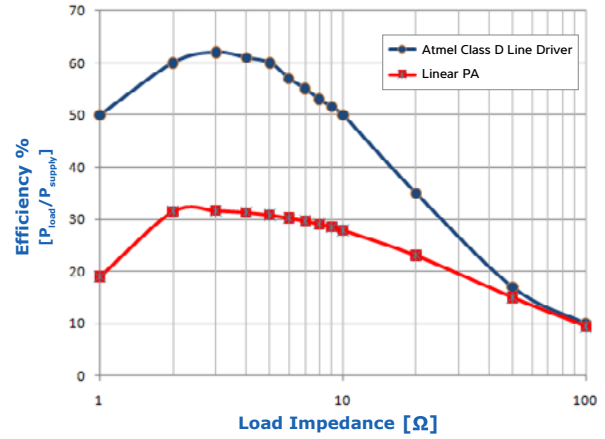

Figure 9. Class D Amplifier vs. Linear Power Amplifier Efficiency

	Standard	Frequency Band	Core	CPU Clock	Flash	SRAM	Package
PL230A	PRIME	CEN / ARIB / FCC	--	--	--	--	LQFP 80
PL250A	G3	CEN / ARIB / FCC	--	--	--	--	LQFP 80
SAM4CP16B	PRIME	CEN / ARIB / FCC	Dual Cortex-M4	120 MHz @core	1 MB	128 + 16 + 8 KB	LQFP 176
SAM4CP16C	G3	CEN / ARIB / FCC	Dual Cortex-M4	120 MHz @core	1 MB	128 + 16 + 8 KB	LQFP 176

Table 4. PLC Product Features

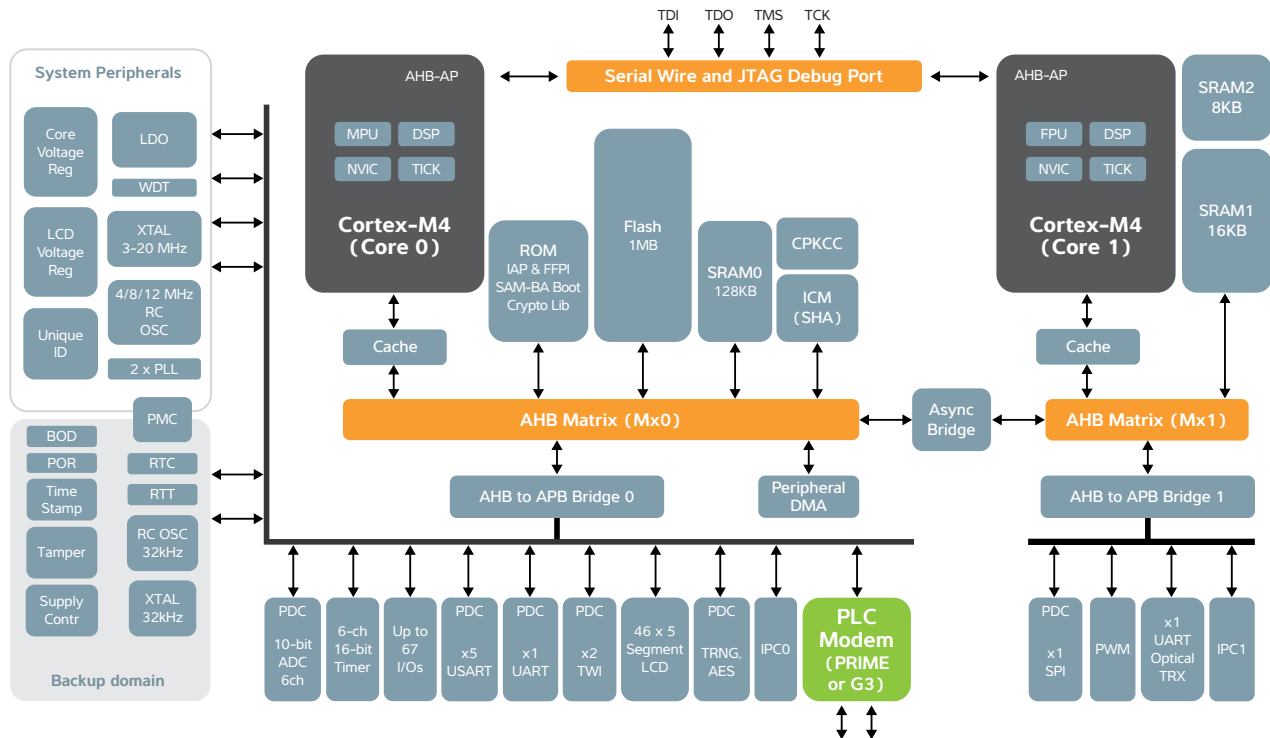

Figure 10. SAM4CP Series Block Diagram

Atmel PLC Software Stacks

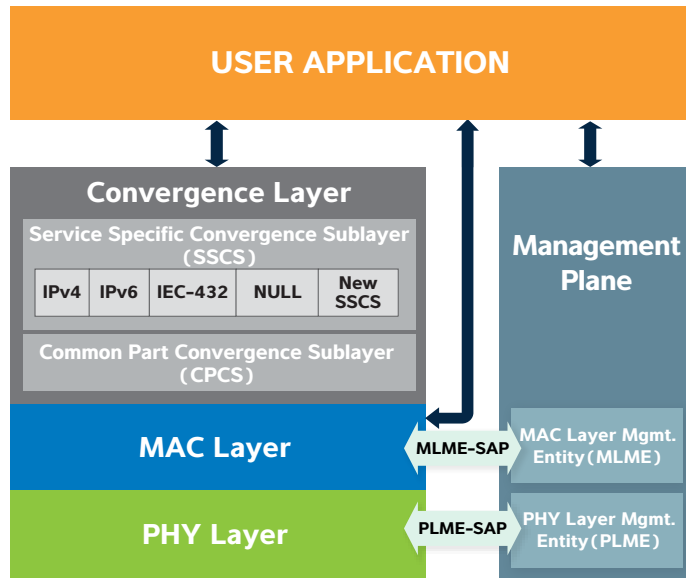

Figure 11. Atmel PRIME Software Stack

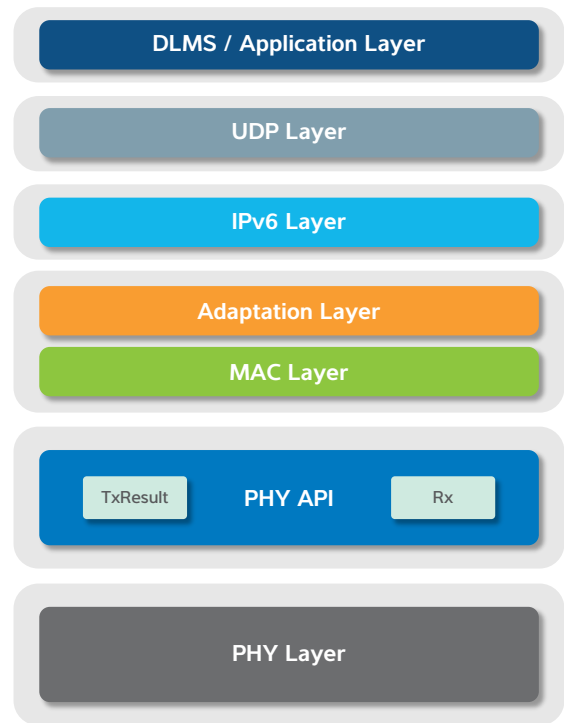

Figure 12. Atmel G3 Software Stack

Atmel provides PRIME and G3 software stacks that turn the management of PLC networks into a transparent process. Users can focus on top-level applications and access the Atmel PLC software stacks via user-friendly application programming interfaces (APIs).

Wireless Connectivity Products

Efficient smart energy wireless applications require both high-performance and power efficiency. Atmel transceivers deliver the leading RF link budget with the industry's lowest power consumption.

Additionally, Atmel offers the most feature-rich IEEE 802.15.4-compliant transceiver family available. Our transceivers support regional sub-1 GHz bands, as well as the global 2.4 GHz band. This enables you to develop wireless applications for customers worldwide, including emerging markets like China.

Enhanced Performance

Powerful hardware features like antenna diversity or external power amplifier support let you further boost transceiver performance to maximize network reliability and RF range of your system. Atmel transceivers support not only IEEE 802.15.4-compliant applications, but provide on-air data rates up to 2 Mbit/s for general purpose ISM (industrial scientific medical) applications. Pin compatibility ensures an easy transition between devices or frequency bands.

To help you speed up system development and prototyping, Atmel offers a variety of free software suites, various hardware evaluation boards, and development kits and modules.

Key Products

The AT86RF212B is a low-power, low-voltage RF transceiver for the regional 700/800/900 MHz frequency bands available in Japan, China, Europe and North America. This transceiver offers an extremely good 120 dB link budget (-110 dBm receiver sensitivity / +10 dBm transmit power) designed for low-cost IEEE 802.15.4, ZigBee® and high data rate ISM applications.

The Atmel AT86RF233 transceiver is designed to operate in the 2.4 GHz ISM band, available worldwide. This transceiver offers link budgets up to 105 dB (-101 dBm receiver sensitivity/+4 dBm transmit power). For a complete overview of features, key parameters, and targeted application areas, please see the data sheet.

AT86RF215 is a dual-band sub-1 GHz/2.4 GHz transceiver compliant to IEEE 802.15.4g-2012 and ETSI TS 102 887-1. The device offers very high flexibility by supporting a variety of data rates with three modulation schemes: multi-rate and multi-regional frequency shift keying (MR-FSK), orthogonal frequency division multiplexing (MR-OFDM), as well as offset quadrature phase-shift keying (MR-O-QPSK). This includes the physical layer which is used for ZigBee PRO and IP. With an output power of 14 dBm and receiver sensitivities down to -123 dBm, link budgets up to 137 dB can be achieved.

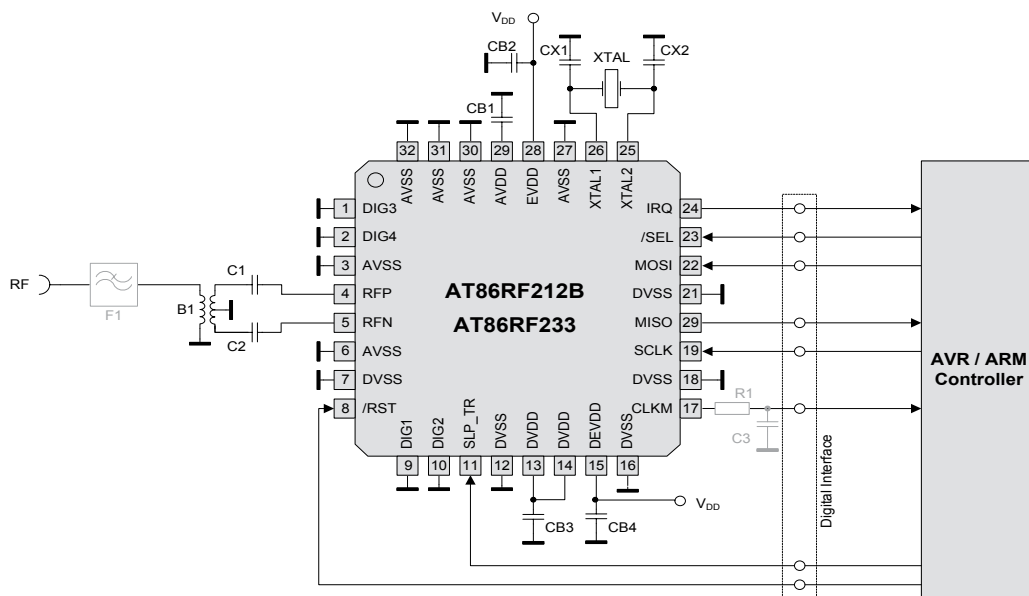

Figure 13. Wireless Transceiver Application Diagram

Atmel Smart Energy Solutions Guide

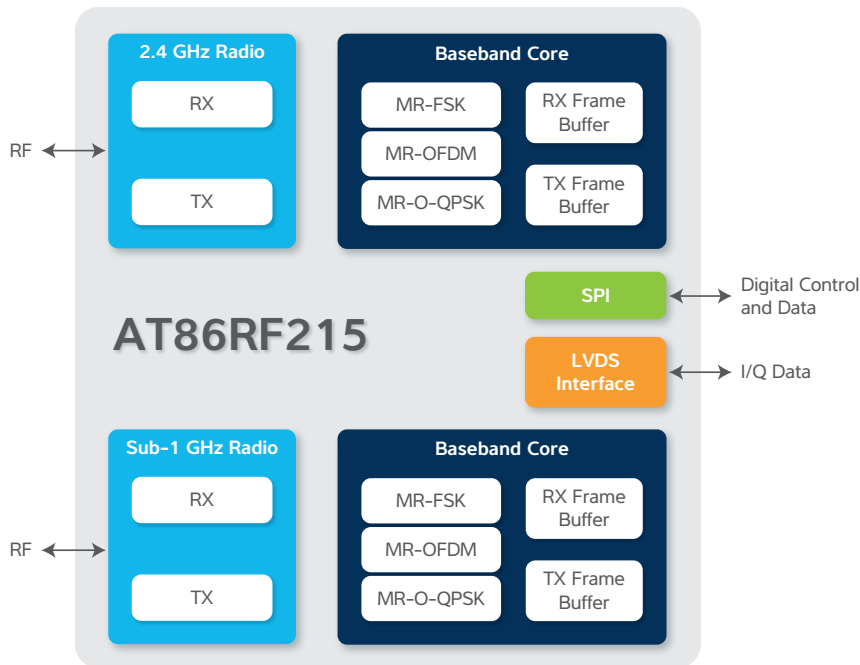

Figure 14. RF215 Block Diagram

Device	Band [MHz]	Modulation	Data Rate [kbit/s]	RX Sens. [dBm]	Max.TX Power [dBm]	Current: SLEEP, TRX_OFF, RX_ON, BUSY_TX	Pack.	Compliance
AT86RF212B Transceiver	769 ... 935	BPSK, O-QPSK	20, 40, 100, 250 <i>proprietary: 200, 400, 500, 1000</i>	-110 @ 20 kbit/s	10	0.2 μ A 0.4 mA 9.2 mA 17.0 mA @ 5 dBm	QFN32	IEEE 802.15.4-2006, IEEE 802.15.4-2011
AT86RF233 Transceiver	2322 ... 2527	O-QPSK	250 <i>proprietary: 500, 1000, 2000</i>	-101 @ 250 kbit/s	4	0.02/0.2 μ A 0.3 mA 6.0/11.8 mA 13.8 mA @ 4 dBm	QFN32	IEEE 802.15.4-2006, IEEE 802.15.4-2011
AT86RF215 Transceiver and I/Q radio	389 ...510 779 ...1020 2400 ...2483	MR-FSK, MR-OFDM, MR-O-QPSK, O-QPSK	6.25 ... 800 <i>proprietary up to 2400</i>	-123 @ 6.25 kbit/s	14	30 nA 3.0 mA 28 mA 65 mA @ 14 dBm	QFN48	IEEE 802.15.4-2006, IEEE 802.15.4-2011, IEEE 802.15.4g-2012, ETSI TS 102 887-1
AT86RF215M Transceiver and I/Q radio	389 ...510 779 ...102	MR-FSK, MR-OFDM, MR-O-QPSK, O-QPSK	6.25 ... 800 <i>proprietary up to 2400</i>	-123 @ 6.25 kbit/s	14	30 nA 3.0 mA 28 mA 65 mA @ 14 dBm	QFN48	IEEE 802.15.4-2011, IEEE 802.15.4g-2012, ETSI TS 102 887-1

Table 5. Wireless Transceiver Products

Smart Energy Portfolio

		Product	Ordering Code	Package	Features	Flash	MRL	
Metering MCU	ATSAM4C8C		ATSAM4C8CA-AU	100LQFP	Green, IND TEMP, CRYPTO	512 KB	A	
			ATSAM4C8CA-AUR	100LQFP	Green, IND TEMP, CRYPTO	512 KB	A	
			ATSAM4C8CB-AU	100LQFP	Green, IND TEMP, CRYPTO	512 KB	B	
			ATSAM4C8CB-AUR	100LQFP	Green, IND TEMP, CRYPTO	512 KB	B	
	ATSAM4C16C		ATSAM4C16CA-AU	100LQFP	Green, IND TEMP, CRYPTO	1 MB	A	
			ATSAM4C16CA-AUR	100LQFP	Green, IND TEMP, CRYPTO	1 MB	A	
			ATSAM4C16CB-AU	100LQFP	Green, IND TEMP, CRYPTO	1 MB	B	
			ATSAM4C16CB-AUR	100LQFP	Green, IND TEMP, CRYPTO	1 MB	B	
	ATSAM4C32CA		ATSAM4C32CA-AU	100LQFP	Green, IND TEMP, CRYPTO	2 MB	A	
			ATSAM4C32CA-AUR	100LQFP	Green, IND TEMP, CRYPTO	2 MB	A	
	ATSAM4C32EA		ATSAM4C32EA-AU	144LQFP	Green, IND TEMP, CRYPTO	2 MB	A	
			ATSAM4C32EA-AUR	144LQFP	Green, IND TEMP, CRYPTO	2 MB	A	
Metrology SoC	Single Phase	ATSAM4CMS8C	ATSAM4CMS8CA-AU	100LQFP	Green, IND TEMP, CRYPTO	512 KB	A	
			ATSAM4CMS8CA-AUR	100LQFP	Green, IND TEMP, CRYPTO	512 KB	A	
			ATSAM4CMS8CB-AU	100LQFP	Green, IND TEMP, CRYPTO	512 KB	B	
			ATSAM4CMS8CB-AUR	100LQFP	Green, IND TEMP, CRYPTO	512 KB	B	
		ATSAM4CMS16C	ATSAM4CMS16CA-AU	100LQFP	Green, IND TEMP, CRYPTO	1 MB	A	
			ATSAM4CMS16CA-AUR	100LQFP	Green, IND TEMP, CRYPTO	1 MB	A	
			ATSAM4CMS16CB-AU	100LQFP	Green, IND TEMP, CRYPTO	1 MB	B	
			ATSAM4CMS16CB-AUR	100LQFP	Green, IND TEMP, CRYPTO	1 MB	B	
	ATSAM4CMS32C	ATSAM4CMS32CA-AU	100LQFP	Green, IND TEMP, CRYPTO	2 MB	A		
		ATSAM4CMS32CA-AUR	100LQFP	Green, IND TEMP, CRYPTO	2 MB	A		
	3 Phase	ATSAM4CMP8C		ATSAM4CMP8CA-AU	100LQFP	Green, IND TEMP, CRYPTO	512 KB	A
				ATSAM4CMP8CA-AUR	100LQFP	Green, IND TEMP, CRYPTO	512 KB	A
				ATSAM4CMP8CB-AU	100LQFP	Green, IND TEMP, CRYPTO	512 KB	B
				ATSAM4CMP8CB-AUR	100LQFP	Green, IND TEMP, CRYPTO	512 KB	B
		ATSAM4CMP16C	ATSAM4CMP16CA-AU	100LQFP	Green, IND TEMP, CRYPTO	1 MB	A	
			ATSAM4CMP16CA-AUR	100LQFP	Green, IND TEMP, CRYPTO	1 MB	A	
ATSAM4CMP16CB-AU			100LQFP	Green, IND TEMP, CRYPTO	1 MB	B		
ATSAM4CMP16CB-AUR			100LQFP	Green, IND TEMP, CRYPTO	1 MB	B		
ATSAM4CMP32C	ATSAM4CMP32CA-AU	100LQFP	Green, IND TEMP, CRYPTO	2 MB	A			
	ATSAM4CMP32CA-AUR	100LQFP	Green, IND TEMP, CRYPTO	2 MB	A			

Atmel Smart Energy Solutions Guide

Package		Part Numbers	Kit Contents Pictures	IDE	RTOS	STACKS/LIBRARIES
Tray	Tools	ATSAM4C-EK		ATMEL Studio & ASF IAR KEIL	FreeRTOS	ATMEL Metrology & Crypto Libraries
Tape & Reel						
Tray						
Tape & Reel						
Tray						
Tape & Reel						
Tray		ATSAM4C32-EK				
Tape & Reel						
Tray						
Tape & Reel						
Tray						
Tape & Reel						
Tray	Tools	ATSAM4CMS-DB		ATMEL Studio & ASF IAR KEIL	FreeRTOS	ATMEL Metrology & Crypto Libraries
Tape & Reel						
Tray						
Tape & Reel						
Tray						
Tape & Reel						
Tray		ATSAM4CMP-DB				
Tape & Reel						
Tray						
Tape & Reel						
Tray						
Tape & Reel						

Smart Energy Portfolio (Continued)

		Product	Ordering Code	Package	Features	Flash	MRL
PLC	PRIME Modem	ATPL230A	ATPL230A-AKU-Y	80LQPF	Green, IND TEMP	--	A
			ATPL230A-AKU-R	80LQPF	Green, IND TEMP	--	A
	PRIME SoC	ATSAM4CP16B	ATSAM4CP16B-AHU-Y	176LQFP	Green, IND TEMP	1 MB	A
	G3 Modem	ATPL250A	ATPL250A-AKU-Y	80LQPF	Green, IND TEMP	--	--
			ATPL250A-AKU-R	80LQPF	Green, IND TEMP	--	--
G3 SoC	ATSAM4CP16C	ATSAM4CP16C-AHU-Y	176LQFP	Green, IND TEMP	1 MB	--	
RF	Sub-1 GHz Transceiver (IEEE 802.15.4-2011)	AT86RF212B	AT86RF212B-ZU	32QFN	700/800/900 MHz ZigBee Transceiver, 85°C	--	B
			AT86RF212B-ZUR	32QFN	700/800/900 MHz ZigBee Transceiver, 85°C	--	B
	2.4 GHz Transceiver (IEEE 802.15.4-2006)	AT86RF233	AT86RF233-ZF	32QFN	2.4 GHz ZigBee Transceiver, 125°C	--	A
			AT86RF233-ZFR	32QFN	2.4 GHz ZigBee Transceiver, 125°C	--	A
			AT86RF233-ZU	32QFN	2.4 GHz ZigBee Transceiver, 85°C	--	A
			AT86RF233-ZUR	32QFN	2.4 GHz ZigBee Transceiver, 85°C	--	A
	Dual-Band Transceiver (IEEE 802.15.4g-2012)	AT86RF215	AT86RF215-ZU	48QFN	Dual-Band Transceiver, 85°C	--	A
			AT86RF215-ZUR	48QFN	Dual-Band Transceiver, 85°C	--	A
	Sub-1 GHz Transceiver (IEEE 802.15.4g-2012)	AT86RF215M	AT86RF215M-ZU	48QFN	Sub-1 GHz Transceiver, 85°C	--	A
			AT86RF215M-ZUR	48QFN	Sub-1 GHz Transceiver, 85°C	--	A
	Dual-Band I/Q Radio	AT86RF215IQ	AT86RF215IQ-ZU	48QFN	Dual-Band I/Q Radio, 85°C	--	A
			AT86RF215IQ-ZUR	48QFN	Dual-Band I/Q Radio, 85°C	--	A

Atmel Smart Energy Solutions Guide

Package		Part Numbers	Kit Contents Pictures			IDE	RTOS	STACKS/LIBRARIES			
Tray	Tools	ATPL230A-EK (2 Modem Boards + 4 Couplings)	2x	2x	2x	ATMEL Studio & ASF IAR	FreeRTOS	PRIME			
Tape & Reel											
Tray		ATSAM4CP16B-EK (2 Boards + 4 Couplings)	2x	2x	2x	ATMEL Studio & ASF IAR	FreeRTOS	PRIME			
Tape & Reel											
Tray		ATPL250A-EK (2 Modem Boards + 4 Couplings)	2x	2x	2x	ATMEL Studio & ASF IAR	FreeRTOS	G3			
Tape & Reel											
Tray	ATSAM4CP16C-EK (2 Boards + 4 Couplings)	2x	2x	2x	ATMEL Studio & ASF IAR	FreeRTOS	G3				
Tray	Tools	ATSAM4L-XPRO + ATZB-212B-XPRO				ATMEL Studio ASF Wireless Performance Analyzer	FreeRTOS eCOS (SAM9)	Exegin Technologies: IEEE 802.15.4 MAC, ZigBee Pro/SEP1.x, ZigBee IP/SEP2.0, 6LoWPAN			
Tape & Reel											
Tray		ATSAM4L-XPRO + ATREB215-XPRO									
Tape & Reel											
Tray		ATSAM4L-XPRO + ATREB215-XPRO									
Tape & Reel											
Tray		ATREB215-XPRO							n/a	n/a	n/a
Tape & Reel											

Smart Energy Portfolio (Continued)

		Product	Ordering Code	Package	Features	Flash	MRL
SAM4C AFE Companion Chip	Single Phase	ATSENSE100	ATSENSE101A-SU	20SOIC	GREEN, IND TEMP	--	A
			ATSENSE101A-SUR	20SOIC	GREEN, IND TEMP	--	A
	Two Phase	ATSENSE200	ATSENSE201A-AU	32LQFP	GREEN, IND TEMP	--	A
			ATSENSE201A-AUR	32LQFP	GREEN, IND TEMP	--	A
			ATSENSE201HA-AU	32LQFP	GREEN, IND TEMP	--	A
			ATSENSE201HA-AUR	32LQFP	GREEN, IND TEMP	--	A
	3 Phase	ATSENSE300	ATSENSE301A-AU	32LQFP	GREEN, IND TEMP	--	A
			ATSENSE301A-AUR	32LQFP	GREEN, IND TEMP	--	A
			ATSENSE301HA-AU	32LQFP	GREEN, IND TEMP	--	A
			ATSENSE301HA-AUR	32LQFP	GREEN, IND TEMP	--	A
Stand Alone AFE (90E series)	Single Phase	ATM90E26	ATM90E26-YU-B	28-SSOP	IND TEMP, 1.8V/3V	--	--
			ATM90E26-YU-R	28-SSOP	IND TEMP, 1.8V/3V	--	--
	3 Phase	ATM90E32	ATM90E32AS-AU-R	48-TQFP	IND TEMP, 1.8V/3V	--	--
			ATM90E32AS-AU-Y	48-TQFP	IND TEMP, 1.8V/3V	--	--
		ATM90E36	ATM90E36A-AU-R	48-TQFP	IND TEMP, 1.8V/3V	--	--
			ATM90E36A-AU-Y	48-TQFP	IND TEMP, 1.8V/3V	--	--

Atmel Smart Energy Solutions Guide

Package		Part Numbers	Kit Contents Pictures	IDE	RTOS	STACKS/LIBRARIES
Tube	Tools	Use Metrology SoC Tools				
Tape & Reel						
Tube						
Tape & Reel						
Tube						
Tape & Reel						
Tube						
Tape & Reel						
Tube						
Tape & Reel						
Tube	Tools	ATM90E2X-DB				All SAM4C Software tools + Metrology Libraries
Tape & Reel						
Tape & Reel		ATM90E32AS-DB				All SAM4C Software tools + Metrology Libraries
Tray		ATM90E32AS-RD				Atmel Cortex-M4 based SAM4LC4C microcontroller and ATM90E32A Atmel Poly-Phase Energy Metering AFE chipset
Tape & Reel		ATM90E36A-DB				All SAM4C Software tools + Metrology Libraries
Tray	ATM90E36A-RD				Atmel Cortex-M4 based SAM4LC4C microcontroller and ATM90E36A Atmel Poly-Phase Energy Metering AFE chipset	



Atmel Corporation | 1600 Technology Drive, San Jose, CA 95110 USA | **T:** (+1) (408) 441.0311 | **F:** (+1) (408) 436.4200 | **www.atmel.com**

© 2015 Atmel Corporation. / Rev.: Atmel-45055F-Smart-Energy-Solution-Guide_E_US_022015

Atmel, Atmel logo and combinations thereof, Enabling Unlimited Possibilities, and others are registered trademarks or trademarks of Atmel Corporation in U.S. and other countries. Other terms and product names may be trademarks of others.

Disclaimer: The information in this document is provided in connection with Atmel products. No license, express or implied, by estoppel or otherwise, to any intellectual property right is granted by this document or in connection with the sale of Atmel products. EXCEPT AS SET FORTH IN THE ATMEL TERMS AND CONDITIONS OF SALES LOCATED ON THE ATMEL WEBSITE, ATMEL ASSUMES NO LIABILITY WHATSOEVER AND DISCLAIMS ANY EXPRESS, IMPLIED OR STATUTORY WARRANTY RELATING TO ITS PRODUCTS INCLUDING, BUT NOT LIMITED TO, THE IMPLIED WARRANTY OF MERCHANTABILITY, FITNESS FOR A PARTICULAR PURPOSE, OR NON-INFRINGEMENT. IN NO EVENT SHALL ATMEL BE LIABLE FOR ANY DIRECT, INDIRECT, CONSEQUENTIAL, PUNITIVE, SPECIAL OR INCIDENTAL DAMAGES (INCLUDING, WITHOUT LIMITATION, DAMAGES FOR LOSS AND PROFITS, BUSINESS INTERRUPTION, OR LOSS OF INFORMATION) ARISING OUT OF THE USE OR INABILITY TO USE THIS DOCUMENT, EVEN IF ATMEL HAS BEEN ADVISED OF THE POSSIBILITY OF SUCH DAMAGES. Atmel makes no representations or warranties with respect to the accuracy or completeness of the contents of this document and reserves the right to make changes to specifications and products descriptions at any time without notice. Atmel does not make any commitment to update the information contained herein. Unless specifically provided otherwise, Atmel products are not suitable for, and shall not be used in, automotive applications. Atmel products are not intended, authorized, or warranted for use as components in applications intended to support or sustain life.

Данный компонент на территории Российской Федерации

Вы можете приобрести в компании MosChip.

Для оперативного оформления запроса Вам необходимо перейти по данной ссылке:

<http://moschip.ru/get-element>

Вы можете разместить у нас заказ для любого Вашего проекта, будь то серийное производство или разработка единичного прибора.

В нашем ассортименте представлены ведущие мировые производители активных и пассивных электронных компонентов.

Нашей специализацией является поставка электронной компонентной базы двойного назначения, продукции таких производителей как XILINX, Intel (ex.ALTERA), Vicor, Microchip, Texas Instruments, Analog Devices, Mini-Circuits, Amphenol, Glenair.

Сотрудничество с глобальными дистрибьюторами электронных компонентов, предоставляет возможность заказывать и получать с международных складов практически любой перечень компонентов в оптимальные для Вас сроки.

На всех этапах разработки и производства наши партнеры могут получить квалифицированную поддержку опытных инженеров.

Система менеджмента качества компании отвечает требованиям в соответствии с ГОСТ Р ИСО 9001, ГОСТ РВ 0015-002 и ЭС РД 009

Офис по работе с юридическими лицами:

105318, г.Москва, ул.Щербаковская д.3, офис 1107, 1118, ДЦ «Щербаковский»

Телефон: +7 495 668-12-70 (многоканальный)

Факс: +7 495 668-12-70 (доб.304)

E-mail: info@moschip.ru

Skype отдела продаж:

moschip.ru

moschip.ru_4

moschip.ru_6

moschip.ru_9