

Sxx35x Series



Description

Excellent unidirectional switches for phase control applications such as heating and motor speed controls. Standard phase control SCRs are triggered with few milliamperes of current at less than 1.5V potential.

Features & Benefits

- RoHS compliant
- Glass – passivated junctions
- Voltage capability up to 1000 V
- Surge capability up to 500 A

Applications

Typical applications are AC solid-state switches, industrial power tools, exercise equipment, white goods and commercial appliances.

Internally constructed isolated packages are offered for ease of heat sinking with highest isolation voltage.

Agency Approval

Agency	Agency File Number
	K Packages: E71639

Main Features

Symbol	Value	Unit
$I_{T(RMS)}$	35	A
V_{DRM}/V_{RRM}	400 to 1000	V
I_{GT}	40	mA

Schematic Symbol

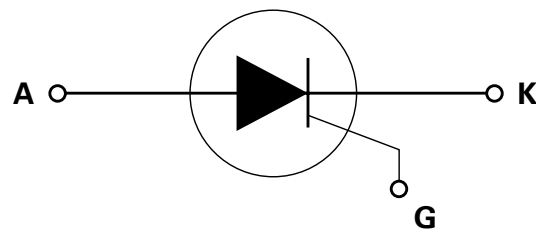

Absolute Maximum Ratings

Symbol	Parameter	Test Conditions	Value	Unit
$I_{T(RMS)}$	RMS on-state current	$T_c = 95^\circ\text{C}$	35	A
$I_{T(AV)}$	Average on-state current	$T_c = 95^\circ\text{C}$	22.0	A
I_{TSM}	Peak non-repetitive surge current	single half cycle; $f = 50\text{Hz}$; T_j (initial) = 25°C	425	A
		single half cycle; $f = 60\text{Hz}$; T_j (initial) = 25°C	500	
I^2t	I^2t Value for fusing	$t_p = 8.3 \text{ ms}$	1035	A^2s
di/dt	Critical rate of rise of on-state current	$f = 60\text{Hz}$; $T_j = 125^\circ\text{C}$	150	$\text{A}/\mu\text{s}$
I_{GM}	Peak gate current	$T_j = 125^\circ\text{C}$	3.5	A
$P_{G(AV)}$	Average gate power dissipation	$T_j = 125^\circ\text{C}$	0.8	W
T_{stg}	Storage temperature range		-40 to 150	$^\circ\text{C}$
T_j	Operating junction temperature range		-40 to 125	$^\circ\text{C}$

Electrical Characteristics ($T_J = 25^\circ\text{C}$, unless otherwise specified)

Symbol	Test Conditions		Value	Unit	
I_{GT}	$V_D = 12\text{V}; R_L = 30\Omega$		MAX.	40	mA
			MIN.	5	
V_{GT}	$V_D = 12\text{V}; R_L = 30\Omega$		MAX.	1.5	V
dv/dt	$V_D = V_{DRM}; \text{gate open}; T_J = 100^\circ\text{C}$	400V	MIN.	450	V/ μs
		600V		425	
		800V		400	
		1000V		200	
	$V_D = V_{DRM}; \text{gate open}; T_J = 125^\circ\text{C}$	400V		350	
		600V		325	
	800V	300			
V_{GD}	$V_D = V_{DRM}; R_L = 3.3\text{ k}\Omega; T_J = 125^\circ\text{C}$		MIN.	0.2	V
I_H	$I_T = 400\text{mA}$ (initial)		MAX.	50	mA
t_q	(1)		MAX.	35	μs
t_{gt}	$I_G = 2 \times I_{GT}; \text{PW} = 15\mu\text{s}; I_T = 70\text{A}$		TYP.	2	μs

Notes :

(1) $I_T=2\text{A}; t_p=50\mu\text{s}; \text{dv/dt}=5\text{V}/\mu\text{s}; \text{di/dt}=30\text{A}/\mu\text{s}$

Static Characteristics

Symbol	Test Conditions		Value	Unit		
V_{TM}	$I_T = 70\text{A}; t_p = 380\mu\text{s}$		MAX.	1.8	V	
I_{DRM} / I_{RRM}	V_{DRM} / V_{RRM}	$T_J = 25^\circ\text{C}$	400 – 600V	MAX.	10	μA
			800 – 1000V		20	
		$T_J = 100^\circ\text{C}$	400 – 600V		1000	
			800V		1500	
			1000V		3000	
			1000V		3000	
$T_J = 125^\circ\text{C}$	400 – 600V	2000				
	800V	3000				

Thermal Resistance

Symbol	Parameter	Value	Unit
$R_{\theta(J-C)}$	Junction to case (AC)	0.7	$^\circ\text{C/W}$

Additional Information



Datasheet



Resources



Samples

Figure 1: Normalized DC Gate Trigger Current vs. Junction Temperature

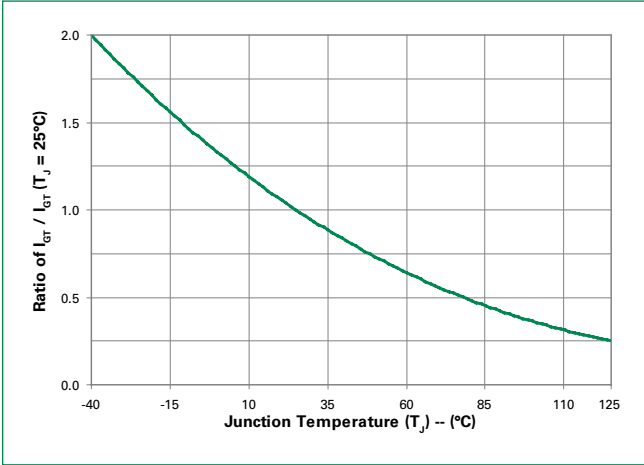

Figure 2: Normalized DC Gate Trigger Voltage vs. Junction Temperature

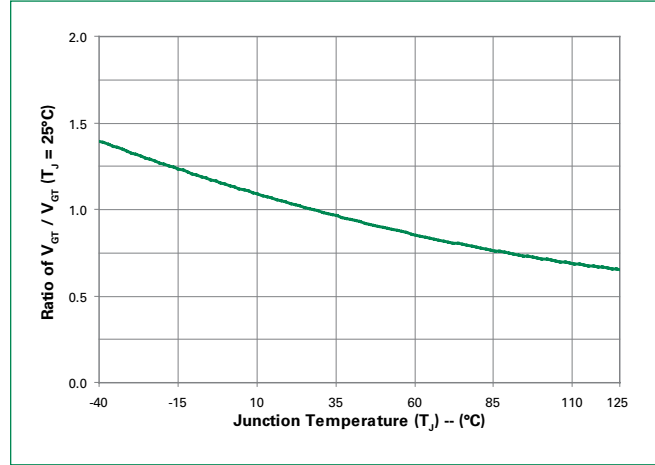

Figure 3: Normalized DC Holding Current vs. Junction Temperature

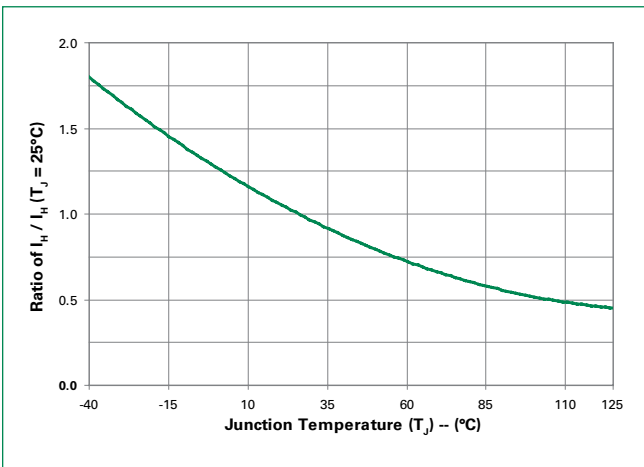

Figure 4: On-State Current vs. On-State Voltage (Typical)

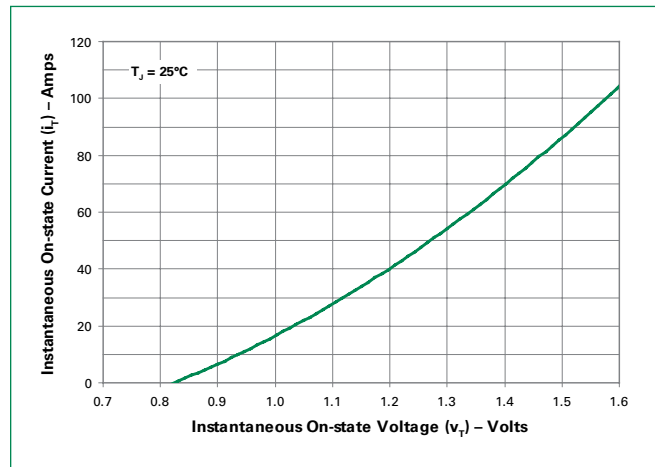

Figure 5: Power Dissipation (Typical) vs. RMS On-State Current

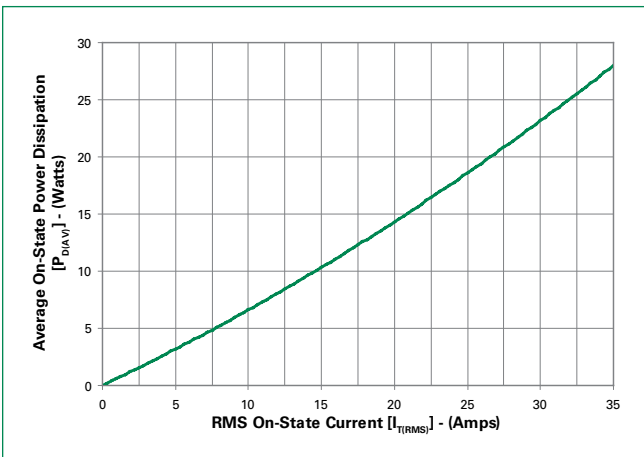

Figure 6: Maximum Allowable Case Temperature vs. RMS On-State Current

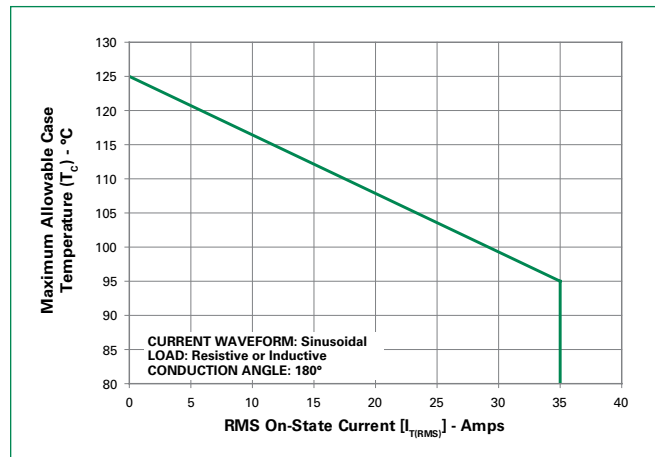

Figure 7: Maximum Allowable Case Temperature vs. Average On-State Current

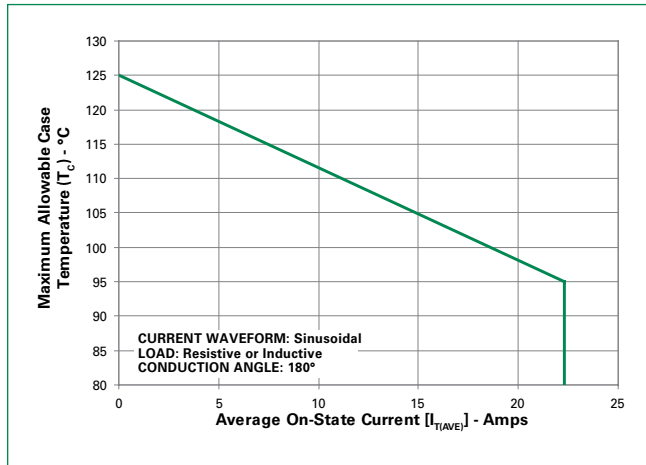

Figure 8: Peak Capacitor Discharge Current



Figure 9: Peak Capacitor Discharge Current Derating

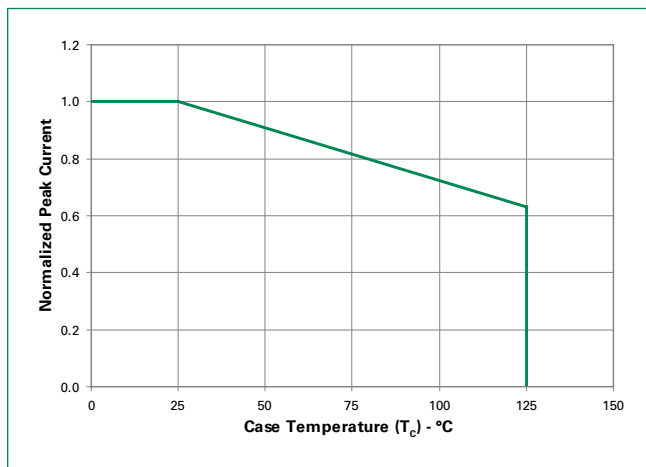
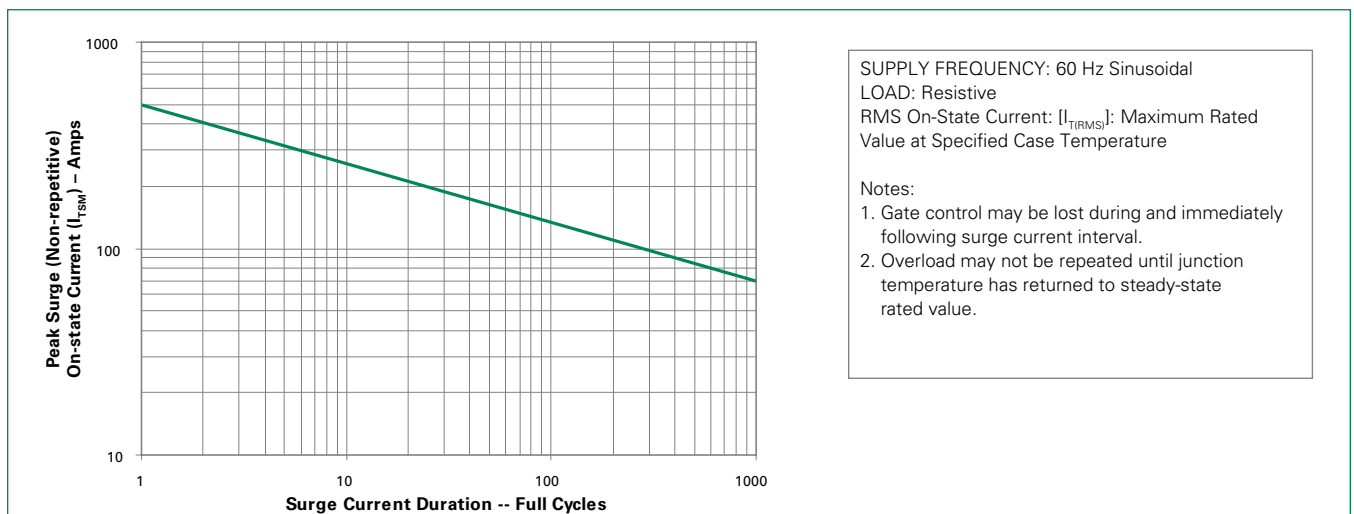

Figure 10: Surge Peak On-State Current vs. Number of Cycles



Soldering Parameters

Reflow Condition		Pb – Free assembly
Pre Heat	- Temperature Min ($T_{s(min)}$)	150°C
	- Temperature Max ($T_{s(max)}$)	200°C
	- Time (min to max) (t_s)	60 – 180 secs
Average ramp up rate (Liquidus Temp) (T_L) to peak		5°C/second max
$T_{s(max)}$ to T_L - Ramp-up Rate		5°C/second max
Reflow	- Temperature (T_L) (Liquidus)	217°C
	- Temperature (t_l)	60 – 150 seconds
Peak Temperature (T_p)		260 ^{+0/-5} °C
Time within 5°C of actual peak Temperature (t_p)		20 – 40 seconds
Ramp-down Rate		5°C/second max
Time 25°C to peak Temperature (T_p)		8 minutes Max.
Do not exceed		280°C



Physical Specifications

Terminal Finish	100% Matte Tin-plated
Body Material	UL recognized epoxy meeting flammability classification 94V-0
Lead Material	Copper Alloy

Design Considerations

Careful selection of the correct device for the application's operating parameters and environment will go a long way toward extending the operating life of the Thyristor. Good design practice should limit the maximum continuous current through the main terminals to 75% of the device rating. Other ways to ensure long life for a power discrete semiconductor are proper heat sinking and selection of voltage ratings for worst case conditions. Overheating, overvoltage (including dv/dt), and surge currents are the main killers of semiconductors. Correct mounting, soldering, and forming of the leads also help protect against component damage.

Environmental Specifications

Test	Specifications and Conditions
AC Blocking	MIL-STD-750, M-1040, Cond A Applied Peak AC voltage @ 125°C for 1008 hours
Temperature Cycling	MIL-STD-750, M-1051, 100 cycles; -40°C to +150°C; 15-min dwell-time
Temperature/Humidity	EIA / JEDEC, JESD22-A101 1008 hours; 320V - DC: 85°C; 85% rel humidity
High Temp Storage	MIL-STD-750, M-1031, 1008 hours; 150°C
Low-Temp Storage	1008 hours; -40°C
Resistance to Solder Heat	MIL-STD-750 Method 2031
Solderability	ANSI/J-STD-002, category 3, Test A
Lead Bend	MIL-STD-750, M-2036 Cond E

Dimensions – TO- 218X (J Package) – Isolated Mounting Tab

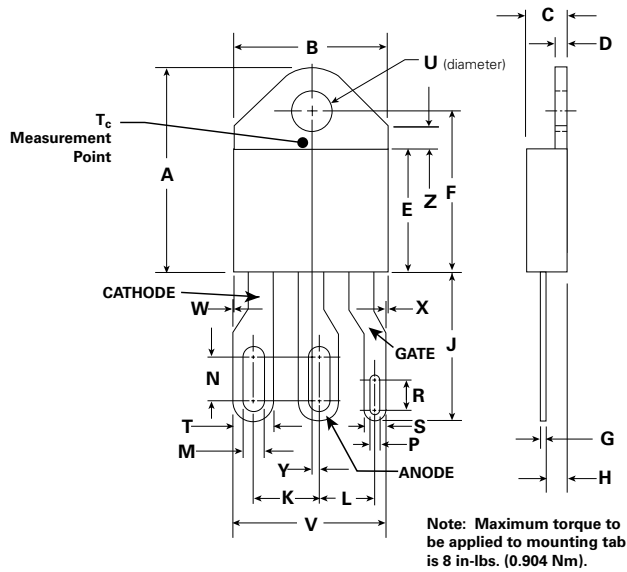

Dimension	Inches		Millimeters	
	Min	Max	Min	Max
A	0.810	0.835	20.57	21.21
B	0.610	0.630	15.49	16.00
C	0.178	0.188	4.52	4.78
D	0.055	0.070	1.40	1.78
E	0.487	0.497	12.37	12.62
F	0.635	0.655	16.13	16.64
G	0.022	0.029	0.56	0.74
H	0.075	0.095	1.91	2.41
J	0.575	0.625	14.61	15.88
K	0.256	0.264	6.50	6.71
L	0.220	0.228	5.58	5.79
M	0.080	0.088	2.03	2.24
N	0.169	0.177	4.29	4.49
P	0.034	0.042	0.86	1.07
R	0.113	0.121	2.87	3.07
S	0.086	0.096	2.18	2.44
T	0.156	0.166	3.96	4.22
U	0.164	0.165	4.10	4.20
V	0.603	0.618	15.31	15.70
W	0.000	0.005	0.00	0.13
X	0.003	0.012	0.07	0.30
Y	0.028	0.032	0.71	0.81
Z	0.085	0.095	2.17	2.42

Dimensions – TO- 218AC (K Package) – Isolated Mounting Tab

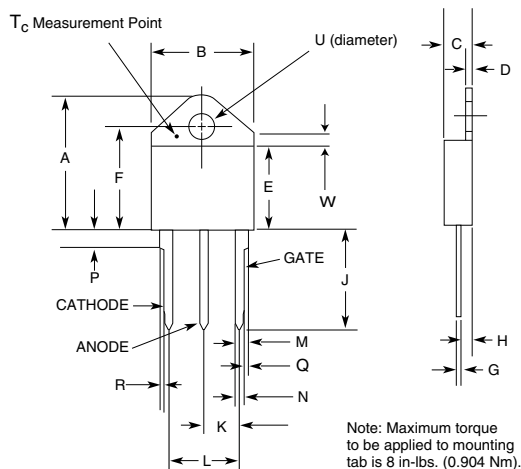

Dimension	Inches		Millimeters	
	Min	Max	Min	Max
A	0.810	0.835	20.57	21.21
B	0.610	0.630	15.49	16.00
C	0.178	0.188	4.52	4.78
D	0.055	0.070	1.40	1.78
E	0.487	0.497	12.37	12.62
F	0.635	0.655	16.13	16.64
G	0.022	0.029	0.56	0.74
H	0.075	0.095	1.91	2.41
J	0.575	0.625	14.61	15.88
K	0.211	0.219	5.36	5.56
L	0.422	0.437	10.72	11.10
M	0.058	0.068	1.47	1.73
N	0.045	0.055	1.14	1.40
P	0.095	0.115	2.41	2.92
Q	0.008	0.016	0.20	0.41
R	0.008	0.016	0.20	0.41
U	0.164	0.165	4.10	4.20
W	0.085	0.095	2.17	2.42

Product Selector

Part Number	Voltage				Gate Sensitivity	Type	Package
	400V	600V	800V	1000V			
Sxx35K	X	X	X	X	40mA	Standard SCR	TO-218AC
Sxx35J	X	X	X		40mA	Standard SCR	TO-218X

Note: xx = Voltage

Packing Options

Part Number	Marking	Weight	Packing Mode	Base Quantity
Sxx35KTP	Sxx35K	4.40g	Tube	250 (25 per tube)
Sxx35JTP	Sxx35J	5.23g	Tube	250 (25 per tube)

Note: xx = Voltage

Part Numbering System

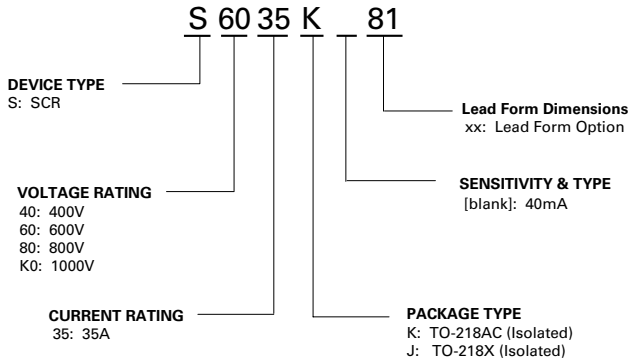

Part Marking System

TO-218 AC - (K Package)
TO-218 X - (J Package)

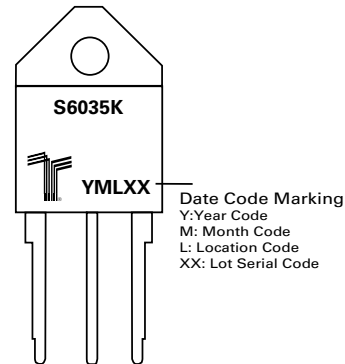

Данный компонент на территории Российской Федерации

Вы можете приобрести в компании MosChip.

Для оперативного оформления запроса Вам необходимо перейти по данной ссылке:

<http://moschip.ru/get-element>

Вы можете разместить у нас заказ для любого Вашего проекта, будь то серийное производство или разработка единичного прибора.

В нашем ассортименте представлены ведущие мировые производители активных и пассивных электронных компонентов.

Нашей специализацией является поставка электронной компонентной базы двойного назначения, продукции таких производителей как XILINX, Intel (ex.ALTERA), Vicor, Microchip, Texas Instruments, Analog Devices, Mini-Circuits, Amphenol, Glenair.

Сотрудничество с глобальными дистрибьюторами электронных компонентов, предоставляет возможность заказывать и получать с международных складов практически любой перечень компонентов в оптимальные для Вас сроки.

На всех этапах разработки и производства наши партнеры могут получить квалифицированную поддержку опытных инженеров.

Система менеджмента качества компании отвечает требованиям в соответствии с ГОСТ Р ИСО 9001, ГОСТ РВ 0015-002 и ЭС РД 009

Офис по работе с юридическими лицами:

105318, г.Москва, ул.Щербаковская д.3, офис 1107, 1118, ДЦ «Щербаковский»

Телефон: +7 495 668-12-70 (многоканальный)

Факс: +7 495 668-12-70 (доб.304)

E-mail: info@moschip.ru

Skype отдела продаж:

moschip.ru

moschip.ru_4

moschip.ru_6

moschip.ru_9