

## Logic N-Channel MOSFET

### Features

- $R_{DS(on)}$  (Max 5  $\Omega$ ) @  $V_{GS}=10V$   
 $R_{DS(on)}$  (Max 5.3 $\Omega$ ) @  $V_{GS}=4.5V$
- Gate Charge (Typical 0.5nC)
- Maximum Junction Temperature Range (150°C)



### General Description

This Power MOSFET is produced using planar DMOS technology. And this Power MOSFET is well suited for Battery switch, Load switch, Motor controller and other small signal switches.



### Absolute Maximum Ratings

Symbol	Parameter	Value	Units
$V_{DSS}$	Drain to Source Voltage	60	V
$I_D$	Continuous Drain Current (@ $T_A = 25^\circ C$ )	200	mA
$I_{DM}$	Drain Current Pulsed (Note 1)	500	mA
$V_{GS}$	Gate to Source Voltage	$\pm 20$	V
$P_D$	Total Power Dissipation Single Operation ( $T_A=25^\circ C$ )	0.4	W
	Total Power Dissipation Single Operation ( $T_A=70^\circ C$ )	3.2	mW
$T_{STG}, T_J$	Operating Junction Temperature & Storage Temperature	- 55 ~ 150	$^\circ C$
$T_L$	Maximum Lead Temperature for soldering purpose, 1/8 from Case for 10 seconds.	300	$^\circ C$

### Thermal Characteristics

Symbol	Parameter	Value			Units
		Min.	Typ.	Max.	
$R_{\theta JA}$	Thermal Resistance, Junction-to-Ambient	-	-	312.5	$^\circ C/W$

# 2N7000

## Electrical Characteristics ( $T_J = 25\text{ }^\circ\text{C}$ unless otherwise noted )

Symbol	Parameter	Test Conditions	Min	Typ	Max	Units
<b>Off Characteristics</b>						
$BV_{DSS}$	Drain-Source Breakdown Voltage	$V_{GS} = 0V, I_D = 250\mu A$	60	-	-	V
$\Delta BV_{DSS} / \Delta T_J$	Breakdown Voltage Temperature coefficient	$I_D = 250\mu A$ , referenced to $25\text{ }^\circ\text{C}$	-	48	-	mV/°C
$I_{DSS}$	Drain-Source Leakage Current	$V_{DS} = 60V, V_{GS} = 0V$ $V_{DS} = 60V, V_{GS} = 0V, T_J = 125\text{ }^\circ\text{C}$	-	-	1 1000	$\mu A$
$I_{GSS}$	Gate-Source Leakage, Forward	$V_{GS} = 20V, V_{DS} = 0V$	-	-	100	nA
	Gate-Source Leakage, Reverse	$V_{GS} = -20V, V_{DS} = 0V$	-	-	-100	nA
<b>On Characteristics</b>						
$V_{GS(th)}$	Gate Threshold Voltage	$V_{DS} = V_{GS}, I_D = 250\mu A$	1.0	-	2.5	V
$R_{DS(ON)}$	Static Drain-Source On-state Resistance	$V_{GS} = 10V, I_D = 500mA$ $V_{GS} = 4.5V, I_D = 75mA$	- -	1.55 1.9	5 5.3	$\Omega$
<b>Dynamic Characteristics</b>						
$C_{iss}$	Input Capacitance	$V_{GS} = 0V, V_{DS} = 25V, f = 1MHz$	-	20	25	pF
$C_{oss}$	Output Capacitance		-	11	14	
$C_{rss}$	Reverse Transfer Capacitance		-	3	4	
<b>Dynamic Characteristics</b>						
$t_{d(on)}$	Turn-on Delay Time	$V_{DD} = 30V, I_D = 200mA, R_G = 50\Omega$ $V_{GS} = 10V$ (Note 2,3)	-	4	18	ns
$t_r$	Rise Time		-	2.5	15	
$t_{d(off)}$	Turn-off Delay Time		-	17	44	
$t_f$	Fall Time		-	7	24	
$Q_g$	Total Gate Charge	$V_{DS} = 30V, V_{GS} = 4.5V, I_D = 200mA$ (Note 2,3)	-	0.5	0.65	nC
$Q_{gs}$	Gate-Source Charge		-	0.15	-	
$Q_{gd}$	Gate-Drain Charge(Miller Charge)		-	0.2	-	

## Source-Drain Diode Ratings and Characteristics

Symbol	Parameter	Test Conditions	Min.	Typ.	Max.	Unit.
$I_S$	Maximum Continuous Diode Forward Current		-	-	200	mA
$V_{SD}$	Diode Forward Voltage	$I_S = 200mA, V_{GS} = 0V$ (Note 2)	-	-	1.2	V

### ※ NOTES

1. Repeativity rating : pulse width limited by junction temperature
2. Pulse Test : Pulse Width  $\leq 300\mu s$ , Duty Cycle  $\leq 2\%$
3. Essentially independent of operating temperature.



**Fig 1. On-State Characteristics**



**Fig 2. Transfer Characteristics**



**Fig 3. On Resistance Variation vs. Drain Current and Gate Voltage**



**Fig 4. On State Current vs. Allowable Case Temperature**



**Fig 5. Capacitance Characteristics**



**Fig 6. Gate Charge Characteristics**



# 2N7000

Fig 7. Breakdown Voltage Variation vs. Junction Temperature

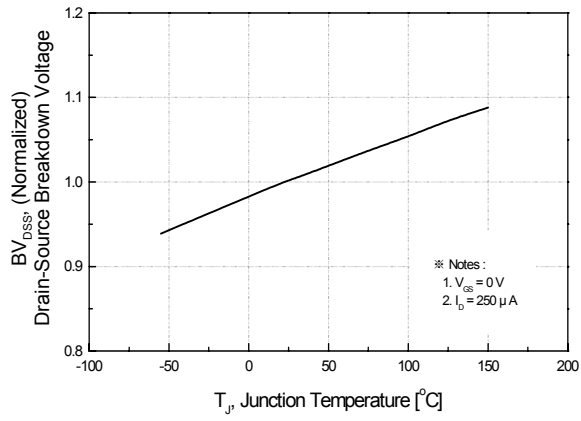

Fig 8. On-Resistance Variation vs. Junction Temperature



Fig. 9. Gate Charge Test Circuit & Waveforms



Fig 10. Switching Time Test Circuit & Waveforms

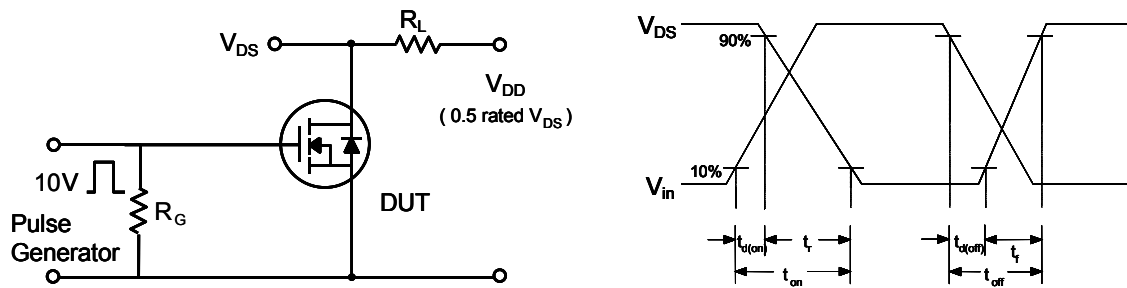

# 2N7000

## TO-92 Package Dimension

Dim.	mm			Inch		
	Min.	Typ.	Max.	Min.	Typ.	Max.
A		4.2			0.165	
B			3.7			0.146
C	4.43		4.83	0.174		0.190
D	14.07		14.87	0.554		0.585
E			0.4			0.016
F	4.43		4.83	0.174		0.190
G			0.45			0.017
H		2.54			0.100	
I		2.54			0.100	
J	0.33		0.48	0.013		0.019

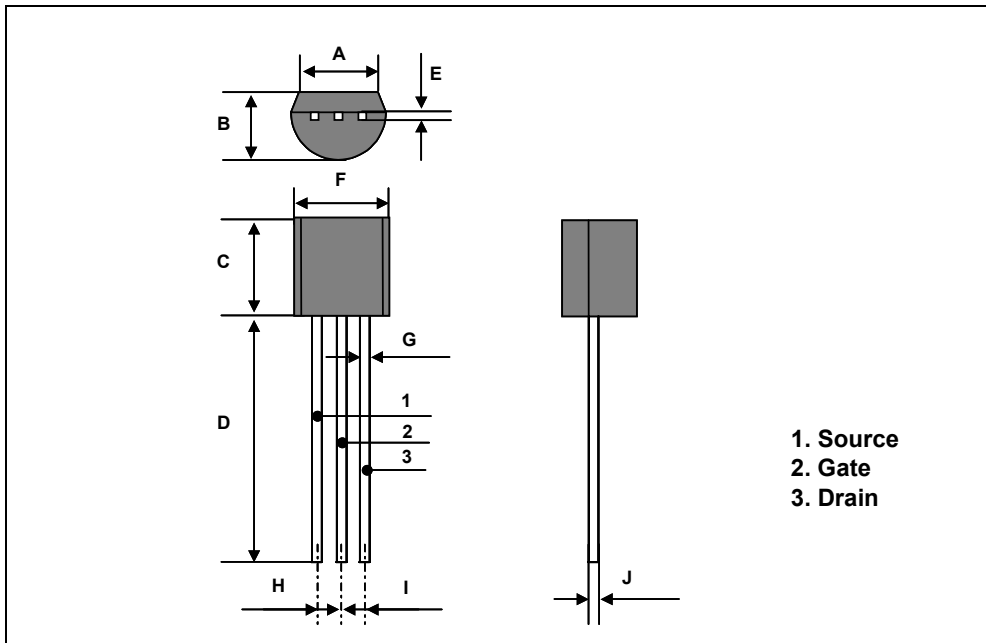

## Данный компонент на территории Российской Федерации

### Вы можете приобрести в компании MosChip.

Для оперативного оформления запроса Вам необходимо перейти по данной ссылке:

<http://moschip.ru/get-element>

Вы можете разместить у нас заказ для любого Вашего проекта, будь то серийное производство или разработка единичного прибора.

В нашем ассортименте представлены ведущие мировые производители активных и пассивных электронных компонентов.

Нашей специализацией является поставка электронной компонентной базы двойного назначения, продукции таких производителей как XILINX, Intel (ex.ALTERA), Vicor, Microchip, Texas Instruments, Analog Devices, Mini-Circuits, Amphenol, Glenair.

Сотрудничество с глобальными дистрибьюторами электронных компонентов, предоставляет возможность заказывать и получать с международных складов практически любой перечень компонентов в оптимальные для Вас сроки.

На всех этапах разработки и производства наши партнеры могут получить квалифицированную поддержку опытных инженеров.

Система менеджмента качества компании отвечает требованиям в соответствии с ГОСТ Р ИСО 9001, ГОСТ РВ 0015-002 и ЭС РД 009

### Офис по работе с юридическими лицами:

105318, г.Москва, ул.Щербаковская д.3, офис 1107, 1118, ДЦ «Щербаковский»

Телефон: +7 495 668-12-70 (многоканальный)

Факс: +7 495 668-12-70 (доб.304)

E-mail: [info@moschip.ru](mailto:info@moschip.ru)

Skype отдела продаж:

moschip.ru

moschip.ru\_4

moschip.ru\_6

moschip.ru\_9