

Logic N-Channel MOSFET

Features

- $R_{DS(on)}$ (Max 5 Ω)@ $V_{GS}=10V$
 $R_{DS(on)}$ (Max 5.3 Ω)@ $V_{GS}=4.5V$
- Gate Charge (Typical 0.5nC)
- Maximum Junction Temperature Range (150°C)

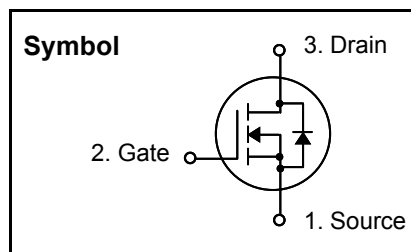

General Description

This Power MOSFET is produced using planar DMOS technology. And this Power MOSFET is well suited for Battery switch, Load switch, Motor controller and other small signal switches.

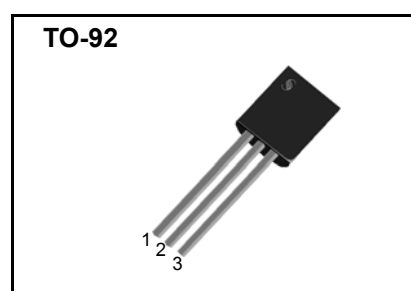

Absolute Maximum Ratings

Symbol	Parameter	Value	Units
V_{DSS}	Drain to Source Voltage	60	V
I_D	Continuous Drain Current(@ $T_A = 25^\circ C$)	200	mA
I_{DM}	Drain Current Pulsed (Note 1)	500	mA
V_{GS}	Gate to Source Voltage	± 20	V
P_D	Total Power Dissipation Single Operation ($T_A=25^\circ C$)	0.4	W
	Total Power Dissipation Single Operation ($T_A=70^\circ C$)	3.2	mW
T_{STG}, T_J	Operating Junction Temperature & Storage Temperature	- 55 ~ 150	$^\circ C$
T_L	Maximum Lead Temperature for soldering purpose, 1/8 from Case for 10 seconds.	300	$^\circ C$

Thermal Characteristics

Symbol	Parameter	Value			Units
		Min.	Typ.	Max.	
$R_{\theta JA}$	Thermal Resistance, Junction-to-Ambient	-	-	312.5	$^\circ C/W$

2N7000

Electrical Characteristics ($T_J = 25\text{ }^\circ\text{C}$ unless otherwise noted)

Symbol	Parameter	Test Conditions	Min	Typ	Max	Units
Off Characteristics						
BV_{DSS}	Drain-Source Breakdown Voltage	$V_{GS} = 0V, I_D = 250\mu A$	60	-	-	V
$\Delta BV_{DSS} / \Delta T_J$	Breakdown Voltage Temperature coefficient	$I_D = 250\mu A$, referenced to $25\text{ }^\circ\text{C}$	-	48	-	mV/ $^\circ\text{C}$
I_{DSS}	Drain-Source Leakage Current	$V_{DS} = 60V, V_{GS} = 0V$ $V_{DS} = 60V, V_{GS} = 0V, T_J = 125\text{ }^\circ\text{C}$	-	-	1 1000	μA
I_{GSS}	Gate-Source Leakage, Forward	$V_{GS} = 20V, V_{DS} = 0V$	-	-	100	nA
	Gate-Source Leakage, Reverse	$V_{GS} = -20V, V_{DS} = 0V$	-	-	-100	nA
On Characteristics						
$V_{GS(th)}$	Gate Threshold Voltage	$V_{DS} = V_{GS}, I_D = 250\mu A$	1.0	-	2.5	V
$R_{DS(ON)}$	Static Drain-Source On-state Resistance	$V_{GS} = 10V, I_D = 500mA$ $V_{GS} = 4.5V, I_D = 75mA$	- -	1.55 1.9	5 5.3	Ω
Dynamic Characteristics						
C_{iss}	Input Capacitance	$V_{GS} = 0V, V_{DS} = 25V, f = 1MHz$	-	20	25	pF
C_{oss}	Output Capacitance		-	11	14	
C_{rss}	Reverse Transfer Capacitance		-	3	4	
Dynamic Characteristics						
$t_{d(on)}$	Turn-on Delay Time	$V_{DD} = 30V, I_D = 200mA, R_G = 50\Omega$ $V_{GS} = 10V$ (Note 2,3)	-	4	18	ns
t_r	Rise Time		-	2.5	15	
$t_{d(off)}$	Turn-off Delay Time		-	17	44	
t_f	Fall Time		-	7	24	
Q_g	Total Gate Charge	$V_{DS} = 30V, V_{GS} = 4.5V, I_D = 200mA$ (Note 2,3)	-	0.5	0.65	nC
Q_{gs}	Gate-Source Charge		-	0.15	-	
Q_{gd}	Gate-Drain Charge(Miller Charge)		-	0.2	-	

Source-Drain Diode Ratings and Characteristics

Symbol	Parameter	Test Conditions	Min.	Typ.	Max.	Unit.
I_S	Maximum Continuous Diode Forward Current		-	-	200	mA
V_{SD}	Diode Forward Voltage	$I_S = 200mA, V_{GS} = 0V$ (Note 2)	-	-	1.2	V

※ NOTES

1. Repeativity rating : pulse width limited by junction temperature
2. Pulse Test : Pulse Width $\leq 300\mu s$, Duty Cycle $\leq 2\%$
3. Essentially independent of operating temperature.



Fig 1. On-State Characteristics

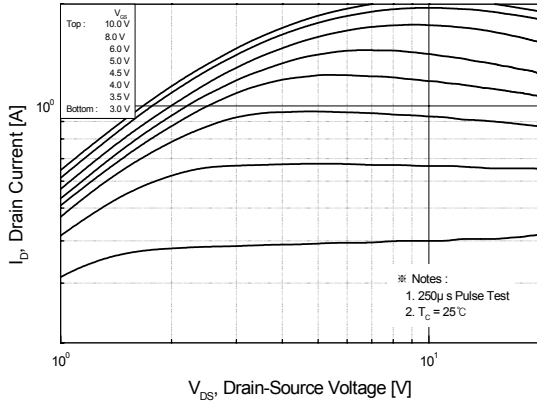

Fig 2. Transfer Characteristics

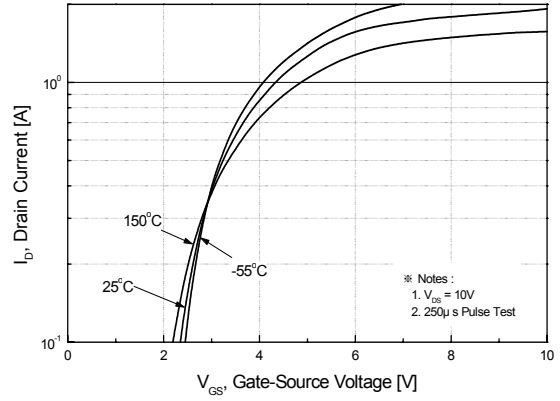

Fig 3. On Resistance Variation vs. Drain Current and Gate Voltage

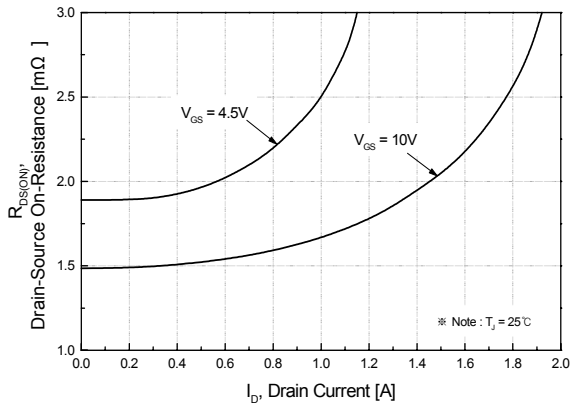

Fig 4. On State Current vs. Allowable Case Temperature

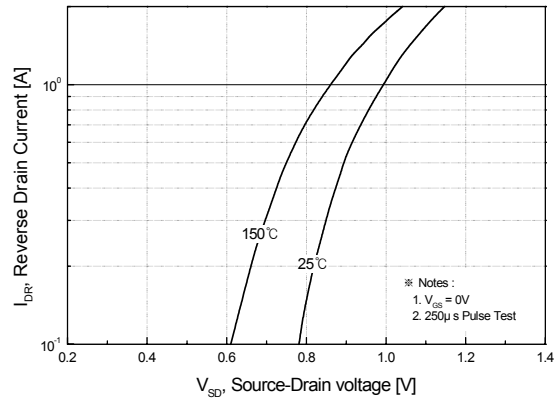

Fig 5. Capacitance Characteristics

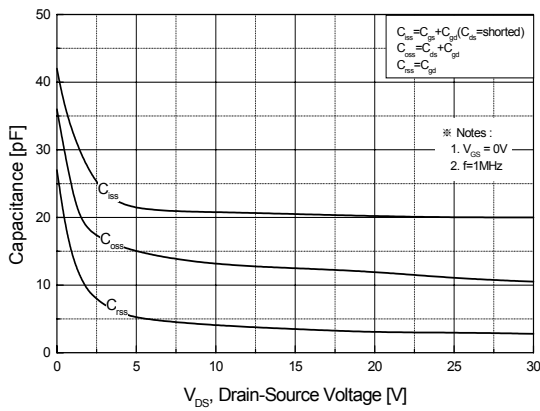
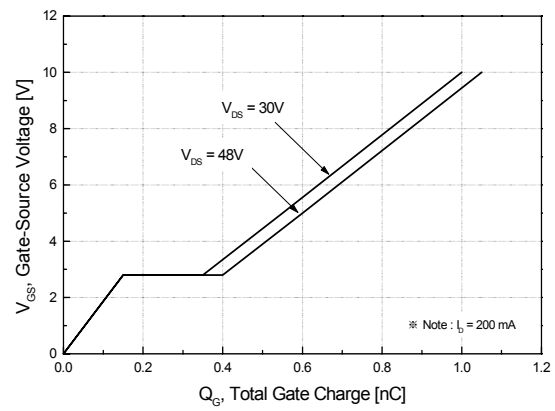

Fig 6. Gate Charge Characteristics



2N7000

Fig 7. Breakdown Voltage Variation vs. Junction Temperature

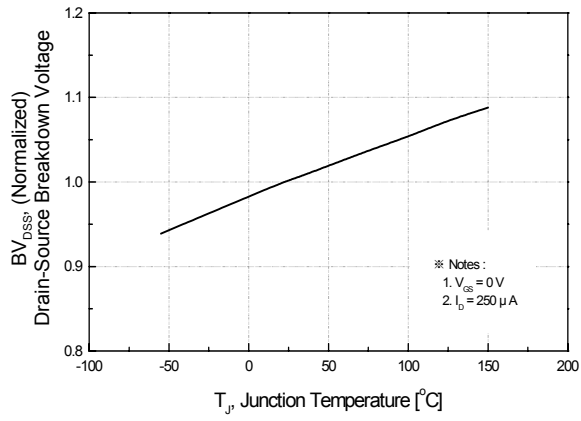

Fig 8. On-Resistance Variation vs. Junction Temperature

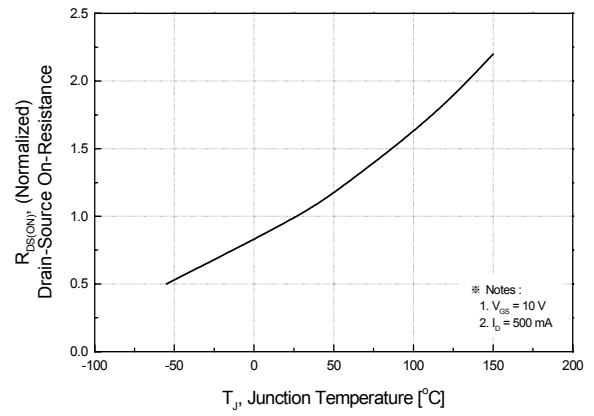

Fig. 9. Gate Charge Test Circuit & Waveforms

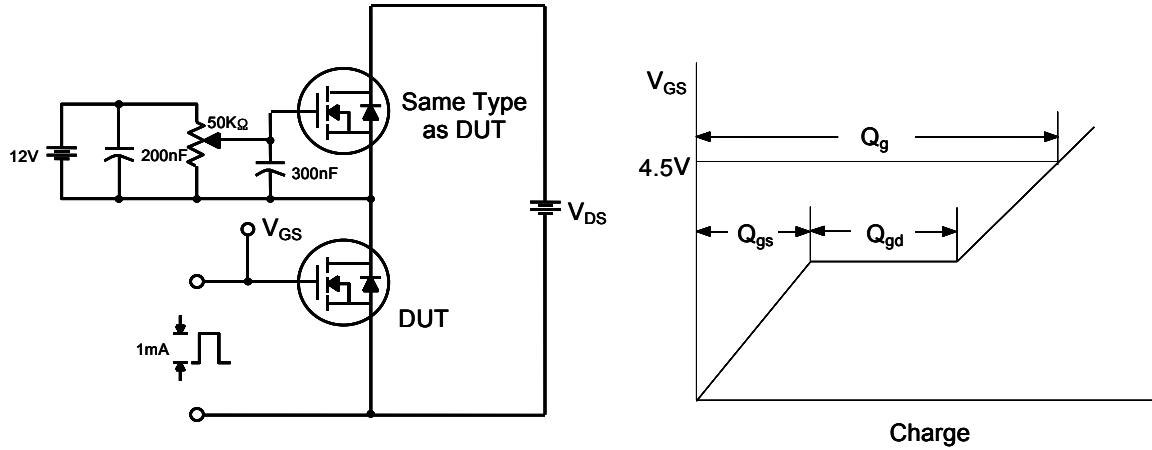
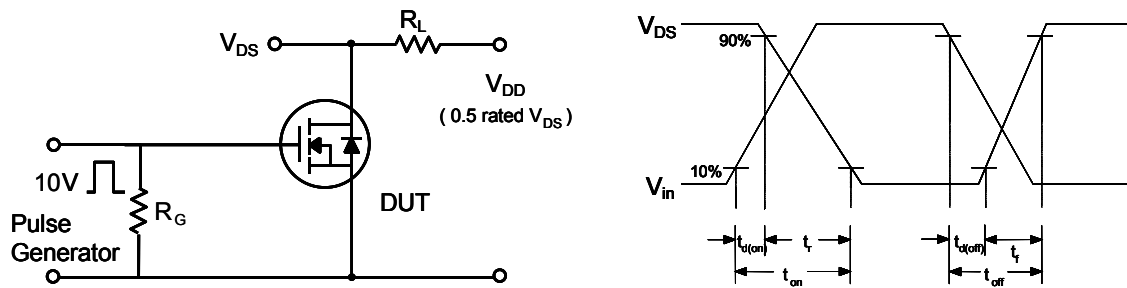

Fig 10. Switching Time Test Circuit & Waveforms



2N7000

TO-92 Package Dimension

Dim.	mm			Inch		
	Min.	Typ.	Max.	Min.	Typ.	Max.
A		4.2			0.165	
B			3.7			0.146
C	4.43		4.83	0.174		0.190
D	14.07		14.87	0.554		0.585
E			0.4			0.016
F	4.43		4.83	0.174		0.190
G			0.45			0.017
H		2.54			0.100	
I		2.54			0.100	
J	0.33		0.48	0.013		0.019

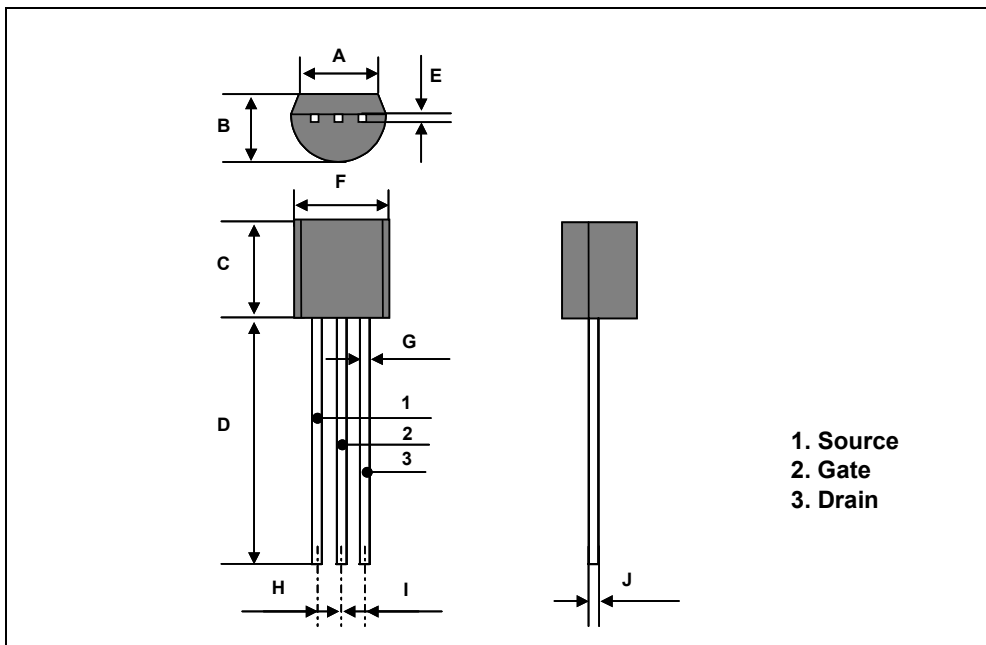

Данный компонент на территории Российской Федерации

Вы можете приобрести в компании MosChip.

Для оперативного оформления запроса Вам необходимо перейти по данной ссылке:

<http://moschip.ru/get-element>

Вы можете разместить у нас заказ для любого Вашего проекта, будь то серийное производство или разработка единичного прибора.

В нашем ассортименте представлены ведущие мировые производители активных и пассивных электронных компонентов.

Нашей специализацией является поставка электронной компонентной базы двойного назначения, продукции таких производителей как XILINX, Intel (ex.ALTERA), Vicor, Microchip, Texas Instruments, Analog Devices, Mini-Circuits, Amphenol, Glenair.

Сотрудничество с глобальными дистрибьюторами электронных компонентов, предоставляет возможность заказывать и получать с международных складов практически любой перечень компонентов в оптимальные для Вас сроки.

На всех этапах разработки и производства наши партнеры могут получить квалифицированную поддержку опытных инженеров.

Система менеджмента качества компании отвечает требованиям в соответствии с ГОСТ Р ИСО 9001, ГОСТ РВ 0015-002 и ЭС РД 009

Офис по работе с юридическими лицами:

105318, г.Москва, ул.Щербаковская д.3, офис 1107, 1118, ДЦ «Щербаковский»

Телефон: +7 495 668-12-70 (многоканальный)

Факс: +7 495 668-12-70 (доб.304)

E-mail: info@moschip.ru

Skype отдела продаж:

moschip.ru

moschip.ru_4

moschip.ru_6

moschip.ru_9