

General Descriptions

- DCX100NS is best suited for applications where the load needs to be turned on and off using control circuits like micro-controllers, comparators etc. particularly at a point of load. It features a discrete PNP pass transistor which can support continuous maximum current up to 100 mA. It also contains an NPN transistor which can be used as a control switch and can also be biased using higher supply. The component devices can be used as part of a circuit or as stand alone discrete devices.

Features

- Built in Biasing Resistors
- Epitaxial Planar Die Construction
- Lead Free By Design/ROHS Compliant (Note 1)**
- "Green" Device (Note 2)**
- Ideally Suited for Automated Assembly Processes**

Mechanical Data

- Case: SOT-563
- Case Material: Molded Plastic. "Green" Molding Compound. UL Flammability Classification Rating 94V-0
- Moisture Sensitivity: Level 1 per J-STD-020
- Terminal Connections: See Diagram
- Terminals: Finish - Matte Tin annealed over Copper leadframe. Solderable per MIL-STD-202, Method 208
- Marking Information: See Page 5
- Ordering Information: See Page 5
- Weight: 0.0035 grams (approximate)



SOT-563

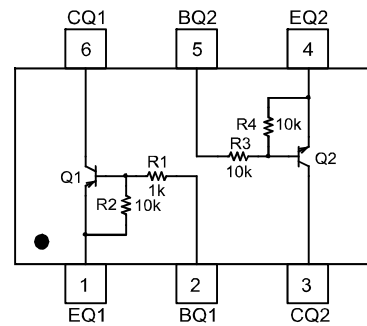

Schematic and Pin Configuration

Reference	Device Type	R1 (NOM)	R2 (NOM)	R3, R4 (NOM)
Q1	PNP	1K Ω	10K Ω	—
Q2	NPN	—	—	10K Ω

Maximum Ratings: Total Device @T_A = 25°C unless otherwise specified

Characteristic	Symbol	Value	Unit
Power Dissipation (Note 3)	P _D	150	mW
Collector Current (using PNP as Pass Transistor)	I _{C(max)}	100	mA
Thermal Resistance, Junction to Ambient Air (Note 3)	R _{θJA}	833	°C/W
Operating and Storage Junction Temperature Range	T _J , T _{STG}	-55 to +150	°C

Sub-Component Device - Pre-Biased PNP Transistor @T_A = 25°C unless otherwise specified

Characteristic	Symbol	Value	Unit
Supply Voltage	V _{CC}	-50	V
Input Voltage	V _{in}	+5 to -10	V
Output Current	I _C	-100	mA

- Notes:
- No purposefully added lead.
 - Diodes Inc.'s "Green" policy can be found on our website at http://www.diodes.com/products/lead_free/index.php.
 - Device mounted on FR-4 PCB, 1 inch x 0.85 inch x 0.062 inch; please see page 6 or as per Diodes Inc. suggested pad layout document AP02001 on our website at <http://www.diodes.com/datasheets/ap02001.pdf>.

Sub-Component Device - Pre-Biased NPN Transistor @T_A = 25°C unless otherwise specified

Characteristic	Symbol	Value	Unit
Supply Voltage	V _{CC}	50	V
Input Voltage	V _{in}	-10 to +40	V
Output Current	I _O	50	mA

Electrical Characteristics: Pre-Biased PNP Transistor @T_A = 25°C unless otherwise specified

Characteristic	Symbol	Min	Typ	Max	Unit	Test Condition
Input Voltage	V _{I(off)}	-0.3	—	—	V	V _{CC} = -5V, I _O = -100uA
	V _{I(on)}	—	—	-3.0	V	V _O = -0.3V, I _O = -20mA
Output Voltage	V _{O(on)}	—	0.1	-0.3	V	I _O /I _I = -10mA / -0.5mA
Input Current	I _I	—	—	-7.2	mA	V _I = -5V
Output Current	I _{O(off)}	—	—	-0.5	uA	V _{CC} = -50V, V _I = 0V
DC Current Gain	G _I	33	—	—	—	V _O = -5V, I _O = -5mA
Input Resistor Tolerance	ΔR1	-30	—	+30	%	—
Resistance Ratio Tolerance	R2/R1	0.8	1	1.2	%	—
Gain-Bandwidth Product	f _T	—	250	—	MHz	V _{CE} = -10V, I _E = -5mA, f = 100 MHz

Electrical Characteristics: Pre-Biased NPN Transistor @T_A = 25°C unless otherwise specified

Characteristic	Symbol	Min	Typ	Max	Unit	Test Condition
Input Voltage	V _{I(off)}	0.5	1.18	—	V	V _{CC} = 5V, I _O = 100uA
	V _{I(on)}	—	1.85	3	V	V _O = 0.3V, I _O = 10mA
Output Voltage	V _{O(on)}	—	0.1	0.3	V	I _O /I _I = 10mA / 0.5mA
Input Current	I _I	—	—	0.88	mA	V _I = 5V
Output Current	I _{O(off)}	—	—	0.5	uA	V _{CC} = 50V, V _I = 0V
DC Current Gain	G _I	30	—	—	—	V _O = 5V, I _O = 5mA
Input Resistor Tolerance	ΔR1	-30	—	+30	%	—
Resistor Ratio Tolerance	R2/R1	0.8	1	1.2	—	—
Gain-Bandwidth Product	f _T	—	250	—	MHz	V _{CE} = 10V, I _E = 5mA, f = 100 MHz

Typical Characteristics @T_A = 25°C unless otherwise specified

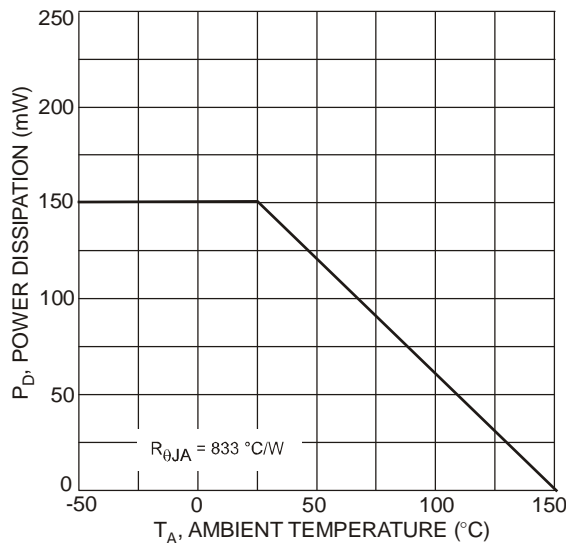

Fig. 1 Power Derating Curve (Total Device)

Characteristics Curves of PNP Transistor (Q1)

@T_A = 25°C unless otherwise specified

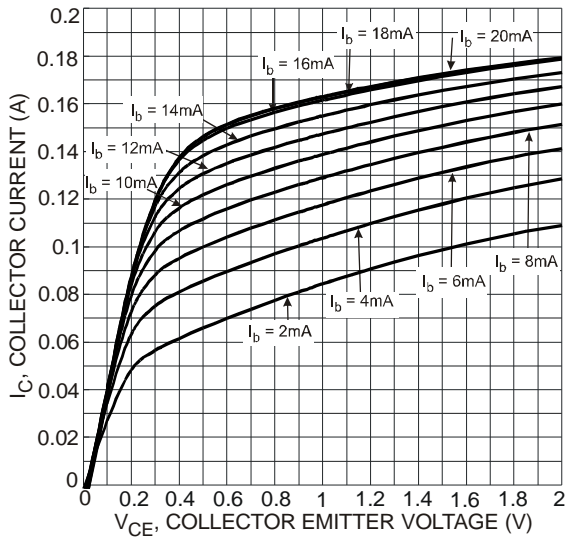

Fig. 2 Typical Collector Current vs. Collector-Emitter Voltage

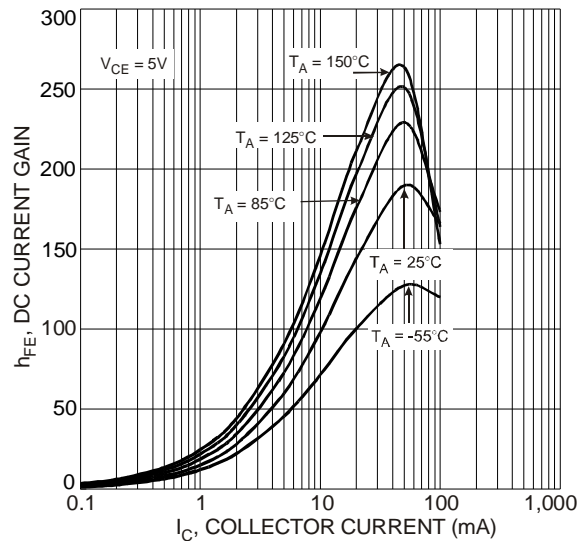

Fig. 3 Typical DC Current Gain vs. Collector Current

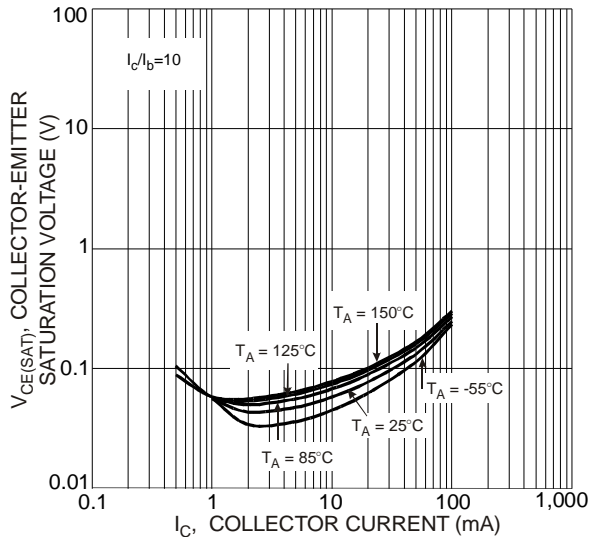

Fig. 4 Typical Collector-Emitter Saturation Voltage vs. Collector Current

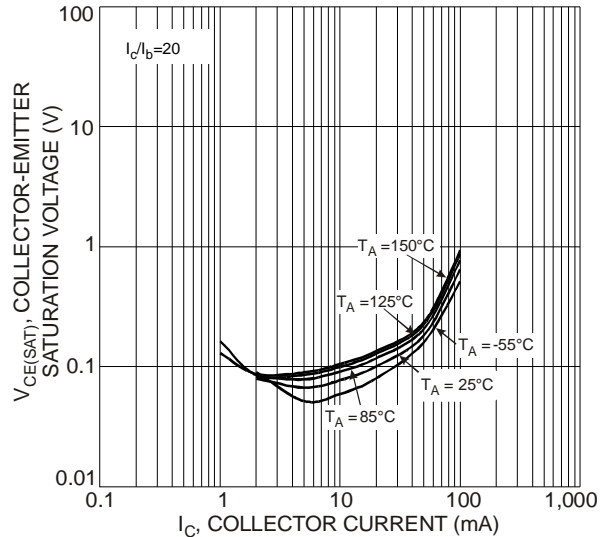

Fig. 5 Typical Collector-Emitter Saturation Voltage vs. Collector Current

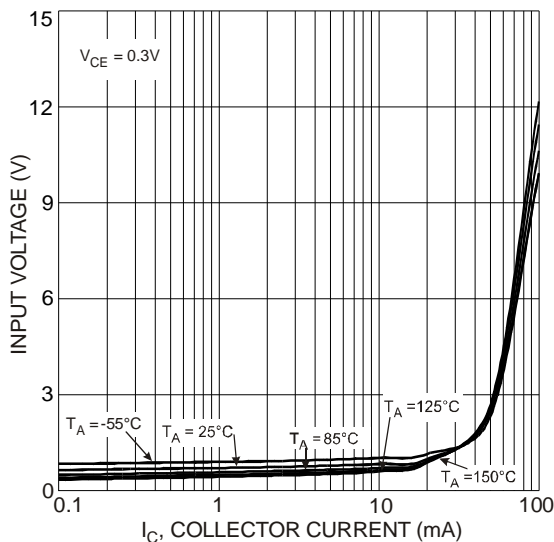

Fig. 6 Typical Input Voltage vs. Collector Current

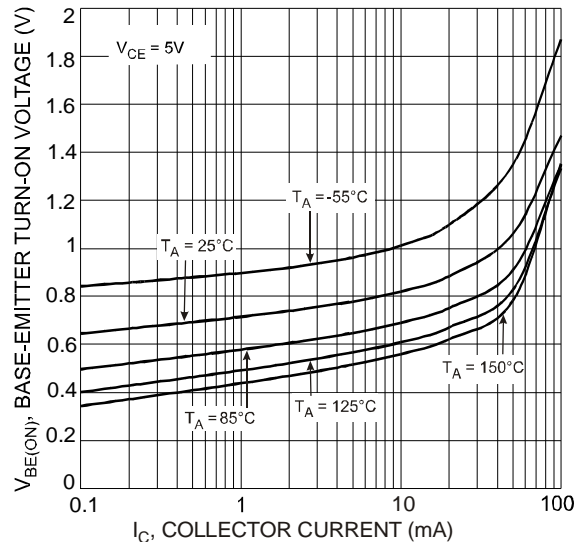

Fig. 7 Typical Base-Emitter Turn-On Voltage vs. Collector Current

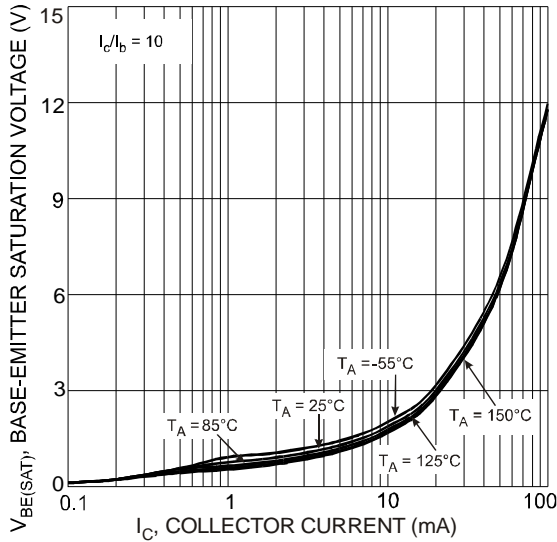

Fig. 8 Typical Base-Emitter Saturation Voltage vs. Collector Current

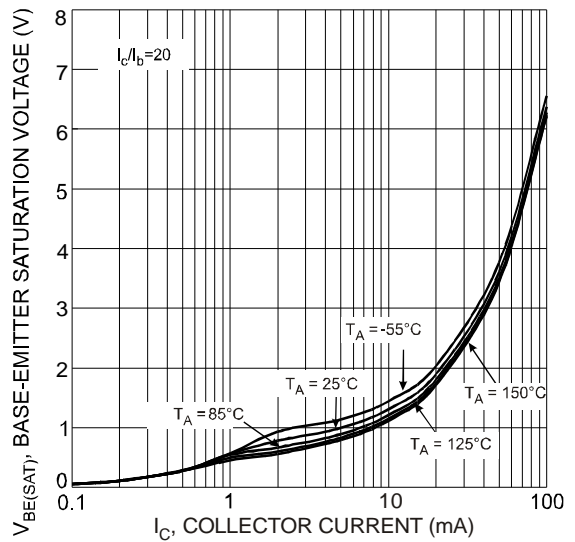

Fig. 9 Typical Base-Emitter Saturation Voltage vs. Collector Current

Characteristics Curves of NPN Transistor (Q2)

@T_A = 25°C unless otherwise specified

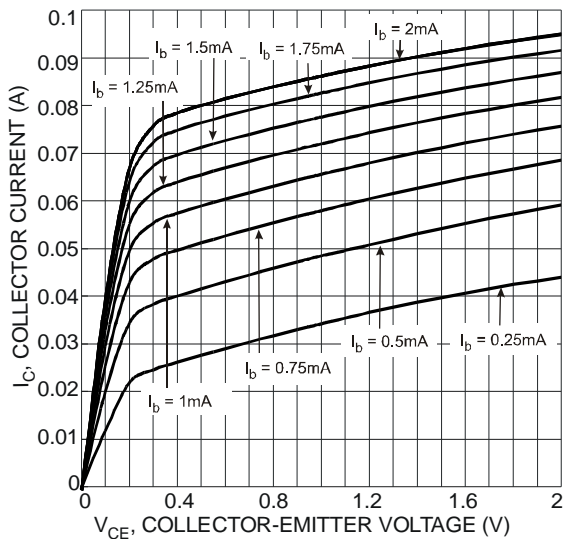

Fig. 10 Typical Collector Current vs. Collector-Emitter Voltage

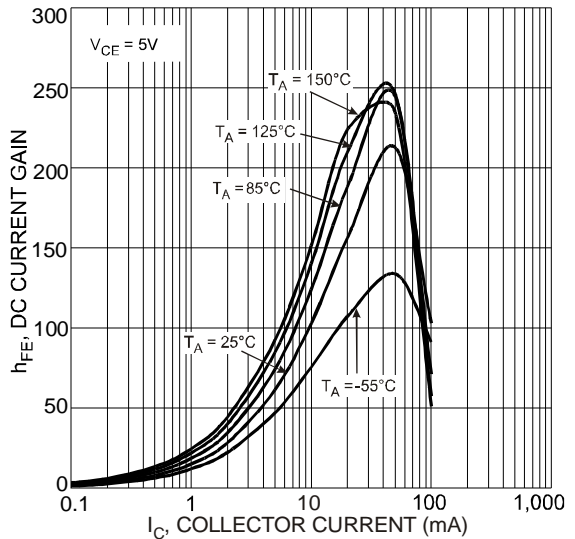

Fig. 11 Typical DC Current Gain vs. Collector Current

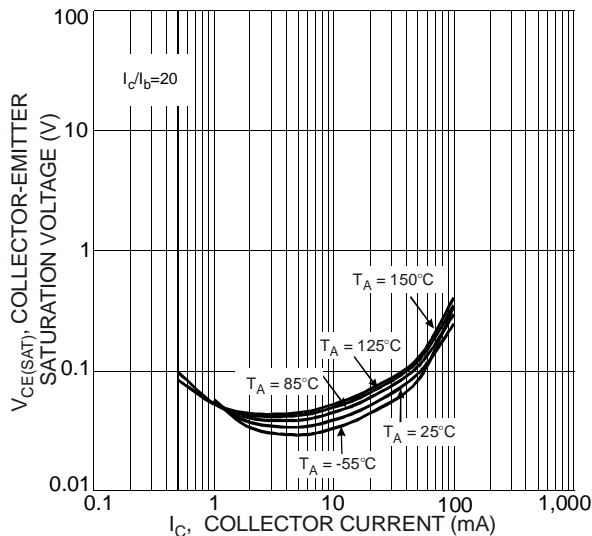

Fig. 12 Typical Collector-Emitter Saturation Voltage vs. Collector Current

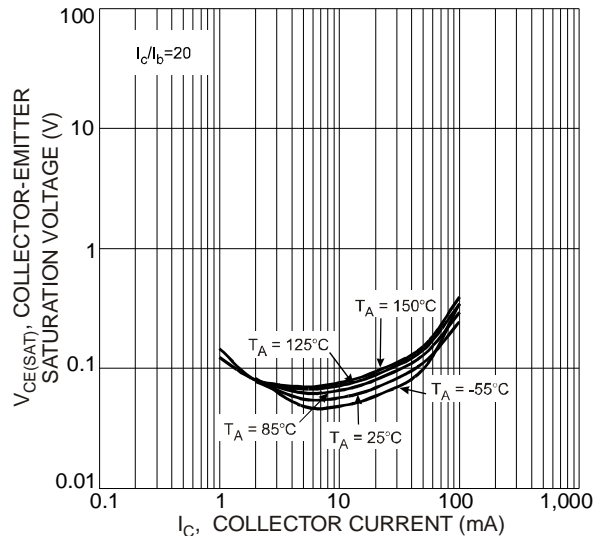

Fig. 13 Typical Collector-Emitter Saturation Voltage vs. Collector Current

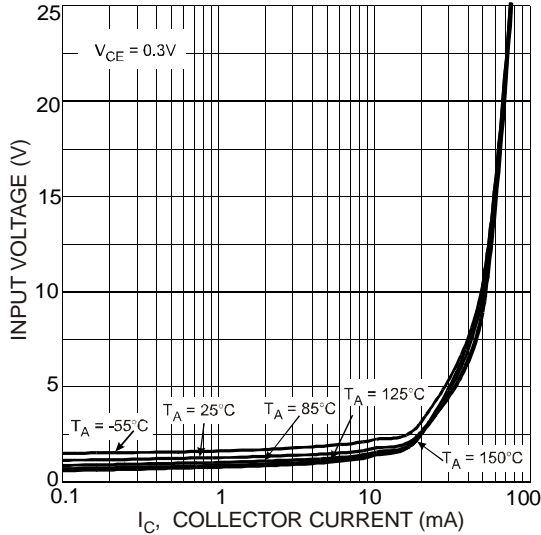

Fig. 14 Typical Input voltage vs. Output Current

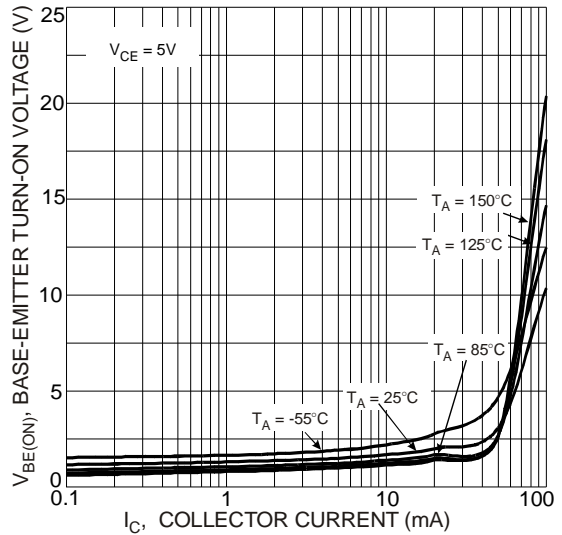

Fig. 15 Typical Base-Emitter Turn-On Voltage vs. Collector Current

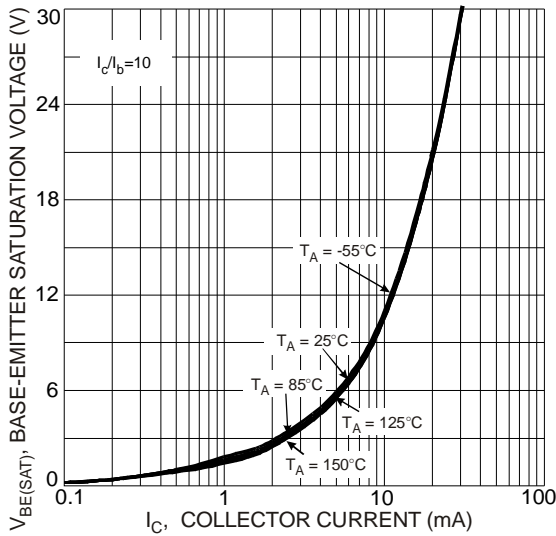

Fig. 16 Typical Base-Emitter Saturation Voltage vs. Collector Current

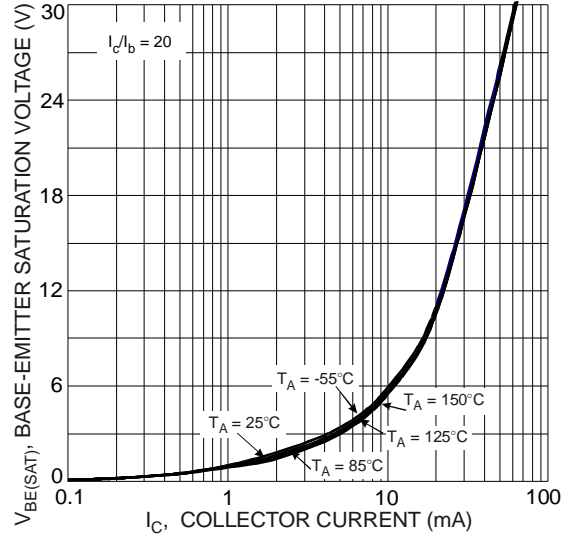

Fig. 17 Typical Base-Emitter Saturation Voltage vs. Collector Current

Ordering Information (Note 4)

Device	Packaging	Shipping
DCX100NS-7	SOT-563	3000/Tape & Reel

Notes: 4. For packaging details, please see page 6 or go to our website at <http://www.diodes.com/datasheets/ap02007.pdf>.

Marking Information

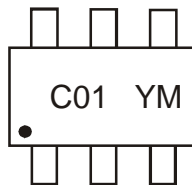

C01 = Product Type Marking Code
 YM = Date Code Marking
 Y = Year e.g., T = 2006
 M = Month e.g., 9 = September

Date Code Key

Year	2005	2006	2007	2008	2009	2010	2011	2012
Code	S	T	U	V	W	X	Y	Z

Month	Jan	Feb	Mar	Apr	May	Jun	Jul	Aug	Sep	Oct	Nov	Dec
Code	1	2	3	4	5	6	7	8	9	O	N	D

Package Outline Dimensions

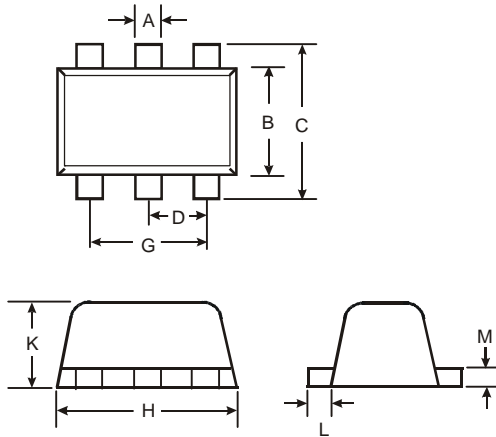

SOT-563			
Dim	Min	Max	Typ
A	0.15	0.30	0.20
B	1.10	1.25	1.20
C	1.55	1.70	1.60
D	-	-	0.50
G	0.90	1.10	1.00
H	1.50	1.70	1.60
K	0.55	0.60	0.60
L	0.10	0.30	0.20
M	0.10	0.18	0.11
All Dimensions in mm			

Suggested Pad Layout

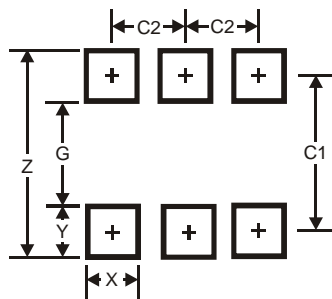

Dimensions	Value (in mm)
Z	2.2
G	1.2
X	0.375
Y	0.5
C1	1.7
C2	0.5

IMPORTANT NOTICE

DIODES INCORPORATED MAKES NO WARRANTY OF ANY KIND, EXPRESS OR IMPLIED, WITH REGARDS TO THIS DOCUMENT, INCLUDING, BUT NOT LIMITED TO, THE IMPLIED WARRANTIES OF MERCHANTABILITY AND FITNESS FOR A PARTICULAR PURPOSE (AND THEIR EQUIVALENTS UNDER THE LAWS OF ANY JURISDICTION).

Diodes Incorporated and its subsidiaries reserve the right to make modifications, enhancements, improvements, corrections or other changes without further notice to this document and any product described herein. Diodes Incorporated does not assume any liability arising out of the application or use of this document or any product described herein; neither does Diodes Incorporated convey any license under its patent or trademark rights, nor the rights of others. Any Customer or user of this document or products described herein in such applications shall assume all risks of such use and will agree to hold Diodes Incorporated and all the companies whose products are represented on Diodes Incorporated website, harmless against all damages.

Diodes Incorporated does not warrant or accept any liability whatsoever in respect of any products purchased through unauthorized sales channel. Should Customers purchase or use Diodes Incorporated products for any unintended or unauthorized application, Customers shall indemnify and hold Diodes Incorporated and its representatives harmless against all claims, damages, expenses, and attorney fees arising out of, directly or indirectly, any claim of personal injury or death associated with such unintended or unauthorized application.

Products described herein may be covered by one or more United States, international or foreign patents pending. Product names and markings noted herein may also be covered by one or more United States, international or foreign trademarks.

LIFE SUPPORT

Diodes Incorporated products are specifically not authorized for use as critical components in life support devices or systems without the express written approval of the Chief Executive Officer of Diodes Incorporated. As used herein:

A. Life support devices or systems are devices or systems which:

1. are intended to implant into the body, or
2. support or sustain life and whose failure to perform when properly used in accordance with instructions for use provided in the labeling can be reasonably expected to result in significant injury to the user.

B. A critical component is any component in a life support device or system whose failure to perform can be reasonably expected to cause the failure of the life support device or to affect its safety or effectiveness.

Customers represent that they have all necessary expertise in the safety and regulatory ramifications of their life support devices or systems, and acknowledge and agree that they are solely responsible for all legal, regulatory and safety-related requirements concerning their products and any use of Diodes Incorporated products in such safety-critical, life support devices or systems, notwithstanding any devices- or systems-related information or support that may be provided by Diodes Incorporated. Further, Customers must fully indemnify Diodes Incorporated and its representatives against any damages arising out of the use of Diodes Incorporated products in such safety-critical, life support devices or systems.

Copyright © 2009, Diodes Incorporated

www.diodes.com

Данный компонент на территории Российской Федерации

Вы можете приобрести в компании MosChip.

Для оперативного оформления запроса Вам необходимо перейти по данной ссылке:

<http://moschip.ru/get-element>

Вы можете разместить у нас заказ для любого Вашего проекта, будь то серийное производство или разработка единичного прибора.

В нашем ассортименте представлены ведущие мировые производители активных и пассивных электронных компонентов.

Нашей специализацией является поставка электронной компонентной базы двойного назначения, продукции таких производителей как XILINX, Intel (ex.ALTERA), Vicor, Microchip, Texas Instruments, Analog Devices, Mini-Circuits, Amphenol, Glenair.

Сотрудничество с глобальными дистрибьюторами электронных компонентов, предоставляет возможность заказывать и получать с международных складов практически любой перечень компонентов в оптимальные для Вас сроки.

На всех этапах разработки и производства наши партнеры могут получить квалифицированную поддержку опытных инженеров.

Система менеджмента качества компании отвечает требованиям в соответствии с ГОСТ Р ИСО 9001, ГОСТ РВ 0015-002 и ЭС РД 009

Офис по работе с юридическими лицами:

105318, г.Москва, ул.Щербаковская д.3, офис 1107, 1118, ДЦ «Щербаковский»

Телефон: +7 495 668-12-70 (многоканальный)

Факс: +7 495 668-12-70 (доб.304)

E-mail: info@moschip.ru

Skype отдела продаж:

moschip.ru

moschip.ru_4

moschip.ru_6

moschip.ru_9