

Cable Components

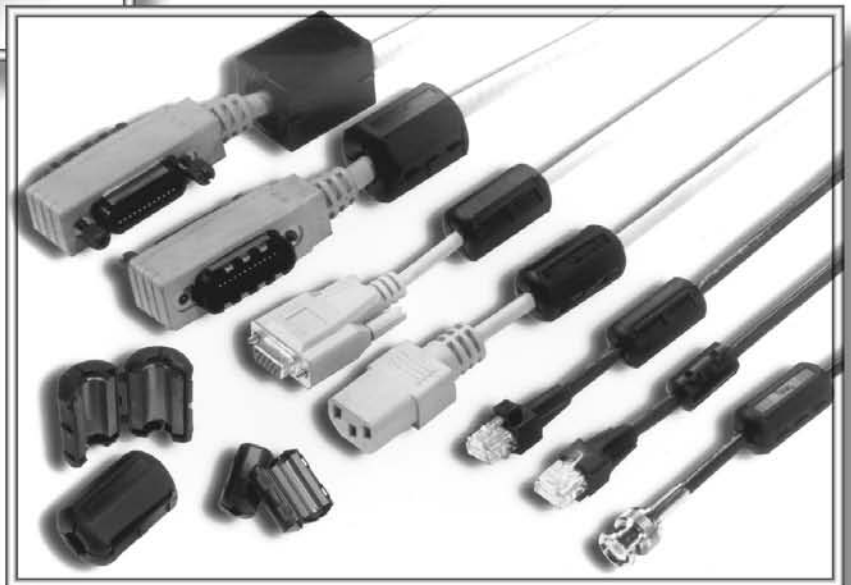

Fair-Rite Products Corp.

PO Box J, One Commercial Row, Wallkill, NY 12589-0288

Phone: (888) FAIR RITE / (845) 895-2055 • FAX: (888) FERRITE / (845) 895-2629
(888) 324-7748 (888) 337-7483

• www.fair-rite.com
• E-Mail: ferrites@fair-rite.com

Engineering Kits

Expanded Cable & Suppressor Kit

Part Number 0199000005

This is our most popular engineering kit. As the name implies, this kit contains a broad sampling of suppression cores to reduce conducted EMI over wires and cables.

Chip Bead Kit

Part Number 0199000018

The chip bead kit has a number of different EIA size chip components with a range of impedance values and signal speeds. Also one of our chip arrays is included in this kit. Parts are RoHS compliant.

Shield Bead Kit

Part Number 0199000019

The shield bead kit has 28 different beads in three suppression materials, 73, 43, and 61.

Antenna/RFID Kit

Part Number 0199000024

The kit contains a range of rods in three low losses, high Q, materials, 78, 61 and 67, to cover frequencies from 10 kHz to 50 MHz.

Surface Mount Bead Kit

Part Number 0199000025

An assortment of surface mount beads for differential and common-mode applications in 73 material for < 50 MHz, 43/44 material for 25-300 MHz and 52/61 material for 250-1000 MHz frequencies. Parts are RoHS compliant.

Wound Bead Kit

Part Number 0199000027

The wound bead kit has twelve wound beads in two suppression materials, 44 and 61, wound in several winding configurations. Parts are RoHS compliant.

Bead-On-Lead Kit

Part Number 0199000028

This bead-on-lead kit has three parts each in three materials, 73, 43 and 61, for through hole applications. Parts are RoHS compliant.

Engineering Kits

Rod Kit (52 Matl)

Part Number 0199000029

A new rod kit in the new 52 material. Samples of seven sizes intended for open circuit applications that require a ferrite material with high saturation and Curie temperature.

31 Snap-It Kit

Part Number 0199000030

This 31 material snap-it kit has a range parts for different cable diameters. Suggested operating frequency 1-300 MHz.

43 Snap-It Kit

Part Number 0199000031

Snap-it assemblies suitable for the 25-300 MHz frequency range. Can accommodate cable diameters from .250 to .590 inches.

46 Core and Snap-It Kit

Part Number 0199000032

This kit has a selection of cable cores and snap-its in our new economical 46 material. This material has similar performance as our 43/44 grade materials over the 25-300 MHz frequency range.

61 Snap-It Kit

Part Number 0199000033

Our recommendation for suppressing conducted EMI in 200-1000 MHz is the 61 material. This kit has a selection of 61 snap-its.

Chip Inductor Kit

Part Number 0199000035

The chip inductor kit has several EIA sizes in both ferrite and ceramic chip inductors. Parts are RoHS compliant.

Multi-Aperture Core Kit

Part Number 0199000036

Kit contains several sizes in four materials, 73, 43, 61 and 67. This allows experimentation from a few kHz into the 50-100 MHz range.

Round Cable EMI Suppression Cores

Listed by frequency range and in ascending order of "B" dimension.

Fair-Rite offers a broad selection of ferrite EMI suppression cable cores in several materials with guaranteed minimum impedance specifications.

. All cable cores have been burnished to remove the sharp edges.

. The column "H" (Oe) gives for each cable core the calculated dc bias field in oersted for 1 turn and 1 ampere direct current. The actual dc H field in the application, is this value of "H" times the actual NI (ampere-turns) product. For the effect of the dc bias on the impedance of the core material, see the material graphs on pages 145-146, Figures 18-23.

. Suppression cable cores are controlled for impedances only. The impedances listed are typical values. Minimum impedance values are specified for the + marked frequencies. The minimum guaranteed impedance is the listed impedance less 20%.

. Single turn impedance tests for 31, 43 and 46 material cores are performed on the 4193A Vector Impedance Meter. The 61 material parts are tested on the 4191A RF Impedance Analyzer. **Cores are tested with the shortest practical wire length.**

. Performance curves of all listed cable suppression cores are compiled on the Fair-Rite Products CD-ROM.

. For smaller suppression parts, refer to the section "EMI Suppression Beads" on pages 29-33.

. For any cable suppression core not listed here, feel free to contact our customer service group for availability and pricing.

. Our "Expanded Cable and Connector EMI Suppression Kit" (part number 0199000005) contains a selection of these suppression cores. See page 67.

. Explanation of Part Numbers: Digits 1&2 = product class, 3&4 material grade and last digit 2 = burnished.

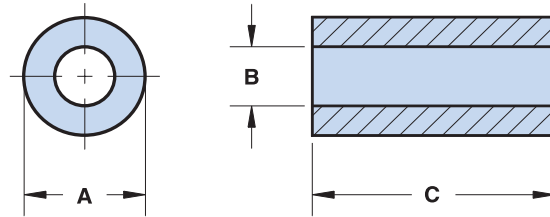

Lower & Broadband Frequencies 1-300 MHz (31 material)

Dimensions (Bold numbers are in millimeters, light numbers are nominal in inches.)

| Part Number | A | B | C* | Wt (g) | H (Oe) | Typical Impedance (Ω) | | | | | |
|-------------|----------------------|-------------------|--------------------|--------|--------|--------------------------------|-------|---------------------|---------------------|----------------------|---------|
| | | | | | | 1 MHz | 5 MHz | 10 MHz ⁺ | 25 MHz ⁺ | 100 MHz ⁺ | 250 MHz |
| 2631250202 | 6.35±0.15 .250 | 2.95±0.45 .125 | 25.4±0.75 1.000 | 2.9 | .52 | 27 | 70 | 90 | 138 | 230 | 240 |
| 2631023002 | 9.5±0.25 .375 | 4.75±0.3 .193 | 19.05±0.7 .750 | 4.7 | .52 | 19 | 49 | 62 | 95 | 160 | 185 |
| 2631480102 | 12.3±0.4 .485 | 4.95±0.25 .200 | 12.7±0.4 .500 | 6.0 | .52 | 18 | 45 | 58 | 88 | 140 | 167 |
| 2631480002 | 12.3±0.4 .485 | 4.95±0.25 .200 | 25.4±0.75 1.000 | 12 | .52 | 34 | 88 | 115 | 175 | 295 | 267 |
| 2631540202 | 14.3±0.45 .562 | 6.35±0.25 .250 | 13.8 - 0.7 .530 | 8.3 | .43 | 17 | 44 | 58 | 88 | 140 | 160 |
| 2631540002 | 14.3±0.45 .562 | 6.35±0.25 .250 | 28.6±0.75 1.125 | 17.7 | .43 | 35 | 91 | 119 | 181 | 300 | 280 |
| 2631625002 | 16.25 - 0.75 .625 | 7.9±0.25 .312 | 14.3±0.35 .562 | 10.3 | .36 | 16 | 40 | 53 | 75 | 130 | 150 |
| 2631625102 | 16.25 - 0.75 .625 | 7.9±0.25 .312 | 28.6±0.75 1.125 | 20.5 | .36 | 30 | 79 | 103 | 156 | 260 | 268 |
| 2631665802 | 17.45±0.4 .687 | 9.5±0.25 .375 | 12.7±0.5 .500 | 10.3 | .32 | 13 | 31 | 38 | 60 | 115 | 137 |
| 2631665702 | 17.45±0.4 .687 | 9.5±0.25 .375 | 28.6±0.75 1.125 | 23.1 | .32 | 27 | 69 | 89 | 138 | 225 | 265 |

* This dimension may be modified to suit specific applications.

⁺ Test frequency

Fair-Rite Products Corp.

PO Box J, One Commercial Row, Wallkill, NY 12589-0288

Phone: (888) FAIR RITE / (845) 895-2055 • FAX: (888) FERRITE / (845) 895-2629
(888) 324-7748 (888) 337-7483

• www.fair-rite.com
• E-Mail: ferrites@fair-rite.com

Round Cable EMI Suppression Cores

Listed by frequency range and in ascending order of "B" dimension.

Lower & Broadband Frequencies 1-300 MHz (31 material)

Dimensions (Bold numbers are in millimeters, light numbers are nominal in inches.)

| Part Number | A | B | C* | Wt (g) | H (Oe) | Typical Impedance (Ω) | | | | | |
|-------------|--------------------|---------------------|----------------------|--------|--------|--------------------------------|-------|---------------------|---------------------|----------------------|---------|
| | | | | | | 1 MHz | 5 MHz | 10 MHz ⁺ | 25 MHz ⁺ | 100 MHz ⁺ | 250 MHz |
| 2631626302 | 18.7±0.5 .735 | 10.15±0.25 .400 | 14.65 - 0.75 .562 | 13.3 | .29 | 14 | 35 | 44 | 69 | 115 | 140 |
| 2631626402 | 18.7±0.5 .735 | 10.15±0.25 .400 | 28.6±0.75 1.125 | 26.6 | .29 | 27 | 69 | 89 | 138 | 225 | 235 |
| 2631102002 | 25.9±0.75 1.020 | 12.8±0.25 .505 | 28.6±0.8 1.125 | 55 | .22 | 31 | 79 | 103 | 156 | 260 | 280 |
| 2631101902 | 28.5±0.6 1.122 | 13.8±0.3 .543 | 28.6±0.8 1.125 | 68 | .21 | 32 | 82 | 106 | 163 | 270 | 300 |
| 2631801202 | 29.0±0.75 1.142 | 19.0±0.5 .748 | 13.85±0.4 .545 | 25 | .17 | 10 | 24 | 31 | 49 | 88 | 130 |
| 2631103002 | 31.1±0.85 1.225 | 19.05±0.6 .750 | 50.8±1.0 2.000 | 116 | .17 | 37 | 98 | 120 | 205 | 340 | 315 |
| 2631626202 | 50.8±1.3 2.000 | 25.4±0.8 1.000 | 38.1±0.75 1.500 | 278 | .11 | 40 | 103 | 140 | 215 | 365 | 290 |
| 2631803802 | 61.0±1.3 2.400 | 35.55±0.85 1.400 | 12.7±0.5 .500 | 118 | .09 | 12 | 28 | 40 | 63 | 119 | 215 |

Broadband Frequencies 25-300 MHz (43 material)

| Part Number | A | B | C* | Wt (g) | H (Oe) | Typical Impedance (Ω) | | | |
|-------------|-------------------|-------------------|--------------------|--------|--------|--------------------------------|---------------------|----------------------|---------|
| | | | | | | 10 MHz | 25 MHz ⁺ | 100 MHz ⁺ | 250 MHz |
| 2643480102 | 12.3±0.4 .485 | 4.95±0.25 .200 | 12.7±0.4 .500 | 6.0 | .52 | 52 | 84 | 121 | 145 |
| 2643480002 | 12.3±0.4 .485 | 4.95±0.25 .200 | 25.4±0.75 1.000 | 12 | .52 | 102 | 165 | 236 | 233 |
| 2643540702 | 14.3±0.45 .562 | 6.35±0.25 .250 | 5.3 - 0.45 .200 | 3.1 | .43 | 20 | 30 | 50 | 68 |
| 2643540102 | 14.3±0.45 .562 | 6.35±0.25 .250 | 10.15±0.4 .400 | 6.3 | .43 | 39 | 61 | 89 | 104 |
| 2643540202 | 14.3±0.45 .562 | 6.35±0.25 .250 | 13.8 - 0.7 .530 | 8.3 | .43 | 51 | 78 | 118 | 140 |
| 2643540002 | 14.3±0.45 .562 | 6.35±0.25 .250 | 28.6±0.75 1.125 | 17.7 | .43 | 105 | 171 | 250 | 255 |
| 2643540302 | 14.3±0.45 .562 | 7.1±0.25 .280 | 15.25±0.4 .600 | 8.9 | .41 | 50 | 75 | 118 | 137 |
| 2643800302 | 12.7±0.25 .500 | 7.15±0.2 .282 | 4.9 - 0.25 .188 | 2.0 | .43 | 15 | 26 | 42 | 59 |
| 2643540402 | 14.3±0.45 .562 | 7.25±0.2 .286 | 28.6±0.75 1.125 | 16 | .40 | 88 | 143 | 215 | 230 |
| 2643801102 | 12.7±0.25 .500 | 7.9±0.2 .312 | 6.35±0.2 .250 | 2.4 | .40 | 16 | 26 | 41 | 59 |
| 2643801902 | 12.7±0.25 .500 | 7.9±0.2 .312 | 12.7±0.4 .500 | 4.7 | .40 | 29 | 44 | 73 | 91 |

* This dimension may be modified to suit specific applications.

⁺ Test frequency

Fair-Rite Products Corp.

PO Box J, One Commercial Row, Wallkill, NY 12589-0288

Phone: (888) FAIR RITE / (845) 895-2055 • FAX: (888) FERRITE / (845) 895-2629 • www.fair-rite.com
(888) 324-7748 (888) 337-7483 • E-Mail: ferrites@fair-rite.com

Round Cable EMI Suppression Cores

Listed by frequency range and in ascending order of "B" dimension.

Broadband Frequencies 25-300 MHz (43 material)

Dimensions (Bold numbers are in millimeters, light numbers are nominal in inches.)

| Part Number | A | B | C* | Wt (g) | H (Oe) | Typical Impedance (Ω) | | | |
|-------------|-----------------------------|---------------------------|-----------------------------|--------|--------|--------------------------------|---------------------|----------------------|---------|
| | | | | | | 10 MHz | 25 MHz ⁺ | 100 MHz ⁺ | 250 MHz |
| 2643625002 | 16.25 - 0.75 .625 | 7.9±0.25 .312 | 14.3±0.35 .562 | 10.3 | .36 | 45 | 70 | 113 | 135 |
| 2643625102 | 16.25 - 0.75 .625 | 7.9±0.25 .312 | 28.6±0.75 1.125 | 20.5 | .36 | 90 | 130 | 213 | 305 |
| 2643625202 | 15.9±0.4 .625 | 7.9±0.3 .312 | 50.8±1.0 2.000 | 36 | .36 | 158 | 235 | 384 | 373 |
| 2643665902 | 17.45±0.4 .687 | 9.5±0.25 .375 | 6.35±0.25 .250 | 5.1 | .32 | 19 | 26 | 44 | 62 |
| 2643665802 | 17.45±0.4 .687 | 9.5±0.25 .375 | 12.7±0.5 .500 | 10.3 | .32 | 35 | 55 | 88 | 108 |
| 2643665702 | 17.45±0.4 .687 | 9.5±0.25 .375 | 28.6±0.75 1.125 | 23.1 | .32 | 78 | 125 | 200 | 255 |
| 2643626302 | 18.7±0.5 .735 | 10.15±0.25 .400 | 14.65 - 0.75 .562 | 13.3 | .29 | 41 | 63 | 96 | 123 |
| 2643626402 | 18.7±0.5 .735 | 10.15±0.25 .400 | 28.6±0.75 1.125 | 26.6 | .29 | 79 | 128 | 196 | 220 |
| 2643626502 | 18.7±0.6 .735 | 10.15±0.4 .400 | 50.8±1.0 2.000 | 47 | .29 | 138 | 225 | 348 | 405 |
| 2643801502 | 25.4±0.65 1.000 | 12.7±0.35 .500 | 6.35±0.25 .250 | 11.6 | .23 | 22 | 34 | 53 | 87 |
| 2643102402 | 25.9±0.75 1.020 | 12.8±0.25 .505 | 21.3±0.5 .840 | 41 | .22 | 68 | 110 | 183 | 230 |
| 2643102002 | 25.9±0.75 1.020 | 12.8±0.25 .505 | 28.6±0.8 1.125 | 55 | .22 | 91 | 145 | 235 | 275 |
| 2643800602 | 20.95±0.4 .825 | 13.2±0.3 .520 | 6.35±0.2 .250 | 6.3 | .24 | 16 | 24 | 44 | 67 |
| 2643800502 | 20.95±0.4 .825 | 13.2±0.3 .520 | 11.9±0.4 .468 | 11.9 | .24 | 27 | 45 | 82 | 115 |
| 2643801802 | 22.1±0.4 .870 | 13.7±0.3 .540 | 6.35±0.2 .250 | 7.2 | .23 | 15 | 25 | 45 | 70 |
| 2643101902 | 28.5±0.6 1.122 | 13.8±0.3 .543 | 28.6±0.8 1.125 | 67 | .21 | 93 | 145 | 230 | 290 |
| 2643801402 | 25.4±0.6 1.000 | 15.5±0.5 .610 | 8.1±0.3 .320 | 12.4 | .20 | 20 | 35 | 55 | 95 |
| 2643806402 | 25.4±0.6 1.000 | 15.5±0.5 .610 | 12.7±0.4 .500 | 19.4 | .20 | 30 | 53 | 90 | 130 |
| 2643251002 | 39.1±0.75 1.540 | 16.75±0.5 .660 | 22.2±0.8 .875 | 104 | .16 | 85 | 135 | 230 | 325 |
| 2643801002 | 29.0±0.75 1.142 | 19.0±0.5 .748 | 7.5±0.25 .295 | 13.6 | .17 | 17 | 28 | 47 | 80 |
| 2643801202 | 29.0±0.75 1.142 | 19.0±0.5 .748 | 13.85±0.4 .545 | 25.1 | .17 | 28 | 51 | 92 | 142 |
| 2643103102 | 29.0±0.75 1.142 | 19.0±0.5 .748 | 38.1±0.75 1.500 | 69 | .17 | 87 | 130 | 200 | 250 |

* This dimension may be modified to suit specific applications.

⁺ Test frequency

Fair-Rite Products Corp.

PO Box J, One Commercial Row, Wallkill, NY 12589-0288

Phone: (888) FAIR RITE / (845) 895-2055 • FAX: (888) FERRITE / (845) 895-2629 • www.fair-rite.com
(888) 324-7748 (888) 337-7483 • E-Mail: ferrites@fair-rite.com

Round Cable EMI Suppression Cores

Listed by frequency range and in ascending order of "B" dimension.

Broadband Frequencies 25-300 MHz (43 material)

Dimensions (Bold numbers are in millimeters, light numbers are nominal in inches.)

| Part Number | A | B | C* | Wt (g) | H (Oe) | Typical Impedance (Ω) | | | |
|-------------|----------------------------|----------------------------|----------------------------|--------|--------|--------------------------------|---------------------|----------------------|---------|
| | | | | | | 10 MHz | 25 MHz ⁺ | 100 MHz ⁺ | 250 MHz |
| 2643804502 | 31.1±0.75 1.225 | 19.05±0.5 .750 | 16.3 - 0.75 .627 | 36 | .17 | 37 | 60 | 100 | 153 |
| 2643103002 | 31.1±0.85 1.225 | 19.05±0.6 .750 | 50.8 ± 1.0 2.000 | 116 | .17 | 105 | 195 | 330 | 310 |
| 2643802702 | 35.55±0.75 1.400 | 22.85±0.5 .900 | 12.7±0.5 .500 | 36 | .14 | 28 | 48 | 80 | 135 |
| 2643626102 | 50.8±1.0 2.000 | 25.4±0.5 1.000 | 25.4±0.75 1.000 | 190 | .11 | 80 | 128 | 224 | 310 |
| 2643625902 | 50.8±1.0 2.000 | 25.4±0.5 1.000 | 28.7±0.75 1.130 | 215 | .11 | 90 | 145 | 254 | 373 |
| 2643626202 | 50.8±1.3 2.000 | 25.4±0.8 1.000 | 38.1±0.75 1.500 | 285 | .11 | 118 | 193 | 336 | 280 |
| 2643626002 | 50.8±1.3 2.000 | 25.4±0.8 1.000 | 50.8±1.0 2.000 | 380 | .11 | 157 | 240 | 360 | 257 |
| 2643803802 | 61.0±1.3 2.400 | 35.55±0.85 1.400 | 12.7±0.5 .500 | 118 | .09 | 33 | 58 | 108 | 218 |

Broadband Frequencies 25-300 MHz (Economical 46 material)

| Part Number | A | B | C* | Wt (g) | H (Oe) | Typical Impedance (Ω) | | | |
|-------------|-----------------------------|--------------------------|---------------------------|--------|--------|--------------------------------|--------|----------------------|---------|
| | | | | | | 10 MHz | 25 MHz | 100 MHz ⁺ | 250 MHz |
| 2646480102 | 12.3±0.4 .485 | 4.95±0.25 .200 | 12.7±0.4 .500 | 6.0 | .52 | 42 | 62 | 110 | 145 |
| 2646480002 | 12.3±0.4 .485 | 4.95±0.25 .200 | 25.4±0.75 1.000 | 12 | .52 | 83 | 125 | 212 | 233 |
| 2646540202 | 14.3±0.45 .562 | 6.35±0.25 .250 | 13.8 - 0.7 .530 | 8.3 | .43 | 45 | 66 | 106 | 127 |
| 2646540002 | 14.3±0.45 .562 | 6.35±0.25 .250 | 28.6±0.75 1.125 | 17.7 | .43 | 89 | 134 | 225 | 253 |
| 2646625002 | 16.25 - 0.75 .625 | 7.9±0.25 .312 | 14.3±0.35 .562 | 10.3 | .36 | 44 | 63 | 102 | 135 |
| 2646625102 | 16.25 - 0.75 .625 | 7.9±0.25 .312 | 28.6±0.75 1.125 | 20.5 | .36 | 78 | 115 | 192 | 235 |
| 2646625202 | 15.9±0.4 .625 | 7.9±0.3 .312 | 50.8±1.0 2.000 | 36 | .36 | 138 | 204 | 345 | 270 |
| 2646665802 | 17.45±0.4 .687 | 9.5±0.25 .375 | 12.7±0.5 .500 | 10.3 | .32 | 32 | 49 | 79 | 110 |
| 2646665702 | 17.45±0.4 .687 | 9.5±0.25 .375 | 28.6±0.75 1.125 | 23.1 | .32 | 72 | 106 | 180 | 225 |
| 2646102402 | 25.9±0.75 1.020 | 12.8±0.25 .505 | 21.3±0.5 .840 | 41 | .22 | 67 | 100 | 165 | 218 |
| 2646102002 | 25.9±0.75 1.020 | 12.8±0.25 .505 | 28.6±0.8 1.125 | 55 | .22 | 74 | 118 | 212 | 268 |
| 2646101902 | 28.5±0.6 1.122 | 13.8±0.3 .543 | 28.6±0.8 1.125 | 67 | .21 | 80 | 121 | 207 | 285 |

* This dimension may be modified to suit specific applications.

⁺ Test frequency

Fair-Rite Products Corp.

PO Box J, One Commercial Row, Wallkill, NY 12589-0288

Phone: (888) FAIR RITE / (845) 895-2055 • FAX: (888) FERRITE / (845) 895-2629 • www.fair-rite.com
(888) 324-7748 (888) 337-7483 • E-Mail: ferrites@fair-rite.com

Round Cable EMI Suppression Cores

Listed by frequency range and in ascending order of "B" dimension.

Broadband Frequencies 25-300 MHz (Economical 46 material)

Dimensions (Bold numbers are in millimeters, light numbers are nominal in inches.)

| Part Number | A | B | C* | Wt (g) | H (Oe) | Typical Impedance (Ω) | | | |
|-------------|---------------------------|----------------------------|----------------------------|--------|--------|--------------------------------|--------|----------------------|---------|
| | | | | | | 10 MHz | 25 MHz | 100 MHz ⁺ | 250 MHz |
| 2646804502 | 31.1±0.75 1.225 | 19.05±0.5 .750 | 16.3 - 0.75 .627 | 36 | .17 | 33 | 49 | 90 | 150 |
| 2646103002 | 31.1±0.85 1.225 | 19.05±0.6 .750 | 50.8 ± 1.0 2.000 | 116 | .17 | 95 | 155 | 297 | 310 |
| 2646626202 | 50.8±1.3 2.000 | 25.4±0.8 1.000 | 38.1±0.75 1.500 | 285 | .11 | 102 | 165 | 302 | 280 |
| 2646803802 | 61.0±1.3 2.400 | 35.55±0.85 1.400 | 12.7±0.5 .500 | 118 | .09 | 30 | 44 | 100 | 200 |

Higher Frequencies 200-1000 MHz (61 material)

| Part Number | A | B | C* | Wt (g) | H (Oe) | Typical Impedance(Ω) | | | |
|-------------|----------------------------|---------------------------|-----------------------------|--------|--------|-------------------------------|----------------------|----------------------|----------|
| | | | | | | 100 MHz | 250 MHz ⁺ | 500 MHz ⁺ | 1000 MHz |
| 2661480002 | 12.3±0.4 .485 | 4.95±0.25 .200 | 25.4±0.75 1.000 | 12 | .52 | ??? | ??? | ??? | ??? |
| 2661540202 | 14.3±0.45 .562 | 6.35±0.25 .250 | 13.8 - 0.7 .530 | 8.3 | .43 | 100 | 145 | 185 | 260 |
| 2661540002 | 14.3±0.45 .562 | 6.35±0.25 .250 | 28.6±0.75 1.125 | 17.7 | .43 | 205 | 295 | 370 | 350 |
| 2661801902 | 12.7±0.25 .500 | 7.9±0.25 .312 | 12.7± 0.4 .500 | 4.7 | .40 | 45 | 70 | 105 | 175 |
| 2661665802 | 17.45±0.4 .687 | 9.5±0.25 .375 | 12.7±0.5 .500 | 10.3 | .32 | 85 | 125 | 160 | 205 |
| 2661665702 | 17.45±0.4 .687 | 9.5±0.25 .375 | 28.6±0.75 1.125 | 23.1 | .32 | 190 | 280 | 360 | 450 |
| 2661626302 | 19.0 - 0.65 .735 | 10.15±0.25 .400 | 14.65 - 0.75 .562 | 13.3 | .29 | 90 | 135 | 180 | 235 |
| 2661626402 | 19.0 - 0.65 .735 | 10.15±0.25 .400 | 28.6±0.75 1.125 | 26.6 | .29 | 185 | 250 | 370 | 460 |
| 2661102402 | 25.9±0.75 1.020 | 12.8±0.25 .505 | 21.3±0.5 .840 | 41 | .22 | 125 | 200 | 310 | 550 |
| 2661102002 | 25.9±0.75 1.020 | 12.8±0.25 .505 | 28.6±0.8 1.125 | 55 | .22 | 190 | 300 | 380 | 400 |

* This dimension may be modified to suit specific applications.

⁺ Test frequency

Fair-Rite Products Corp.

PO Box J, One Commercial Row, Wallkill, NY 12589-0288

Phone: (888) FAIR RITE / (845) 895-2055 • FAX: (888) FERRITE / (845) 895-2629
(888) 324-7748

• www.fair-rite.com
• E-Mail: ferrites@fair-rite.com

Round Cable Snap-its

Listed by frequency range and in ascending order of cable diameter.

Round cable snap-its can easily accommodate round cables or bundled wires with diameters from 2.5 mm (.100") to 25.4 mm (1.000"). These assemblies are available in four ferrite material grades to suppress differential or common-mode conducted EMI from 1 MHz into the GHz region.

The polypropylene cases are meeting the RoHS restrictions of hazardous substances and have a flammability rating of UL 94-V0.

- Round cable snap-it assemblies are controlled for impedances only. The impedances listed are typical values. Minimum impedance values are specified for the + marked frequencies. The minimum guaranteed impedance is the listed impedance less 20%.
- Single turn impedance tests for the 31, 43 and 44 material are performed on the 4193A Vector Impedance Analyzer. The 61 material parts are tested on the 4191A RF Impedance Analyzer. **Cores are tested with the shortest practical wire length.**
- Performance curves of all listed round cable snap-its are compiled on the Fair-Rite Products CD-ROM.
- Many of the snap-it parts have round core equivalents. See section Round Cable EMI Suppression Cores on pages 70-74.
- Round Cable Snap-it Kits are available for each of the four suppression materials. 31 Snap-It Kit (0199000030), 43 Snap-It Kit (0199000031), 46 Core and Snap-It Kit (0199000032) and 61 Snap-It Kit (0199000033). For additional details see page 68.
- Explanation of Part Numbers: Digits 1&2 = product class and 3&4 material grade.

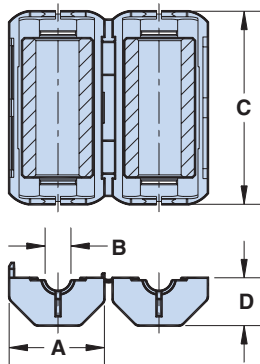

Figure 1

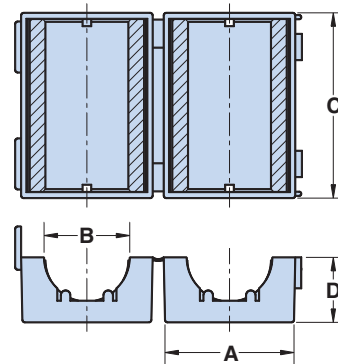

Figure 2

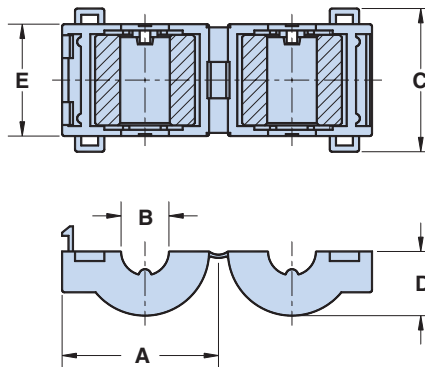

Figure 3

Fair-Rite Products Corp.

PO Box J, One Commercial Row, Wallkill, NY 12589-0288

Phone: (888) FAIR RITE / (845) 895-2055 • FAX: (888) FERRITE / (845) 895-2629
(888) 324-7748 (888) 337-7483

• www.fair-rite.com
• E-Mail: ferrites@fair-rite.com

Round Cable Snap-its

Listed by frequency range and in ascending order of cable diameter.

Lower & Broadband Frequencies 1-300 MHz (31 material)

Dimensions (Bold numbers are in millimeters, light numbers are nominal in inches.)

| Part Number | Fig. | Max. Cable Diameter | A | B** | C | D | Wt. (g) | Typical Impedance(Ω) | | | | | | Solid Equivalent* |
|-------------|------|---------------------|---------------|---------------|----------------|----------------|---------|-------------------------------|-------|---------------------|---------------------|----------------------|---------|-------------------|
| | | | | | | | | 1 MHz | 5 MHz | 10 MHz ⁺ | 25 MHz ⁺ | 100 MHz ⁺ | 250 MHz | |
| 0431178181 | 1 | 4.1 .161 | 11.8 .465 | 4.3 .169 | 23.2 .913 | 5.6 .221 | 4.2 | 12 | 43 | 60 | 90 | 160 | 183 | |
| 0431173951 | 1 | 4.9 .193 | 12.8 .504 | 5.1 .201 | 25.0 .984 | 5.6 .220 | 6.5 | 14 | 44 | 60 | 100 | 180 | 208 | 2631023002 |
| 0431164951 | 1 | 4.9 .193 | 17.3 .680 | 5.1 .201 | 36.2 1.420 | 8.4 .331 | 17 | 25 | 75 | 100 | 169 | 280 | 247 | 2631480002 |
| 0431164281 | 1 | 6.3 .250 | 20.0 .788 | 6.6 .260 | 39.4 1.550 | 9.8 .385 | 26 | 28 | 83 | 105 | 180 | 310 | 240 | 2631540002 |
| 0431178281 | 1 | 8.7 .343 | 21.5 .846 | 9.0 .354 | 39.4 1.550 | 10.55 .415 | 23 | 18 | 63 | 85 | 130 | 250 | 275 | 2631665702 |
| 0431167281 | 1 | 9.85 .388 | 23.7 .933 | 10.15 .400 | 39.4 1.550 | 11.7 .461 | 33 | 18 | 56 | 81 | 144 | 240 | 270 | 2631626402 |
| 0431164181 | 1 | 12.7 .500 | 31.0 1.220 | 13.05 .514 | 39.4 1.550 | 15.25 .600 | 61 | 25 | 71 | 100 | 156 | 260 | 260 | 2631102002 |
| 0431176451 | 1 | 18.0 .709 | 38.6 1.520 | 18.35 .722 | 47.5 1.870 | 19.15 .755 | 161 | 47 | 95 | 130 | 225 | 380 | 370 | 2631103002 |
| 0431173551 | 2 | 18.5 .728 | 29.2 1.150 | 18.8 .740 | 42.0 1.65 | 14.7 .579 | 78 | 16 | 48 | 69 | 125 | 220 | 310 | 2631103102 |
| 0431177081 | 1 | 25.4 1.000 | 56.4 2.220 | 25.9 1.020 | 42.95 1.690 | 27.45 1.080 | 308 | 45 | 90 | 125 | 218 | 375 | 340 | 2631626202 |

Broadband Frequencies 25-300 MHz (43 & 44 materials)

| Part Number | Fig. | Max. Cable Diameter | A | B** | C | D | E | Wt. (g) | Typical Impedance(Ω) | | | | Solid Equivalent* |
|-------------|------|---------------------|---------------|-------------|---------------|---------------|--------------|---------|-------------------------------|---------------------|----------------------|---------|-------------------|
| | | | | | | | | | 10 MHz | 25 MHz ⁺ | 100 MHz ⁺ | 250 MHz | |
| 0443178181 | 1 | 4.1 .161 | 11.8 .465 | 4.3 .169 | 23.2 .913 | 5.6 .221 | | 4.2 | 40 | 70 | 125 | 152 | |
| 0444173951 | 1 | 4.9 .193 | 12.8 .504 | 5.1 .201 | 25.0 .984 | 5.6 .220 | | 6.5 | 54 | 94 | 150 | 187 | 2643023002 |
| 0444164951 | 1 | 4.9 .193 | 17.3 .680 | 5.1 .201 | 38.2 1.420 | 8.4 .331 | | 17 | 90 | 144 | 245 | 257 | 2643480002 |
| 0443164251 | 2 | 6.3 .250 | 17.9 .705 | 6.6 .260 | 32.2 1.270 | 9.2 .362 | | 31 | 100 | 163 | 275 | 275 | 2643540002 |
| 0444164281 | 1 | 6.3 .250 | 20.0 .788 | 6.6 .260 | 39.4 1.550 | 9.8 .385 | | 26 | 95 | 156 | 260 | 270 | 2643540002 |
| 0443625006 | 3 | 7.6 .299 | 24.7 .972 | 7.9 .311 | 22.8 .898 | 10.2 .402 | 17.8 .701 | 13 | 27 | 50 | 113 | 188 | 2643625002 |
| 0443178281 | 1 | 8.7 .343 | 21.5 .846 | 9.0 .354 | 39.4 1.550 | 10.55 .415 | | 24 | 65 | 120 | 230 | 265 | 2643665702 |
| 0443665806 | 3 | 9.2 .362 | 26.3 1.035 | 9.5 .374 | 21.4 .843 | 11.0 .433 | 16.4 .646 | 13 | 23 | 41 | 88 | 122 | 2643665802 |

* For solid cable cores see pages 32 and 70-74

⁺ Test frequency

** "B" dimension is the core dimension.

Fair-Rite Products Corp.

Phone: (888) FAIR RITE / (845) 895-2055 • FAX: (888) FERRITE / (845) 895-2629
(888) 324-7748 (888) 337-7483

PO Box J, One Commercial Row, Wallkill, NY 12589-0288

• www.fair-rite.com
• E-Mail: ferrites@fair-rite.com

Round Cable Snap-its

Listed by frequency range and in ascending order of cable diameter.

Broadband Frequencies 25-300 MHz (43 & 44 materials)

Dimensions (Bold numbers are in millimeters, light numbers are nominal in inches.)

| Part Number | Fig. | Max. Cable Diameter | A | B** | C | D | E | Wt. (g) | Typical Impedance(Ω) | | | | Solid Equivalent* |
|-------------|------|----------------------|----------------------|----------------------|-----------------------|-----------------------|---------------------|---------|-------------------------------|---------------------|----------------------|---------|-------------------|
| | | | | | | | | | 10 MHz | 25 MHz ⁺ | 100 MHz ⁺ | 250 MHz | |
| 0443167251 | 2 | 9.85 .388 | 22.1 .870 | 10.15 .400 | 32.3 1.272 | 11.0 .433 | | 42 | 79 | 138 | 225 | 285 | 2643626402 |
| 0444167281 | 1 | 9.85 .388 | 23.7 .933 | 10.15 .400 | 39.4 1.550 | 11.7 .460 | | 33 | 77 | 125 | 210 | 260 | 2643626402 |
| 0443164151 | 2 | 12.7 .500 | 29.0 1.142 | 13.05 .514 | 32.5 1.280 | 14.8 .583 | | 84 | 90 | 156 | 250 | 305 | 2643102002 |
| 0444164181 | 1 | 12.7 .500 | 31.0 1.220 | 13.05 .514 | 39.4 1.550 | 15.25 .600 | | 61 | 76 | 138 | 230 | 280 | 2643102002 |
| 0443800506 | 3 | 12.8 .504 | 29.7 1.169 | 13.2 .520 | 20.6 .811 | 12.7 .500 | 15.6 .614 | 16 | 18 | 35 | 75 | 120 | 2643800502 |
| 0443806406 | 3 | 15.0 .591 | 34.3 1.360 | 15.5 .610 | 21.2 .835 | 15.0 .591 | 16.2 .638 | 23 | 24 | 43 | 90 | 147 | 2643806402 |
| 0444176451 | 1 | 18.0 .709 | 38.6 1.520 | 18.35 .722 | 47.5 1.870 | 19.15 .755 | | 161 | 100 | 175 | 365 | 365 | 2643103002 |
| 0444173551 | 2 | 18.5 .728 | 29.2 1.150 | 18.8 .740 | 42.0 1.650 | 14.7 .579 | | 78 | 50 | 95 | 195 | 322 | 2643103102 |
| 0444177081 | 1 | 25.4 1.000 | 56.4 2.220 | 25.9 1.020 | 42.95 1.690 | 27.45 1.080 | | 308 | 115 | 194 | 335 | 330 | 2643626202 |

Broadband Frequencies 25-300 MHz (Economical 46 material)

| Part Number | Fig. | Max. Cable Diameter | A | B** | C | D | E | Wt. (g) | Typical Impedance(Ω) | | | | Solid Equivalent* |
|-------------|------|----------------------|----------------------|----------------------|-----------------------|-----------------------|---|---------|-------------------------------|--------|----------------------|---------|-------------------|
| | | | | | | | | | 10 MHz | 25 MHz | 100 MHz ⁺ | 250 MHz | |
| 0446173951 | 1 | 4.9 .193 | 12.8 .504 | 5.1 .201 | 25.0 .984 | 5.6 .220 | | 6.5 | 46 | 82 | 135 | 185 | |
| 0446164951 | 1 | 4.9 .193 | 17.3 .680 | 5.1 .201 | 38.2 1.420 | 8.4 .331 | | 17 | 72 | 120 | 220 | 250 | 2646480002 |
| 0446164281 | 1 | 6.3 .250 | 20.0 .788 | 6.6 .260 | 39.4 1.550 | 9.8 .385 | | 26 | 81 | 131 | 235 | 265 | 2646540002 |
| 0446164251 | 2 | 6.3 .250 | 17.9 .705 | 6.6 .260 | 32.2 1.270 | 9.2 .362 | | 31 | 81 | 134 | 245 | 273 | 2646540002 |
| 0446167281 | 1 | 9.85 .388 | 23.7 .933 | 10.15 .400 | 39.4 1.550 | 11.7 .460 | | 33 | 66 | 105 | 190 | 275 | |
| 0446167251 | 2 | 9.85 .388 | 22.1 .870 | 10.15 .400 | 32.3 1.272 | 11.0 .433 | | 42 | 72 | 116 | 202 | 247 | |
| 0446164181 | 1 | 12.7 .500 | 31.0 1.220 | 13.05 .514 | 39.4 1.550 | 15.25 .600 | | 61 | 73 | 115 | 205 | 275 | 2646102002 |
| 0446164151 | 2 | 12.7 .500 | 29.0 1.142 | 13.05 .514 | 32.5 1.280 | 14.8 .583 | | 84 | 84 | 127 | 225 | 270 | 2646102002 |
| 0446176451 | 1 | 18.0 .709 | 38.6 1.520 | 18.35 .722 | 47.5 1.870 | 19.15 .755 | | 161 | 85 | 137 | 330 | 360 | 2646103002 |
| 0446173551 | 2 | 18.5 .728 | 29.2 1.150 | 18.8 .740 | 42.0 1.650 | 14.7 .579 | | 78 | 48 | 85 | 176 | 300 | |
| 0446177081 | 1 | 25.4 1.000 | 56.4 2.220 | 25.9 1.020 | 42.95 1.690 | 27.45 1.080 | | 308 | 97 | 169 | 330 | 330 | 2646626202 |

* For solid cable cores see pages 70-74

⁺ Test frequency

** "B" dimension is the core dimension.

Fair-Rite Products Corp.

PO Box J, One Commercial Row, Wallkill, NY 12589-0288

Phone: (888) FAIR RITE / (845) 895-2055 • FAX: (888) FERRITE / (845) 895-2629 • www.fair-rite.com
(888) 324-7748 (888) 337-7483 • E-Mail: ferrites@fair-rite.com

Round Cable Snap-its

Listed by frequency range and in ascending order of cable diameter.

Higher Frequencies 200-1000 MHz (61 material)

Dimensions (Bold numbers are in millimeters, light numbers are nominal in inches.)

| Part Number | Fig. | Max. Cable Diameter | A | B** | C | D | Wt. (g) | Typical Impedance(Ω) | | | | Solid Equivalent* |
|-------------|------|---------------------|---------------|---------------|---------------|---------------|---------|-------------------------------|----------------------|----------------------|----------|-------------------|
| | | | | | | | | 100 MHz | 250 MHz ⁺ | 500 MHz ⁺ | 1000 MHz | |
| 0461178181 | 1 | 4.1 .161 | 11.8 .465 | 4.3 .169 | 23.2 .913 | 5.6 .221 | 42 | 115 | 165 | 215 | 300 | |
| 0461164951 | 1 | 4.9 .193 | 17.3 .620 | 5.1 .201 | 38.2 1.420 | 8.4 .331 | 17 | 215 | 325 | 385 | 332 | |
| 0461164281 | 1 | 6.3 .250 | 20.0 .788 | 6.6 .260 | 39.4 1.550 | 9.8 .385 | 26 | 230 | 355 | 425 | 420 | 2661540002 |
| 0461178281 | 1 | 8.7 .343 | 21.5 .846 | 9.0 .354 | 39.4 1.550 | 10.55 .415 | 24 | 180 | 285 | 380 | 430 | 2661665702 |
| 0461167281 | 1 | 9.85 .388 | 23.7 .933 | 10.15 .400 | 39.4 1.550 | 11.7 .460 | 33 | 175 | 275 | 375 | 400 | 2661626402 |
| 0461164181 | 1 | 12.7 .500 | 31.0 1.220 | 13.05 .514 | 39.4 1.550 | 15.25 .600 | 61 | 205 | 320 | 435 | 257 | 2661102002 |
| 0461176451 | 1 | 18.0 .709 | 38.6 1.520 | 18.35 .722 | 47.5 1.870 | 19.15 .755 | 161 | 360 | 480 | 350 | 110 | |

* For solid cable cores see pages 70-74

⁺ Test frequency

** "B" dimension is the core dimension.

Fair-Rite Products Corp.

PO Box J, One Commercial Row, Wallkill, NY 12589-0288

Phone: (888) FAIR RITE / (845) 895-2055 • FAX: (888) FERRITE / (845) 895-2629
(888) 324-7748 (888) 337-7483

• www.fair-rite.com
• E-Mail: ferrites@fair-rite.com

Split Round Cable EMI Suppression Cores

Listed by frequency and in ascending order of cable diameter.

Split round cable suppression cores can be used on cables and wire harnesses with diameters ranging from 2.5 mm (.100") to 25.4 mm (1.000"). These cores are available in three ferrite material grades to attenuate conducted differential and common-mode EMI from 1 MHz into the GHz region.

- Split round cable suppression cores are controlled for impedances only. The impedances listed are typical values. Minimum impedance values are specified for the + marked frequencies. The minimum guaranteed impedance is the listed impedance less 20%.
- Single turn impedance tests for the 31, 43, 44 and 46 material are performed on the 4193A Vector Impedance Analyzer. The 61 material parts are tested on the 4191A RF Impedance Analyzer. **Cores are tested with the shortest practical wire length.**
- Over-molding, heat shrink tubing or any other suitable mechanical arrangement can be utilized to clamp split cable cores together. Many of these split round cable cores can be supplied as Round Snap-It assemblies. The first two digits change from 26 to 04. See pages 75 - 78 for the listing of Round Cable Snap-Its.
- Many of the split round cable suppression cores have round cable core equivalents. See section Round Cable EMI Suppression Cores on pages 70-74.
- Performance curves of all listed split round cable suppression cores are compiled on the Fair-Rite CD-ROM.
- The "Expanded Cable and Suppressor Kit" (part number 0199000005) contains a selection of these split round cable suppression cores. For details see page 67.
- Explanation of Part Numbers: Digits 1&2 = product class and 3&4 material grade.

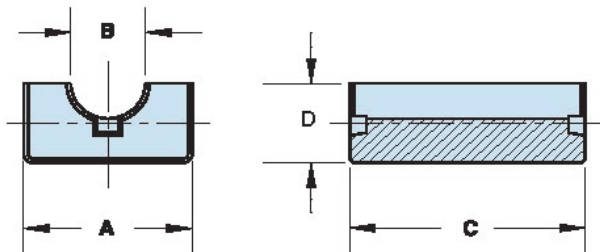

Figure 1

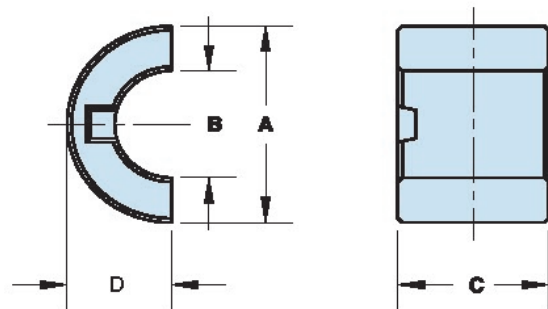

Figure 2

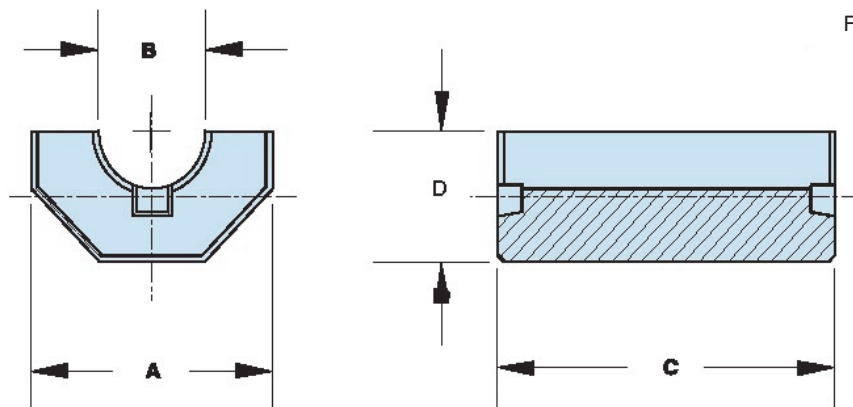

Figure 3

Fair-Rite Products Corp. PO Box J, One Commercial Row, Wallkill, NY 12589-0288

Phone: (888) FAIR RITE / (845) 895-2055 • FAX: (888) FERRITE / (845) 895-2629
(888) 324-7748 (888) 337-7483

• www.fair-rite.com
• E-Mail: ferrites@fair-rite.com

Split Round Cable EMI Suppression Cores

Listed by frequency and in ascending order of cable diameter.

Lower & Broadband Frequencies 1-300 MHz (31 material)

Dimensions (Bold numbers are in millimeters, light numbers are nominal in inches.)

| Part Number | Fig. | Max. Cable Diameter | A | B** | C | D | Wt. (g) | Typical Impedance(Ω) | | | | | | Solid Equivalent* |
|-------------|------|----------------------|-----------------------------|-----------------------------|------------------------------|-----------------------------|---------|-------------------------------|-------|---------------------|---------------------|----------------------|---------|-------------------|
| | | | | | | | | 1 MHz | 5 MHz | 10 MHz ⁺ | 25 MHz ⁺ | 100 MHz ⁺ | 250 MHz | |
| 2631178181 | 3 | 4.1 .161 | 9.0 ± 0.25 .354 | 4.3 ± 0.2 .169 | 18.0 ± 0.5 .709 | 4.2 ± 0.15 .166 | 2.0 | 12 | 43 | 60 | 90 | 160 | 183 | |
| 2631173951 | 3 | 4.9 .193 | 10.0 ± 0.25 .394 | 5.1 ± 0.2 .201 | 19.8 ± 0.5 .780 | 4.6 ± 0.15 .181 | 2.8 | 14 | 44 | 60 | 100 | 180 | 208 | 2631023002 |
| 2631164951 | 3 | 4.9 .193 | 12.3 ± 0.45 .484 | 5.1 ± 0.2 .201 | 25.4 ± 0.75 1.000 | 6.15 ± 0.2 .242 | 6.6 | 25 | 75 | 100 | 169 | 280 | 247 | 2631480002 |
| 2631164281 | 3 | 6.3 .250 | 15.0 ± 0.25 .590 | 6.6 ± 0.3 .260 | 28.9 ± 0.6 1.125 | 7.5 ± 0.15 .295 | 11 | 28 | 83 | 105 | 180 | 310 | 240 | 2631540002 |
| 2631178281 | 3 | 8.7 .343 | 16.5 ± 0.4 .648 | 9.0 ± 0.3 .354 | 28.6 ± 0.8 1.126 | 8.25 ± 0.15 .325 | 9.9 | 18 | 63 | 85 | 130 | 250 | 275 | 2631665702 |
| 2631167281 | 3 | 9.85 .388 | 18.6 ± 0.45 .732 | 10.15 ± 0.3 400 | 28.9 ± 0.6 1.138 | 9.5 ± 0.25 .375 | 14 | 18 | 56 | 81 | 144 | 240 | 270 | 2631626402 |
| 2631164181 | 3 | 12.7 .500 | 25.9 ± 0.5 1.020 | 13.05 ± 0.3 .514 | 28.9 ± 0.6 1.138 | 12.95 ± 0.25 .510 | 27 | 25 | 71 | 100 | 156 | 260 | 260 | 2631102002 |
| 2631176451 | 3 | 18.0 .709 | 34.9 ± 0.65 1.374 | 18.35 ± 0.35 .722 | 44.35 ± 0.35 1.746 | 17.45 ± 0.3 .687 | 76 | 47 | 95 | 130 | 225 | 380 | 370 | 2631103002 |
| 2631173551 | 1 | 18.5 .728 | 25.9 ± 0.5 1.020 | 18.8 ± 0.3 .740 | 38.9 ± 0.4 1.532 | 13.0 ± 0.25 .512 | 35 | 16 | 48 | 69 | 125 | 220 | 310 | 2631103102 |
| 2631177081 | 3 | 25.4 1.000 | 50.8 ± 1.0 2.000 | 25.9 ± 0.5 1.030 | 37.45 ± 0.75 1.474 | 25.4 ± 0.5 1.000 | 145 | 45 | 90 | 125 | 218 | 375 | 340 | 2631626202 |

Broadband Frequencies 25-300 MHz (43 & 44 material)

| Part Number | Fig. | Max. Cable Diameter | A | B** | C | D | Wt. (g) | Typical Impedance(Ω) | | | | Solid Equivalent* |
|-------------|------|---------------------|----------------------------|---------------------------|-----------------------------|----------------------------|---------|-------------------------------|---------------------|----------------------|---------|-------------------|
| | | | | | | | | 10 MHz | 25 MHz ⁺ | 100 MHz ⁺ | 250 MHz | |
| 2643166751 | 1 | 2.3 .090 | 7.65 - 0.25 .296 | 2.3 ± 0.25 .095 | 7.8 - 0.5 .297 | 3.9 - 0.25 .148 | 1.0 | 30 | 60 | 93 | 105 | 2643000801 |
| 2643178181 | 3 | 4.1 .161 | 9.0 ± 0.25 .354 | 4.3 ± 0.2 .169 | 18.0 ± 0.5 .709 | 4.2 ± 0.15 .166 | 2.0 | 40 | 70 | 125 | 152 | |
| 2644173951 | 3 | 4.9 .193 | 10.0 ± 0.25 .394 | 5.1 ± 0.2 .201 | 19.8 ± 0.5 .780 | 4.6 ± 0.15 .181 | 2.8 | 54 | 94 | 150 | 187 | 2643023002 |
| 2644164951 | 3 | 4.9 .193 | 12.3 ± 0.45 .484 | 5.1 ± 0.2 .201 | 25.4 ± 0.75 1.000 | 6.15 ± 0.2 .242 | 6.6 | 90 | 144 | 245 | 257 | 2643480002 |
| 2643164251 | 1 | 6.3 .250 | 15.0 ± 0.25 .590 | 6.6 ± 0.3 .260 | 28.6 ± 0.8 1.125 | 7.5 ± 0.15 .295 | 14 | 100 | 163 | 275 | 275 | 2643540002 |
| 2644164281 | 3 | 6.3 .250 | 15.0 ± 0.25 .590 | 6.6 ± 0.3 .260 | 28.9 ± 0.6 1.125 | 7.5 ± 0.15 .295 | 11 | 95 | 156 | 260 | 270 | 2643540002 |
| 2643165451 | 1 | 6.3 .250 | 15.0 ± 0.25 .590 | 6.6 ± 0.3 .260 | 15.25 ± 0.6 .600 | 7.5 ± 0.15 .295 | 7.0 | 52 | 94 | 155 | 232 | |
| 2643625006 | 2 | 7.6 .300 | 15.9 ± 0.4 .626 | 7.9 ± 0.3 .311 | 14.3 ± 0.4 .563 | 7.95 ± 0.2 .313 | 5.3 | 27 | 50 | 113 | 188 | 2643625002 |
| 2643178281 | 3 | 8.7 .343 | 16.5 ± 0.4 .648 | 9.0 ± 0.3 .354 | 28.6 ± 0.8 1.126 | 8.25 ± 0.15 .325 | 9.9 | 65 | 120 | 230 | 265 | 2643665702 |
| 2643665806 | 2 | 9.3 .365 | 17.5 ± 0.5 .689 | 9.5 ± 0.3 .374 | 12.7 ± 0.4 .500 | 8.75 ± 0.25 .344 | 5.1 | 23 | 41 | 88 | 122 | 2643665802 |

* For solid cable cores see pages 31-32 and 70-74

⁺ Test frequency

** "B" dimension is the core dimension.

Fair-Rite Products Corp.

Phone: (888) FAIR RITE / (845) 895-2055 • FAX: (888) FERRITE / (845) 895-2629
(888) 324-7748

PO Box J, One Commercial Row, Wallkill, NY 12589-0288

• www.fair-rite.com
• E-Mail: ferrites@fair-rite.com

Split Round Cable EMI Suppression Cores

Listed by frequency and in ascending order of cable diameter.

Broadband Frequencies 25-300 MHz (43 & 44 material)

Dimensions (Bold numbers are in millimeters, light numbers are nominal in inches.)

| Part Number | Fig. | Max. Cable Diameter | A | B** | C | D | Wt. (g) | Typical Impedance(Ω) | | | | Solid Equivalent* |
|-------------|------|---------------------|--------------------|--------------------|---------------------|--------------------|---------|-------------------------------|---------------------|----------------------|---------|-------------------|
| | | | | | | | | 10 MHz | 25 MHz ⁺ | 100 MHz ⁺ | 250 MHz | |
| 2643167251 | 1 | 9.85 .388 | 18.65±0.4 .735 | 10.15±0.3 .400 | 28.6±0.8 1.125 | 9.4±0.15 .370 | 19 | 79 | 138 | 225 | 285 | 2643626402 |
| 2644167281 | 3 | 9.85 .388 | 18.6±0.45 .732 | 10.15±0.3 .400 | 28.9±0.6 1.138 | 9.5±0.25 .375 | 14 | 77 | 125 | 210 | 260 | 2643626402 |
| 2643164151 | 1 | 12.7 .500 | 25.9±0.5 1.020 | 13.05±0.3 .514 | 28.6±0.8 1.125 | 12.95±0.25 .510 | 39 | 90 | 156 | 250 | 305 | 2643102002 |
| 2644164181 | 3 | 12.7 .500 | 25.9±0.5 1.020 | 13.05±0.3 .514 | 28.9±0.6 1.138 | 12.95±0.25 .510 | 27 | 76 | 138 | 230 | 280 | 2643102002 |
| 2643800506 | 2 | 12.8 .504 | 21.0±0.5 .827 | 13.2±0.4 .520 | 11.9±0.4 .469 | 10.5±0.25 .413 | 6.3 | 18 | 35 | 75 | 120 | 2643800502 |
| 2643806406 | 2 | 15.0 .591 | 25.4±0.6 1.000 | 15.5±0.5 .610 | 12.7±0.4 .500 | 12.7±0.3 .500 | 9.9 | 24 | 43 | 90 | 147 | 2643806402 |
| 2644176451 | 3 | 18.0 .709 | 34.9±0.65 1.374 | 18.35±0.35 .722 | 44.35±0.35 1.746 | 17.45±0.3 .687 | 76 | 100 | 175 | 365 | 365 | 2643103002 |
| 2644173551 | 1 | 18.5 .728 | 25.9±0.5 1.020 | 18.8±0.3 .740 | 38.9±0.4 1.532 | 13.0±0.25 .512 | 35 | 50 | 95 | 195 | 322 | 2643103102 |
| 2644177081 | 3 | 25.4 1.000 | 50.8±1.0 2.000 | 25.9±0.5 1.030 | 37.45±0.75 1.474 | 25.4±0.5 1.000 | 145 | 115 | 194 | 335 | 350 | 2643626202 |

Broadband Frequencies 25-300 MHz (Economical 46 material)

| Part Number | Fig. | Max. Cable Diameter | A | B** | C | D | Wt. (g) | Typical Impedance(Ω) | | | | Solid Equivalent* |
|-------------|------|---------------------|--------------------|--------------------|---------------------|--------------------|---------|-------------------------------|--------|----------------------|---------|-------------------|
| | | | | | | | | 10 MHz | 25 MHz | 100 MHz ⁺ | 250 MHz | |
| 2646173951 | 3 | 4.9 .193 | 10.0±0.25 .394 | 5.1±0.2 .201 | 19.8±0.5 .780 | 4.6±0.15 .181 | 2.8 | 46 | 82 | 135 | 185 | |
| 2646164951 | 3 | 4.9 .193 | 12.3±0.45 .484 | 5.1±0.2 .201 | 25.4±0.75 1.000 | 6.15±0.2 .242 | 6.6 | 72 | 120 | 220 | 250 | 2646800002 |
| 2646164251 | 1 | 6.3 .250 | 15.0±0.25 .590 | 6.6±0.3 .260 | 28.6±0.8 1.125 | 7.5±0.15 .295 | 14 | 81 | 134 | 245 | 273 | 2646540002 |
| 2646164281 | 3 | 6.3 .250 | 15.0±0.25 .590 | 6.6±0.3 .260 | 28.9±0.6 1.125 | 7.5±0.15 .295 | 11 | 81 | 131 | 235 | 265 | 2646540002 |
| 2646167281 | 3 | 9.85 .388 | 18.6±0.45 .732 | 10.15±0.3 .400 | 28.9±0.6 1.138 | 9.5±0.25 .375 | 14 | 66 | 105 | 190 | 275 | |
| 2646167251 | 1 | 9.85 .388 | 18.65±0.4 .735 | 10.15±0.3 .400 | 28.6±0.8 1.125 | 9.4±0.15 .370 | 19 | 72 | 116 | 202 | 247 | |
| 2646164181 | 3 | 12.7 .500 | 25.9±0.5 1.020 | 13.05±0.3 .514 | 28.9±0.6 1.138 | 12.95±0.25 .510 | 27 | 73 | 115 | 205 | 275 | 2646102002 |
| 2646164151 | 1 | 12.7 .500 | 25.9±0.5 1.020 | 13.05±0.3 .514 | 28.6±0.8 1.125 | 12.95±0.25 .510 | 39 | 84 | 127 | 225 | 270 | 2646102002 |
| 2646176451 | 3 | 18.0 .709 | 34.9±0.65 1.374 | 18.35±0.35 .722 | 44.35±0.35 1.746 | 17.45±0.3 .687 | 76 | 85 | 152 | 330 | 360 | 2646103002 |
| 2646173551 | 1 | 18.5 .728 | 25.9±0.5 1.020 | 18.8±0.3 .740 | 38.9±0.4 1.532 | 13.0±0.25 .512 | 35 | 48 | 85 | 176 | 300 | |
| 2646177081 | 3 | 25.4 1.000 | 50.8±1.0 2.000 | 25.9±0.5 1.030 | 37.45±0.75 1.474 | 25.4±0.5 1.000 | 145 | 97 | 169 | 330 | 330 | 2646626202 |

* For solid cable cores see pages 70-74

⁺ Test frequency

** "B" dimension is the core dimension.

Fair-Rite Products Corp.

PO Box J, One Commercial Row, Wallkill, NY 12589-0288

Phone: (888) FAIR RITE / (845) 895-2055 • FAX: (888) FERRITE / (845) 895-2629
(888) 324-7748 (888) 337-7483

• www.fair-rite.com
• E-Mail: ferrites@fair-rite.com

Split Round Cable EMI Suppression Cores

Listed by frequency and in ascending order of cable diameter.

Higher Frequencies 200-1000 MHz (61 material)

Dimensions (Bold numbers are in millimeters, light numbers are nominal in inches.)

| Part Number | Fig. | Max. Cable Diameter | A | B** | C | D | Wt. (g) | Typical Impedance(Ω) | | | | Solid Equivalent* |
|-------------|------|---------------------|---------------------------|---------------------------|----------------------------|---------------------------|---------|-------------------------------|----------------------|----------------------|----------|-------------------|
| | | | | | | | | 100 MHz ⁺ | 250 MHz ⁺ | 500 MHz ⁺ | 1000 MHz | |
| 2661178181 | 3 | 4.1 .161 | 9.0±0.25 .354 | 4.5±0.2 .169 | 18.0±0.5 .709 | 4.2±0.15 .166 | 2.0 | 115 | 165 | 215 | 300 | |
| 2661164951 | 3 | 4.9 .193 | 12.3±0.45 .484 | 5.1±0.2 .201 | 25.4±0.75 1.000 | 6.15±0.2 .242 | 6.6 | 215 | 325 | 385 | 332 | |
| 2661164281 | 3 | 6.3 .250 | 15.0±0.25 .590 | 6.6±0.3 .260 | 28.9±0.6 1.125 | 7.5±0.15 .295 | 11 | 230 | 355 | 425 | 420 | 2661540002 |
| 2661178281 | 3 | 8.7 .343 | 16.5±0.4 .648 | 9.0±0.3 .354 | 28.6±0.8 1.126 | 8.25±0.15 .325 | 9.9 | 180 | 285 | 380 | 430 | 2661665702 |
| 2661167281 | 3 | 9.85 .388 | 18.6±0.45 .732 | 10.15±0.3 .400 | 28.9±0.6 1.138 | 9.5±0.25 .375 | 14 | 175 | 275 | 375 | 400 | 2661626402 |
| 2661164181 | 3 | 12.7 .500 | 25.9±0.5 1.020 | 13.05±0.3 .514 | 28.9±0.6 1.138 | 12.95±0.25 .510 | 27 | 205 | 320 | 435 | 257 | 2661102002 |
| 2661176451 | 3 | 18.0 .709 | 34.9±0.65 1.374 | 18.35±0.35 .722 | 44.35±0.35 1.746 | 17.45±0.3 .687 | 76 | 360 | 400 | 350 | 110 | |

* For solid cable cores see pages 70-74

⁺ Test frequency

** "B" dimension is the core dimension.

Fair-Rite Products Corp.

PO Box J, One Commercial Row, Wallkill, NY 12589-0288

Phone: (888) FAIR RITE / (845) 895-2055 • FAX: (888) FERRITE / (845) 895-2629
(888) 324-7748 (888) 337-7483

• www.fair-rite.com
• E-Mail: ferrites@fair-rite.com

Flat Cable EMI Suppression Cores

Listed by frequency range and in ascending order of cable width.

Flat cable suppression core can accommodate multi-conductors flat cables, in widths from 12.7 mm (.500") up to 78 mm (3.1"). These flat cable cores are available in two ferrite material grades to reduce conducted EMI from 1 MHz into the hundreds of MHz.

- Flat cable suppression cores, split or single cores, are controlled for impedances only. The impedances listed are typical values. Minimum impedance values are specified for the + marked frequencies. The minimum guaranteed impedance is the listed impedance less 20%.
- Single turn impedance tests for the 31 and 43 material are made on the 4193A Vector Impedance Analyzer. **All tests are made with the shortest practical wire length.**
- Performance curves for all flat cable parts are compiled on the Fair-Rite Products CD-ROM.
- Assembly clips are available for most of the split flat cable cores. See pages 86-87 for a listing of flat cable cores and the clips that can be used with these cores.
- Our "Expanded Cable & Connector EMI Suppressor Kit" (part number 0199000005) contains a selection of these flat cable cores and clips. See page 67.
- Explanation of Part Numbers: Digits 1&2 = product class and 3&4 = material grade.

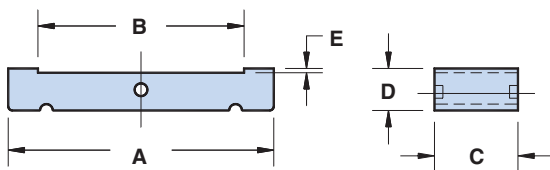

Figure 1

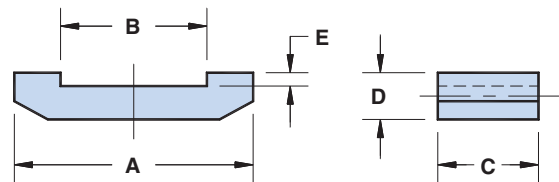

Figure 2

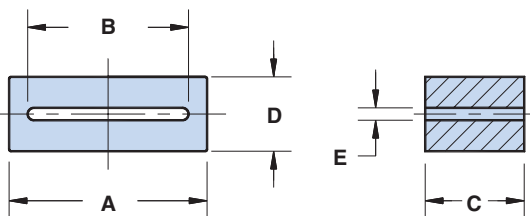

Figure 3

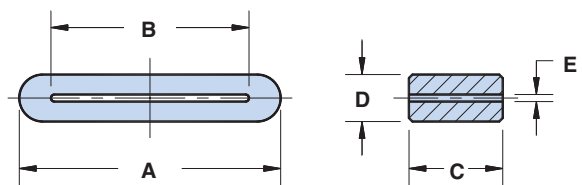

Figure 4

Fair-Rite Products Corp.

PO Box J, One Commercial Row, Wallkill, NY 12589-0288

Phone: (888) FAIR RITE / (845) 895-2055 • FAX: (888) FERRITE / (845) 895-2629 • www.fair-rite.com
 (888) 324-7748 (888) 337-7483 • E-Mail: ferrites@fair-rite.com

Flat Cable EMI Suppression Cores

Listed by frequency range in ascending order of cable width.

Lower & Broadband Frequencies 1-300 MHz (31 material)

Dimensions (Bold numbers are in millimeters, light numbers are nominal in inches.)

| Part Number | Fig. | Max. Cable Dimensions | A | B | C | D | E | Wt. (g) | Typical Impedance(Ω) | | | | | |
|-------------|------|----------------------------|-------------------|---------------------|--------------------|-------------------|------------------|---------|-------------------------------|-------|---------------------|---------------------|----------------------|---------|
| | | | | | | | | | 1 MHz | 5 MHz | 10 MHz ⁺ | 25 MHz ⁺ | 100 MHz ⁺ | 250 MHz |
| 2631163851 | 3 | 25.9 x 1.5 1.020 x .060 | 38.1±1.0 1.500 | 26.65±0.75 1.050 | 25.4±0.75 1.000 | 12.05±0.4 .475 | 1.9±0.4 .075 | 51 | 20 | 52 | 68 | 112 | 240 | 440 |
| 2631163951* | 1 | 51.0 x 1.3 2.000 x .050 | 63.5±1.3 2.500 | 52.1±1.1 2.050 | 28.6±0.8 1.125 | 6.35±0.25 .250 | 0.85±0.2 .033 | 50 | 13 | 35 | 54 | 105 | 300 | 425 |
| 2631164051* | 1 | 64.0 x 1.3 2.520 x .050 | 76.2±1.5 3.000 | 65.3±1.3 2.570 | 28.6±0.8 1.125 | 6.35±0.25 .250 | 0.85±0.2 .033 | 60 | 11 | 34 | 52 | 105 | 310 | 440 |

Broadband Frequencies 25-300 MHz (43 material)

| Part Number | Fig. | Max. Cable Dimensions | A | B | C | D | E | Wt. (g) | Typical Impedance(Ω) | | | |
|-------------|------|-----------------------------|---------------------|---------------------|-------------------|--------------------|-------------------|---------|-------------------------------|---------------------|----------------------|---------|
| | | | | | | | | | 10 MHz | 25 MHz ⁺ | 100 MHz ⁺ | 250 MHz |
| 2643170251 | 2 | 12.2 x 2.3 .480 x .091 | 22.75±0.65 .895 | 12.7±0.5 .500 | 12.7±0.5 .500 | 3.3 - 0.25 .125 | 1.15±0.25 .050 | 3.5 | 20 | 35 | 70 | 135 |
| 2643178451 | 4 | 13.1 x 1.35 .516 x .053 | 18.5±0.4 .728 | 13.5±0.4 .531 | 6.0±0.3 .236 | 6.6±0.25 .260 | 1.6±0.25 .063 | 2.9 | 15 | 25 | 48 | 90 |
| 2643178351 | 4 | 13.1 x 1.35 .516 x .053 | 18.5±0.4 .728 | 13.5±0.4 .531 | 12.0±0.3 .472 | 6.6±0.25 .260 | 1.6±0.25 .063 | 5.9 | 31 | 48 | 82 | 140 |
| 2643169552 | 3 | 13.95 x 0.75 .549 x .030 | 19.95±0.4 .785 | 14.2±0.25 .560 | 10.15±0.5 .400 | 6.35±0.25 .250 | 0.9±0.15 .035 | 5.7 | 25 | 40 | 90 | 160 |
| 2643168751 | 3 | 17.3 x 2.3 .681 x .091 | 25.4±0.75 1.000 | 17.8±0.5 .700 | 12.7±0.4 .500 | 10.15±0.25 .400 | 2.55±0.25 .100 | 13 | 31 | 50 | 95 | 200 |
| 2643173351 | 4 | 19.6 x 0.5 .772 x .020 | 24.5±0.4 .965 | 20.0±0.4 .787 | 12.0±0.3 .472 | 5.0±0.25 .197 | 0.75±0.25 .030 | 6.6 | 23 | 39 | 88 | 157 |
| 2643178651 | 4 | 21.1 x 1.35 .831 x .053 | 26.5±0.4 1.043 | 21.5±0.4 .846 | 6.0±0.3 .236 | 6.6±0.25 .260 | 1.6±0.25 .063 | 4.1 | 13 | 22 | 50 | 95 |
| 2643178551 | 4 | 21.1 x 1.35 .831 x .053 | 26.5±0.4 1.043 | 21.5±0.4 .846 | 12.0±0.3 .472 | 6.6±0.25 .260 | 1.6±0.25 .063 | 8.2 | 24 | 38 | 82 | 155 |
| 2643168651 | 2 | 25.4 x 12.2 1.000 x .480 | 38.85±0.75 1.530 | 26.15±0.75 1.030 | 28.6±0.7 1.125 | 13.0±0.3 .512 | 6.35±0.25 .255 | 45 | 57 | 100 | 188 | 295 |
| 2643164551 | 3 | 25.9 x 1.5 1.020 x .059 | 38.1±1.0 1.500 | 26.65±0.75 1.050 | 12.3±0.4 .485 | 12.05±0.4 .475 | 1.9±0.4 .075 | 25 | 33 | 53 | 105 | 215 |
| 2643171051* | 1 | 25.9 x 1.3 1.020 x .051 | 38.1±1.0 1.500 | 26.65±0.75 1.050 | 12.7±0.4 .500 | 6.35±0.25 .250 | 0.85±0.2 .033 | 14 | 32 | 53 | 112 | 235 |

* For assembly clips see page 86.

⁺ Test frequency

Fair-Rite Products Corp.

PO Box J, One Commercial Row, Wallkill, NY 12589-0288

Phone: (888) FAIR RITE / (845) 895-2055 • FAX: (888) FERRITE / (845) 895-2629 • www.fair-rite.com
(888) 324-7748 (888) 337-7483 • E-Mail: ferrites@fair-rite.com

Flat Cable EMI Suppression Cores

Listed by frequency range in ascending order of cable width.

Broadband Frequencies 25-300 MHz (43 material)

Dimensions (Bold numbers are in millimeters, light numbers are nominal in inches.)

| Part Number | Fig. | Max. Cable Dimensions | A | B | C | D | E | Wt. (g) | Typical Impedance(Ω) | | | |
|-------------|------|-------------------------------------|----------------------------|----------------------------|---------------------------|--------------------------|--------------------------|---------|-------------------------------|---------------------|----------------------|---------|
| | | | | | | | | | 10 MHz | 25 MHz ⁺ | 100 MHz ⁺ | 250 MHz |
| 2643166851* | 1 | 25.9 x 1.3 1.020 x .051 | 38.1±1.0 1.500 | 26.65±0.75 1.050 | 25.4±0.75 1.000 | 6.35±0.25 .250 | 0.85±0.2 .033 | 27 | 66 | 115 | 235 | 410 |
| 2643163851 | 3 | 25.9 x 1.5 1.020 x .059 | 38.1±1.0 1.500 | 26.65±0.75 1.050 | 25.4±0.75 1.000 | 12.05±0.4 .475 | 1.9±0.4 .075 | 51 | 64 | 105 | 220 | 385 |
| 2643178851 | 4 | 26.1 x 1.35 1.028 x .053 | 31.5±0.4 1.240 | 26.5±0.4 1.043 | 6.0±0.3 .236 | 6.6±0.25 .260 | 1.6±0.25 .063 | 4.8 | 12 | 22 | 55 | 94 |
| 2643178751 | 4 | 26.1 x 1.35 1.028 x .053 | 31.5±0.4 1.240 | 26.5±0.4 1.043 | 12.0±0.3 .472 | 6.6±0.25 .260 | 1.6±0.25 .063 | 9.7 | 22 | 37 | 85 | 157 |
| 2643172551 | 4 | 26.5 x 1.25 1.043 x .049 | 33.5±0.65 1.319 | 27.0±0.5 1.063 | 8.0±0.4 .315 | 6.5±0.25 .256 | 1.25±0.7 .063 | 6.8 | 12 | 22 | 58 | 106 |
| 2643169351 | 3 | 27.0 x 1.1 1.063 x .043 | 33.65±0.75 1.325 | 27.5±0.5 1.083 | 13.2±0.5 .520 | 6.7±0.4 .265 | 1.35±0.25 .053 | 12 | 22 | 39 | 98 | 192 |
| 2643166451* | 1 | 26.95 x 3.05 1.061 x .120 | 38.35±1.0 1.510 | 27.95±1.0 1.100 | 28.6±0.7 1.125 | 9.0±0.3 .355 | 3.3±0.25 .130 | 35 | 61 | 96 | 185 | 335 |
| 2643168051 | 1 | 32.3 x 6.2 1.272 x .244 | 52.9±1.0 2.083 | 33.0±0.7 1.299 | 31.25±1.0 1.230 | 12.5±0.4 .492 | 3.5±0.4 .138 | 84 | 81 | 140 | 265 | 400 |
| 2643167551 | 1 | 32.3 x 6.2 1.272 x .244 | 52.9±1.0 2.083 | 33.0±0.7 1.299 | 63.5±1.8 2.500 | 12.5±0.4 .492 | 3.5±0.4 .138 | 170 | 150 | 270 | 480 | 370 |
| 2643170951* | 1 | 33.7 x 1.3 1.327 x .051 | 45.1±0.75 1.775 | 34.4±0.7 1.355 | 12.7±0.4 .500 | 6.35±0.25 .250 | 0.85±0.2 .033 | 16 | 25 | 50 | 115 | 240 |
| 2643166551 | 3 | 33.7 x 1.2 1.327 x .047 | 45.1±0.75 1.775 | 34.4±0.7 1.355 | 28.6±0.7 1.125 | 12.45±0.4 .490 | 1.5±0.3 .060 | 71 | 67 | 115 | 300 | 415 |
| 2643166651 | 1 | 33.7 x 1.3 1.327 x .051 | 45.1±0.75 1.775 | 34.4±0.7 1.355 | 28.6±0.7 1.125 | 6.35±0.25 .250 | 0.85±0.2 .033 | 36 | 60 | 110 | 290 | 435 |
| 2643168251* | 1 | 51.0 x 1.3 2.008 x .051 | 63.5±1.3 2.500 | 52.1±1.1 2.050 | 12.7±0.4 .500 | 6.35±0.25 .250 | 0.85±0.2 .033 | 22 | 22 | 50 | 125 | 255 |
| 2643163951* | 1 | 51.0 x 1.3 2.008 x .051 | 63.5±1.3 2.500 | 52.1±1.1 2.050 | 28.6±0.8 1.125 | 6.35±0.25 .250 | 0.85±0.2 .033 | 50 | 56 | 100 | 290 | 400 |
| 2643167751* | 1 | 64.0 x 1.3 2.520 x .051 | 76.2±1.5 3.000 | 65.3±1.3 2.570 | 12.7±0.4 .500 | 6.35±0.25 .250 | 0.85±0.2 .033 | 27 | 22 | 45 | 115 | 240 |
| 2643164051* | 1 | 64.0 x 1.3 2.520 x .051 | 76.2±1.5 3.000 | 65.3±1.3 2.570 | 28.6±0.8 1.125 | 6.35±0.25 .250 | 0.85±0.2 .033 | 60 | 48 | 100 | 290 | 420 |
| 2643168351* | 1 | 76.7 x 1.3 3.020 x .051 | 88.9±1.8 3.500 | 78.2±1.5 3.080 | 28.6±0.8 1.125 | 6.5±0.35 .256 | 0.95±0.3 .037 | 70 | 45 | 100 | 280 | 440 |

*For assembly clips see page 86.

⁺ Test frequency

Fair-Rite Products Corp.

PO Box J, One Commercial Row, Wallkill, NY 12589-0288

Phone: (888) FAIR RITE / (845) 895-2055 • FAX: (888) FERRITE / (845) 895-2629
(888) 324-7748 (888) 337-7483

• www.fair-rite.com
• E-Mail: ferrites@fair-rite.com

Flat Cable Cores Assembly Clips

Fair-Rite offers several clips to accommodate the assembly of the split flat cable suppression cores.

- Figures 1 and 2 are metal clips, made from 0.5mm (.020") high carbon steel with a zinc electroplate finish.
- Figure 3 clips are a polypropylene material RoHS compliant, with a flammability rating of UL94-V0.

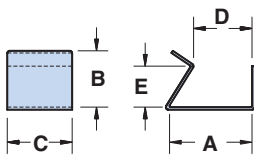

Figure 1

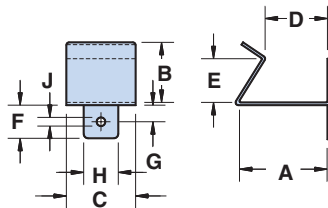

Figure 2

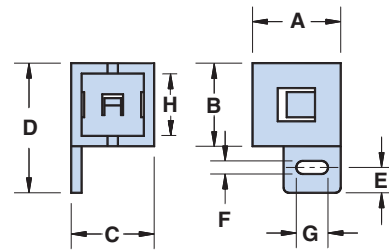

Figure 3

Clips

Dimensions (Bold numbers are in millimeters, light numbers are nominal in inches.)

| Part Number Clip | Fig. | A | B | C | D | E | F | G | H | J |
|------------------|------|---------------------|---------------------|---------------------|---------------------|--------------------|--------------------|--------------------|----------------------|--------------------|
| 0199001401 | 1 | 16.1 .635 | 11.0 .433 | 12.7 .500 | 11.4 .450 | 8.0 .315 | — | — | — | — |
| 0199010301 | 2 | 21.2 .835 | 11.0 .433 | 12.7 .500 | 16.5 .650 | 8.0 .315 | 7.5 .295 | 4.0 .157 | 6.0 .236 | 3.0 .118 |
| 0199016051 | 3 | 16.7 .657 | 15.9 .626 | 15.9 .626 | 24.6 .969 | 4.4 .171 | 3.2 .126 | 6.4 .252 | 13.1 .516 | — |
| 0199016551 | 3 | 16.7 .657 | 32.2 1.27 | 15.9 .626 | 40.5 1.59 | 4.4 .171 | 3.2 .126 | 6.4 .252 | 29.5 1.161 | — |

Flat Cable Cores Assembly Clips

| | 0199001401 | 0199010301 | 0199016051 | 0199016551 |
|------------|------------|------------|------------|------------|
| 2631163951 | X | | | X |
| 2631164051 | X | | | |
| | | | | |
| | | | | |
| 2643163951 | X | | | X |
| 2643164051 | X | | | X |
| 2643166451 | | X | | |
| 2643166651 | X | | | X |
| 2643166851 | X | | | |
| 2643167751 | X | | X | |
| 2643168251 | X | | X | |
| 2643168351 | X | | | X |
| 2643170951 | X | | X | |
| 2643171051 | X | | X | |

Fair-Rite Products Corp.

PO Box J, One Commercial Row, Wallkill, NY 12589-0288

Phone: (888) FAIR RITE / (845) 895-2055 • FAX: (888) FERRITE / (845) 895-2629
(888) 324-7748 (888) 337-7483

• www.fair-rite.com
• E-Mail: ferrites@fair-rite.com

Flat Cable Snap-its

Listed by frequency range in ascending order of cable width.

Flat cable snap-its for use on multi-conductor flat cables to suppress common-mode conducted EMI from 1MHz to hundreds of MHz. These flat cable snap-its are available in two ferrite materials, 31 and 43.

The polypropylene cases are meeting the RoHS restrictions of hazardous substances and have a flammability rating of UL94-V0.

- Flat cable snap-it assemblies are controlled for impedances only. The impedances listed are typical values. Minimum impedance values are specified for the + marked frequencies. The minimum guaranteed impedance is the listed impedance less 20%.
- Single turn impedance tests on the 31 and 43 material parts are performed on the 4193A Vector Impedance Analyzer. **Cores are tested with the shortest practical wire length.**
- Performance curves of all listed flat cable snap-its are compiled on the Fair-Rite Products CD-ROM.
- The "Expanded Cable and Connector EMI Suppressor Kit" (part number 0199000005) contains several flat cable snap-it assemblies. See page 67.
- Explanation of Part Numbers: Digits 1&2 = product class and 3&4 material grade.

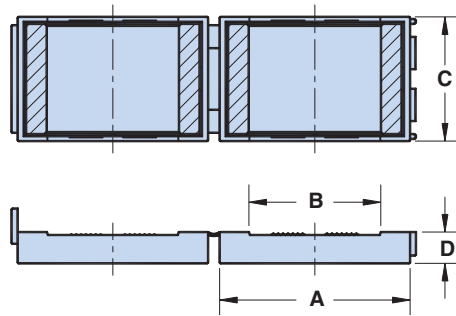

Lower & Broadband Frequencies 1-300 MHz (31 material)

Dimensions (Bold numbers are in millimeters, light numbers are nominal in inches.)

| Part Number | Max. Cable Dimensions | A | B | C | D | Wt. (g) | Typical Impedance(Ω) | | | | | |
|-------------|-----------------------------------|----------------------|----------------------|----------------------|--------------------|---------|-------------------------------|-------|---------------------|---------------------|----------------------|---------|
| | | | | | | | 1 MHz | 5 MHz | 10 MHz ⁺ | 25 MHz ⁺ | 100 MHz ⁺ | 250 MHz |
| 0431163951 | 51.0 x 1.3 2.000 x .050 | 67.8 2.670 | 52.1 2.050 | 32.3 1.272 | 8.1 .320 | 110 | 13 | 35 | 54 | 105 | 300 | 425 |
| 0431164051 | 64.0 x 1.3 2.520 x .050 | 80.8 3.180 | 65.3 2.570 | 32.3 1.272 | 8.1 .320 | 130 | 11 | 34 | 52 | 105 | 310 | 440 |

Broadband Frequencies 25-300 MHz (43 material)

| Part Number | Max. Cable Dimensions | A | B | C | D | Wt. (g) | Typical Impedance(Ω) | | | |
|-------------|-----------------------------------|----------------------|----------------------|----------------------|--------------------|---------|-------------------------------|---------------------|----------------------|---------|
| | | | | | | | 10 MHz | 25 MHz ⁺ | 100 MHz ⁺ | 250 MHz |
| 0443166651 | 33.7 X 1.3 1.325 X .050 | 49.5 1.950 | 34.4 1.350 | 32.3 1.272 | 8.1 .320 | 80 | 60 | 110 | 290 | 435 |
| 0443163951 | 51.0 X 1.3 2.000 X .050 | 67.8 2.670 | 52.1 2.050 | 32.3 1.272 | 8.1 .320 | 110 | 56 | 100 | 290 | 400 |
| 0443164051 | 64.0 X 1.3 2.520 X .050 | 80.8 3.180 | 65.3 2.570 | 32.3 1.272 | 8.1 .320 | 130 | 48 | 100 | 290 | 420 |

⁺ Test frequency

Fair-Rite Products Corp.

PO Box J, One Commercial Row, Wallkill, NY 12589-0288

Phone: (888) FAIR RITE / (845) 895-2055 • FAX: (888) FERRITE / (845) 895-2629
(888) 324-7748 (888) 337-7483

• www.fair-rite.com
• E-Mail: ferrites@fair-rite.com

Connector EMI Suppression Plates

To provide suppression of conducted EMI at critical interfaces Fair-Rite has available a line of suppression plates that can be used with many types of connectors. All connector plates are supplied in the NiZn 44 grade ideally suited for this application because of its high impedance along with a high resistivity.

- Connector plates are controlled for impedance only. The impedances listed are typical values. Minimum impedance values are specified for the + marked frequencies. The minimum guaranteed impedance is the listed typical impedance less 20%. Single turn impedance tests are performed on the 4193A Vector Impedance Analyzer.
- Performance curves of all listed connector plates are included on the Fair-Rite Products CD-ROM.
- For any connector EMI suppression plate requirement not listed here, feel free to contact our customer service group for availability and pricing.
- Explanation of Part Numbers: Digits 1&2 = product class and 3&4 = the 44 material grade.

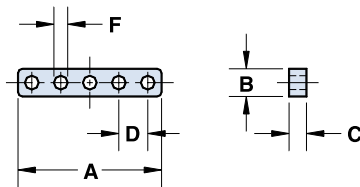

Figure 1

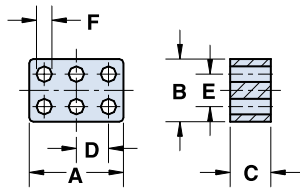

Figure 2

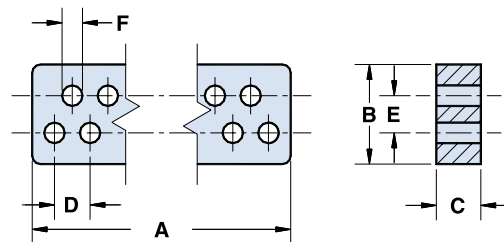

Figure 3

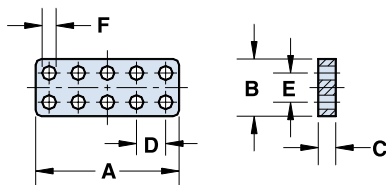

Figure 4

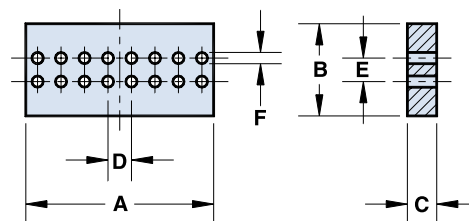

Figure 5

Fair-Rite Products Corp.

PO Box J, One Commercial Row, Wallkill, NY 12589-0288

Phone: (888) FAIR RITE / (845) 895-2055 • FAX: (888) FERRITE / (845) 895-2629
(888) 324-7748 (888) 337-7483

• www.fair-rite.com
• E-Mail: ferrites@fair-rite.com

Connector EMI Suppression Plates

Dimensions (Bold numbers are in millimeters, light numbers are nominal in inches.)

| Part Number | Figure | Total Holes | Number of Rows | A | B | C* | D | E | F | Wt (g) | Typical Impedance(Ω) | |
|-------------|--------|-------------|----------------|---------------------------|-------------------------------|--------------------------|--------------------------|--------------------------|--------------------------|--------|-------------------------------|----------------------|
| | | | | | | | | | | | 25 MHz ⁺ | 100 MHz ⁺ |
| 2644246701 | 1 | 5 | 1 | 12.52±0.13 .493 | 2.54 Max. .100 Max. | 1.52±0.13 .060 | 2.54±0.13 .100 | — | 1.22±0.07 .048 | .18 | 13 | 28 |
| 2644246201 | 2 | 6 | 2 | 5.86±0.10 .231 | 3.86±0.10 .152 | 1.52±0.13 .060 | 2.00±0.08 .079 | 2.00±0.08 .079 | 0.82±0.1 .034 | .14 | 14 | 28 |
| 2644245701 | 2 | 6 | 2 | 7.44±0.10 .293 | 4.90±0.10 .193 | 1.52±0.13 .060 | 2.54±0.13 .100 | 2.54±0.10 .100 | 1.22±0.07 .048 | .22 | 13 | 28 |
| 2644236101 | 3 | 9 | 2 | 14.40±0.15 .567 | 7.75 0.25 .300 | 3.43±0.13 .135 | 2.75±0.13 .108 | 2.85±0.13 .112 | 1.60±0.08 .062 | 1.6 | 30 | 51 |
| 2644236401 | 3 | 9 | 2 | 14.40±0.15 .567 | 7.75 0.25 .300 | 6.86±0.13 .270 | 2.75±0.13 .108 | 2.85±0.13 .112 | 1.60±0.08 .062 | 3.2 | 56 | 91 |
| 2644247001 | 4 | 10 | 2 | 12.52±0.13 .493 | 4.90±0.10 .193 | 1.52±0.13 .060 | 2.54±0.13 .100 | 2.54±0.10 .100 | 1.22±0.07 .048 | .37 | 13 | 28 |
| 2644247101 | 4 | 10 | 2 | 12.52±0.13 .493 | 4.90±0.10 .193 | 3.05±0.13 .120 | 2.54±0.13 .100 | 2.54±0.10 .100 | 1.22±0.07 .048 | .74 | 23 | 40 |
| 2644236301 | 3 | 15 | 2 | 22.55±0.25 .888 | 7.75 0.25 .300 | 3.43±0.13 .135 | 2.75±0.13 .108 | 2.85±0.13 .112 | 1.60±0.08 .062 | 2.4 | 30 | 51 |
| 2644236501 | 3 | 15 | 2 | 22.55±0.25 .888 | 7.75 0.25 .300 | 6.86±0.13 .270 | 2.75±0.13 .108 | 2.85±0.13 .112 | 1.60±0.08 .062 | 4.9 | 56 | 91 |
| 2644373941 | 5 | 16 | 2 | 21.60±0.25 .850 | 11.65 0.40 .451 | 1.52±0.13 .060 | 2.54±0.13 .100 | 7.62±0.15 .300 | 1.00±0.15 .042 | 2.9 | 19 | 36 |
| 2644373841 | 5 | 16 | 2 | 20.30±0.25 .800 | 10.15 0.40 .392 | 3.18±0.13 .125 | 2.54±0.13 .100 | 2.54±0.10 .100 | 1.22±0.07 .048 | 2.8 | 30 | 51 |
| 2644236001 | 3 | 25 | 2 | 36.3±0.4 1.430 | 7.75 0.25 .300 | 3.43±0.13 .135 | 2.75±0.13 .108 | 2.85±0.13 .112 | 1.60±0.08 .062 | 3.6 | 30 | 51 |
| 2644236601 | 3 | 25 | 2 | 36.3±0.4 1.430 | 7.75 0.25 .300 | 6.86±0.13 .270 | 2.75±0.13 .108 | 2.85±0.13 .112 | 1.60±0.08 .062 | 7.2 | 56 | 91 |

* This dimension may be modified to suit specific applications.

⁺ Test Frequency

Fair-Rite Products Corp.

PO Box J, One Commercial Row, Walkill, NY 12589-0288

Phone: (888) FAIR RITE / (845) 895-2055 • FAX: (888) FERRITE / (845) 895-2629 • www.fair-rite.com
(888) 324-7748 (888) 337-7483 • E-Mail: ferrites@fair-rite.com

Miscellaneous Suppression Cores

Fair-Rite has tooled several special core geometries in the 43 & 77 material for suppression of conducted EMI.

- These suppression cores are controlled for impedance only. The impedances listed are typical values. Single turn tests are performed on the 4193A Vector Impedance Analyzer **with the shortest practical wire length.**
- Performance curves on these miscellaneous cores are included on the Fair-Rite Products CD-ROM.
- For any non-catalog suppression core design feel free to contact our customer service or application group for feasibility and availability.
- Explanation of Part Numbers: Digits 1&2 = product class and 3&4 = the material grade.

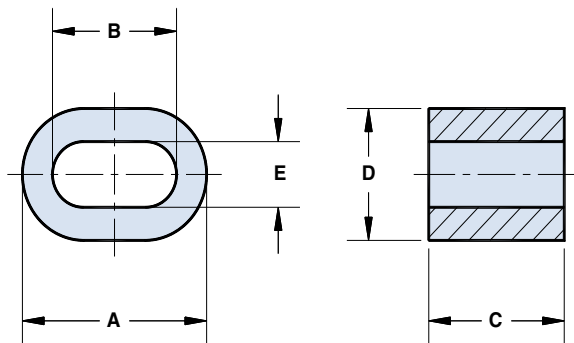

Figure 1

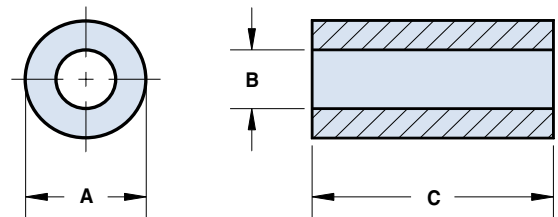

Figure 2

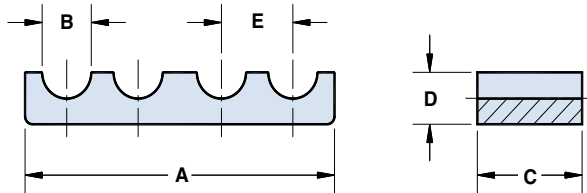

Figure 3

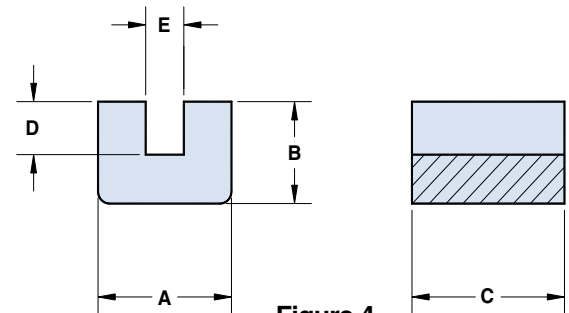

Figure 4

Dimensions (Bold numbers are in millimeters, light numbers are nominal in inches.)

| Part Number | Fig. | A | B | C* | D | E | Typical Impedance (Ω) | | | | |
|-------------|------|----------------------------|----------------------------|--------------------------|---------------------------|---------------------------|--------------------------------|--------|--------|---------|---------|
| | | | | | | | 1 MHz | 10 MHz | 25 MHz | 100 MHz | 250 MHz |
| 2643167851 | 1 | 38.85±0.75 1.530 | 26.15±0.75 1.030 | 28.6±0.7 1.125 | 26.0±0.6 1.025 | 12.95±0.25 .510 | --- | 60 | 94 | 169 | 250 |
| 2643165151 | 3 | 82.6±1.6 3.250 | 13.1±0.3 .516 | 28.0±0.7 1.100 | 12.95±0.25 .510 | 19.05±0.4 .750 | --- | 100 | 163 | 280 | 340 |
| 2643175451 | 4 | 17.8±0.4 .700 | 12.7±0.5 .500 | 20.32±0.5 .800 | 6.6±0.25 .260 | 5.08±0.25 .200 | --- | 75 | 119 | 180 | 270 |
| 2677006302 | 2 | 9.5±0.25 .375 | 4.75±0.3 .193 | 10.4±0.25 .410 | --- | --- | 25 | 48 | 33 | --- | --- |
| 2677102402 | 2 | 25.9±0.75 1.020 | 12.8±0.25 .505 | 21.3±0.5 .840 | --- | --- | 52 | 28 | 24 | --- | --- |

*This dimension may be modified to suit specific applications.

Fair-Rite Products Corp.

PO Box J, One Commercial Row, Wallkill, NY 12589-0288

Phone: (888) FAIR RITE / (845) 895-2055 • FAX: (888) FERRITE / (845) 895-2629 • www.fair-rite.com
 (888) 324-7748 (888) 337-7483 • E-Mail: ferrites@fair-rite.com

0431163951

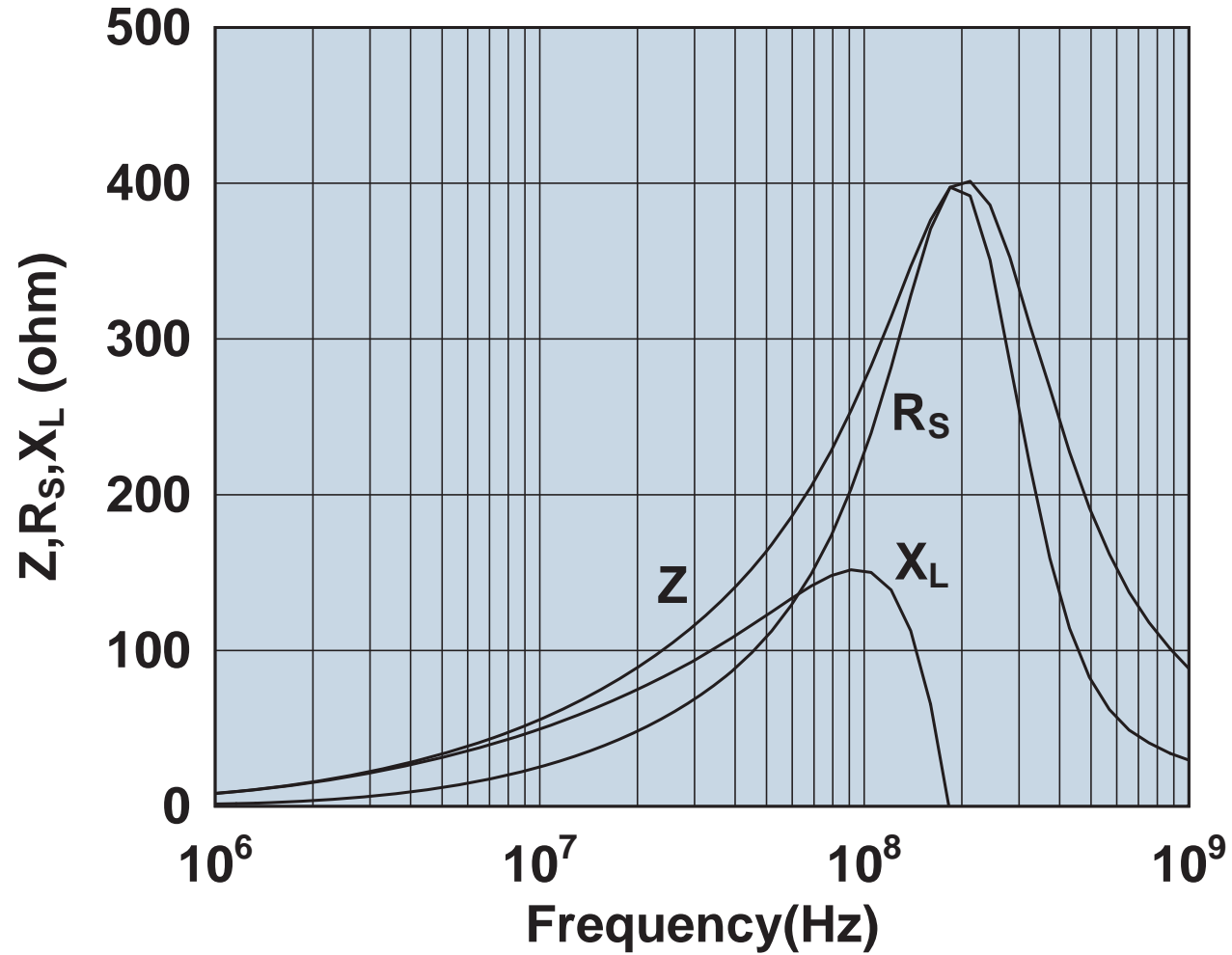

Impedance, reactance, and resistance vs. frequency.

0431164051

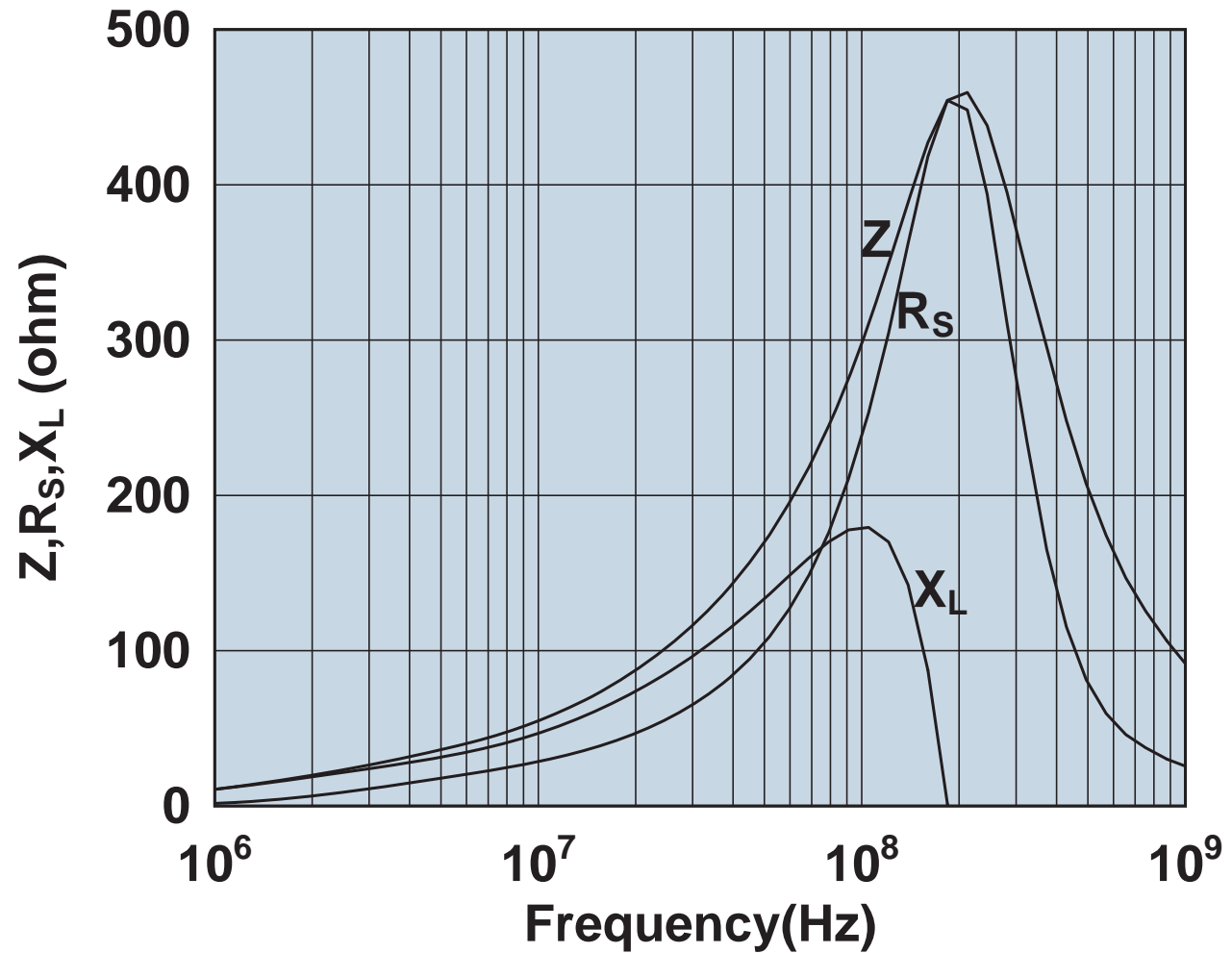

Impedance, reactance, and resistance vs. frequency.

0431164181

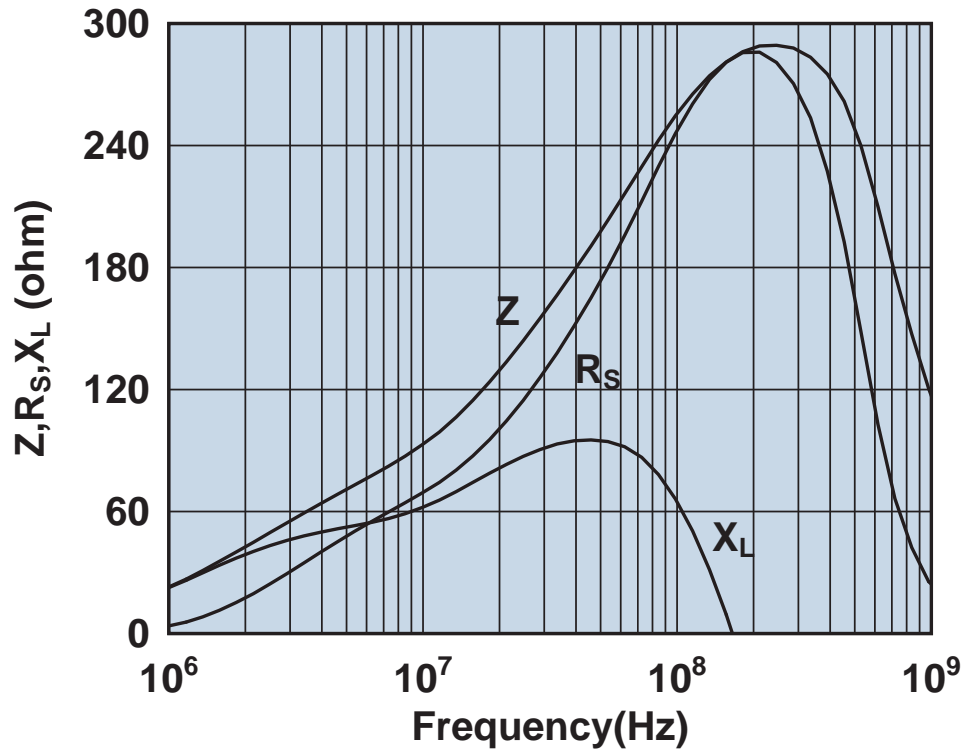

Impedance, reactance, and resistance vs. frequency.

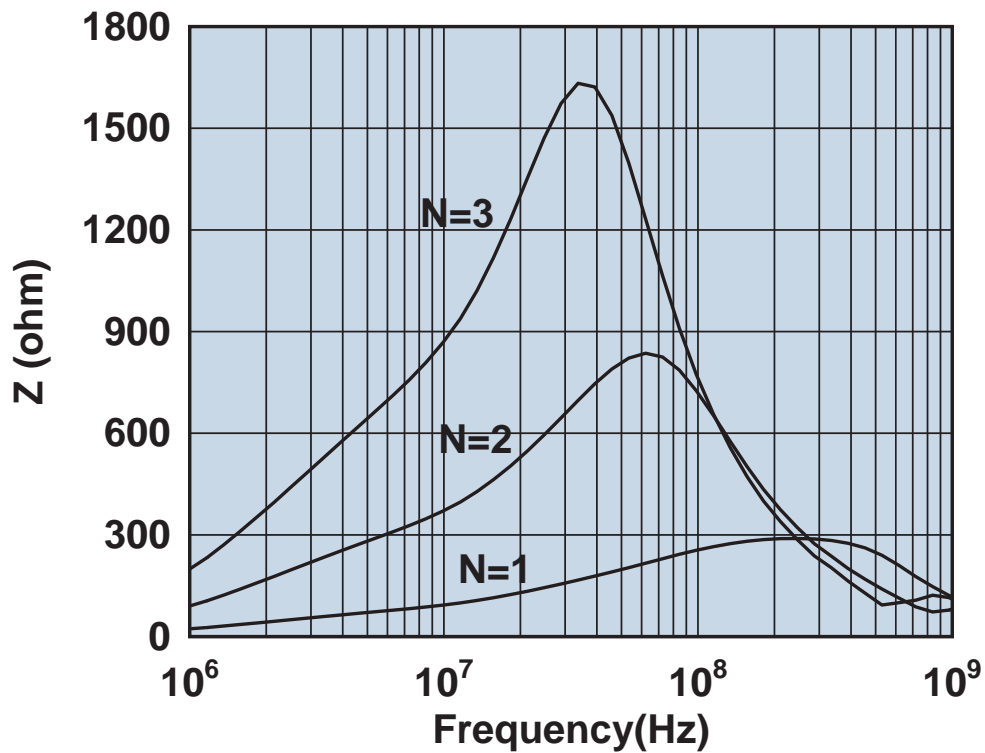

Impedance vs. frequency with one, two, and three turns.

0431164281

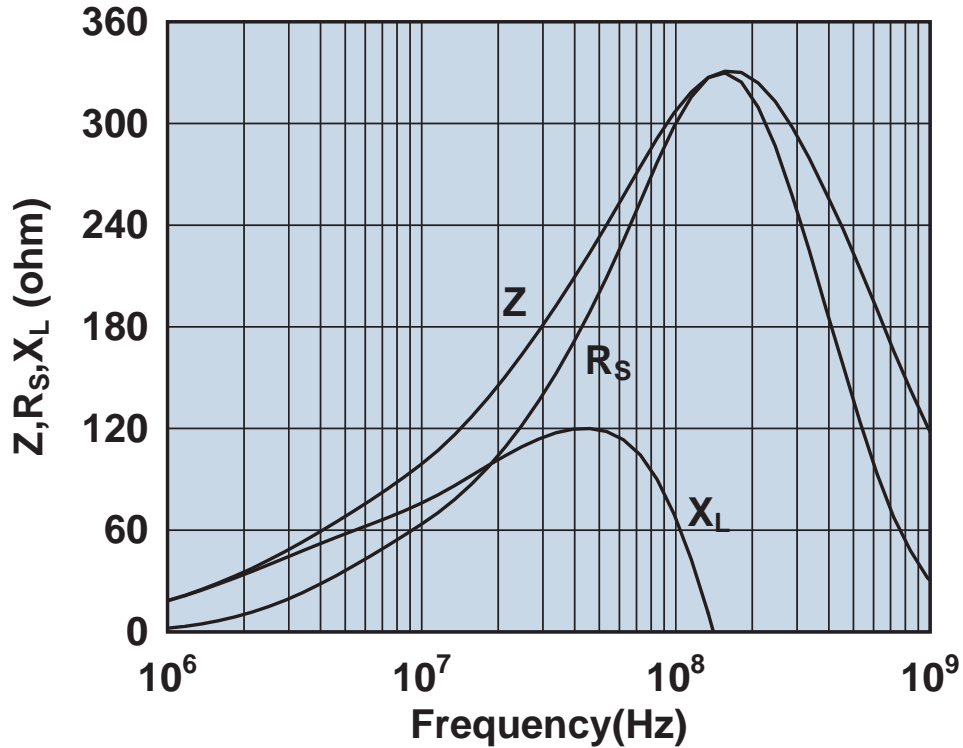

Impedance, reactance, and resistance vs. frequency.

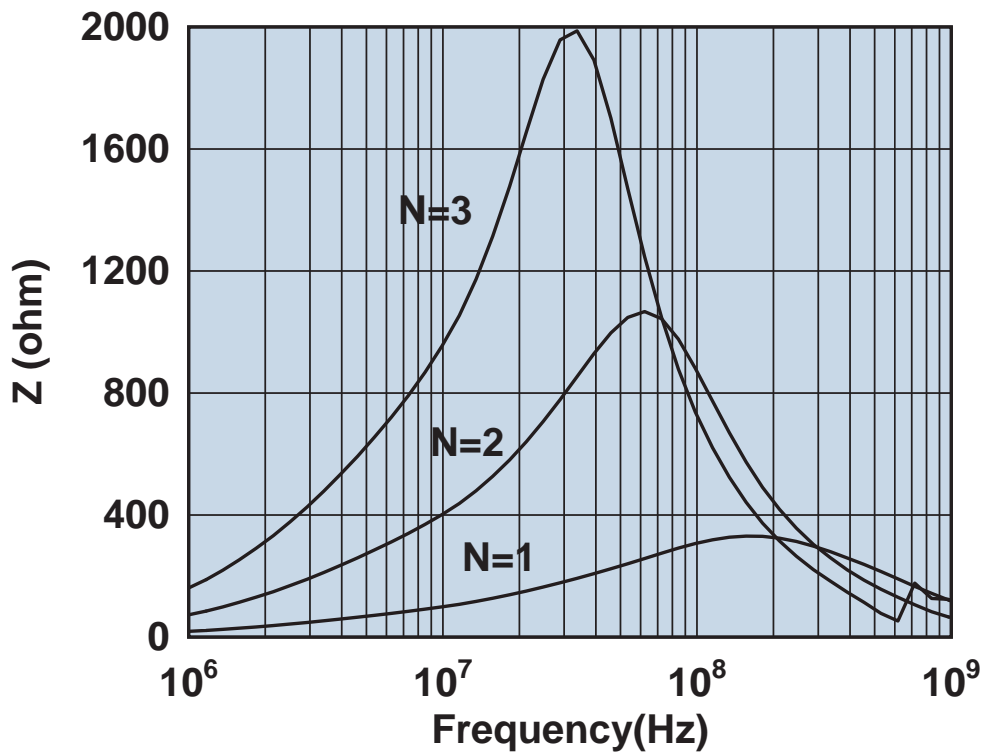

Impedance vs. frequency with one, two, and three turns.

0431164951

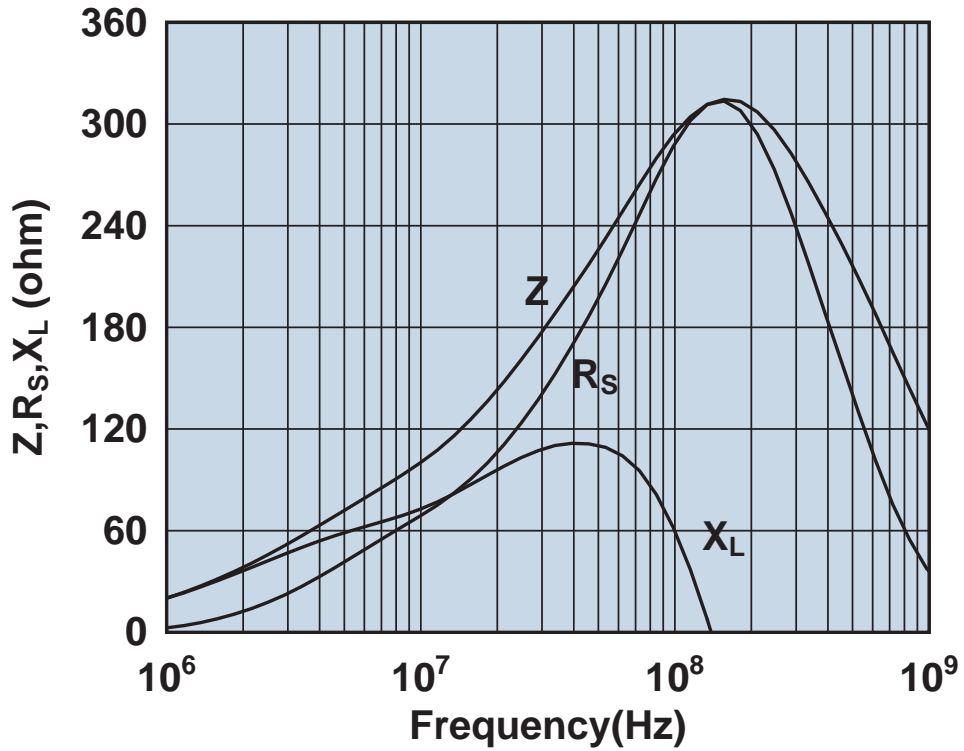

Impedance, reactance, and resistance vs. frequency.

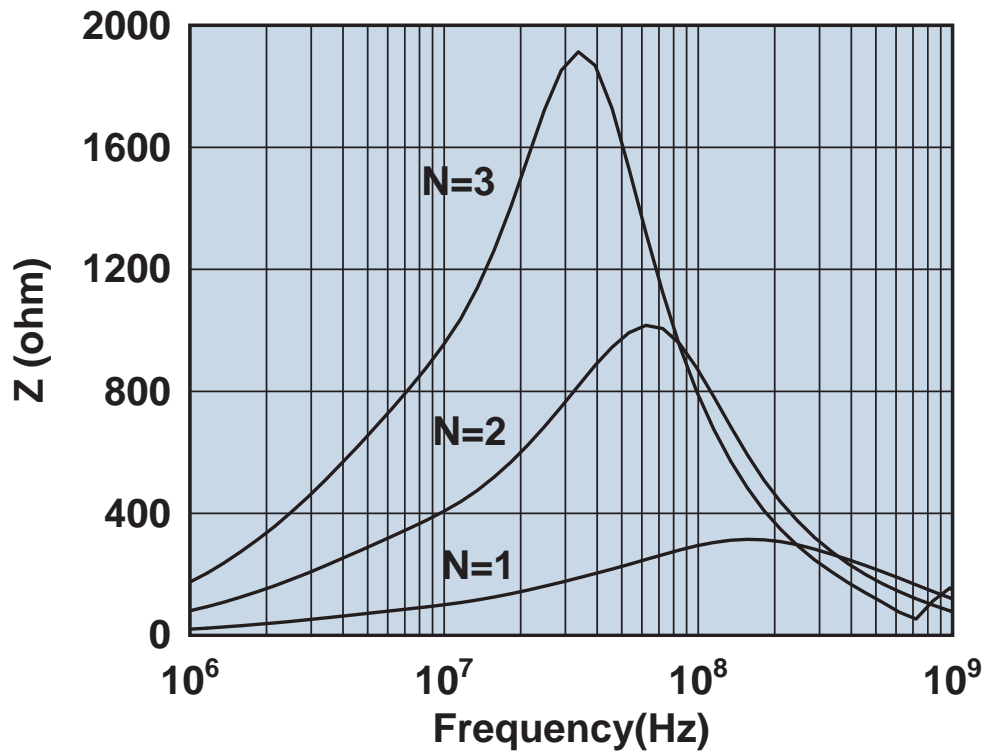

Impedance vs. frequency with one, two, and three turns.

0431167281

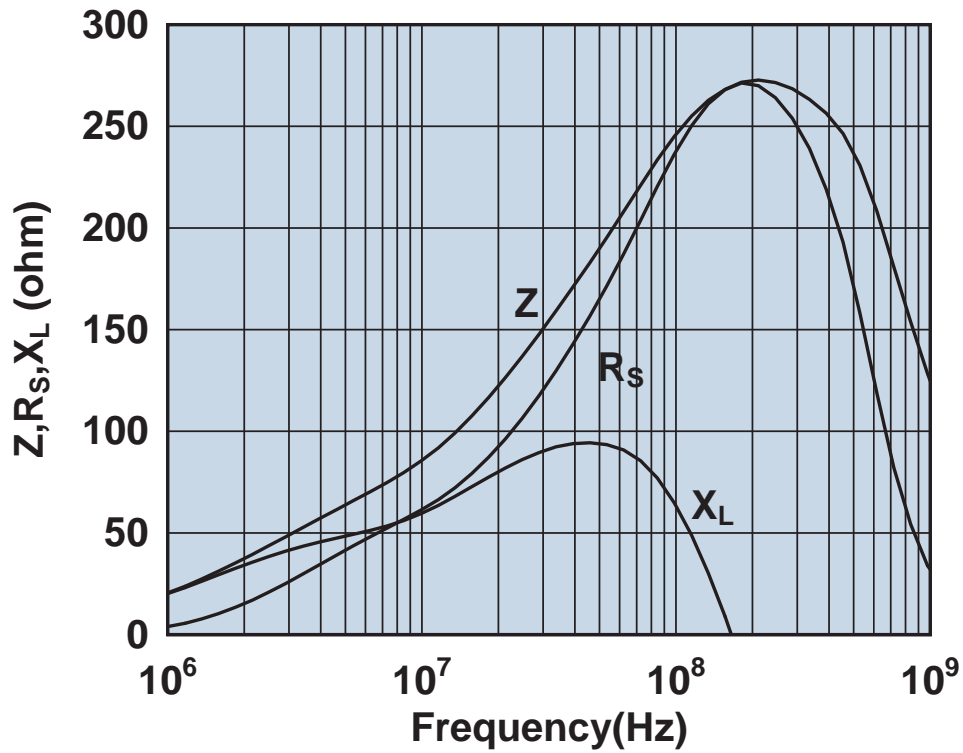

Impedance, reactance, and resistance vs. frequency.

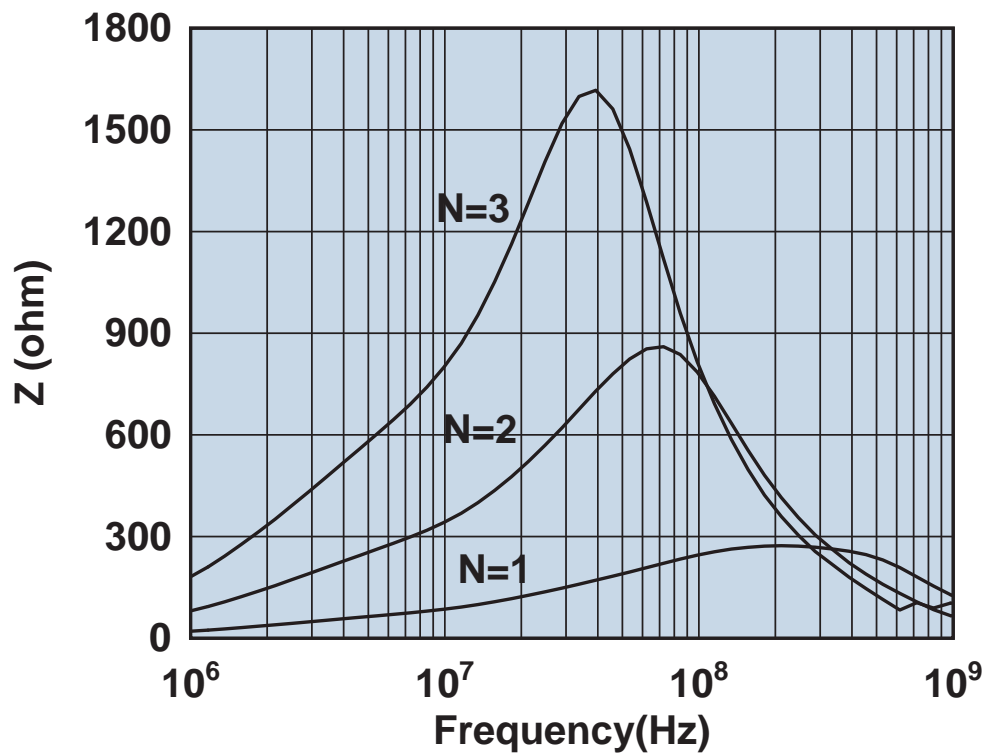

Impedance vs. frequency with one, two, and three turns.

0431173551

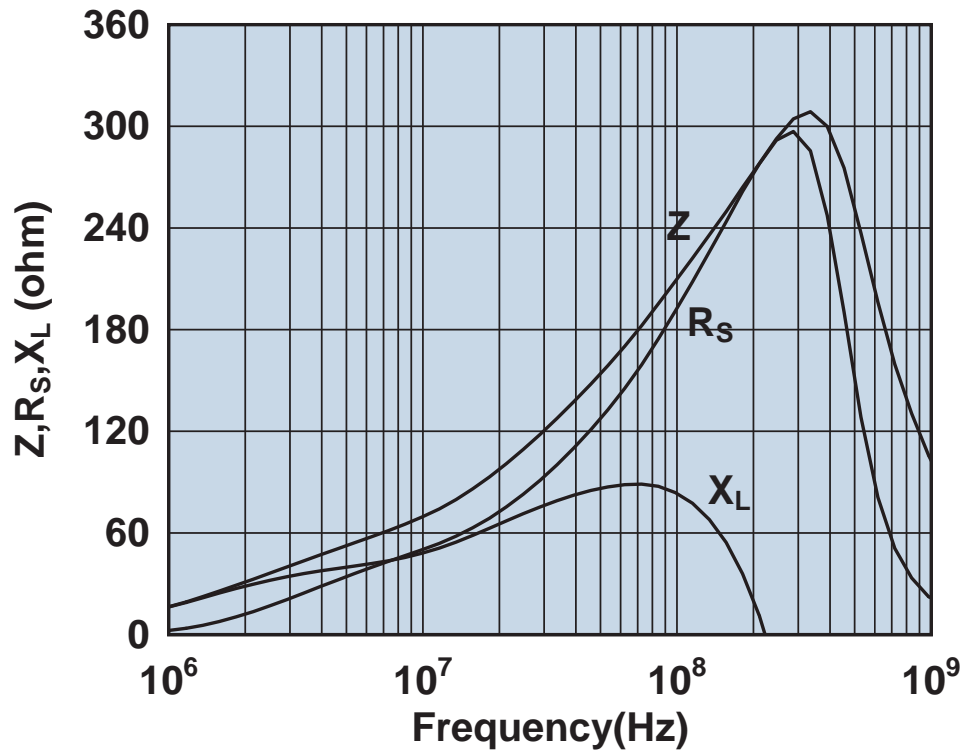

Impedance, reactance, and resistance vs. frequency.

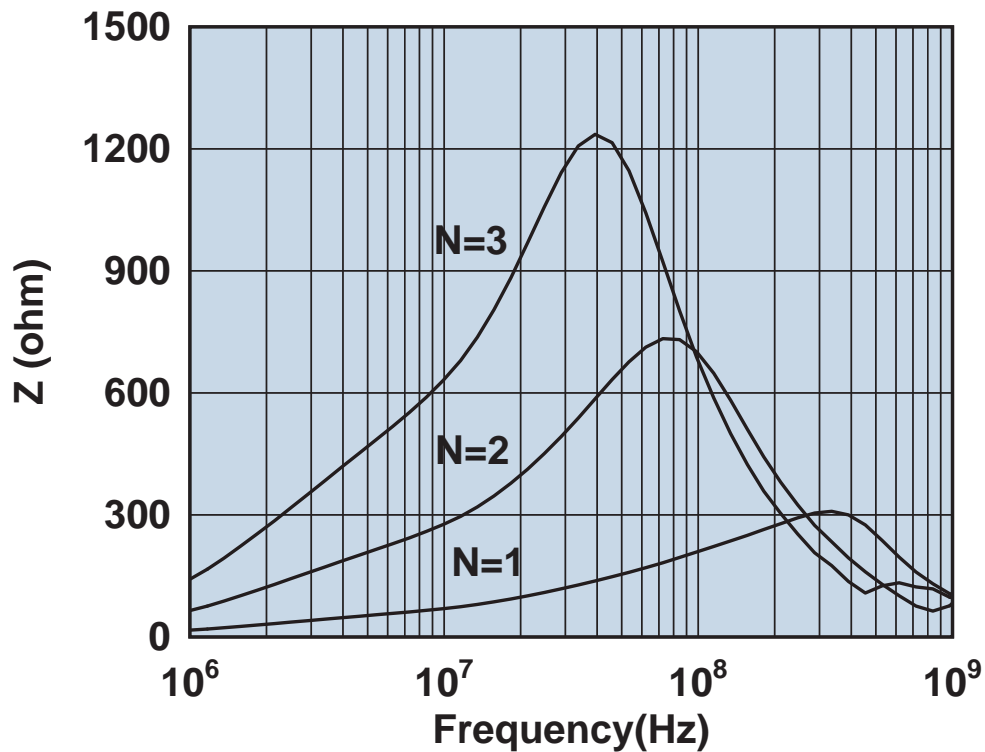

Impedance vs. frequency with one, two, and three turns.

0431173951

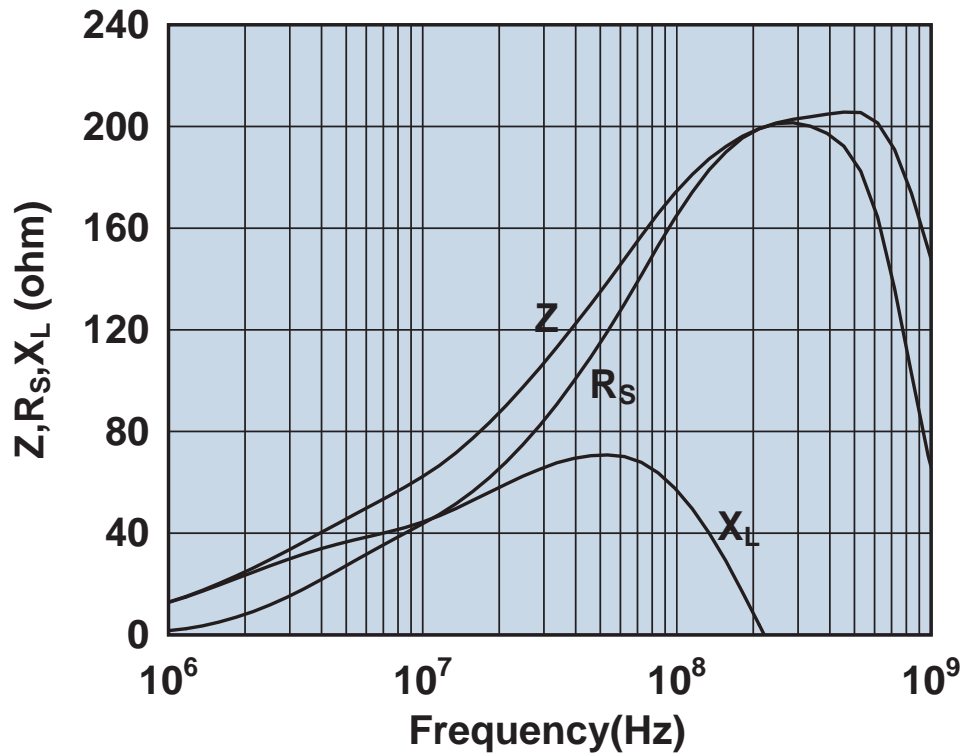

Impedance, reactance, and resistance vs. frequency.

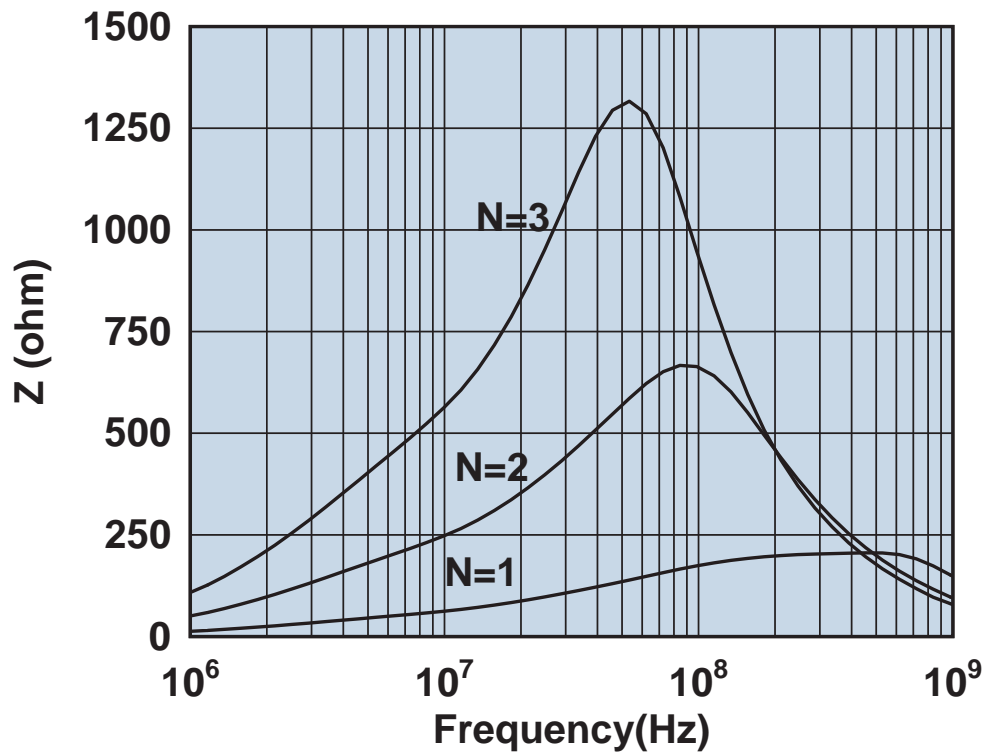

Impedance vs. frequency with one, two, and three turns.

0431176451

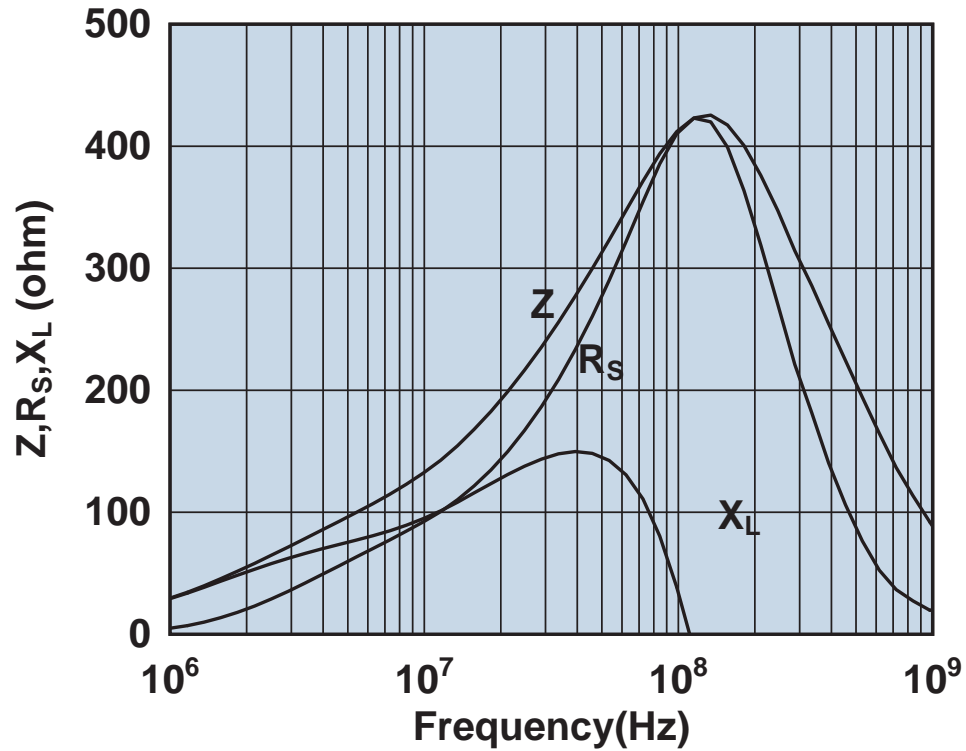

Impedance, reactance, and resistance vs. frequency.

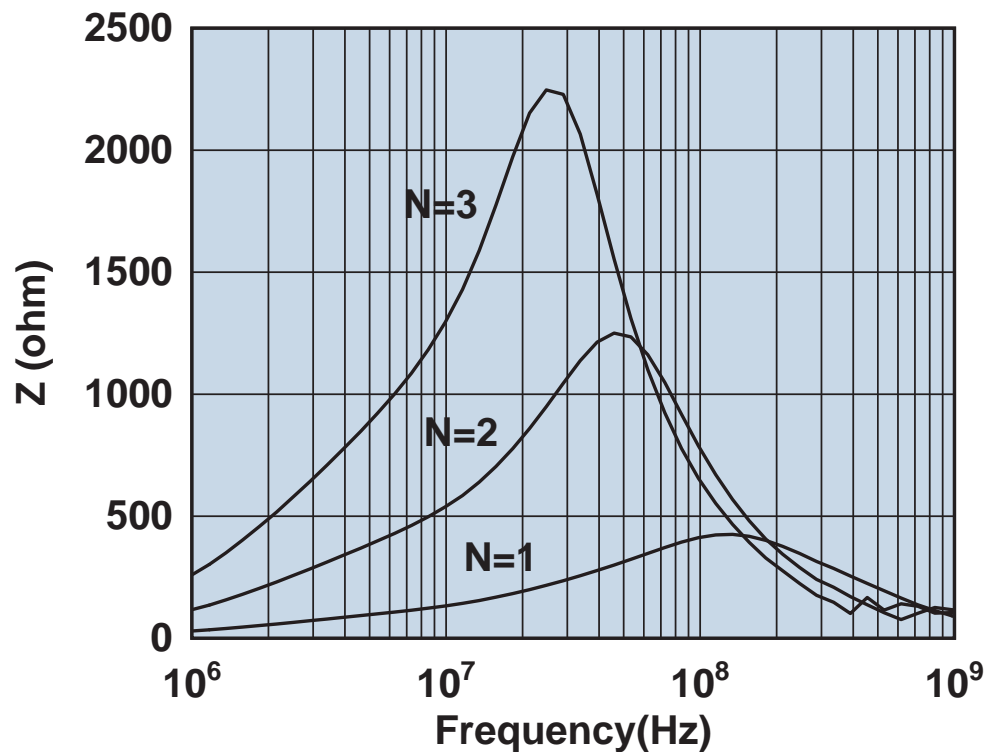

Impedance vs. frequency with one, two, and three turns.

0431177081

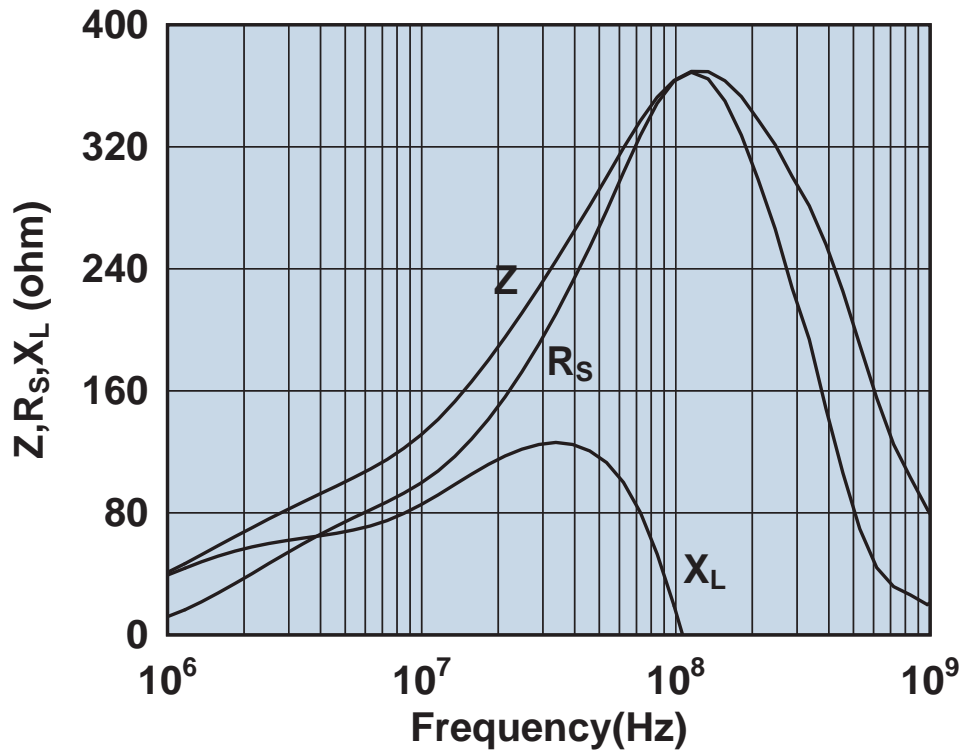

Impedance, reactance, and resistance vs. frequency.

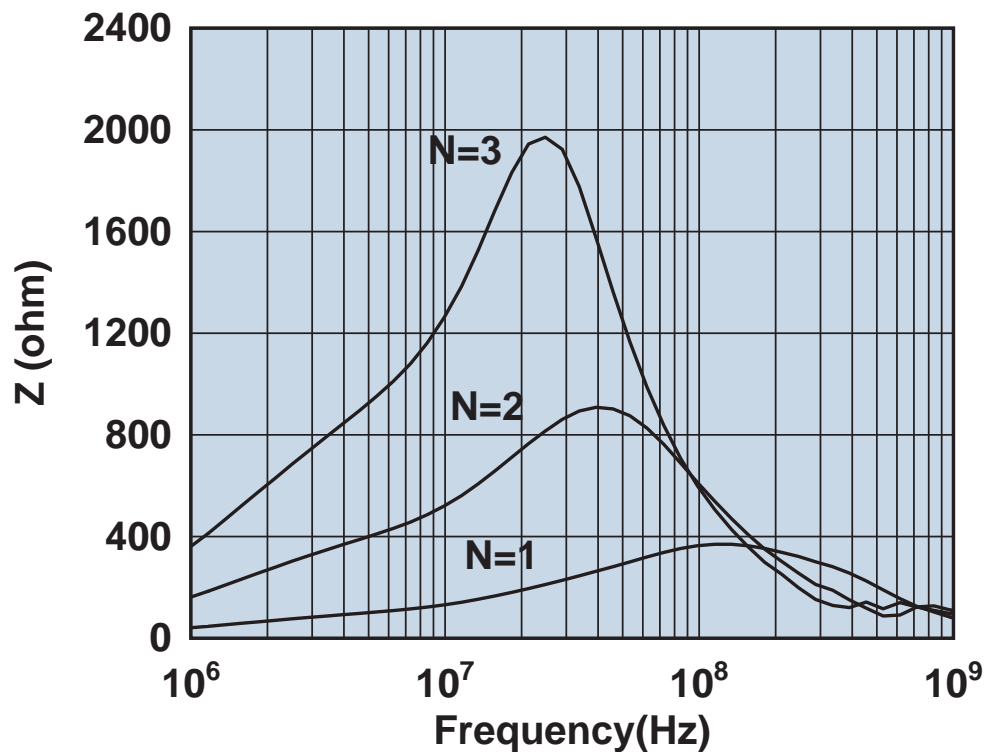

Impedance vs. frequency with one, two, and three turns.

0431178181

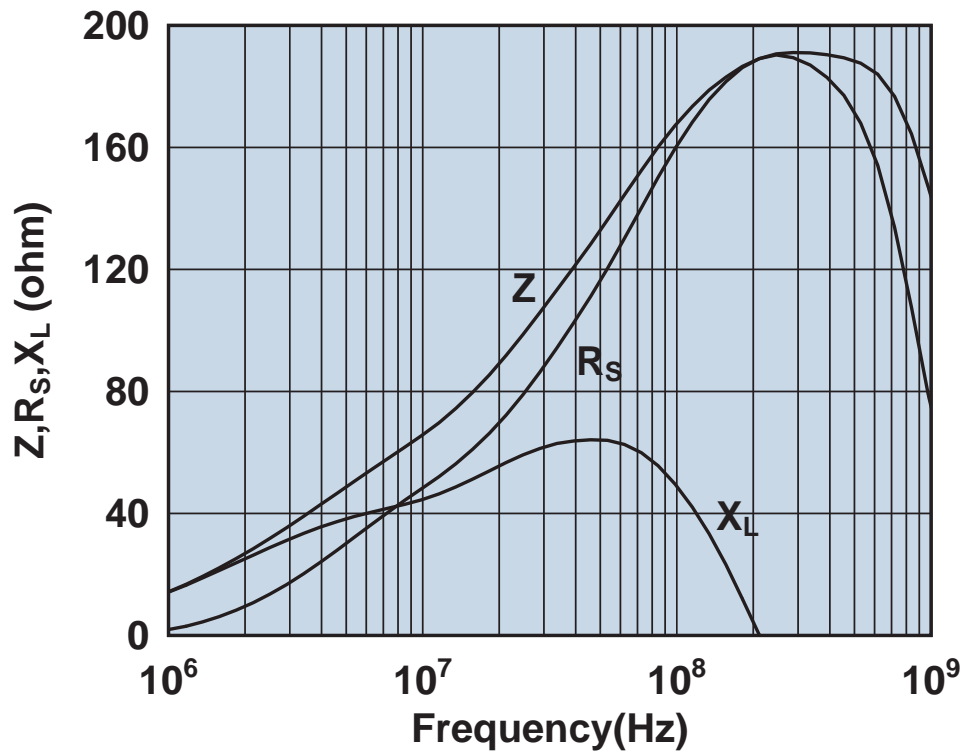

Impedance, reactance, and resistance vs. frequency.

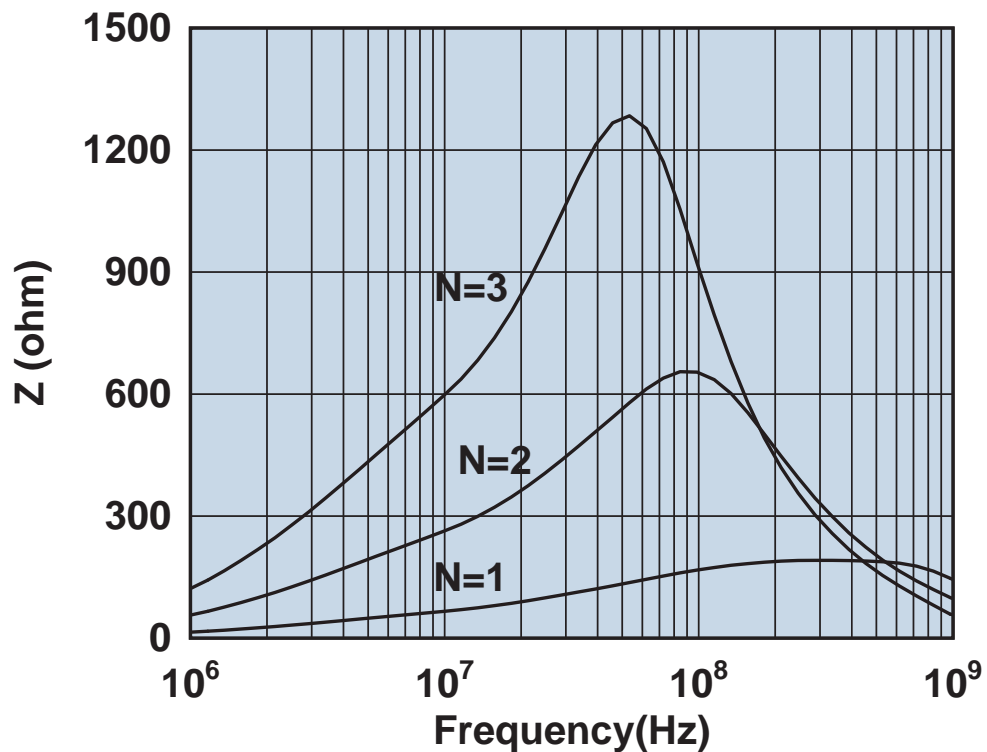

Impedance vs. frequency with one, two, and three turns.

0431178281

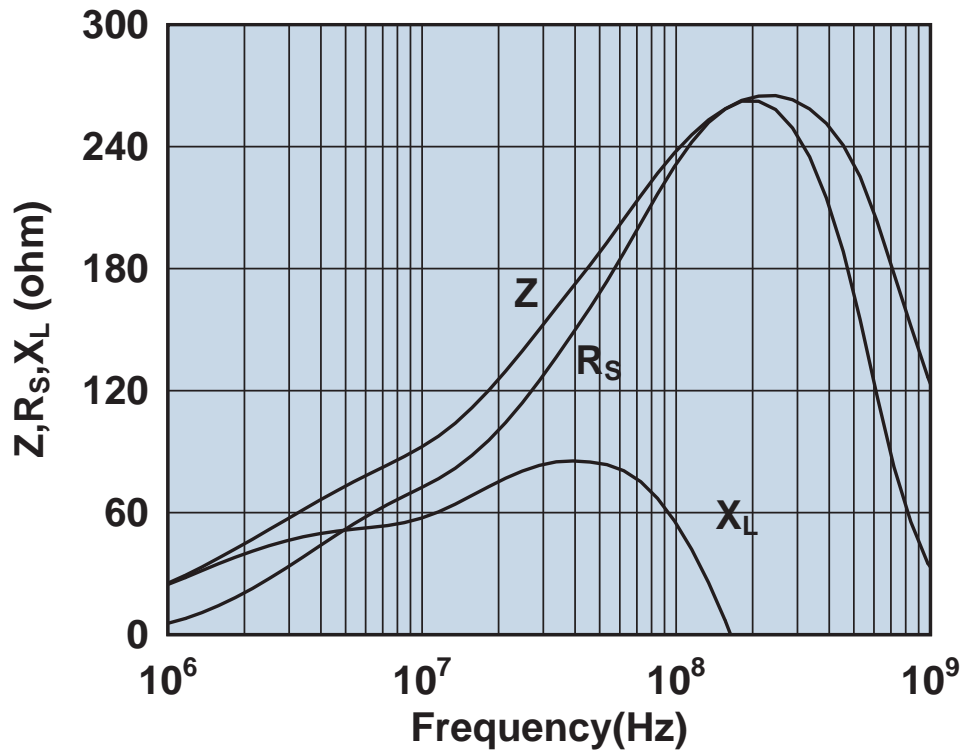

Impedance, reactance, and resistance vs. frequency.

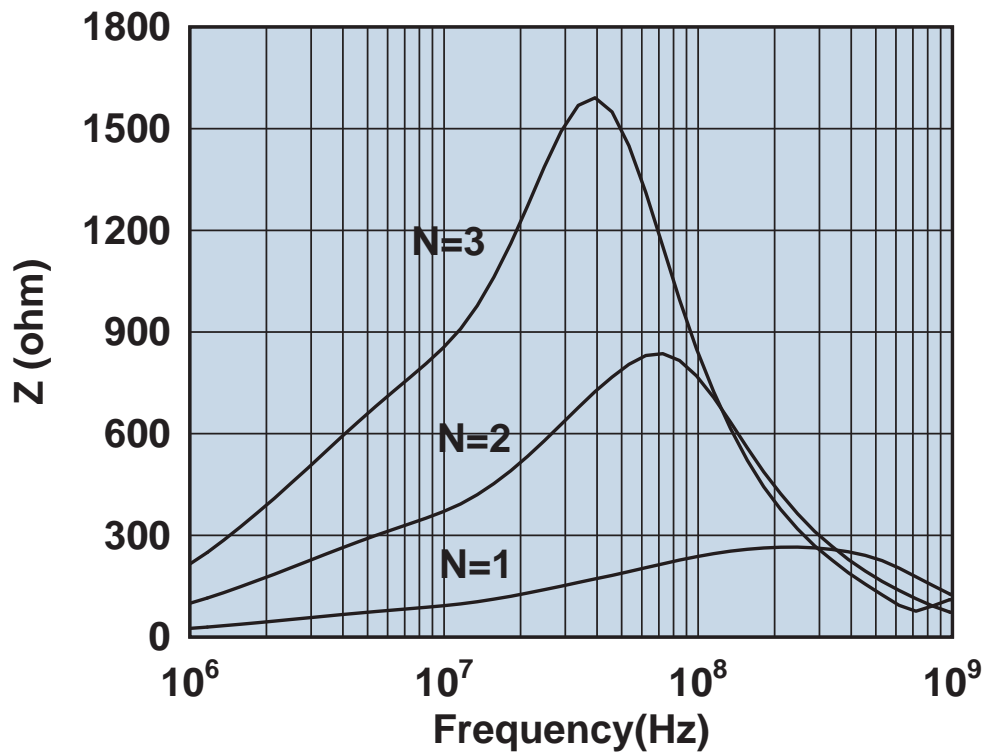

Impedance vs. frequency with one, two, and three turns.

0443163951

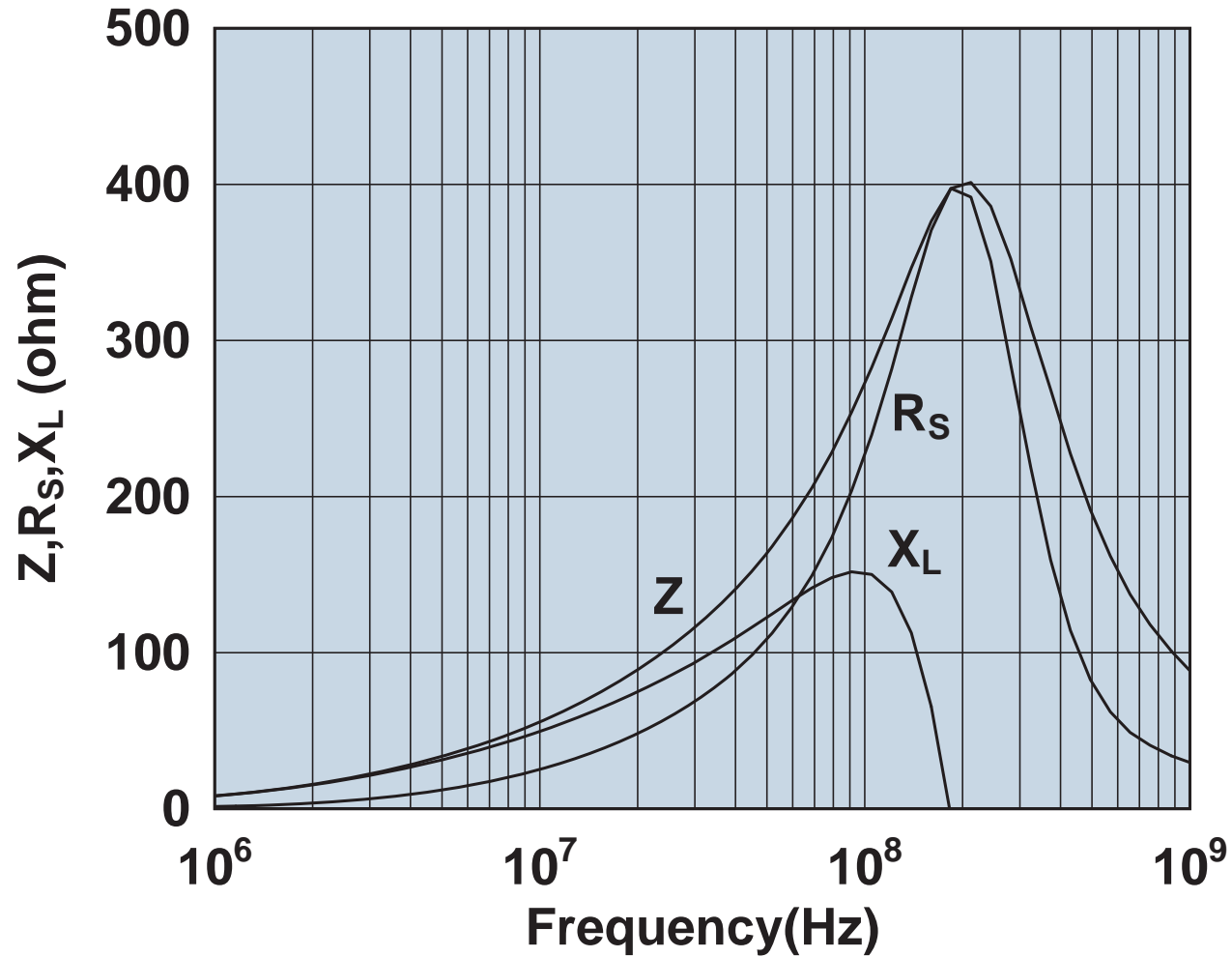

Impedance, reactance, and resistance vs. frequency.

0443164051

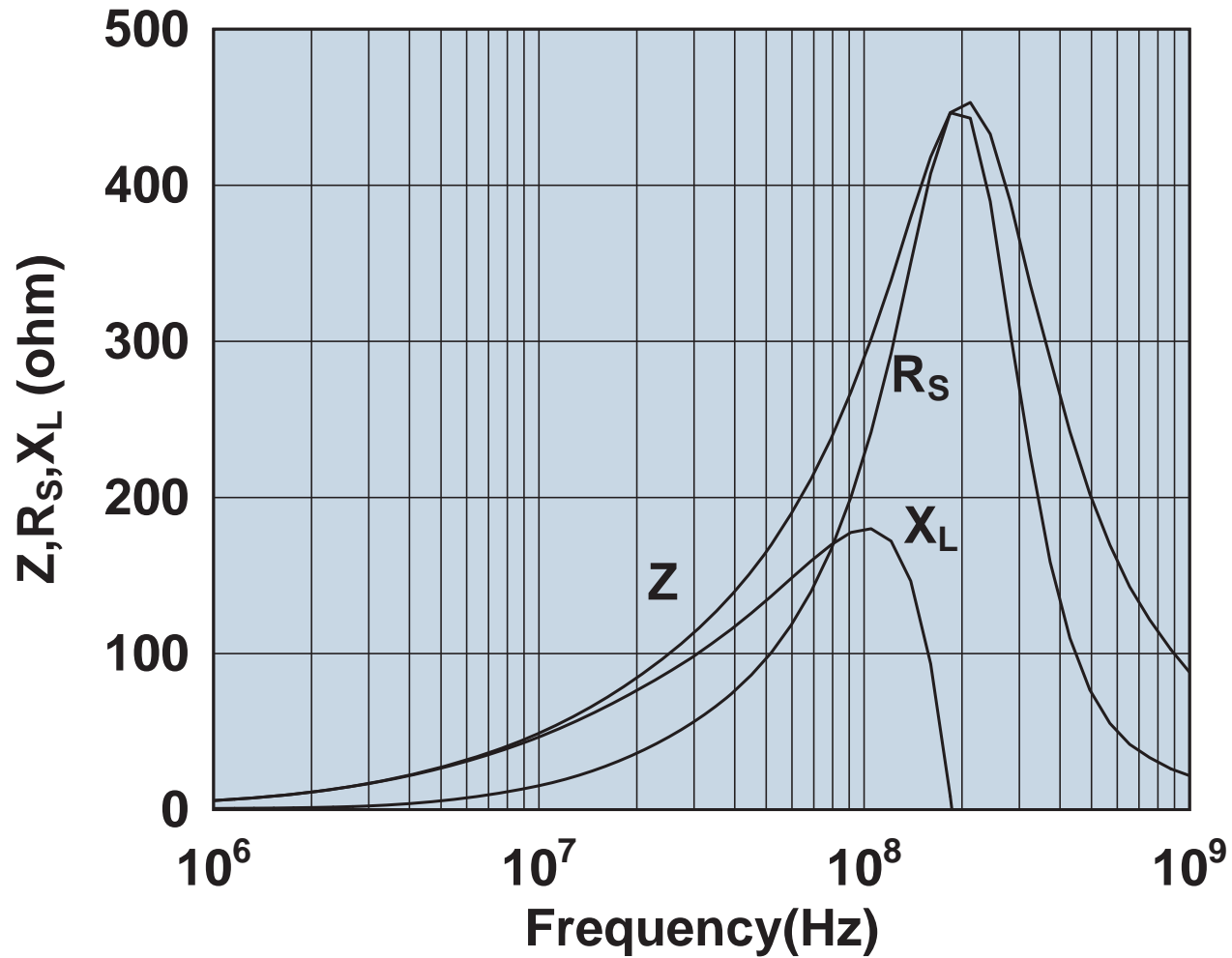

Impedance, reactance, and resistance vs. frequency.

0443164151

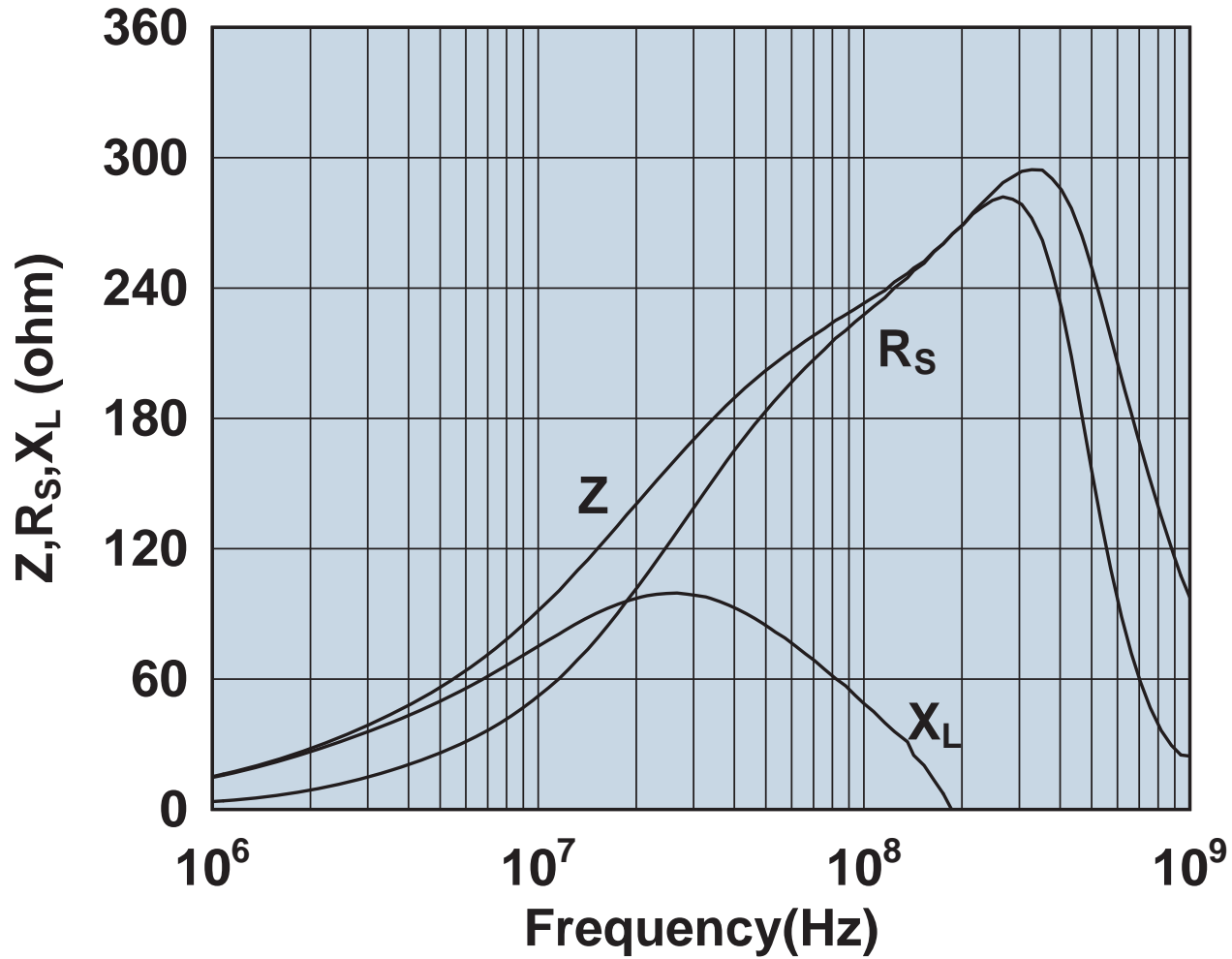

Impedance, reactance, and resistance vs. frequency.

0443164251

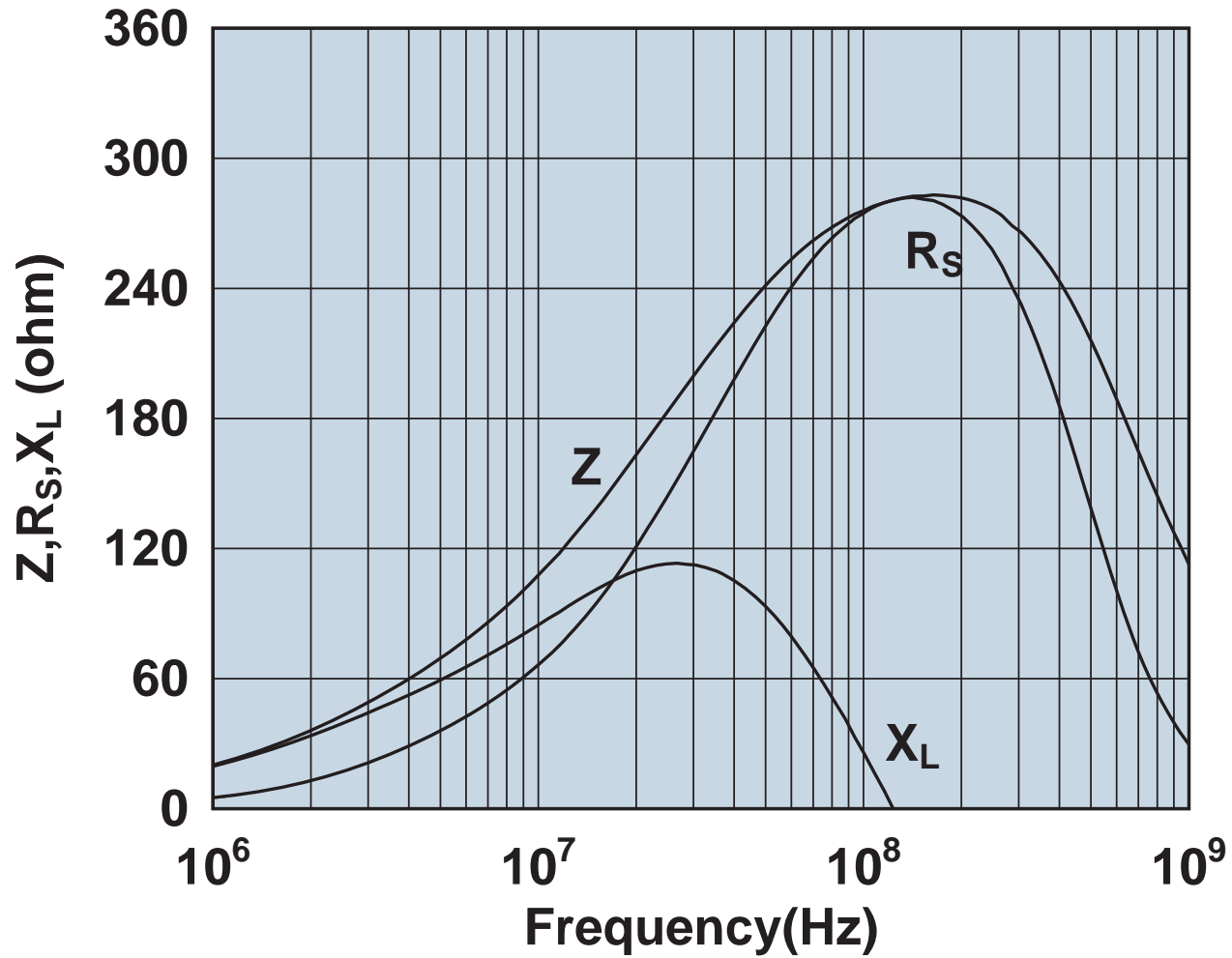

Impedance, reactance, and resistance vs. frequency.

0443166651



Impedance, reactance, and resistance vs. frequency.

0443167251

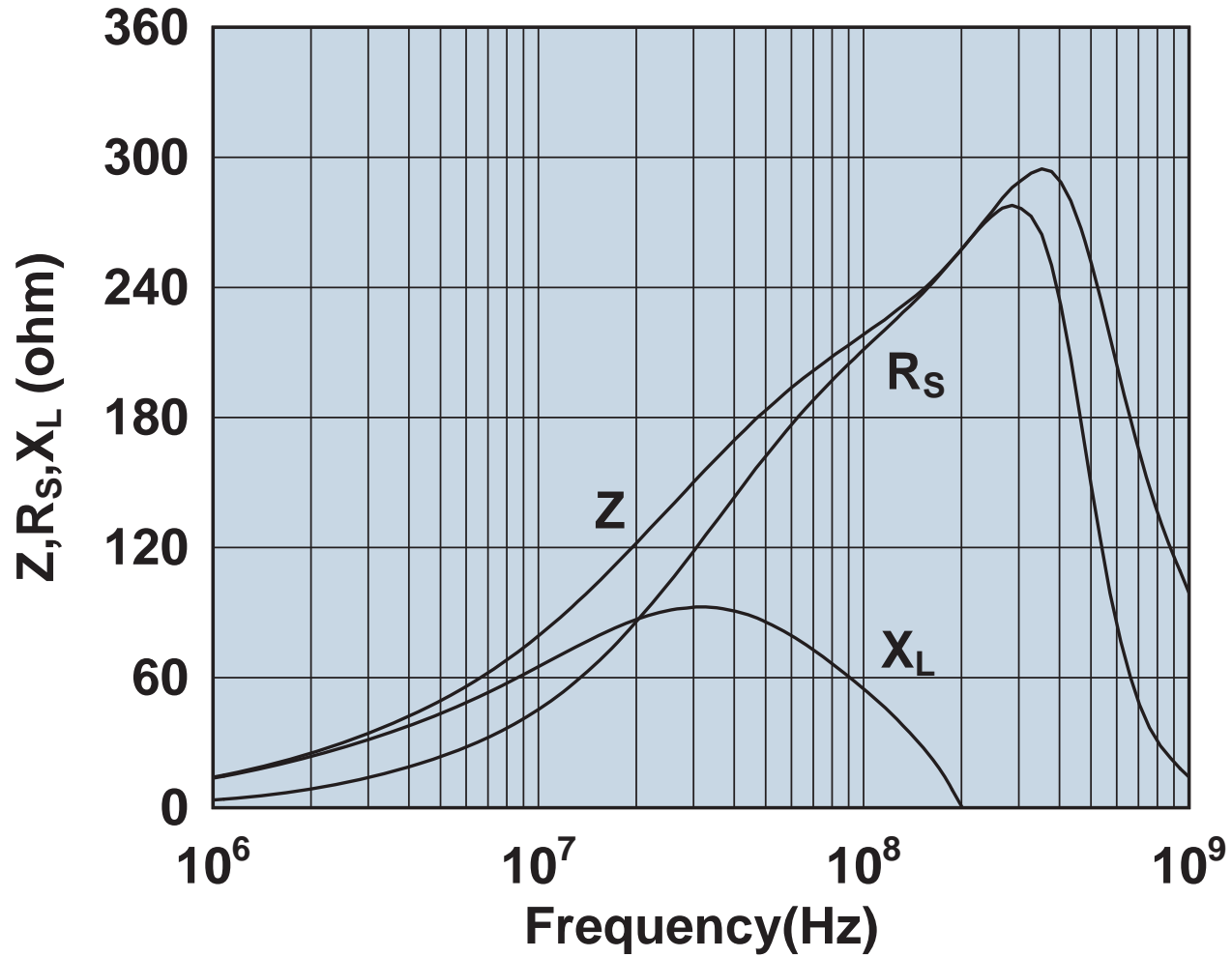

Impedance, reactance, and resistance vs. frequency.

0443178181

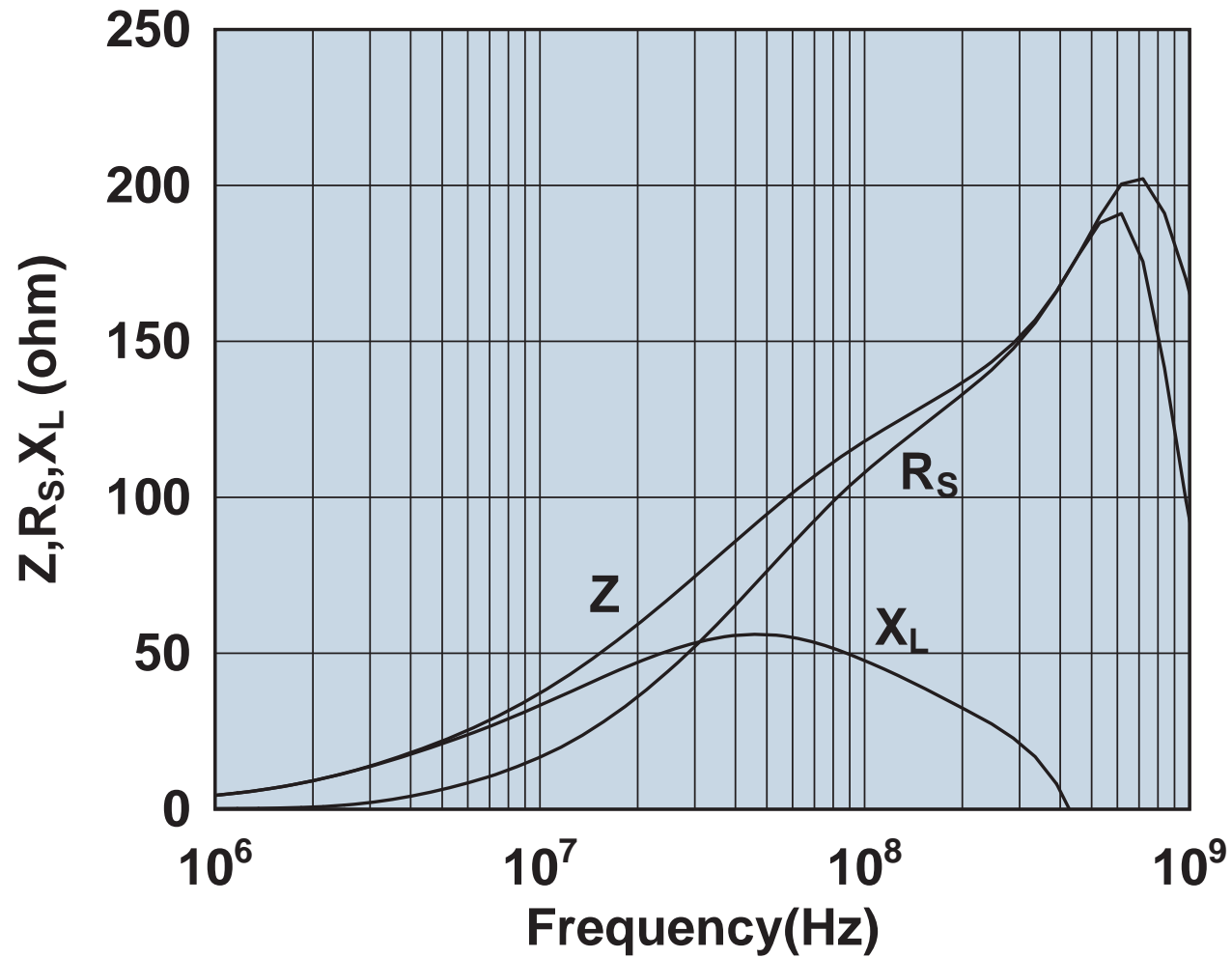

Impedance, reactance, and resistance vs. frequency.

0443178281

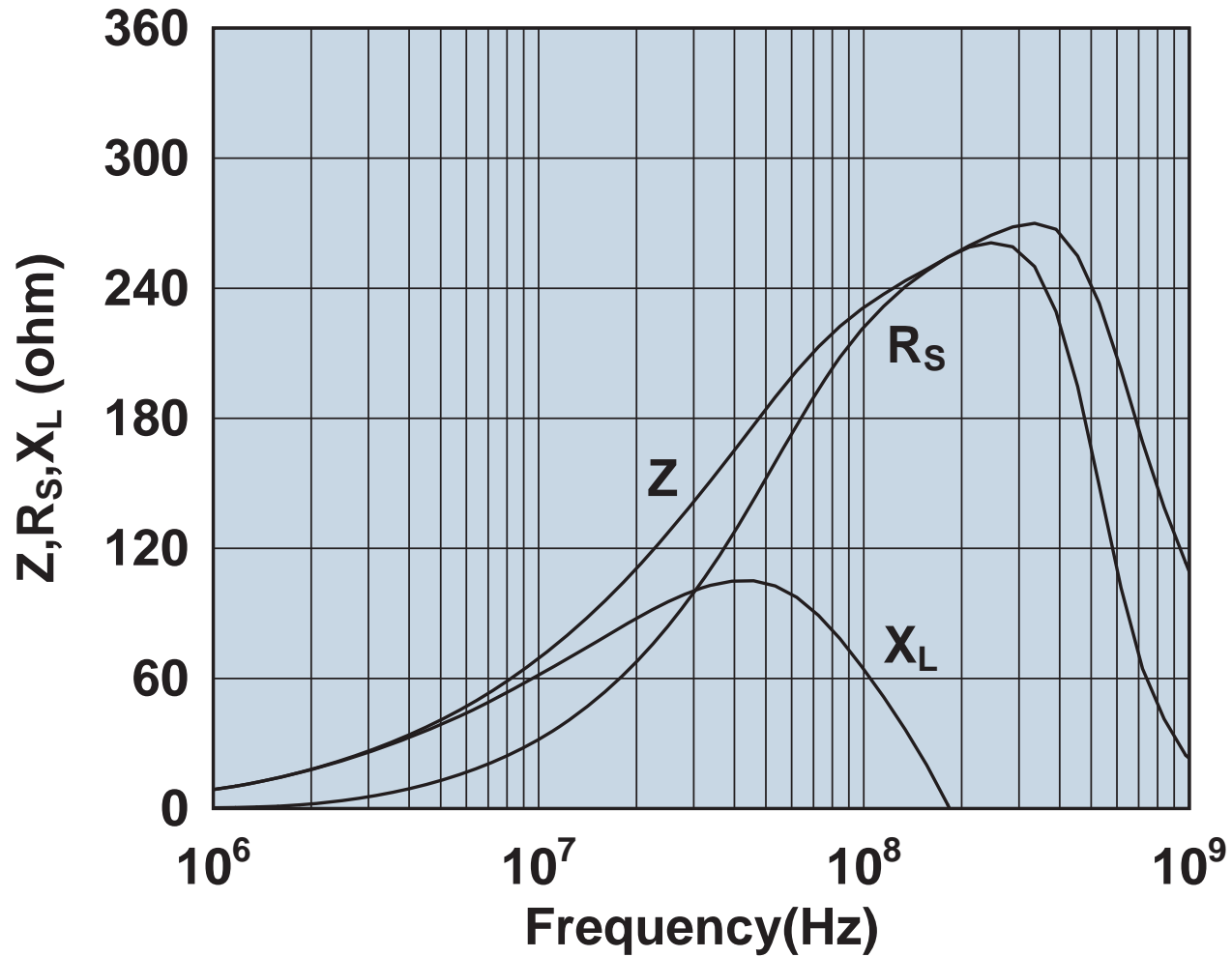

Impedance, reactance, and resistance vs. frequency.

0443625006

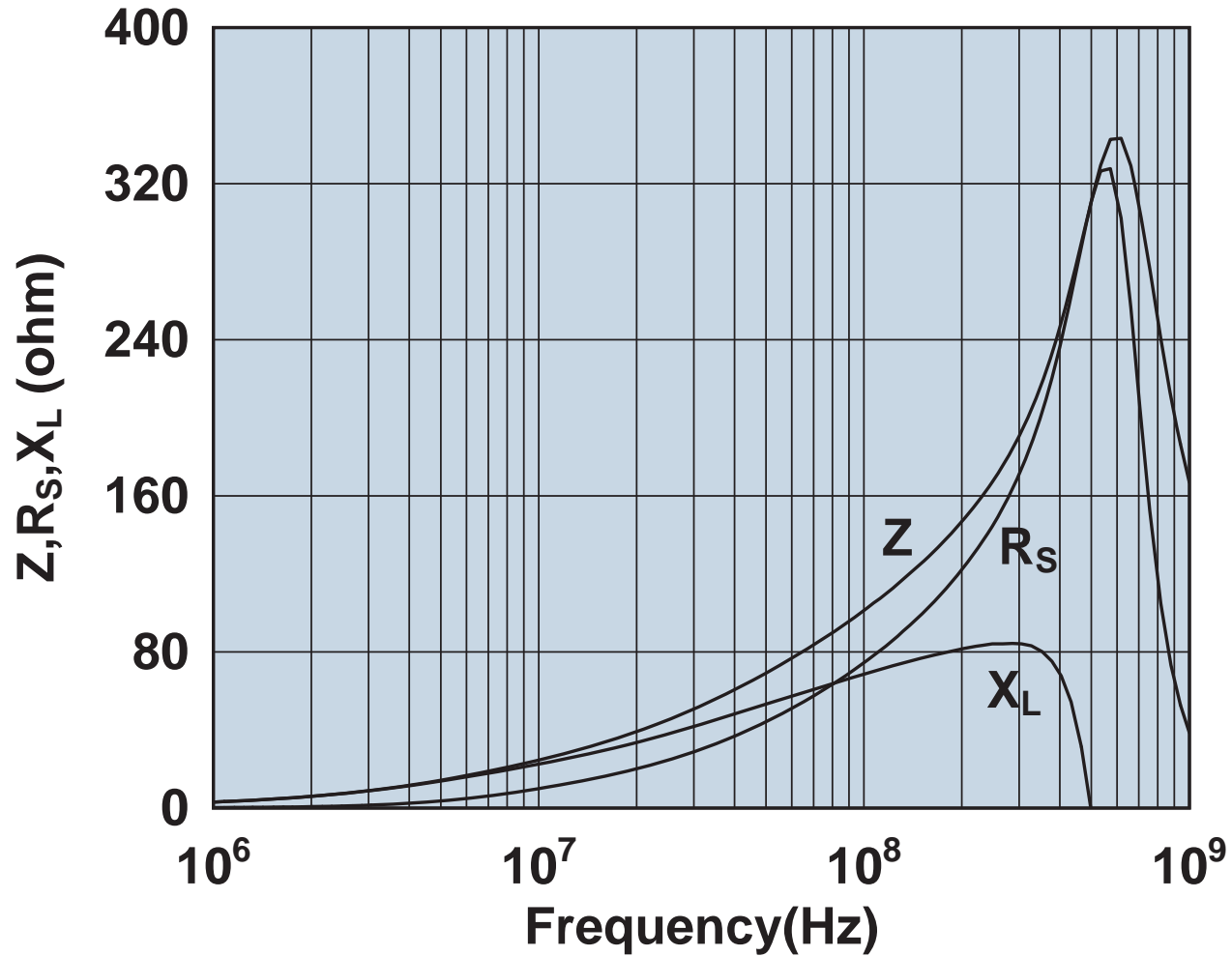

Impedance, reactance, and resistance vs. frequency.

0443665806

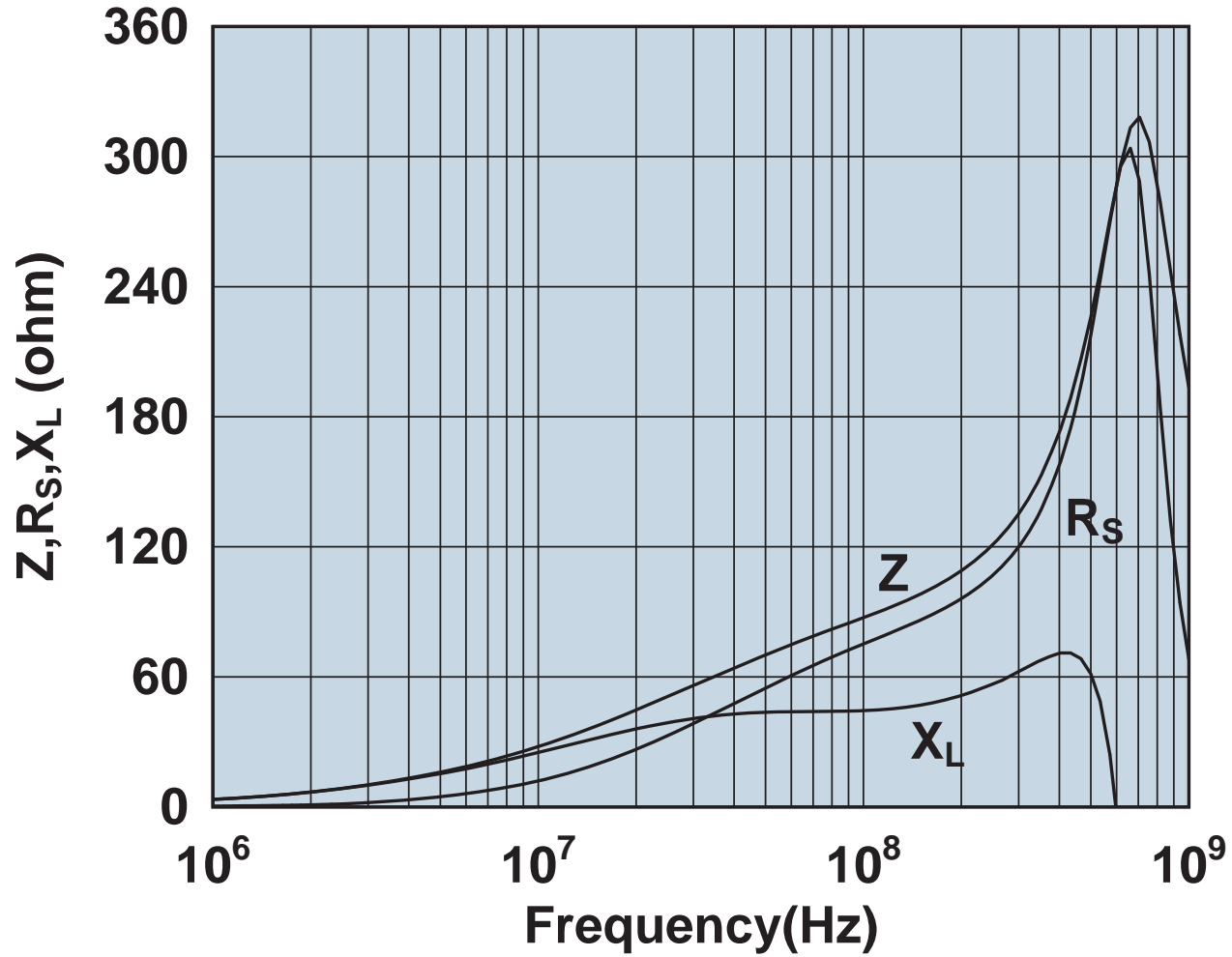

Impedance, reactance, and resistance vs. frequency.

0443800506



Impedance, reactance, and resistance vs. frequency.

0443806406

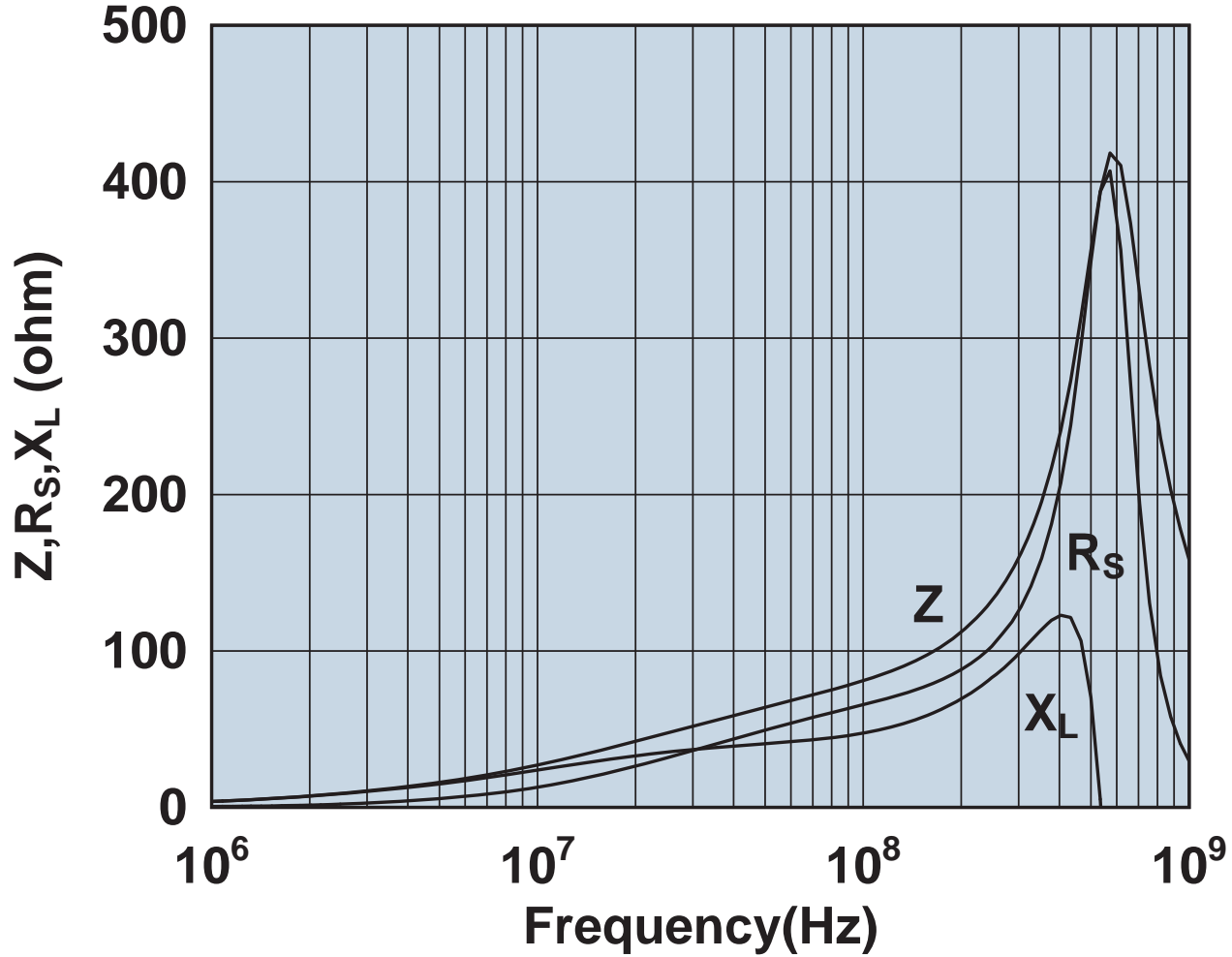

Impedance, reactance, and resistance vs. frequency.

0444164181

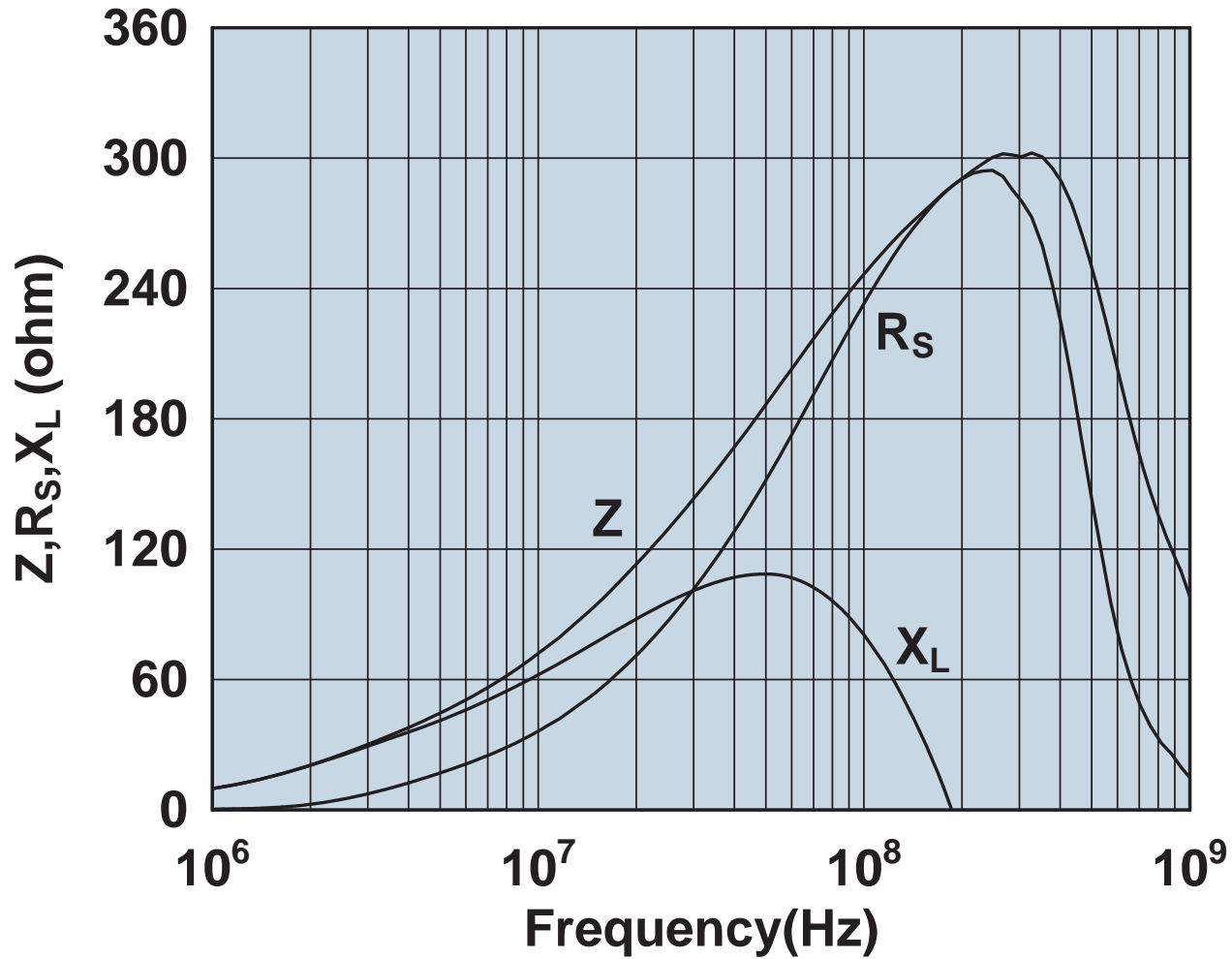

Impedance, reactance, and resistance vs. frequency.

0444164281

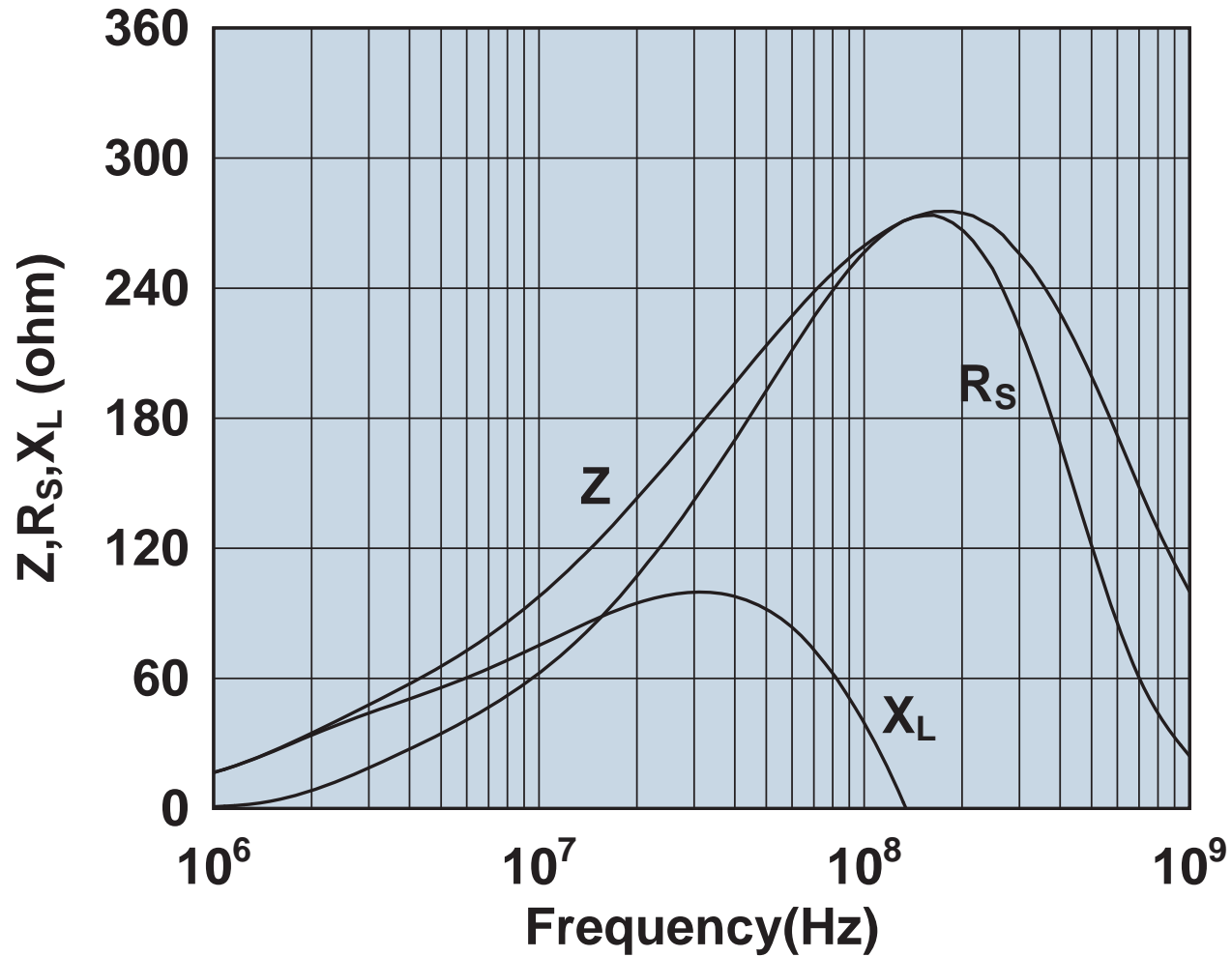

Impedance, reactance, and resistance vs. frequency.

0444164951

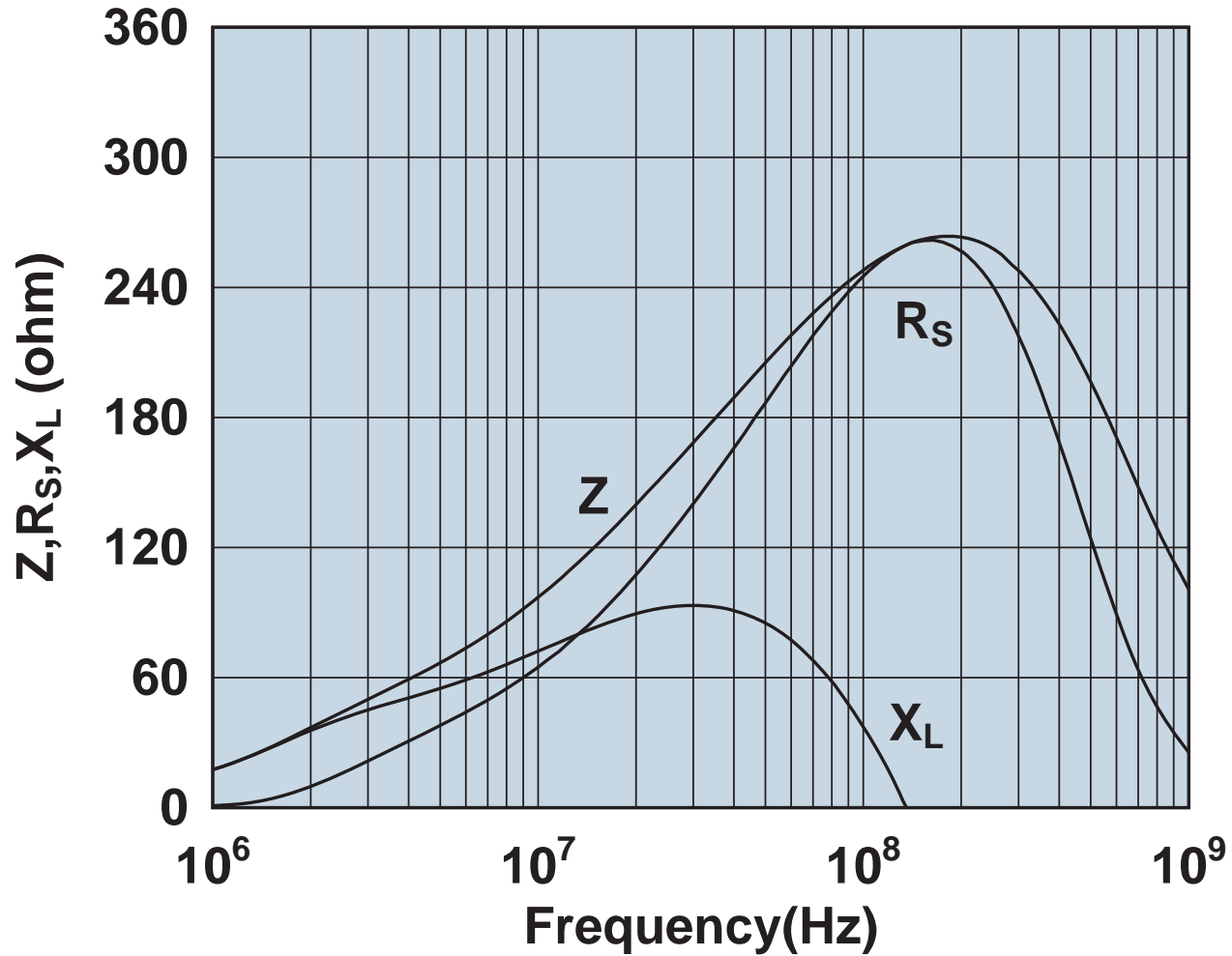

Impedance, reactance, and resistance vs. frequency.

0444167281

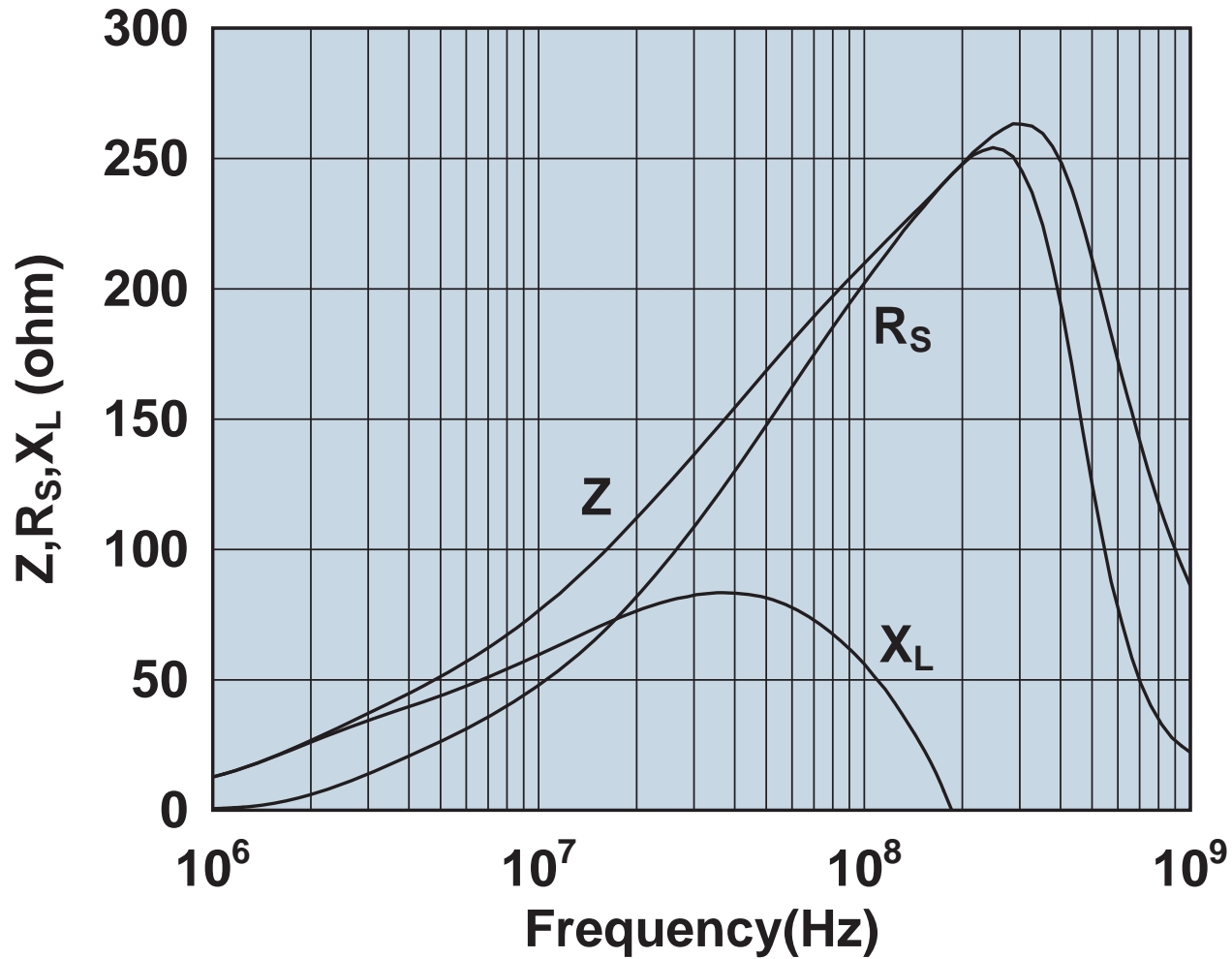

Impedance, reactance, and resistance vs. frequency.

0444173551

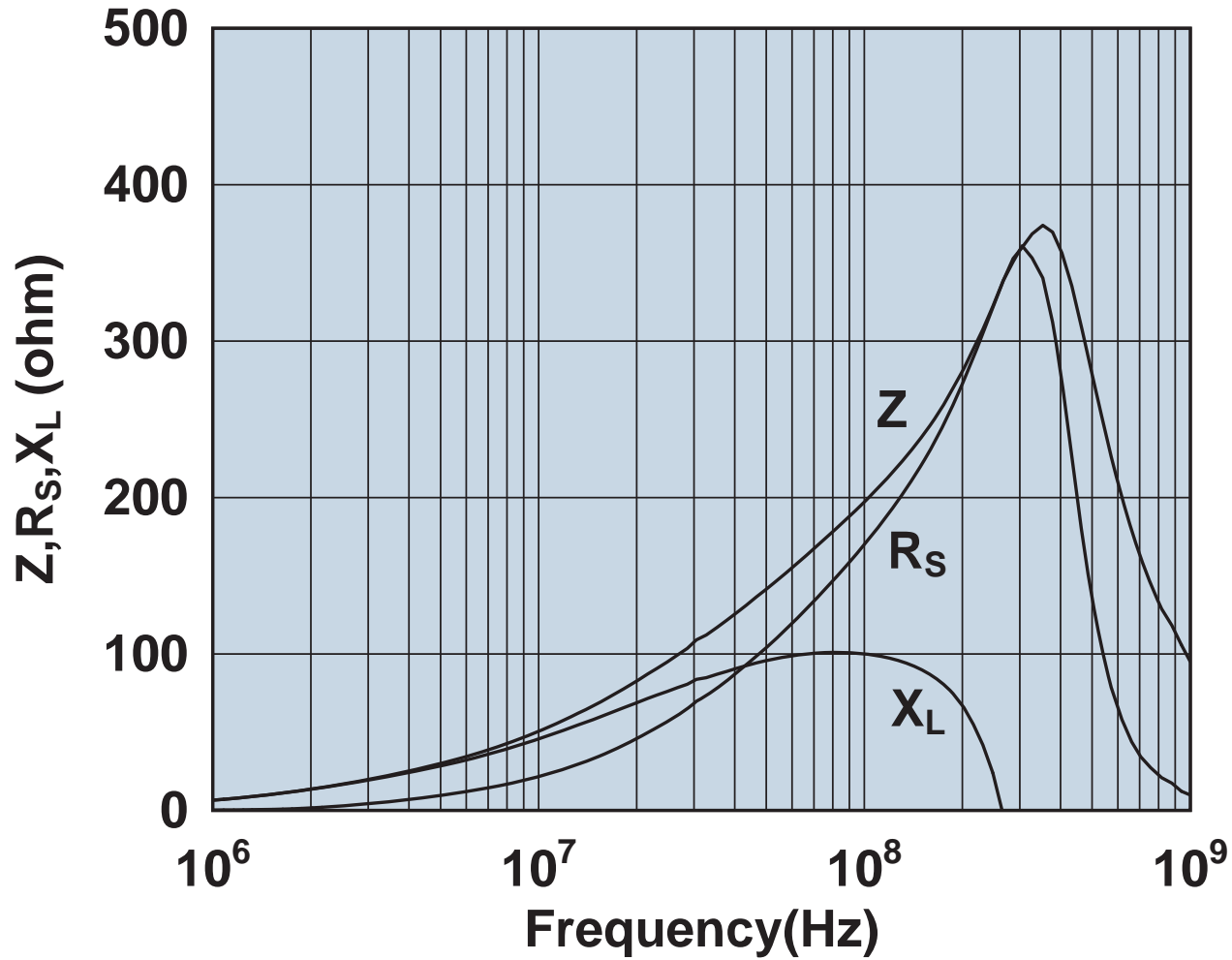

Impedance, reactance, and resistance vs. frequency.

0444173951

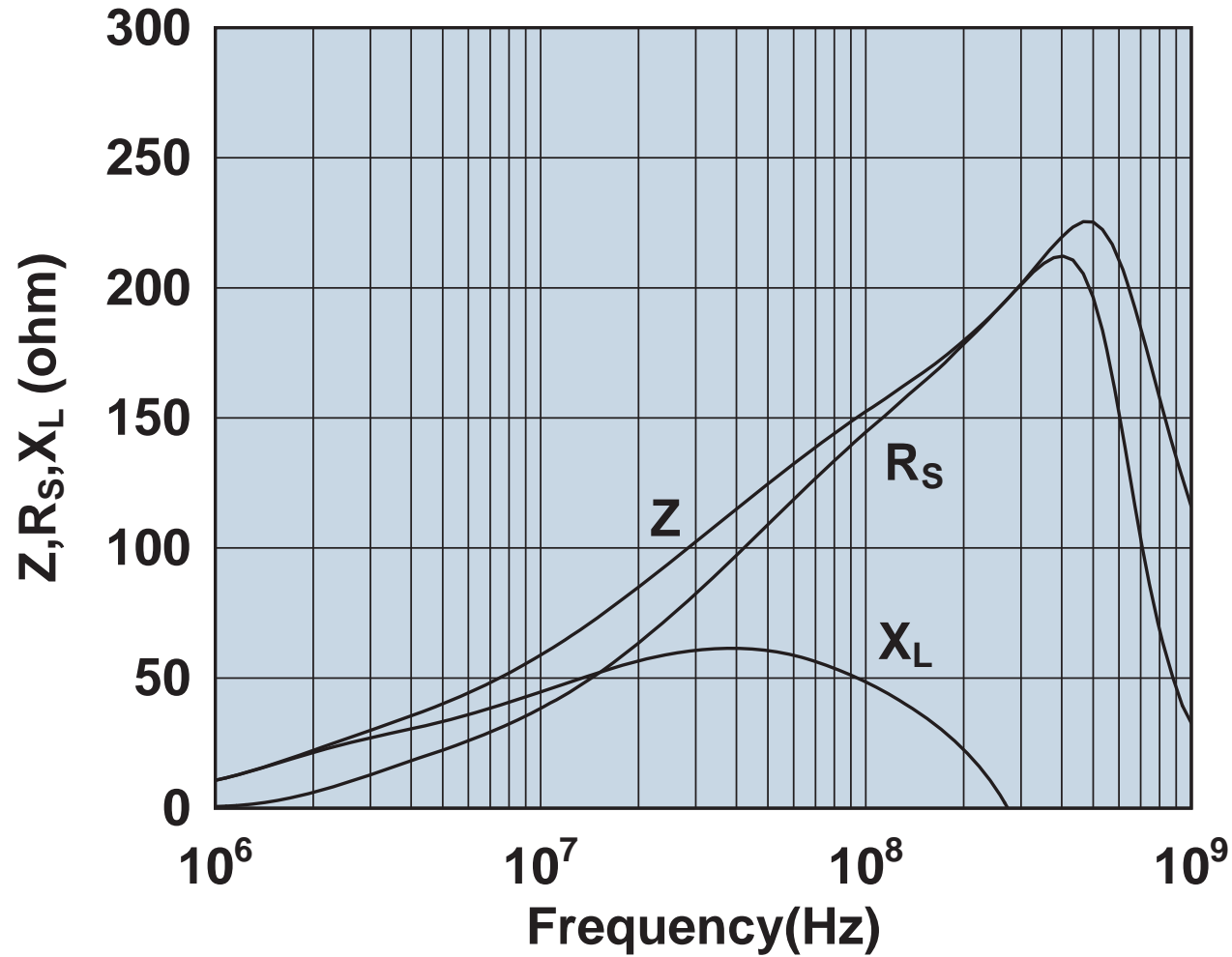

Impedance, reactance, and resistance vs. frequency.

0444176451

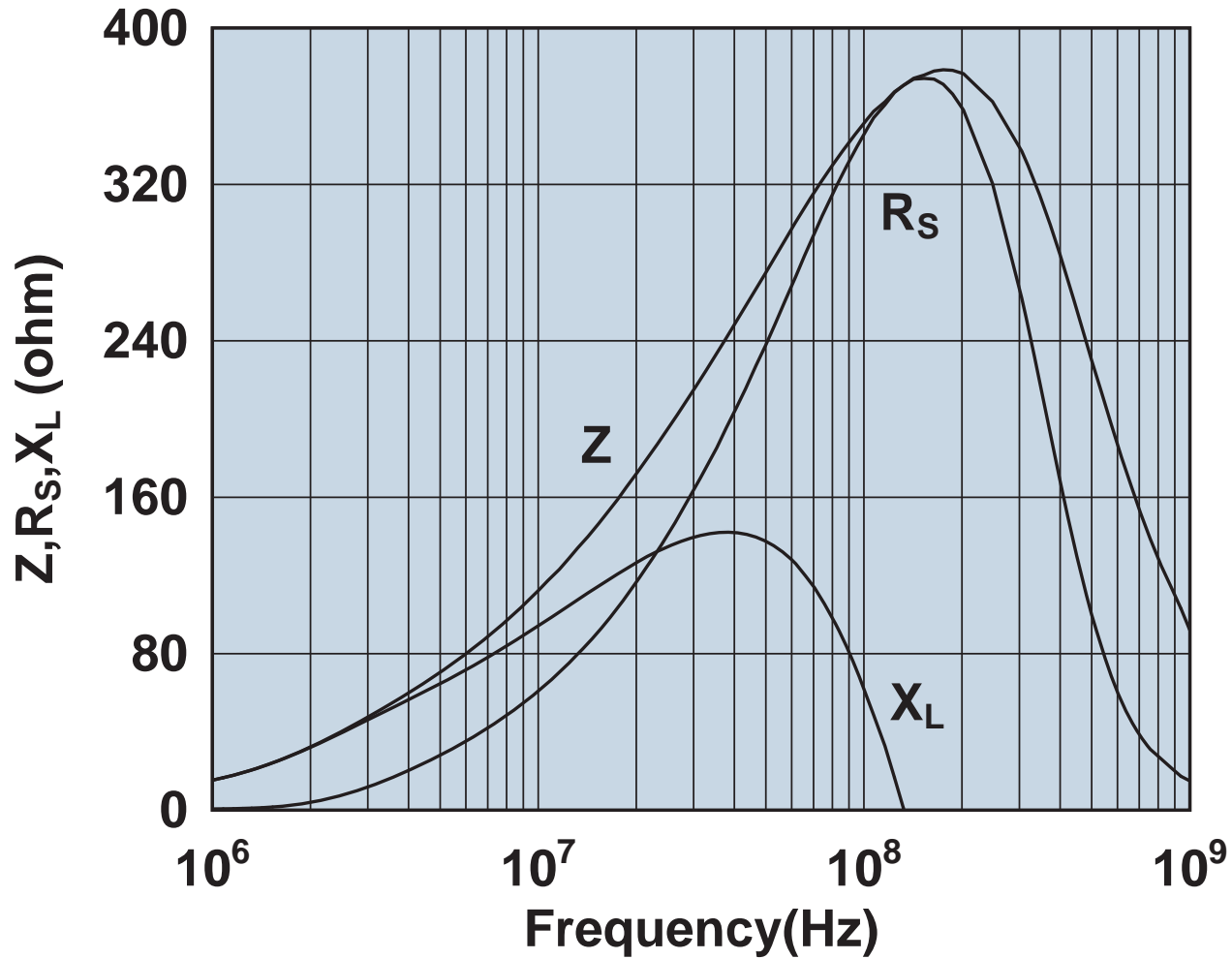

Impedance, reactance, and resistance vs. frequency.

0444177081

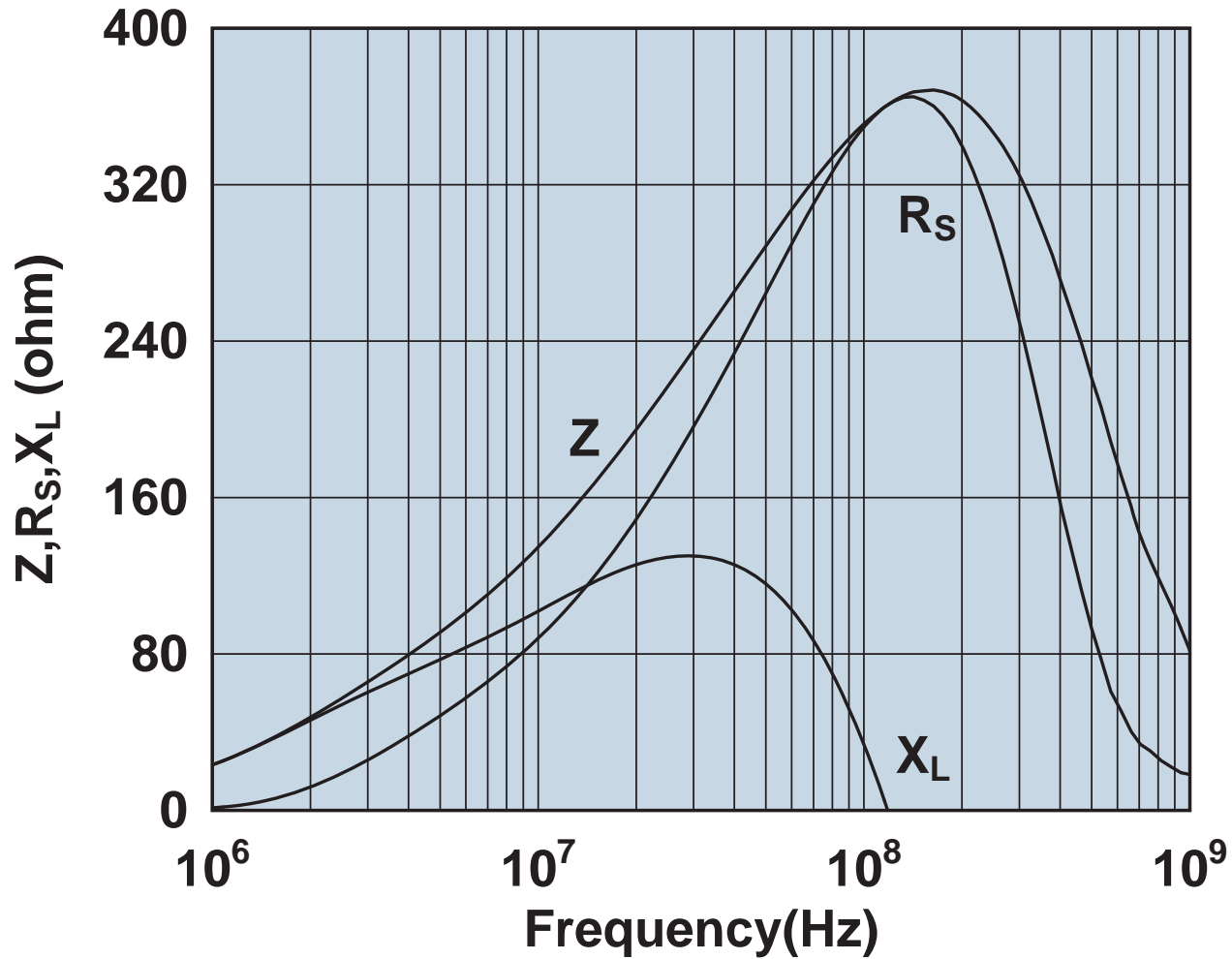

Impedance, reactance, and resistance vs. frequency.

0446164151

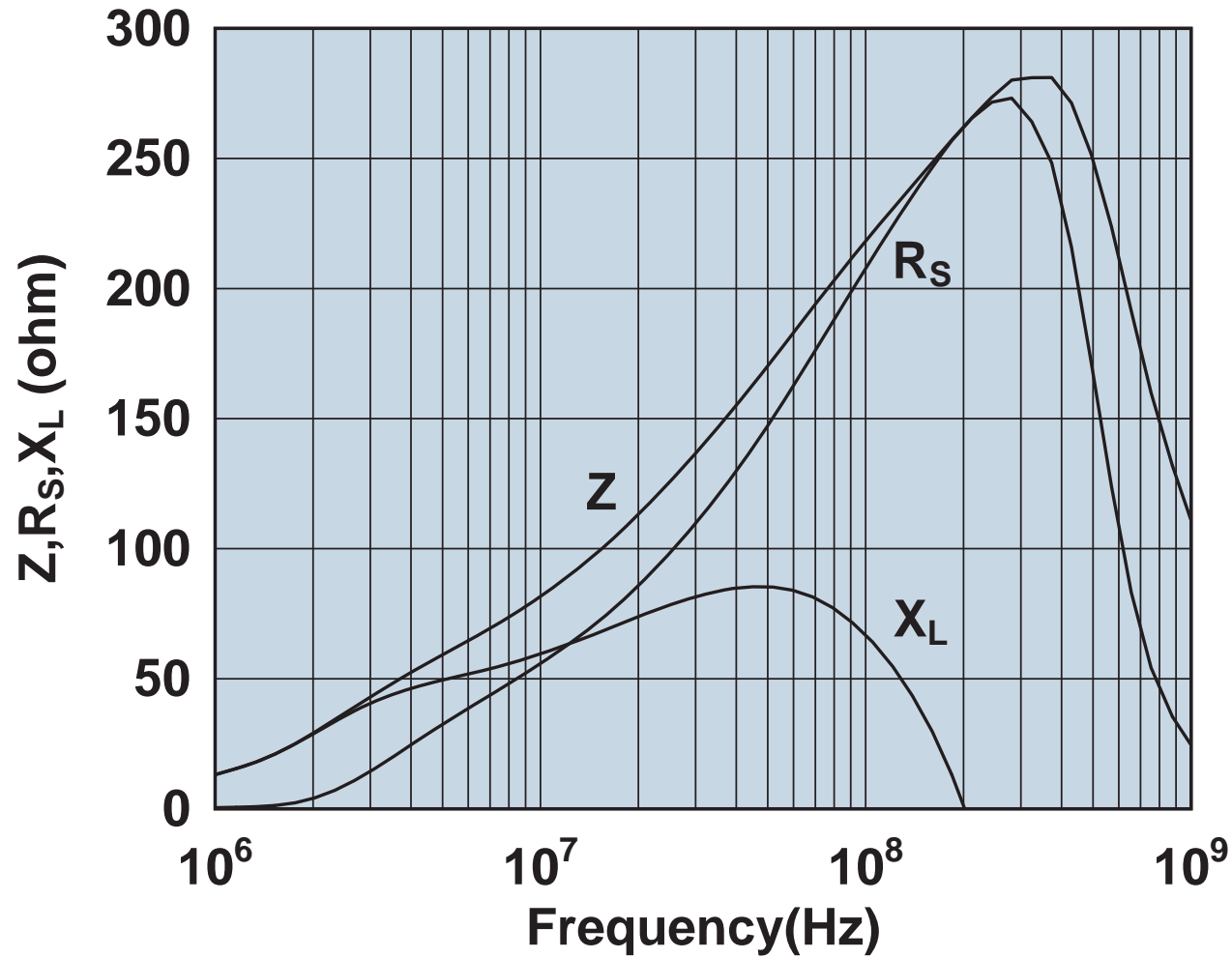

Impedance, reactance, and resistance vs. frequency.

0446164181

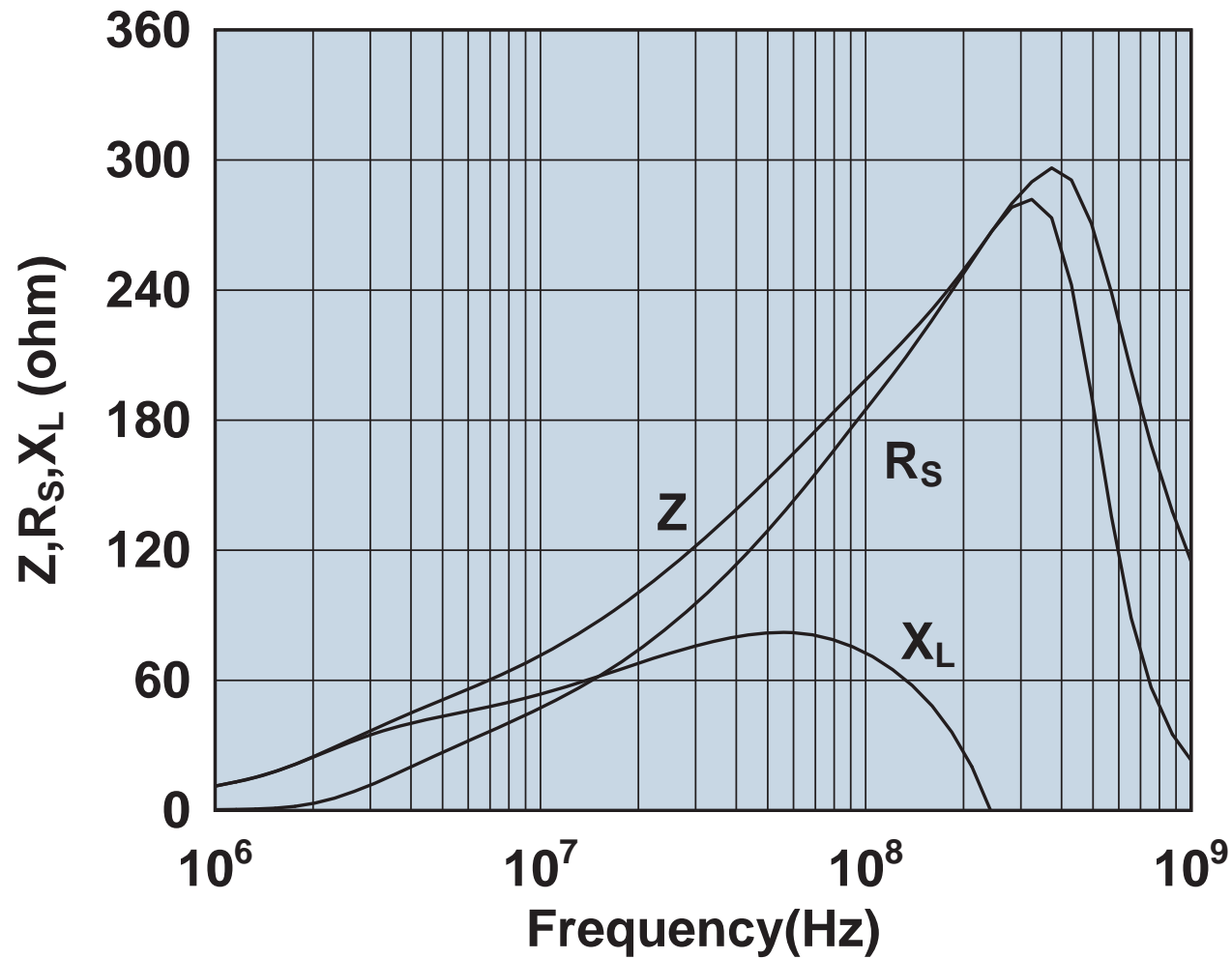

Impedance, reactance, and resistance vs. frequency.

0446164251

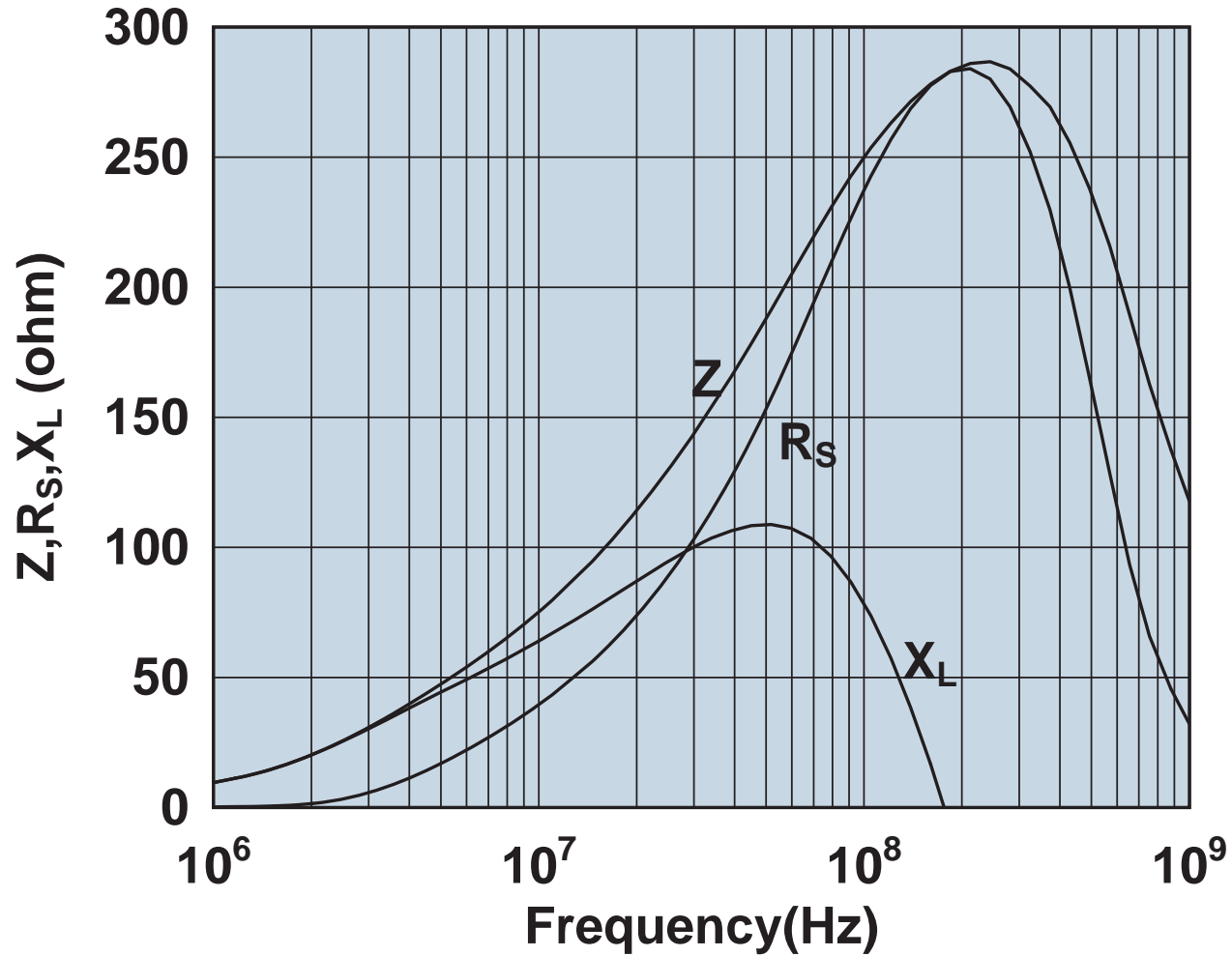

Impedance, reactance, and resistance vs. frequency.

0446164281

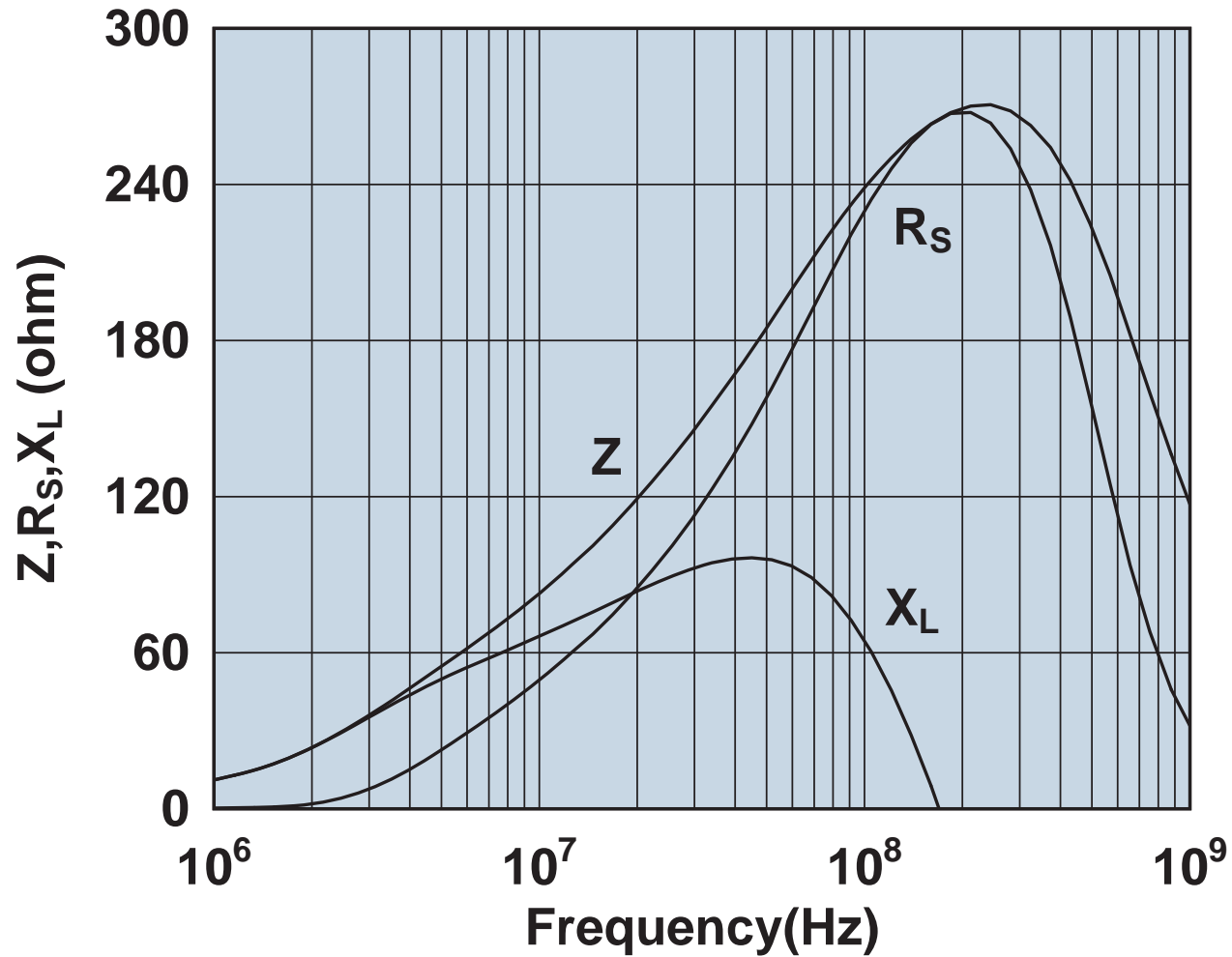

Impedance, reactance, and resistance vs. frequency.

0446164951

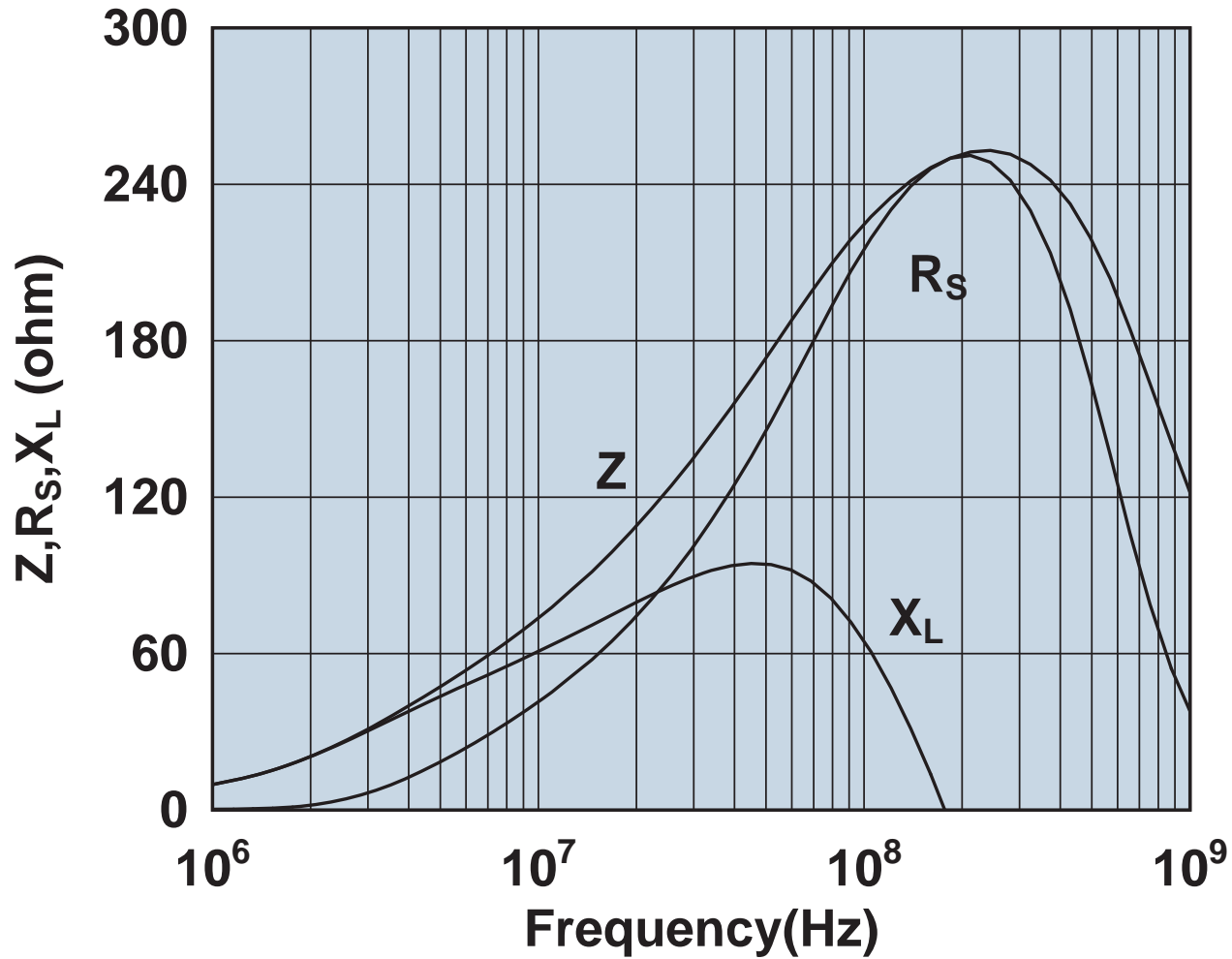

Impedance, reactance, and resistance vs. frequency.

0446167251

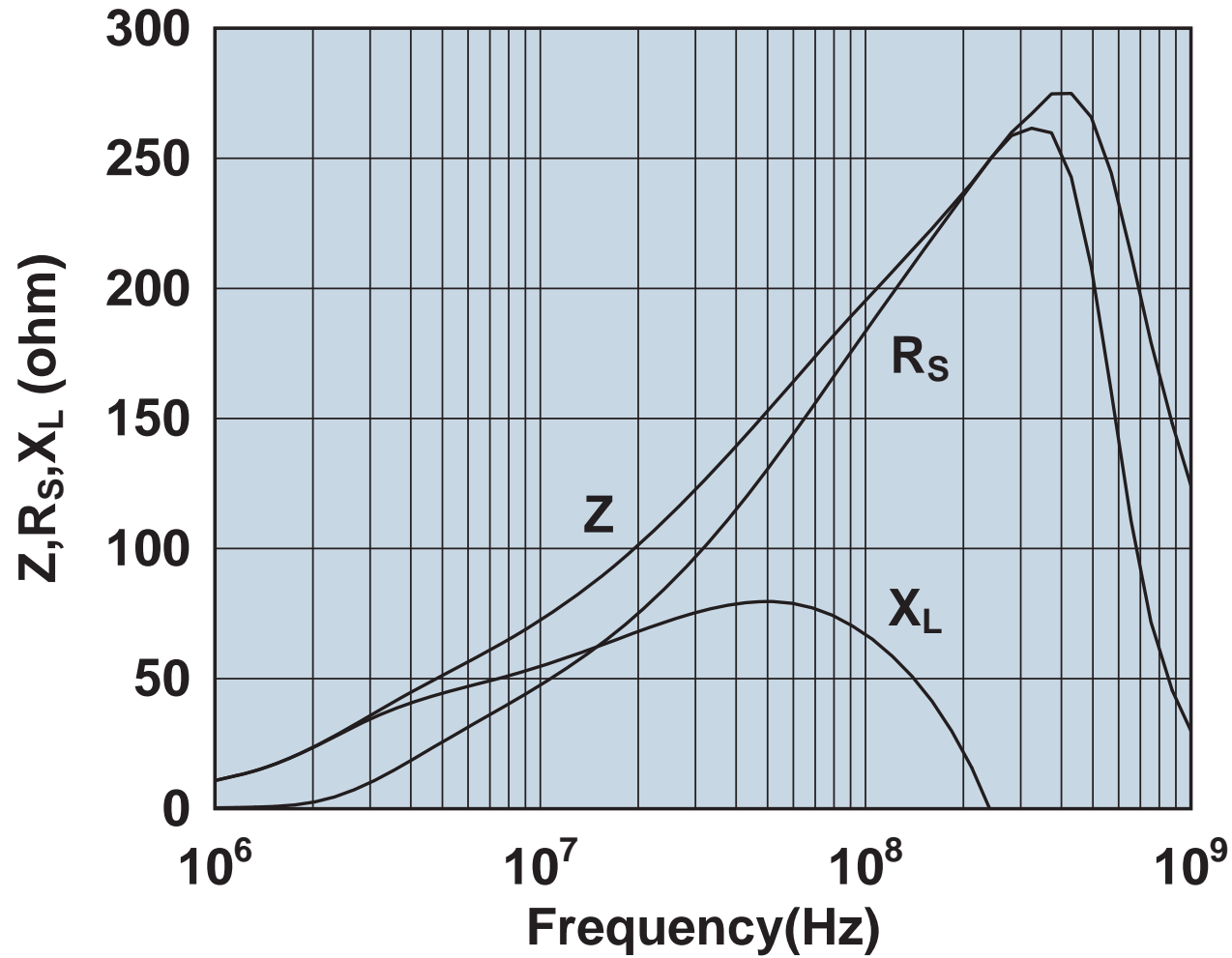

Impedance, reactance, and resistance vs. frequency.

0446167281

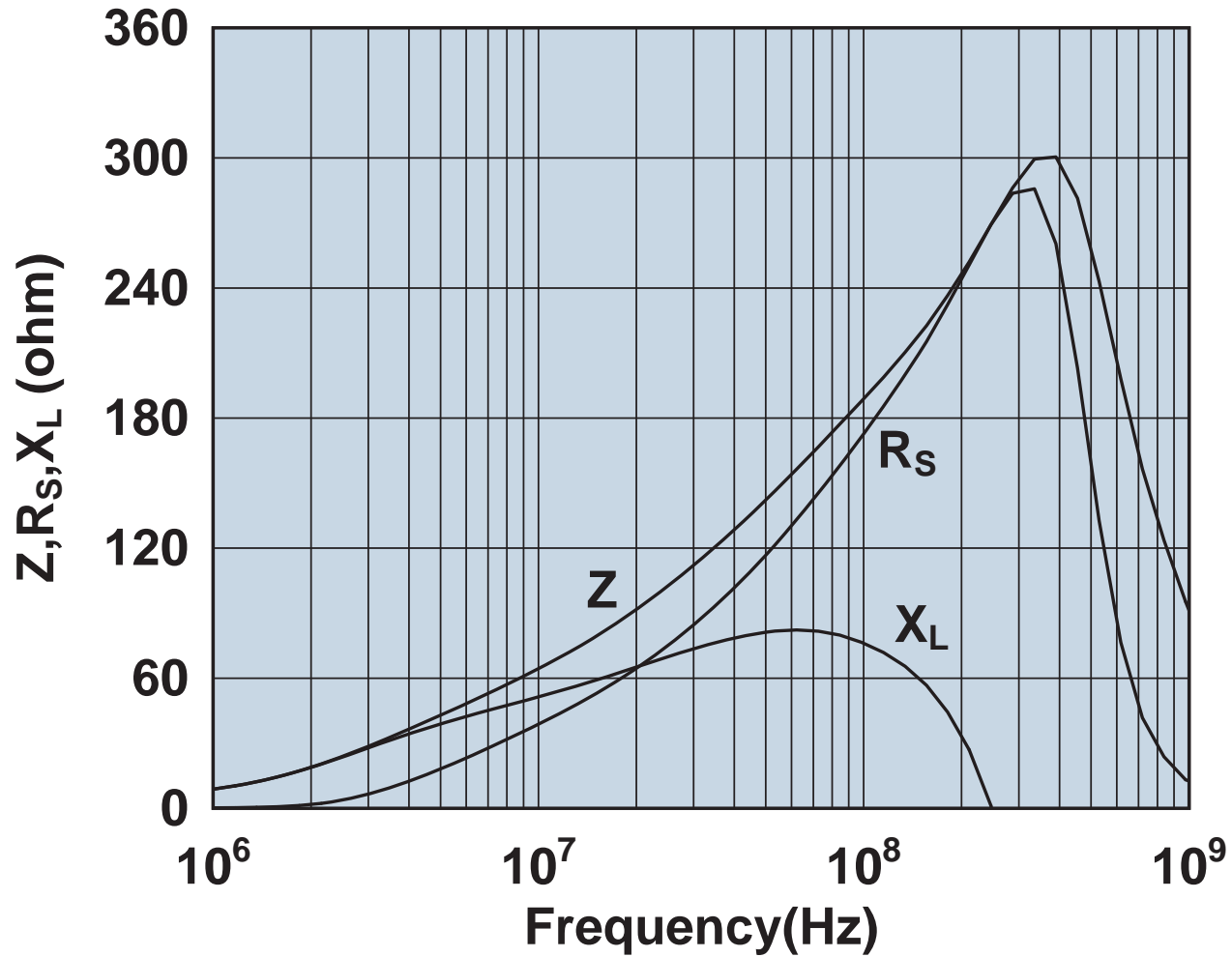

Impedance, reactance, and resistance vs. frequency.

0446173551

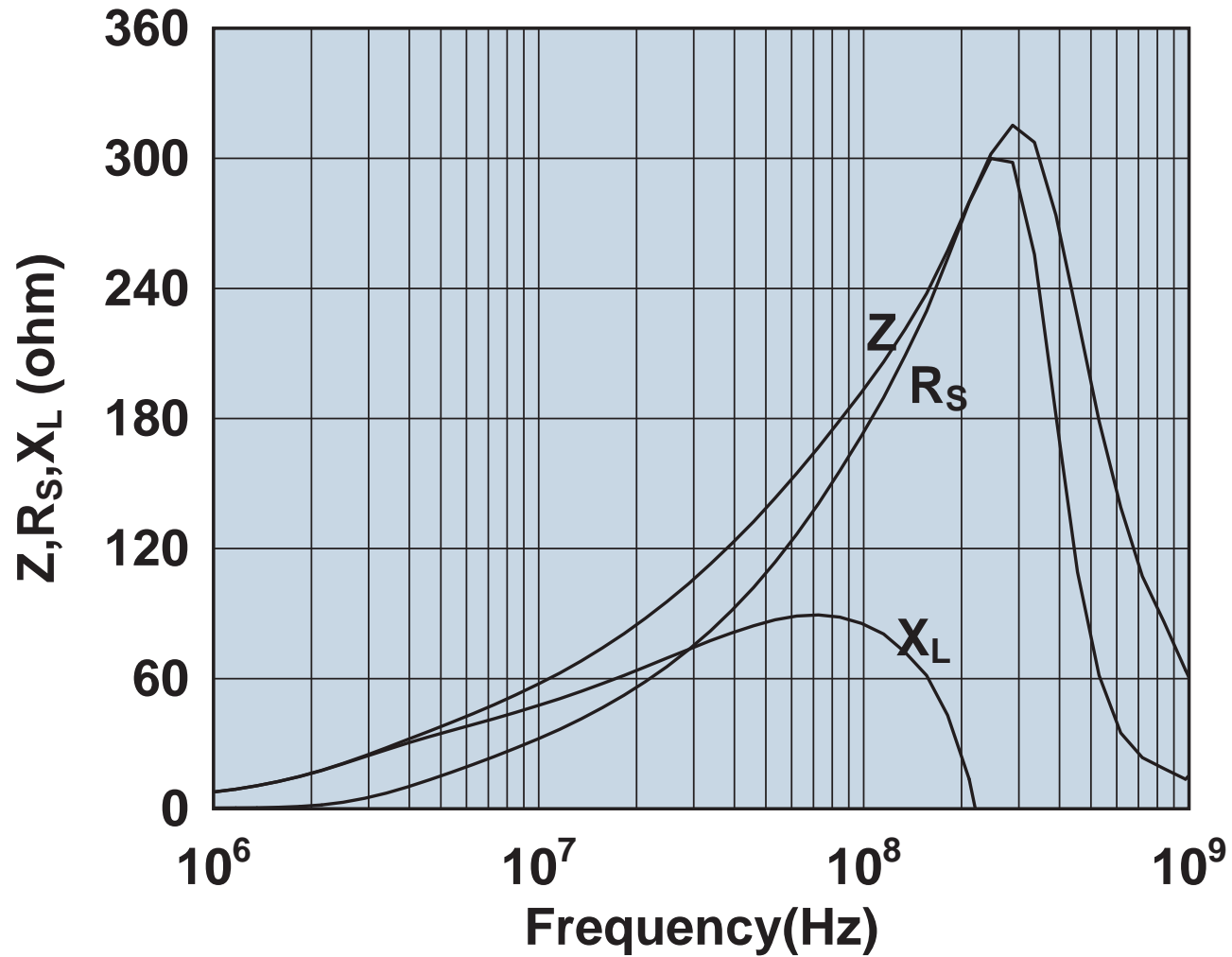

Impedance, reactance, and resistance vs. frequency.

0446173951

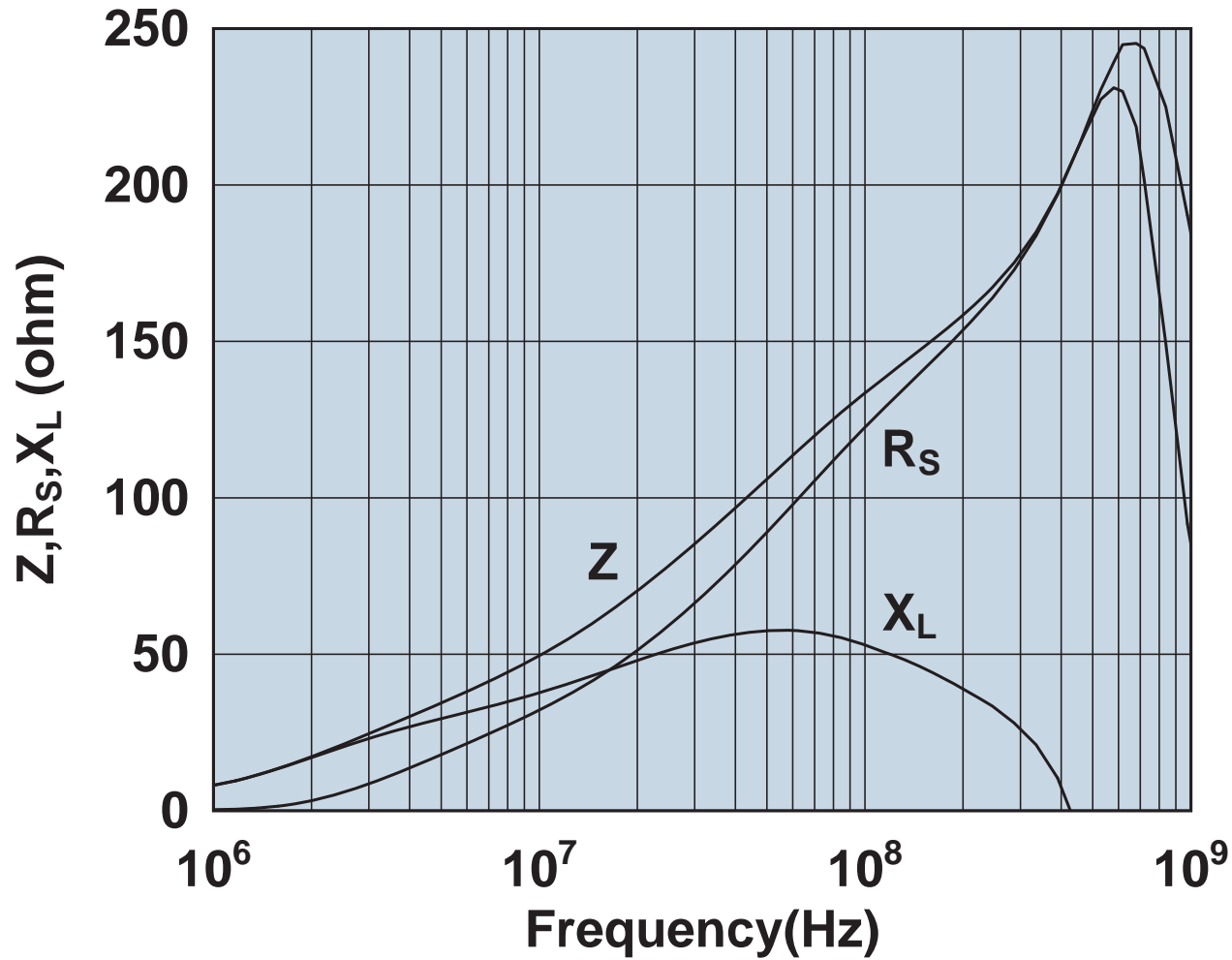

Impedance, reactance, and resistance vs. frequency.

0446176451

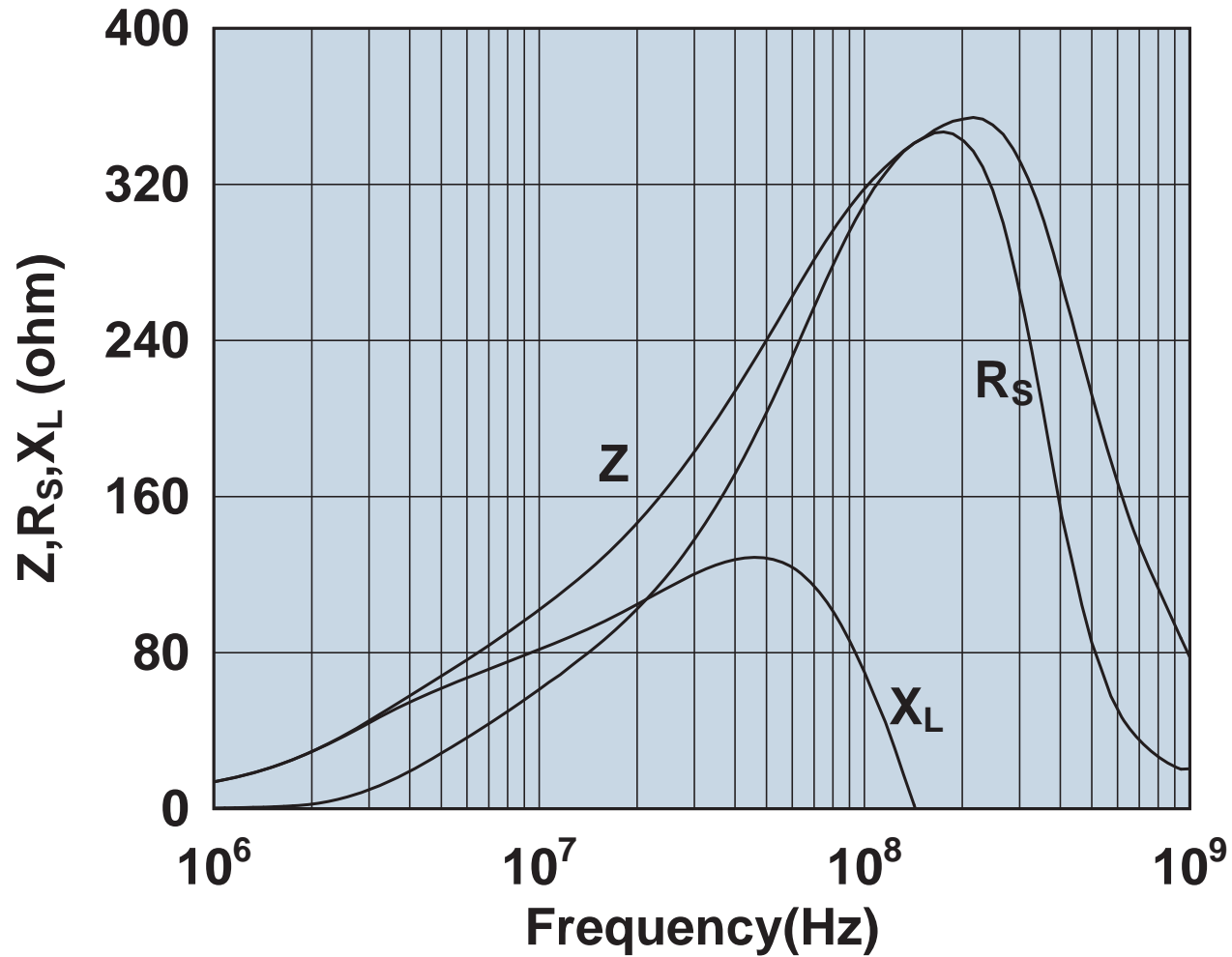

Impedance, reactance, and resistance vs. frequency.

0446177081

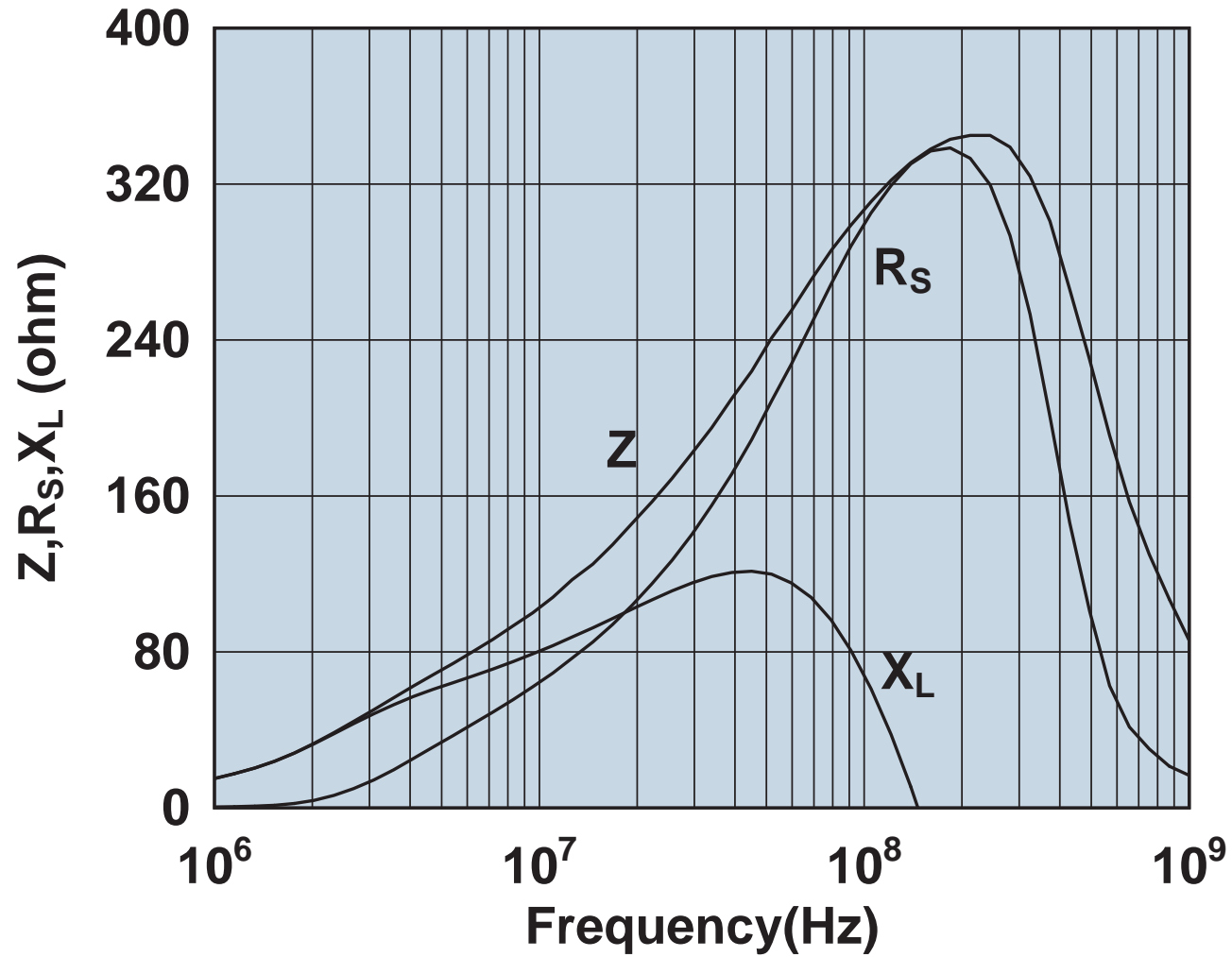

Impedance, reactance, and resistance vs. frequency.

0461164181

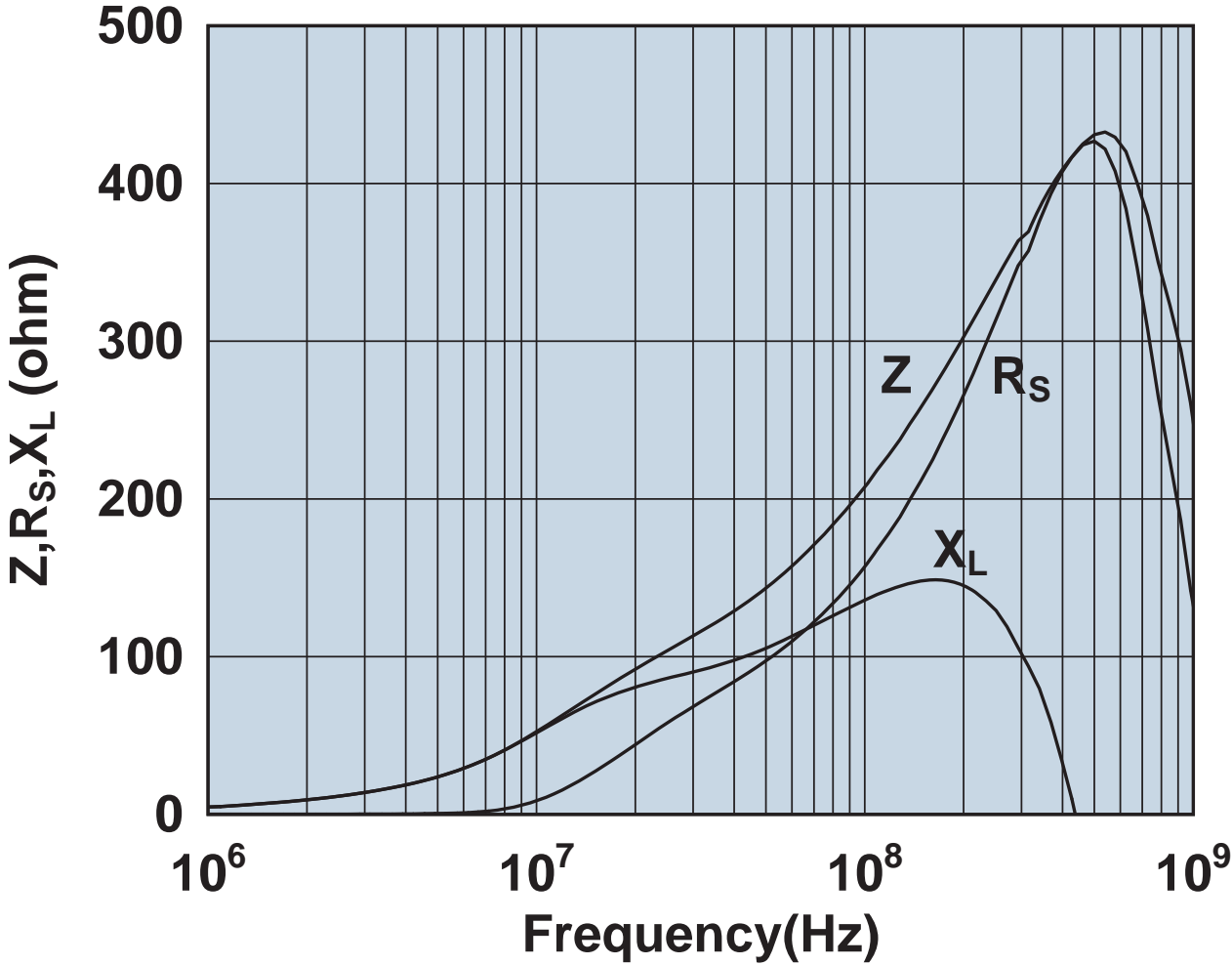

Impedance, reactance, and resistance vs. frequency.

0461164281

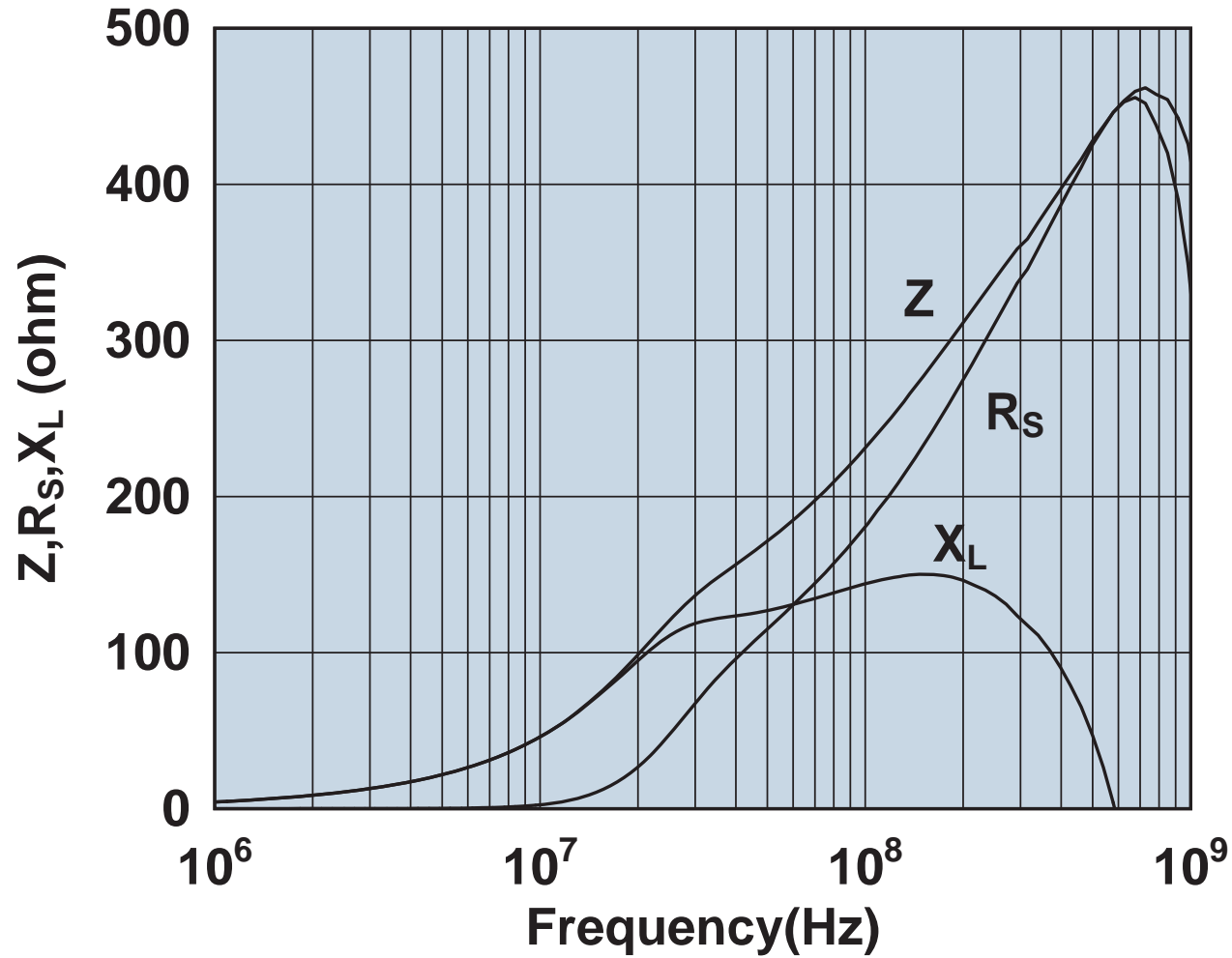

Impedance, reactance, and resistance vs. frequency.

0461164951

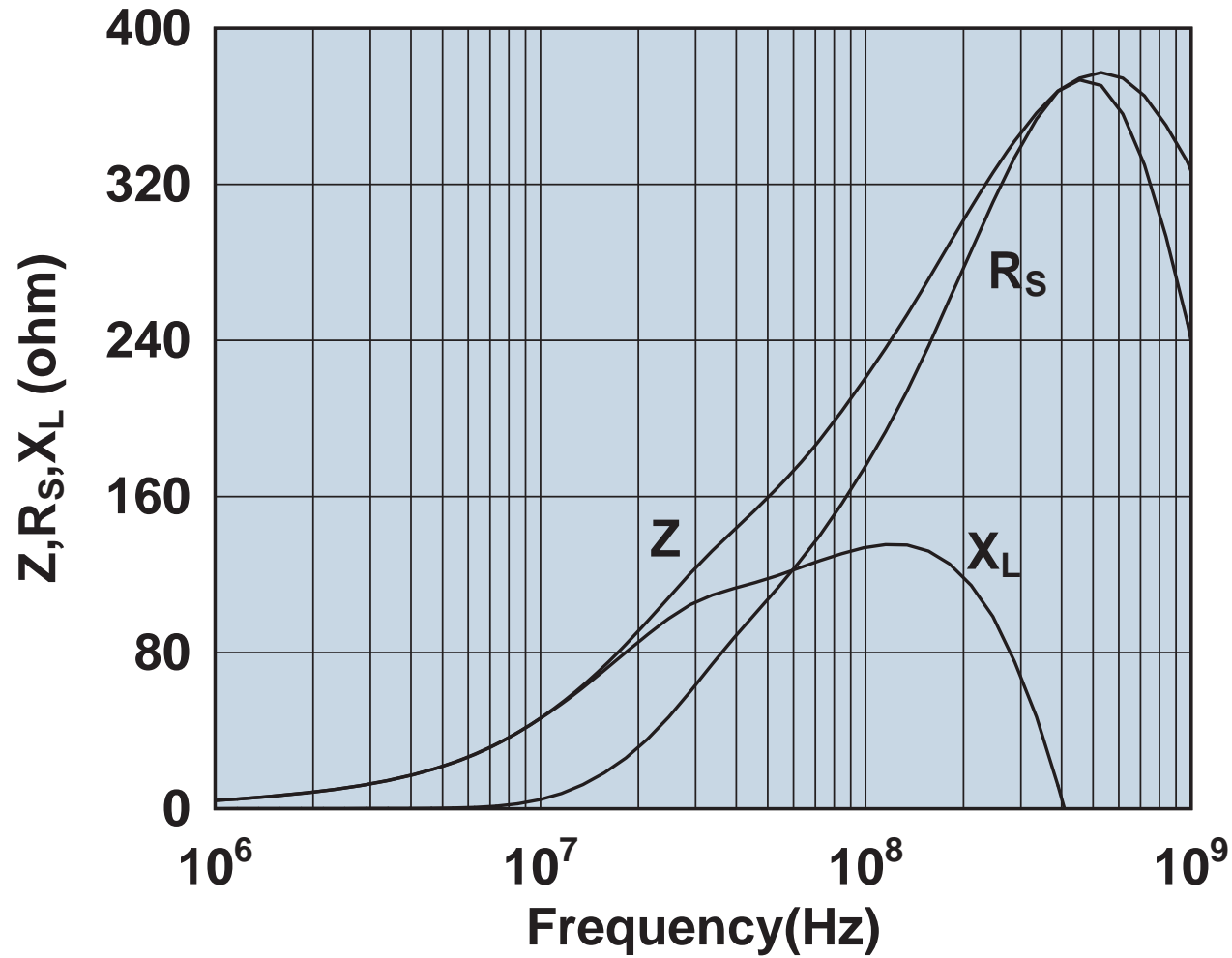

Impedance, reactance, and resistance vs. frequency.

0461167281

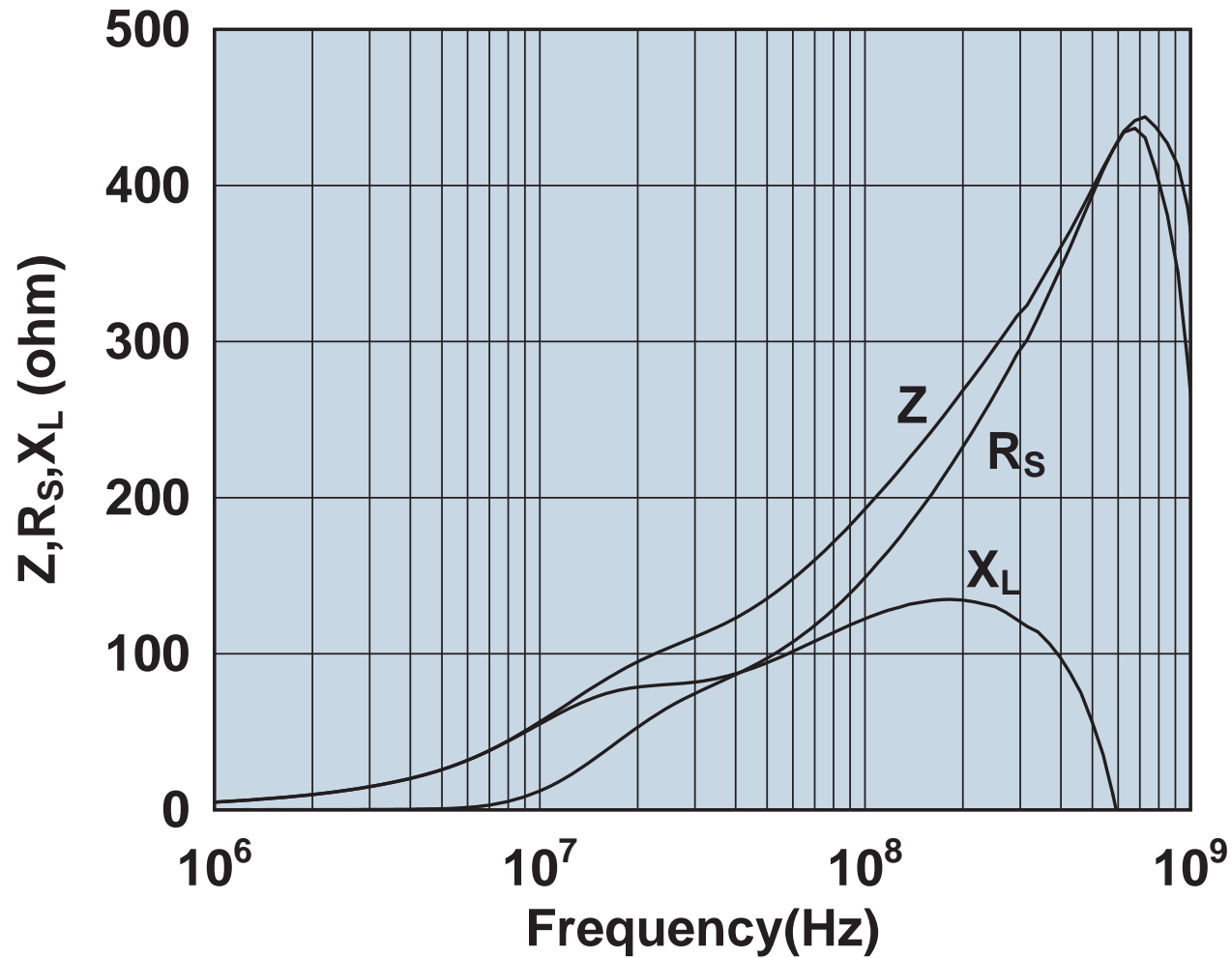

Impedance, reactance, and resistance vs. frequency.

0461176451

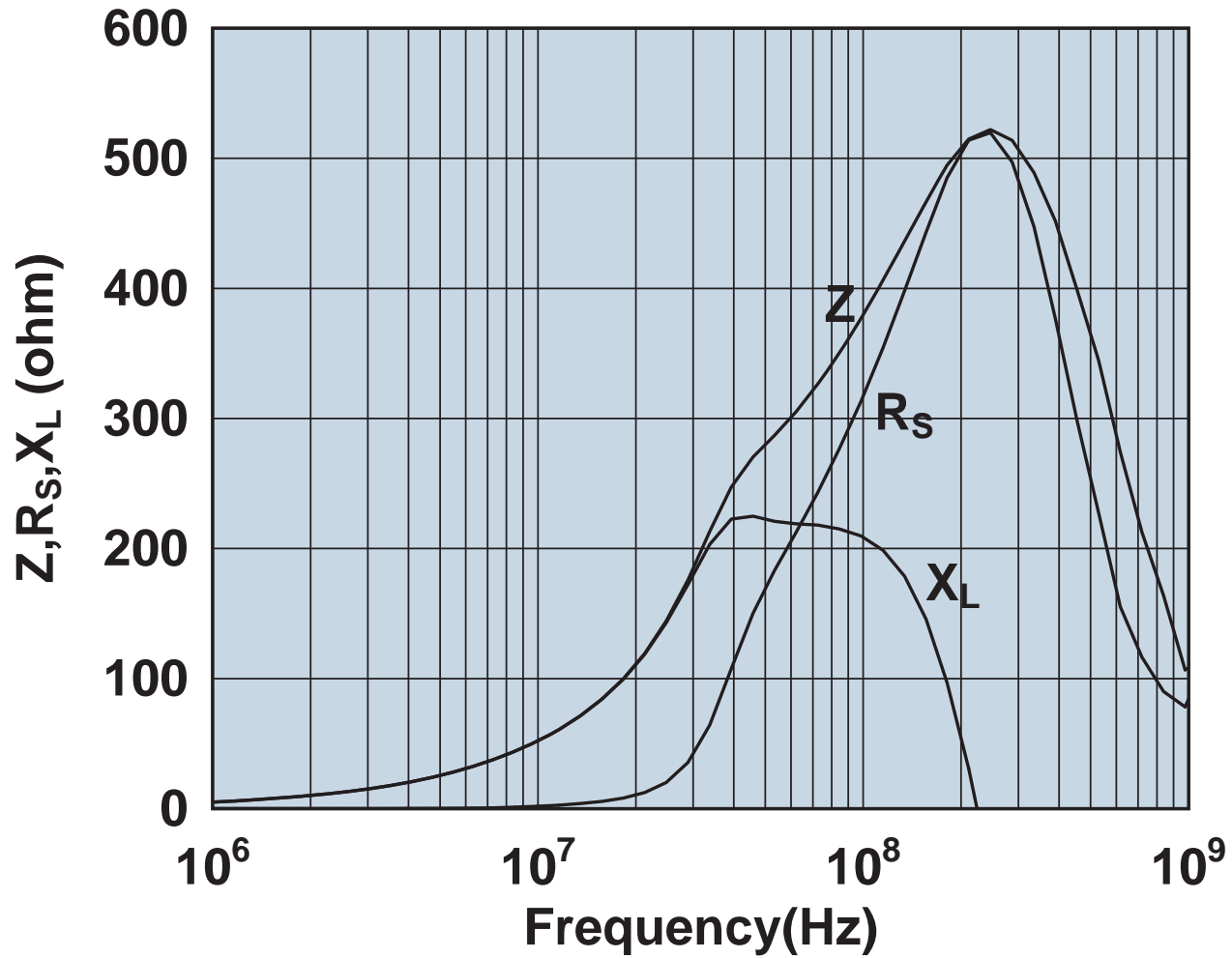

Impedance, reactance, and resistance vs. frequency.

0461178181

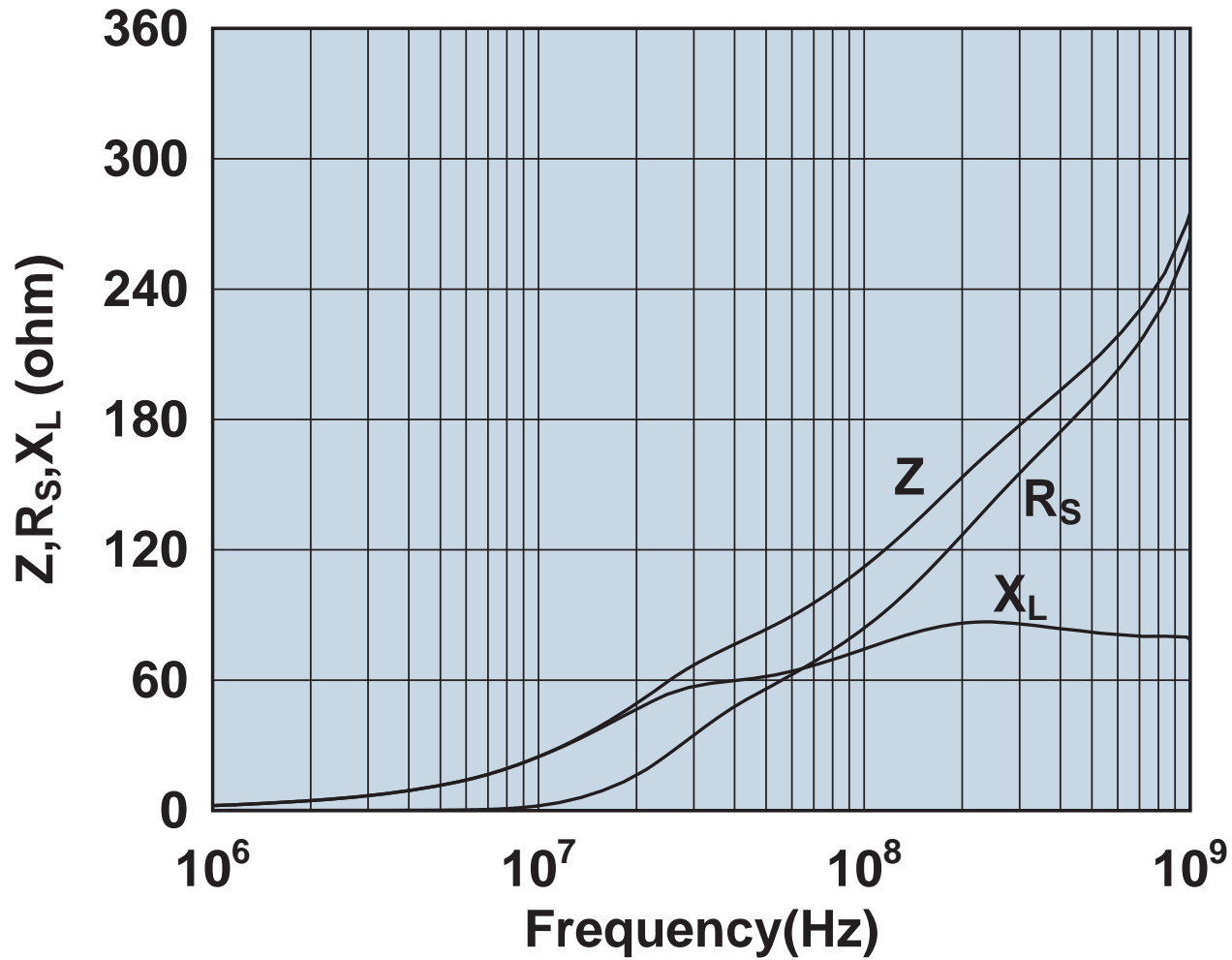

Impedance, reactance, and resistance vs. frequency.

0461178281

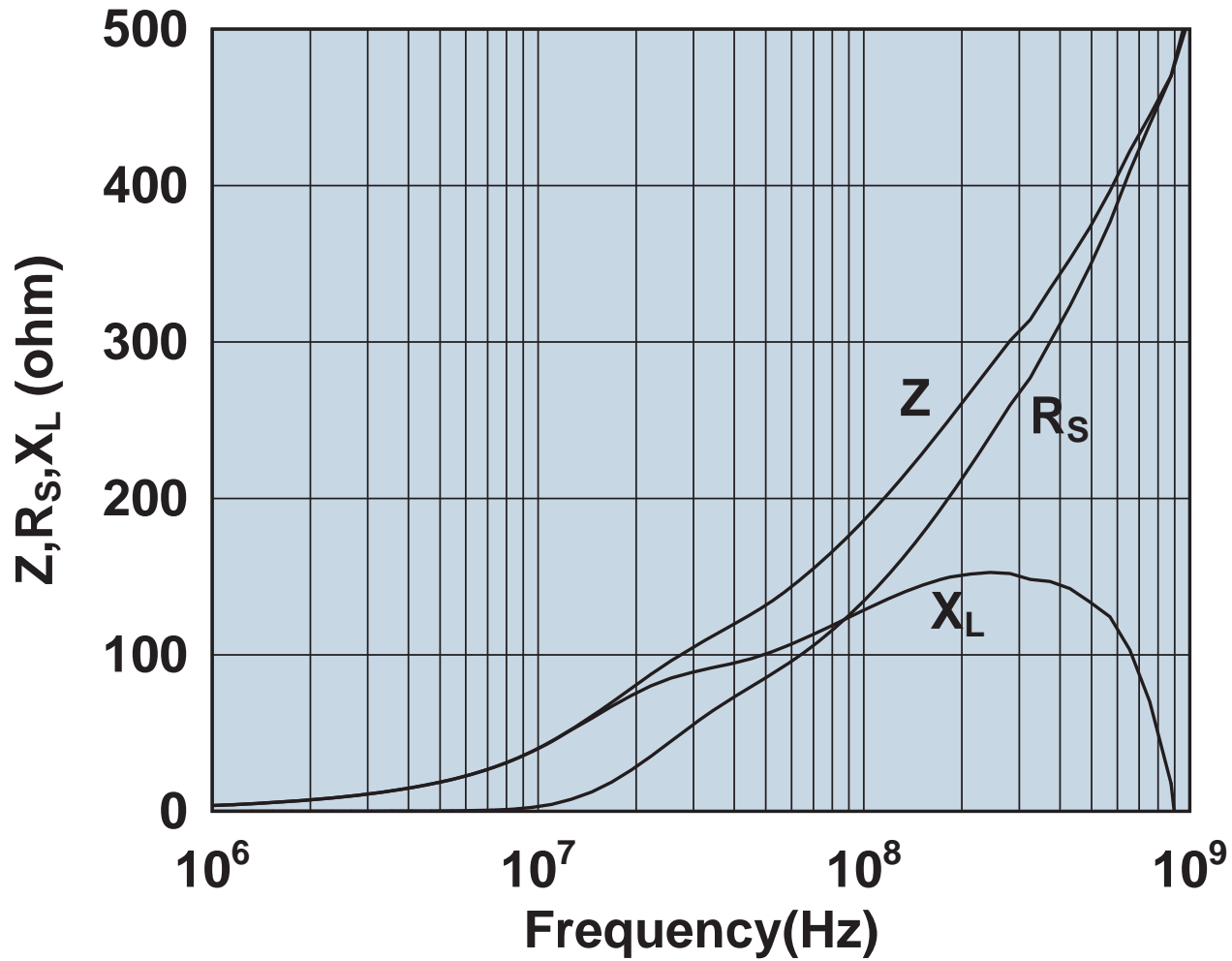

Impedance, reactance, and resistance vs. frequency.

2631023002

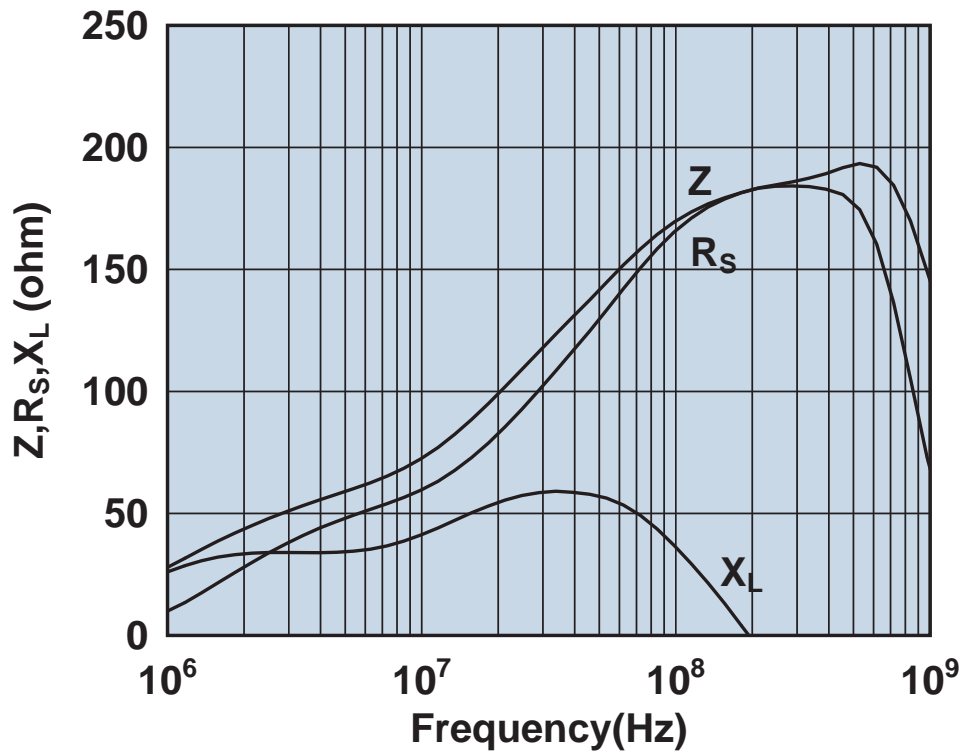

Impedance, reactance, and resistance vs. frequency.

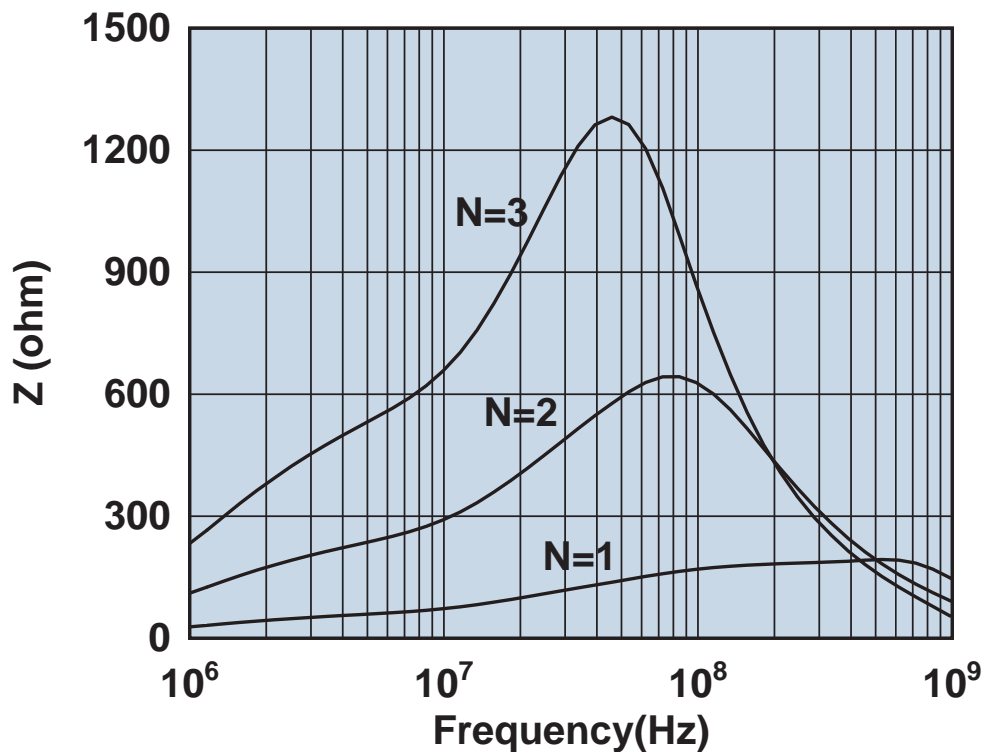

Impedance vs. frequency with one, two, and three turns.

2631101902

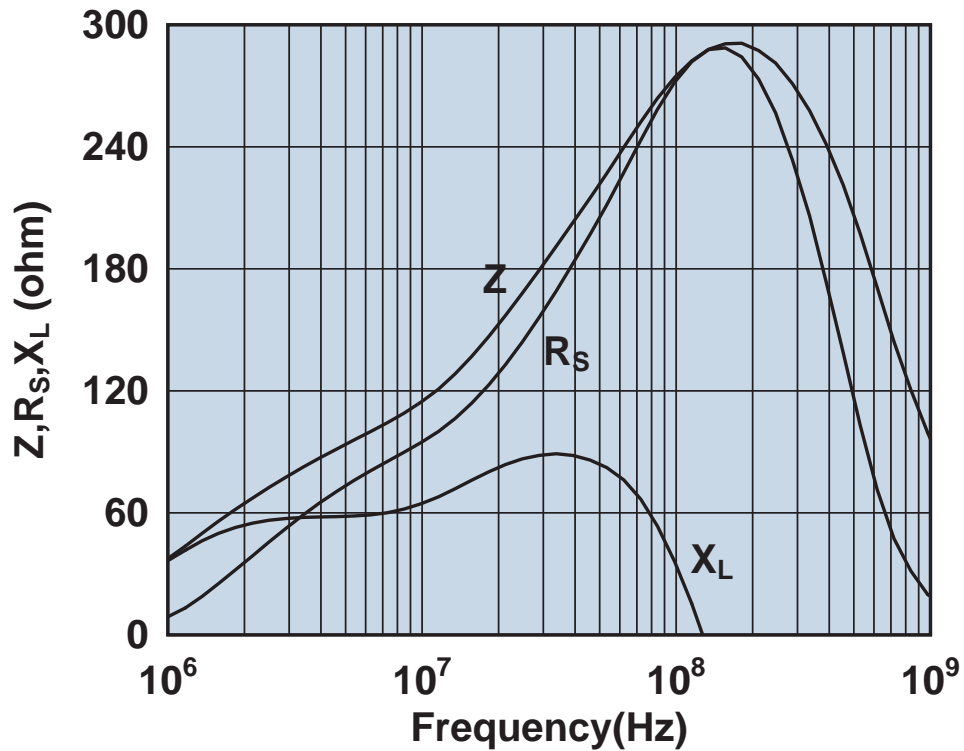

Impedance, reactance, and resistance vs. frequency.

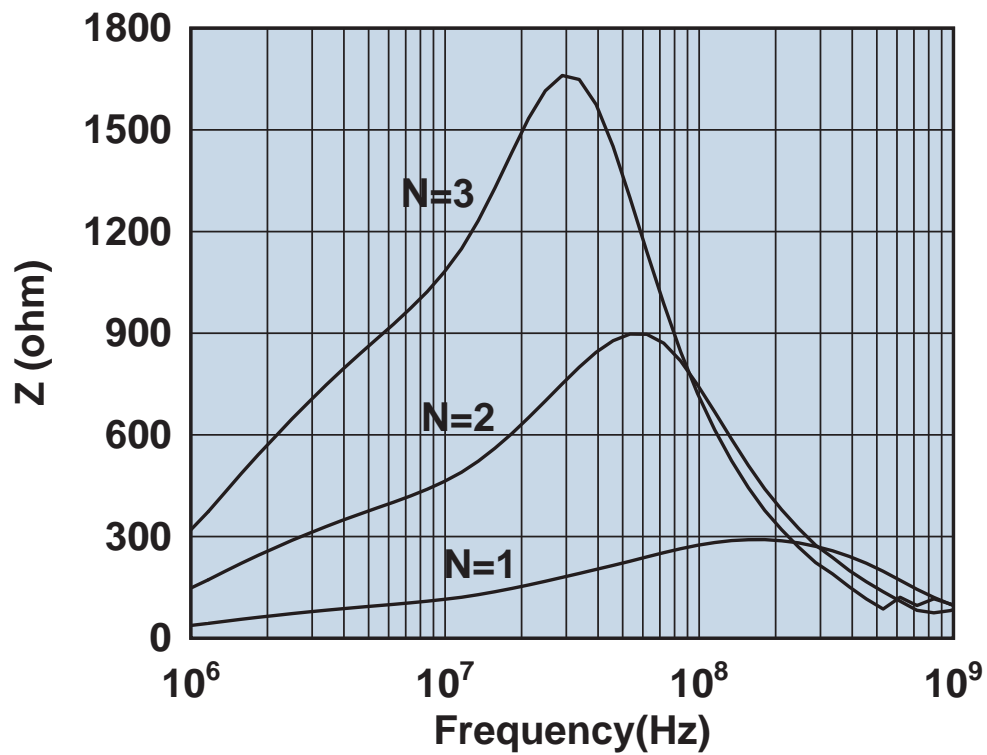

Impedance vs. frequency with one, two, and three turns.

2631102002

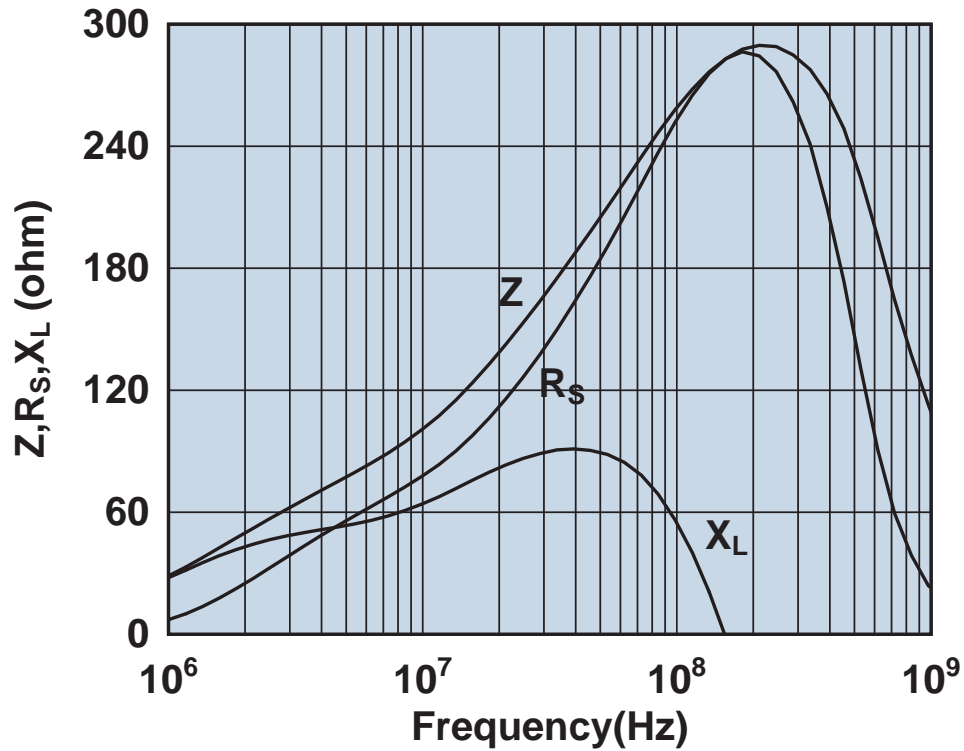

Impedance, reactance, and resistance vs. frequency.

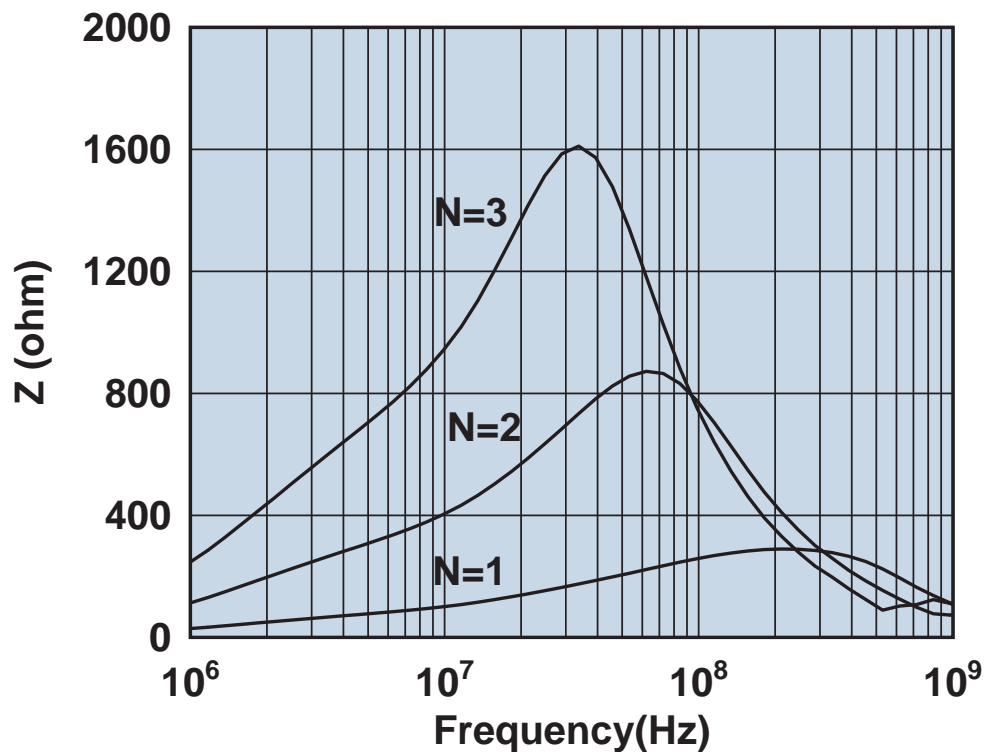

Impedance vs. frequency with one, two, and three turns.

2631103002

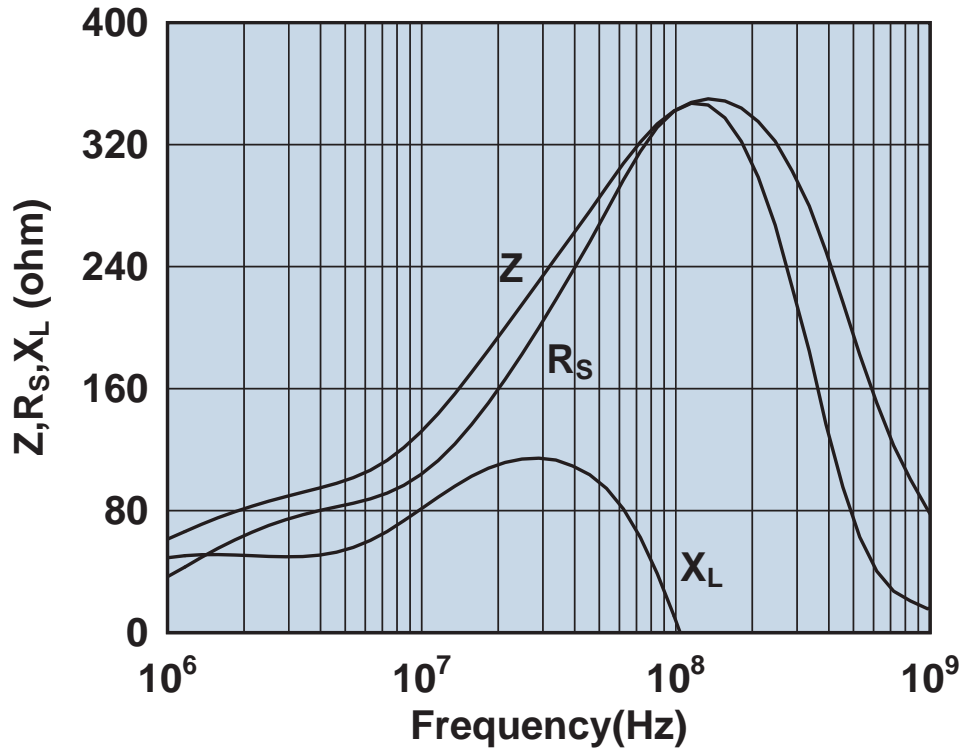

Impedance, reactance, and resistance vs. frequency.

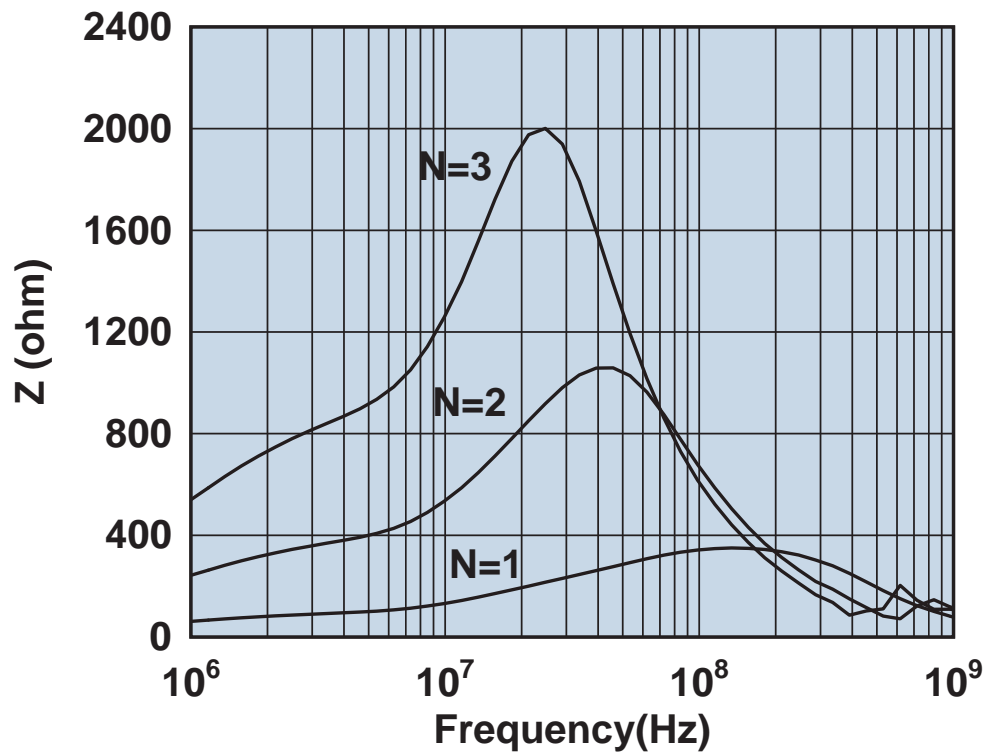

Impedance vs. frequency with one, two, and three turns.

2631163851

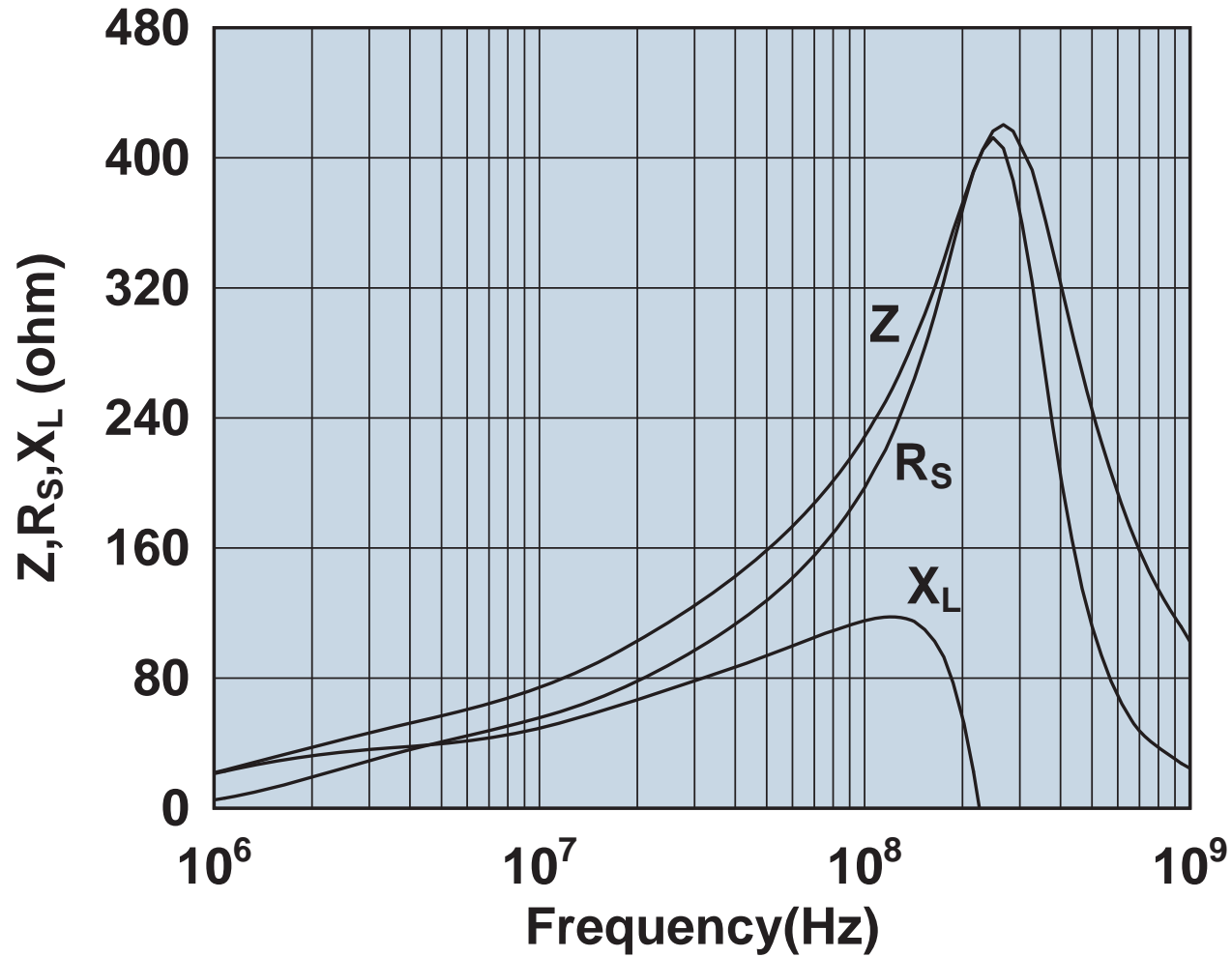

Impedance, reactance, and resistance vs. frequency.

2631163951

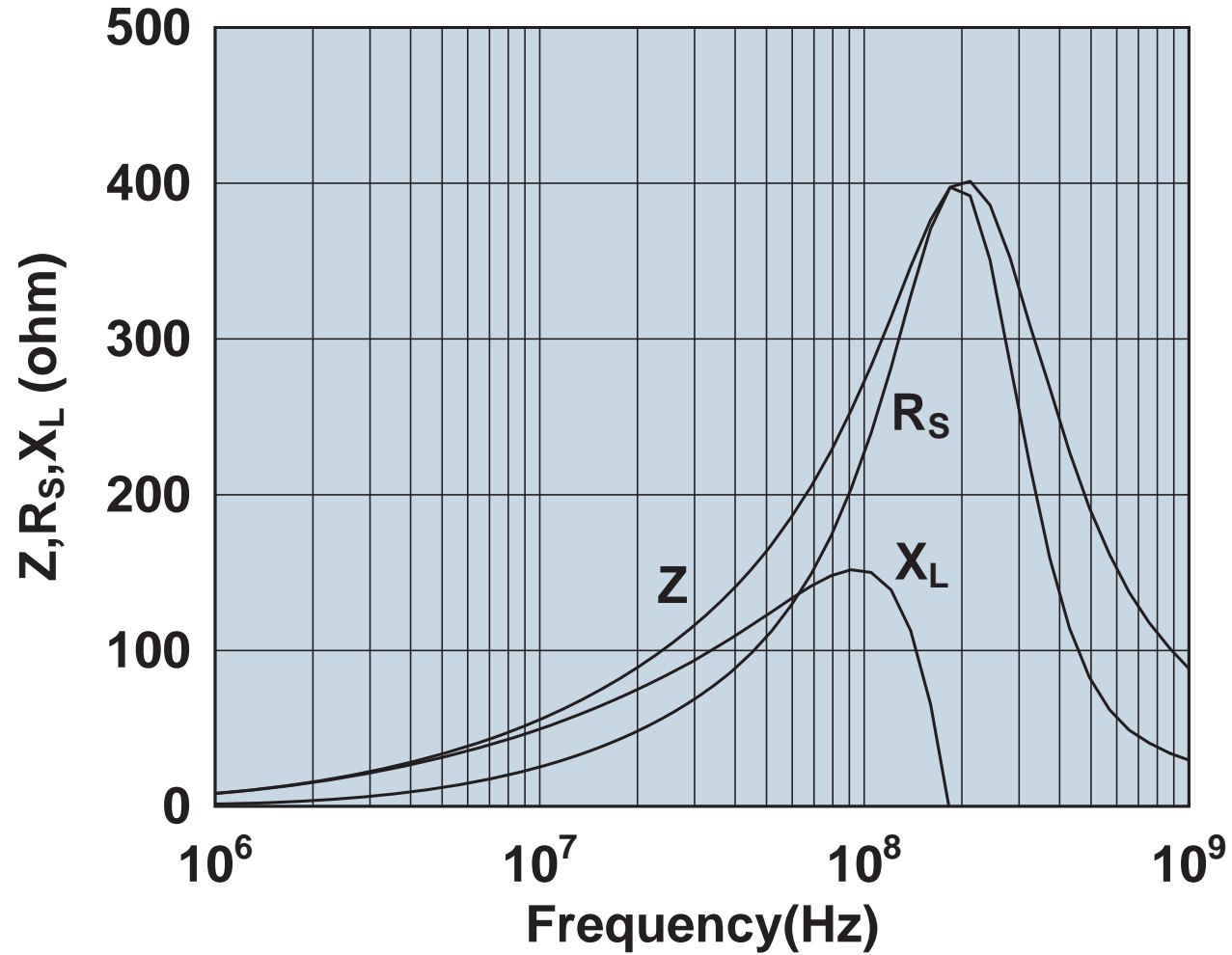

Impedance, reactance, and resistance vs. frequency.

2631164051

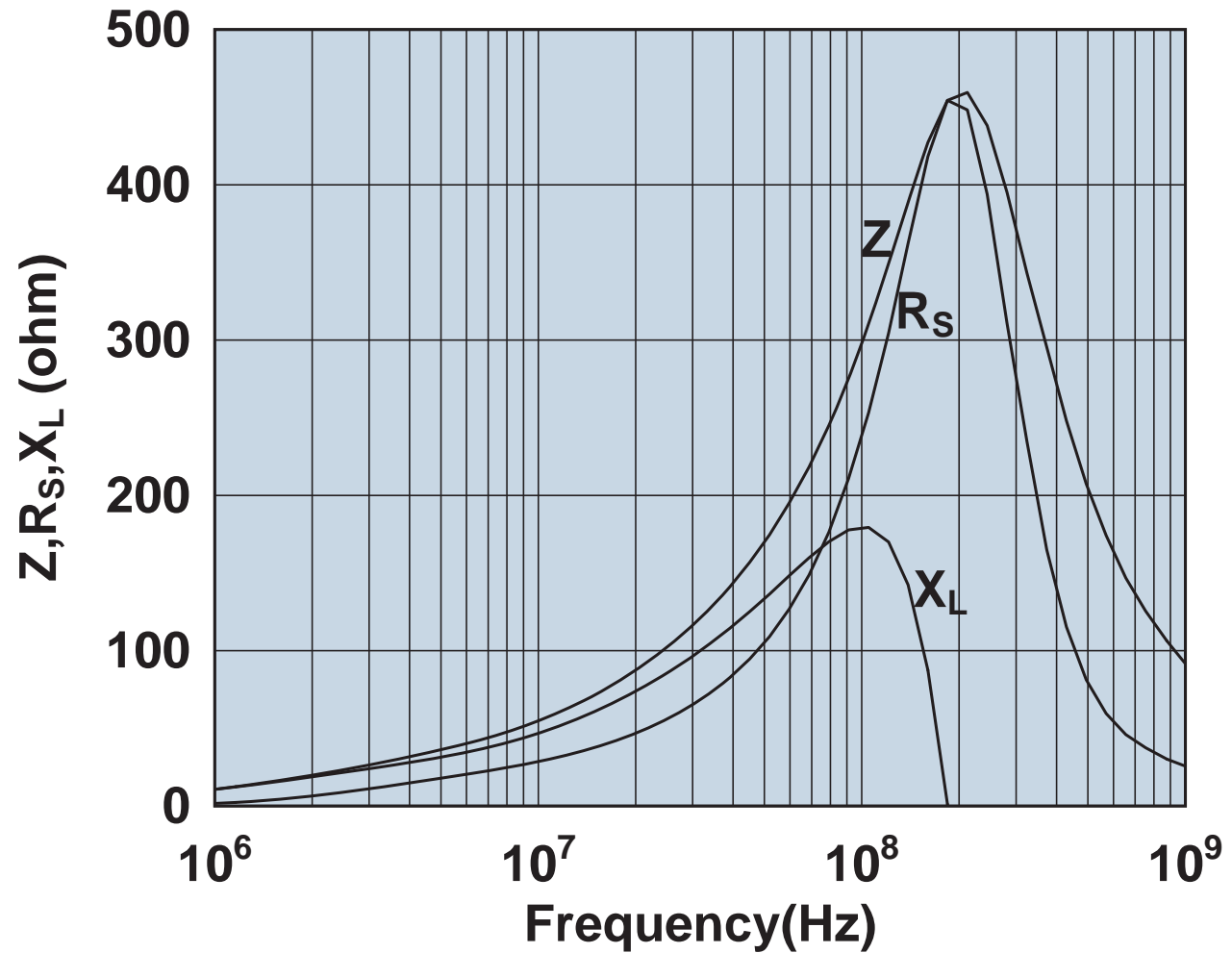

Impedance, reactance, and resistance vs. frequency.

2631164181

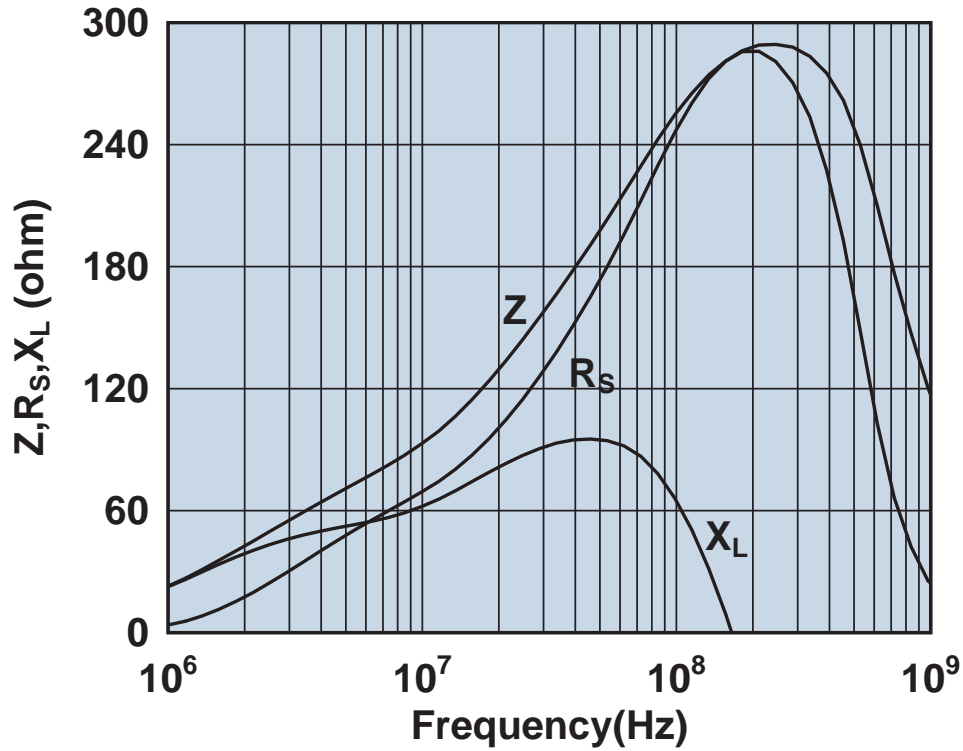

Impedance, reactance, and resistance vs. frequency.

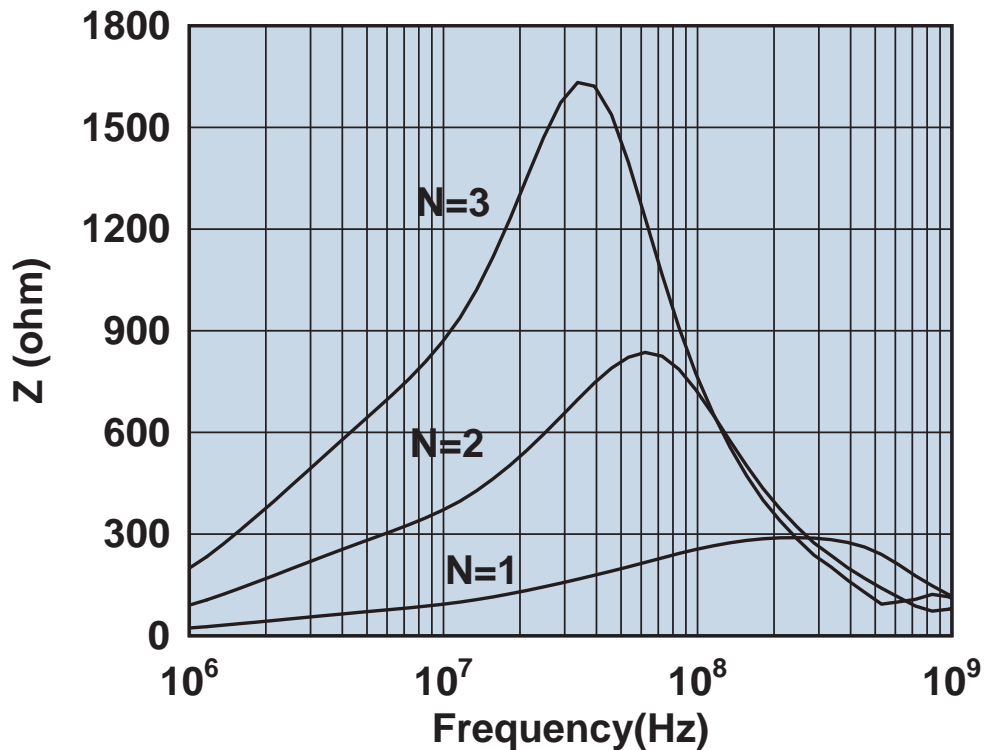

Impedance vs. frequency with one, two, and three turns.

2631164281

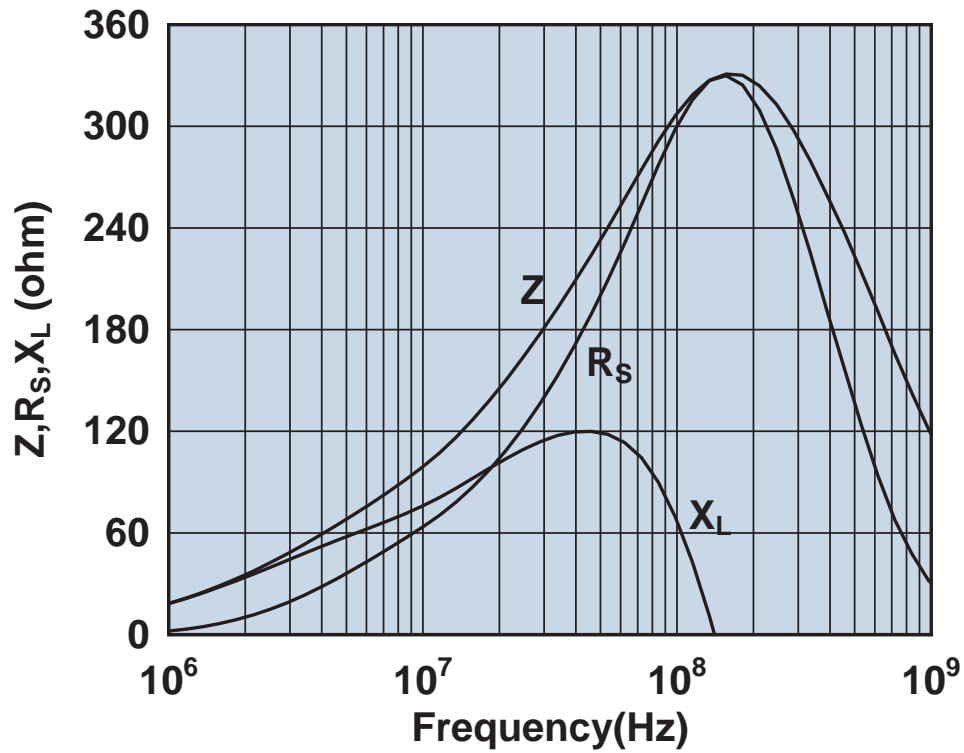

Impedance, reactance, and resistance vs. frequency.

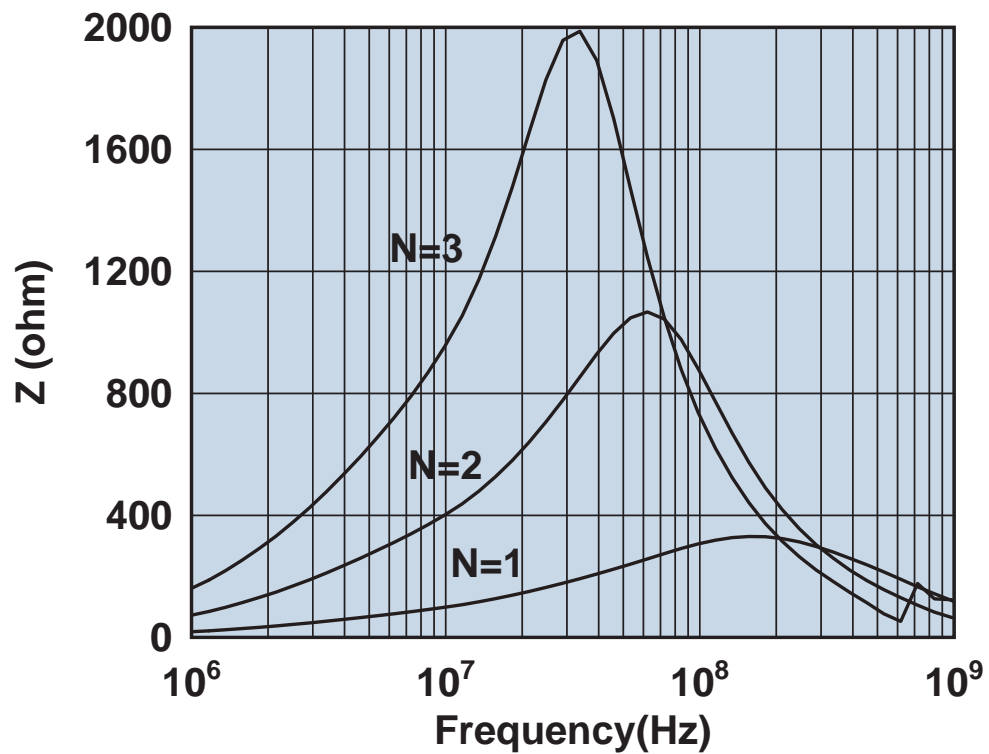

Impedance vs. frequency with one, two, and three turns.

2631164951

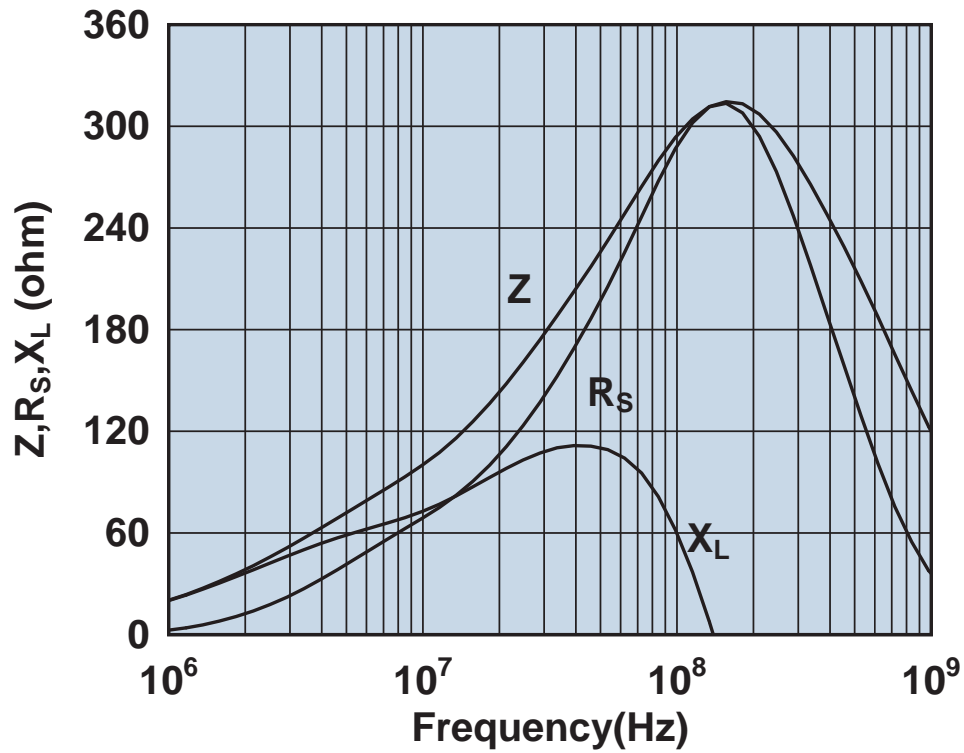

Impedance, reactance, and resistance vs. frequency.

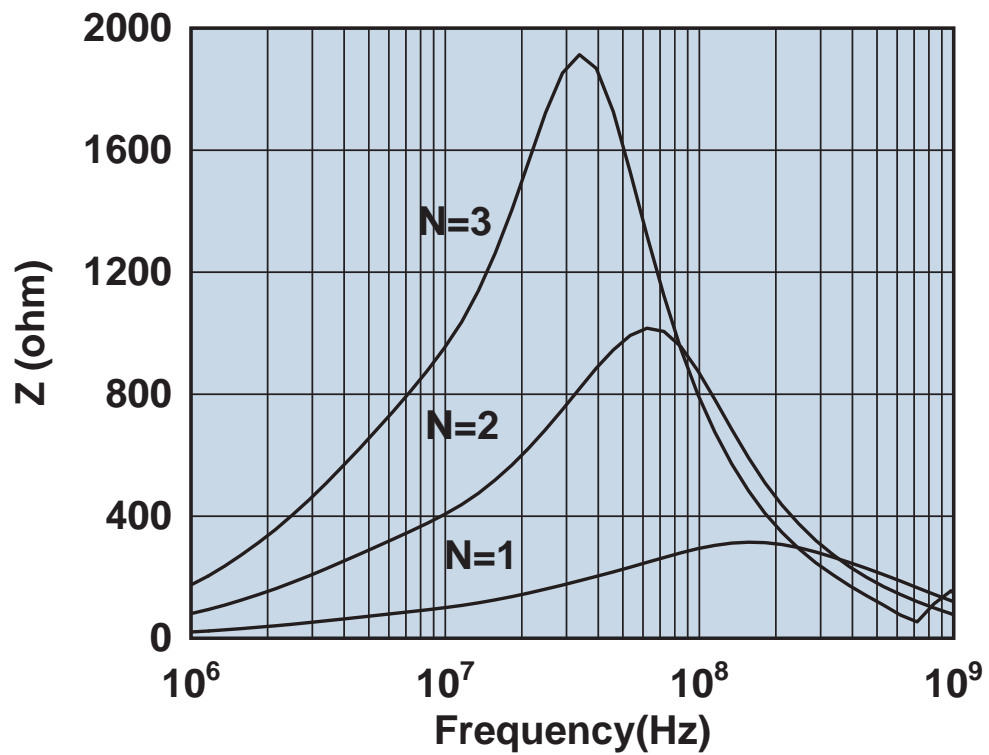

Impedance vs. frequency with one, two, and three turns.

2631167281

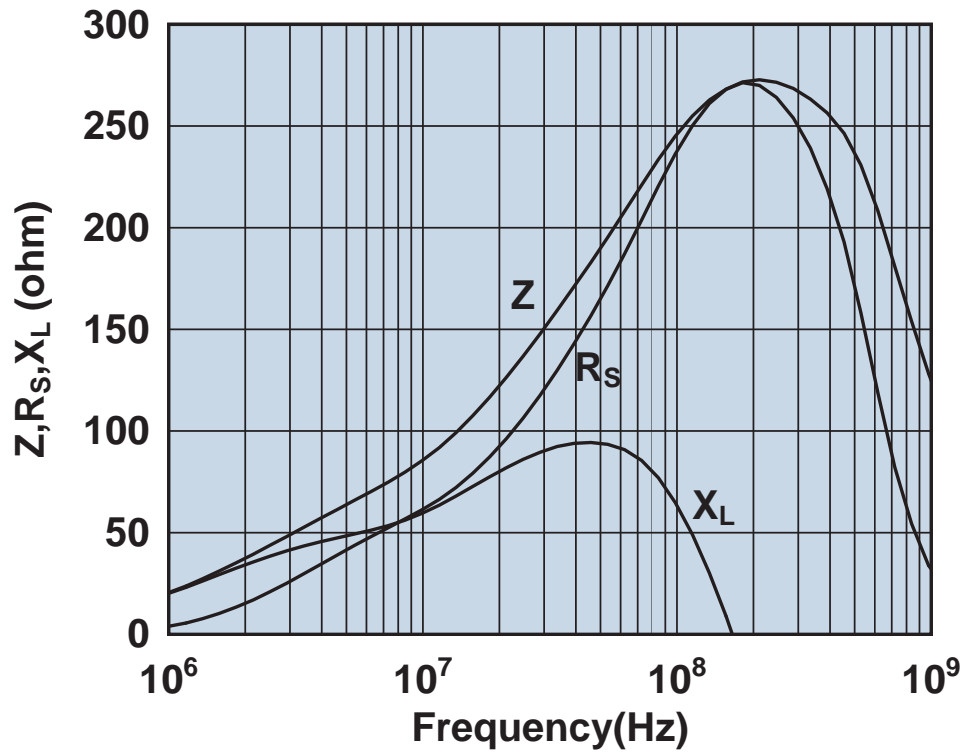

Impedance, reactance, and resistance vs. frequency.

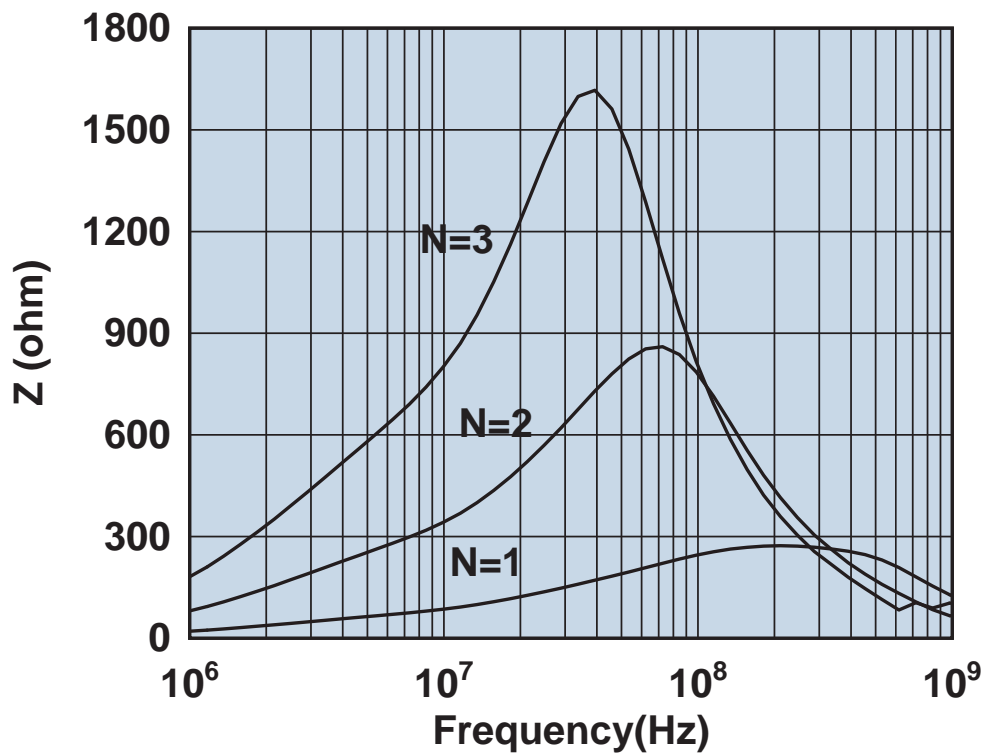

Impedance vs. frequency with one, two, and three turns.

2631173551

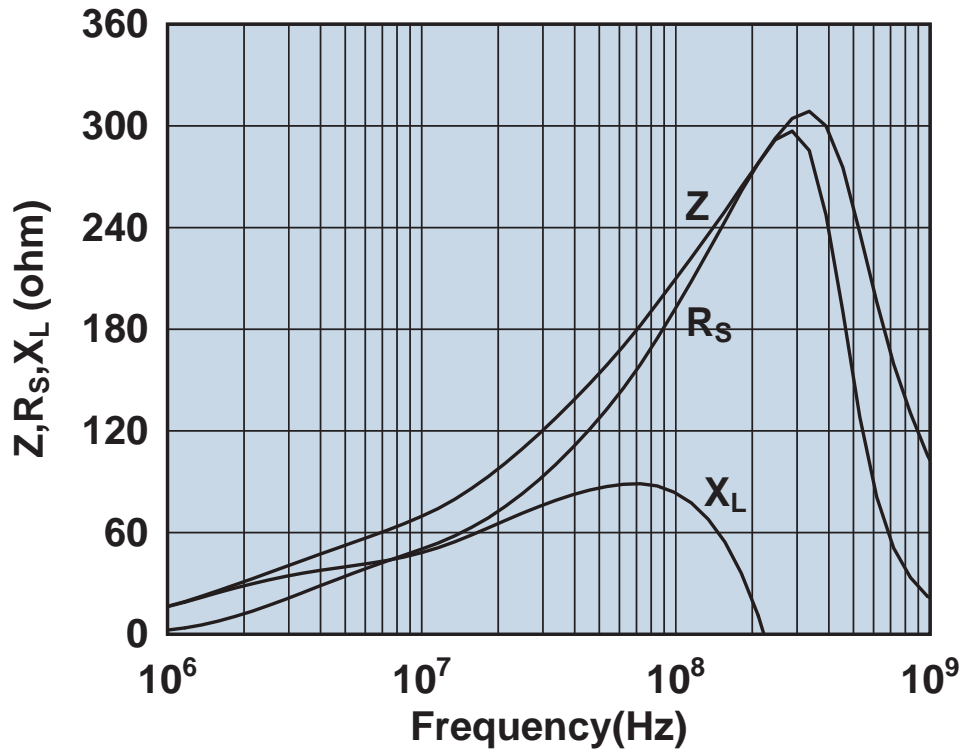

Impedance, reactance, and resistance vs. frequency.

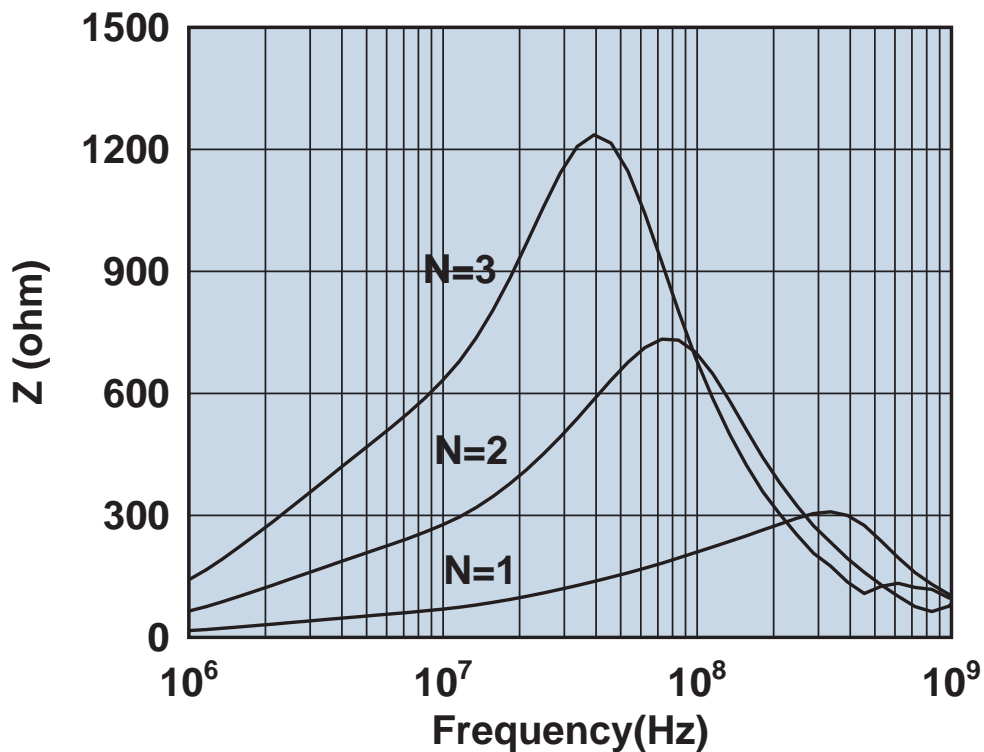

Impedance vs. frequency with one, two, and three turns.

2631173951

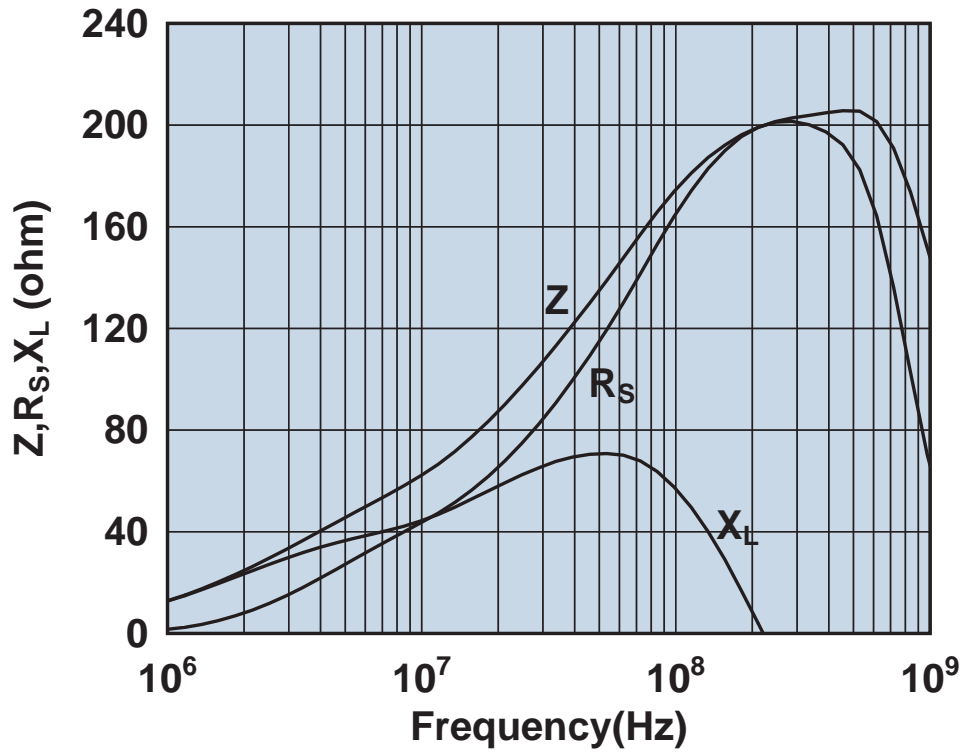

Impedance, reactance, and resistance vs. frequency.

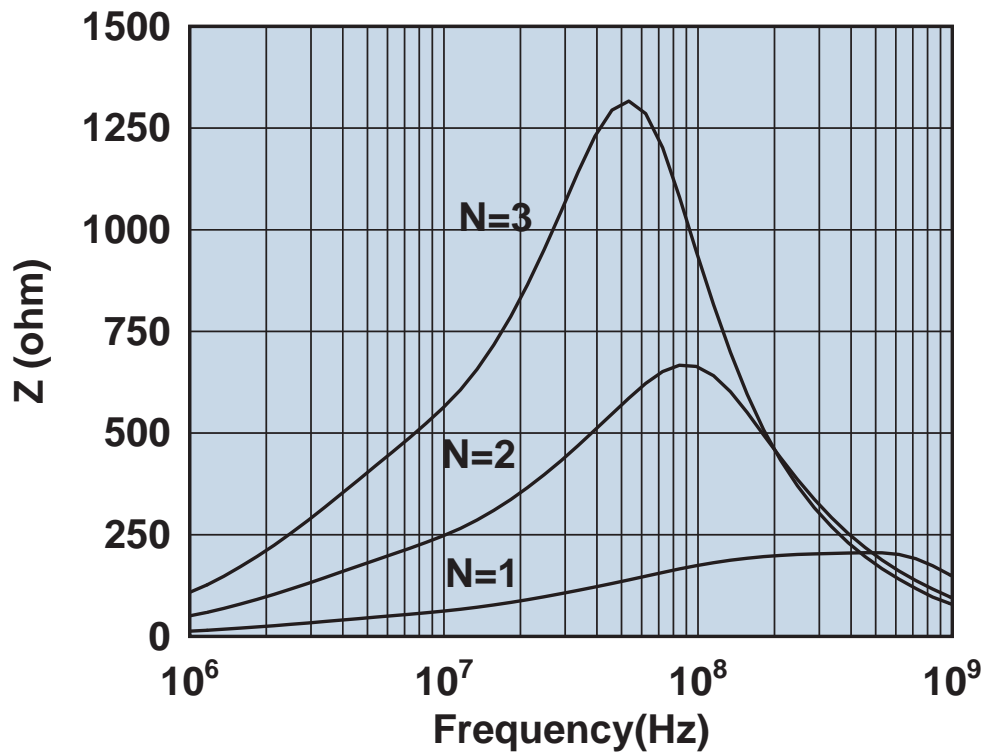

Impedance vs. frequency with one, two, and three turns.

2631176451

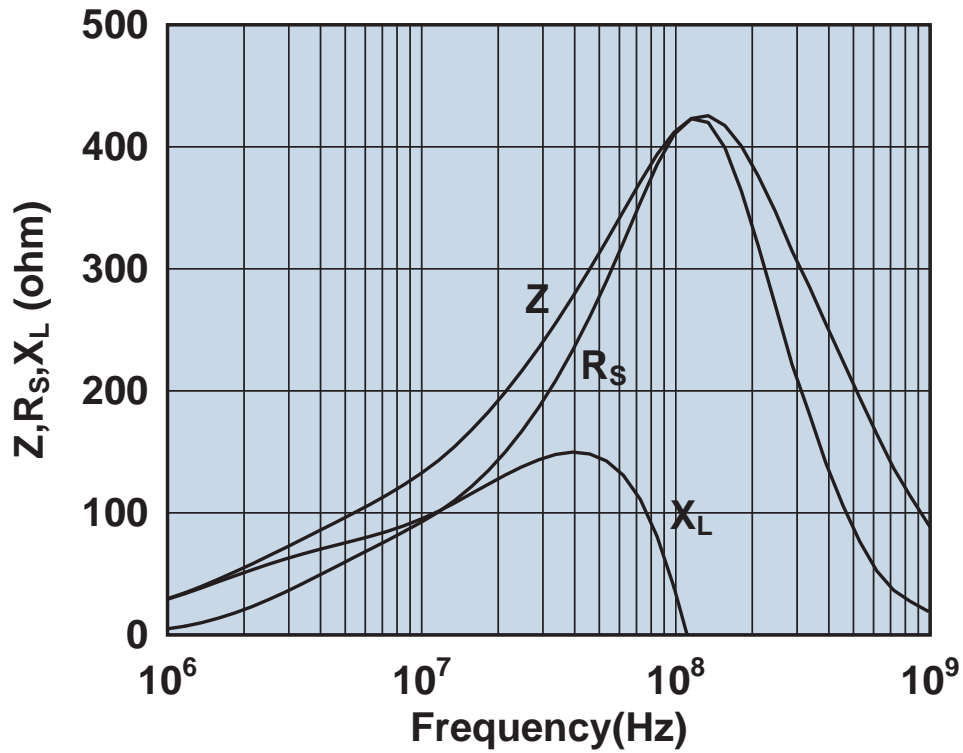

Impedance, reactance, and resistance vs. frequency.

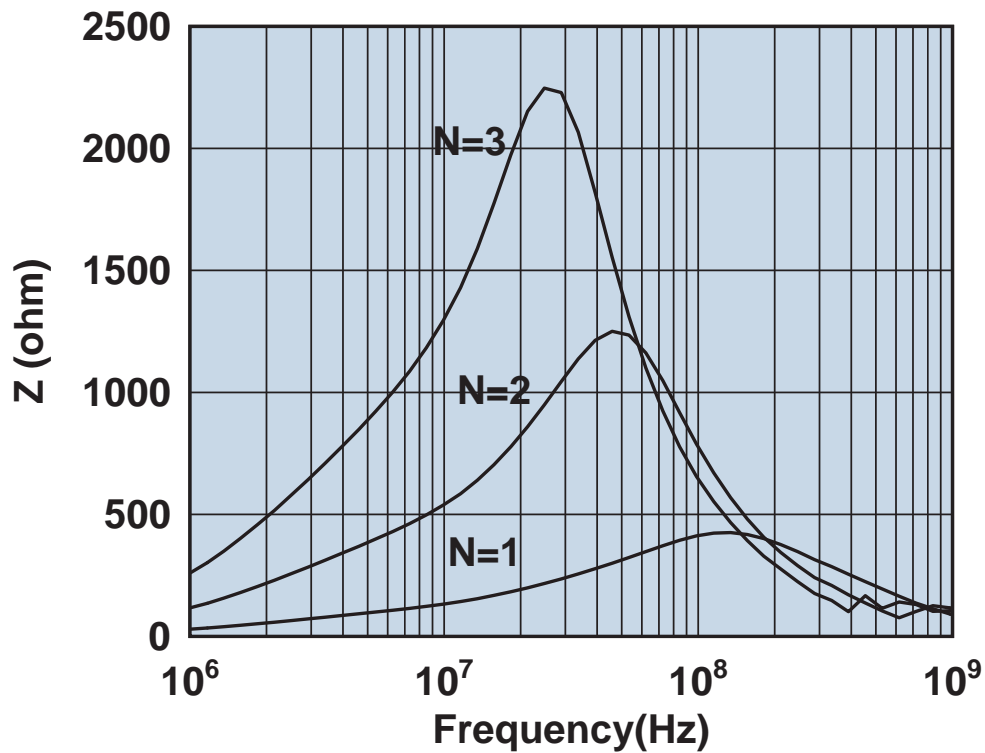

Impedance vs. frequency with one, two, and three turns.

2631177081

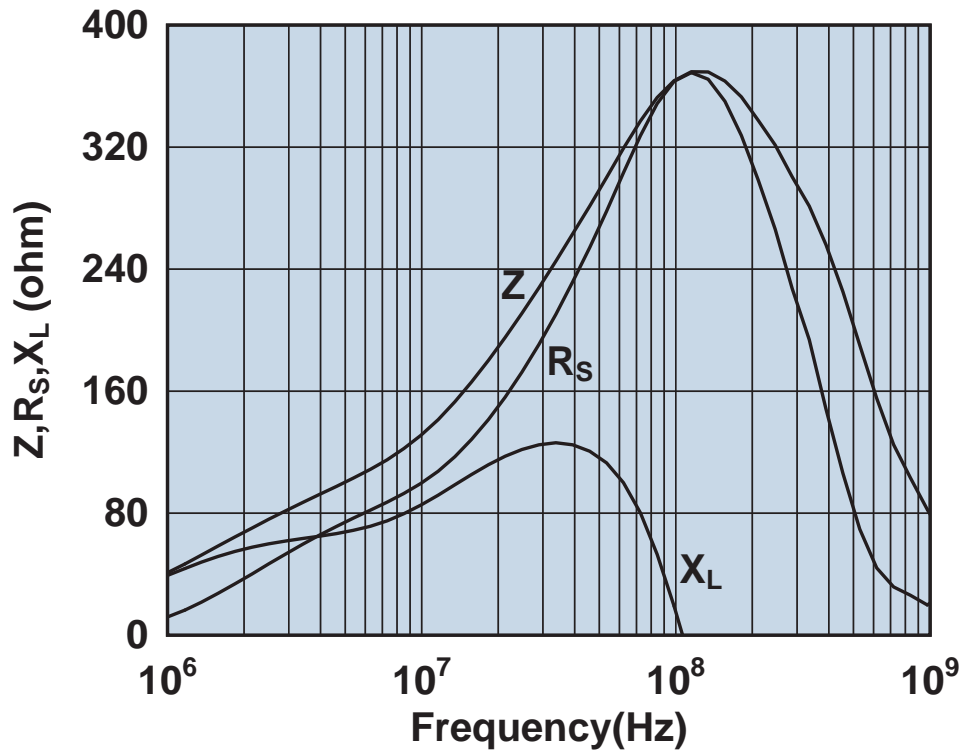

Impedance, reactance, and resistance vs. frequency.

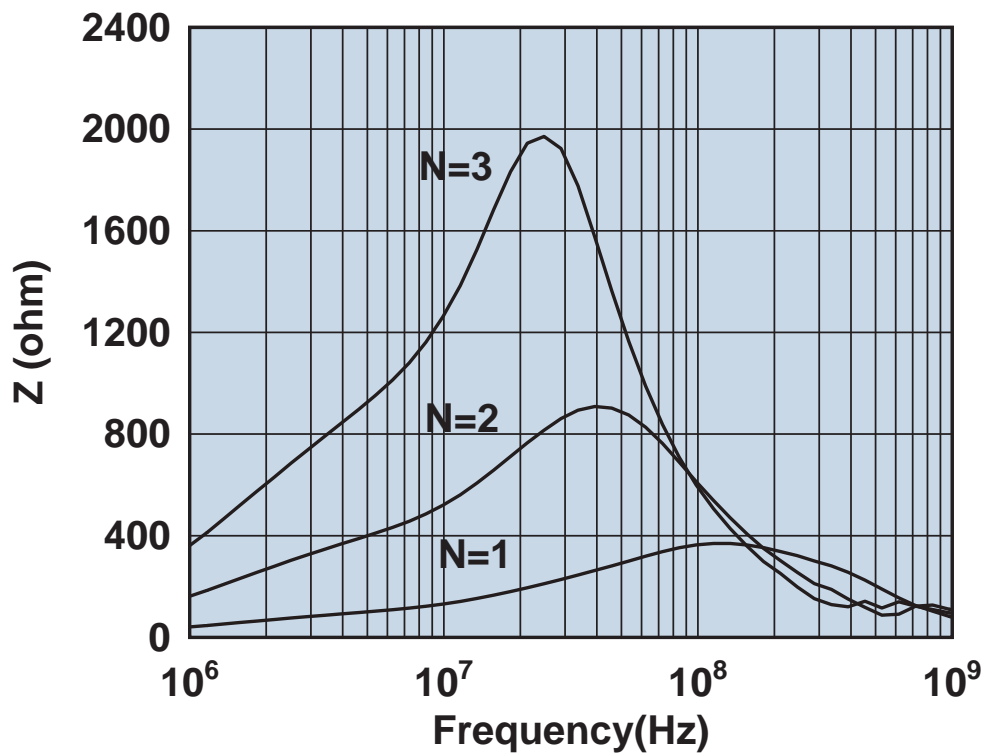

Impedance vs. frequency with one, two, and three turns.

2631178181

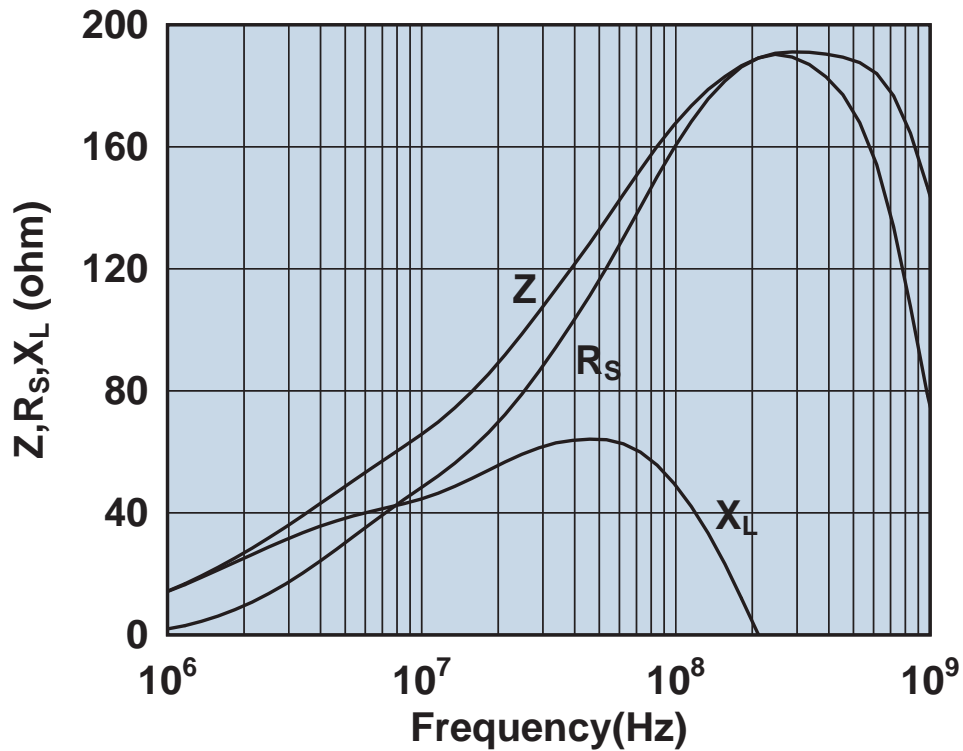

Impedance, reactance, and resistance vs. frequency.

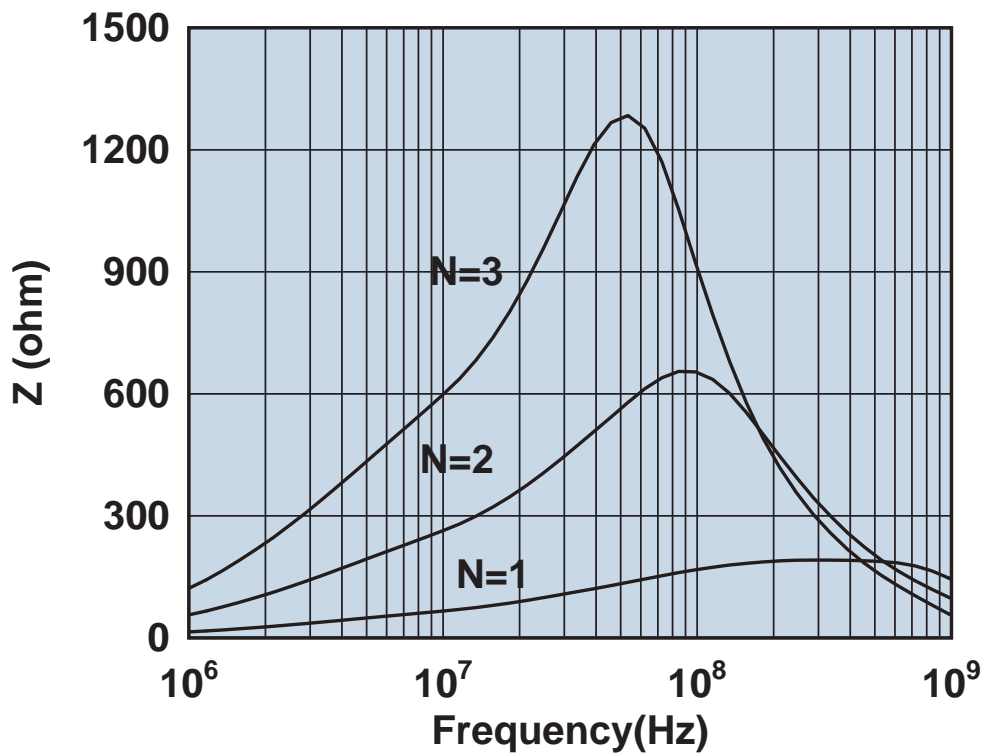

Impedance vs. frequency with one, two, and three turns.

2631178281

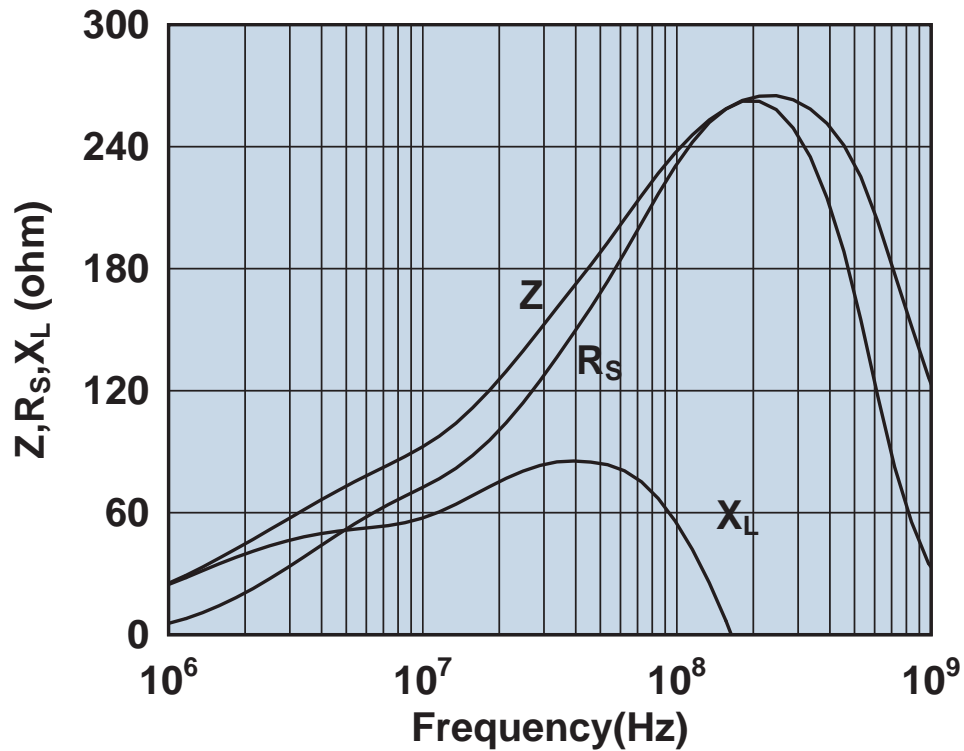

Impedance, reactance, and resistance vs. frequency.

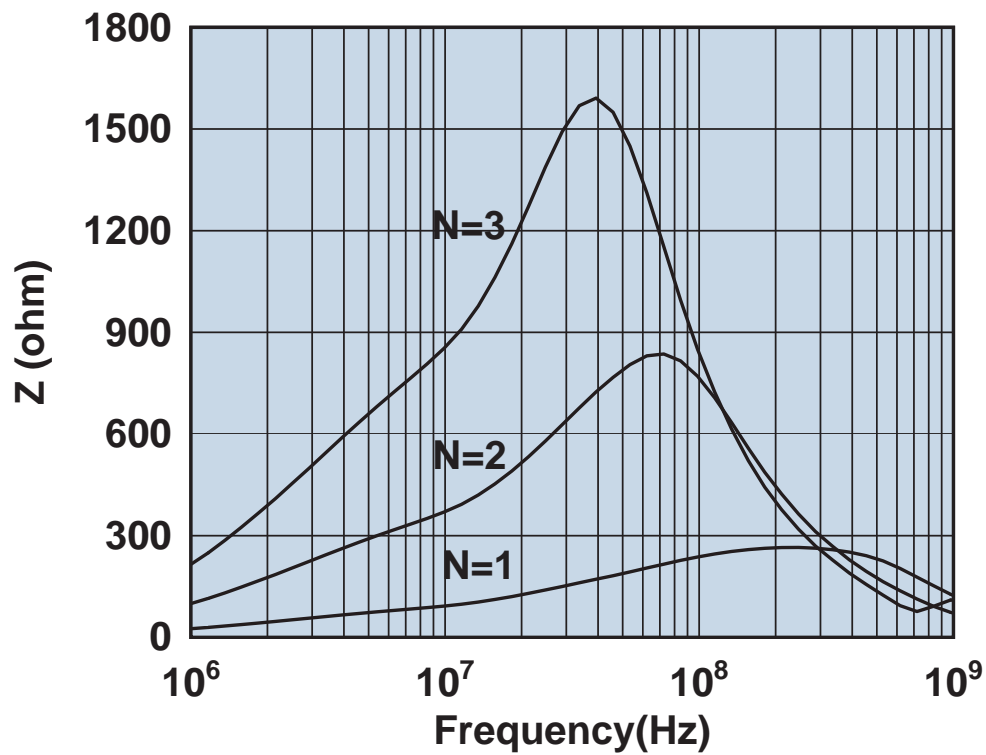

Impedance vs. frequency with one, two, and three turns.

2631250202

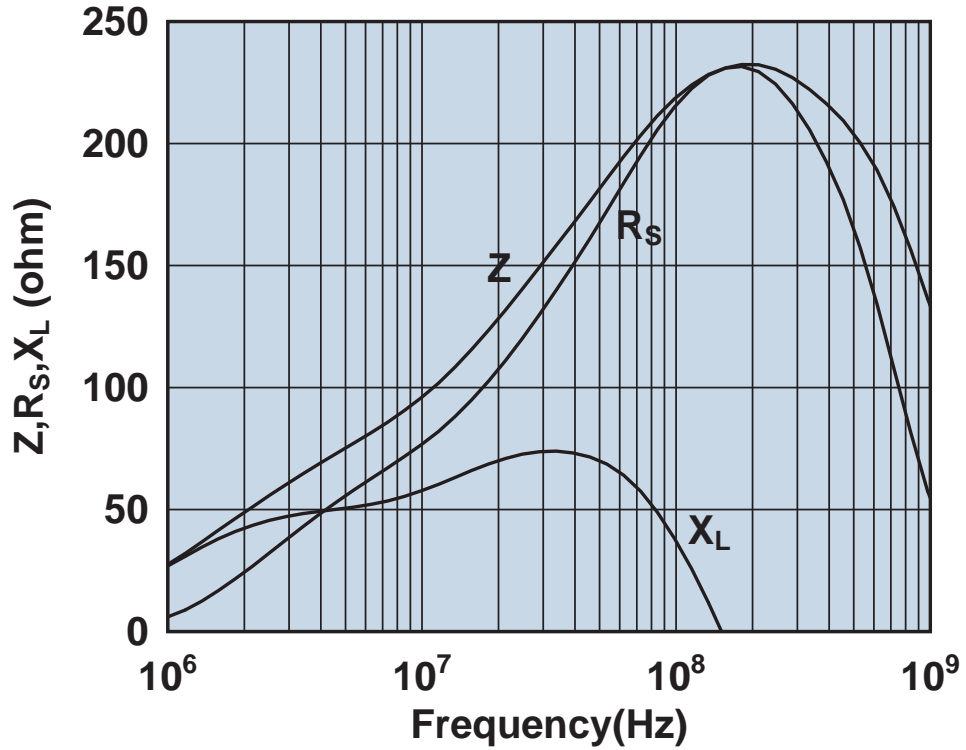

Impedance, reactance, and resistance vs. frequency.

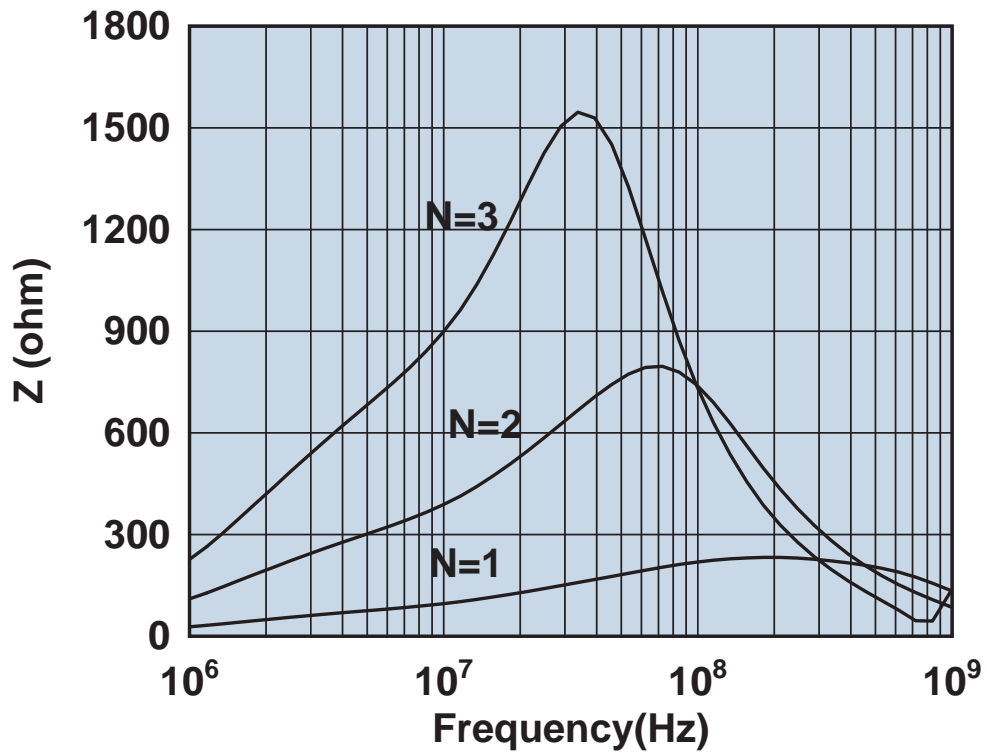

Impedance vs. frequency with one, two, and three turns.

2631480002

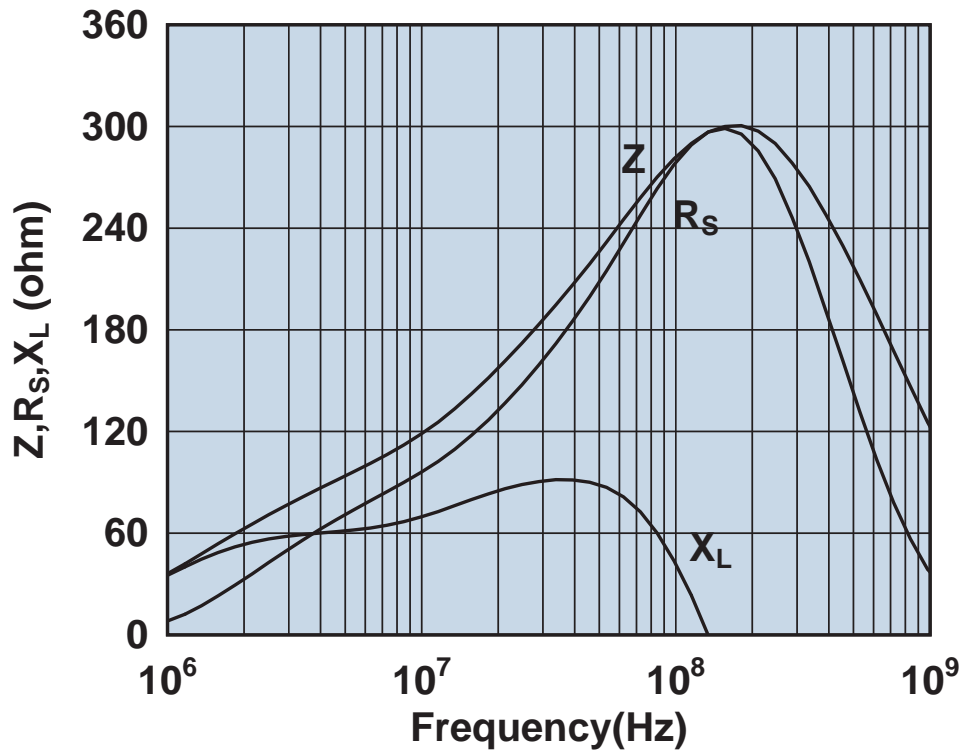

Impedance, reactance, and resistance vs. frequency.

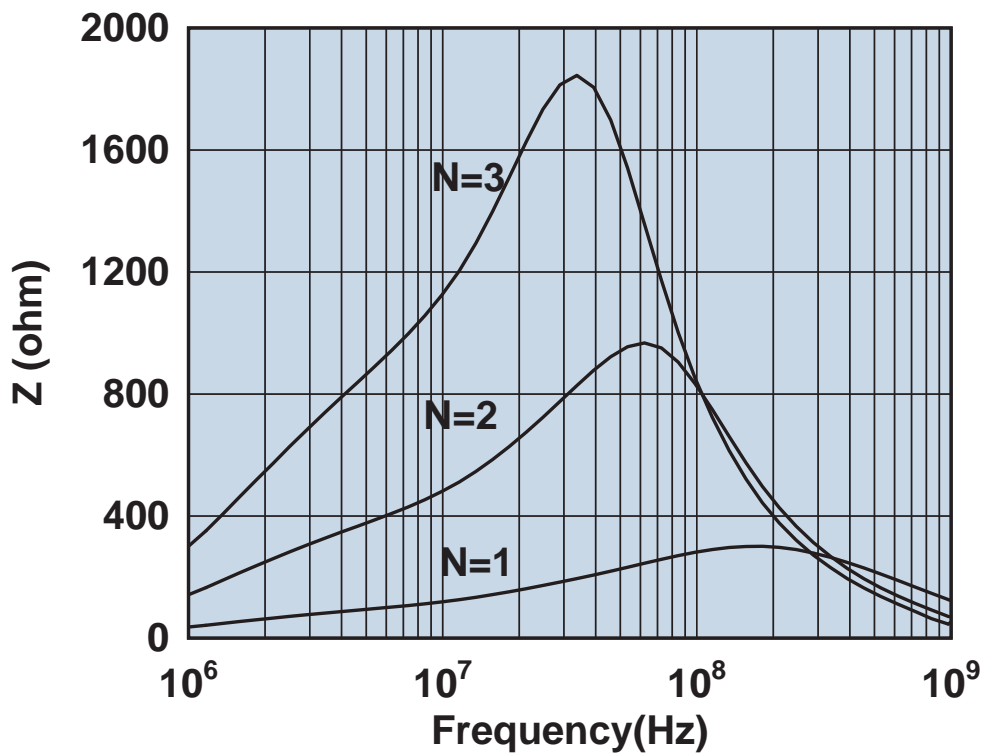

Impedance vs. frequency with one, two, and three turns.

2631480102

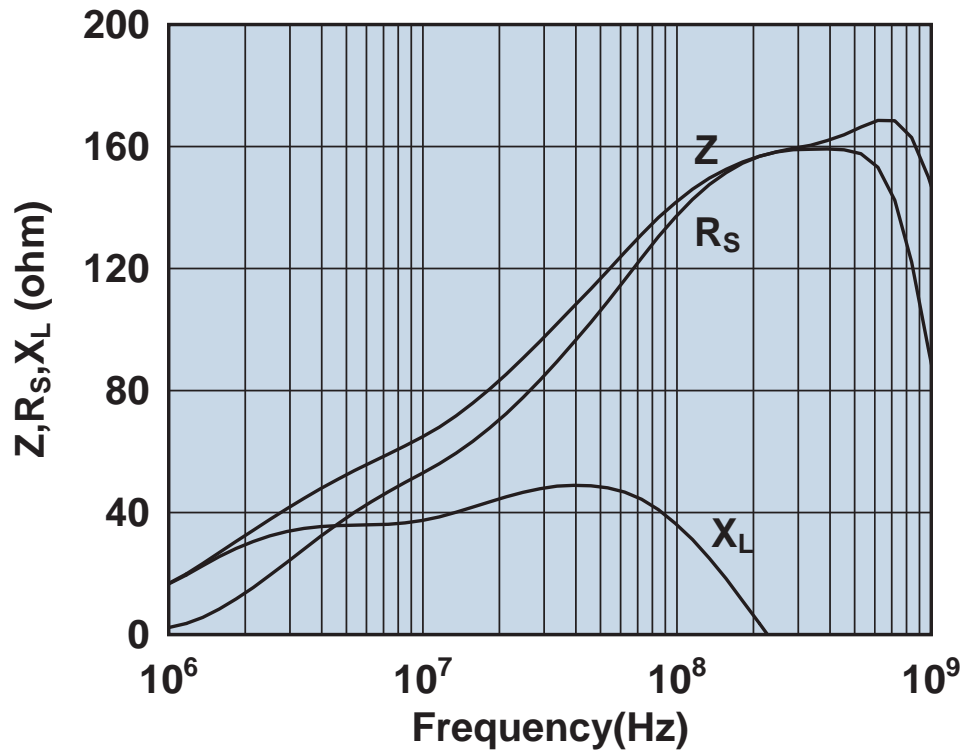

Impedance, reactance, and resistance vs. frequency.

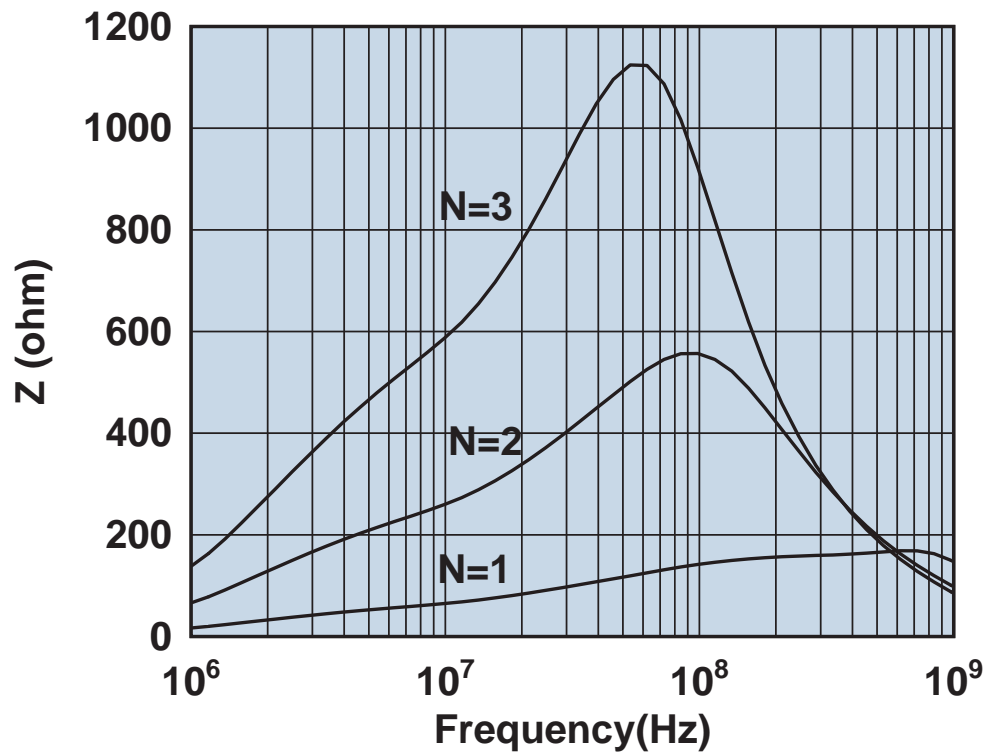

Impedance vs. frequency with one, two, and three turns.

2631540002

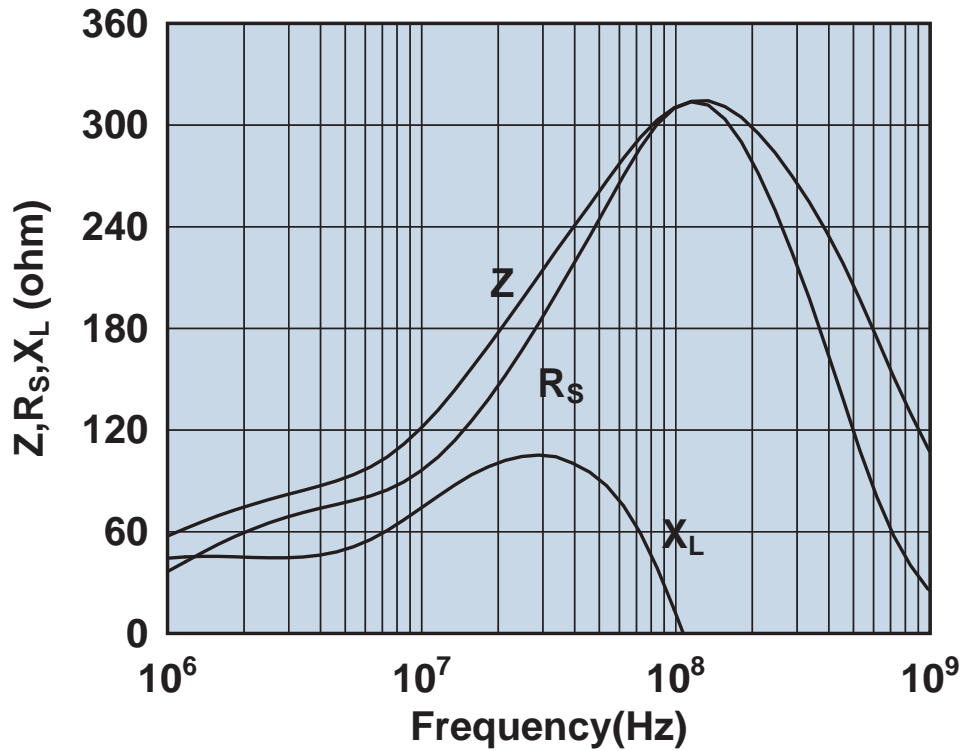

Impedance, reactance, and resistance vs. frequency.

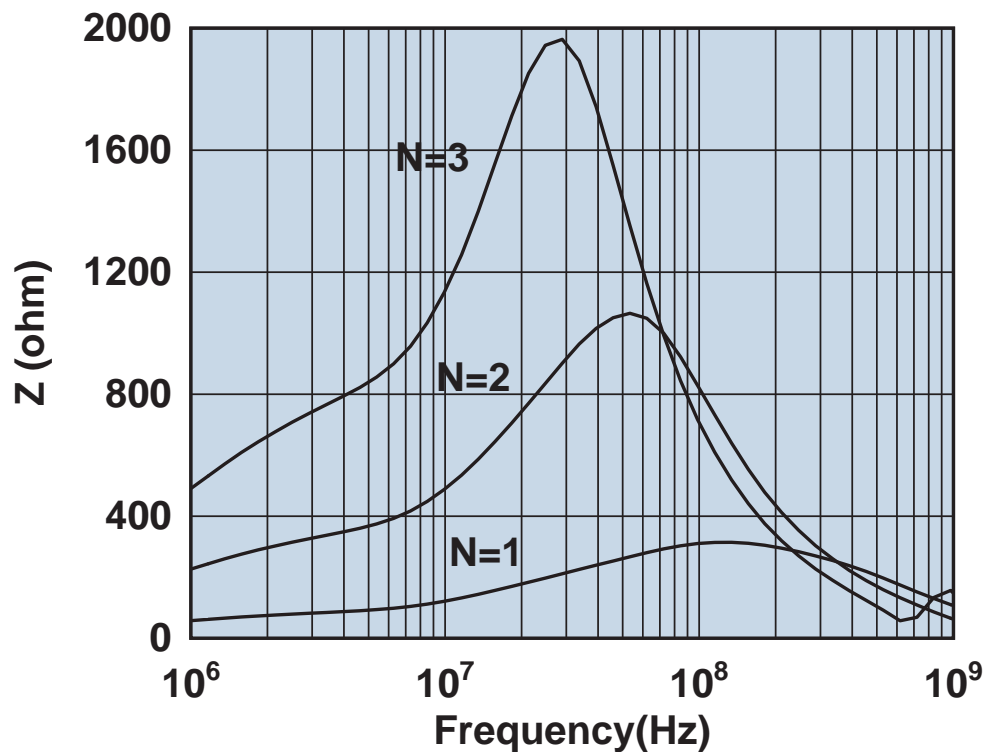

Impedance vs. frequency with one, two, and three turns.

2631540202

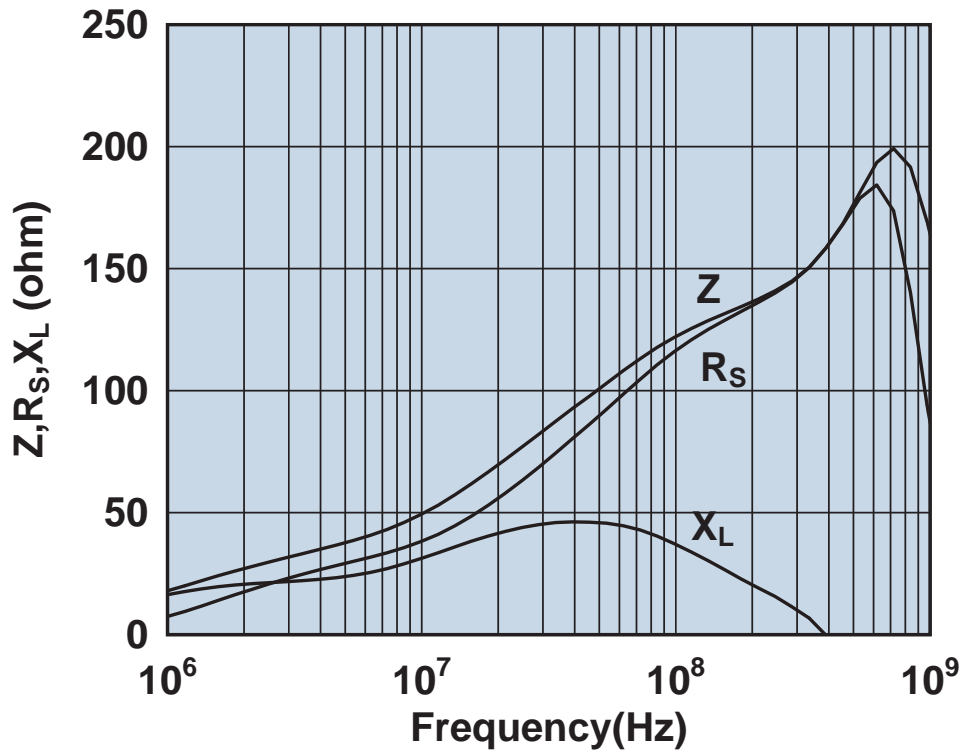

Impedance, reactance, and resistance vs. frequency.

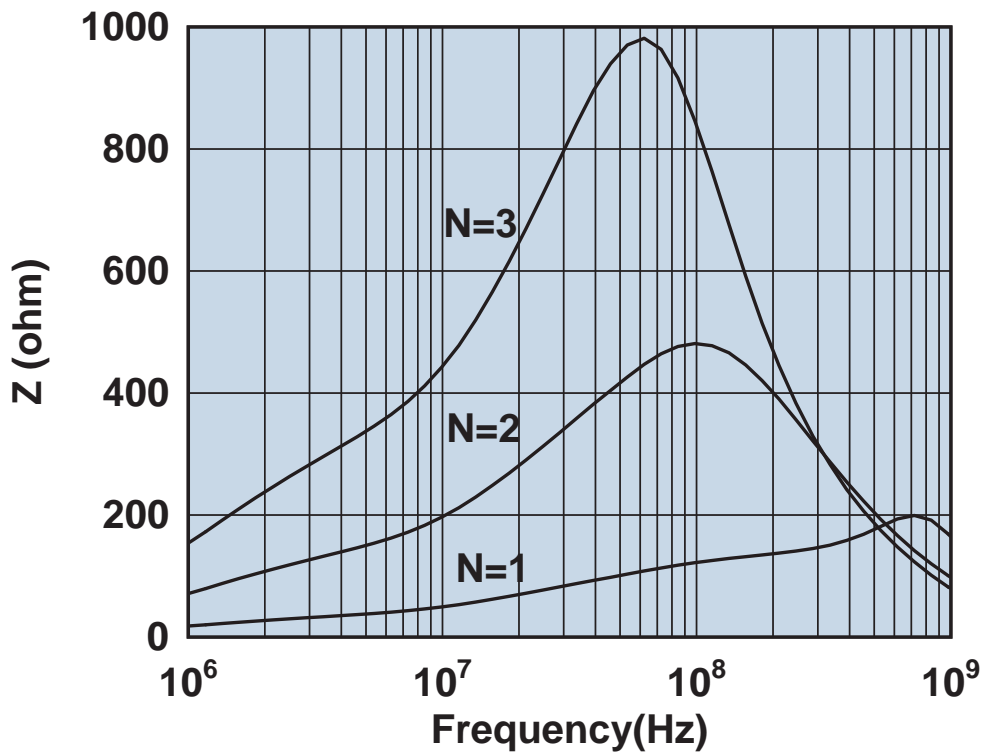

Impedance vs. frequency with one, two, and three turns.

2631625002

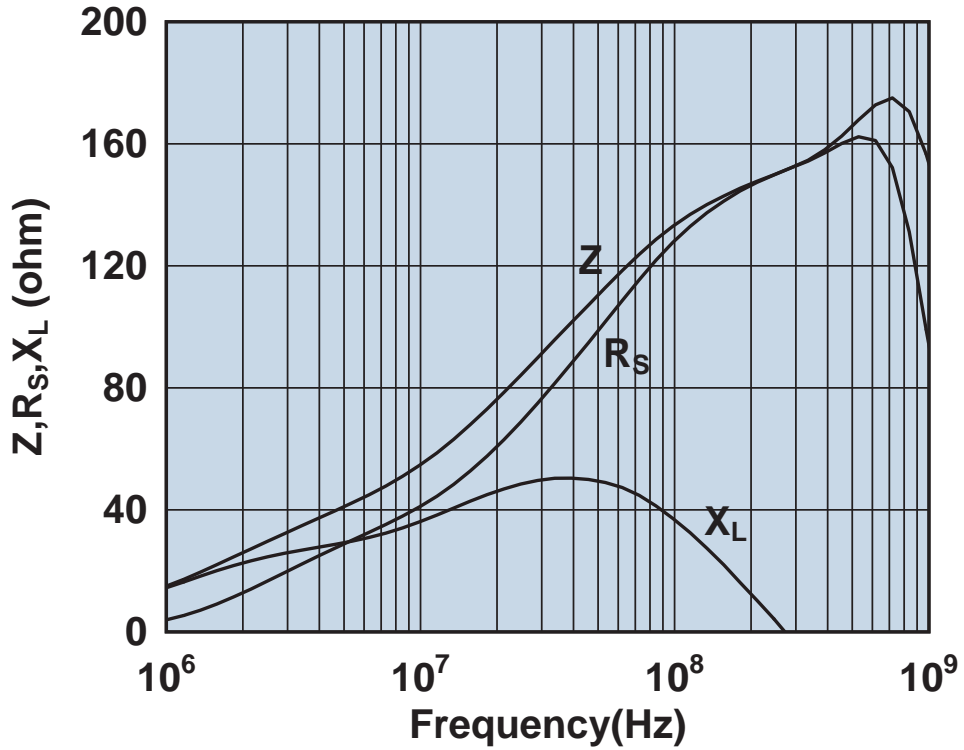

Impedance, reactance, and resistance vs. frequency.

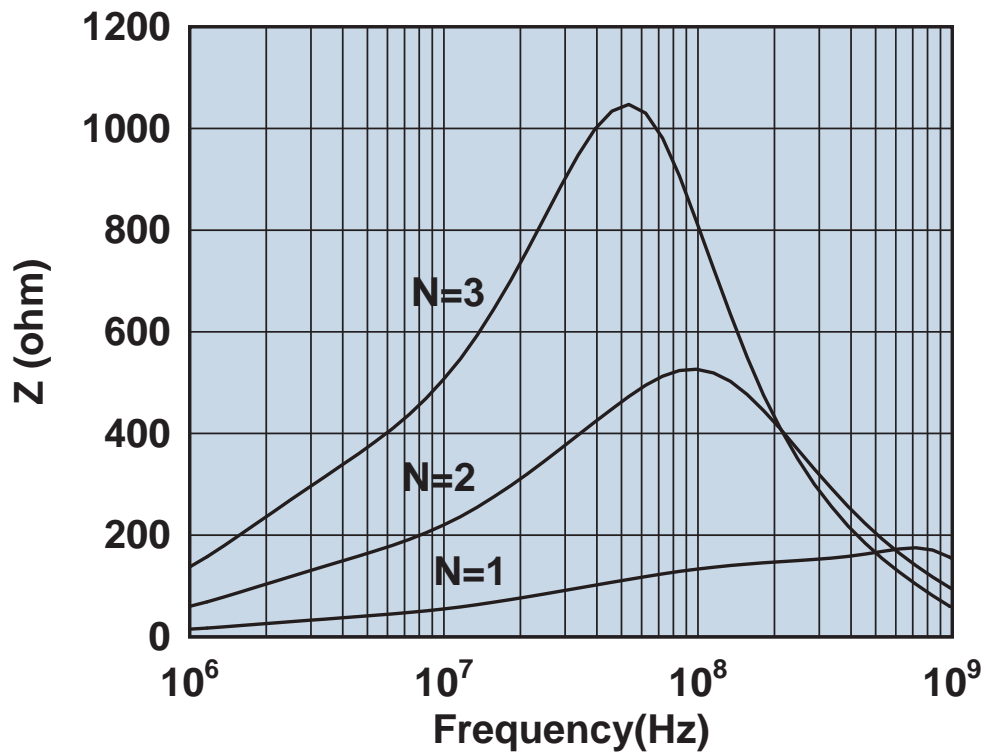

Impedance vs. frequency with one, two, and three turns.

2631625102

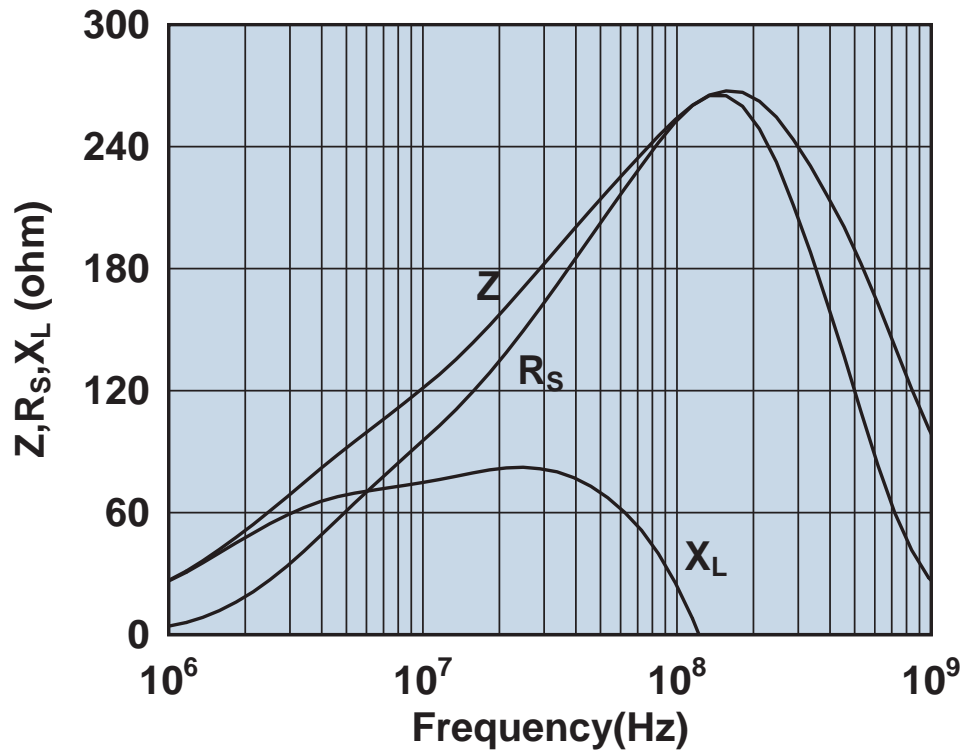

Impedance, reactance, and resistance vs. frequency.

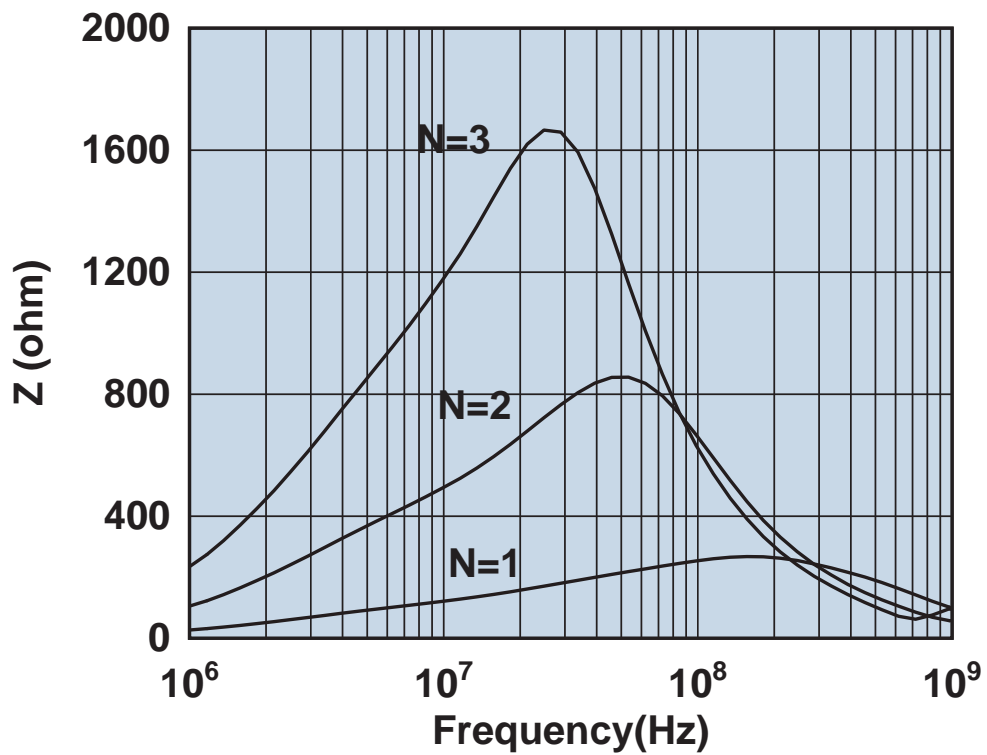

Impedance vs. frequency with one, two, and three turns.

2631626202

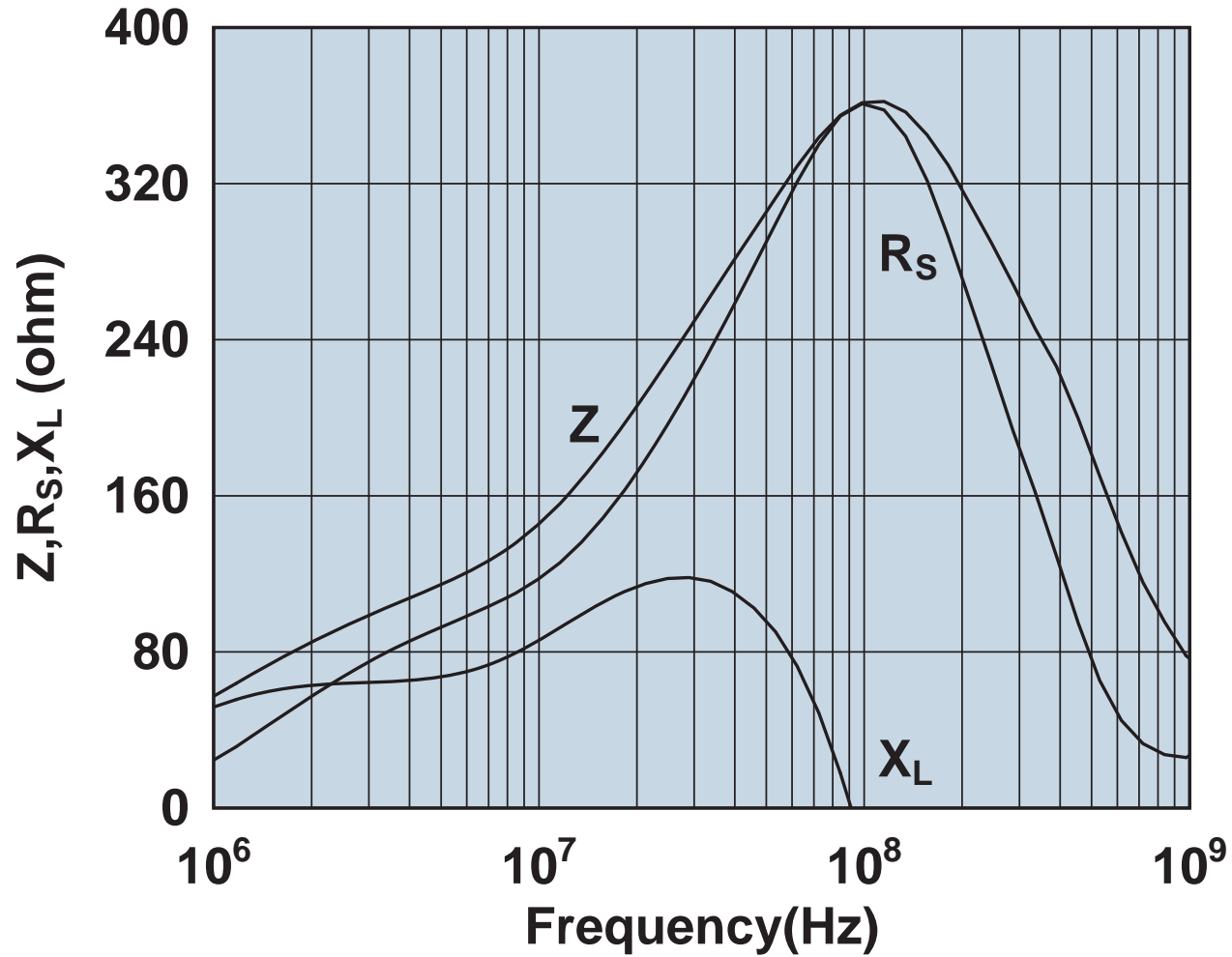

Impedance, reactance, and resistance vs. frequency.

2631626302

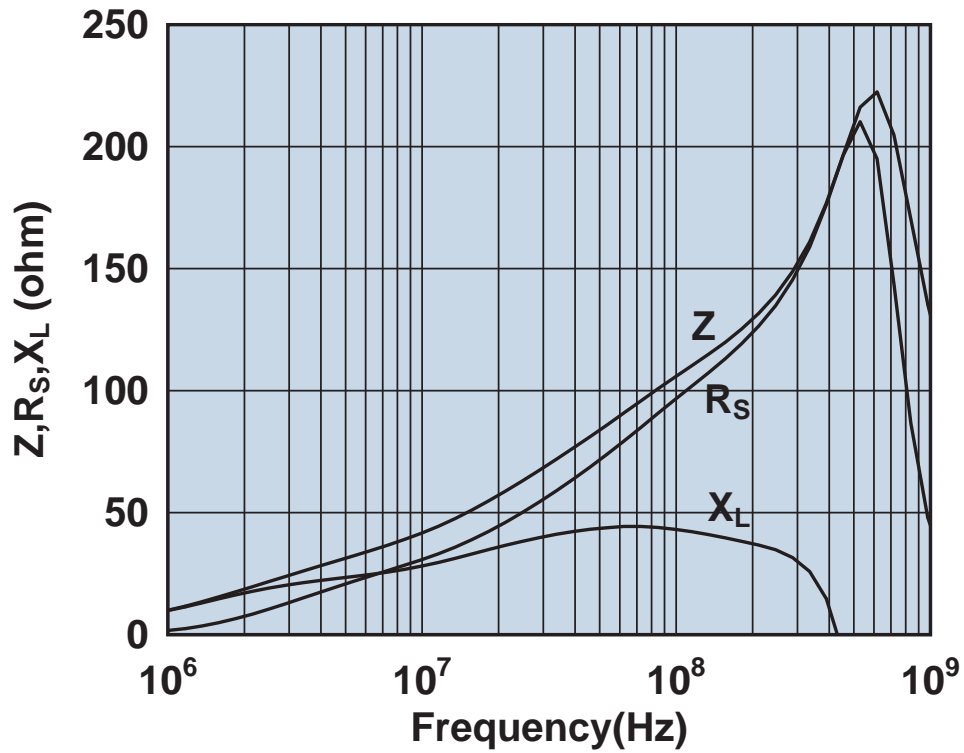

Impedance, reactance, and resistance vs. frequency.

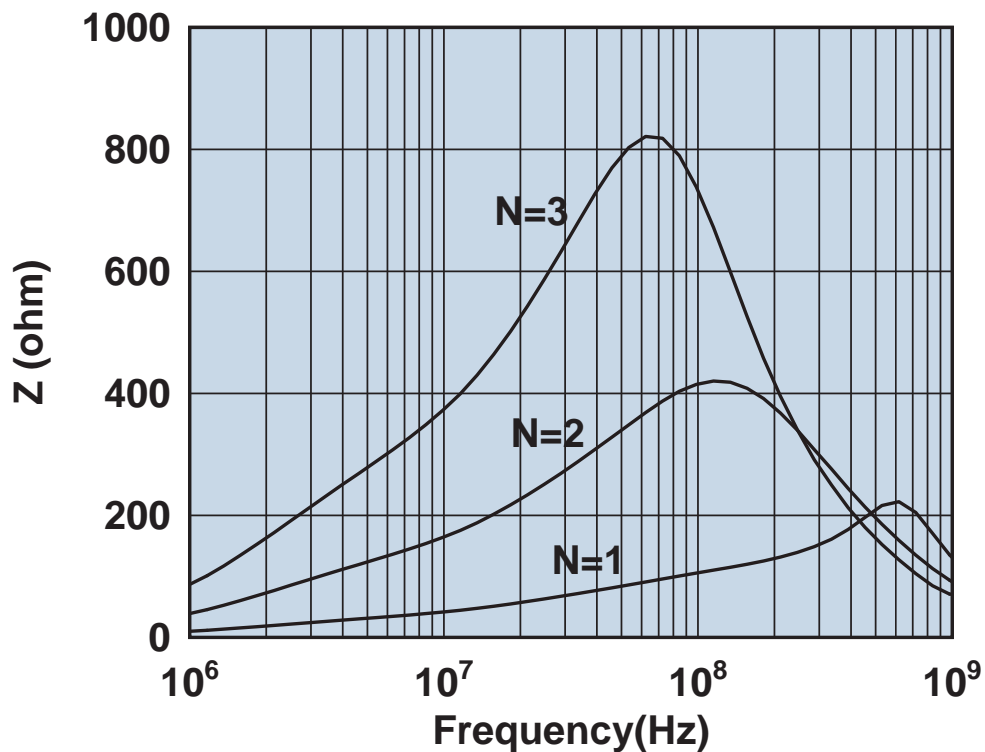

Impedance vs. frequency with one, two, and three turns.

2631626402

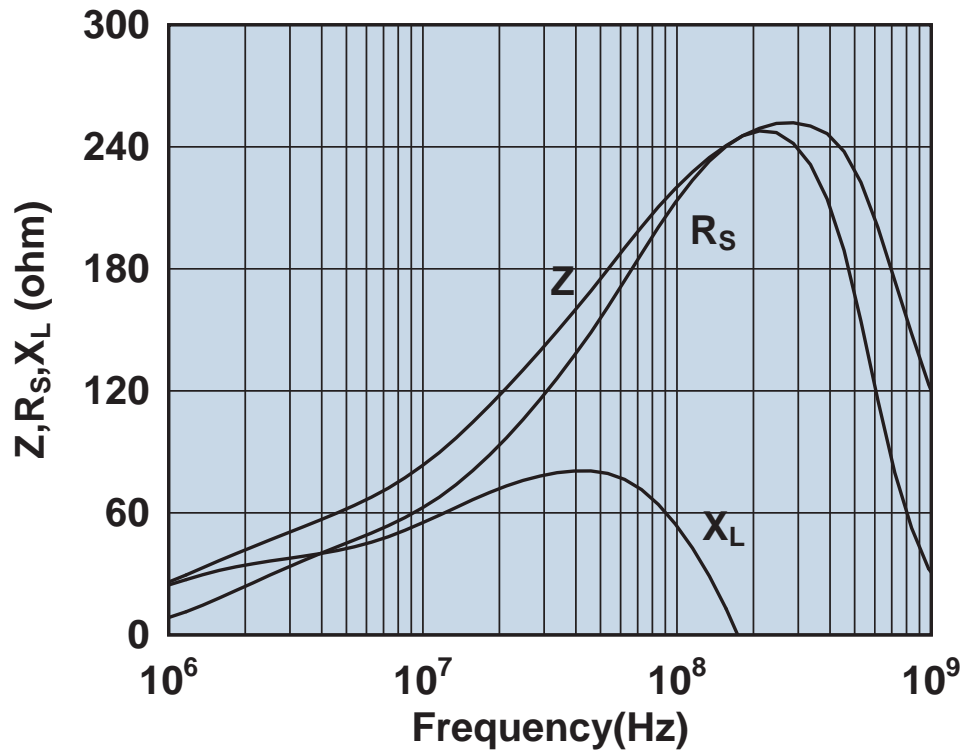

Impedance, reactance, and resistance vs. frequency.

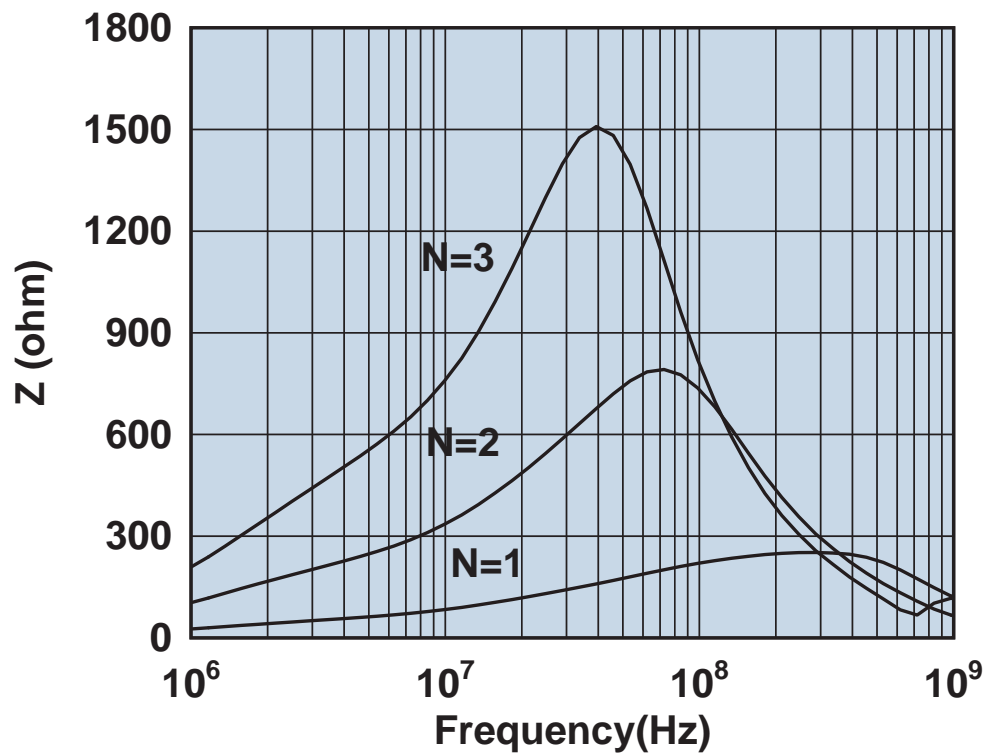

Impedance vs. frequency with one, two, and three turns.

2631665702

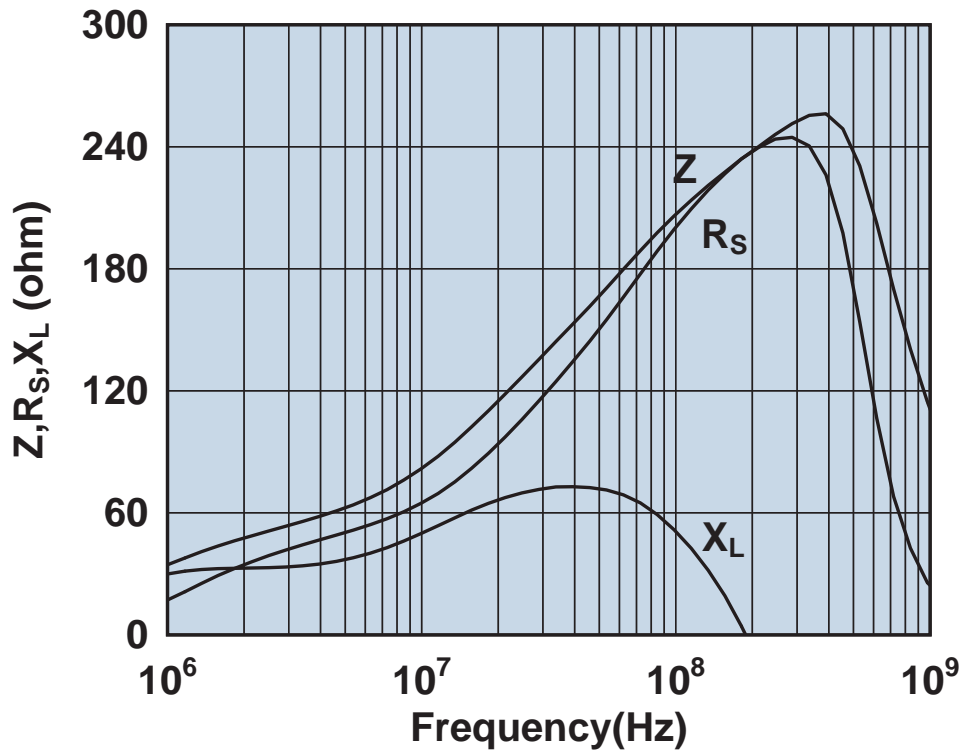

Impedance, reactance, and resistance vs. frequency.

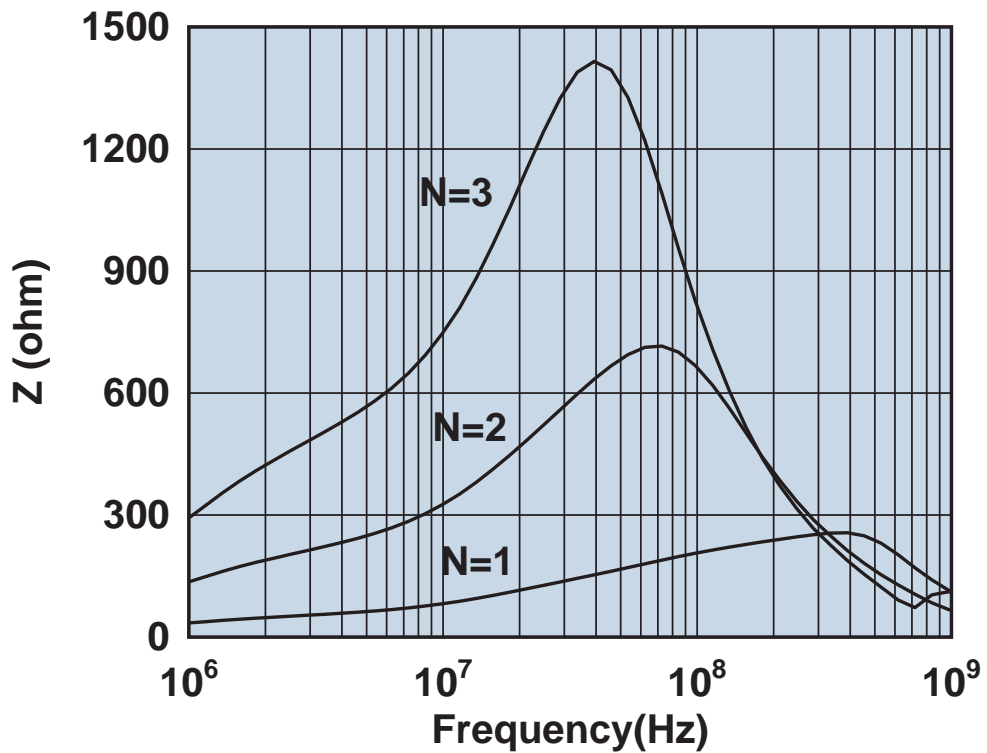

Impedance vs. frequency with one, two, and three turns.

2631665802

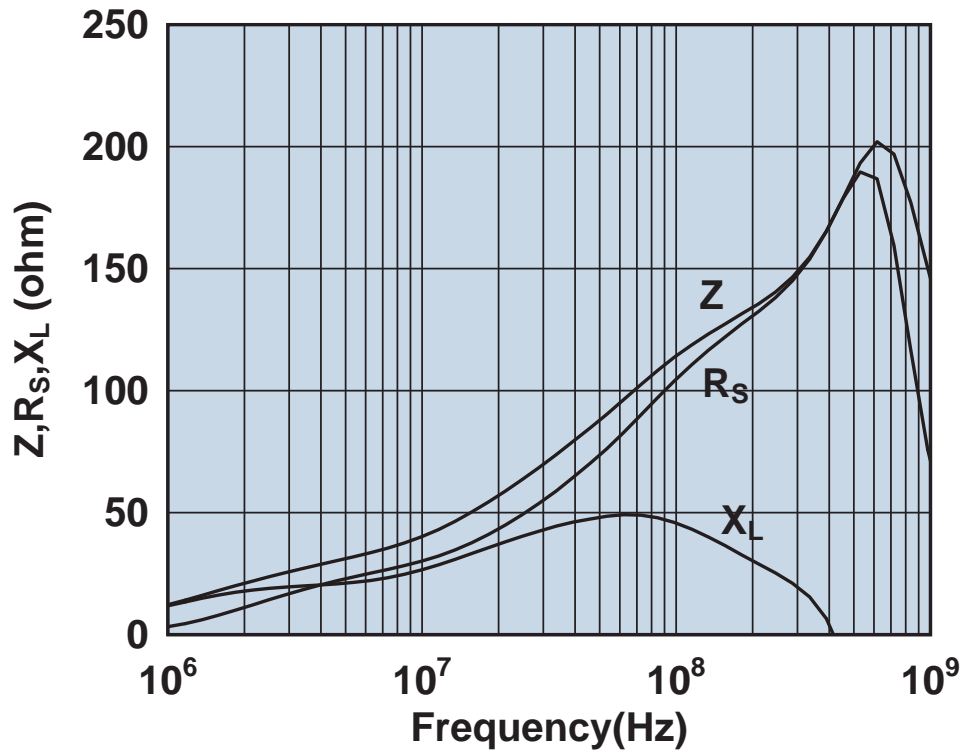

Impedance, reactance, and resistance vs. frequency.

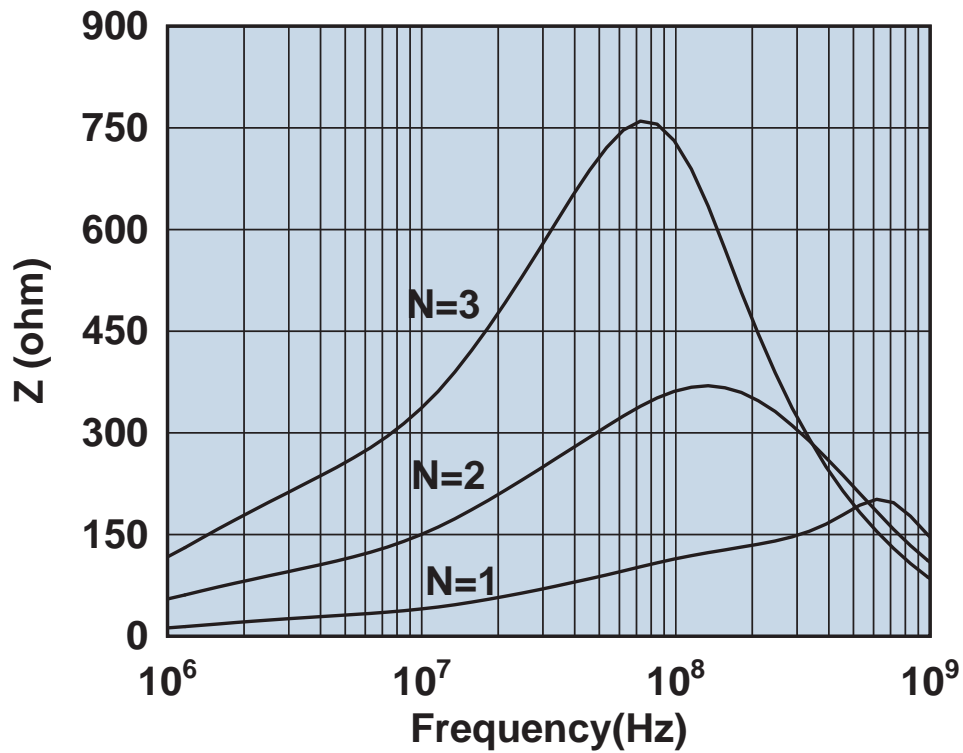

Impedance vs. frequency with one, two, and three turns.

2631801202

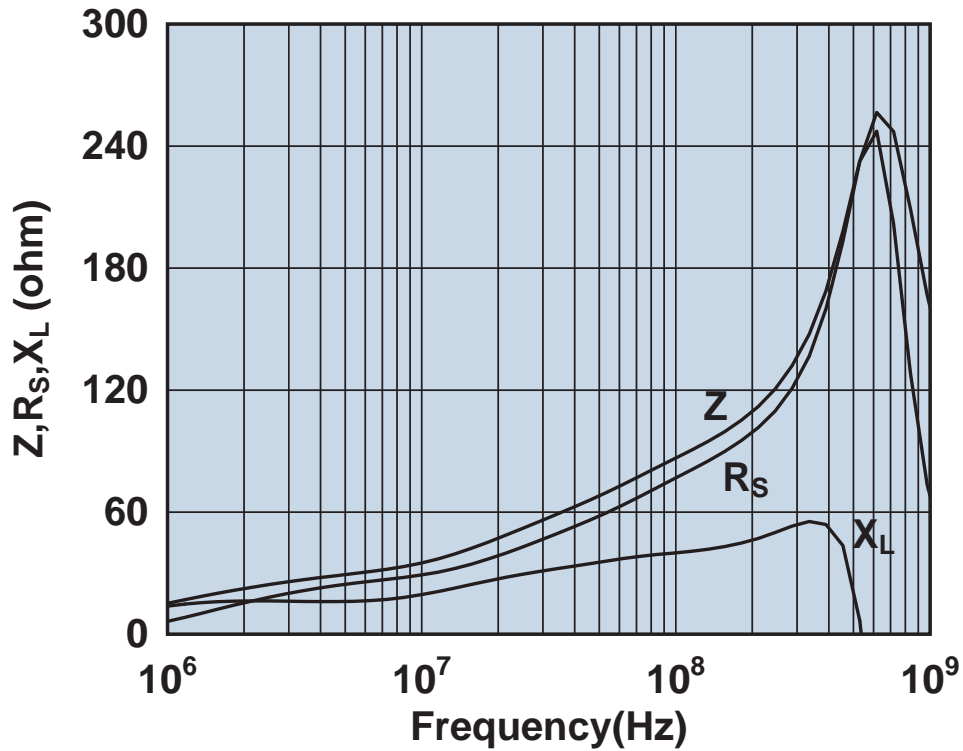

Impedance, reactance, and resistance vs. frequency.

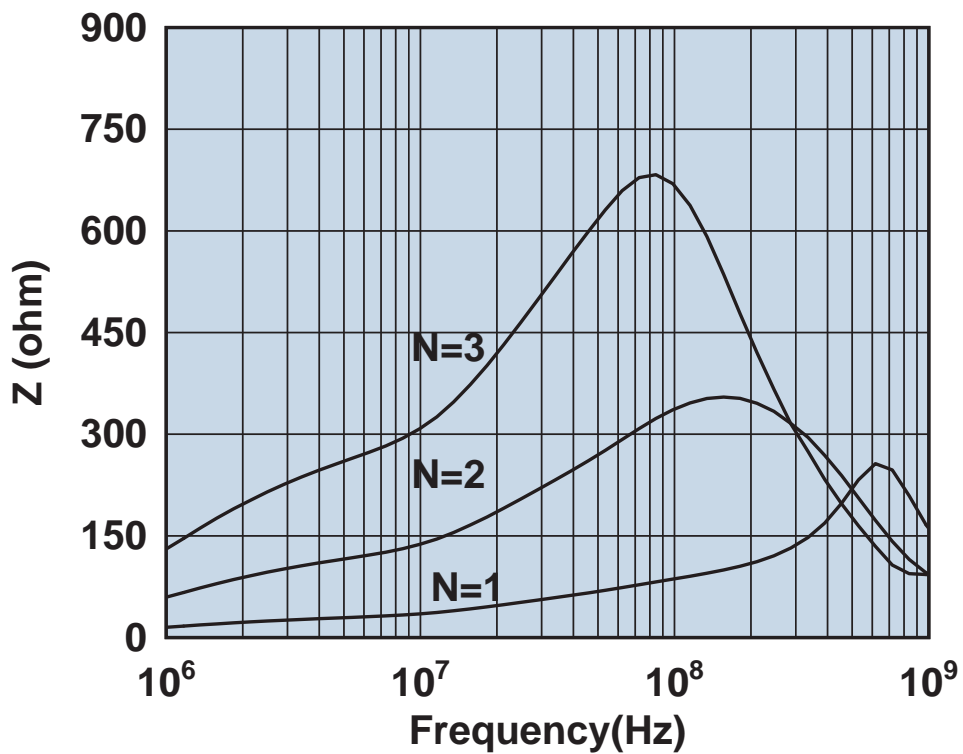

Impedance vs. frequency with one, two, and three turns.

2631803802

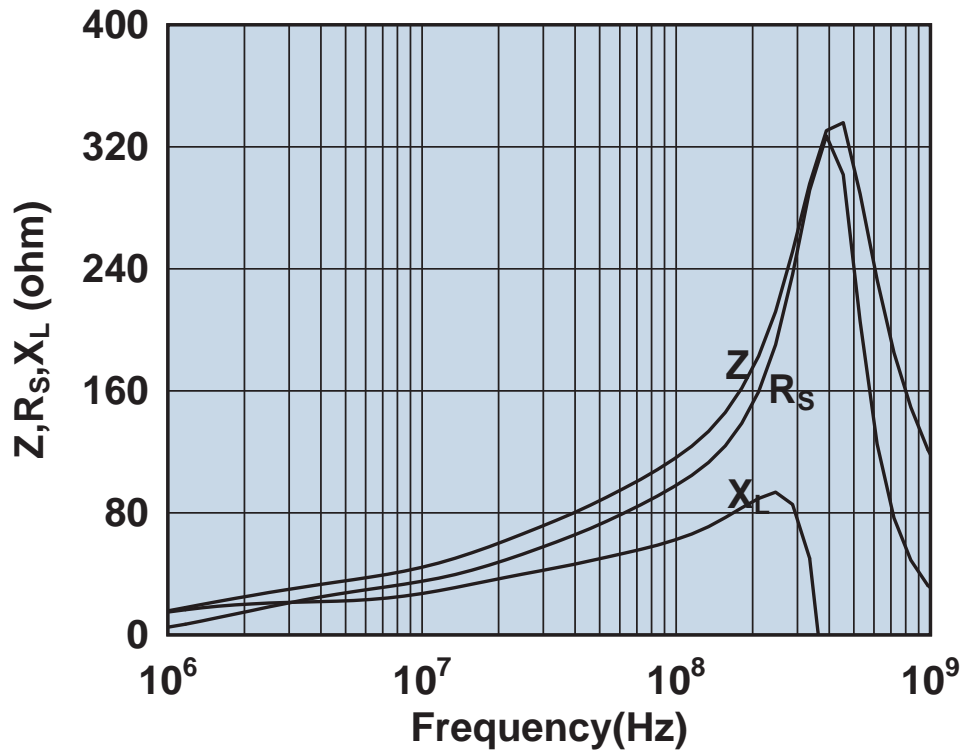

Impedance, reactance, and resistance vs. frequency.

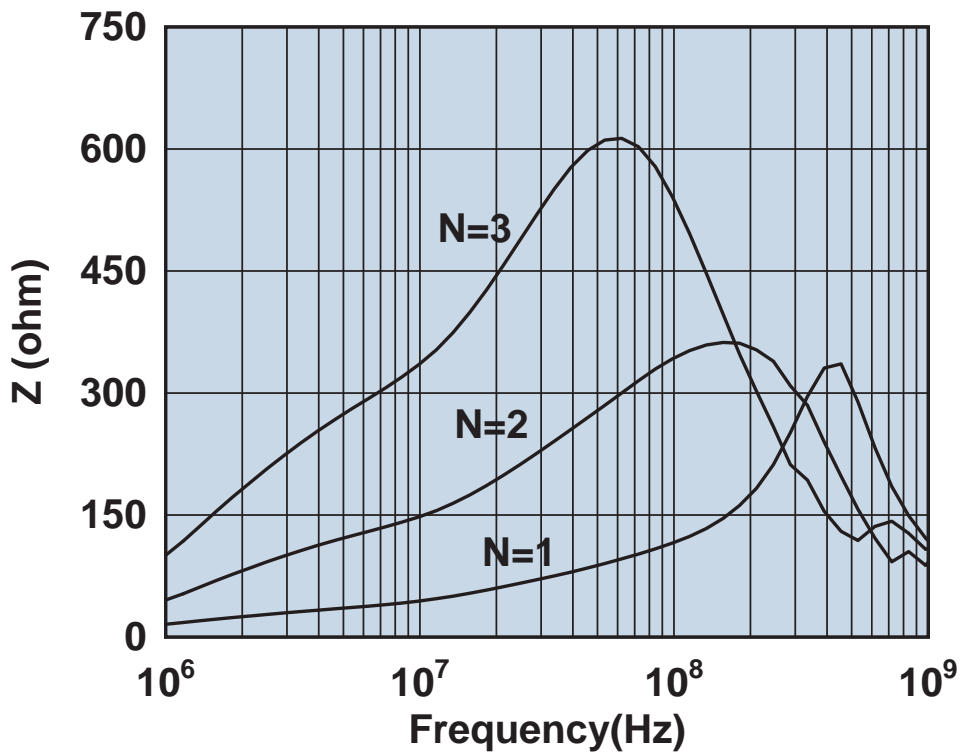

Impedance vs. frequency with one, two, and three turns.

2643102002

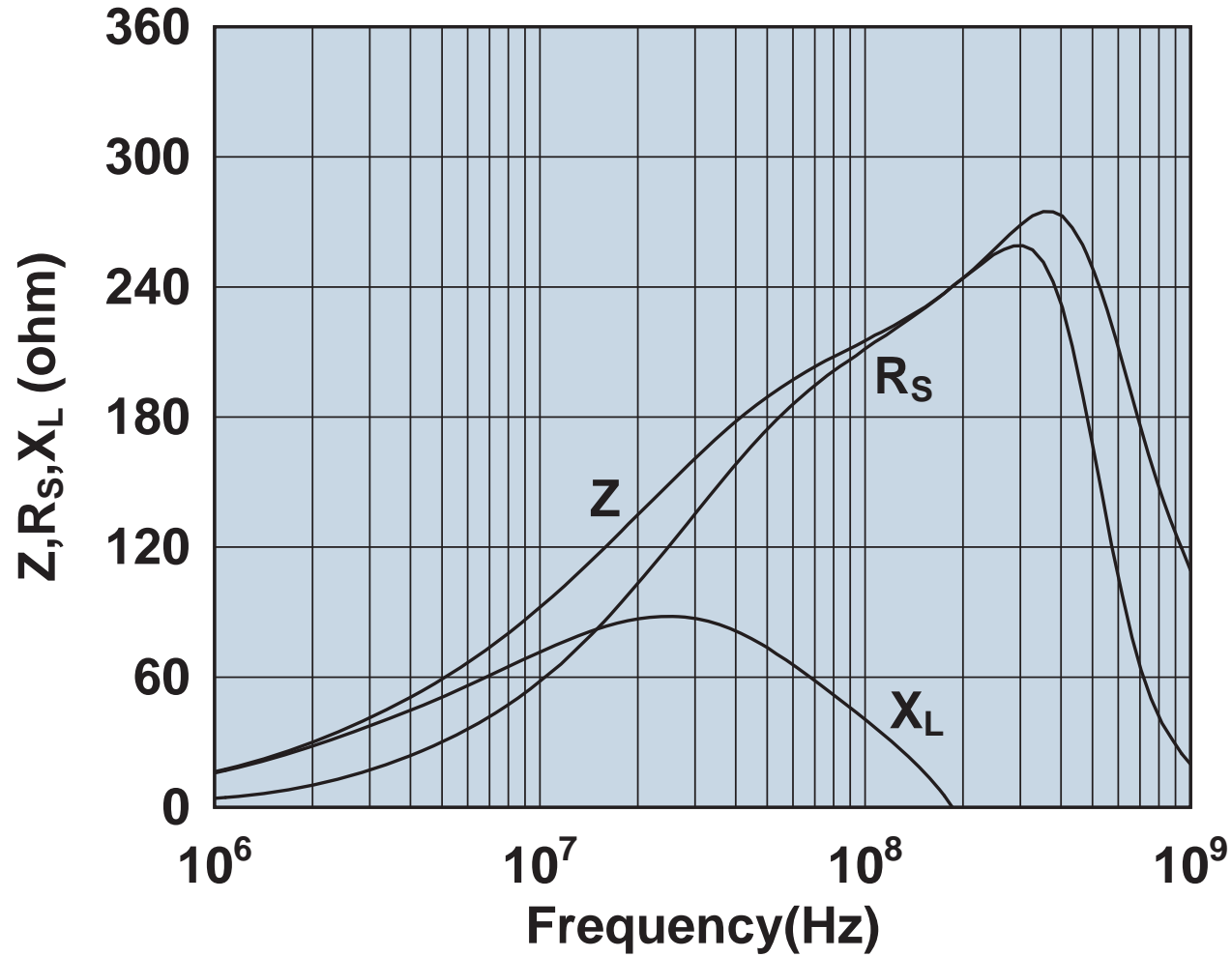

Impedance, reactance, and resistance vs. frequency.

2643102402

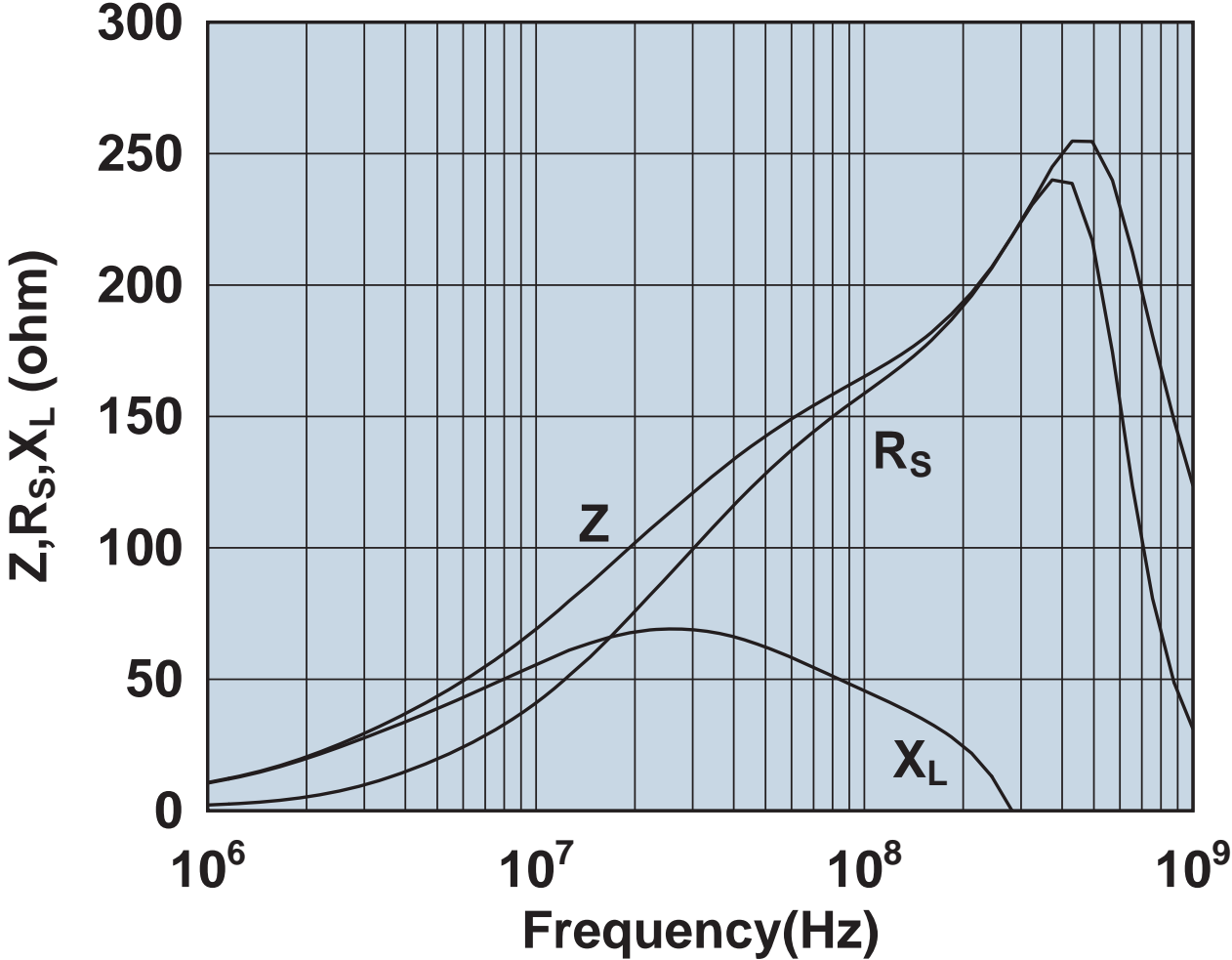

Impedance, reactance, and resistance vs. frequency.

2643103002

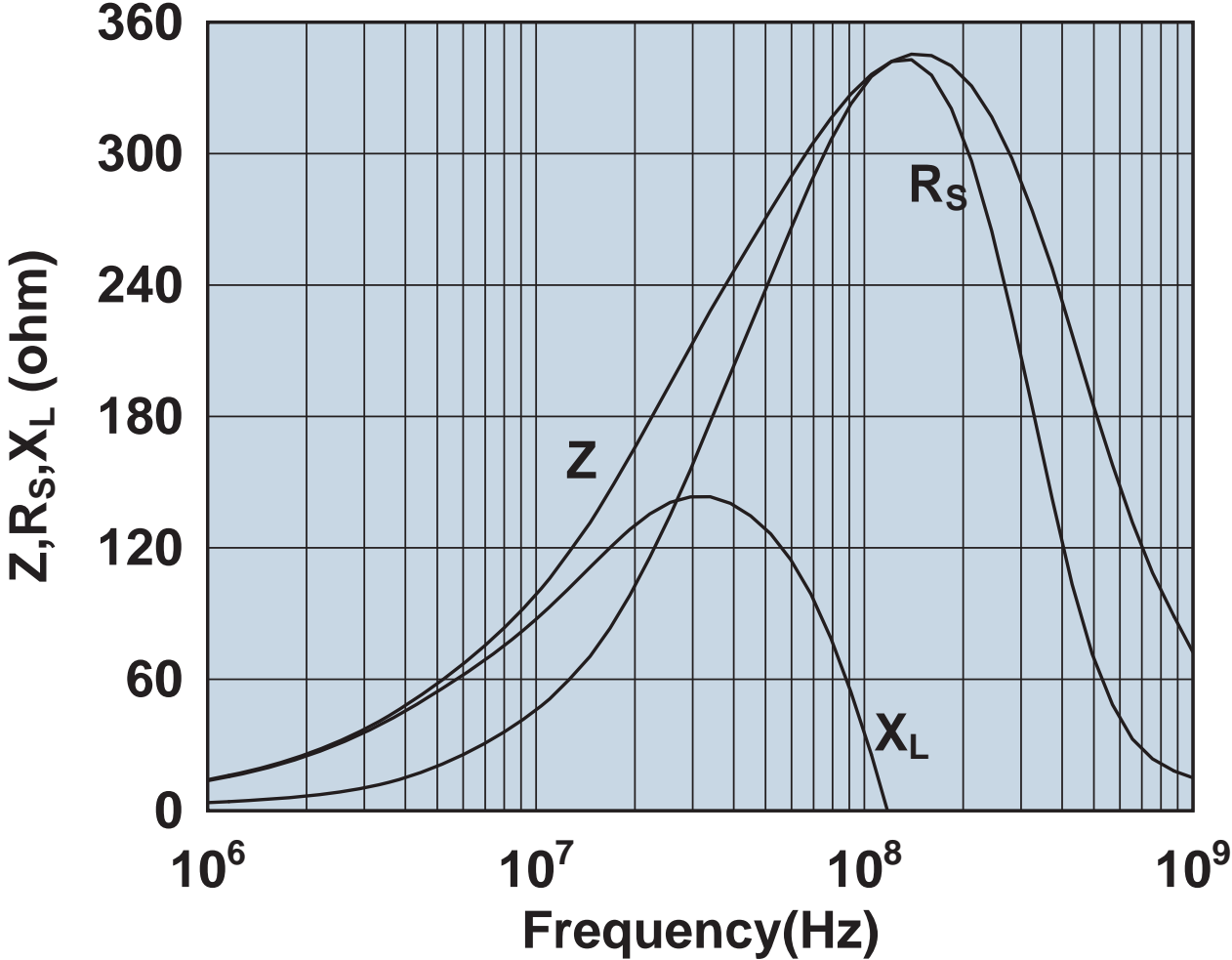

Impedance, reactance, and resistance vs. frequency.

2643103102

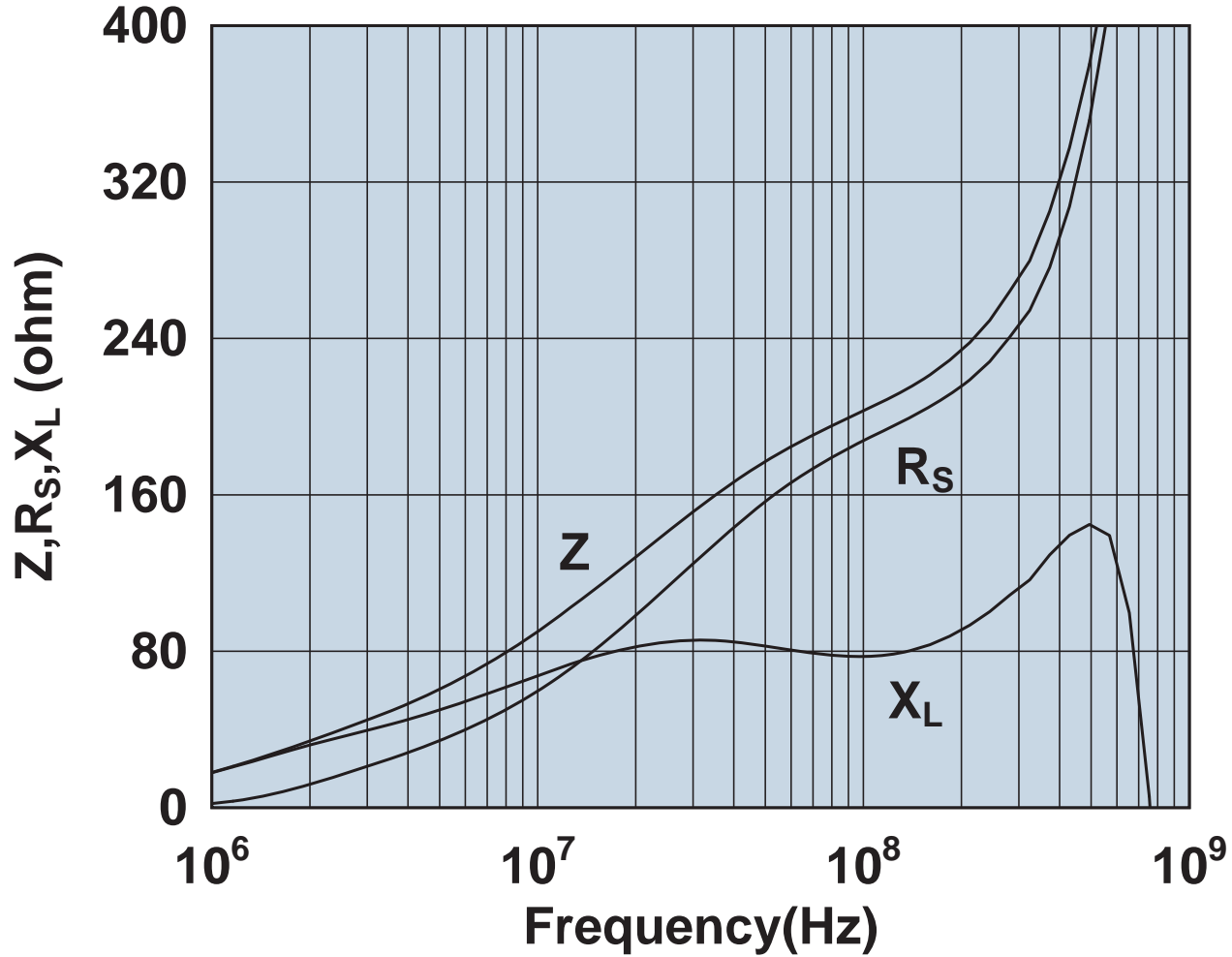

Impedance, reactance, and resistance vs. frequency.

2643163851

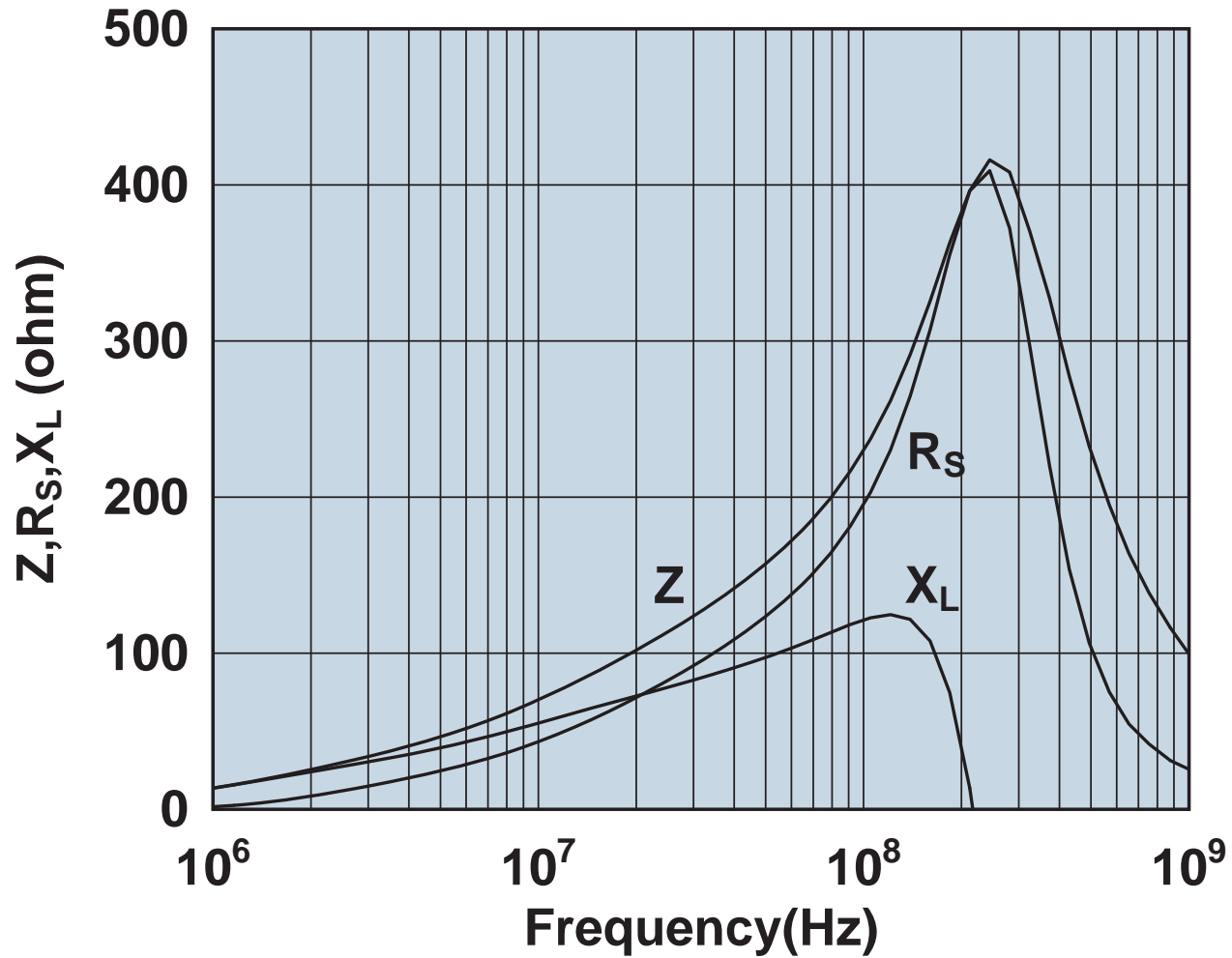

Impedance, reactance, and resistance vs. frequency.

2643163951

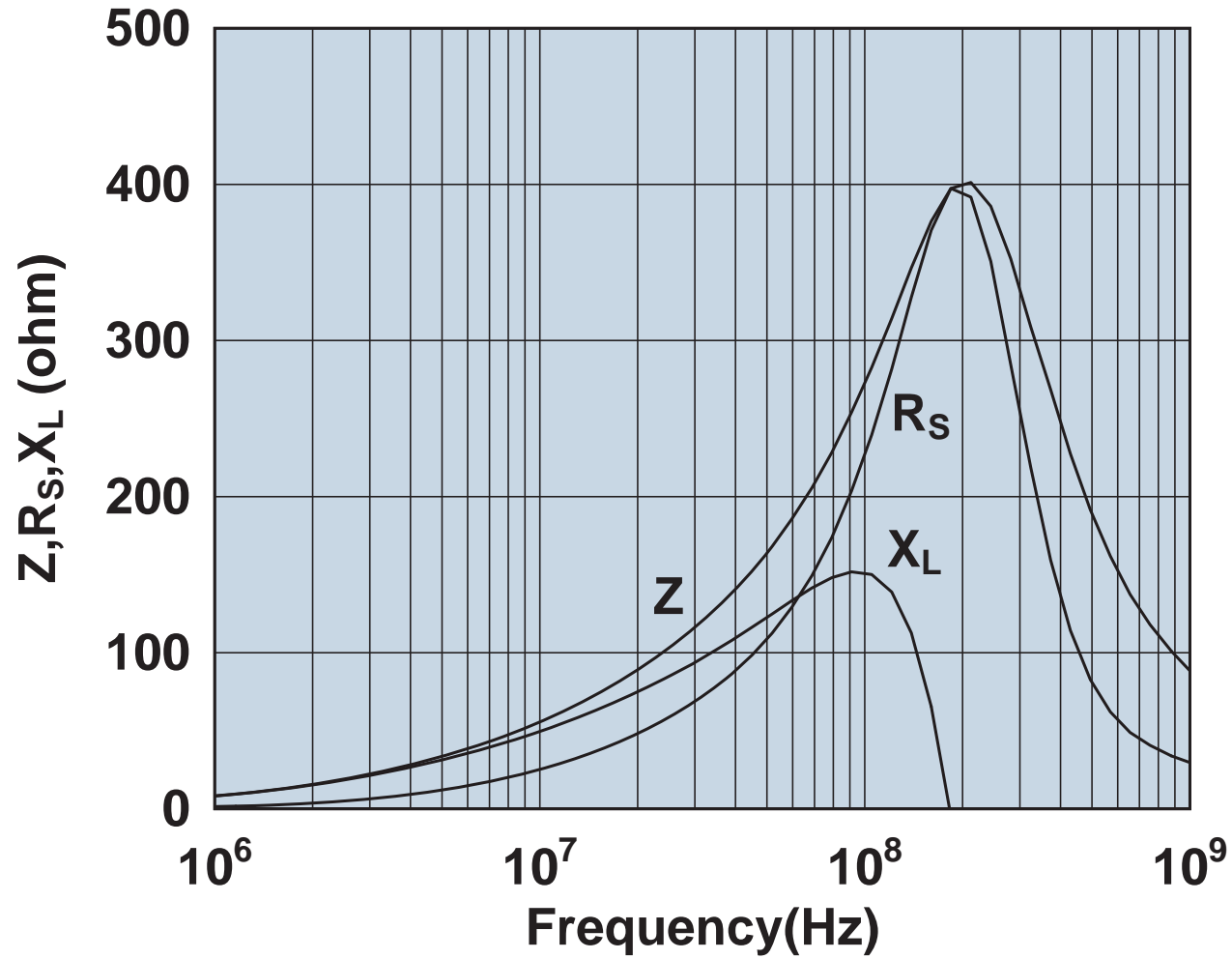

Impedance, reactance, and resistance vs. frequency.

2643164051

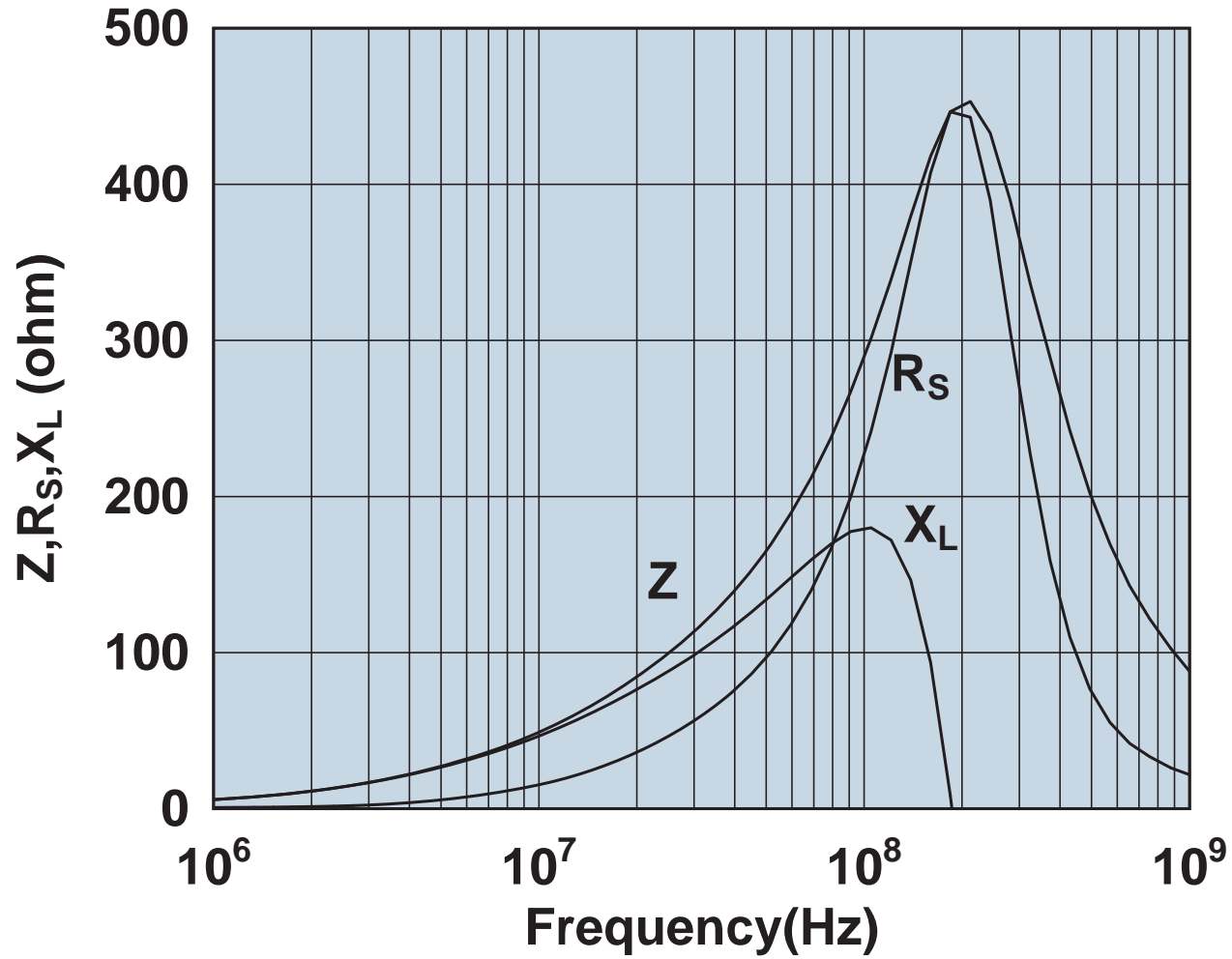

Impedance, reactance, and resistance vs. frequency.

2643164151

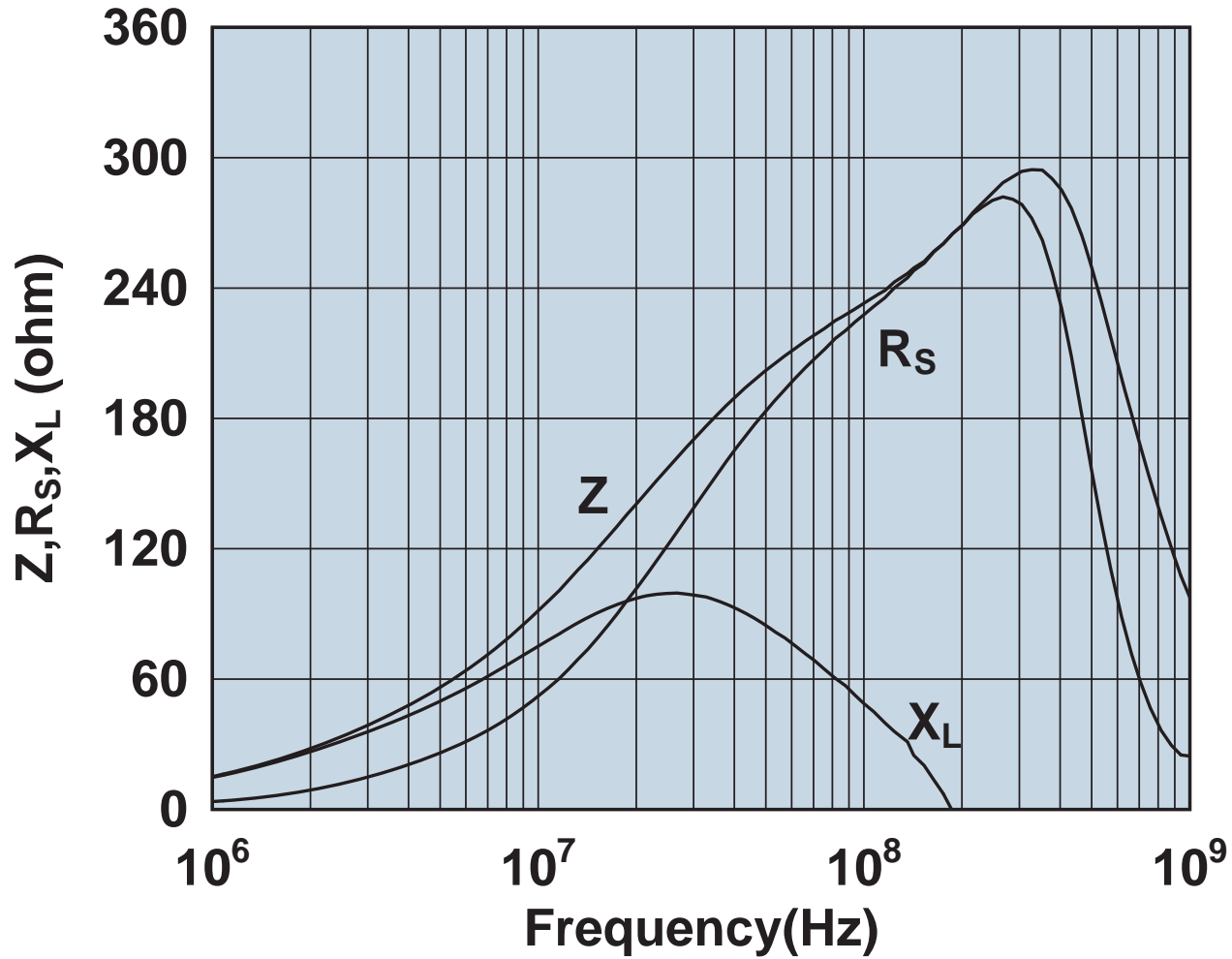

Impedance, reactance, and resistance vs. frequency.

2643164251

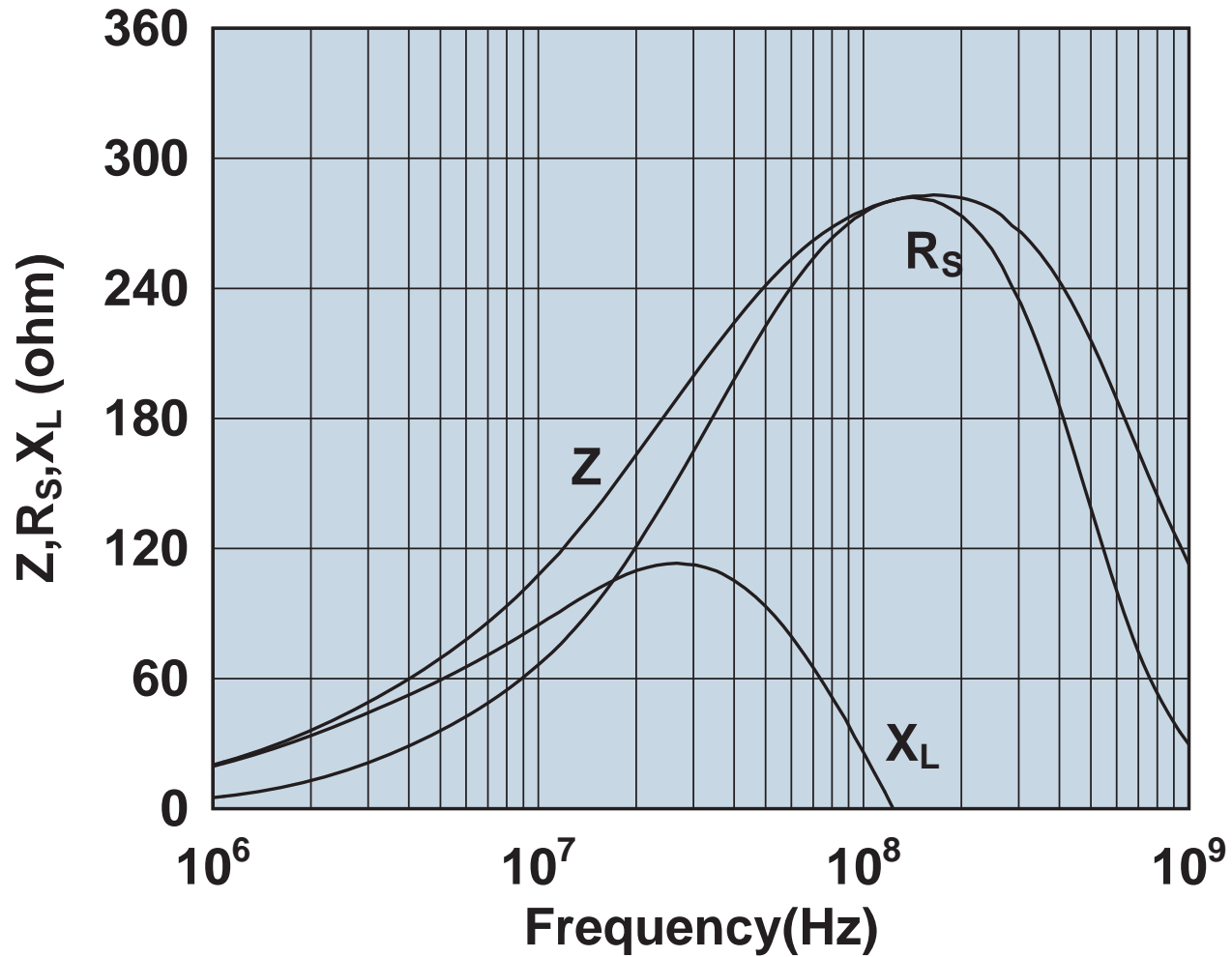

Impedance, reactance, and resistance vs. frequency.

2643164551

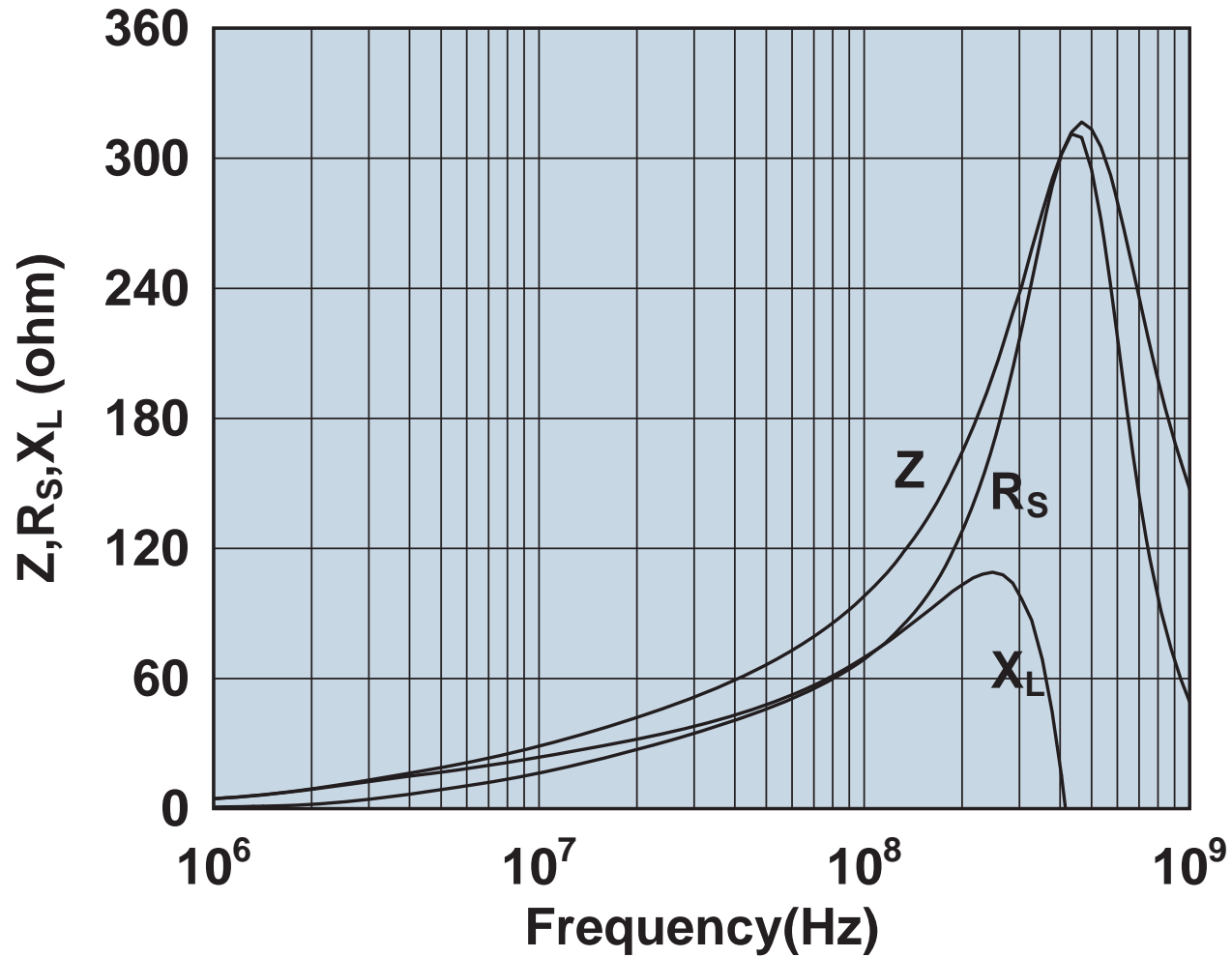

Impedance, reactance, and resistance vs. frequency.

2643165151

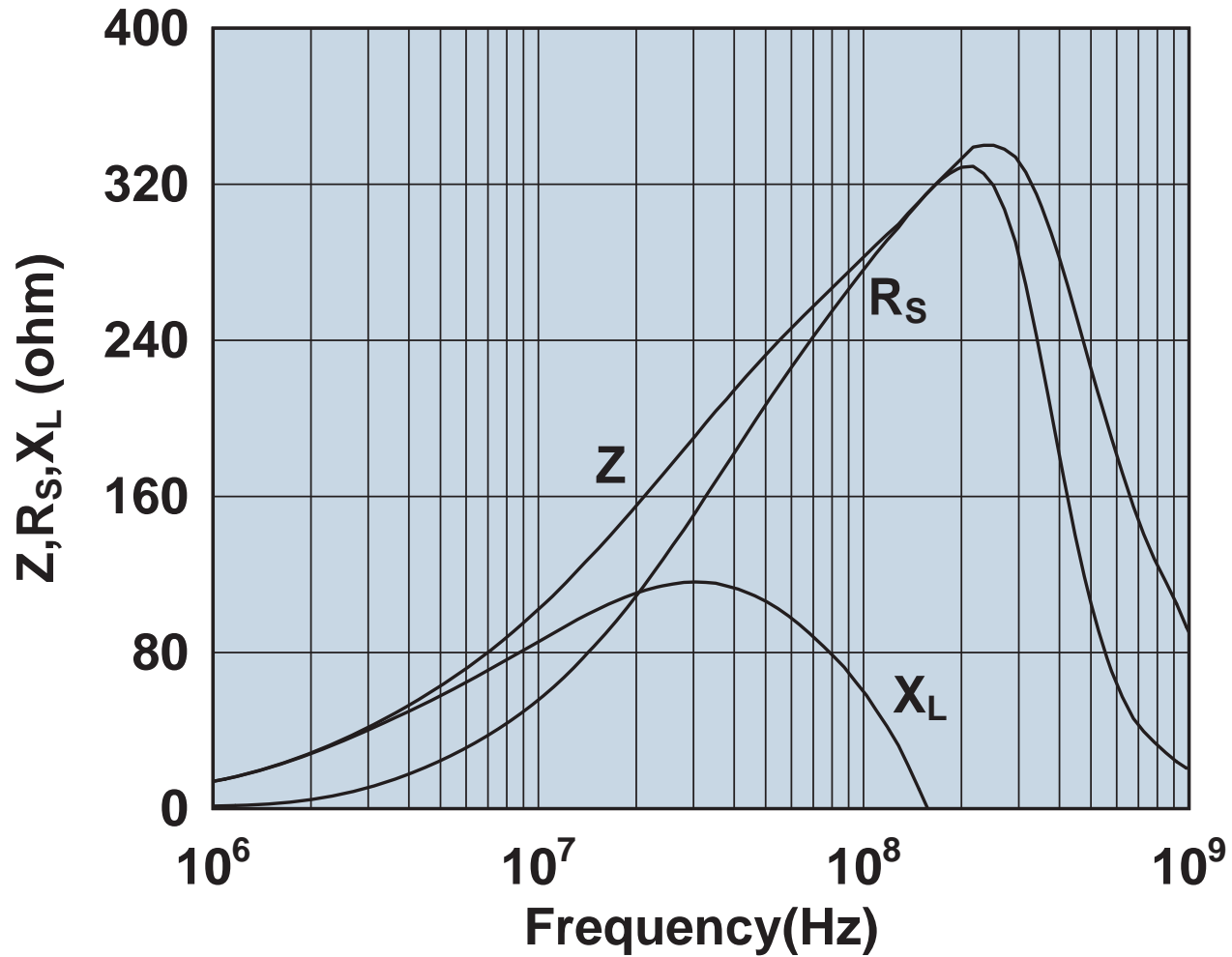

Impedance, reactance, and resistance vs. frequency.

2643165451

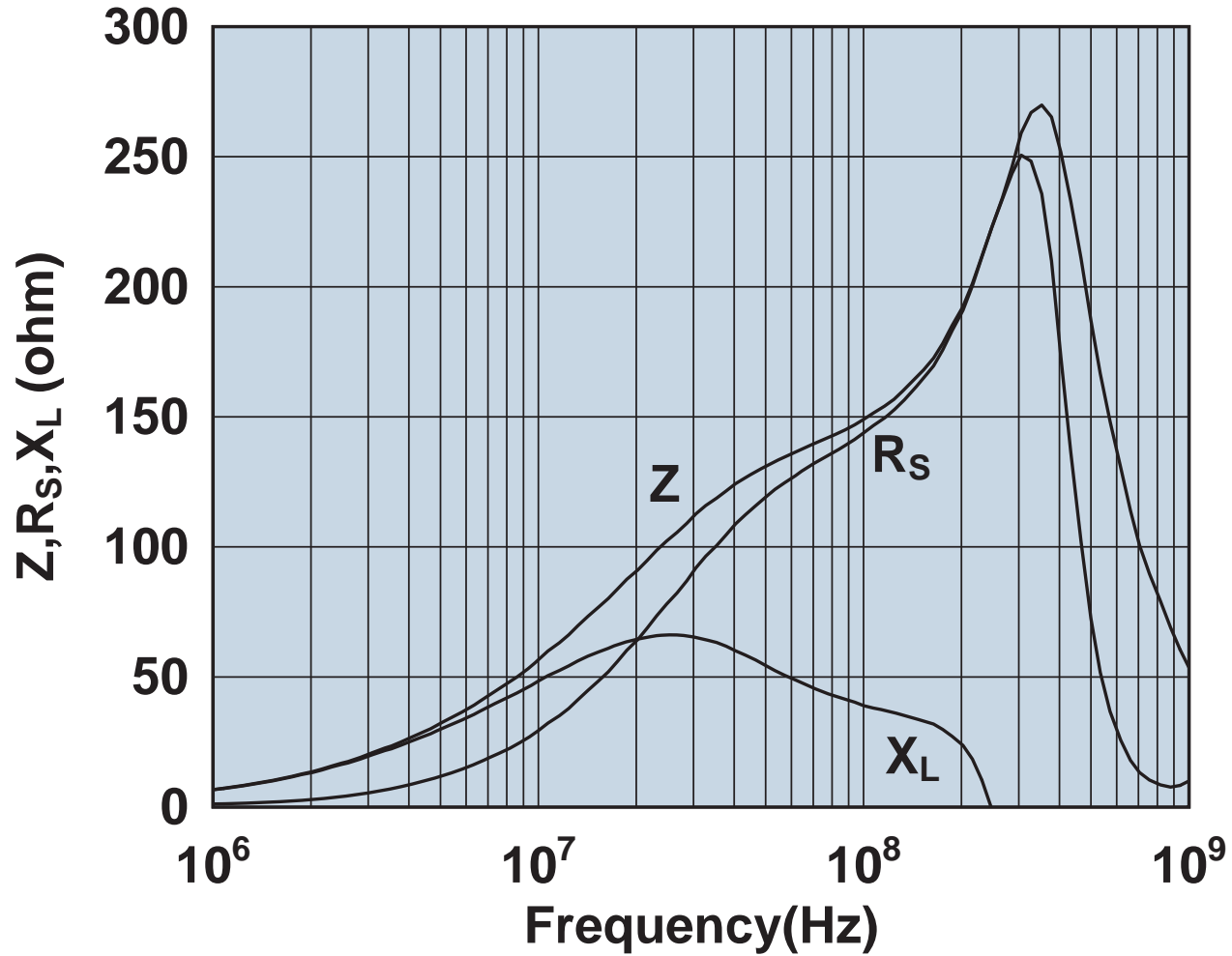

Impedance, reactance, and resistance vs. frequency.

2643166251

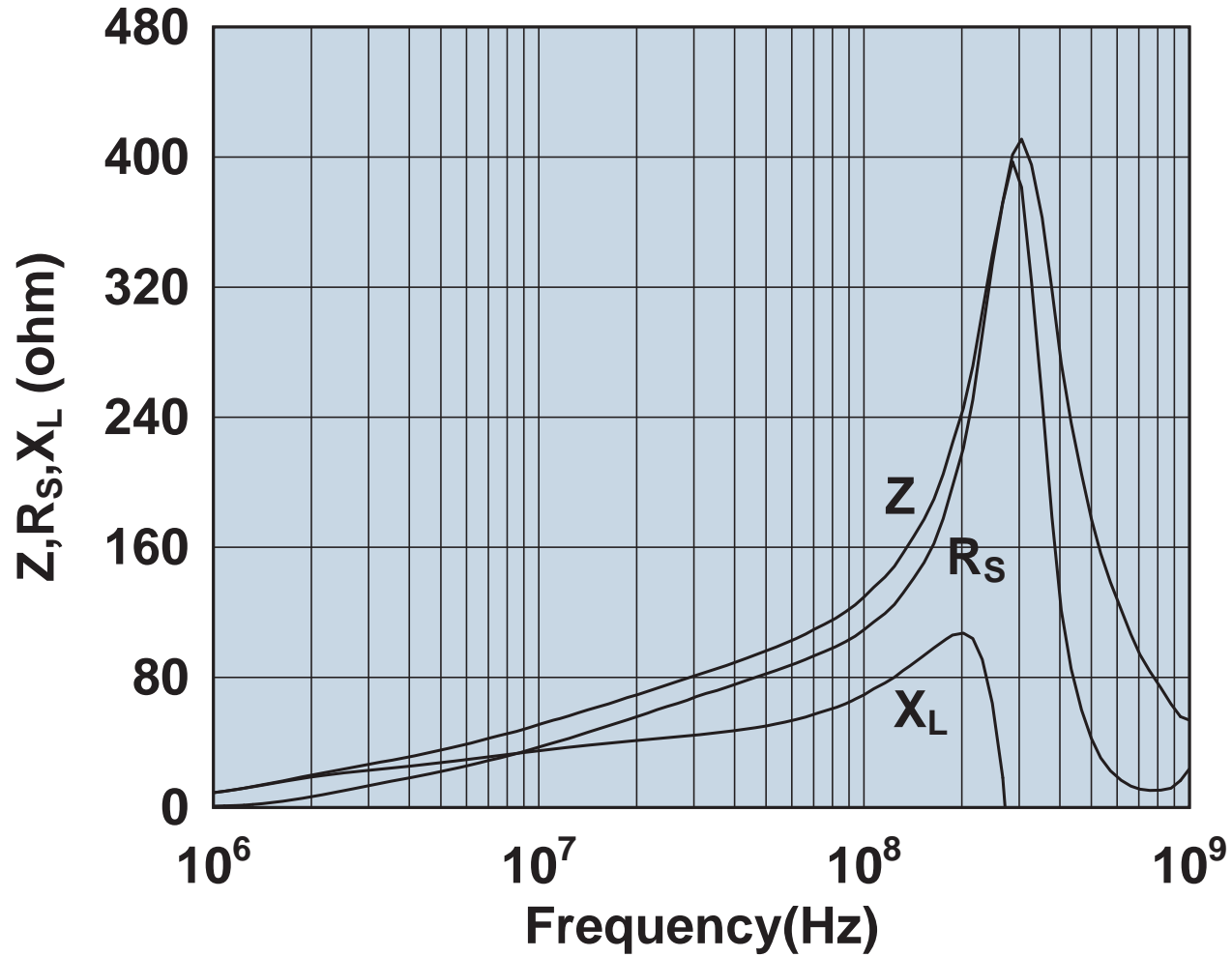

Impedance, reactance, and resistance vs. frequency.

2643166451

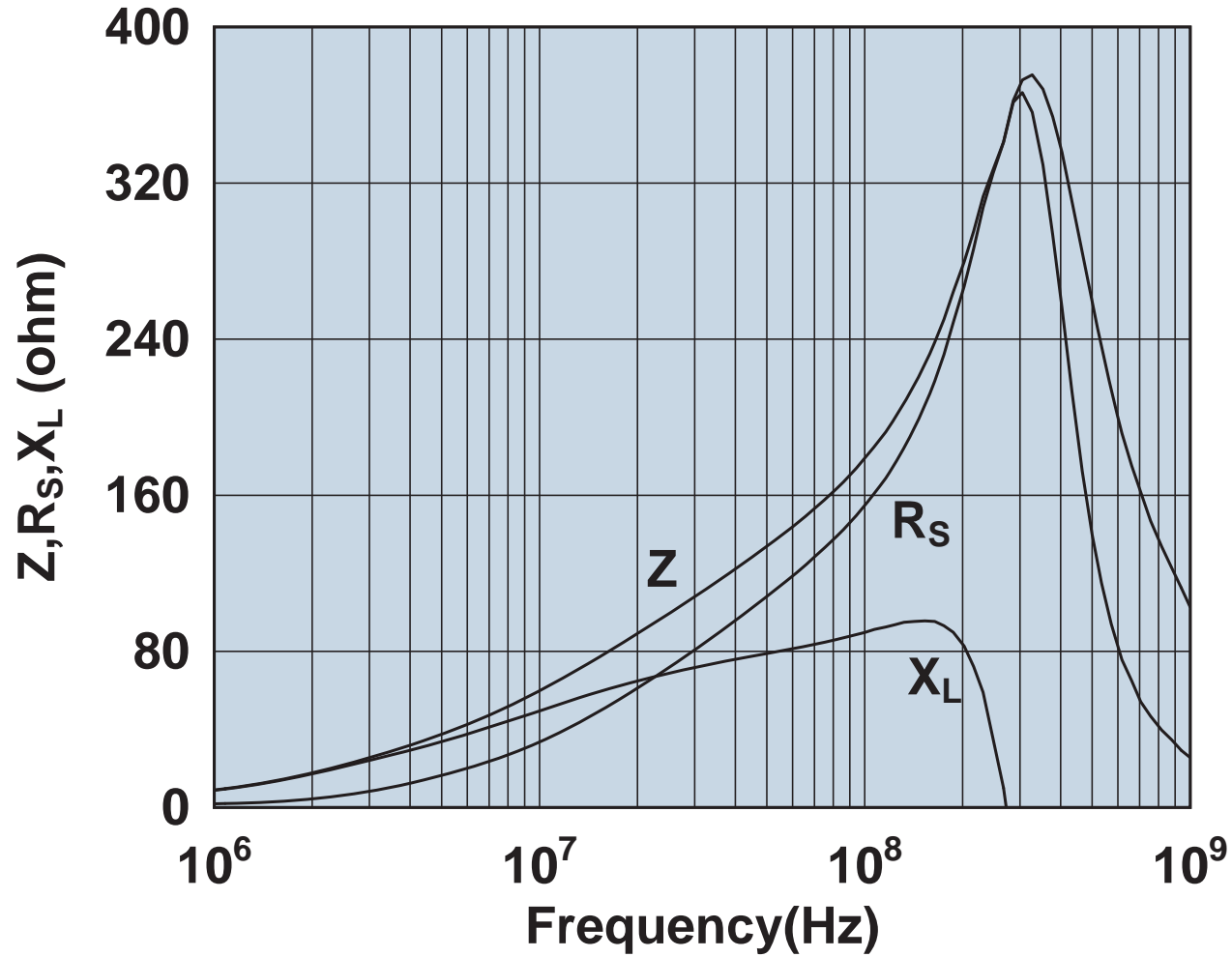

Impedance, reactance, and resistance vs. frequency.

2643166551

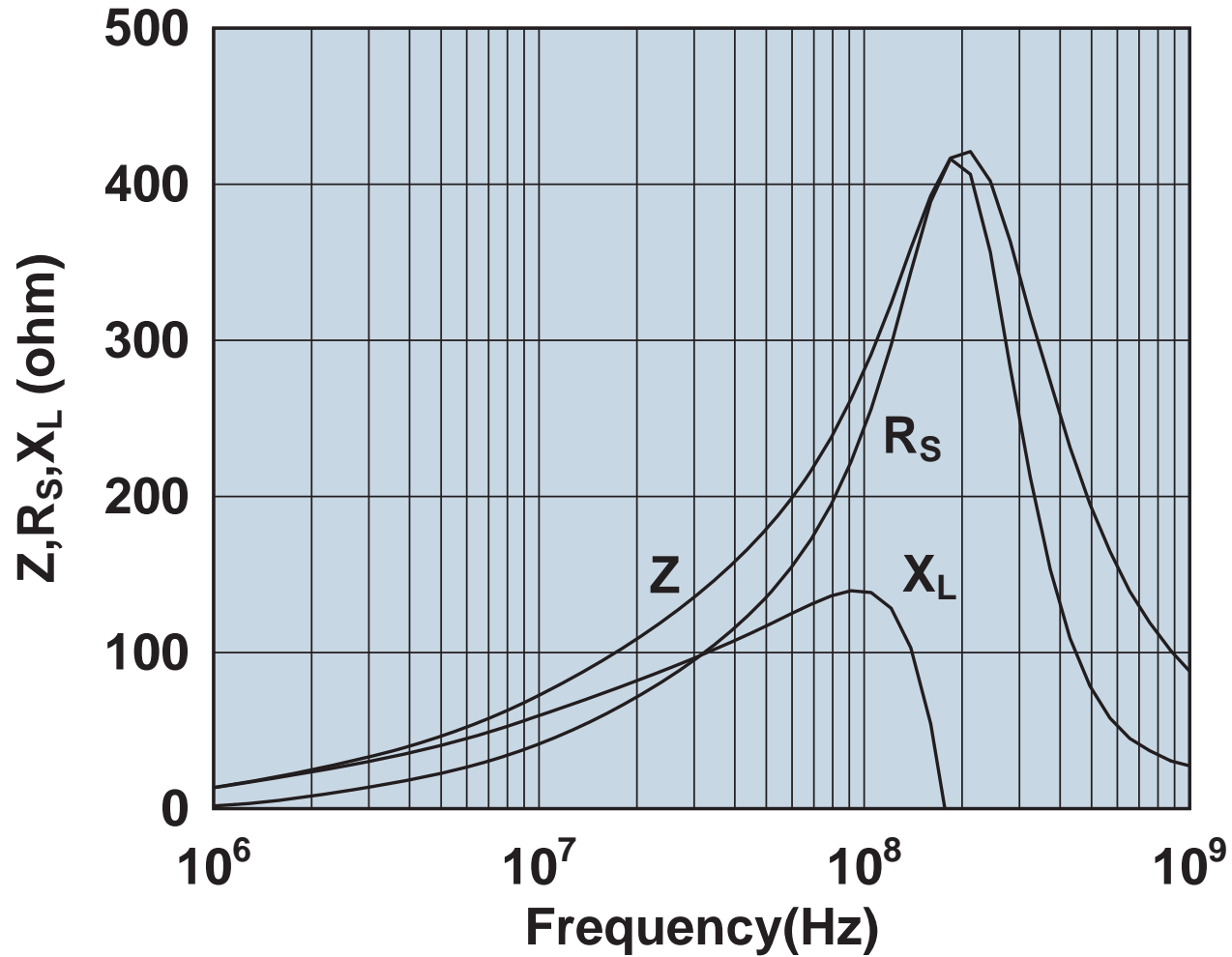

Impedance, reactance, and resistance vs. frequency.

2643166651



Impedance, reactance, and resistance vs. frequency.

2643166751

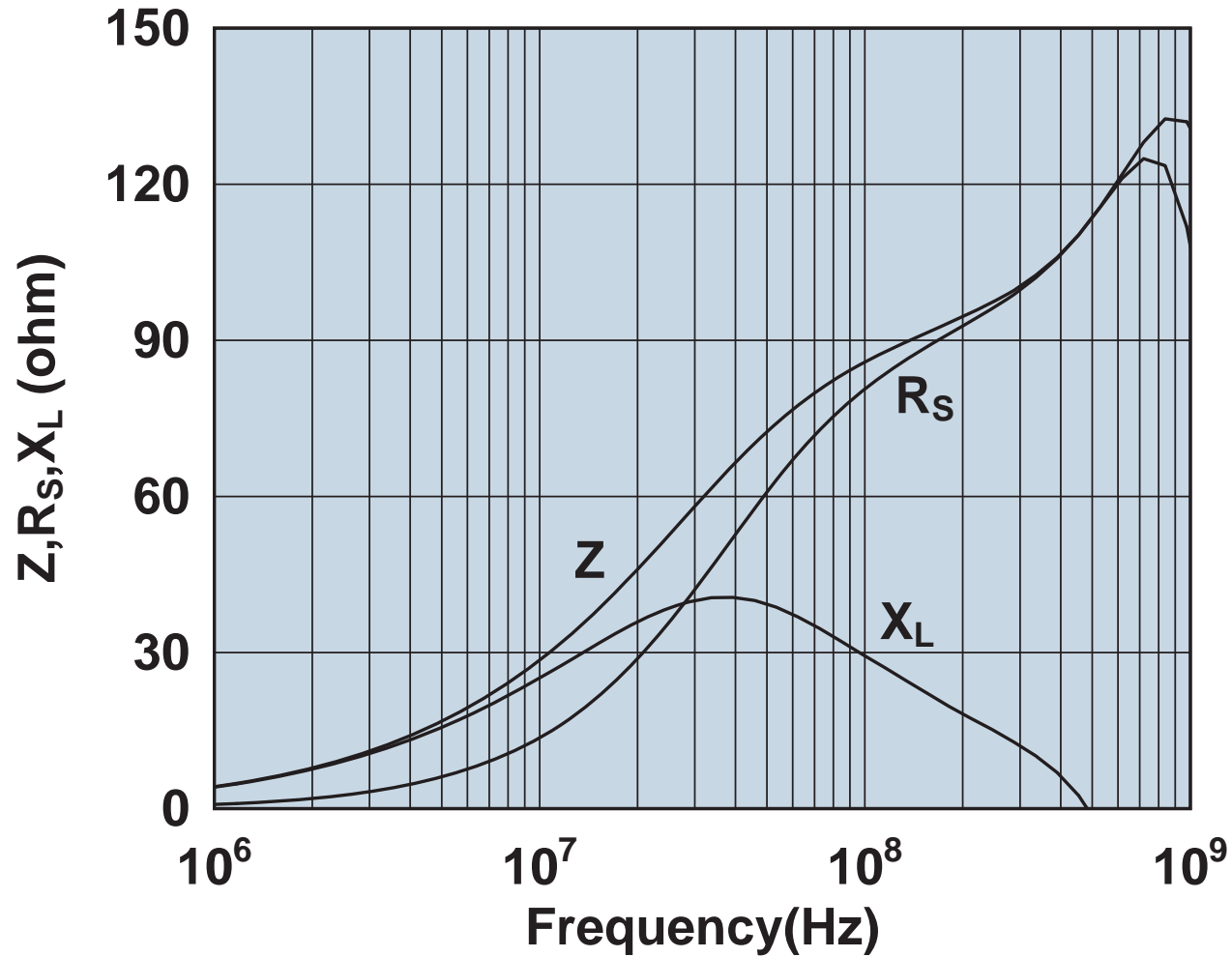

Impedance, reactance, and resistance vs. frequency.

2643166851

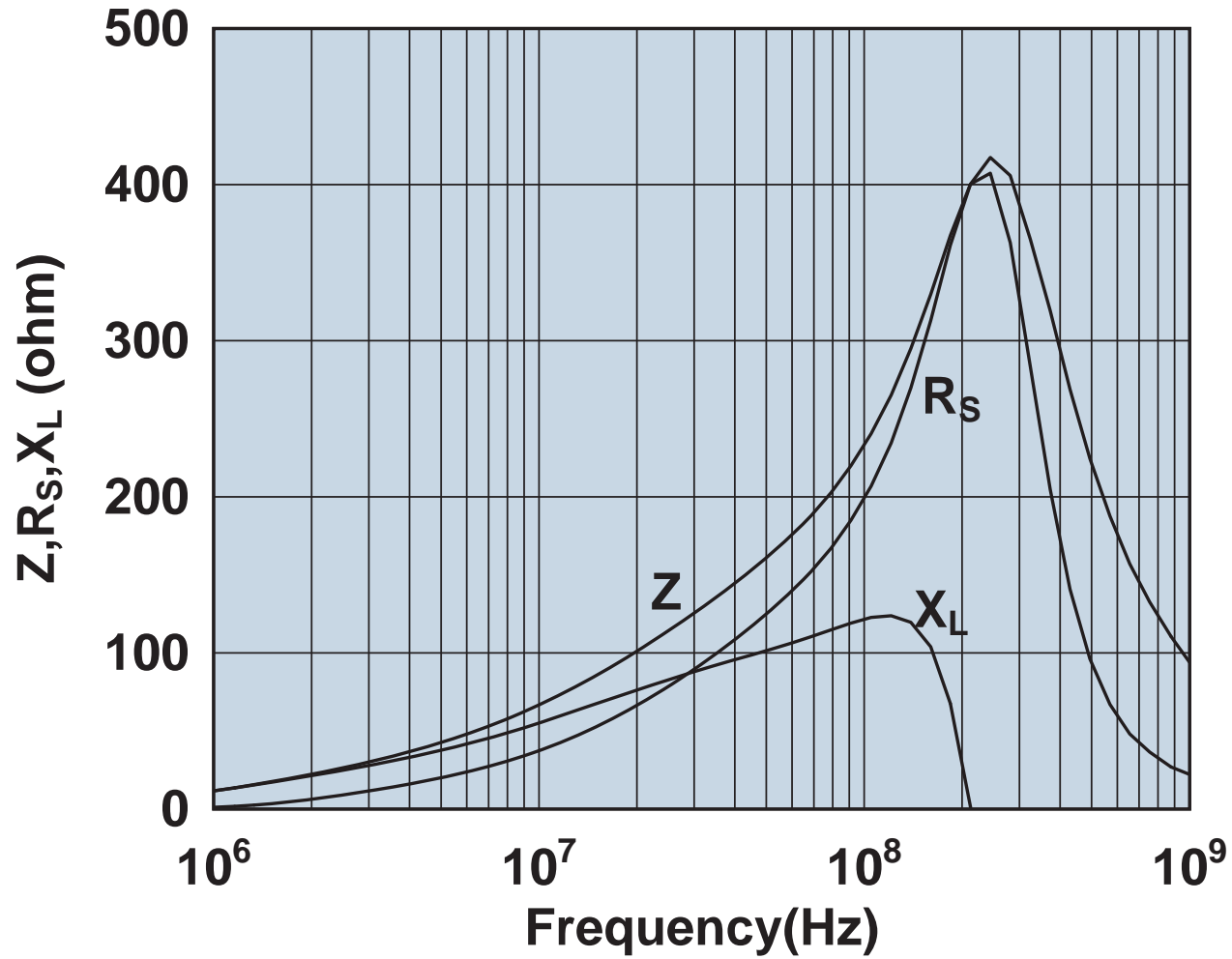

Impedance, reactance, and resistance vs. frequency.

2643167251

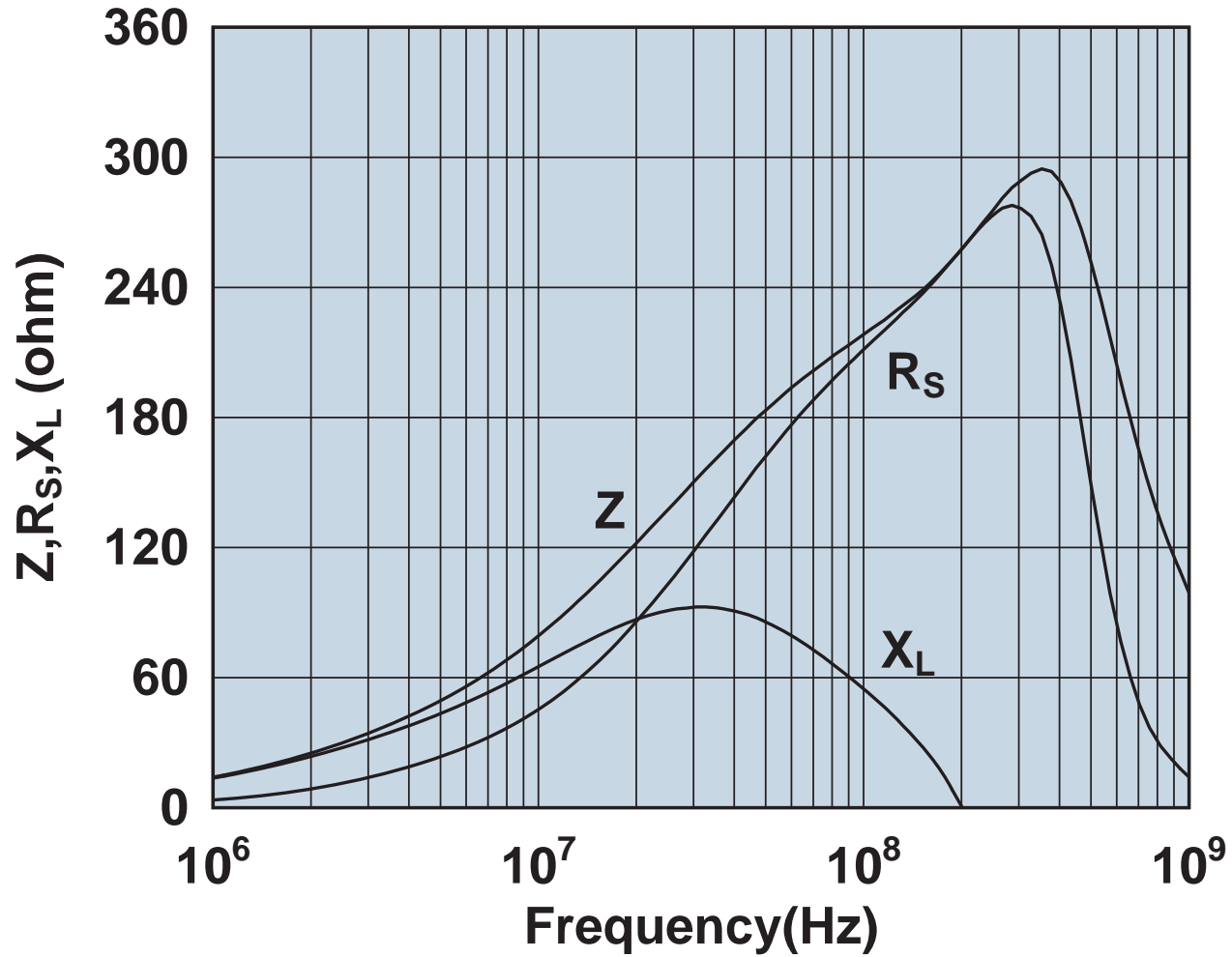

Impedance, reactance, and resistance vs. frequency.

2643167551

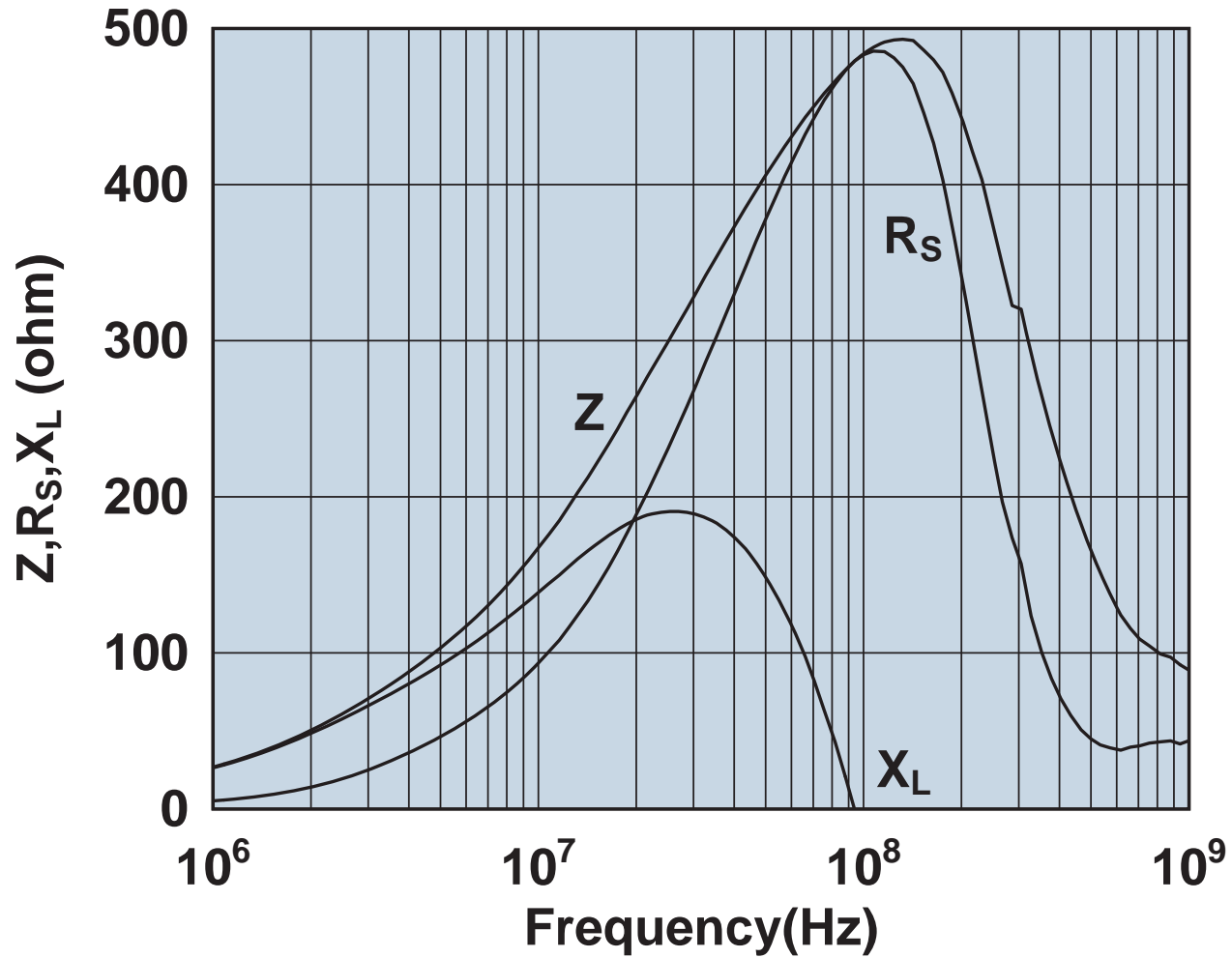

Impedance, reactance, and resistance vs. frequency.

2643167751

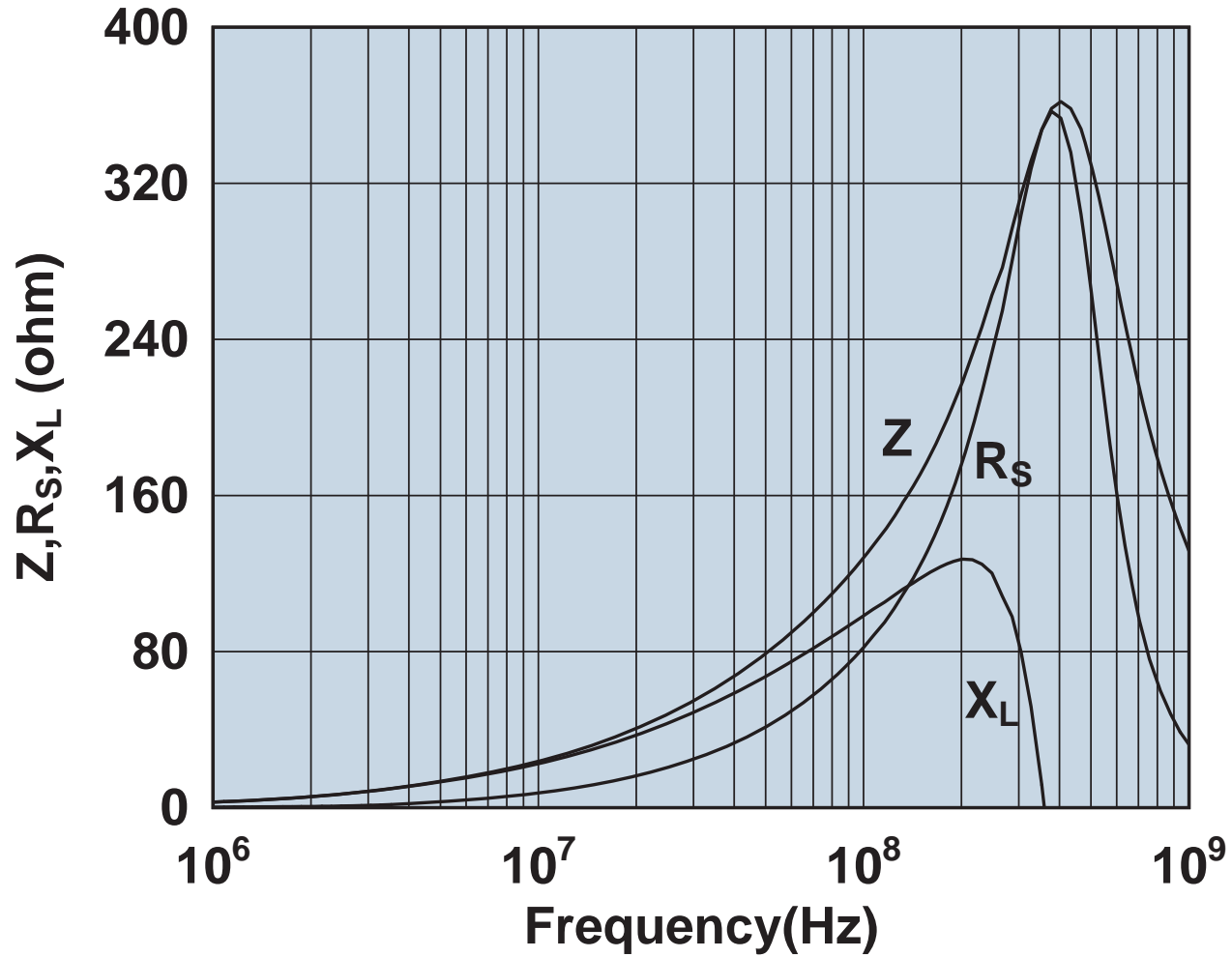

Impedance, reactance, and resistance vs. frequency.

2643167851

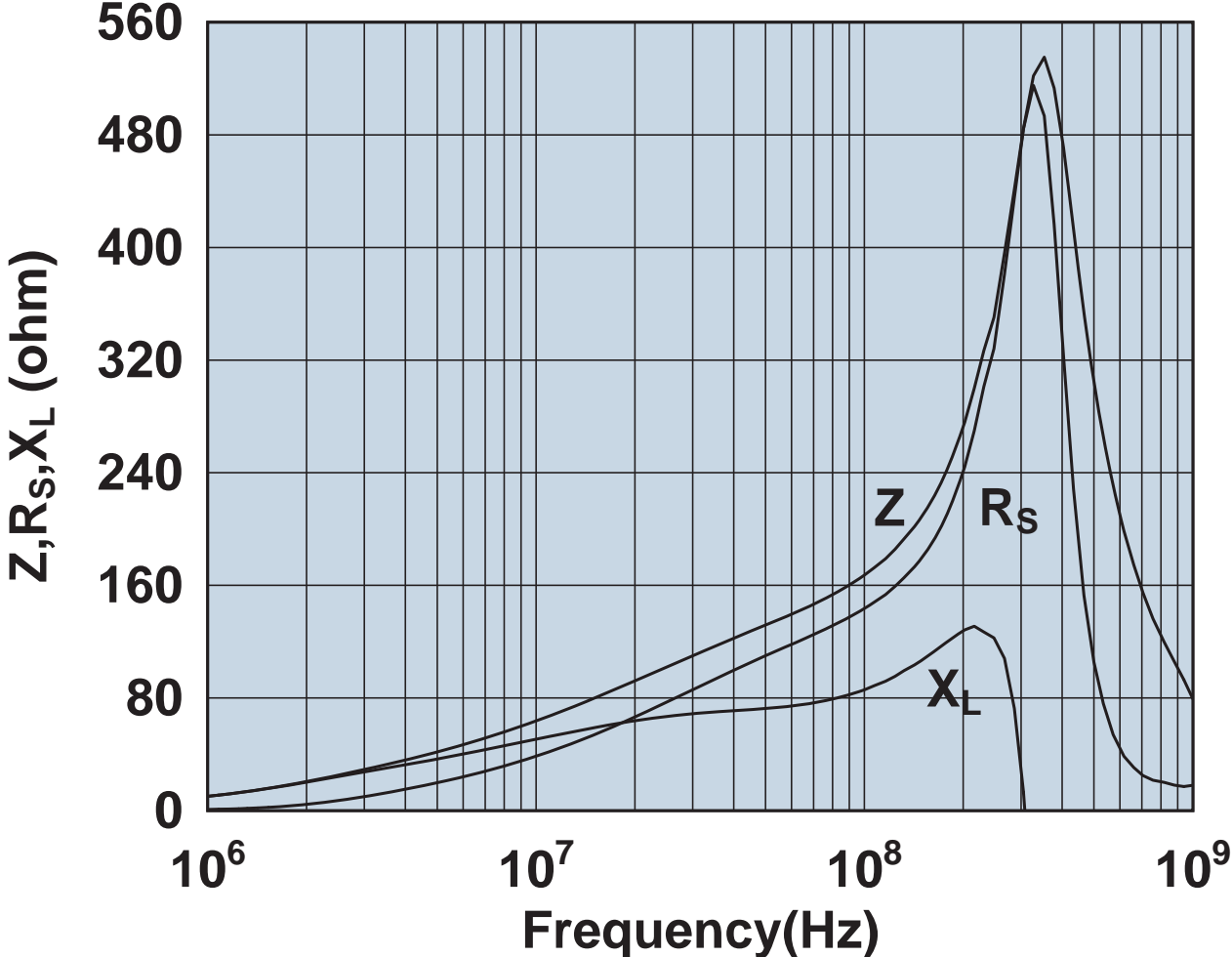

Impedance, reactance, and resistance vs. frequency.

2643168051

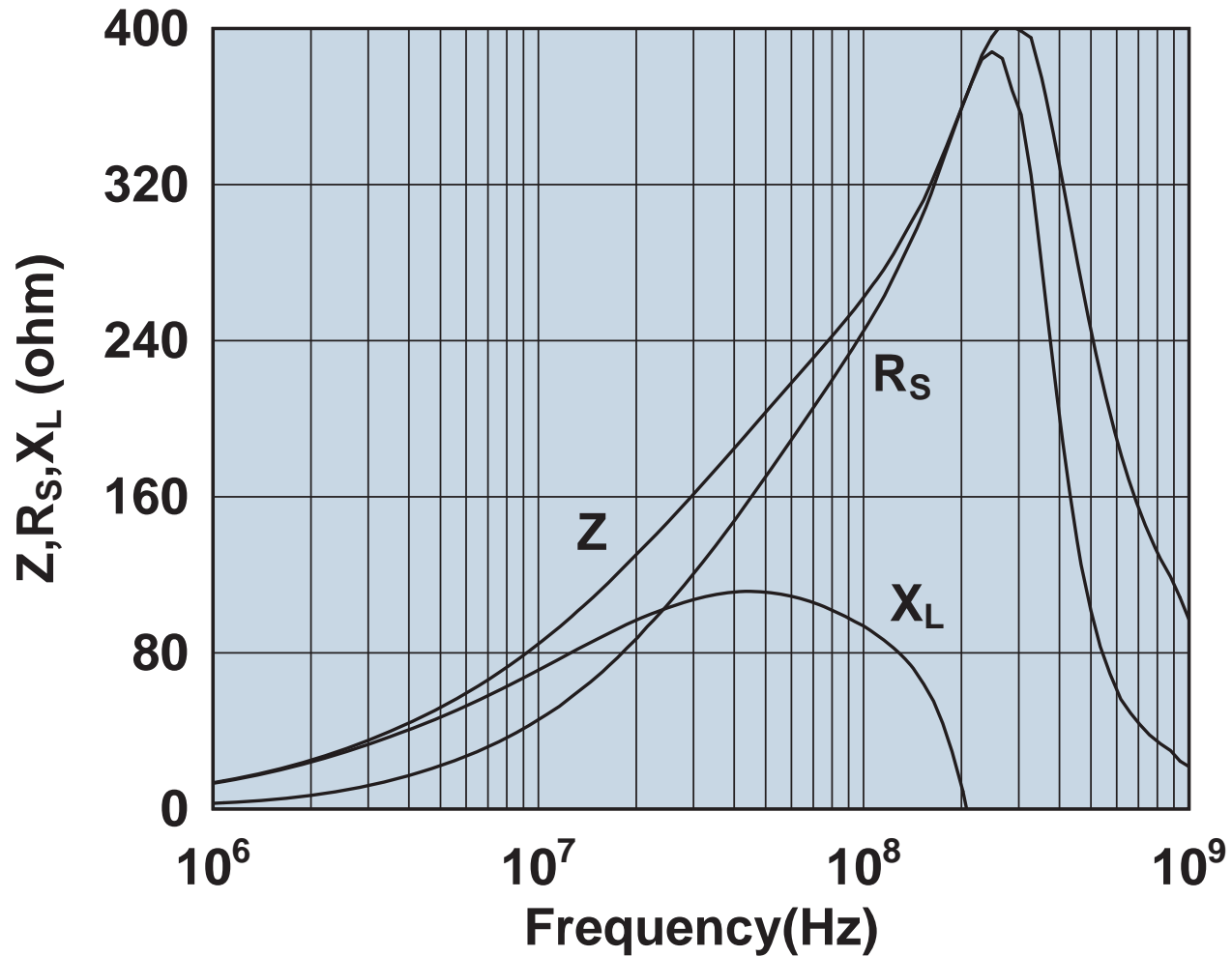

Impedance, reactance, and resistance vs. frequency.

2643168251

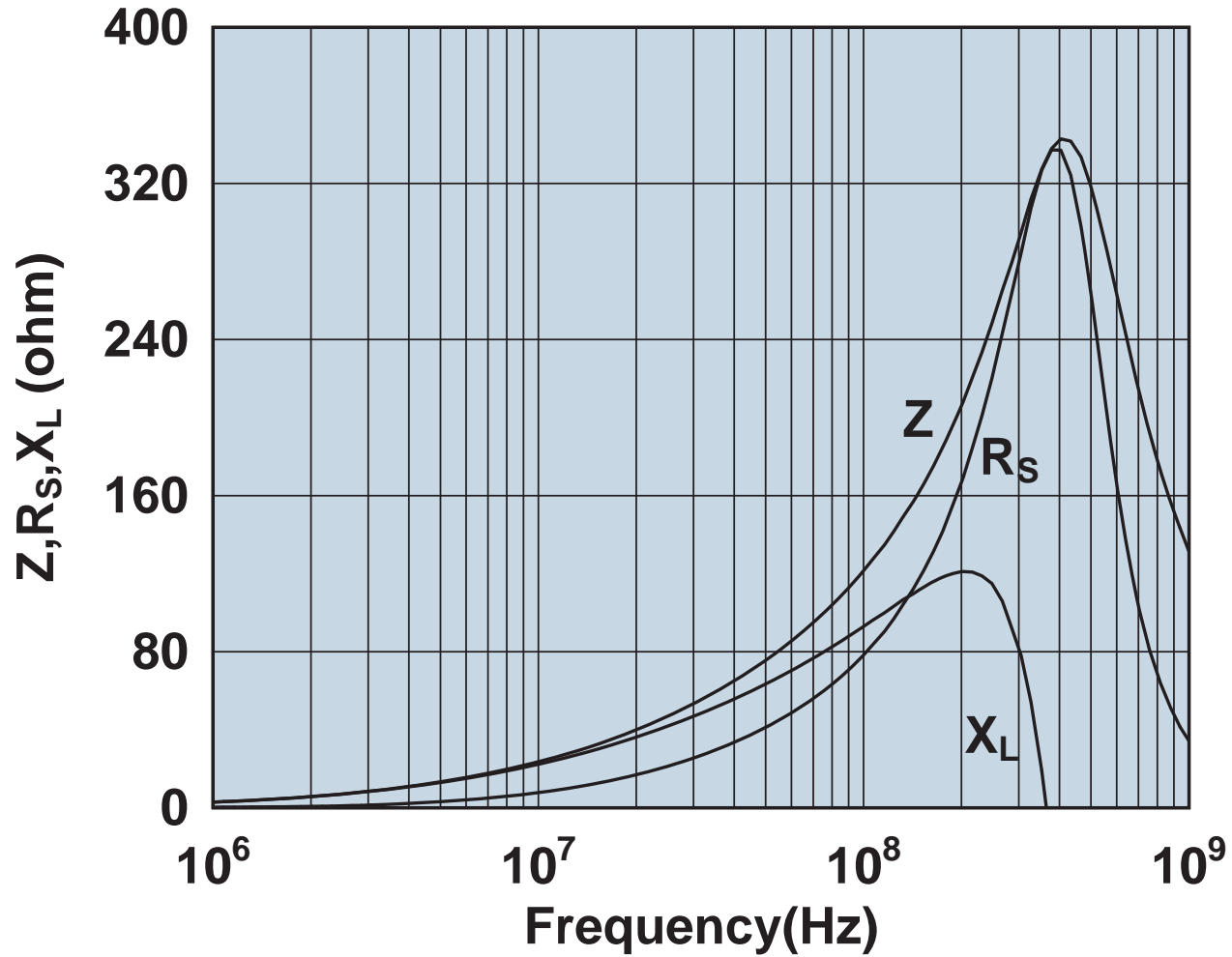

Impedance, reactance, and resistance vs. frequency.

2643168351

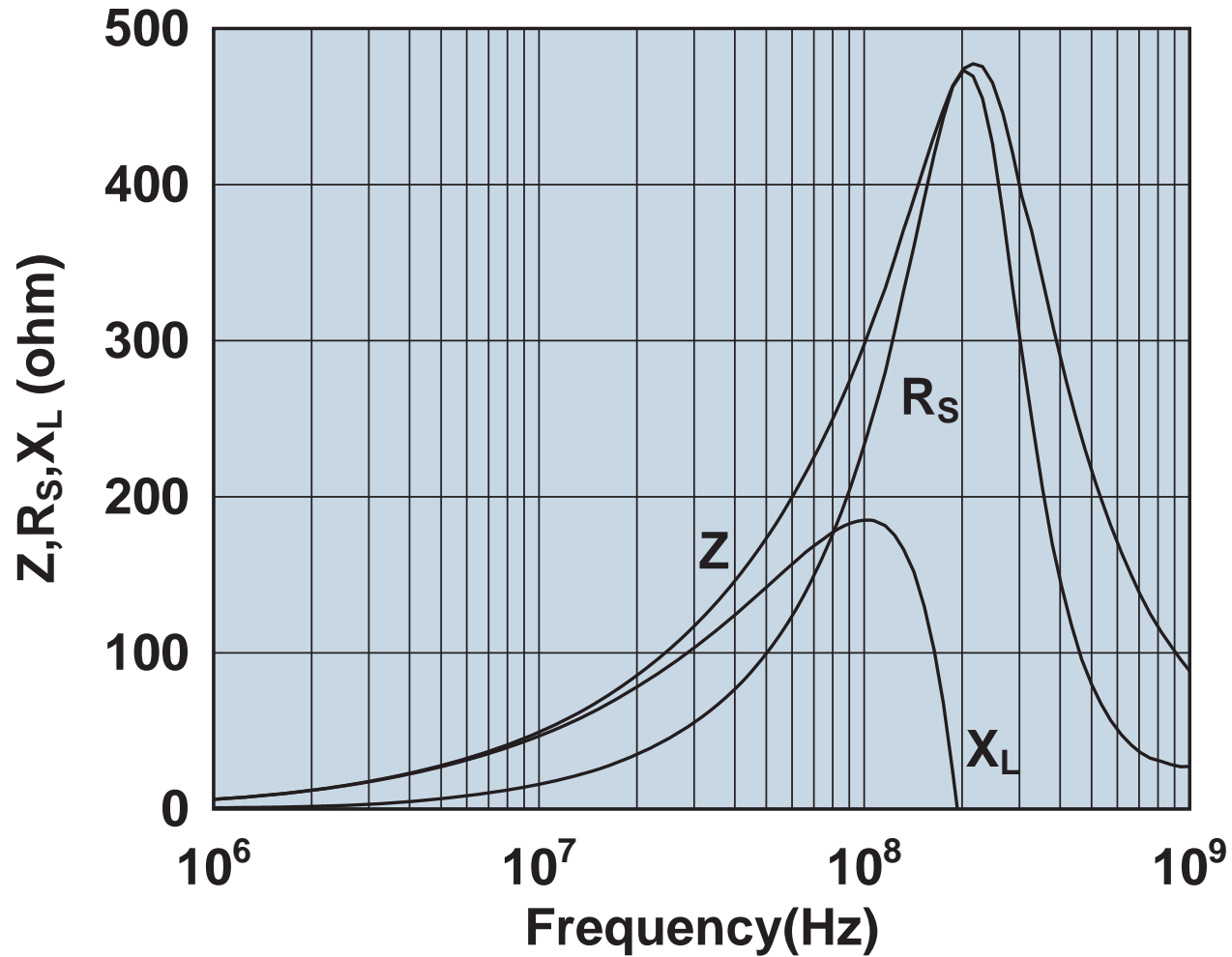

Impedance, reactance, and resistance vs. frequency.

2643168651

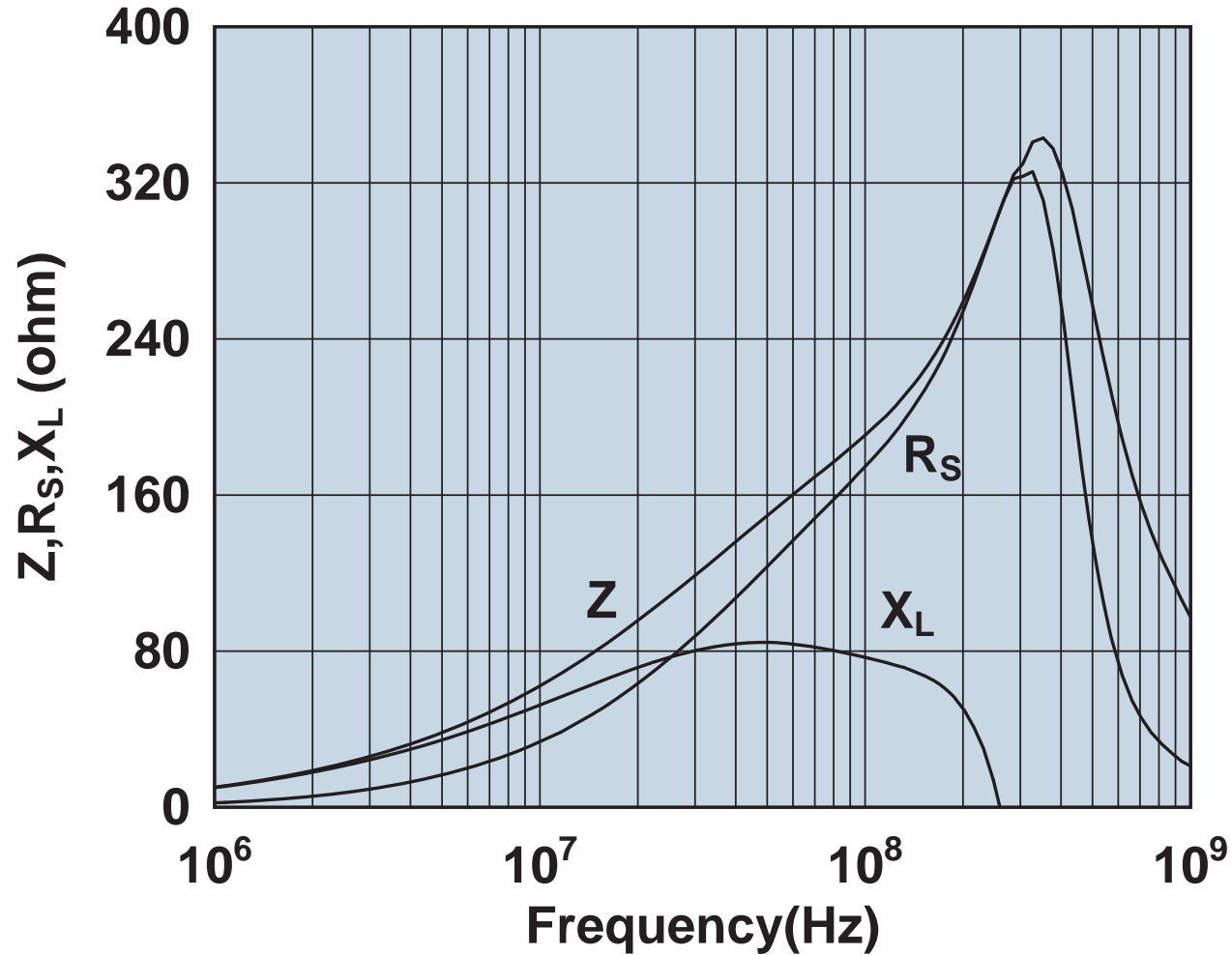

Impedance, reactance, and resistance vs. frequency.

2643168751

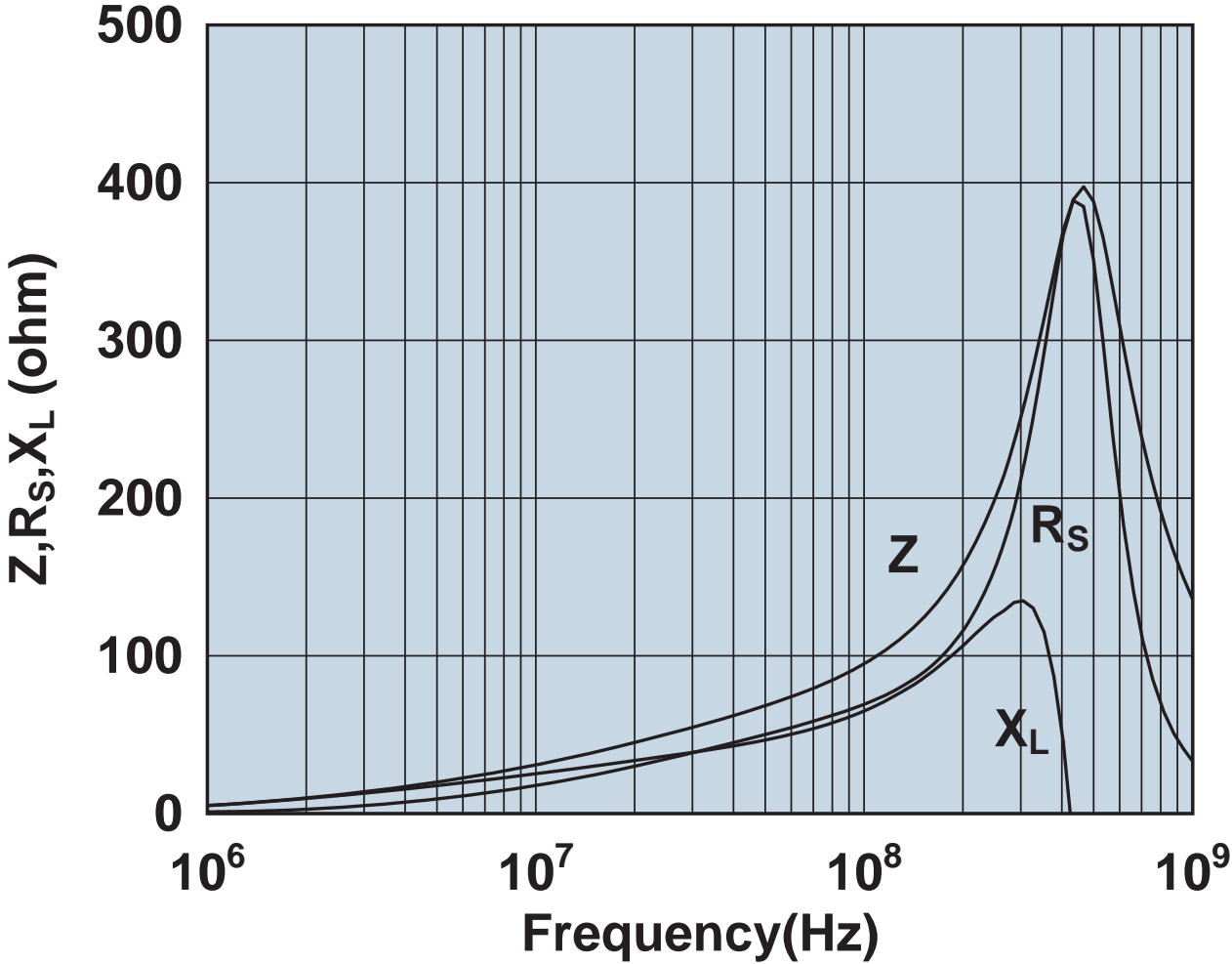

Impedance, reactance, and resistance vs. frequency.

2643169351

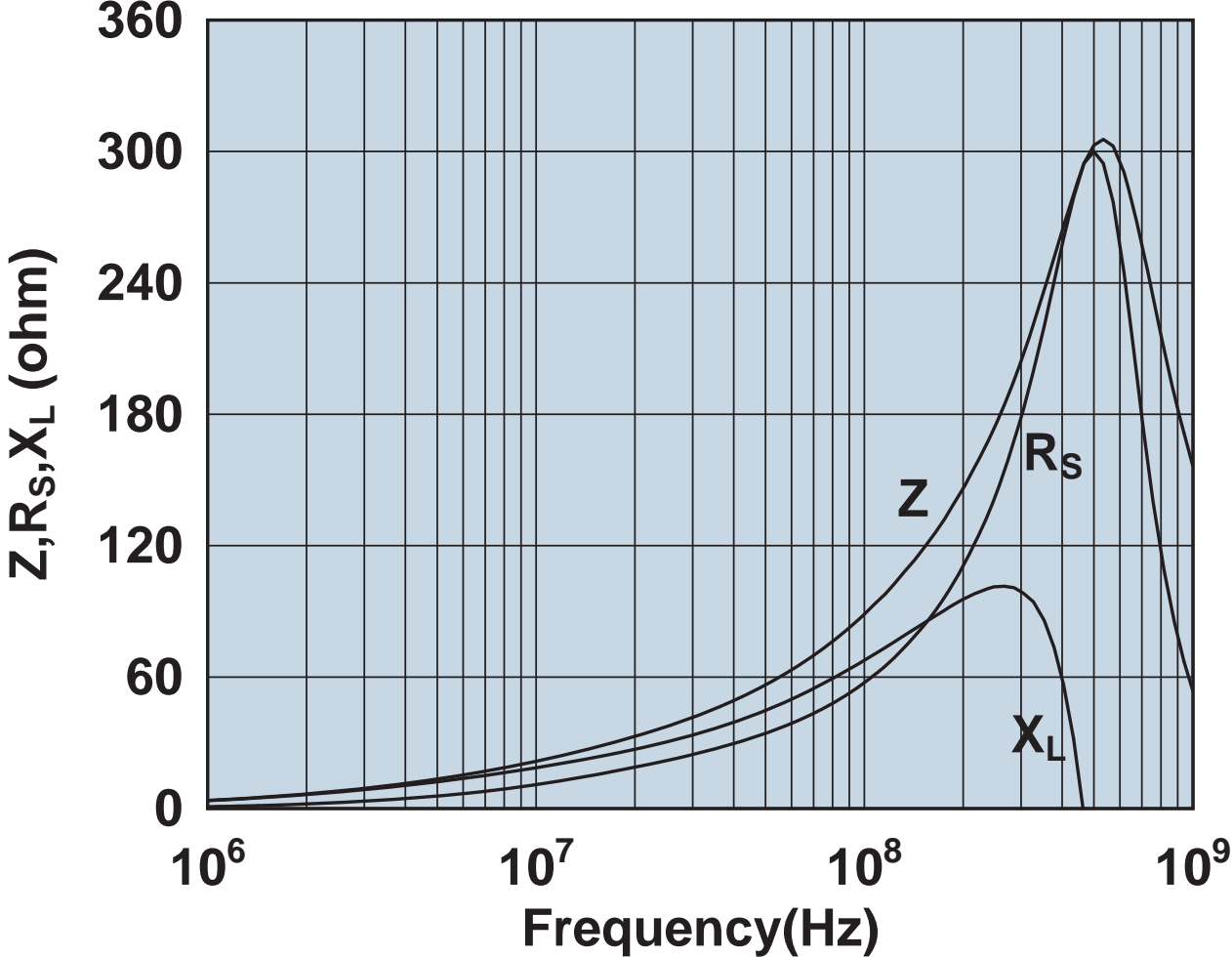

Impedance, reactance, and resistance vs. frequency.

2643169552

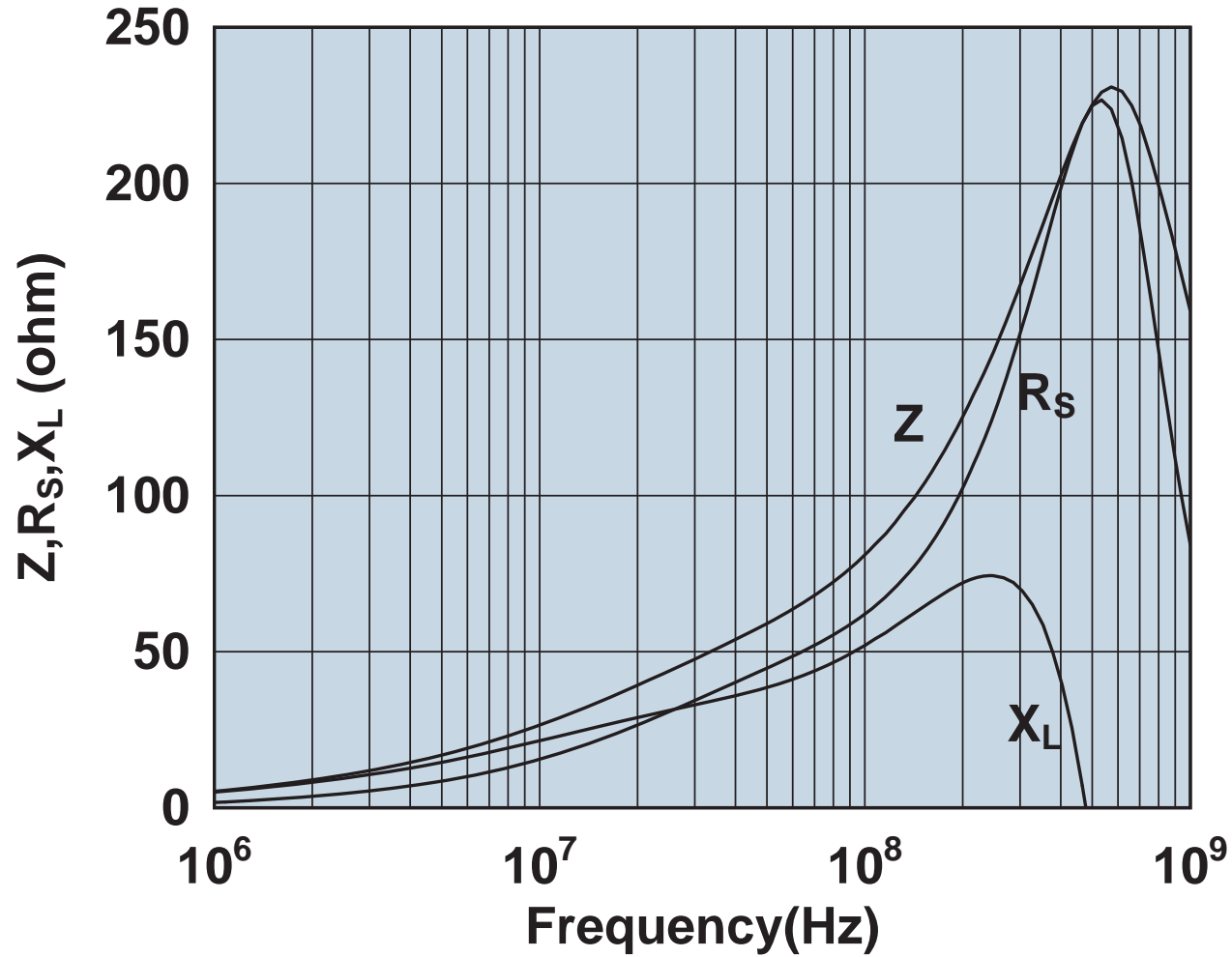

Impedance, reactance, and resistance vs. frequency.

2643170251

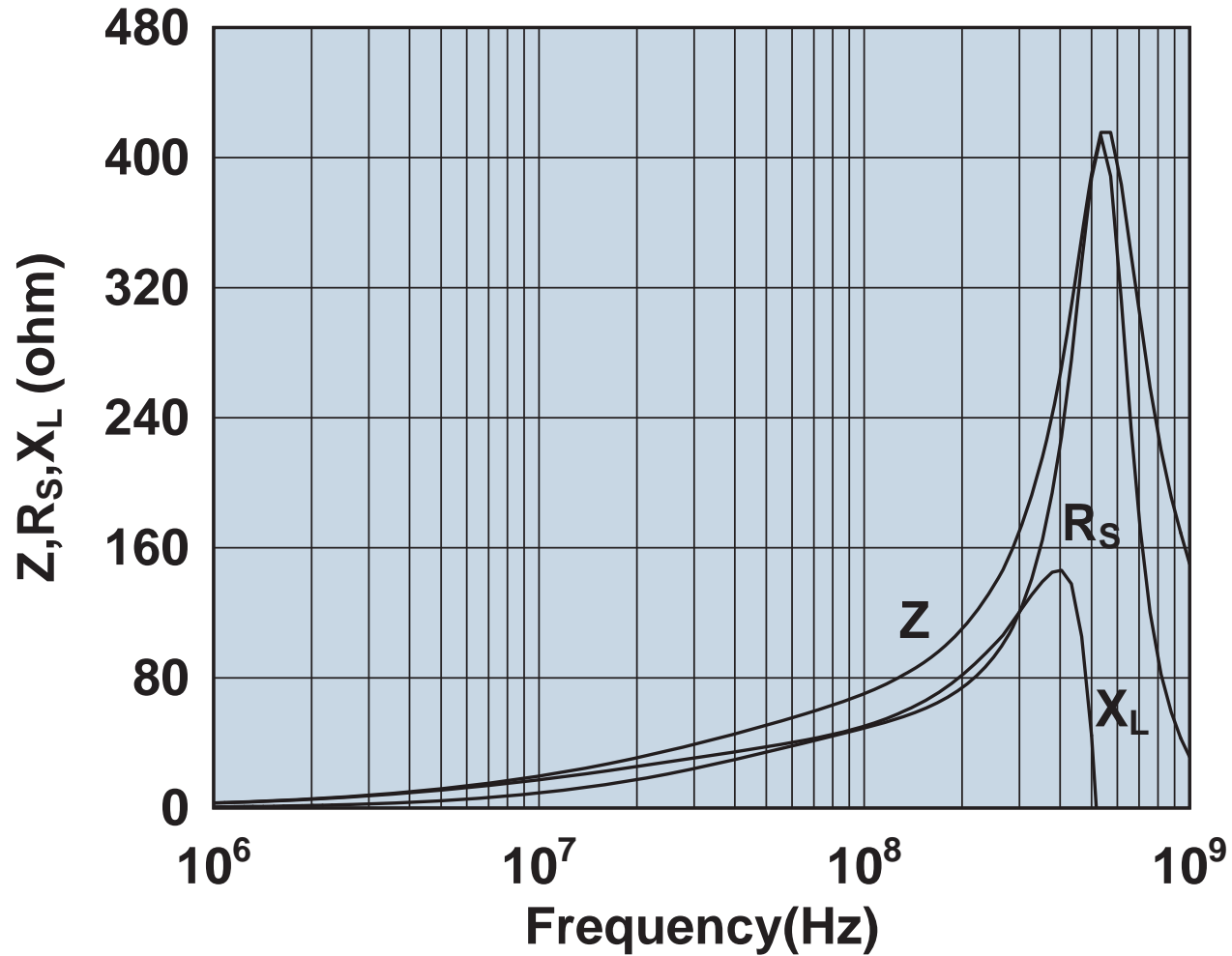

Impedance, reactance, and resistance vs. frequency.

2643170951

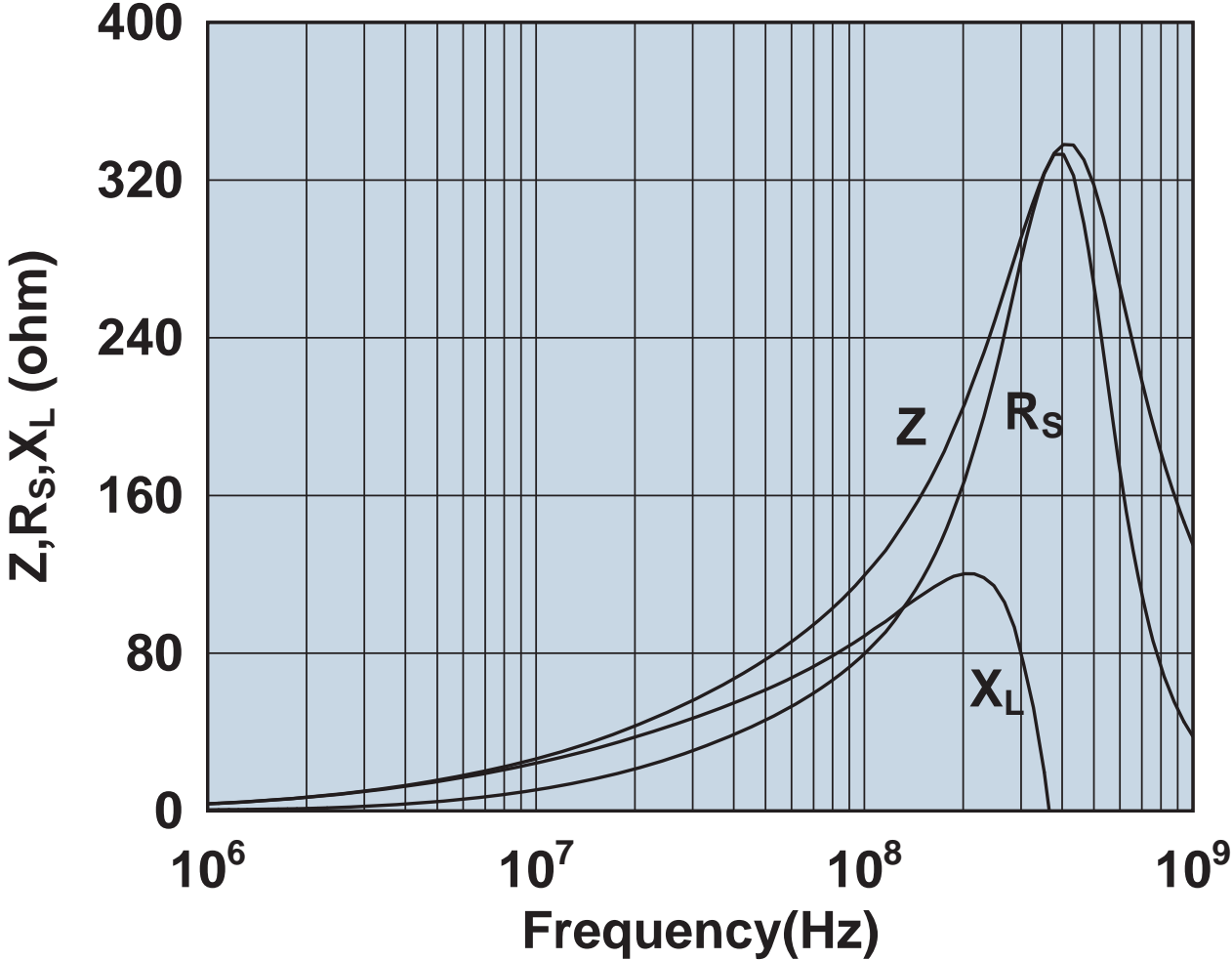

Impedance, reactance, and resistance vs. frequency.

2643171051

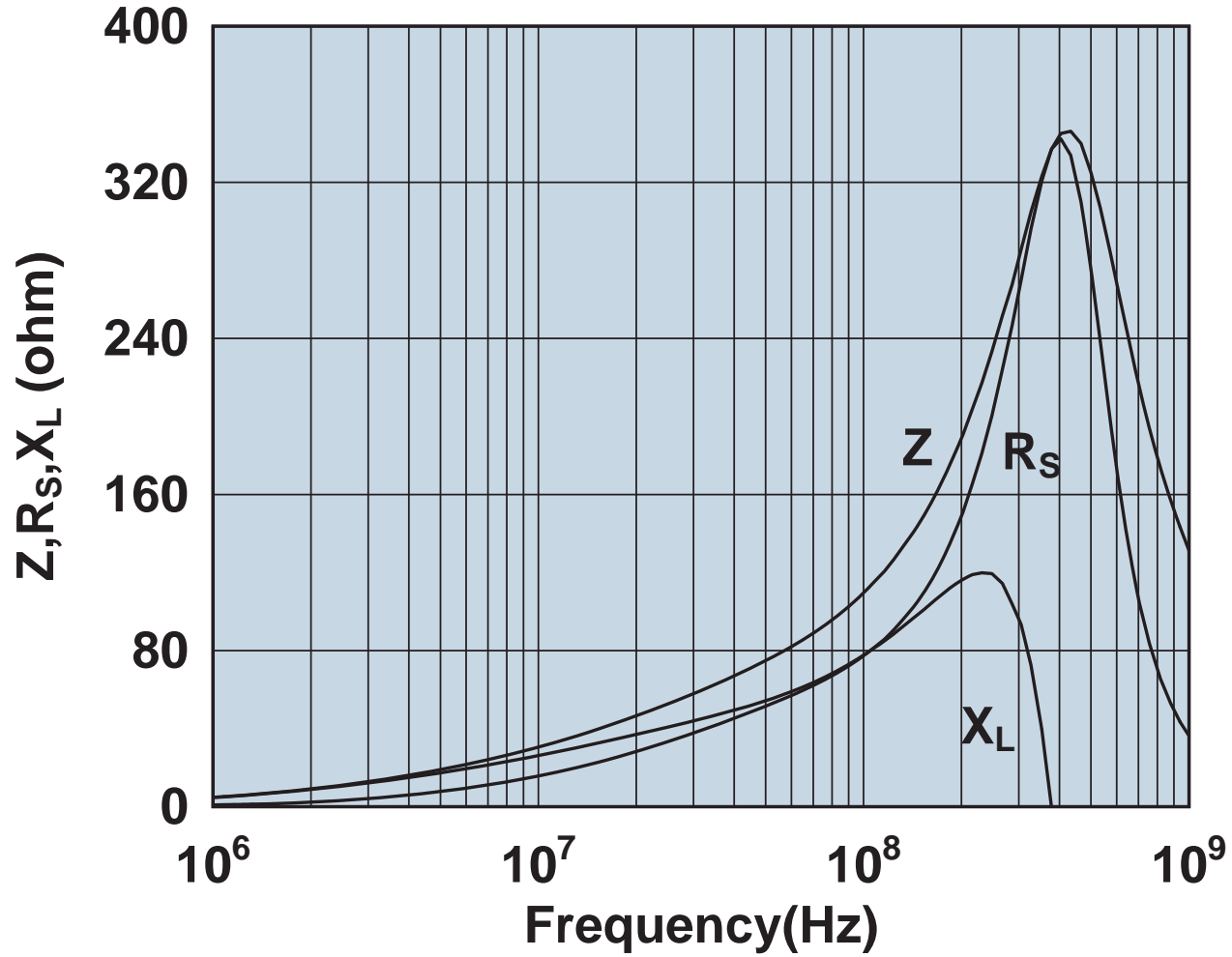

Impedance, reactance, and resistance vs. frequency.

2643172551

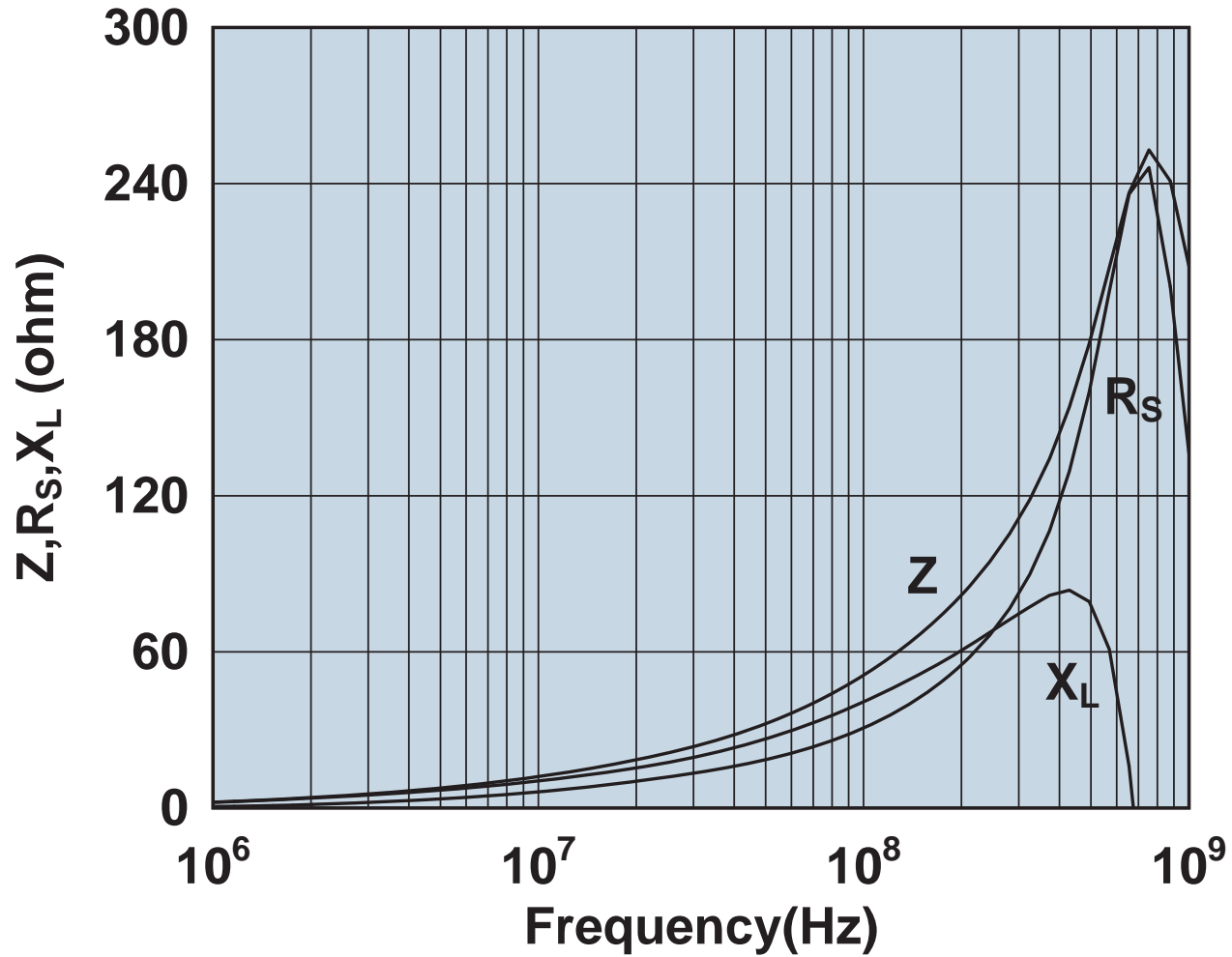

Impedance, reactance, and resistance vs. frequency.

2643173351

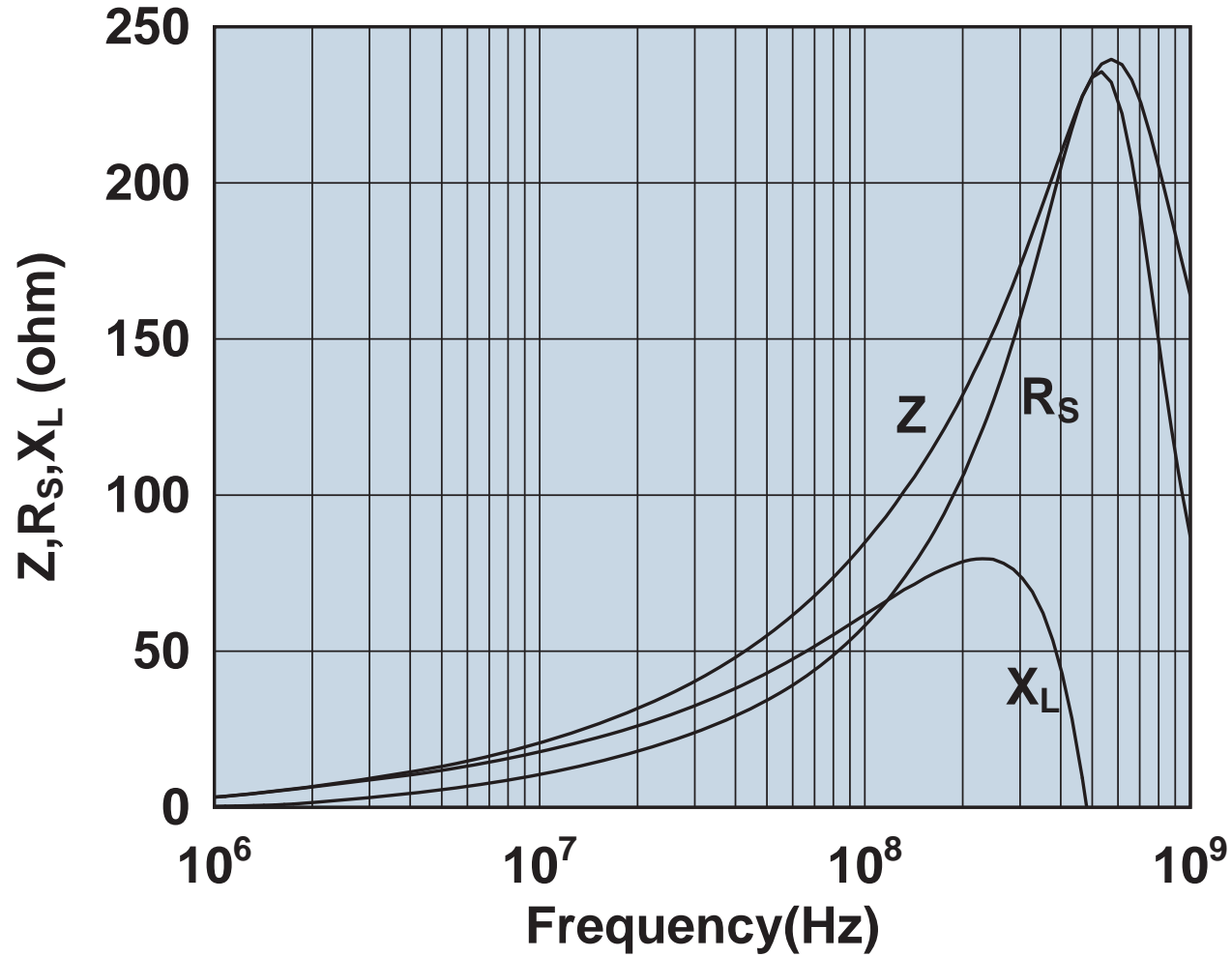

Impedance, reactance, and resistance vs. frequency.

2643175451

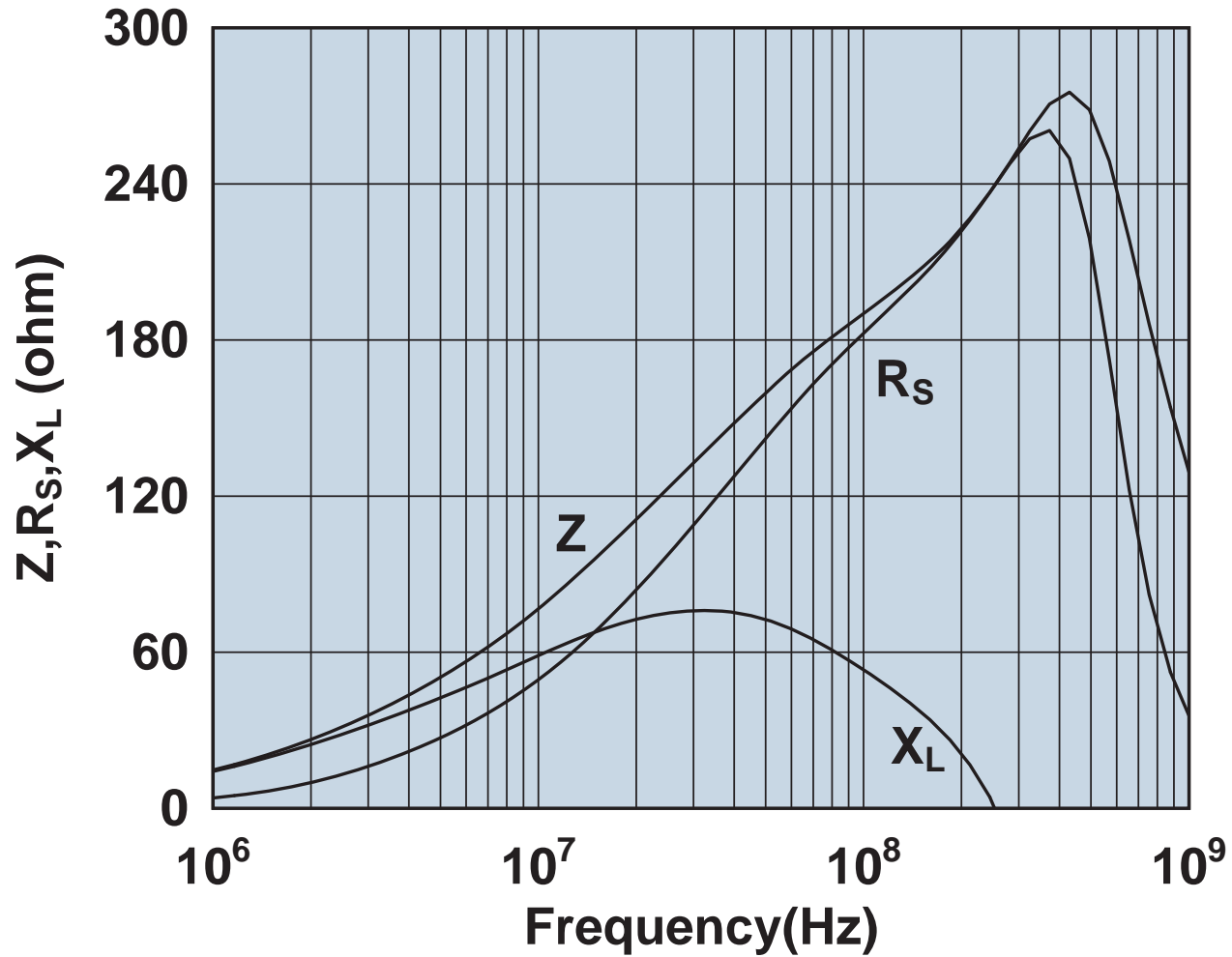

Impedance, reactance, and resistance vs. frequency.

2643178181

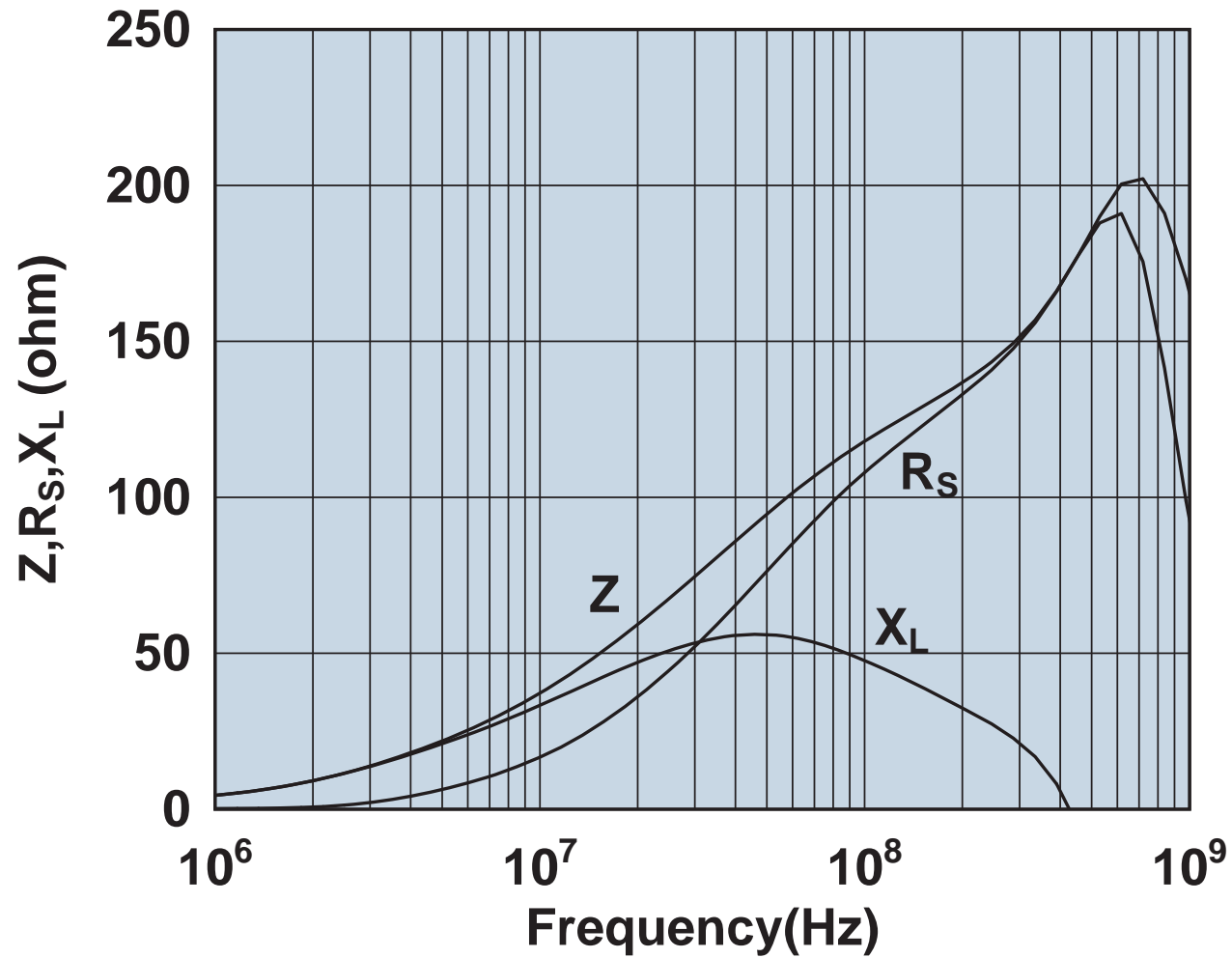

Impedance, reactance, and resistance vs. frequency.

2643178281

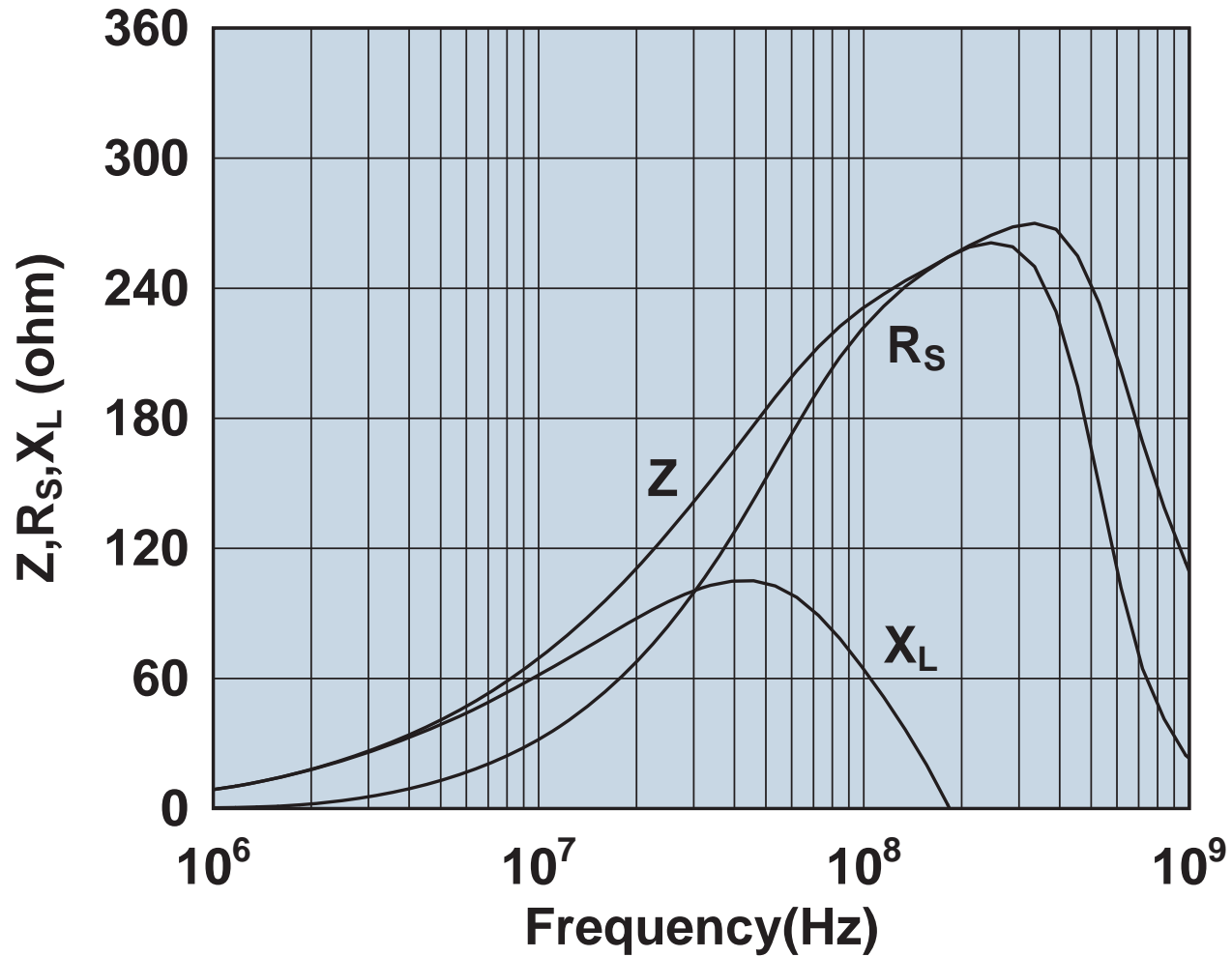

Impedance, reactance, and resistance vs. frequency.

2643178351

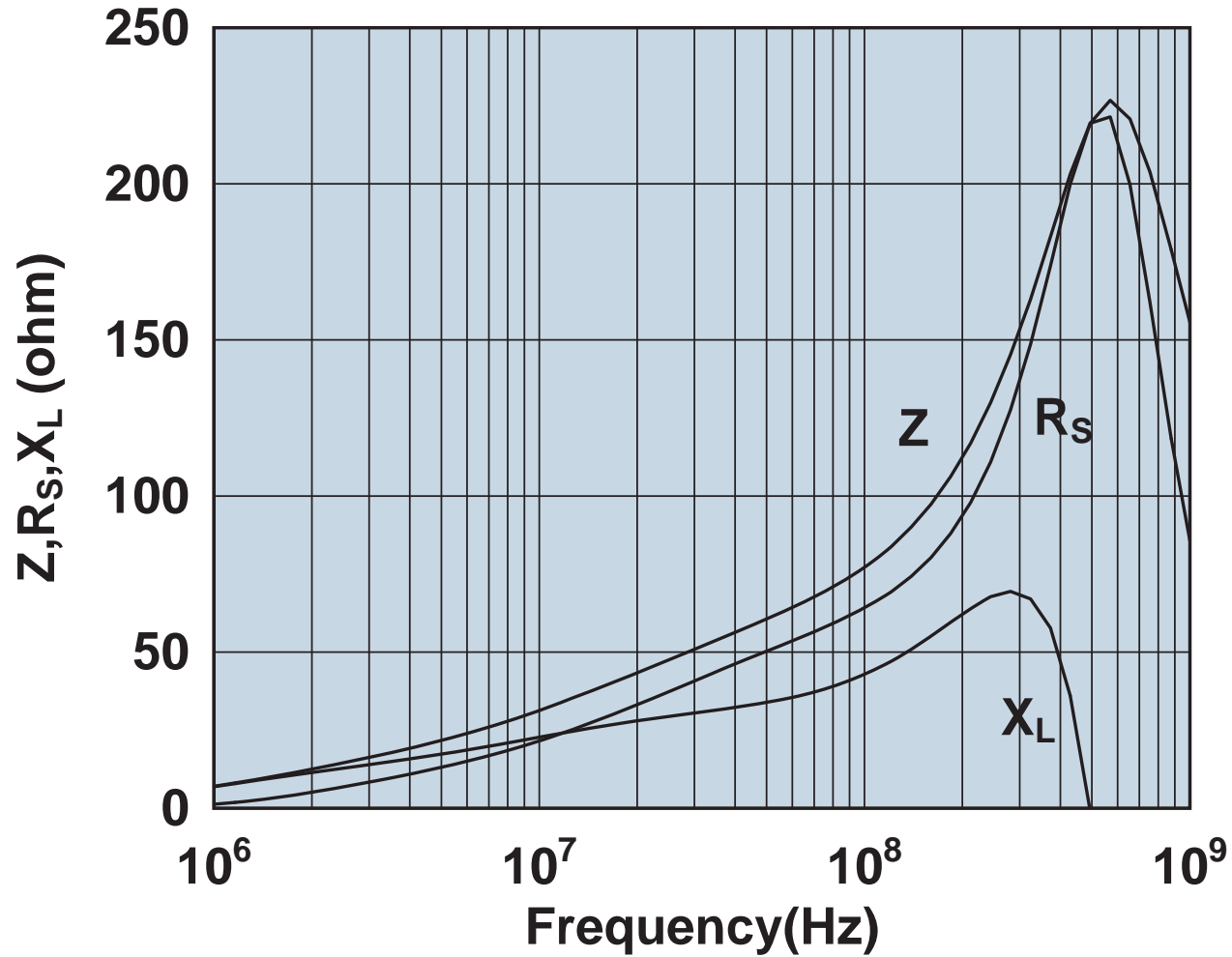

Impedance, reactance, and resistance vs. frequency.

2643178451

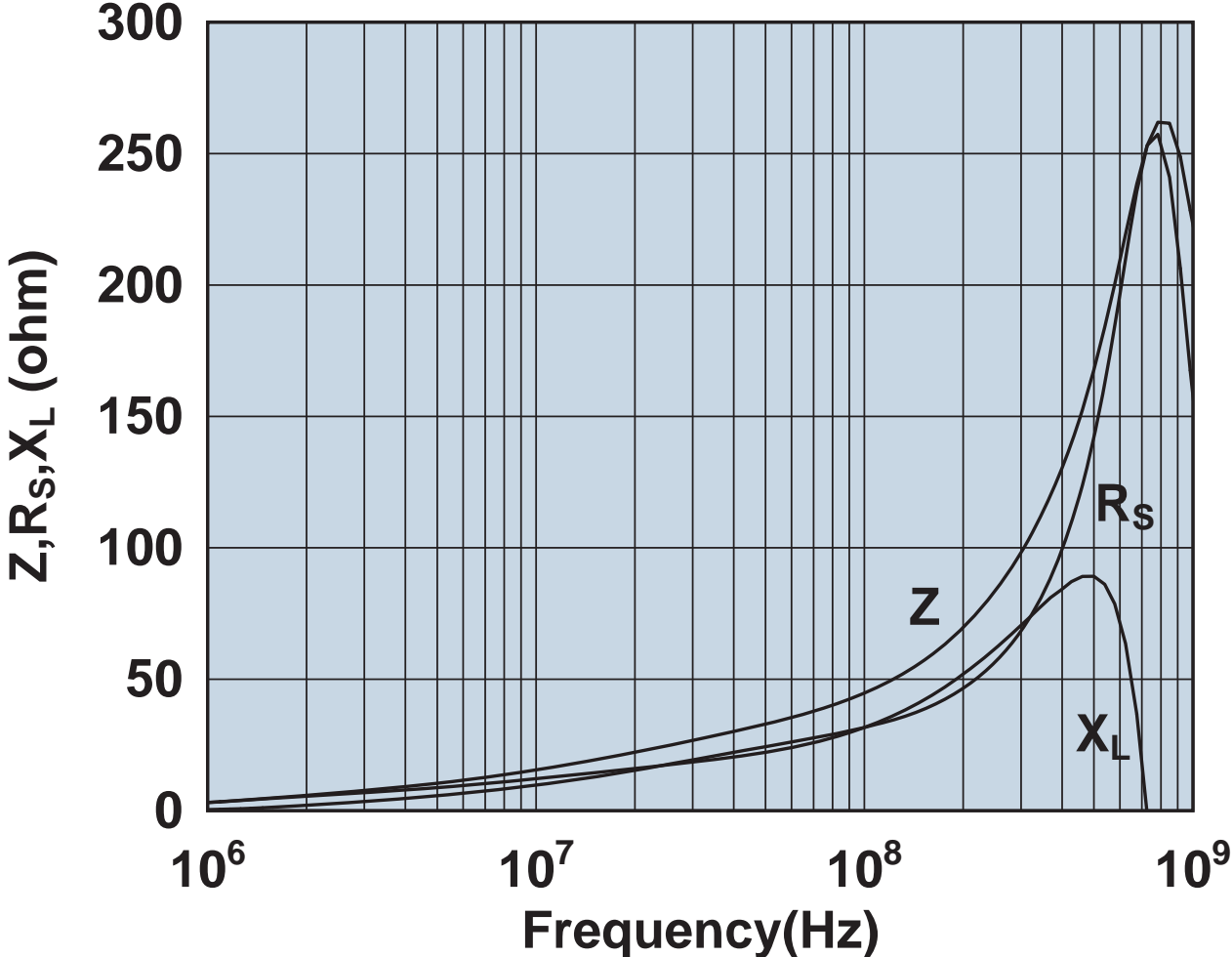

Impedance, reactance, and resistance vs. frequency.

2643178551

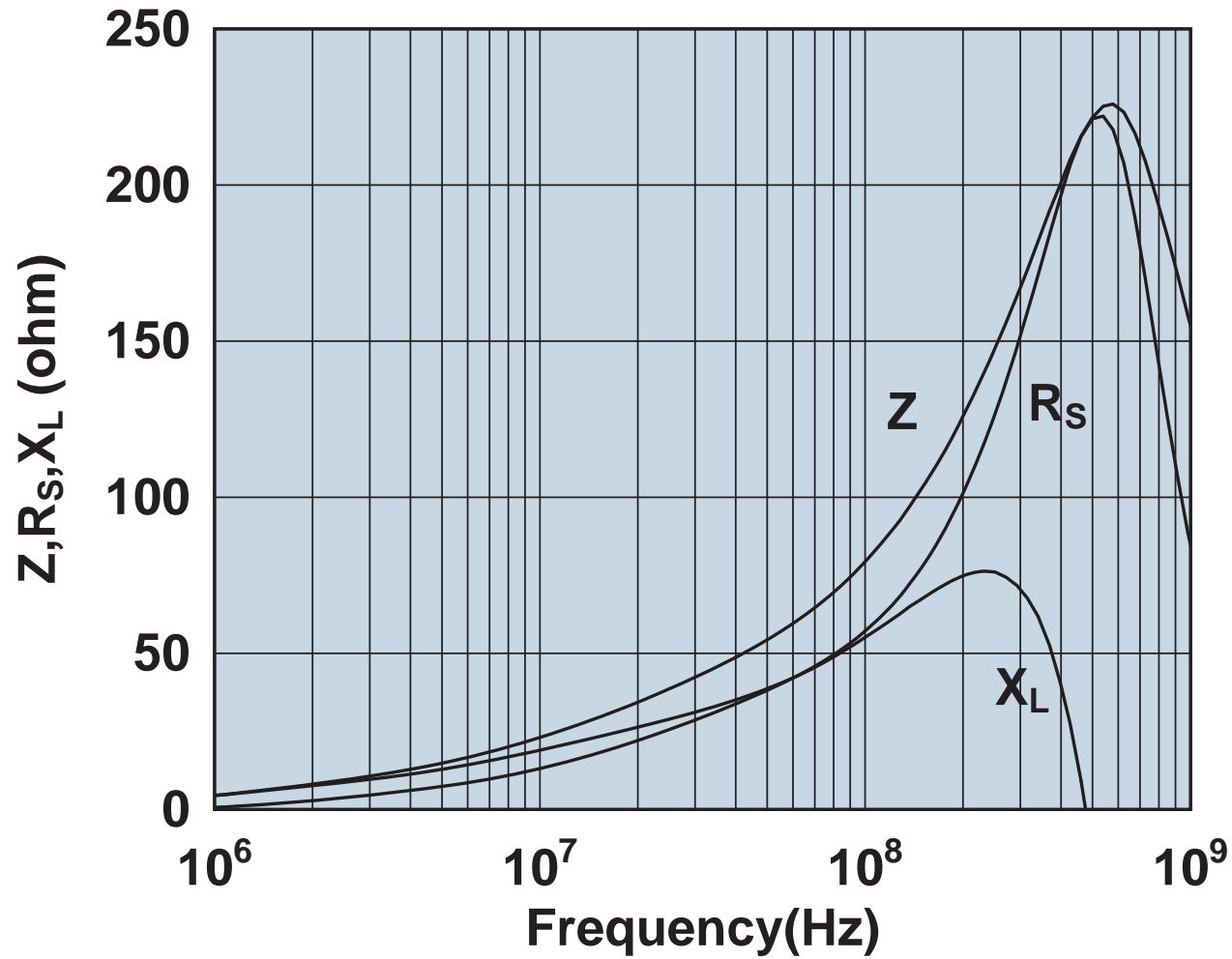

Impedance, reactance, and resistance vs. frequency.

2643178651

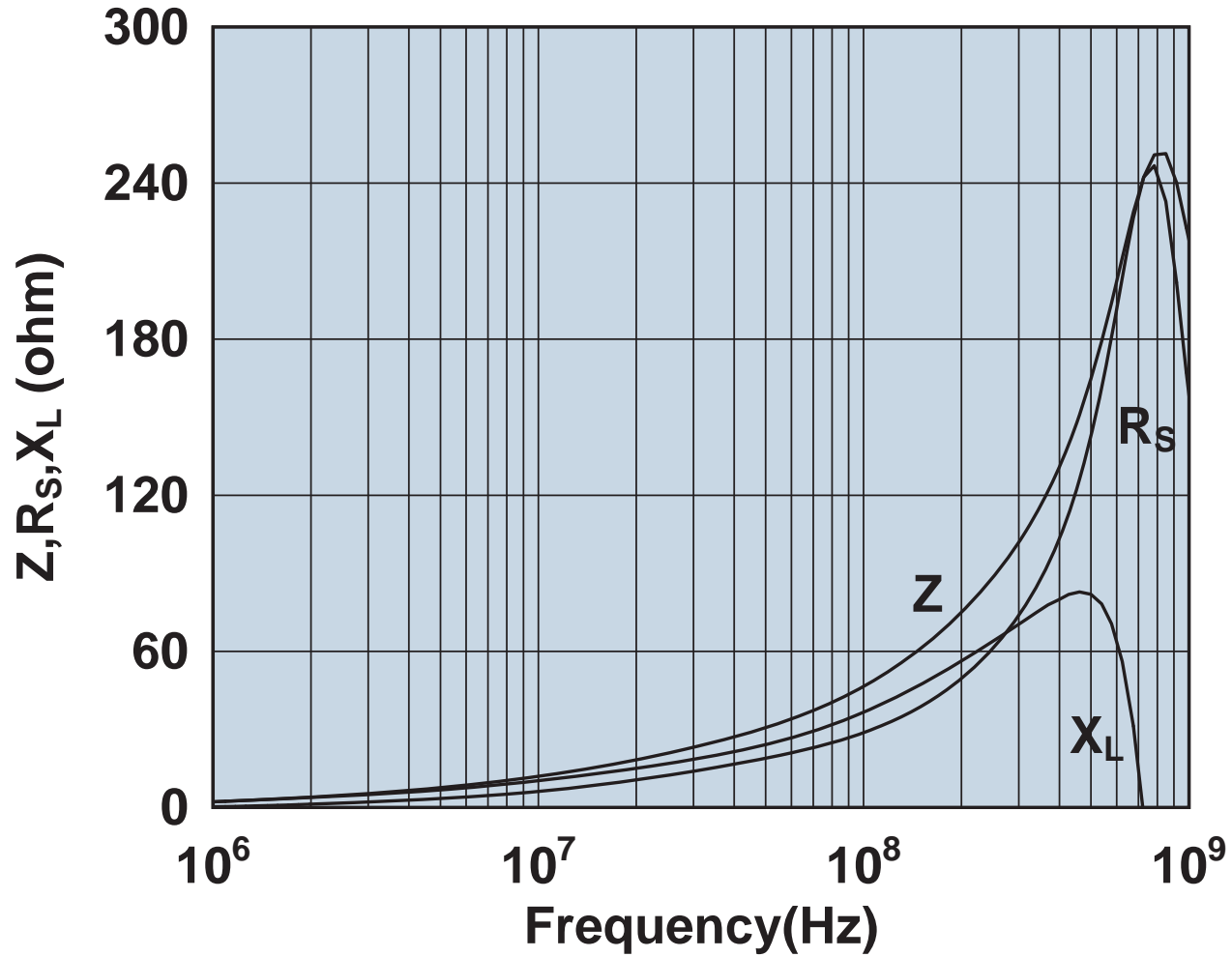

Impedance, reactance, and resistance vs. frequency.

2643178751

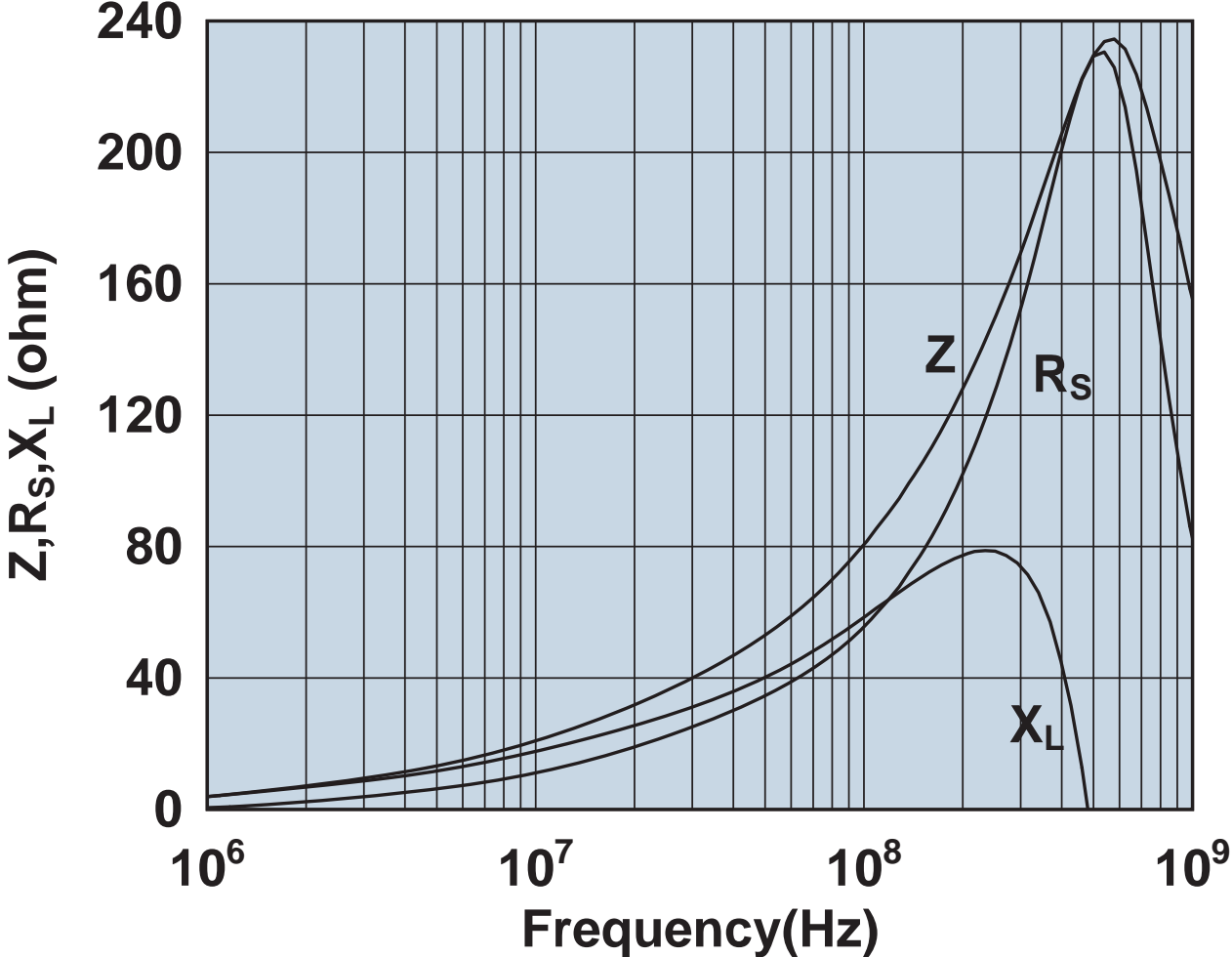

Impedance, reactance, and resistance vs. frequency.

2643178851

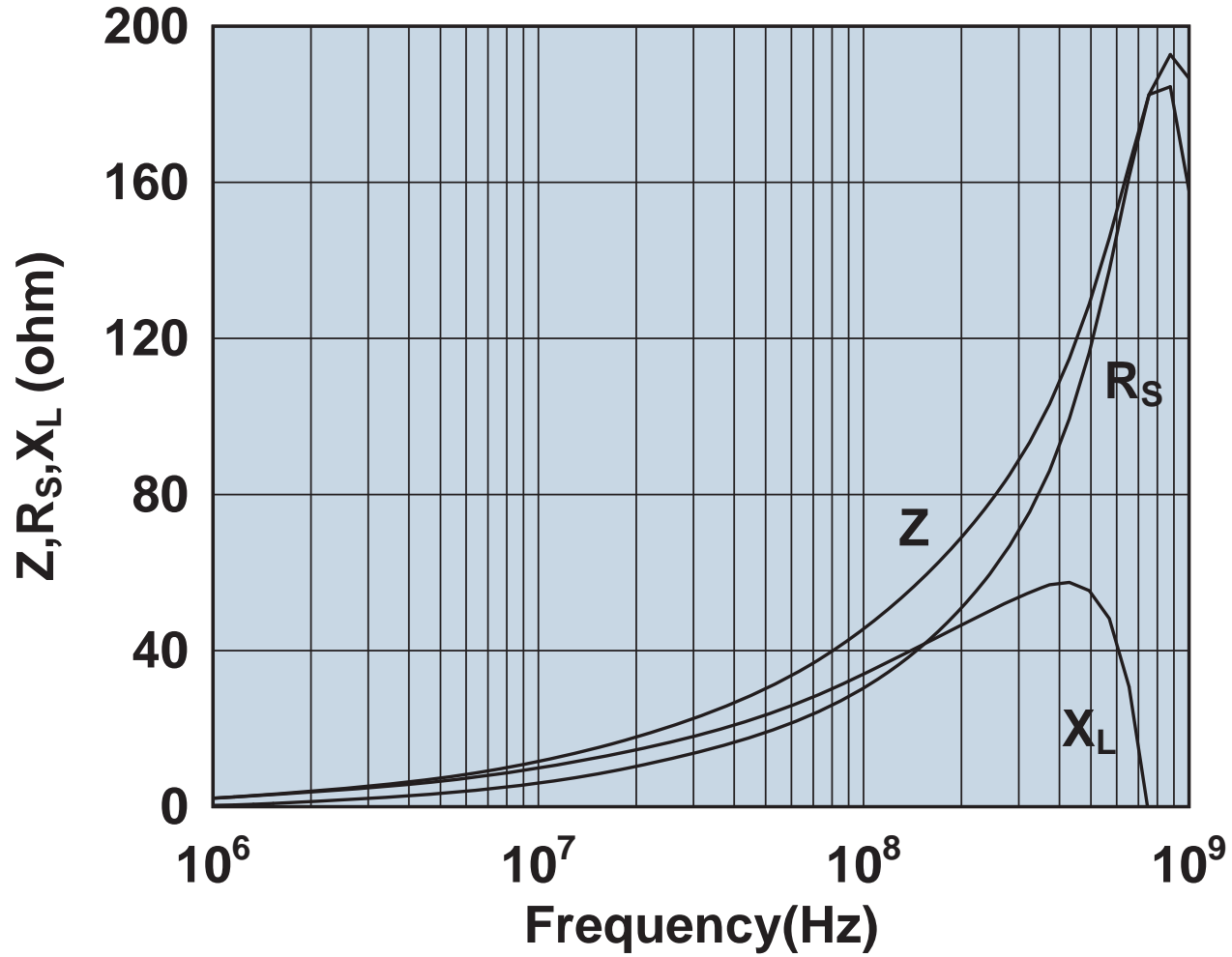

Impedance, reactance, and resistance vs. frequency.

2643251002

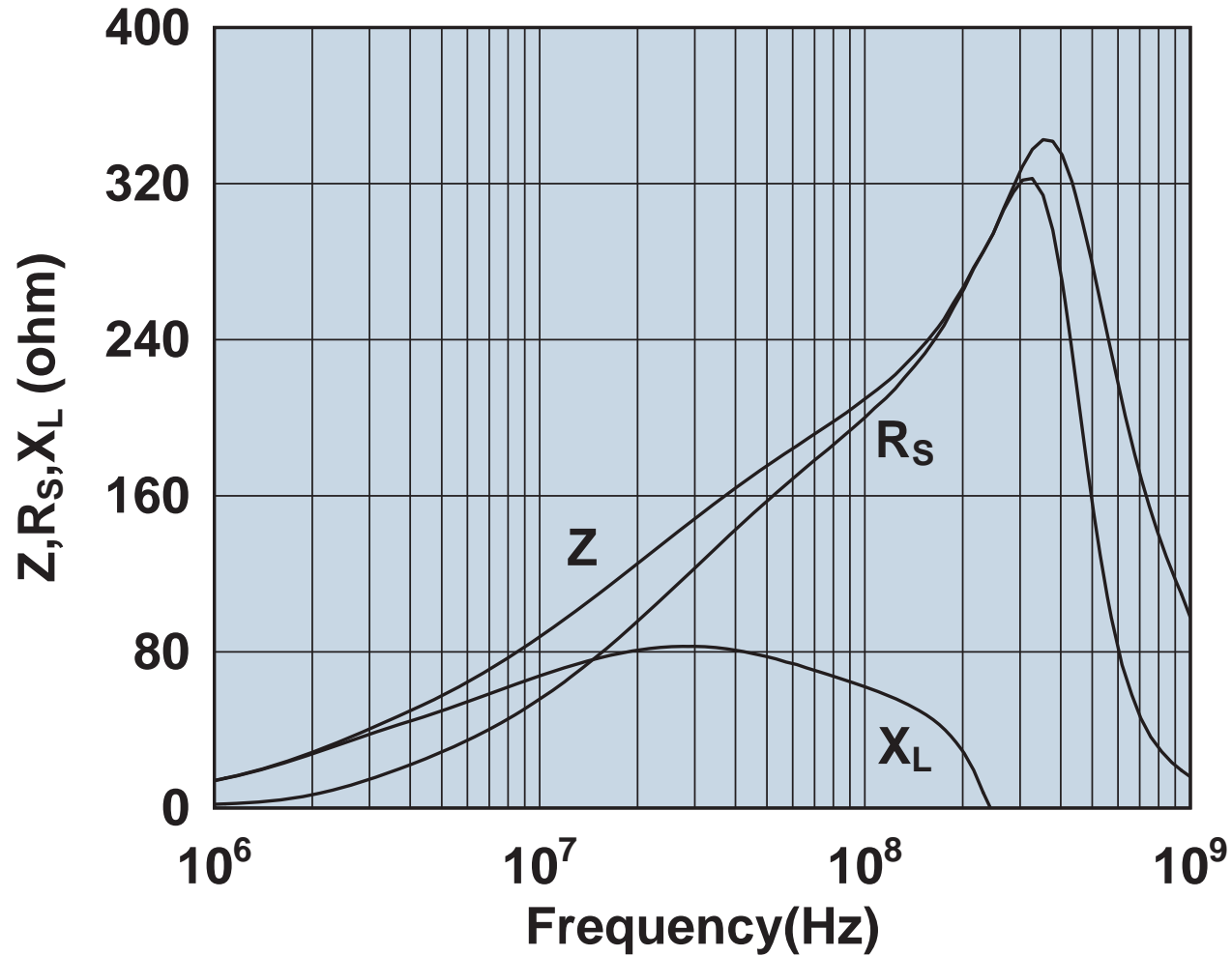

Impedance, reactance, and resistance vs. frequency.

2643480002

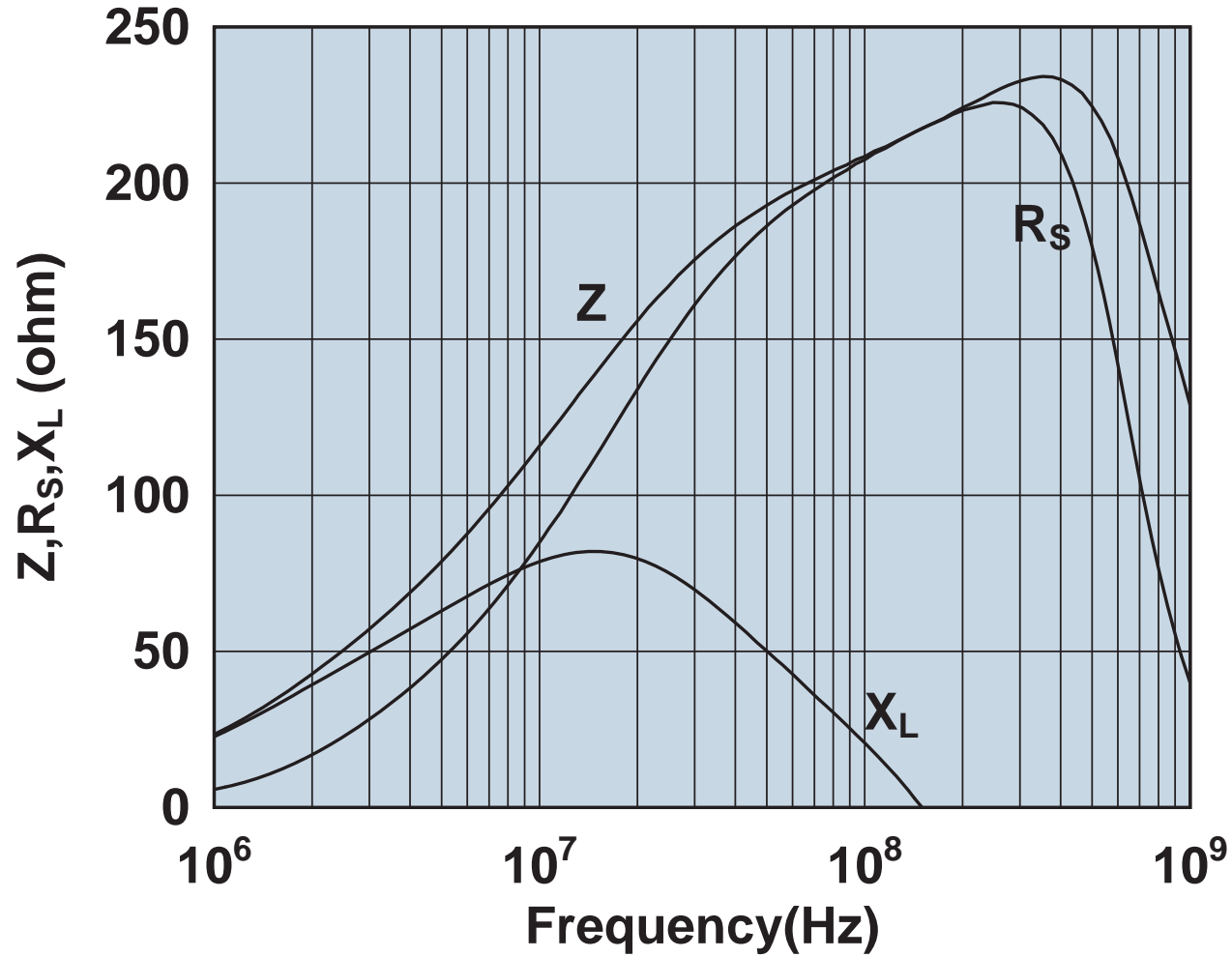

Impedance, reactance, and resistance vs. frequency.

2643480102

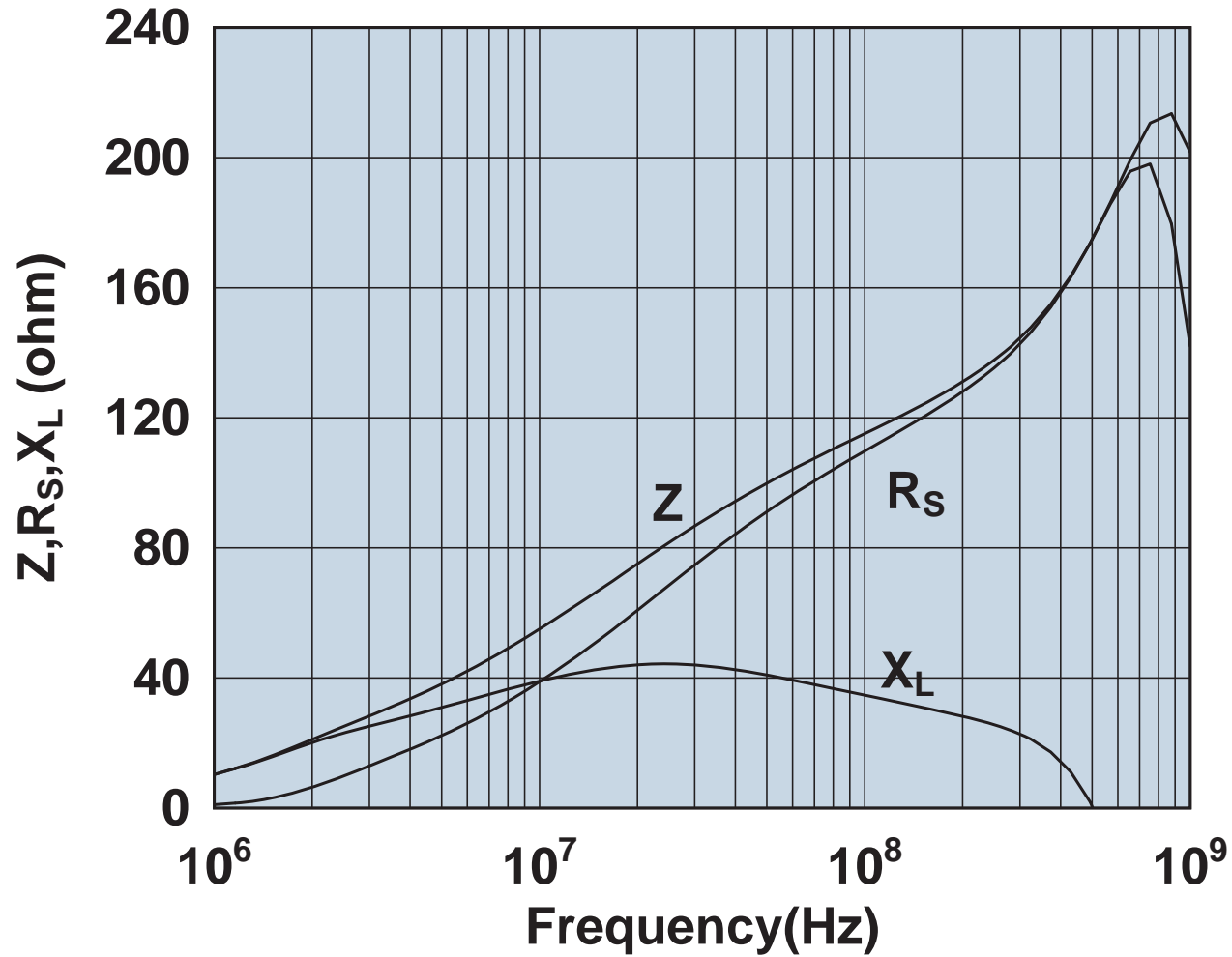

Impedance, reactance, and resistance vs. frequency.

2643540002

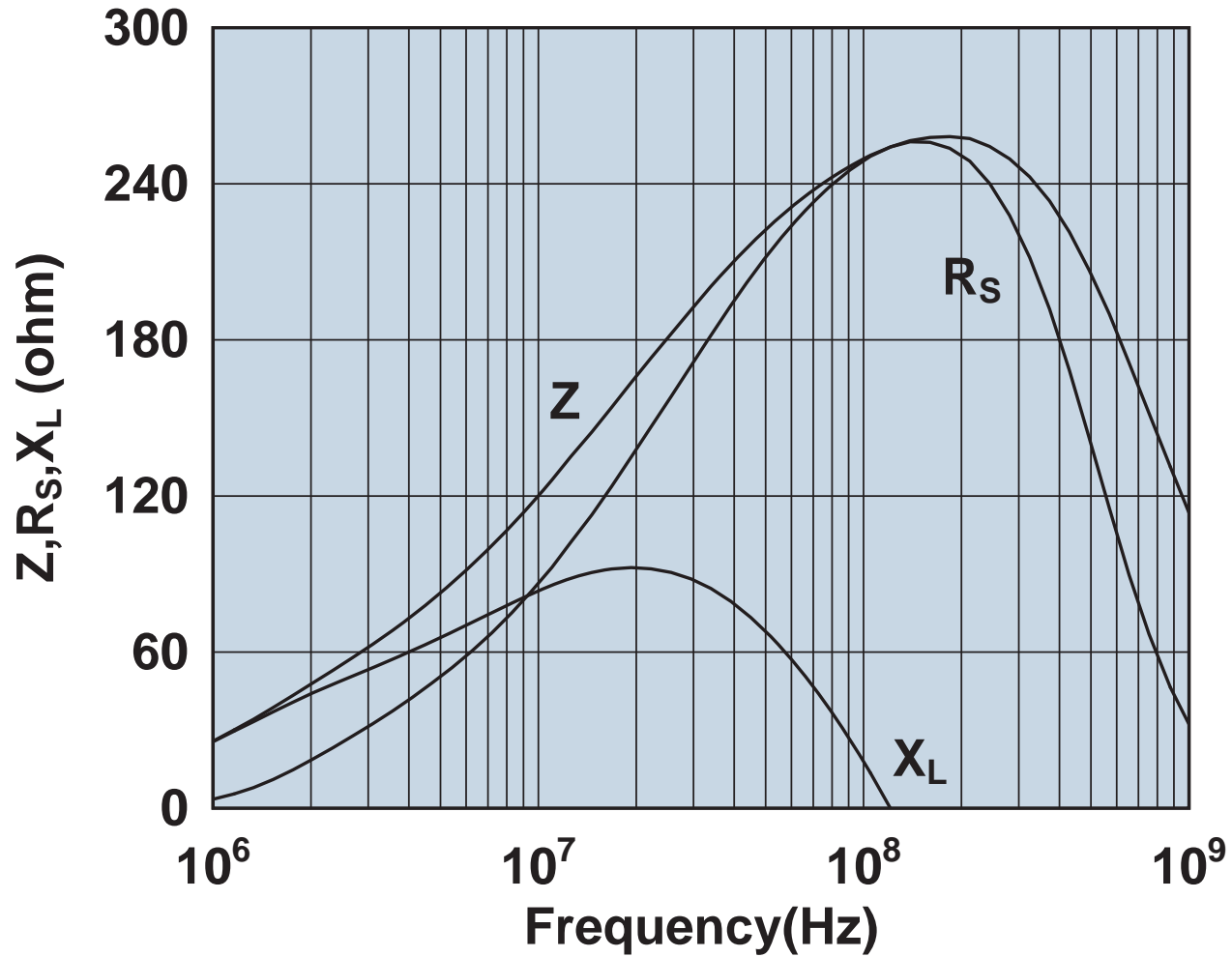

Impedance, reactance, and resistance vs. frequency.

2643540102

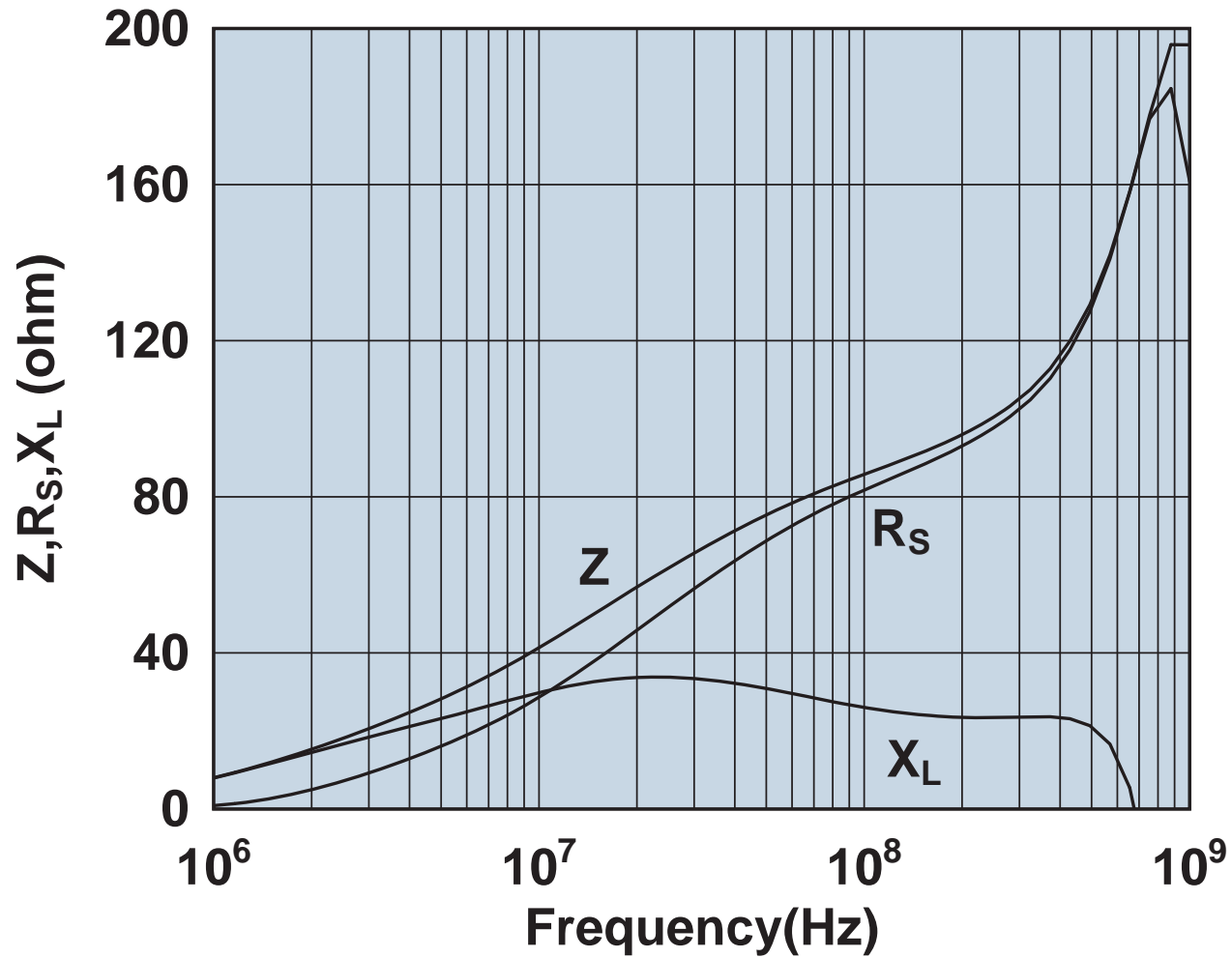

Impedance, reactance, and resistance vs. frequency.

2643540202

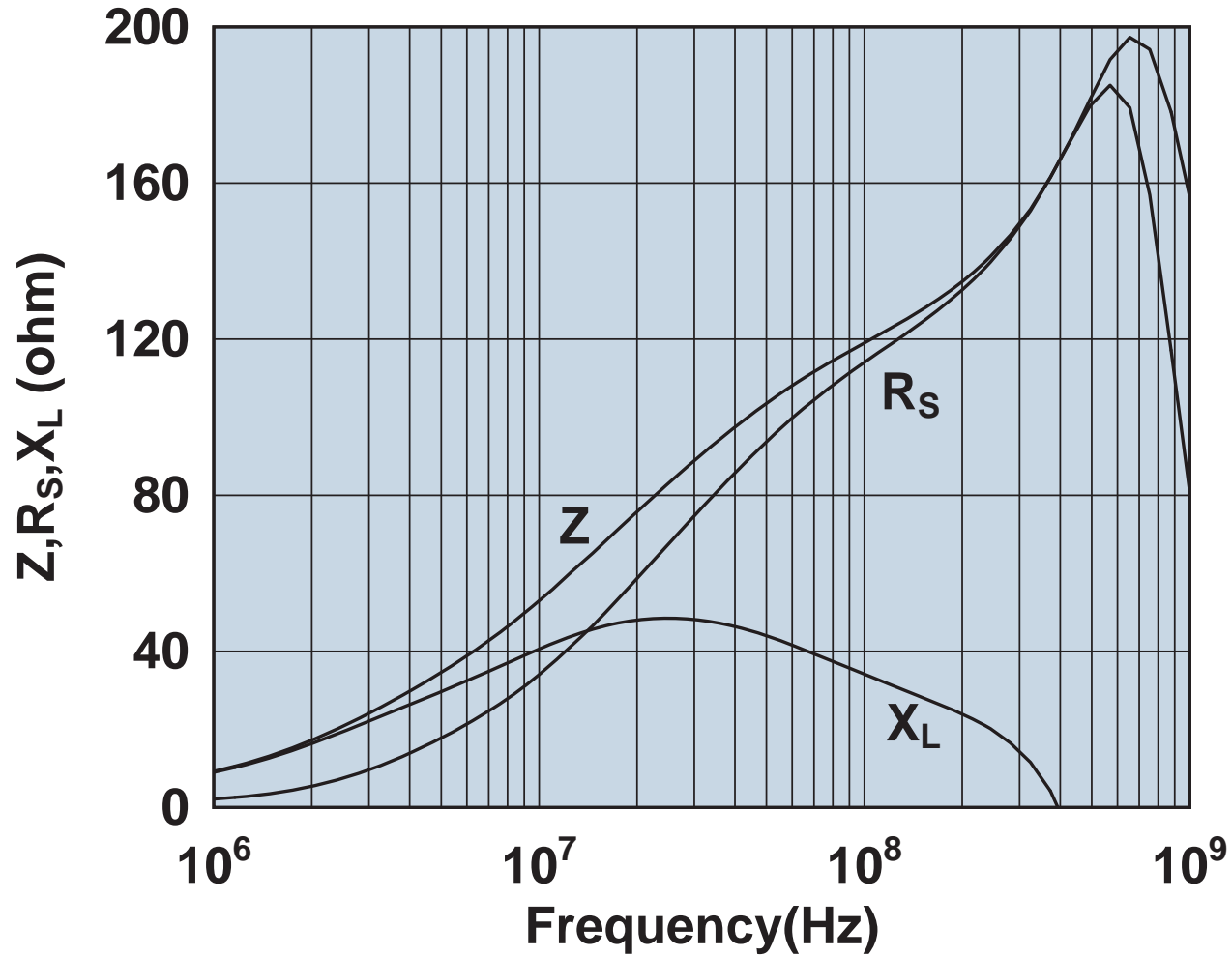

Impedance, reactance, and resistance vs. frequency.

2643540302

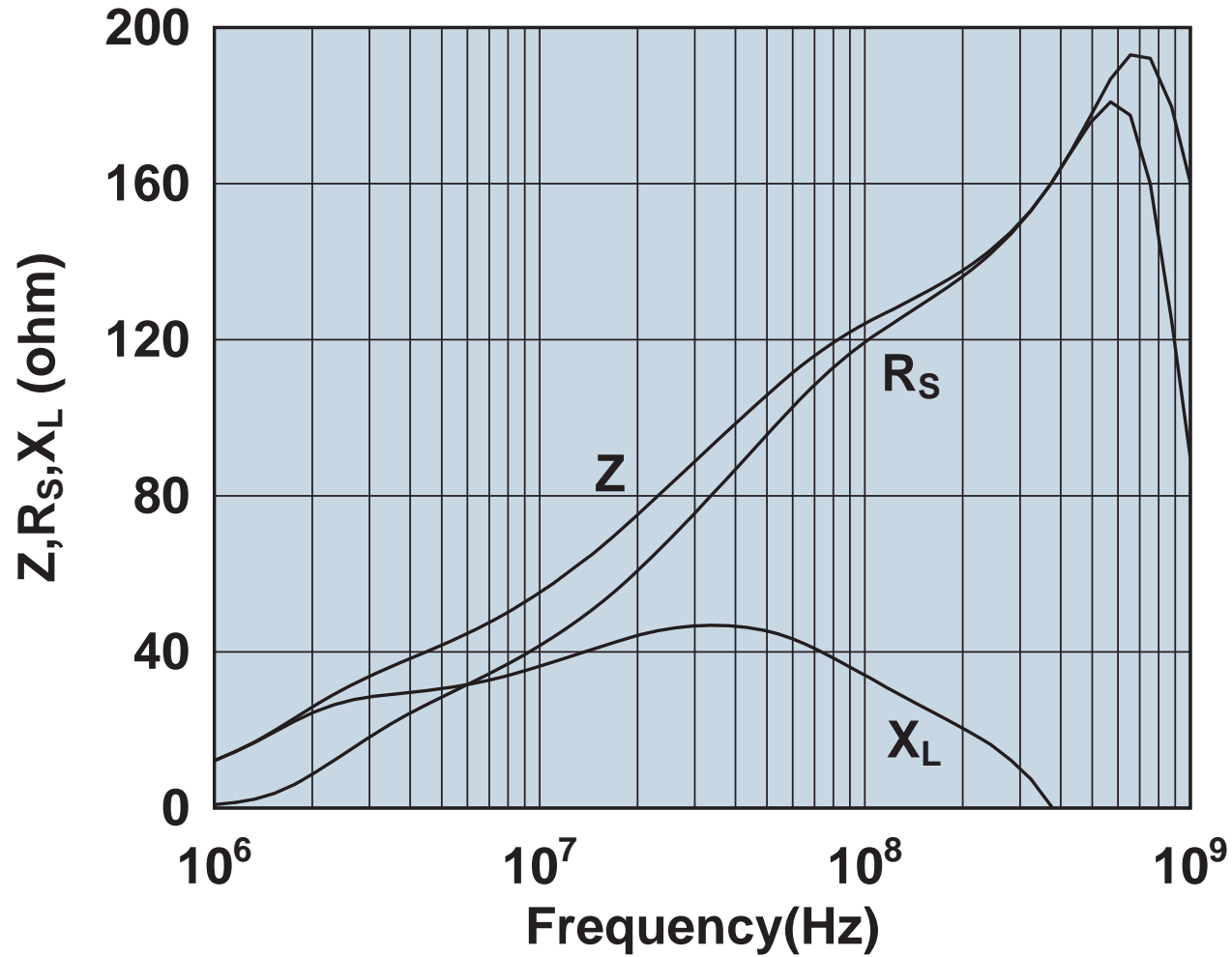

Impedance, reactance, and resistance vs. frequency.

2643540402

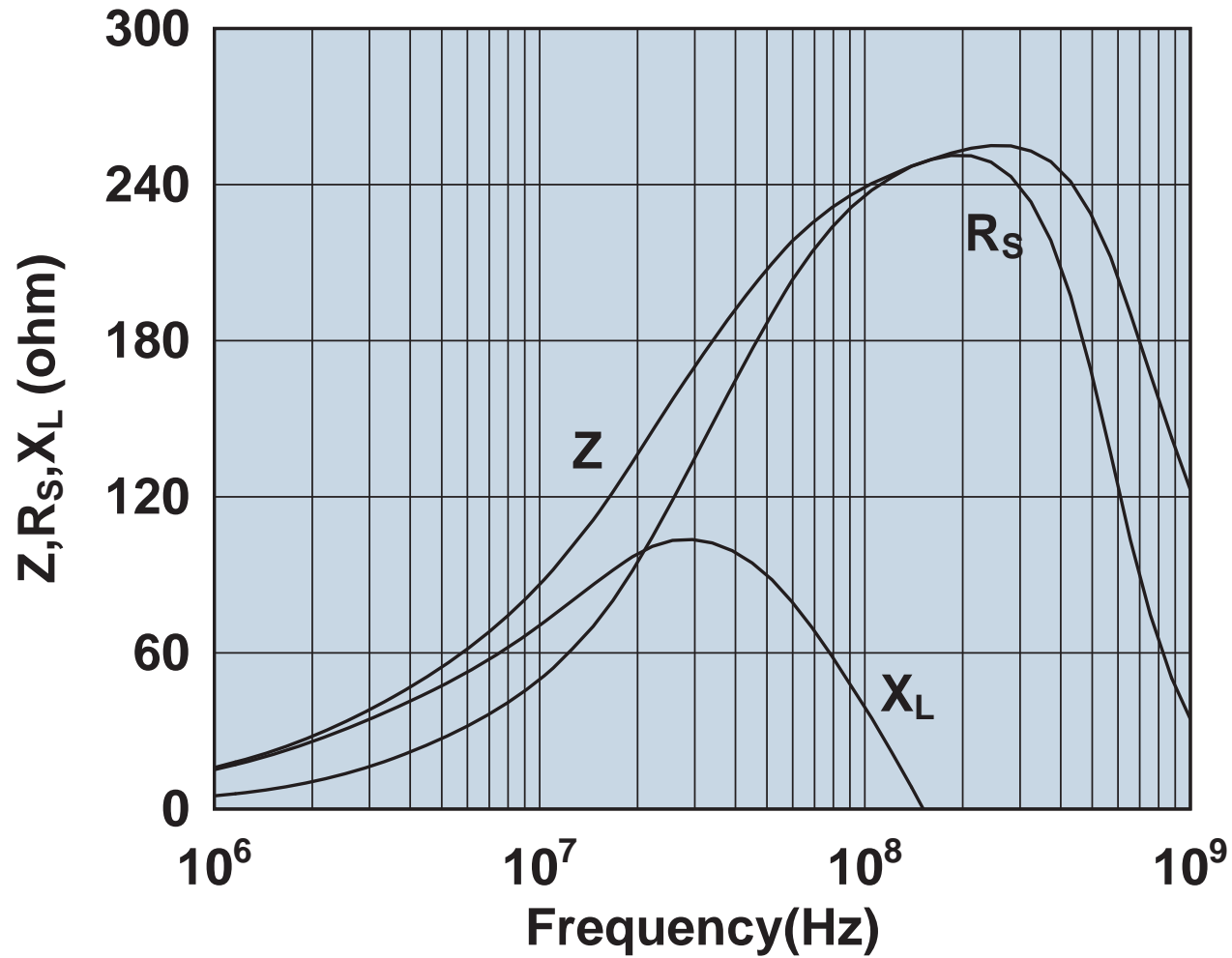

Impedance, reactance, and resistance vs. frequency.

2643540702

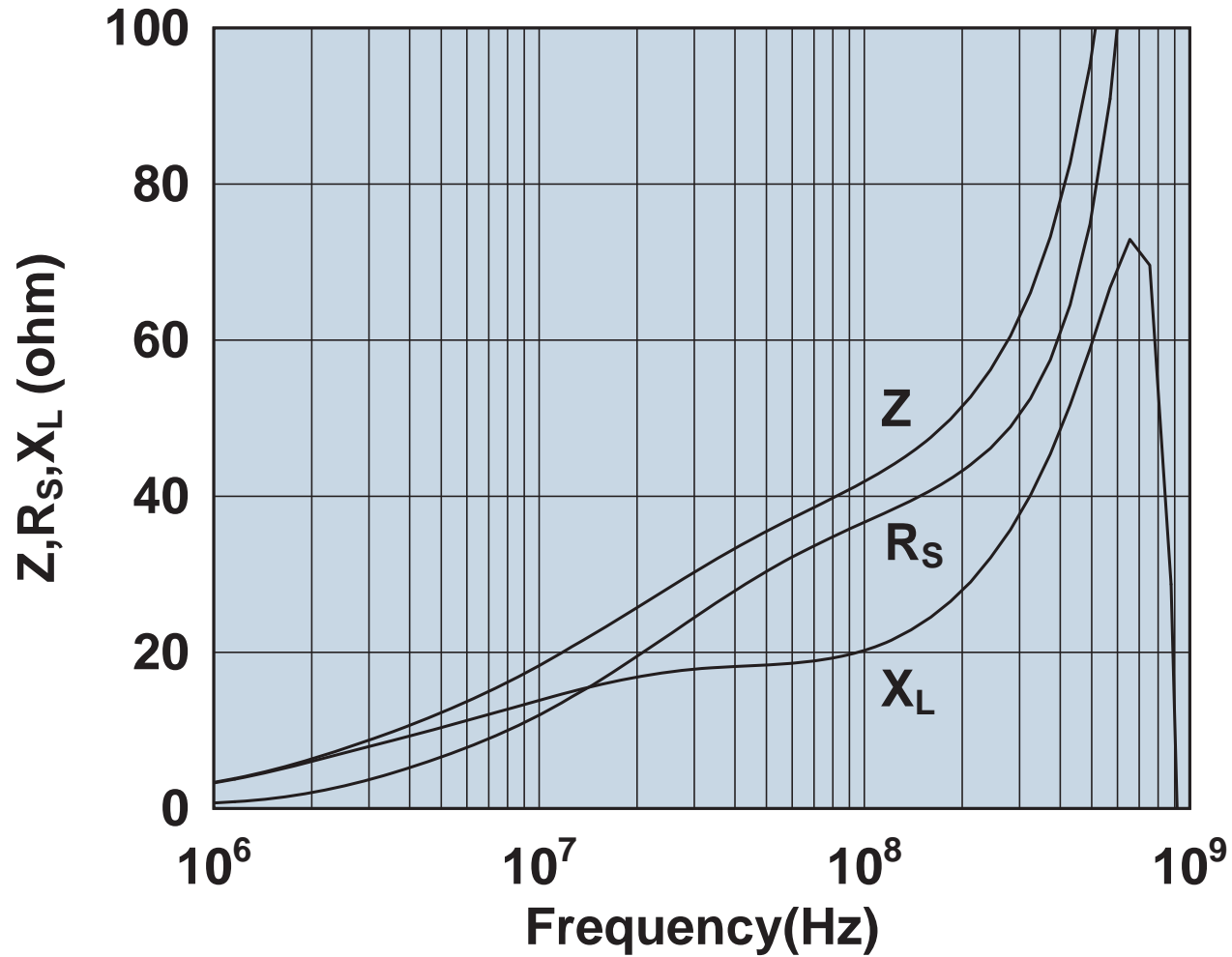

Impedance, reactance, and resistance vs. frequency.

2643625002

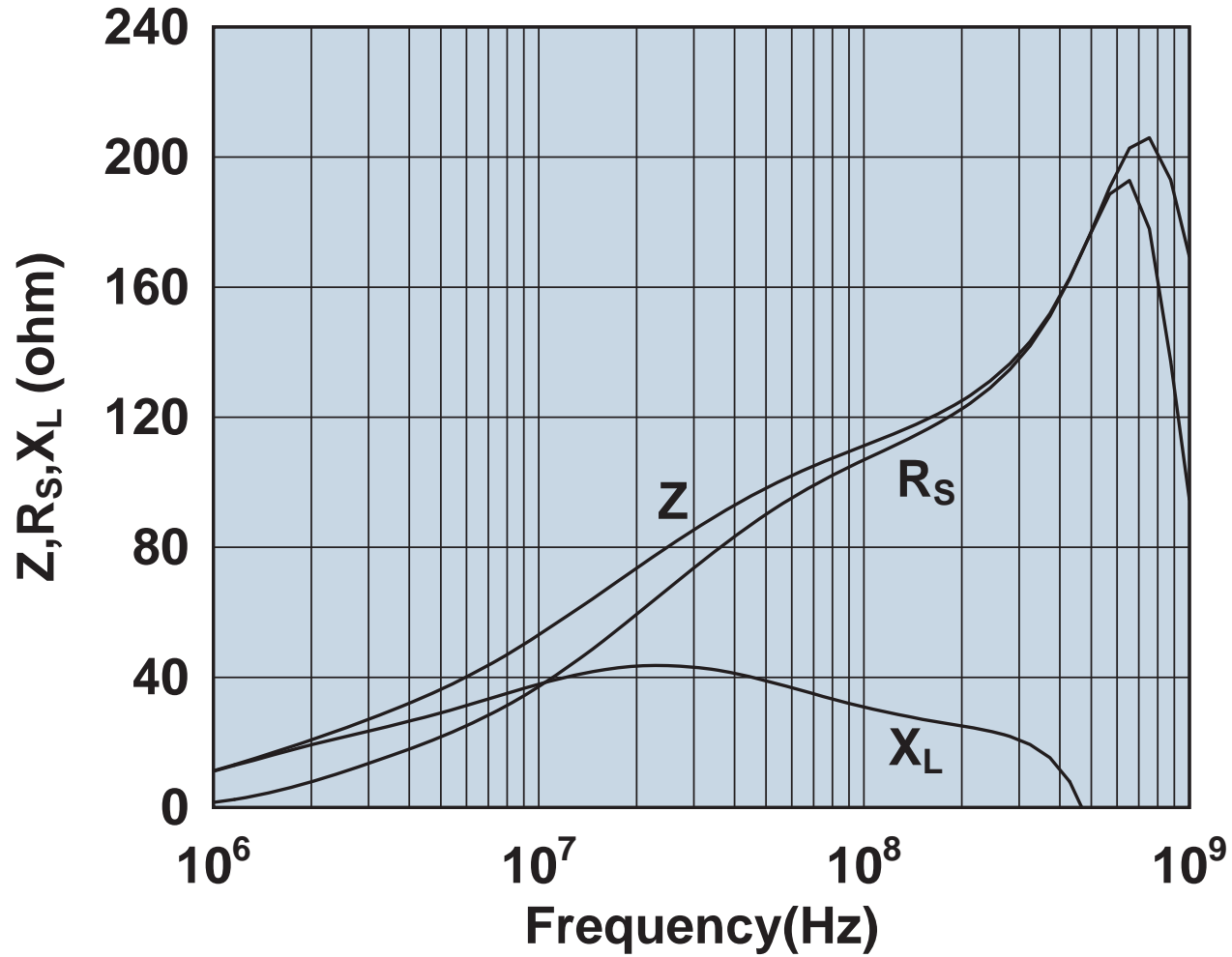

Impedance, reactance, and resistance vs. frequency.

2643625006

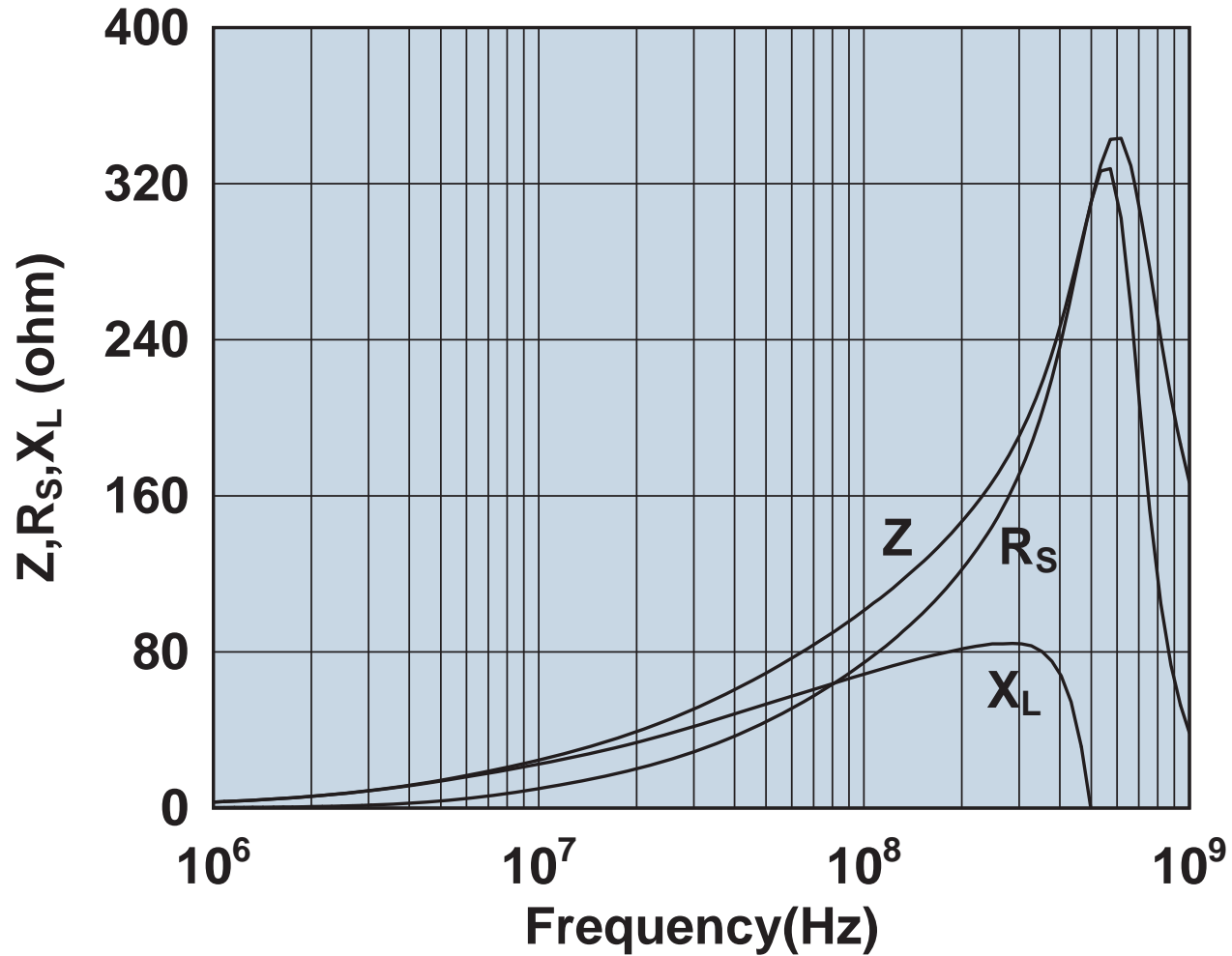

Impedance, reactance, and resistance vs. frequency.

2643625102

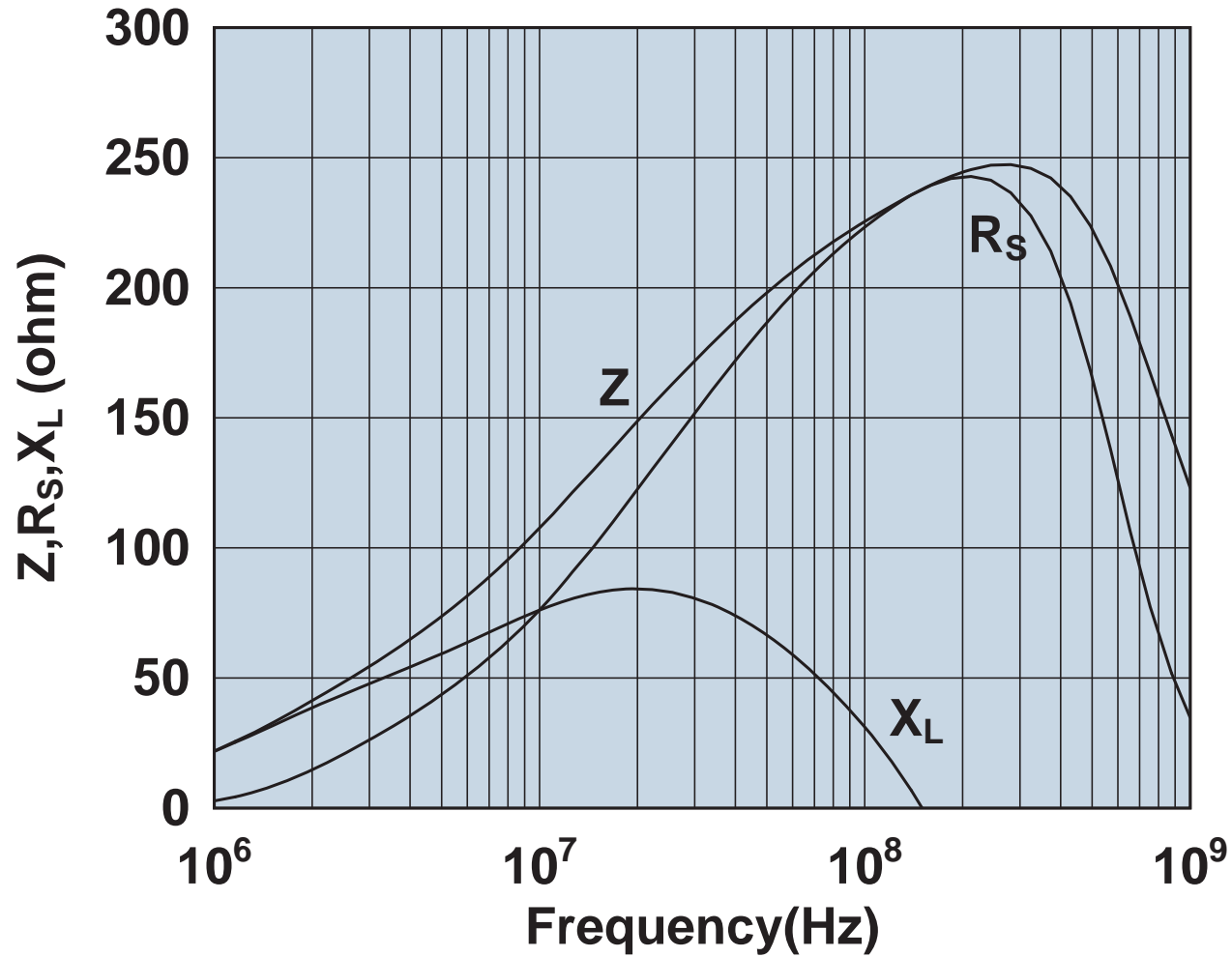

Impedance, reactance, and resistance vs. frequency.

2643625202

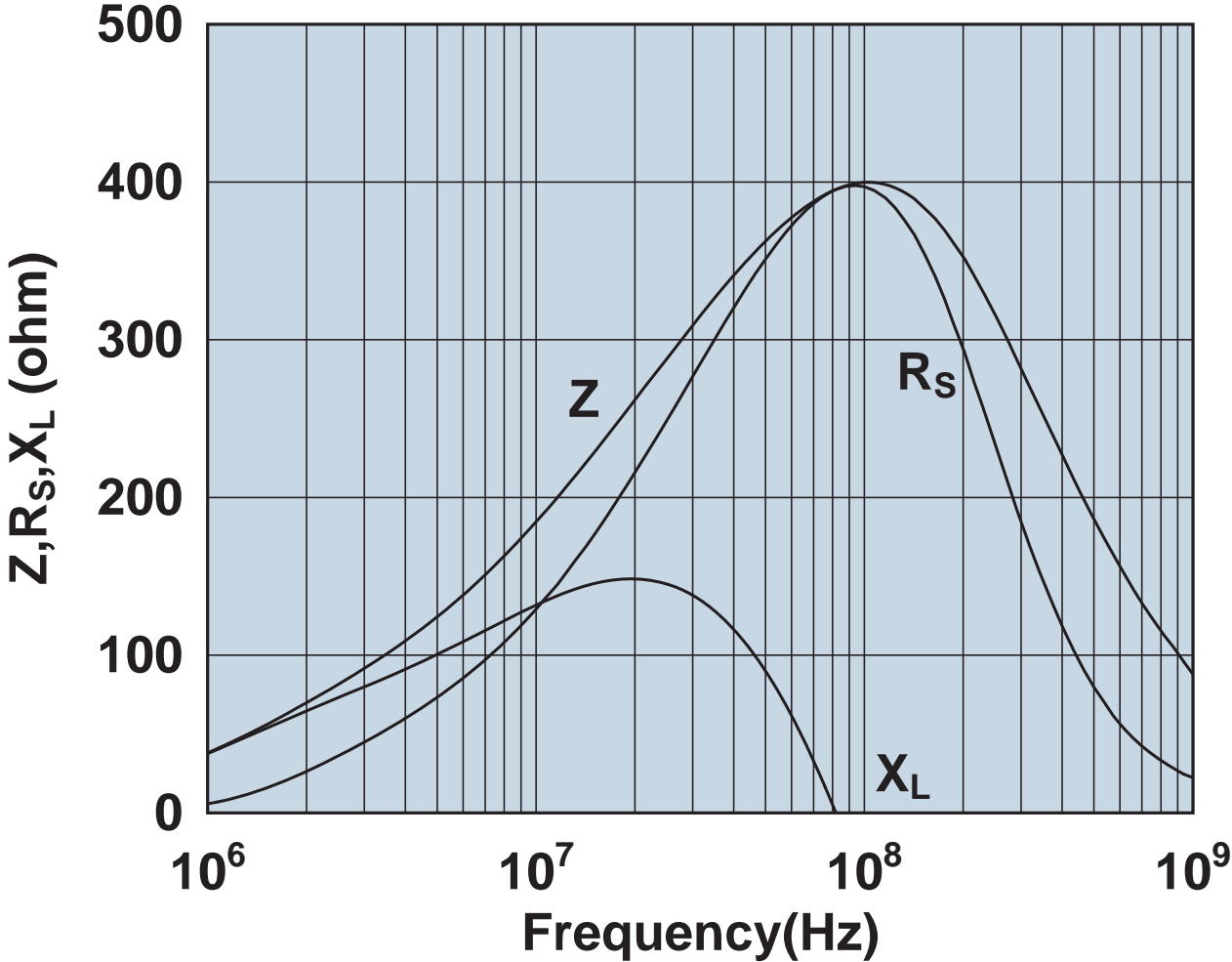

Impedance, reactance, and resistance vs. frequency.

2643625902

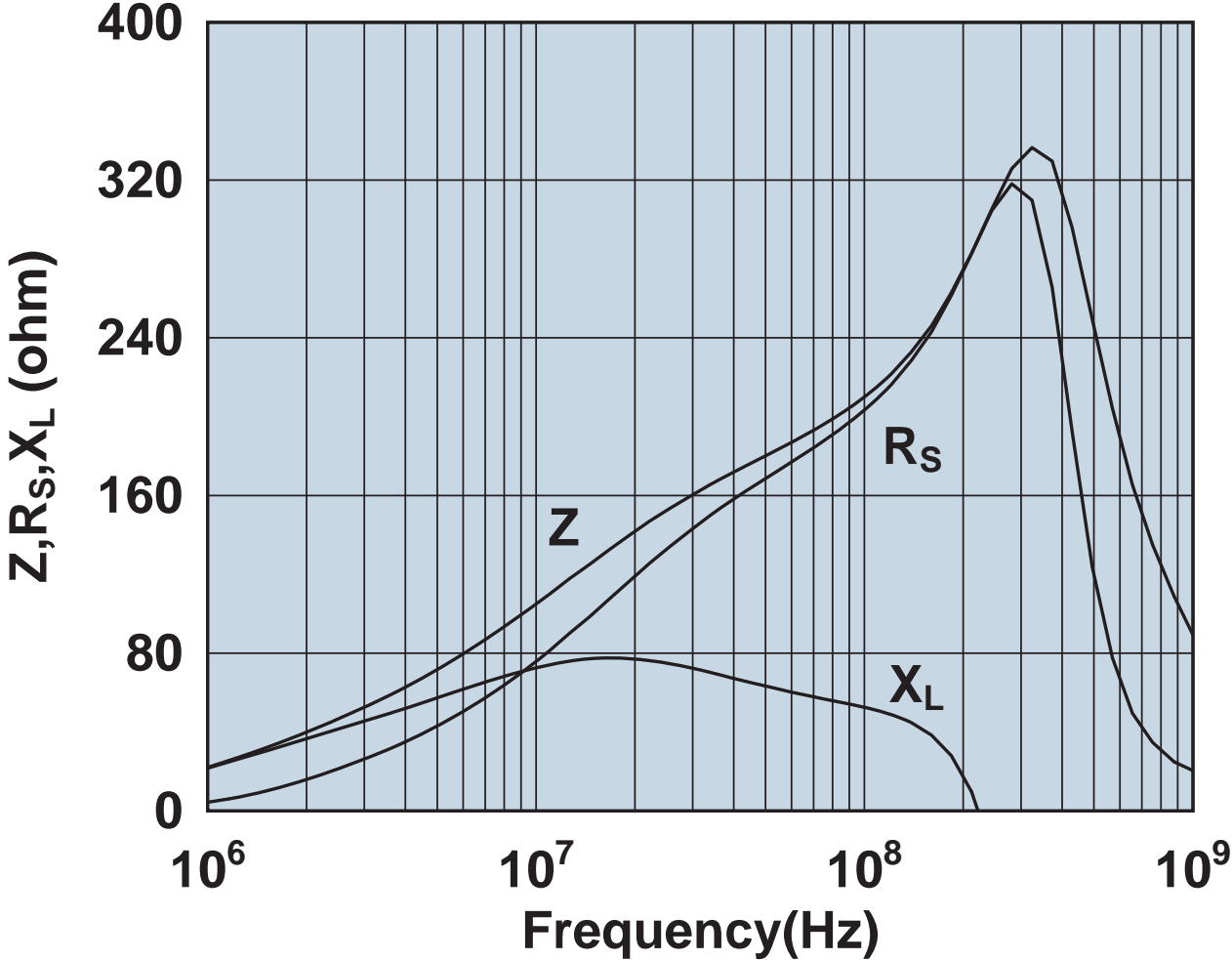

Impedance, reactance, and resistance vs. frequency.

2643626002

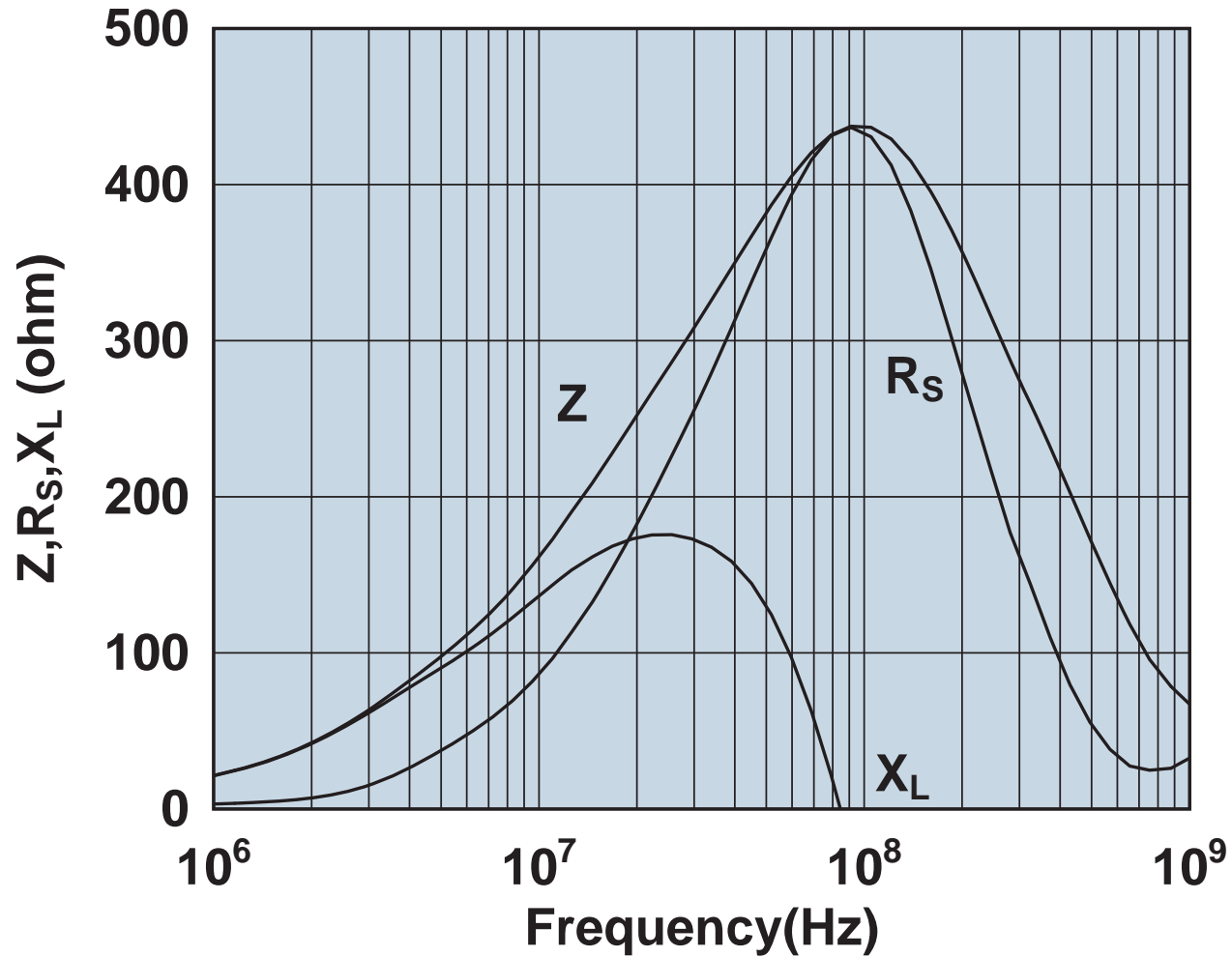

Impedance, reactance, and resistance vs. frequency.

2643626102

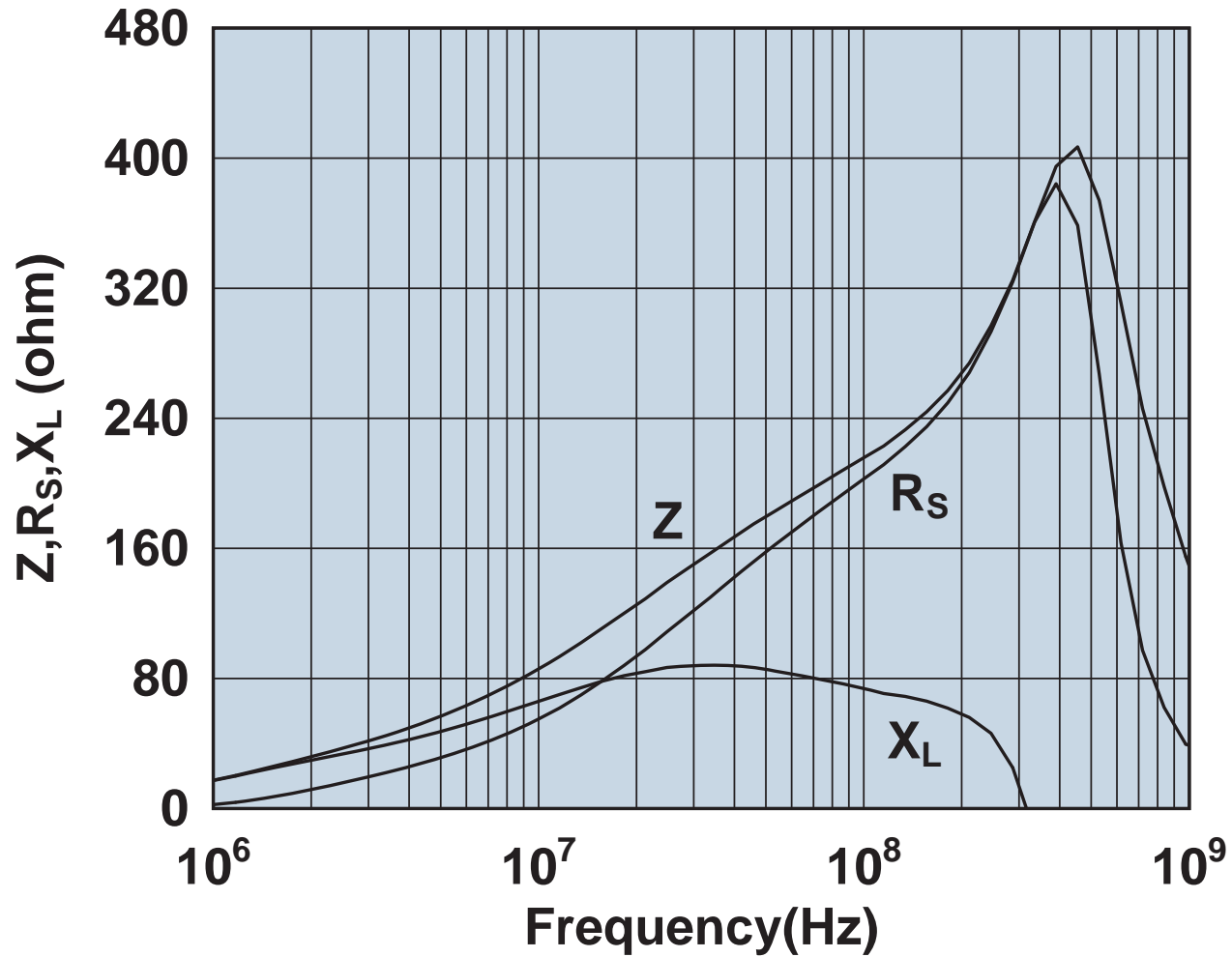

Impedance, reactance, and resistance vs. frequency.

2643626202

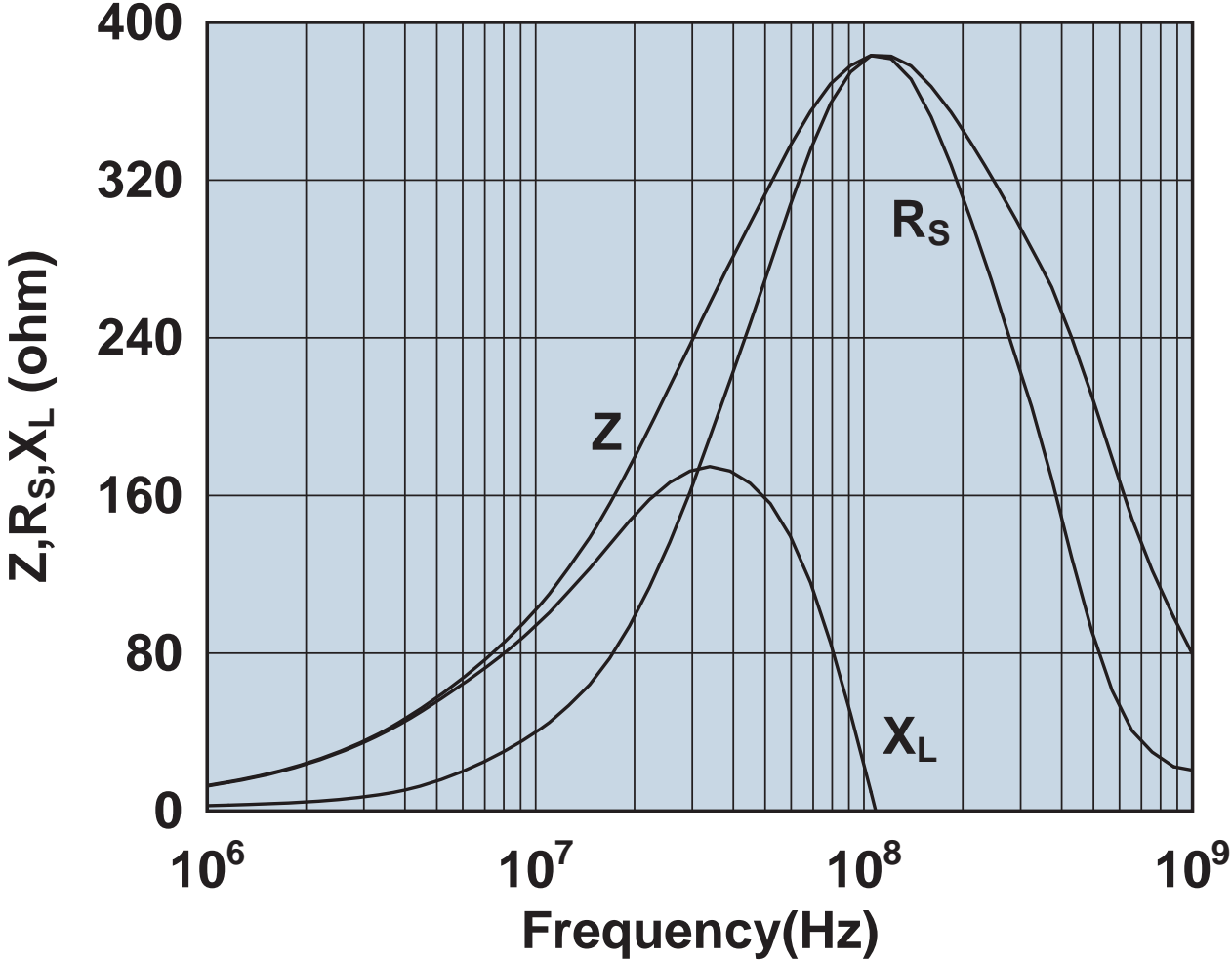

Impedance, reactance, and resistance vs. frequency.

2643626302

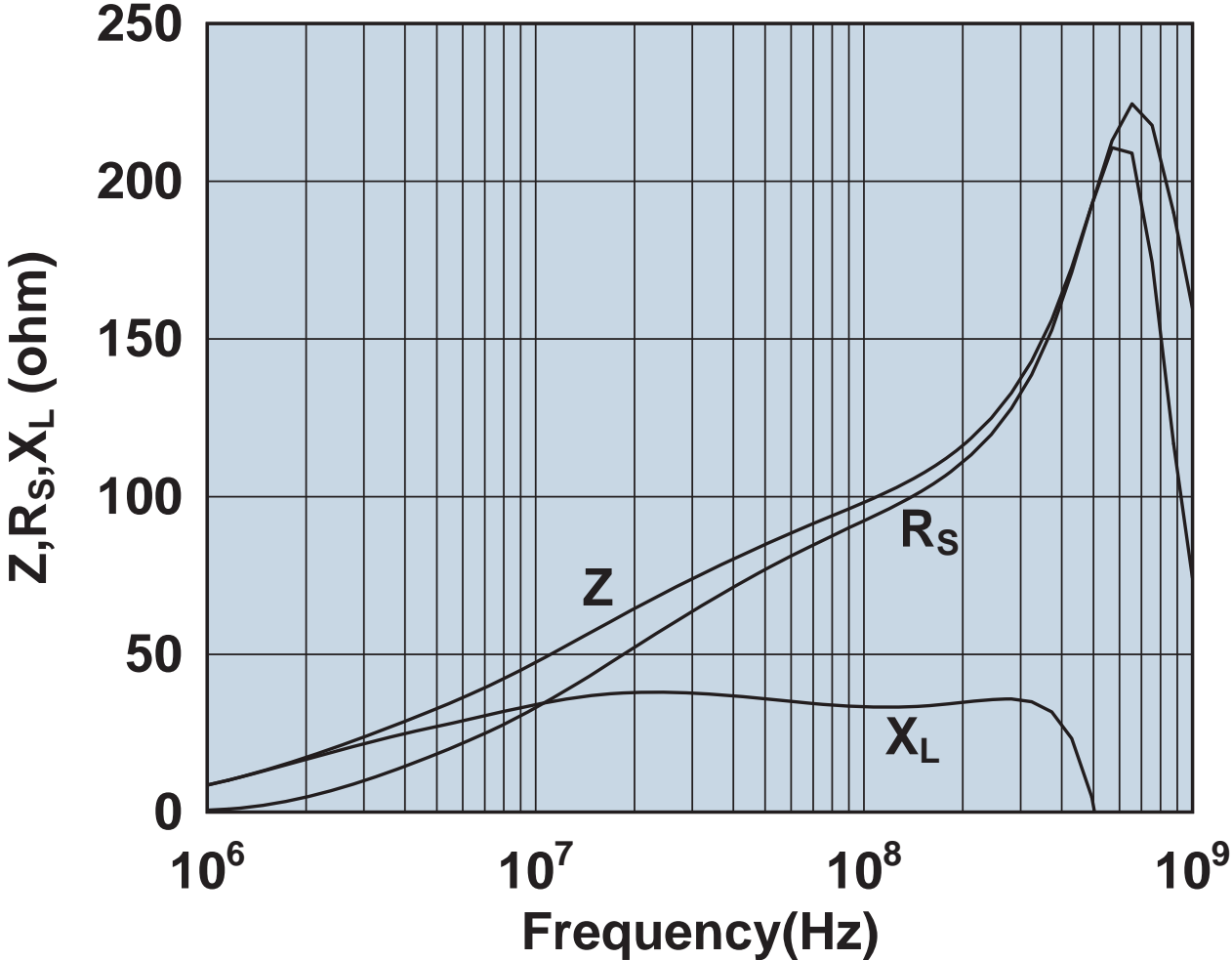

Impedance, reactance, and resistance vs. frequency.

2643626402

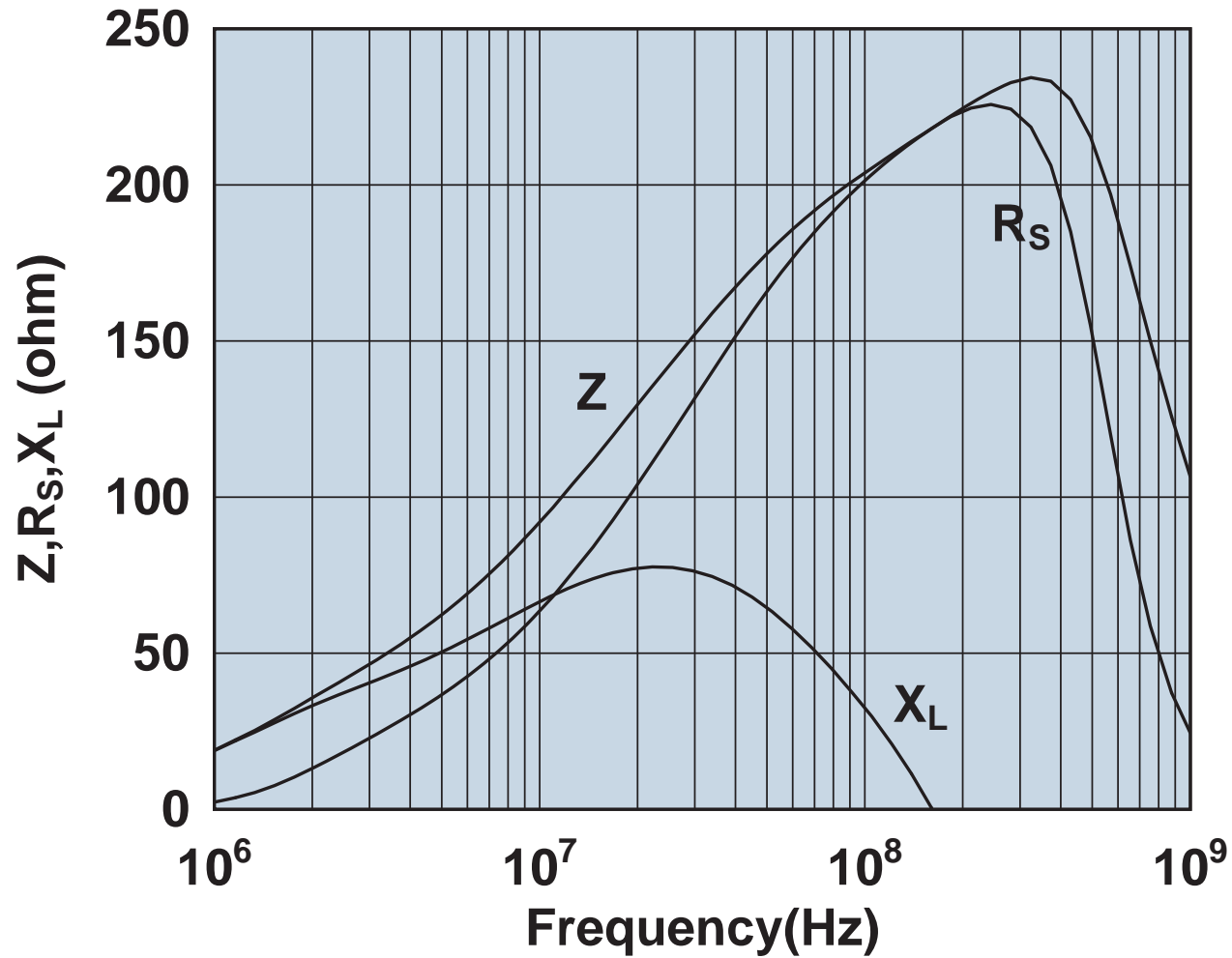

Impedance, reactance, and resistance vs. frequency.

2643626502

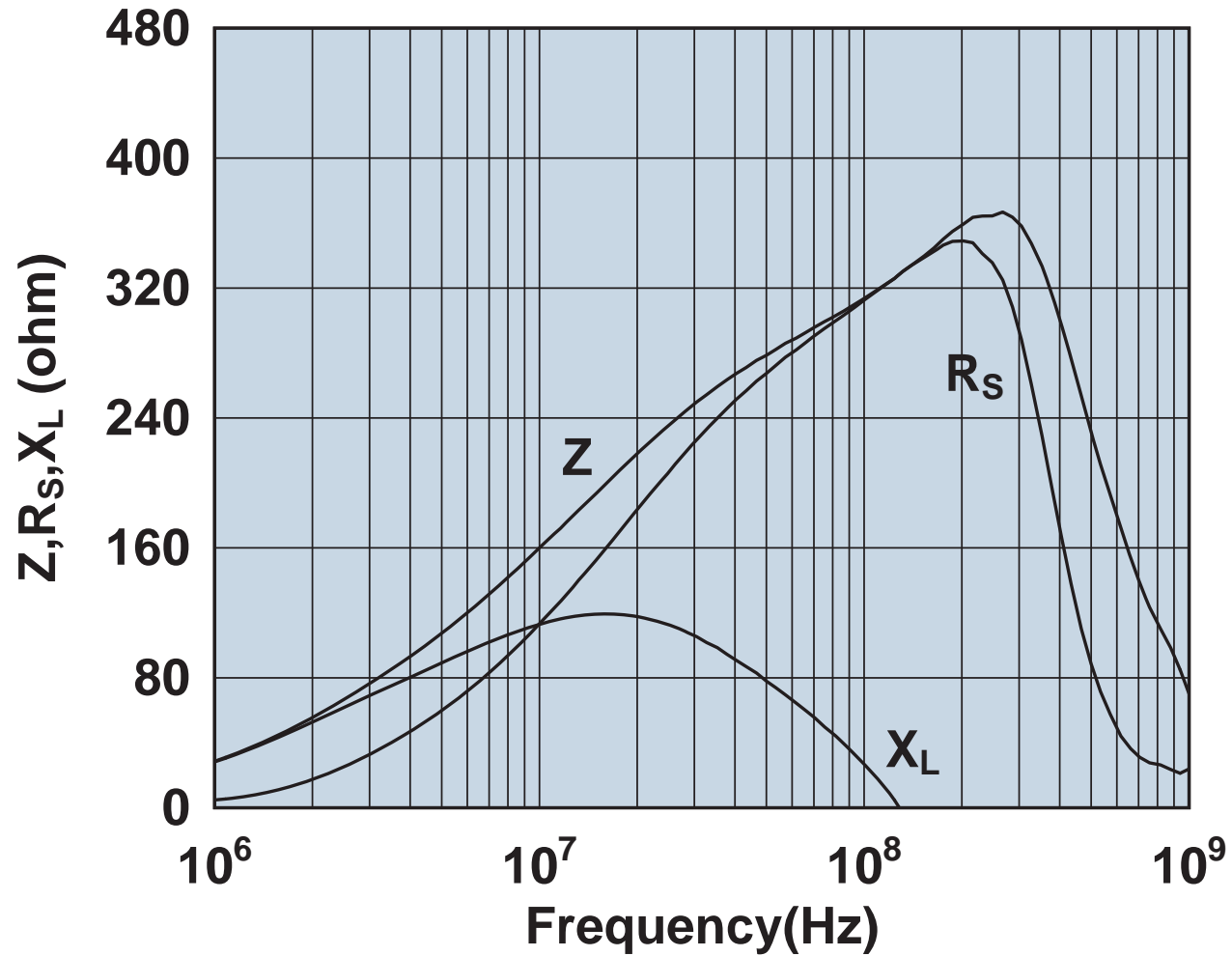

Impedance, reactance, and resistance vs. frequency.

2643665702

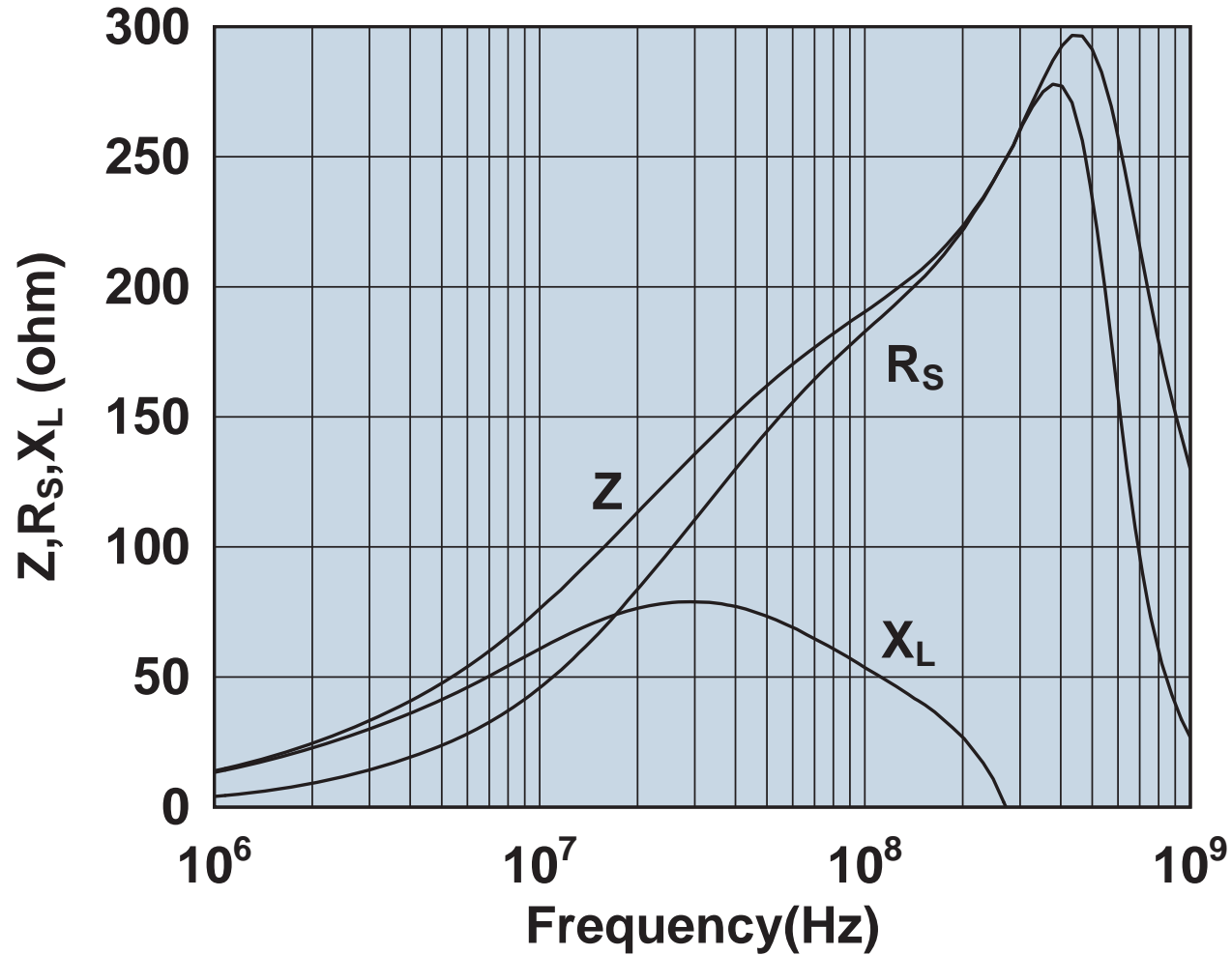

Impedance, reactance, and resistance vs. frequency.

2643665802

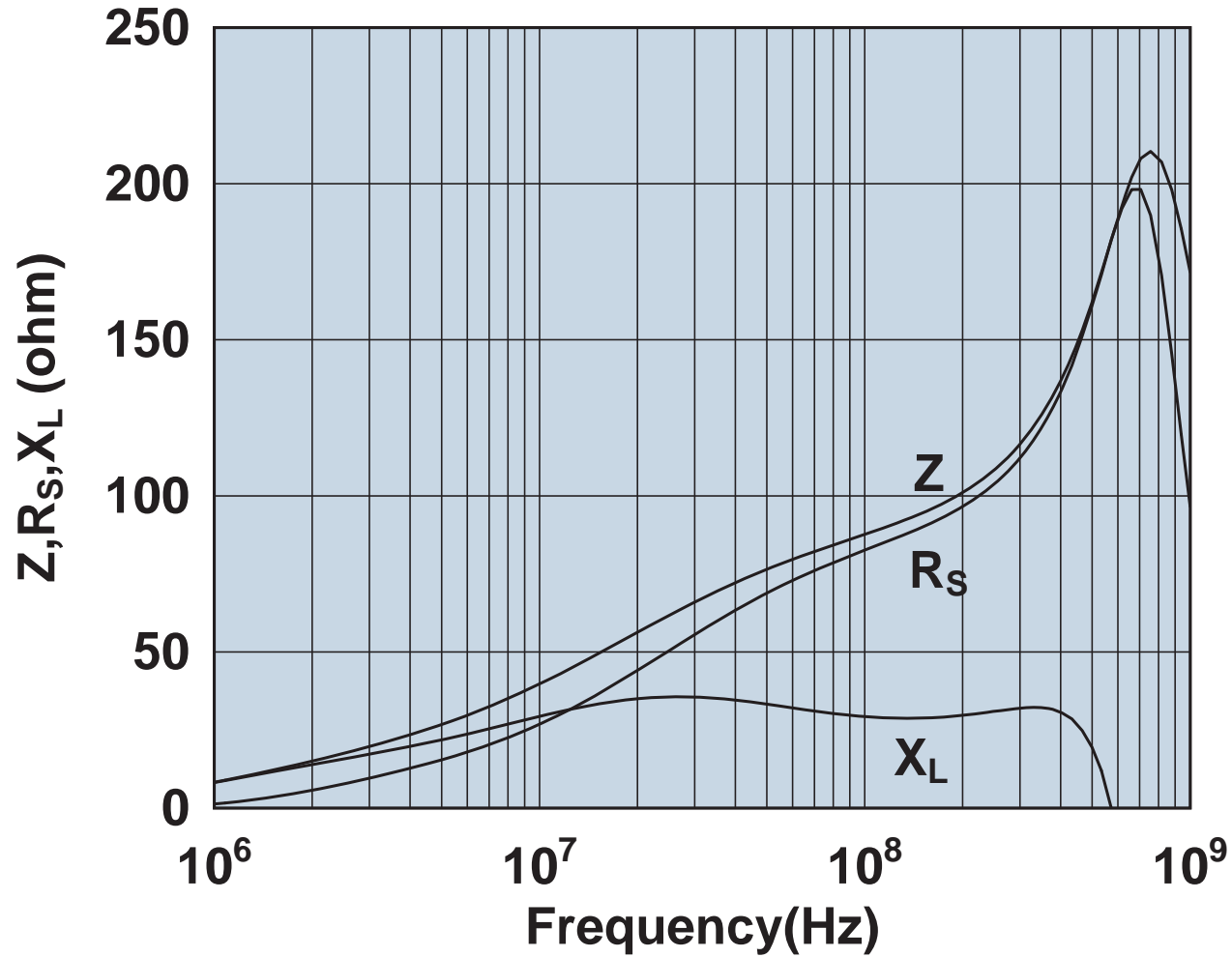

Impedance, reactance, and resistance vs. frequency.

2643665806

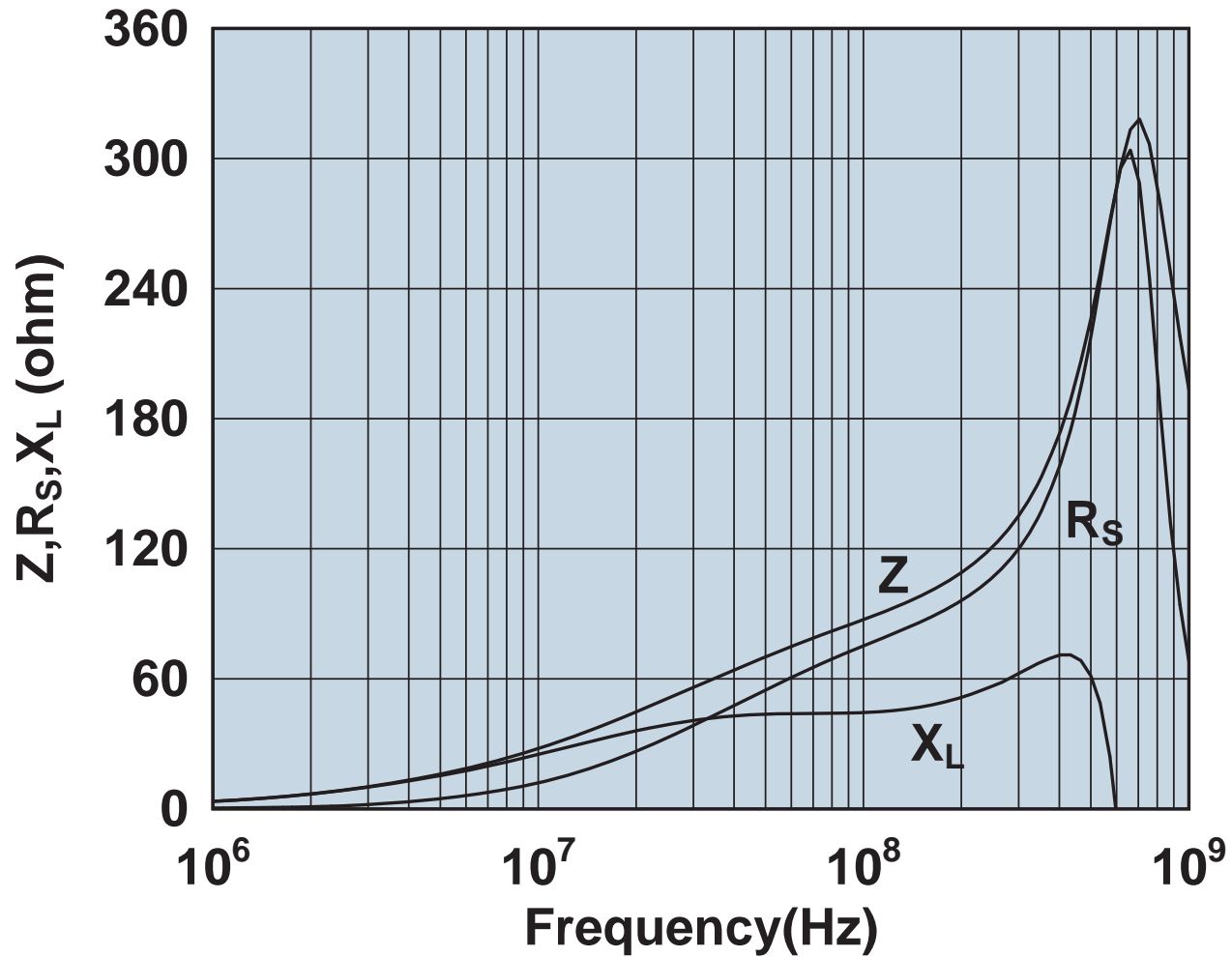

Impedance, reactance, and resistance vs. frequency.

2643665902

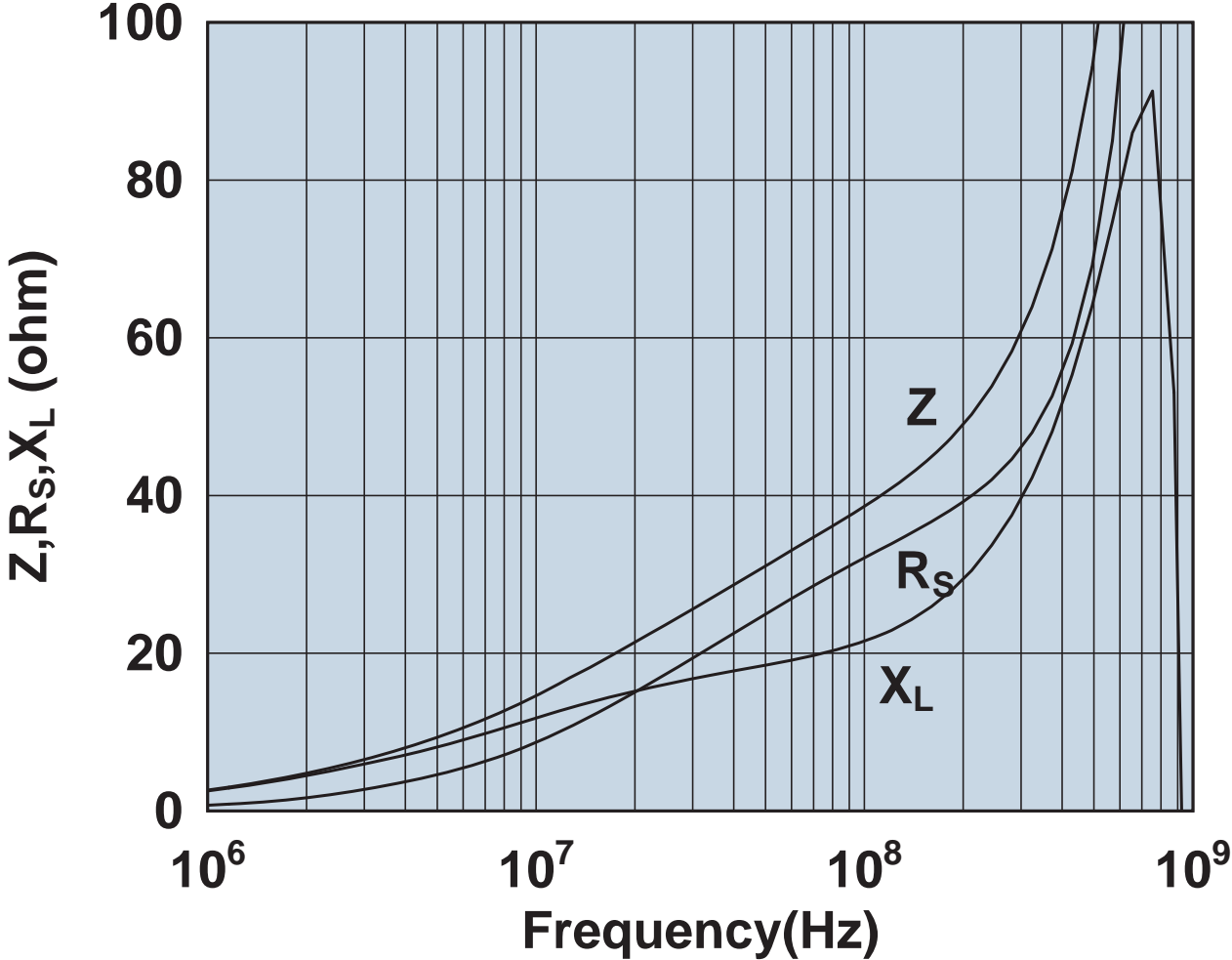

Impedance, reactance, and resistance vs. frequency.

2643800302

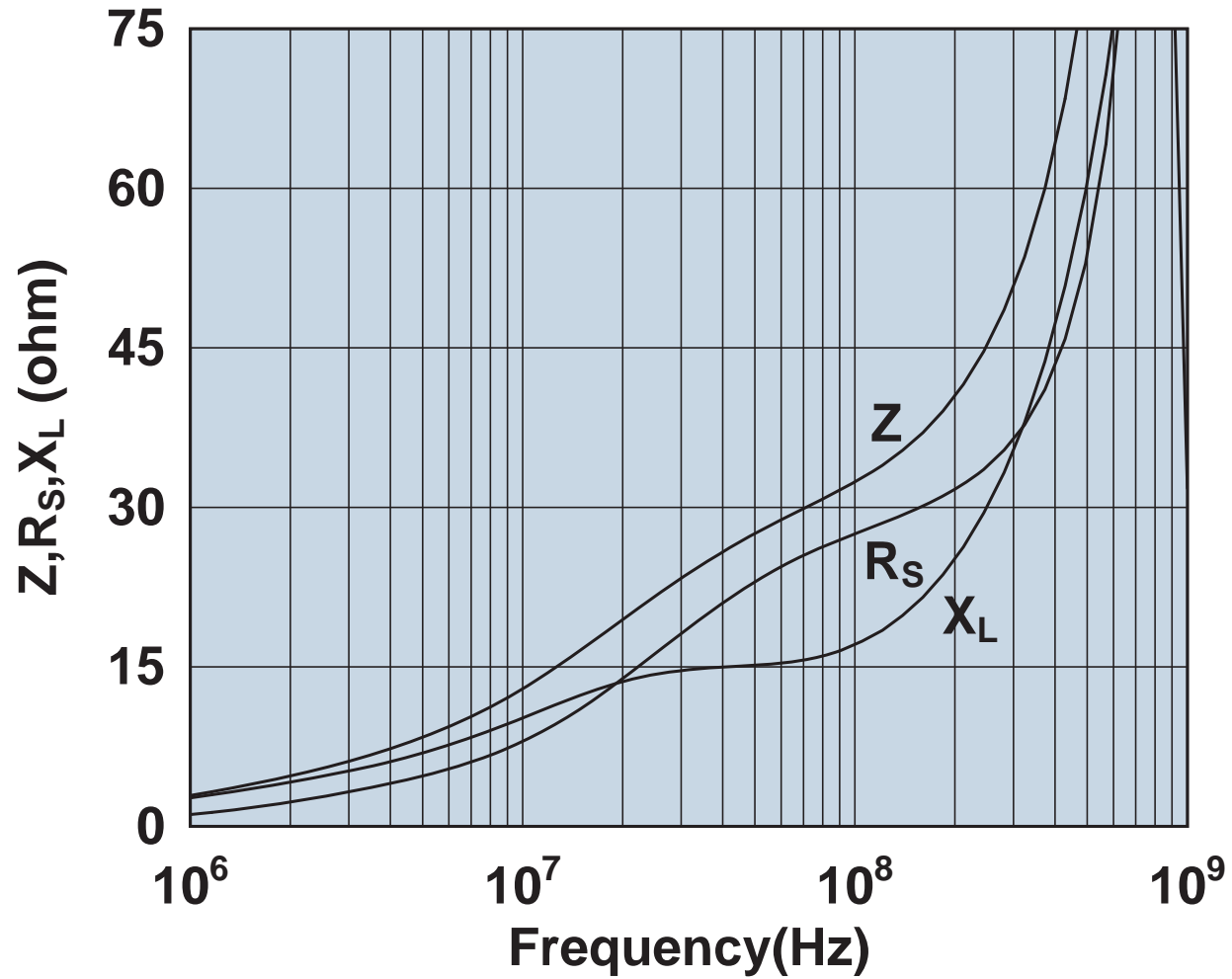

Impedance, reactance, and resistance vs. frequency.

2643800502

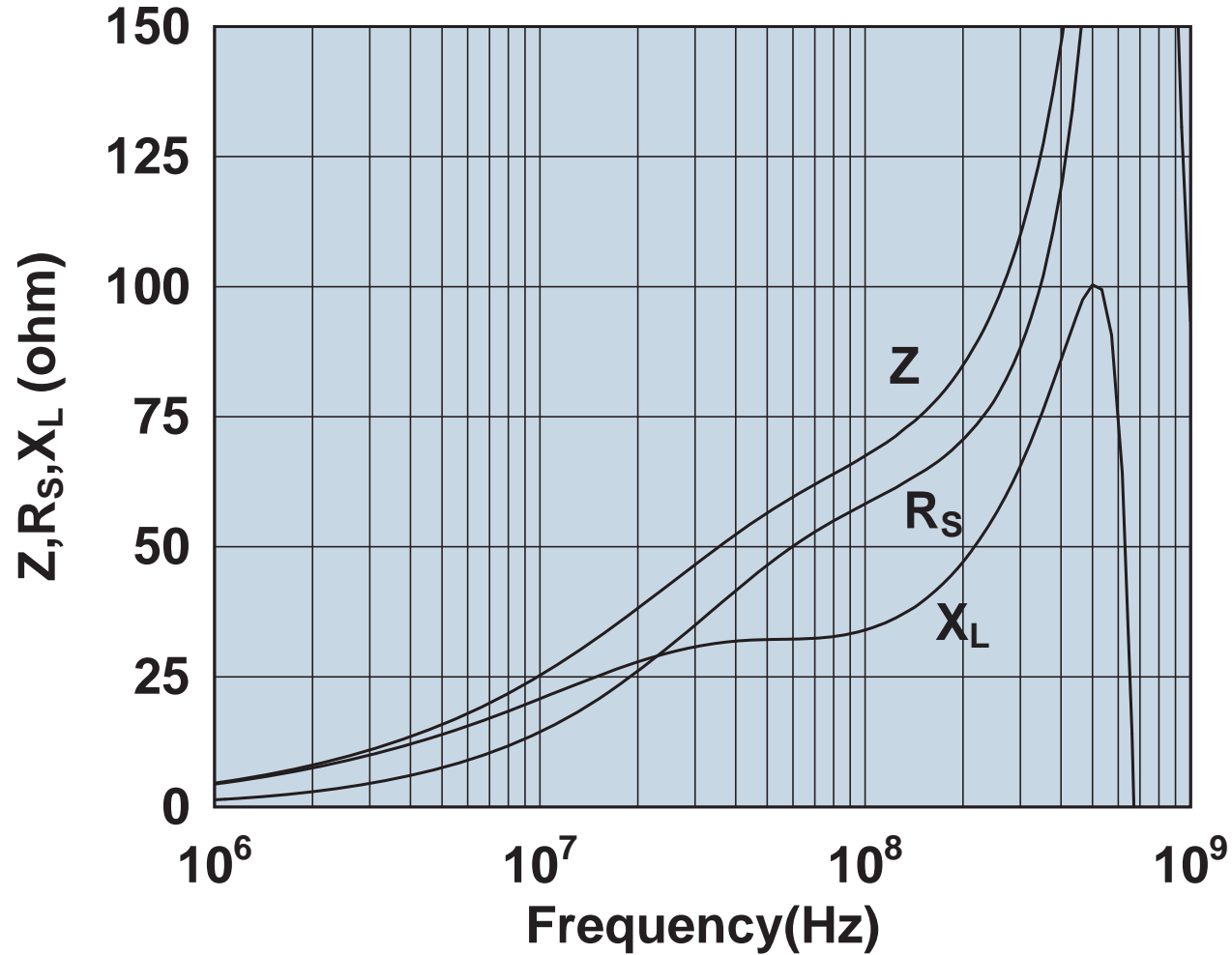

Impedance, reactance, and resistance vs. frequency.

2643800506



Impedance, reactance, and resistance vs. frequency.

2643800602

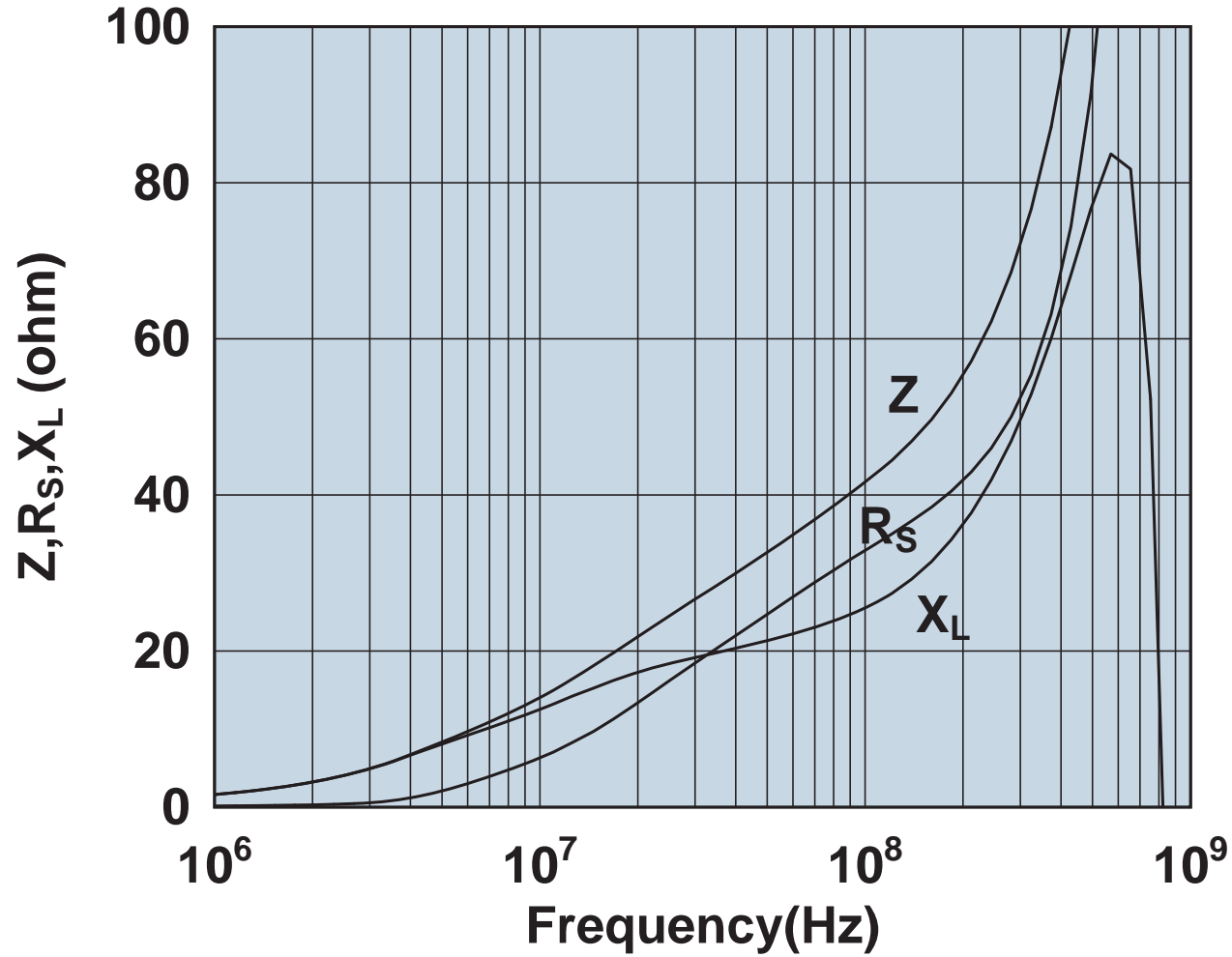

Impedance, reactance, and resistance vs. frequency.

2643801002

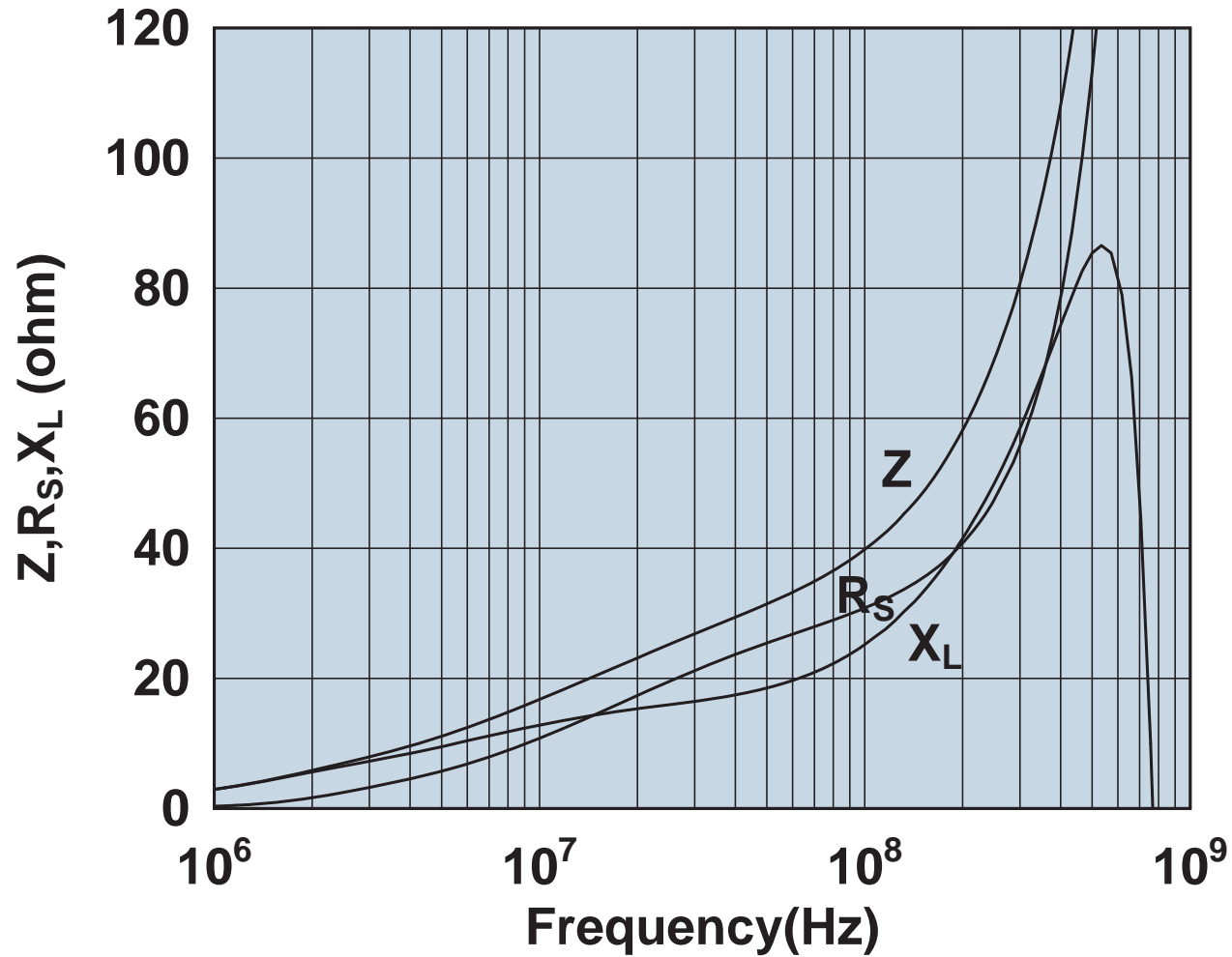

Impedance, reactance, and resistance vs. frequency.

2643801102

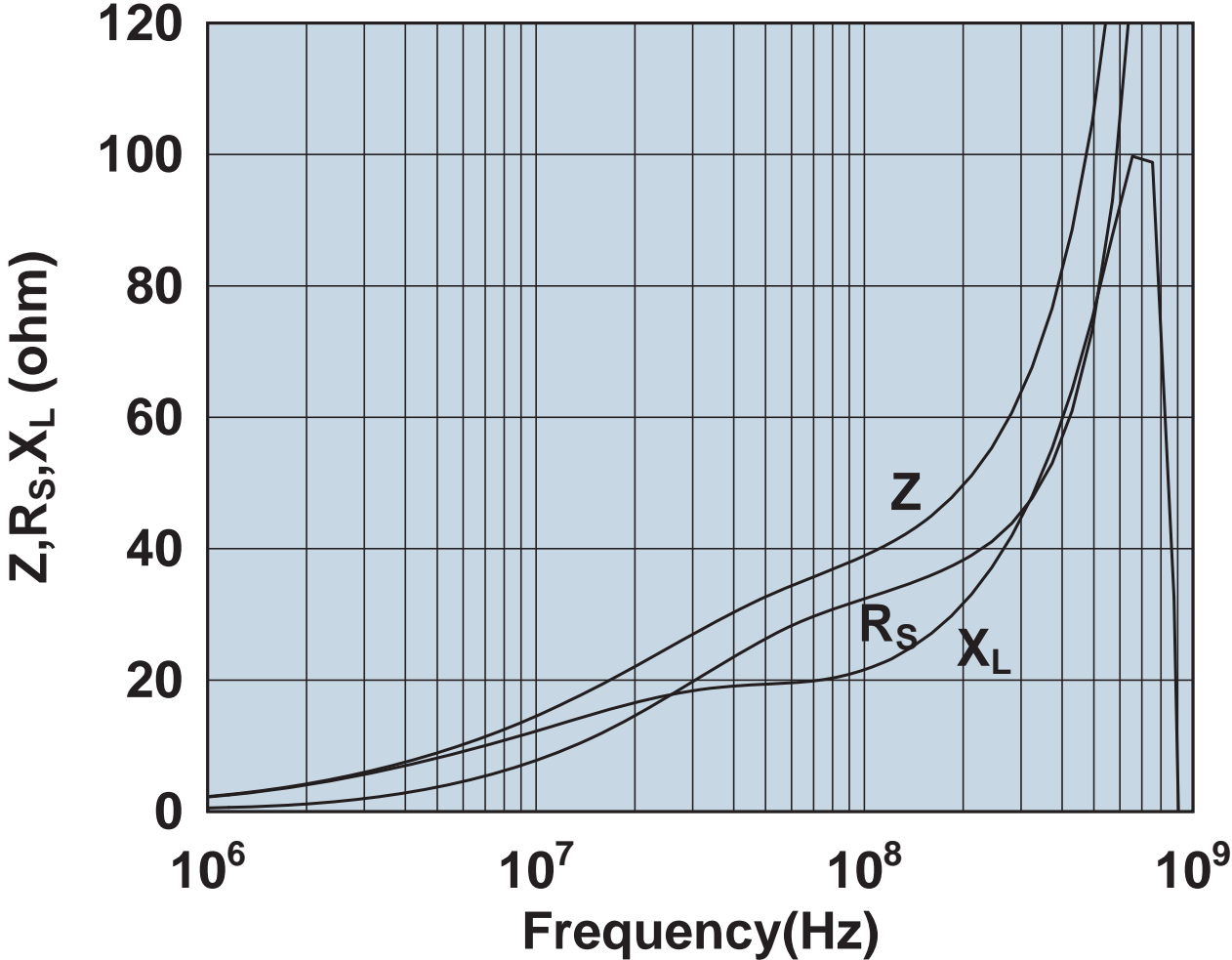

Impedance, reactance, and resistance vs. frequency.

2643801202

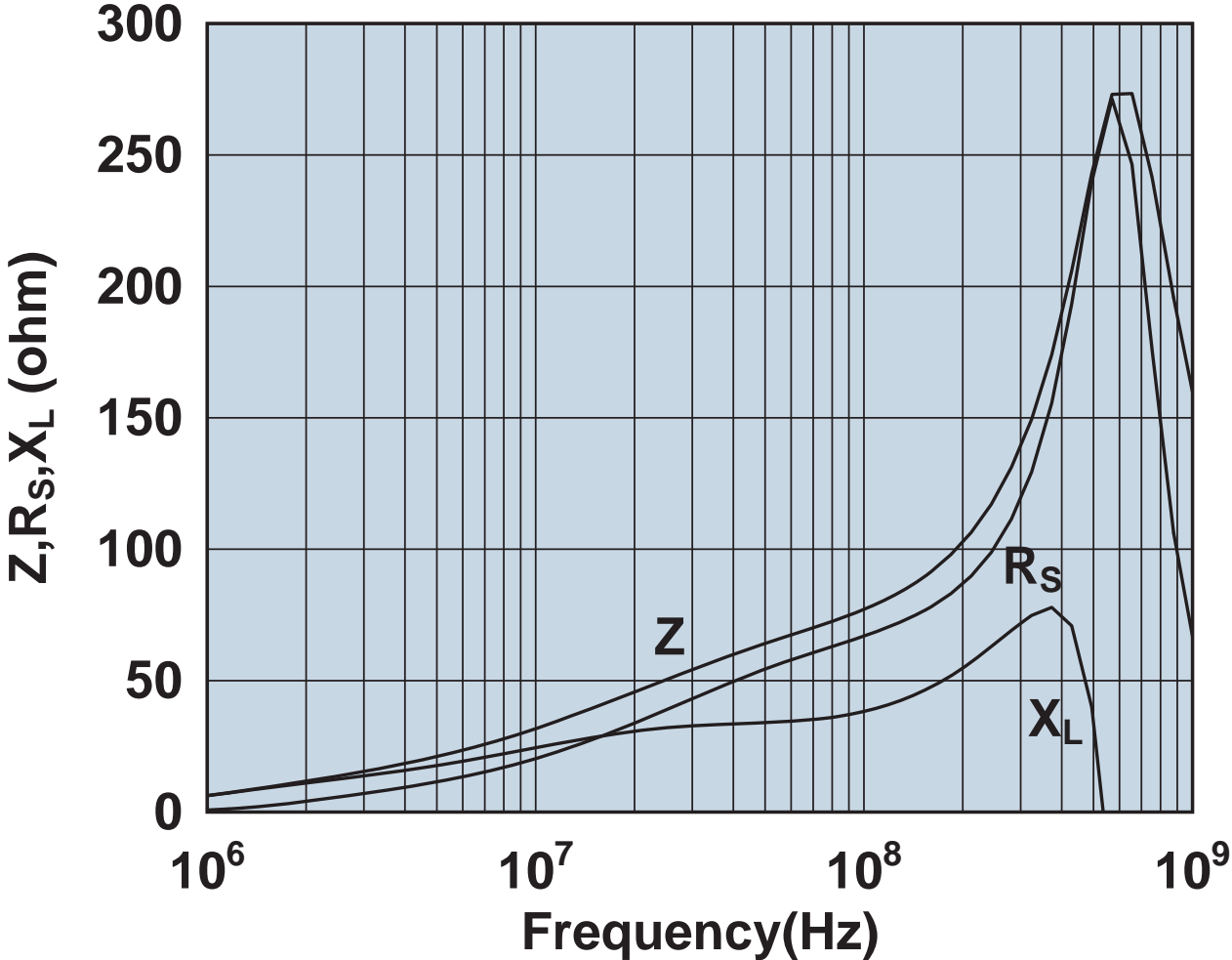

Impedance, reactance, and resistance vs. frequency.

2643801402

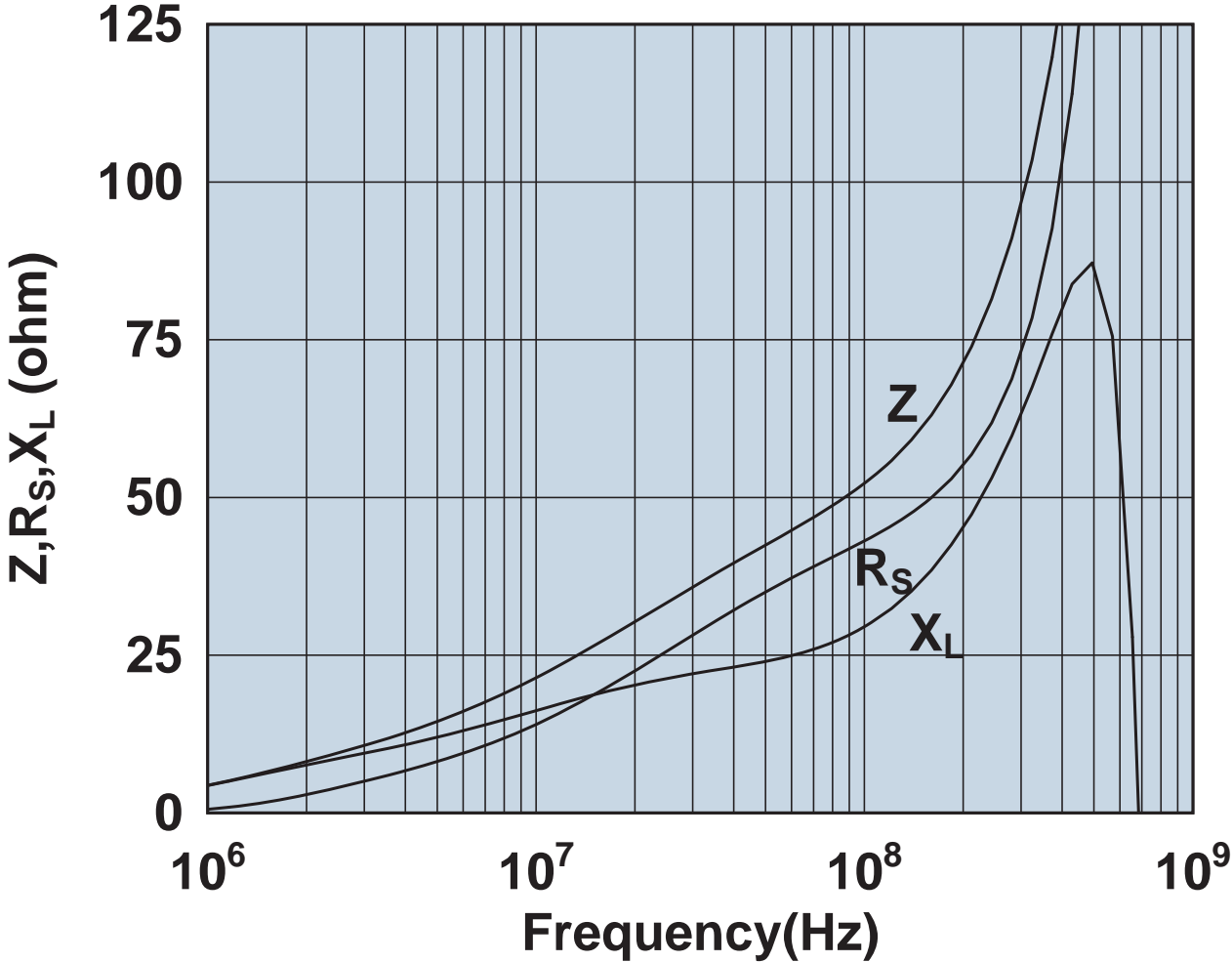

Impedance, reactance, and resistance vs. frequency.

2643801502

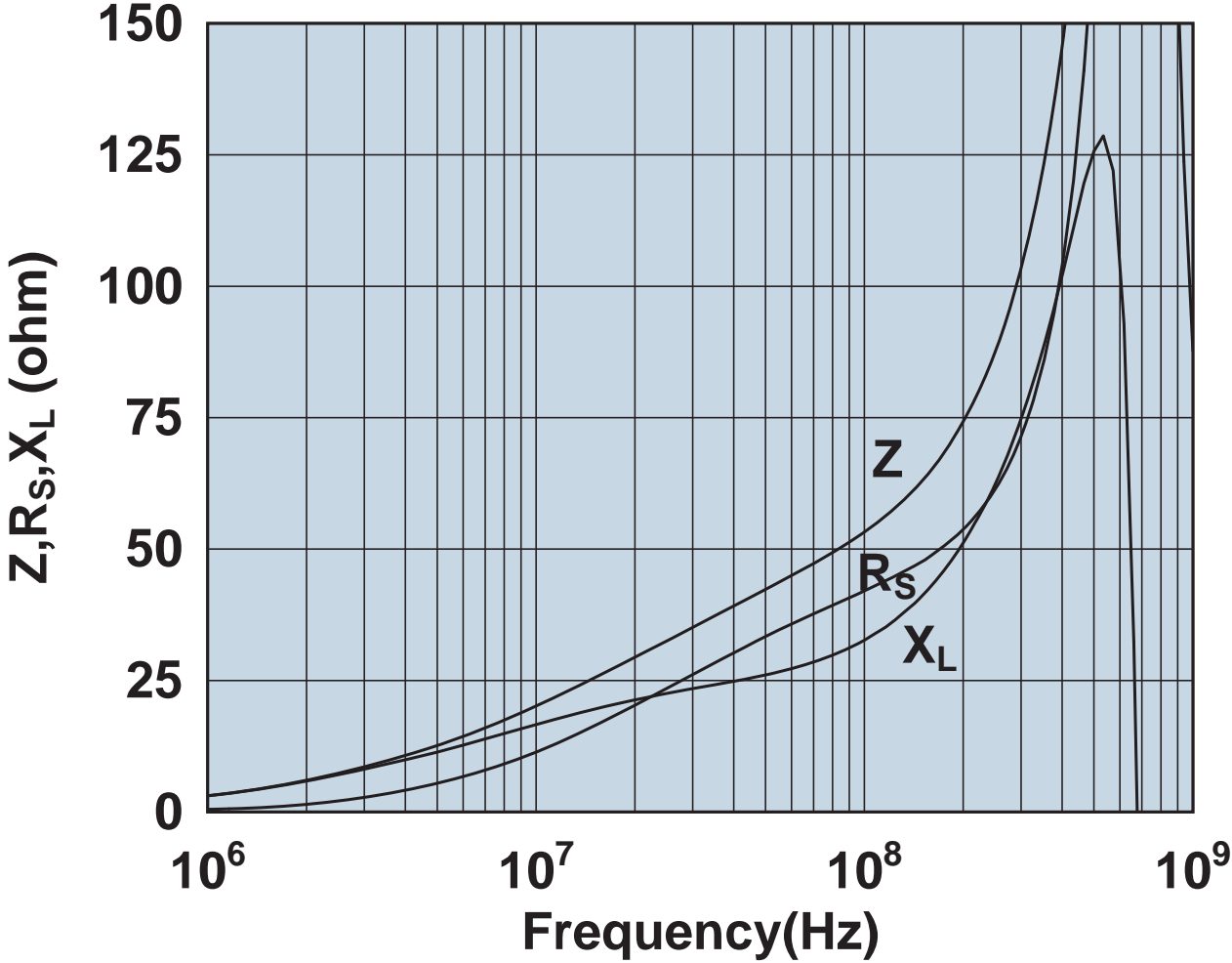

Impedance, reactance, and resistance vs. frequency.

2643801802

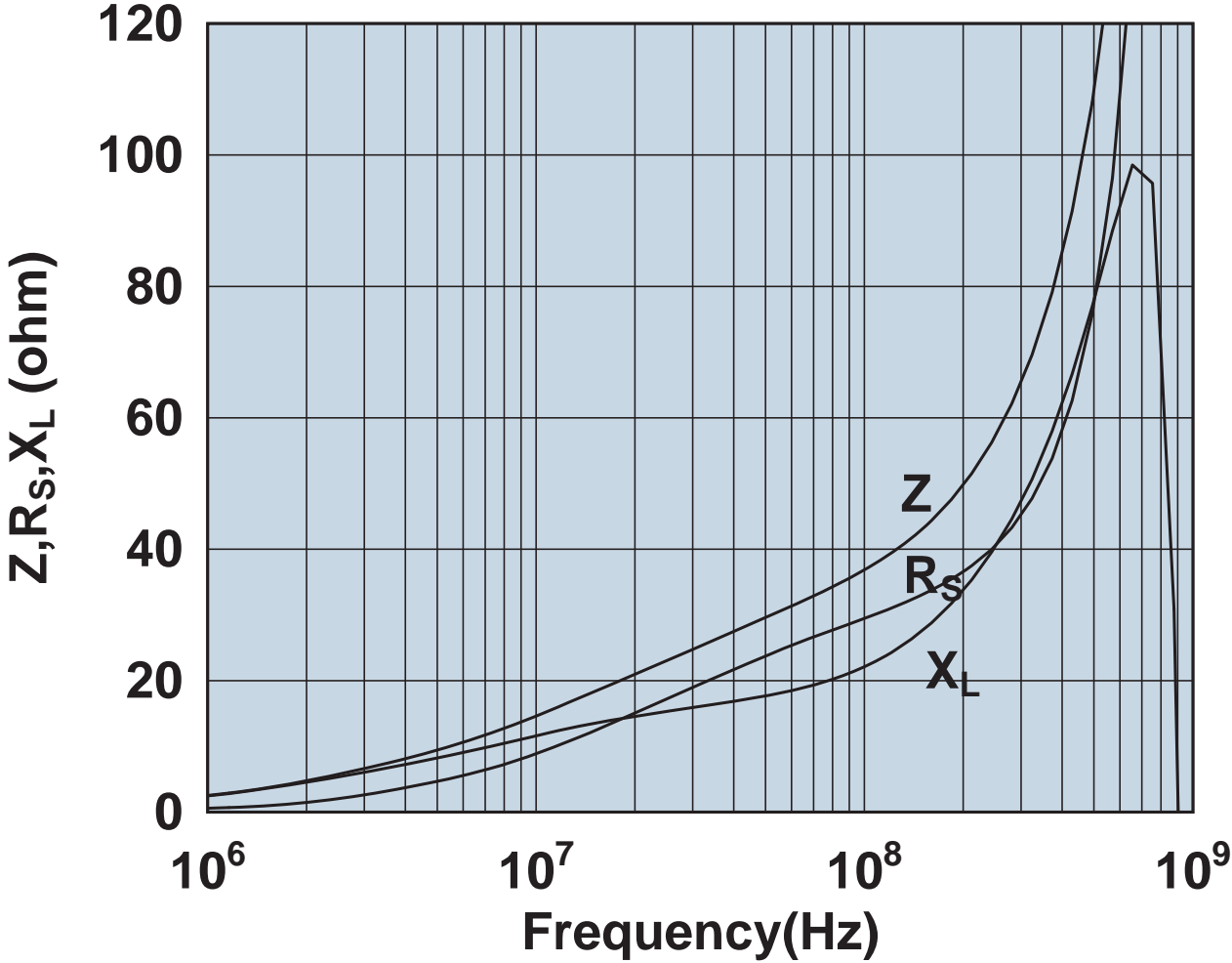

Impedance, reactance, and resistance vs. frequency.

2643801902

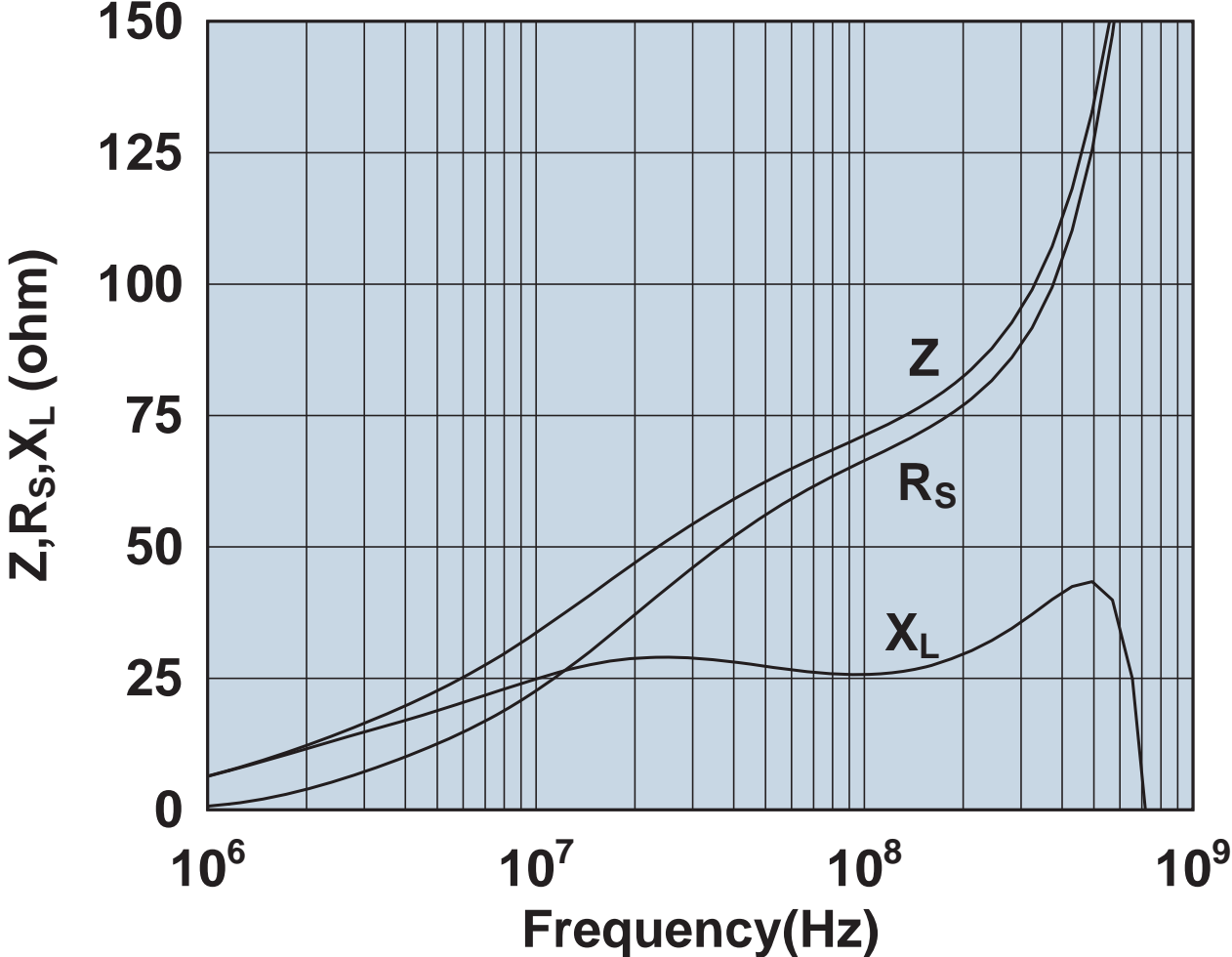

Impedance, reactance, and resistance vs. frequency.

2643802702

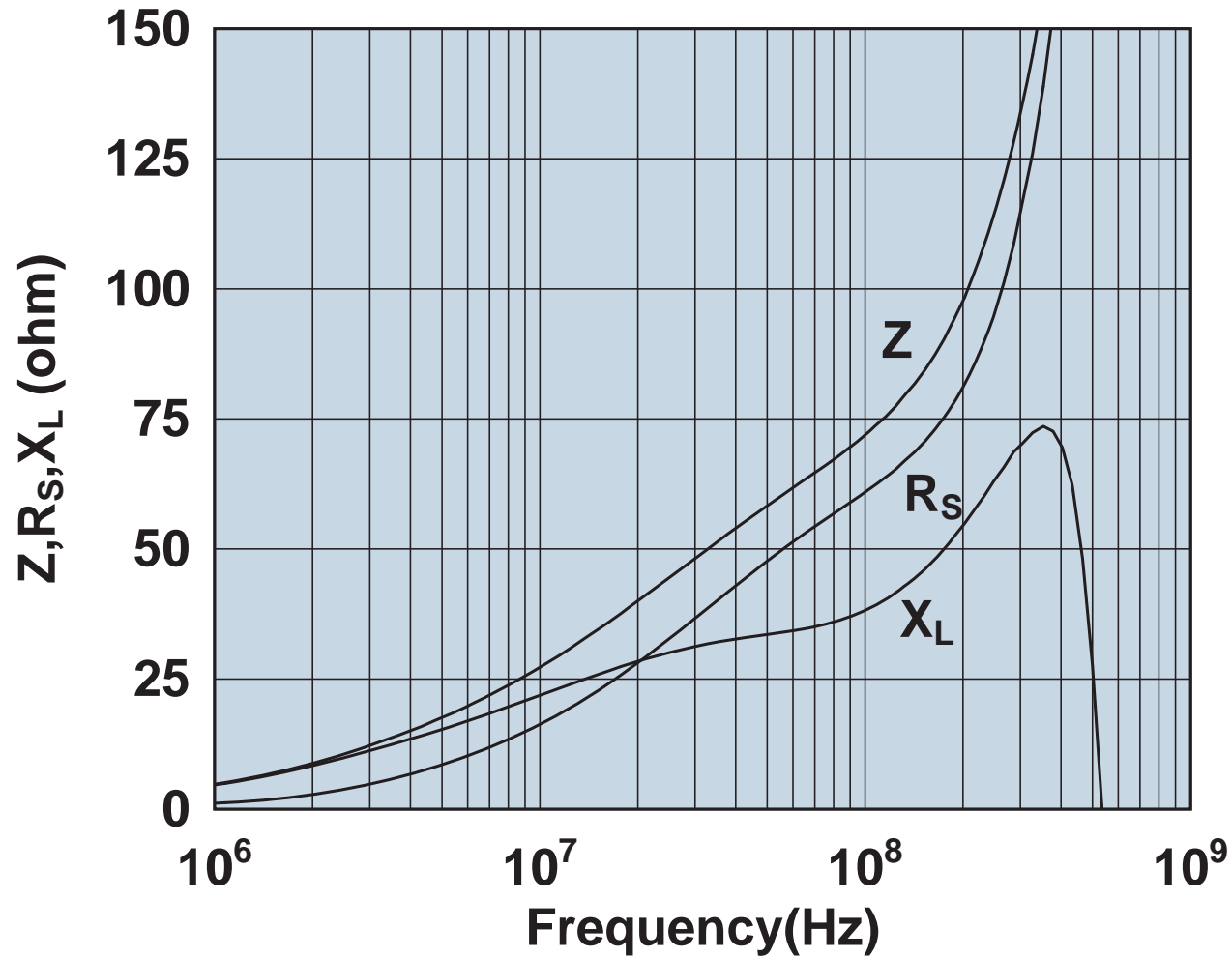

Impedance, reactance, and resistance vs. frequency.

2643803802

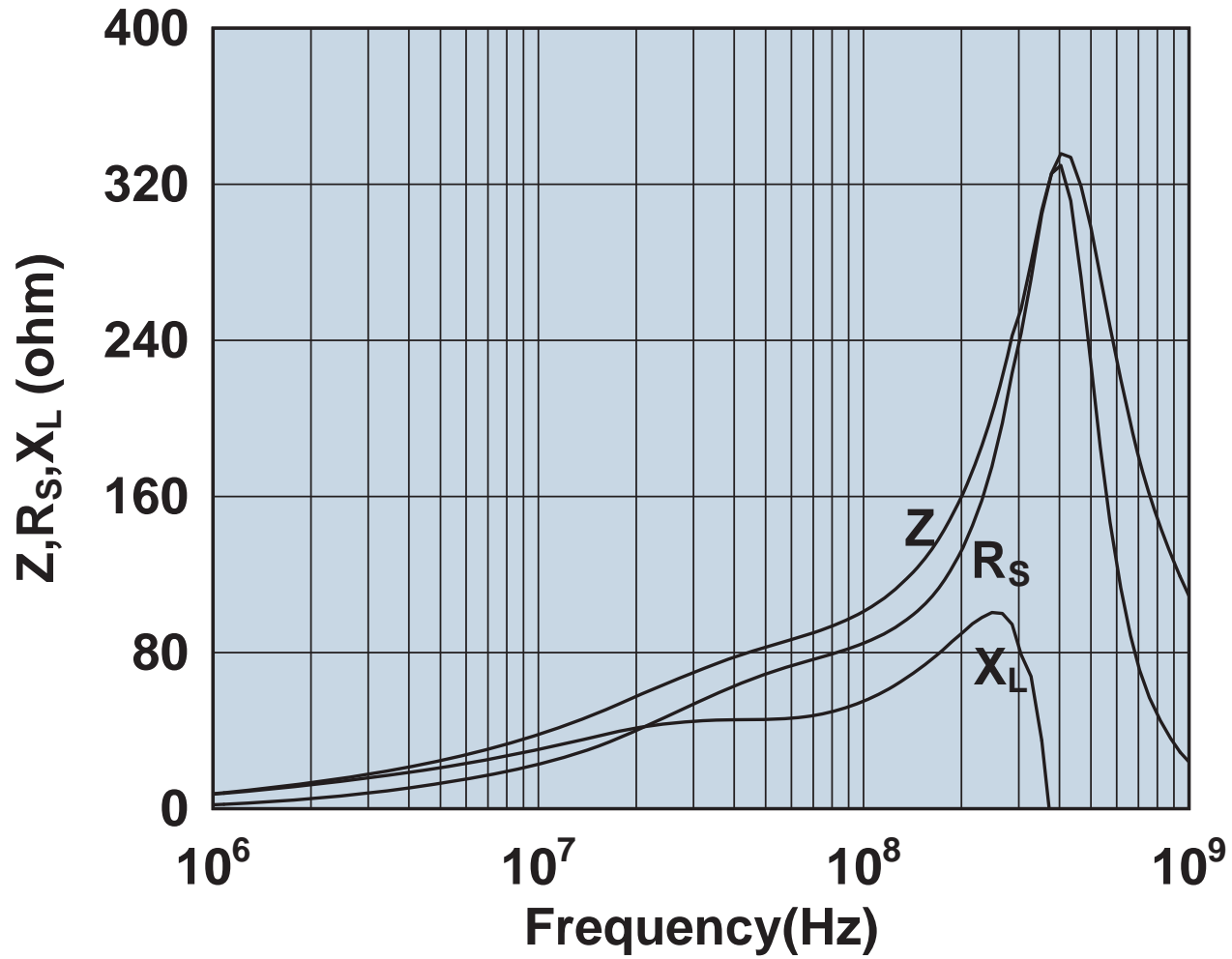

Impedance, reactance, and resistance vs. frequency.

2643804502

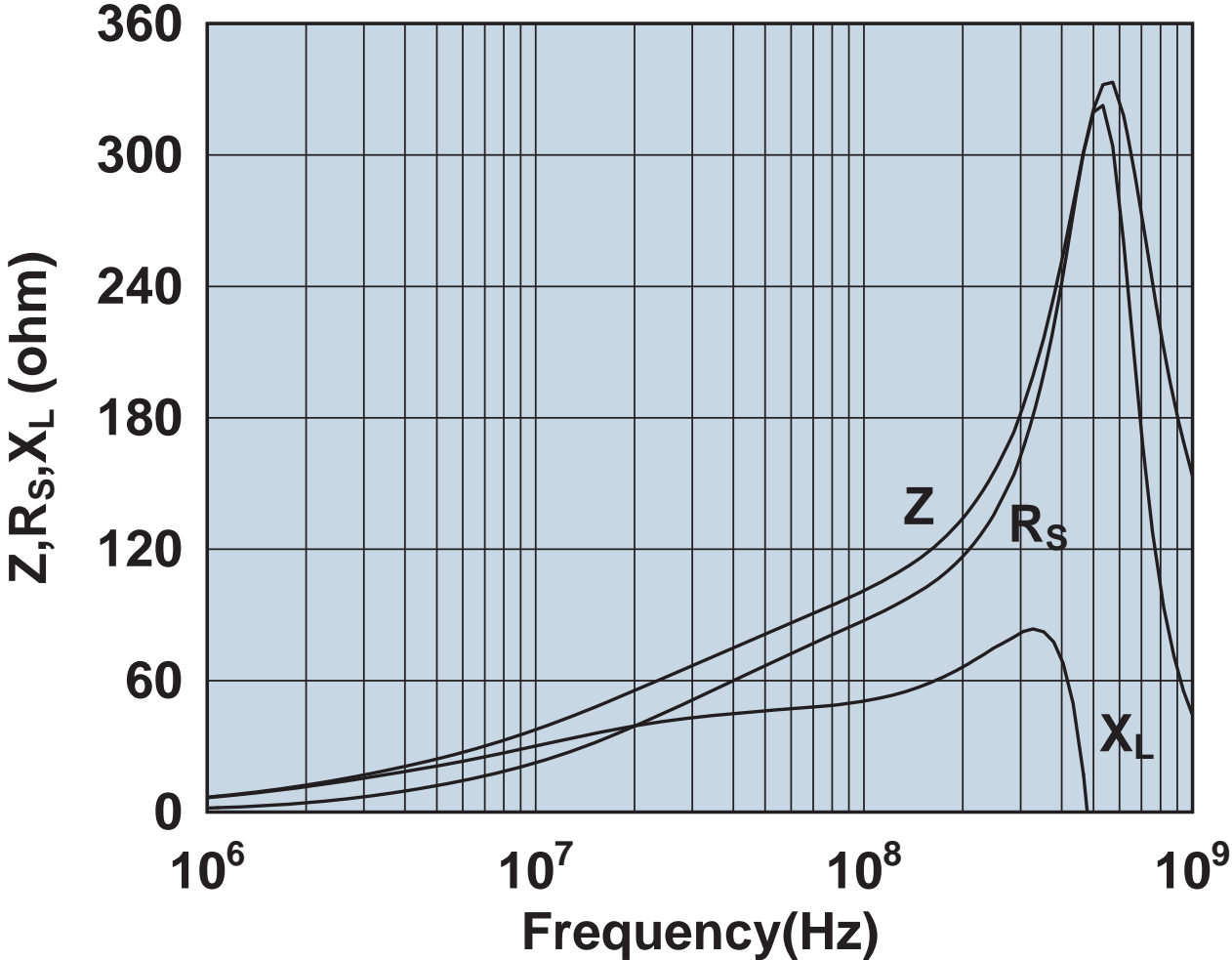

Impedance, reactance, and resistance vs. frequency.

2643806402

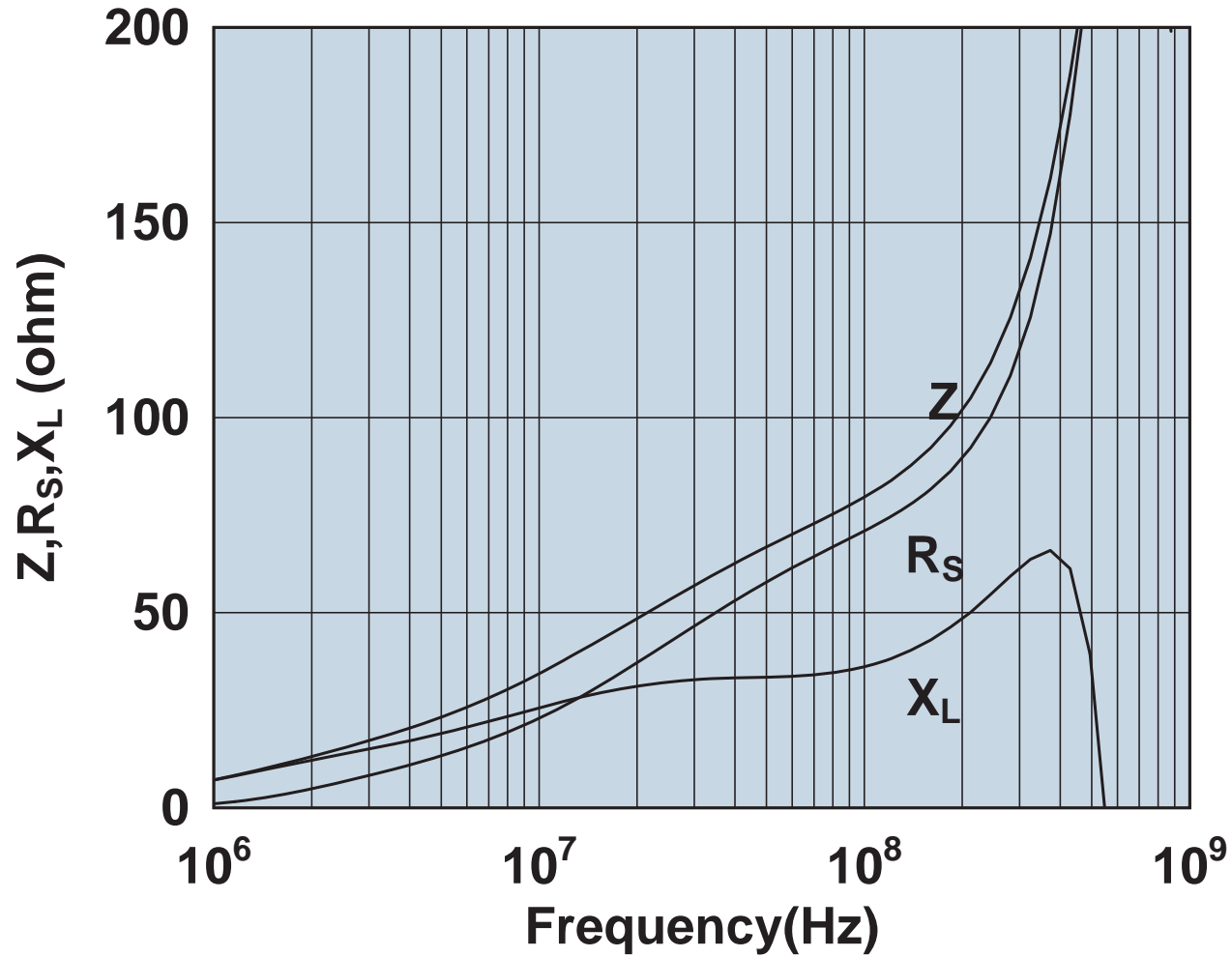

Impedance, reactance, and resistance vs. frequency.

2643806406

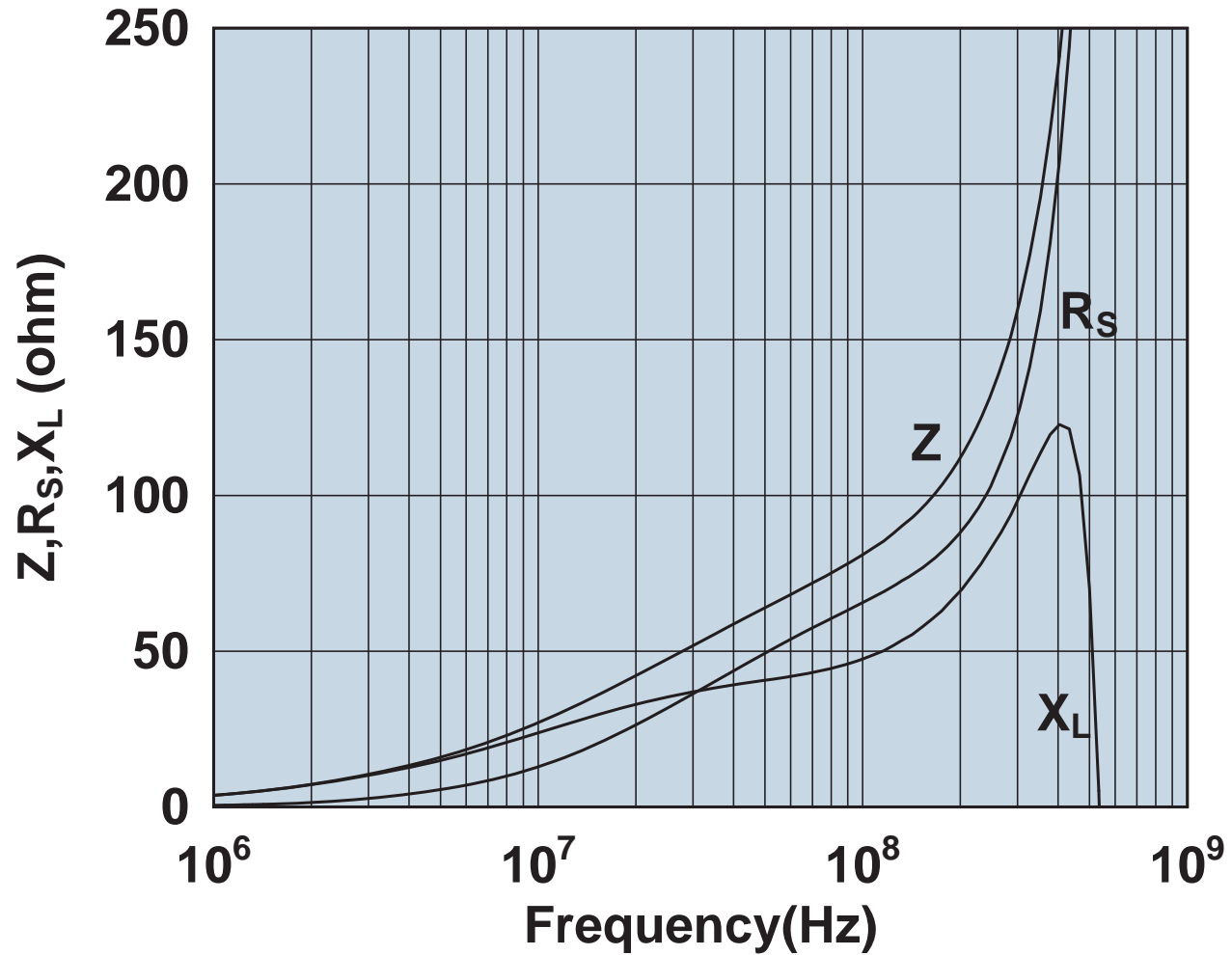

Impedance, reactance, and resistance vs. frequency.

2644164181

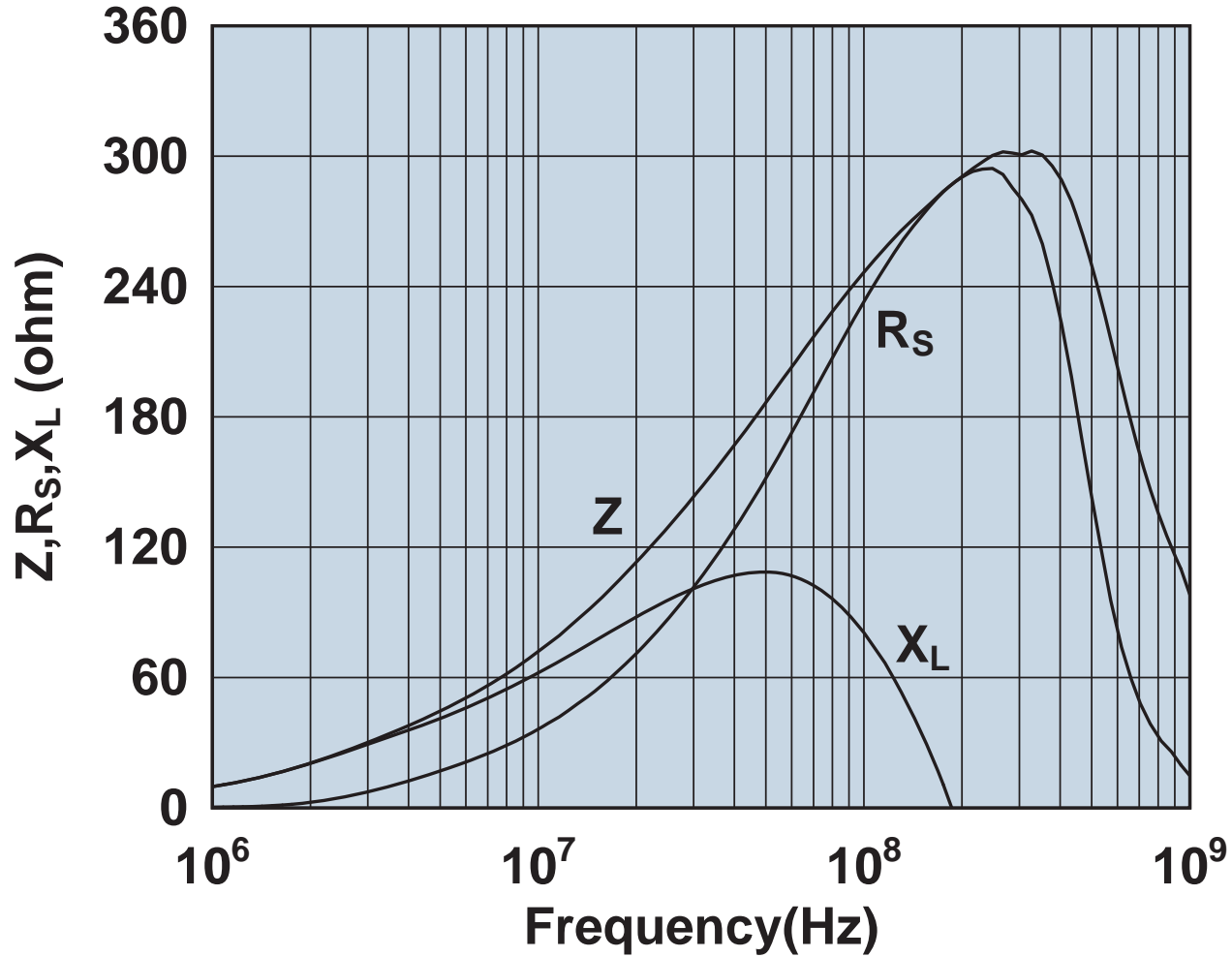

Impedance, reactance, and resistance vs. frequency.

2644164281

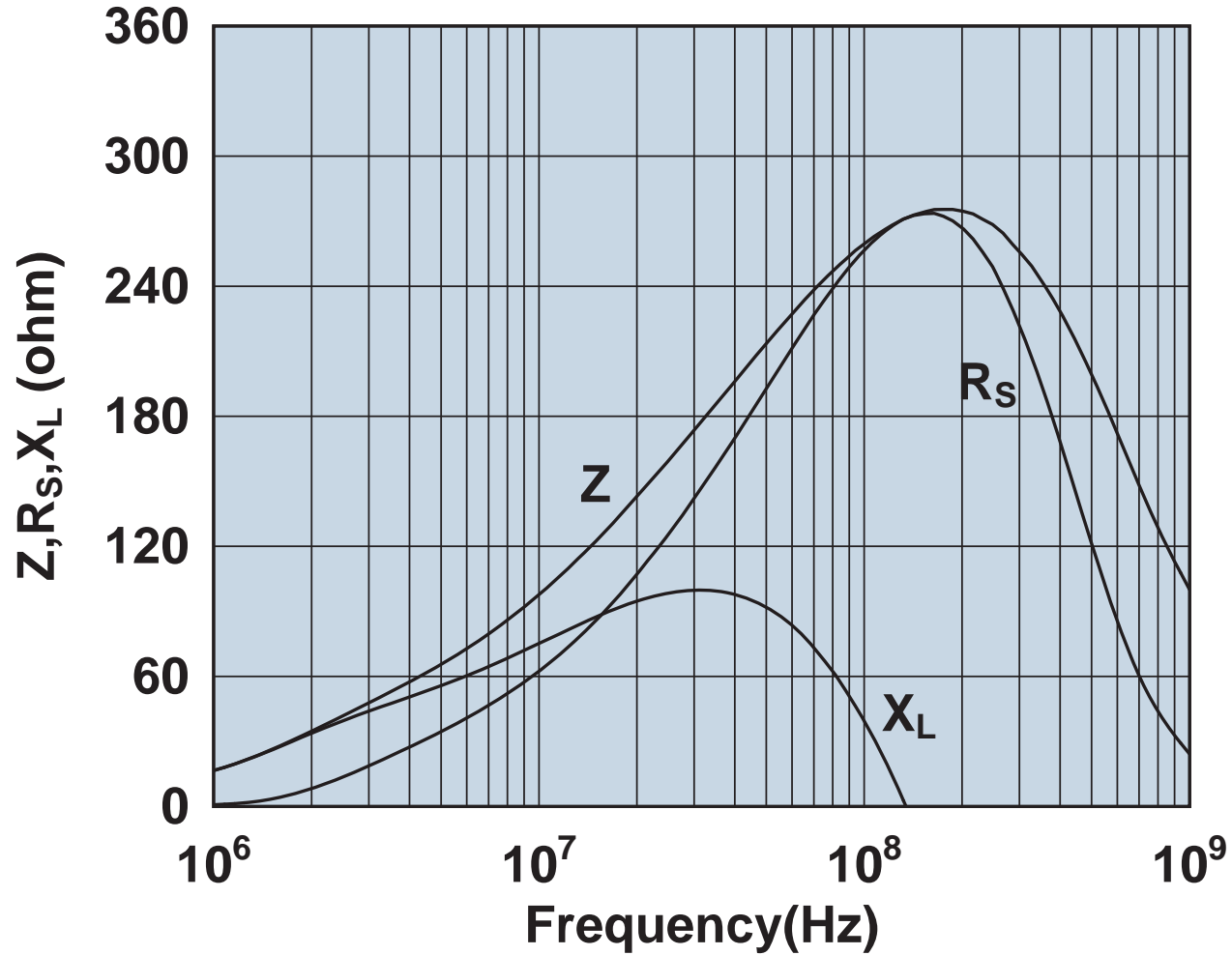

Impedance, reactance, and resistance vs. frequency.

2644164951

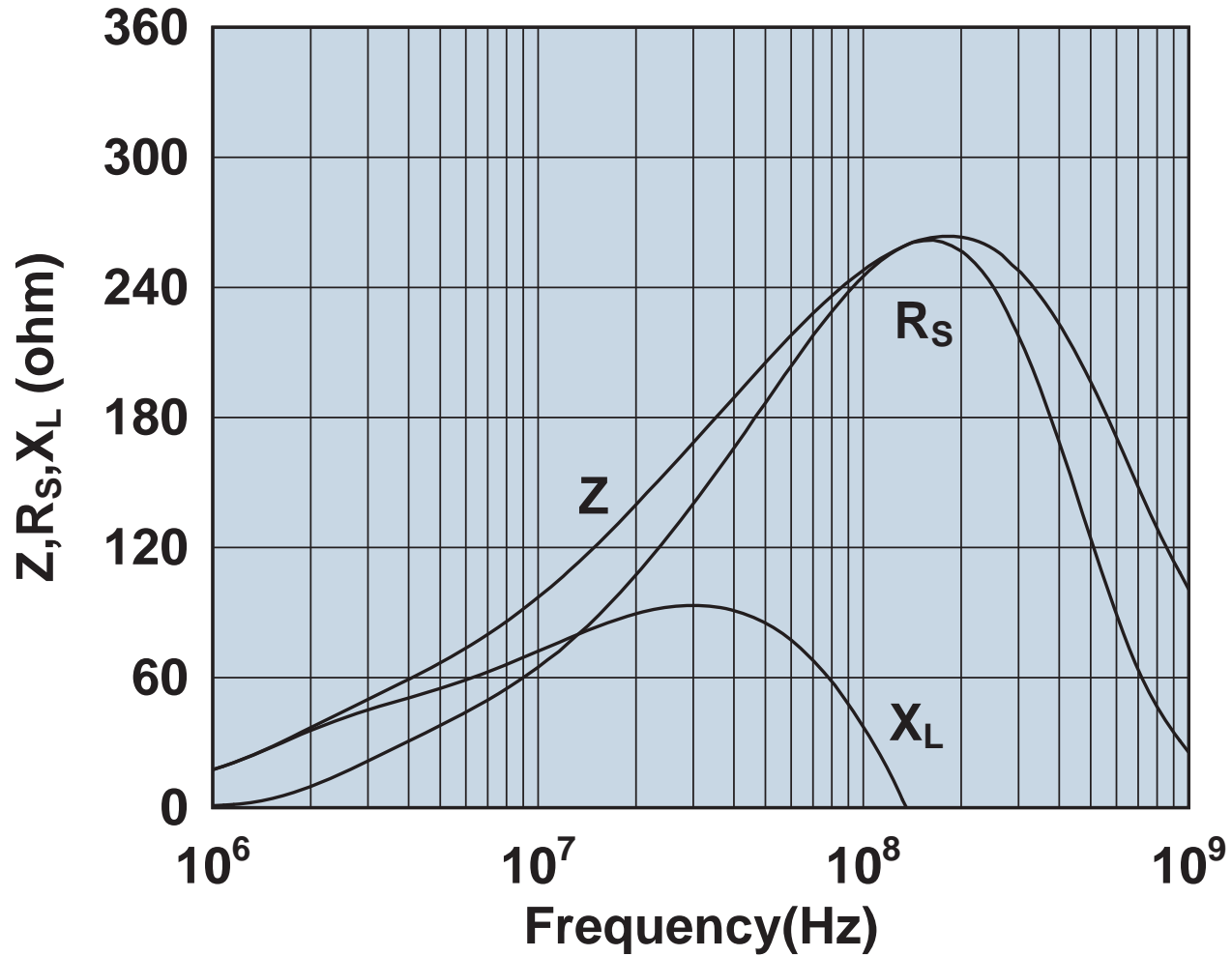

Impedance, reactance, and resistance vs. frequency.

2644167281

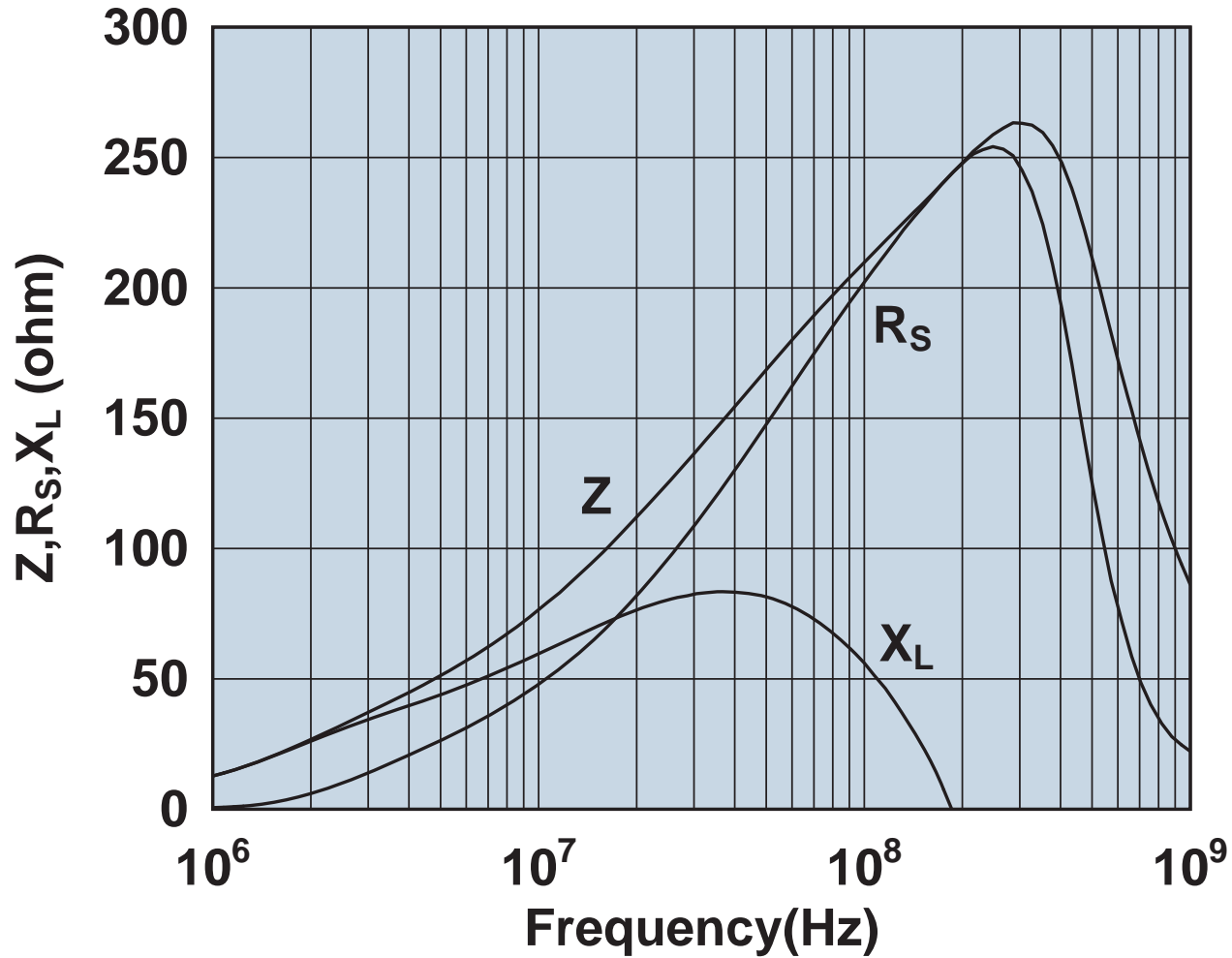

Impedance, reactance, and resistance vs. frequency.

2644173551

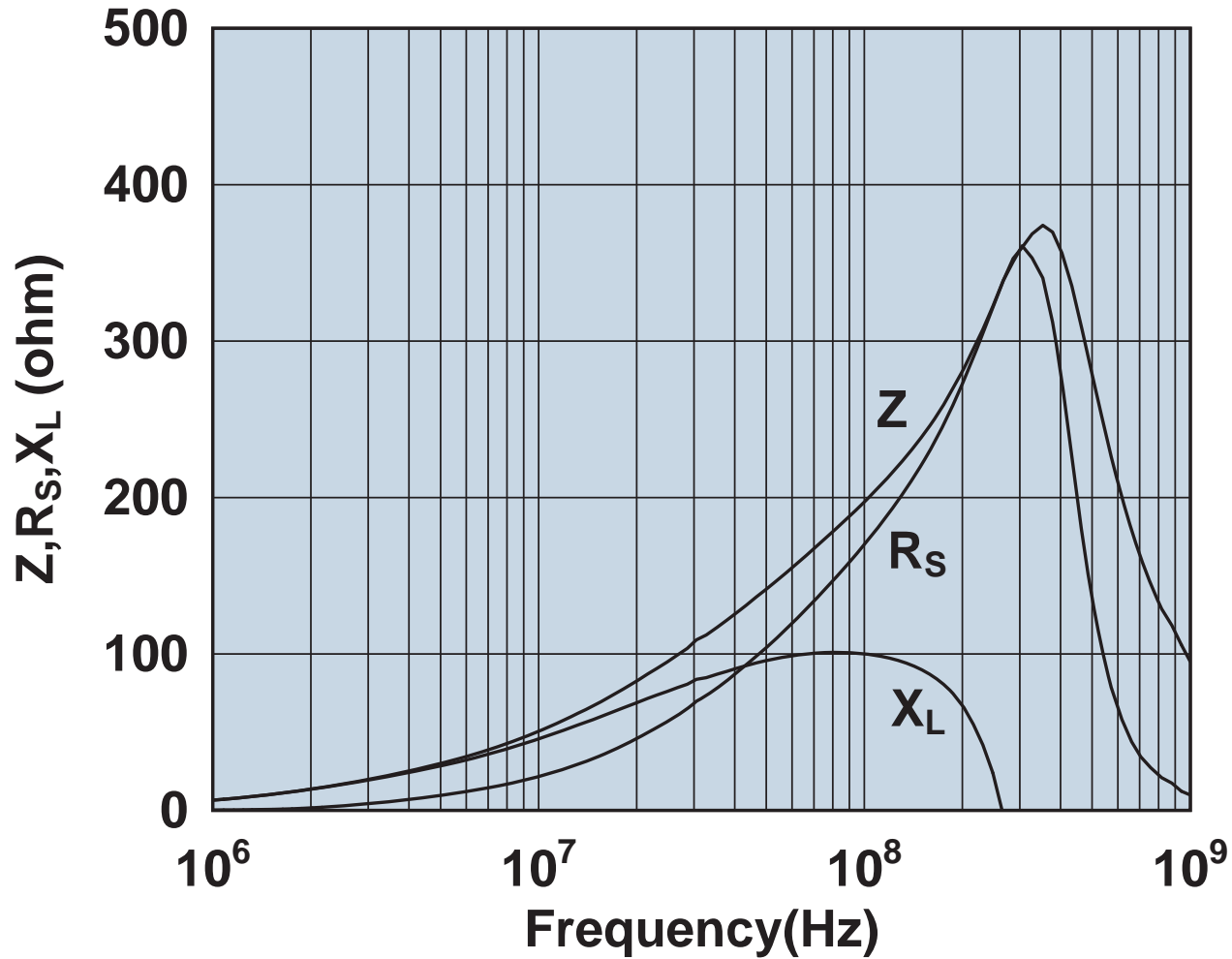

Impedance, reactance, and resistance vs. frequency.

2644173951

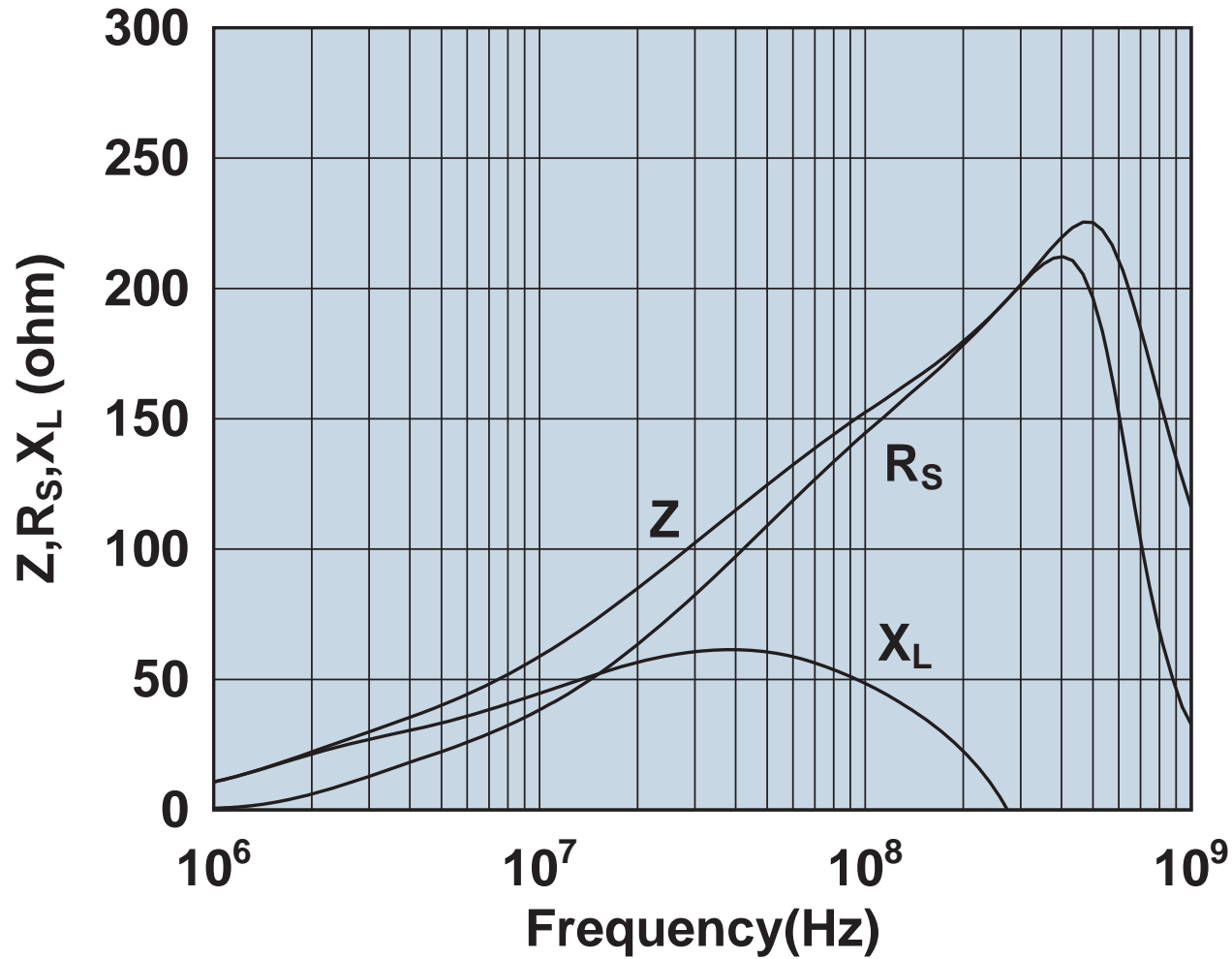

Impedance, reactance, and resistance vs. frequency.

2644176451

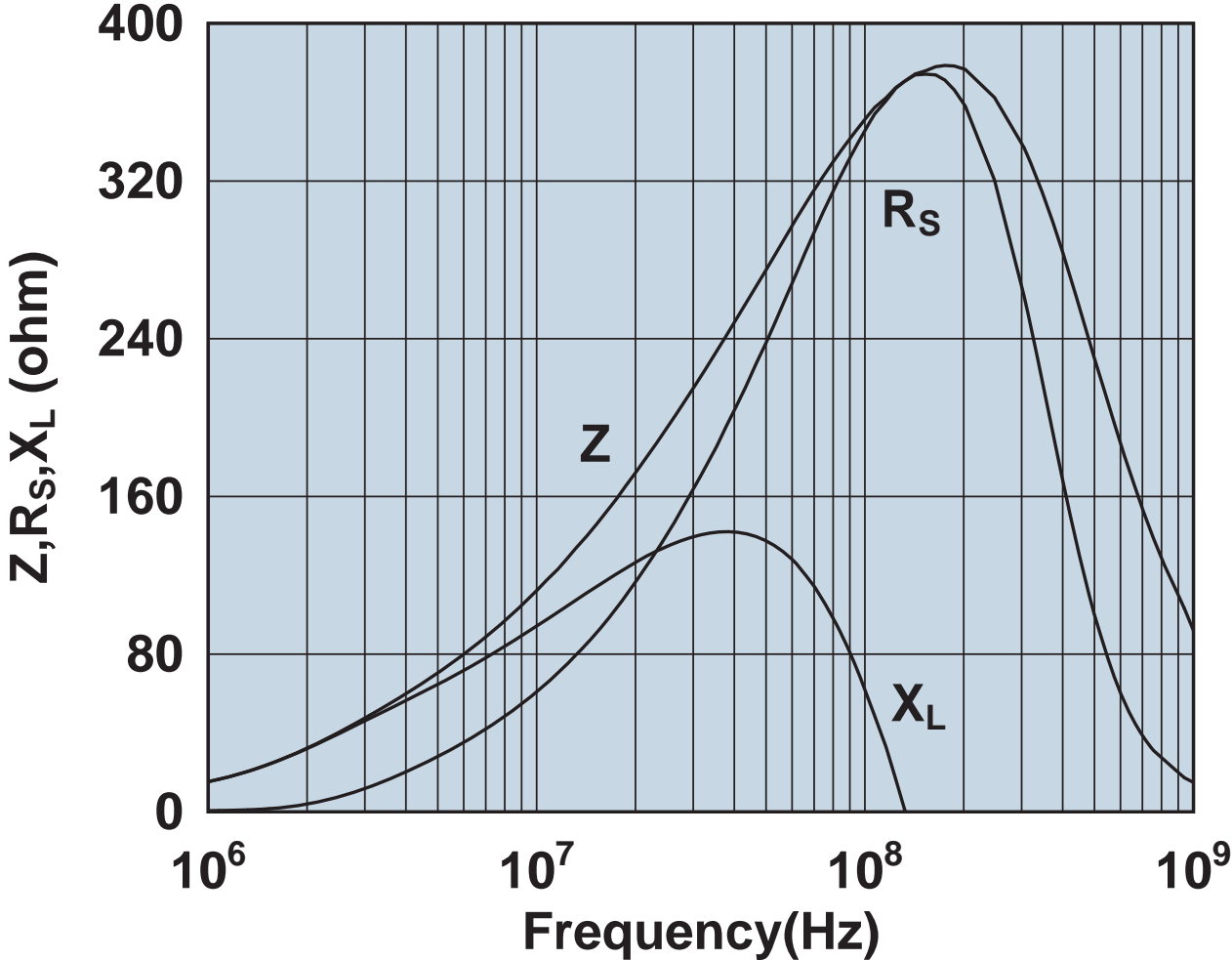

Impedance, reactance, and resistance vs. frequency.

2644177081

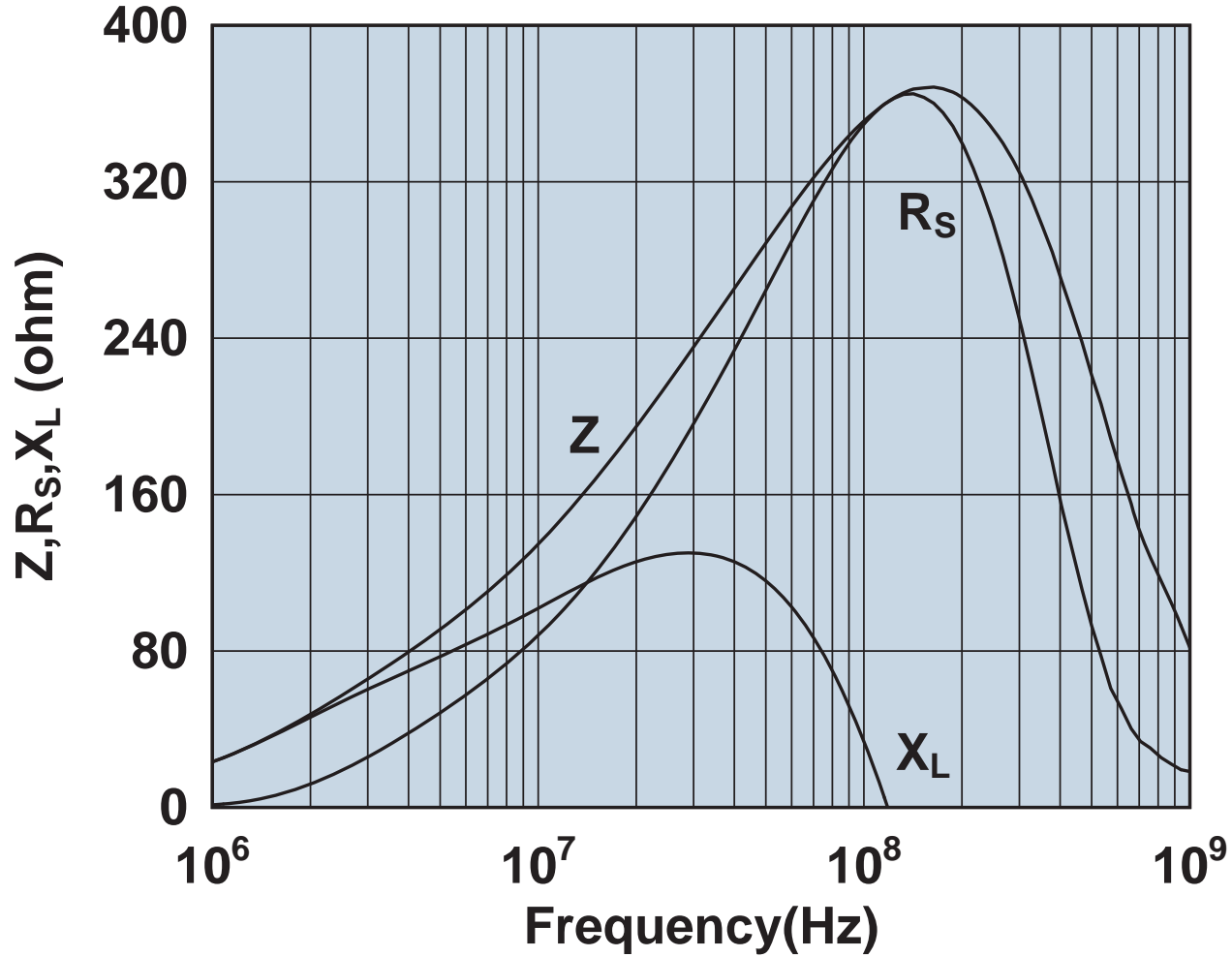

Impedance, reactance, and resistance vs. frequency.

2644236001

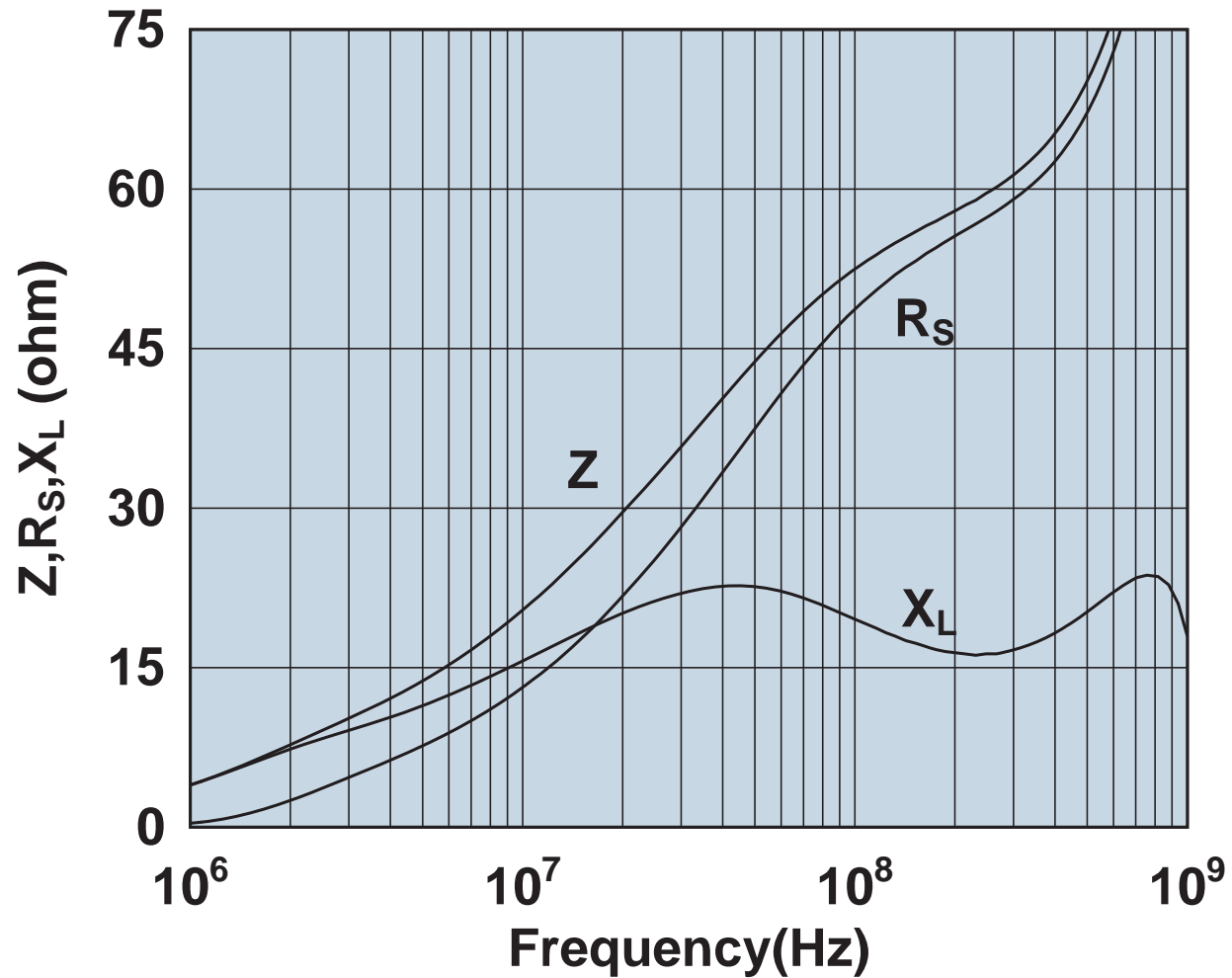

Impedance, reactance, and resistance vs. frequency.

2644236101

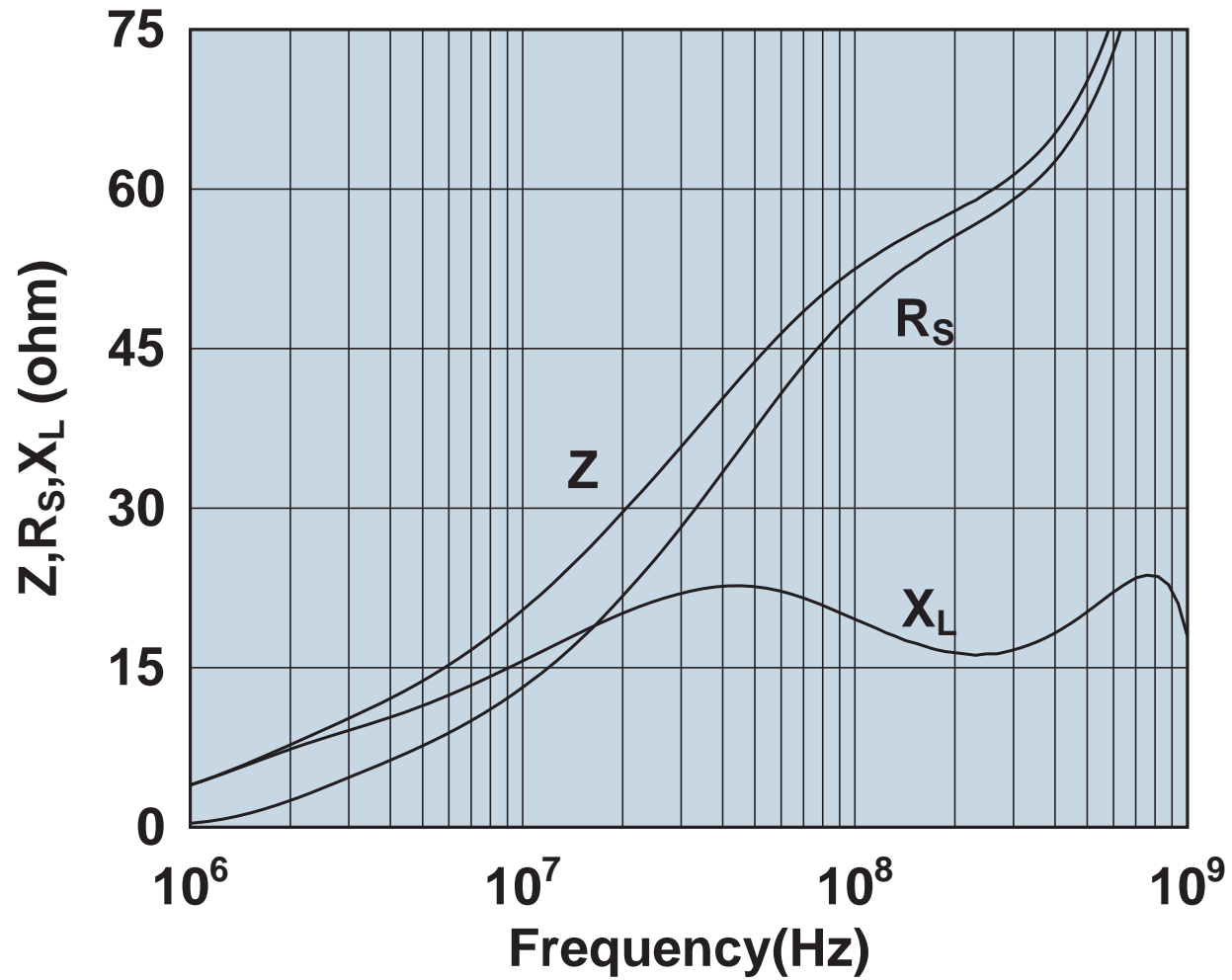

Impedance, reactance, and resistance vs. frequency.

2644236301

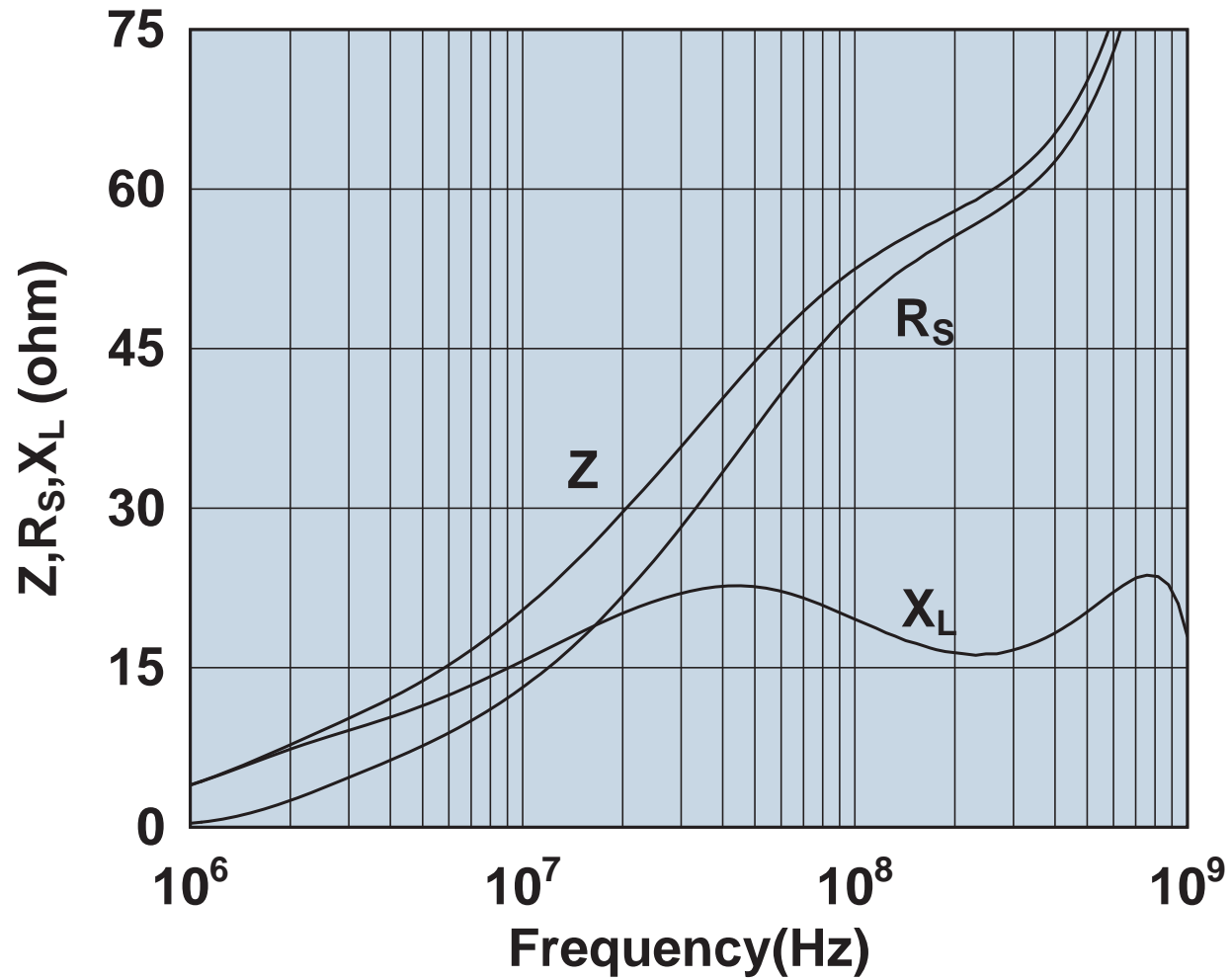

Impedance, reactance, and resistance vs. frequency.

2644236401

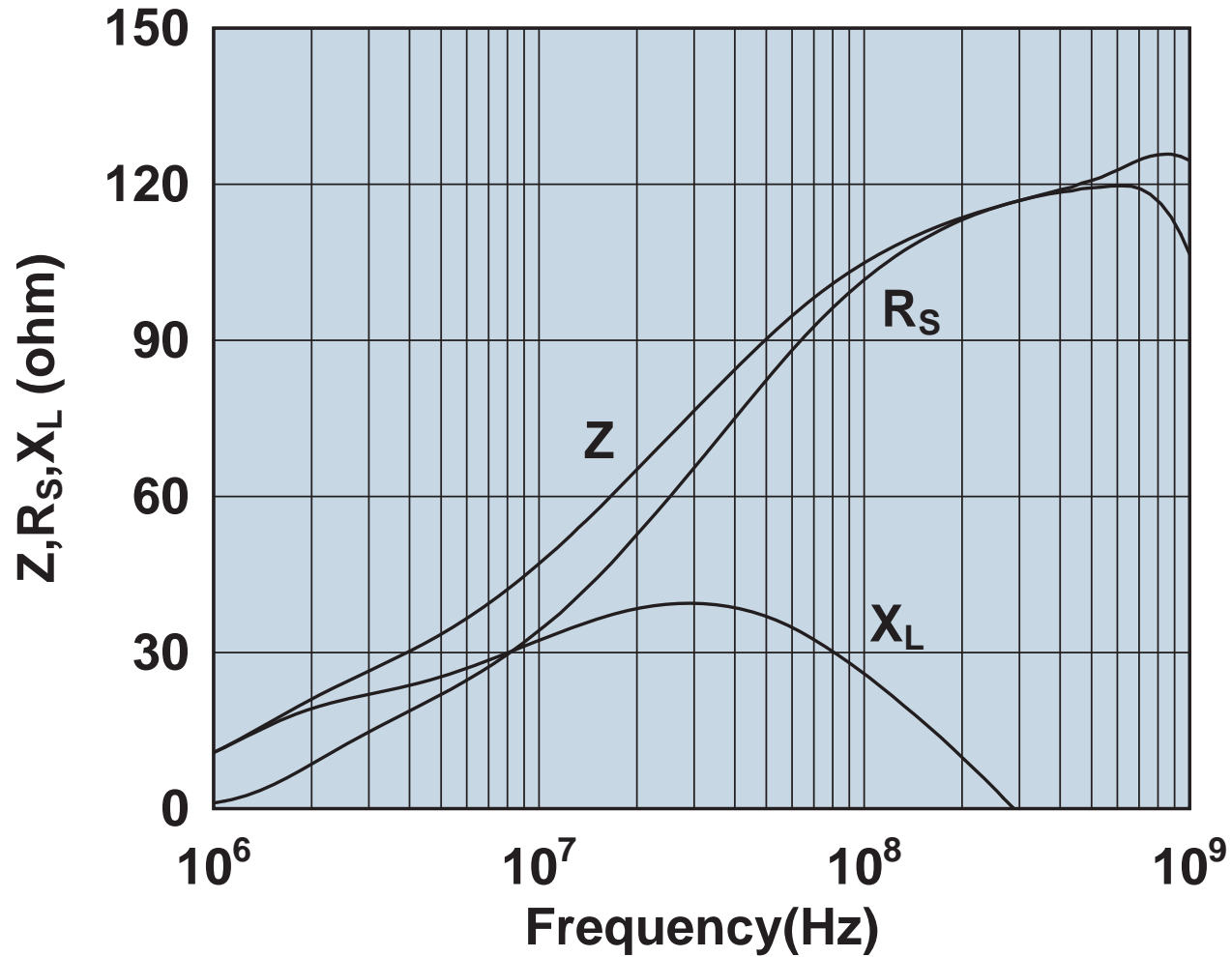

Impedance, reactance, and resistance vs. frequency.

2644236501

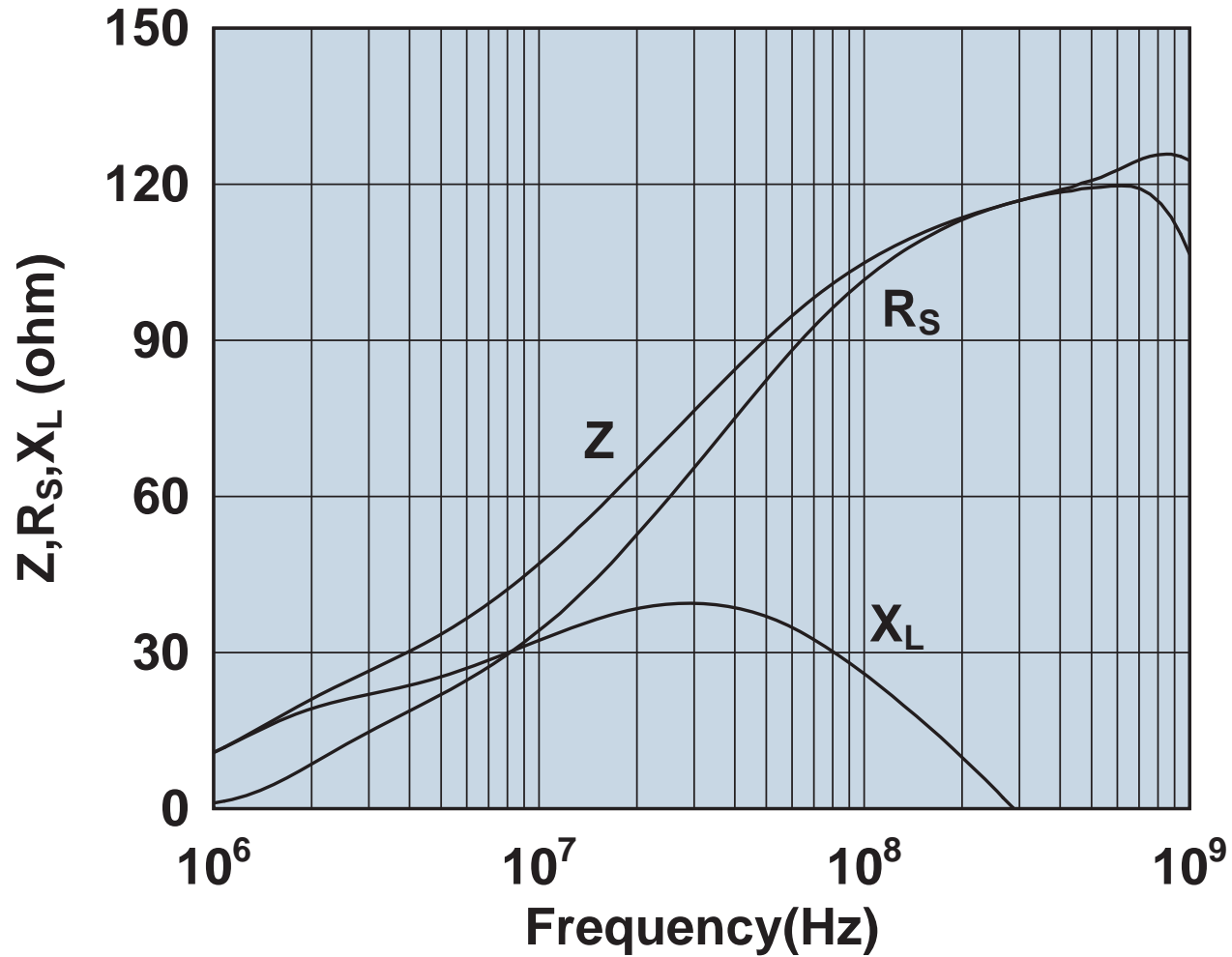

Impedance, reactance, and resistance vs. frequency.

2644236601

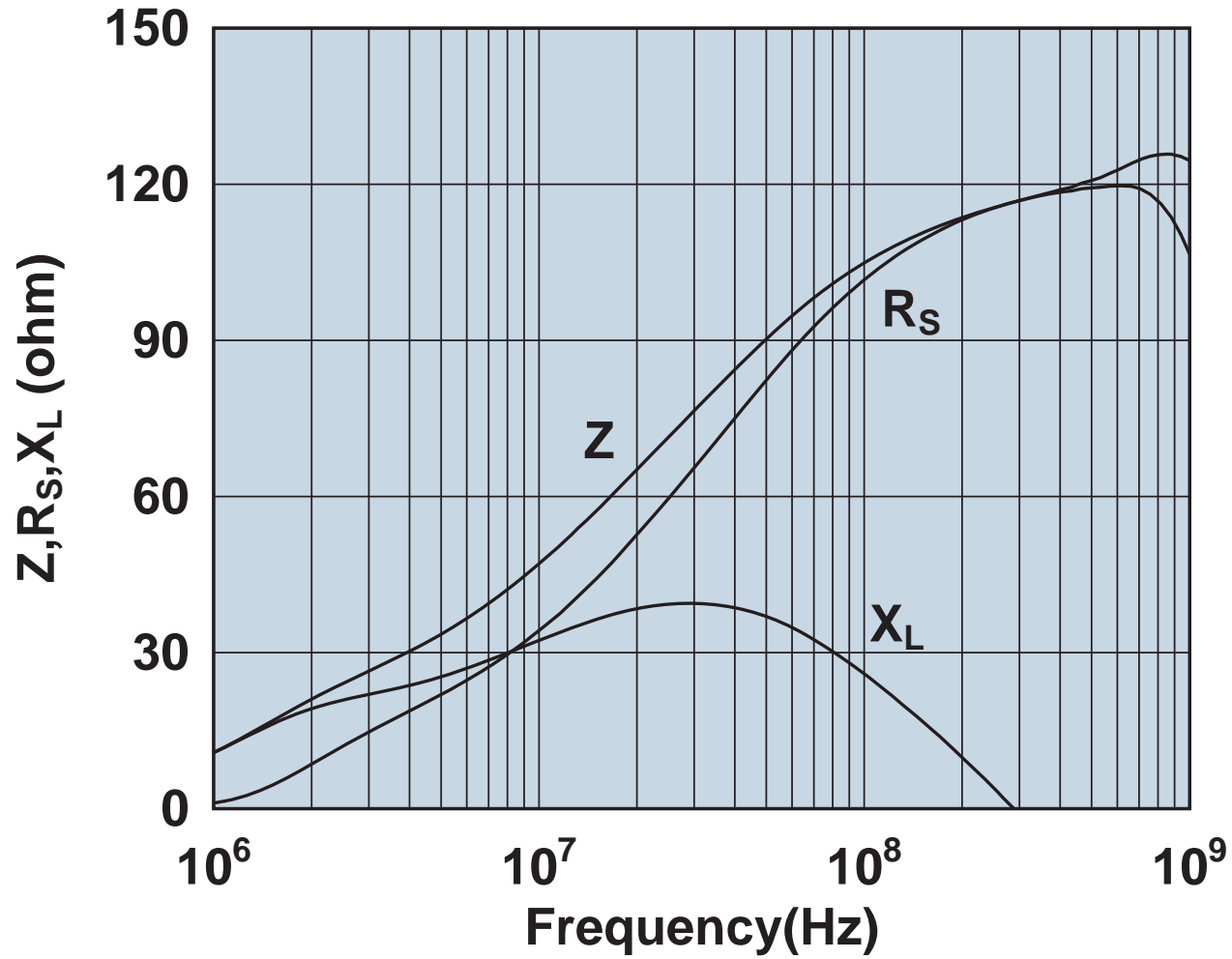

Impedance, reactance, and resistance vs. frequency.

2644245601

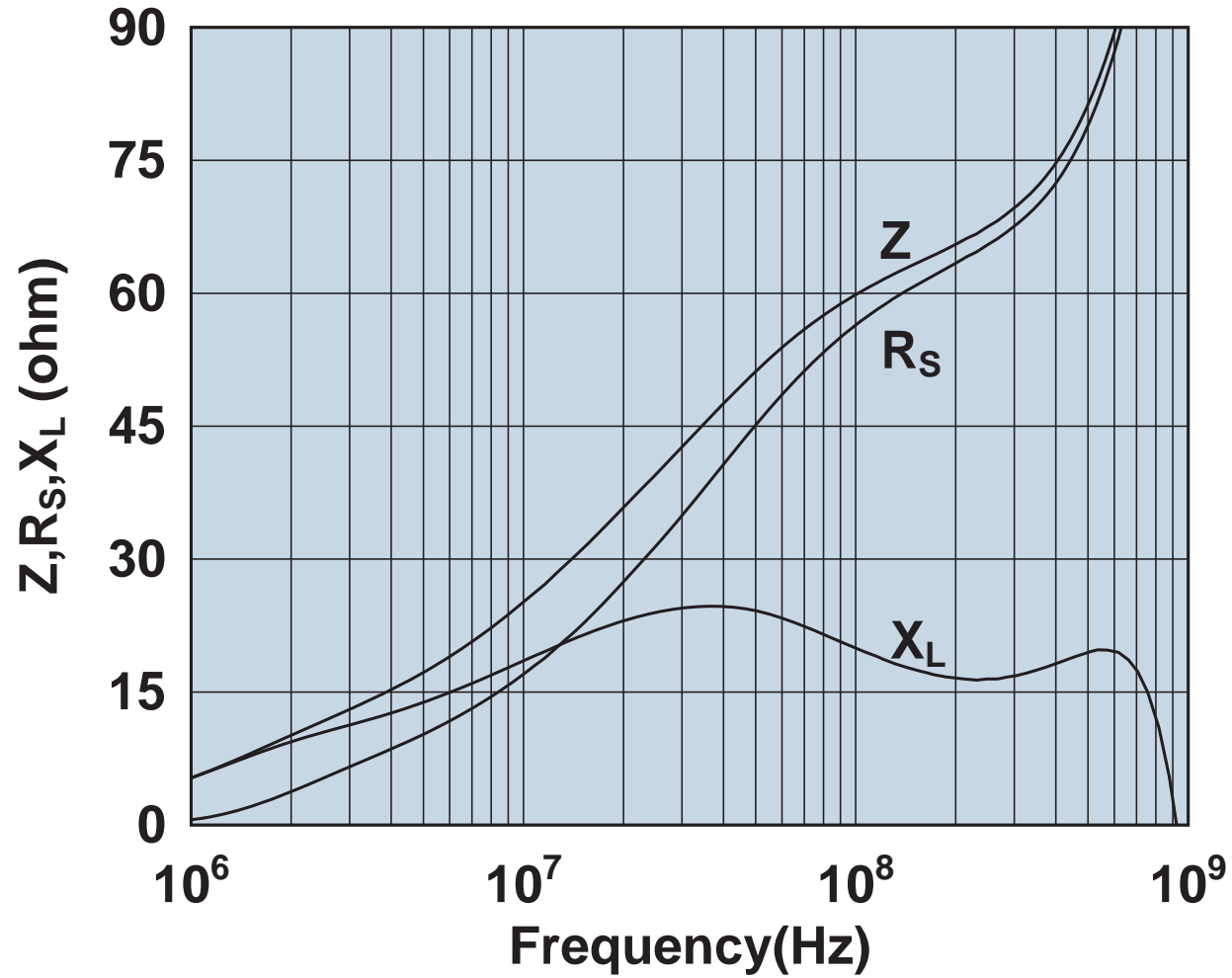

Impedance, reactance, and resistance vs. frequency.

2644245701

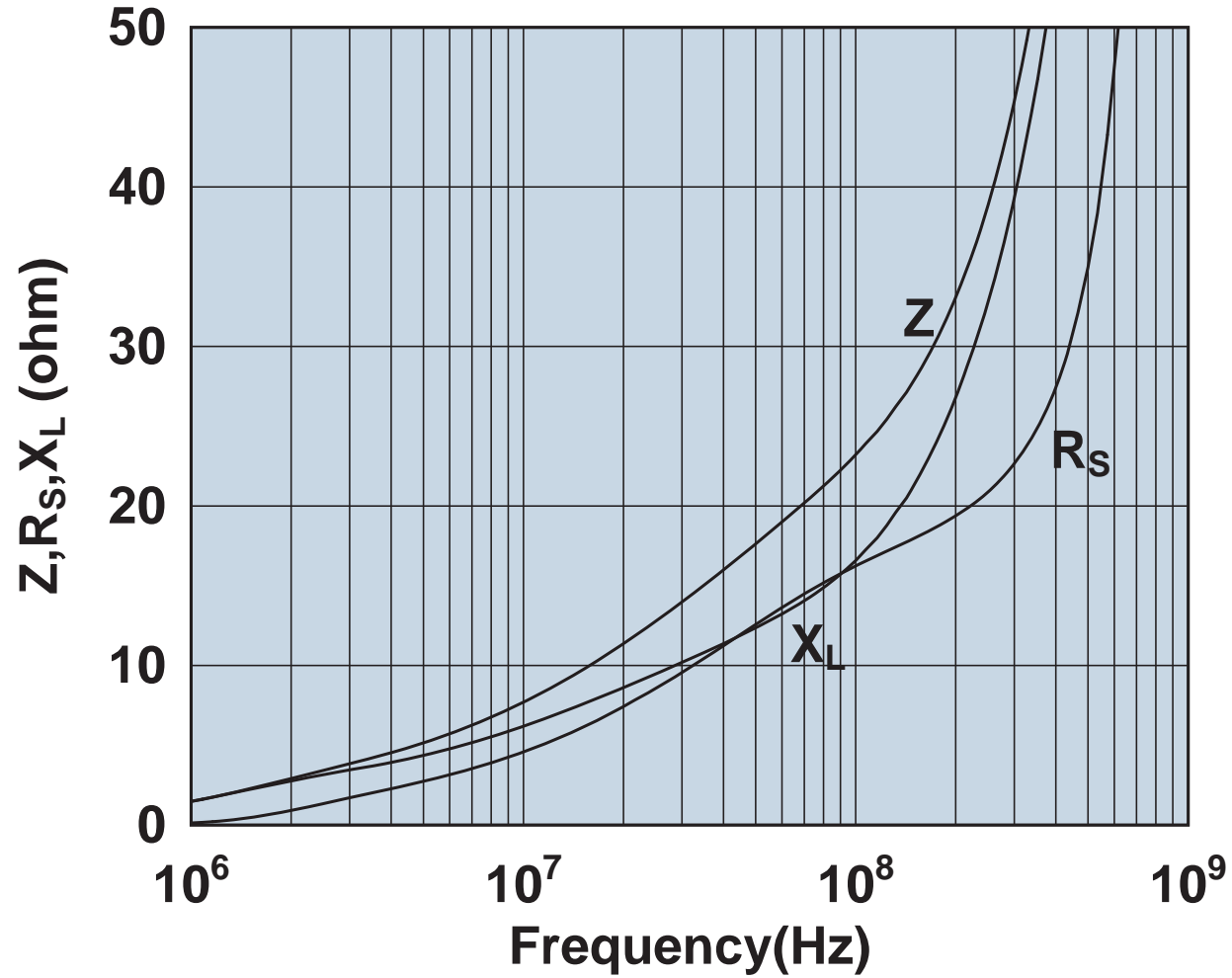

Impedance, reactance, and resistance vs. frequency.

2644245801

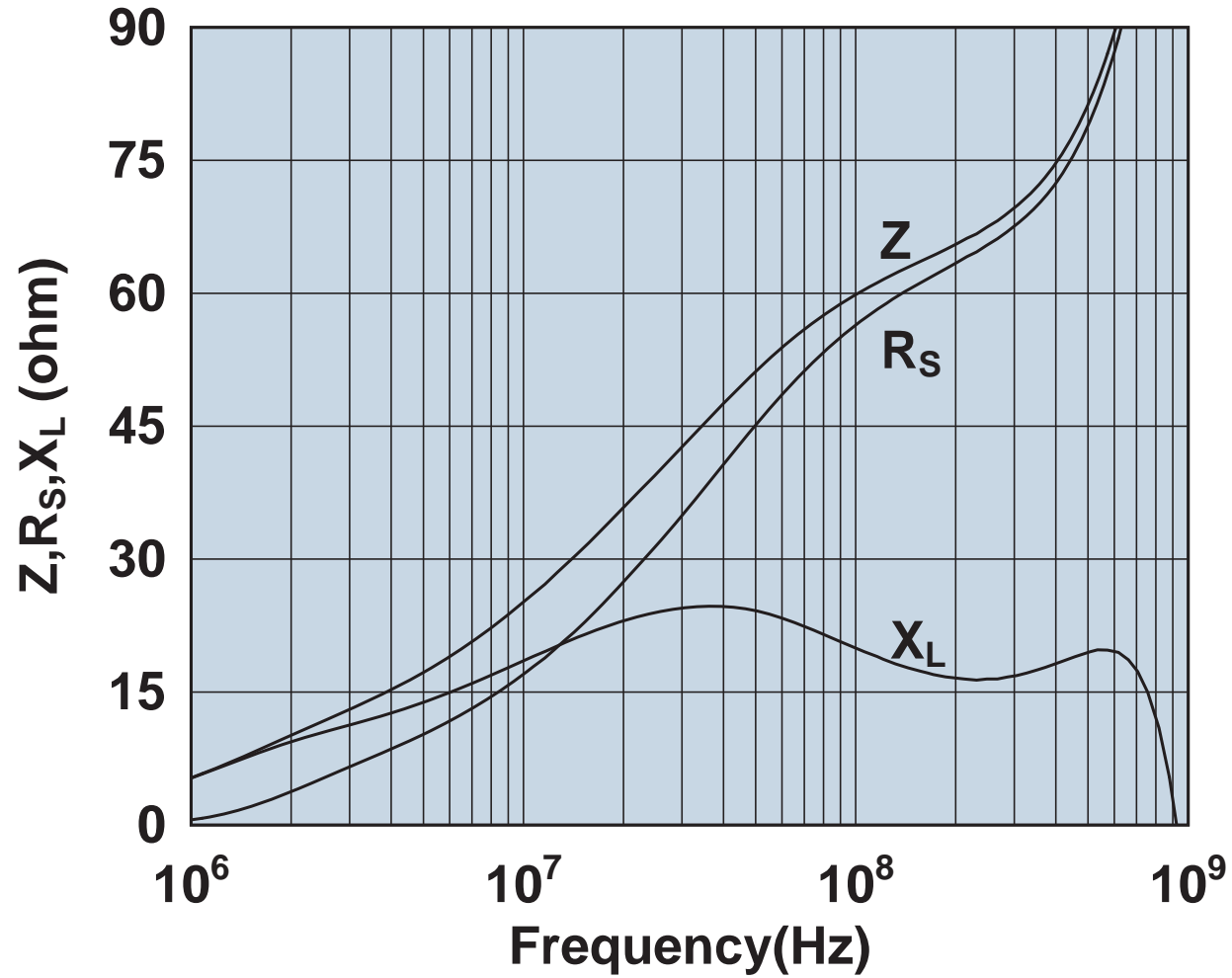

Impedance, reactance, and resistance vs. frequency.

2644245901



Impedance, reactance, and resistance vs. frequency.

2644246001

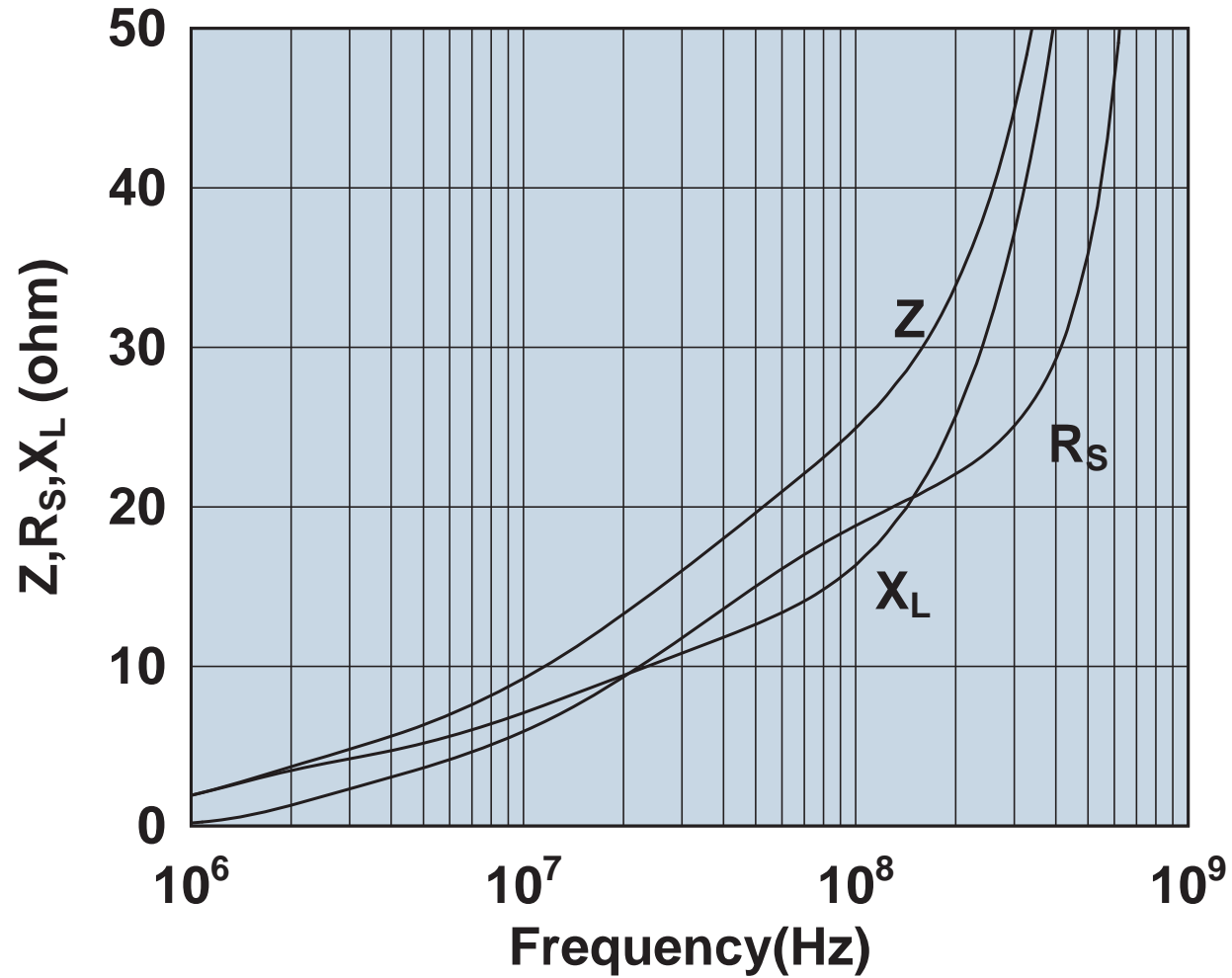

Impedance, reactance, and resistance vs. frequency.

2644246101

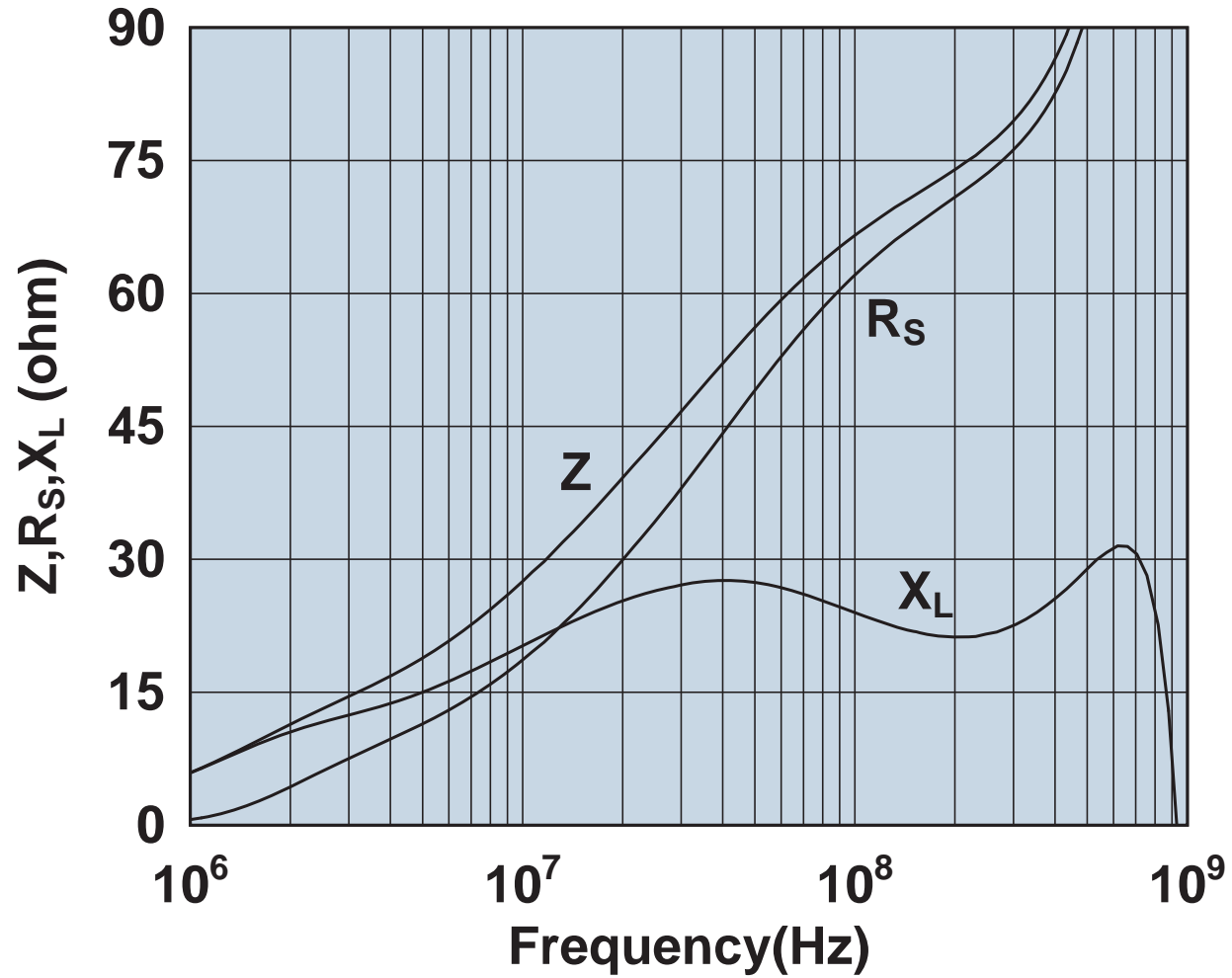

Impedance, reactance, and resistance vs. frequency.

2644246201

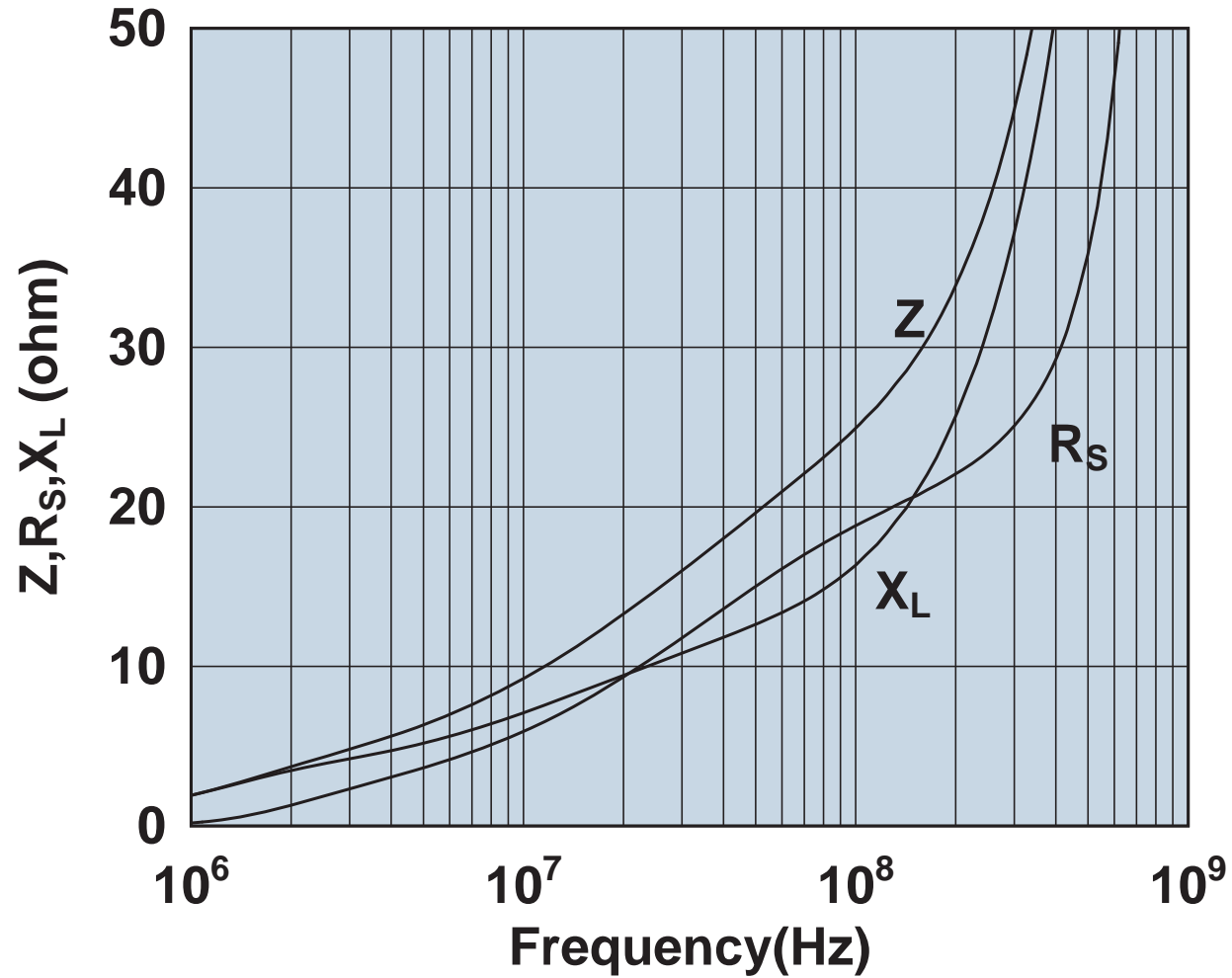

Impedance, reactance, and resistance vs. frequency.

2644246301

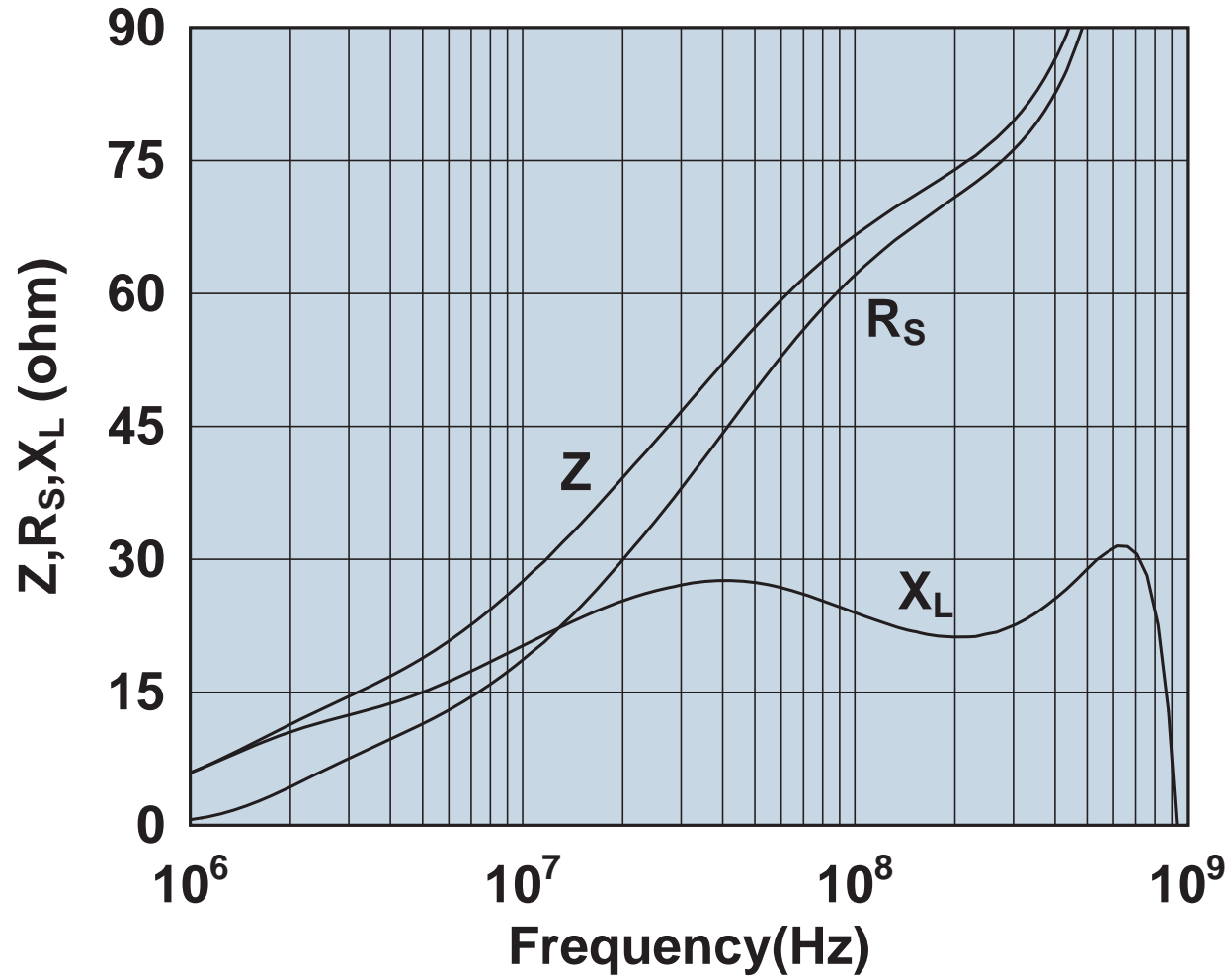

Impedance, reactance, and resistance vs. frequency.

2644246701

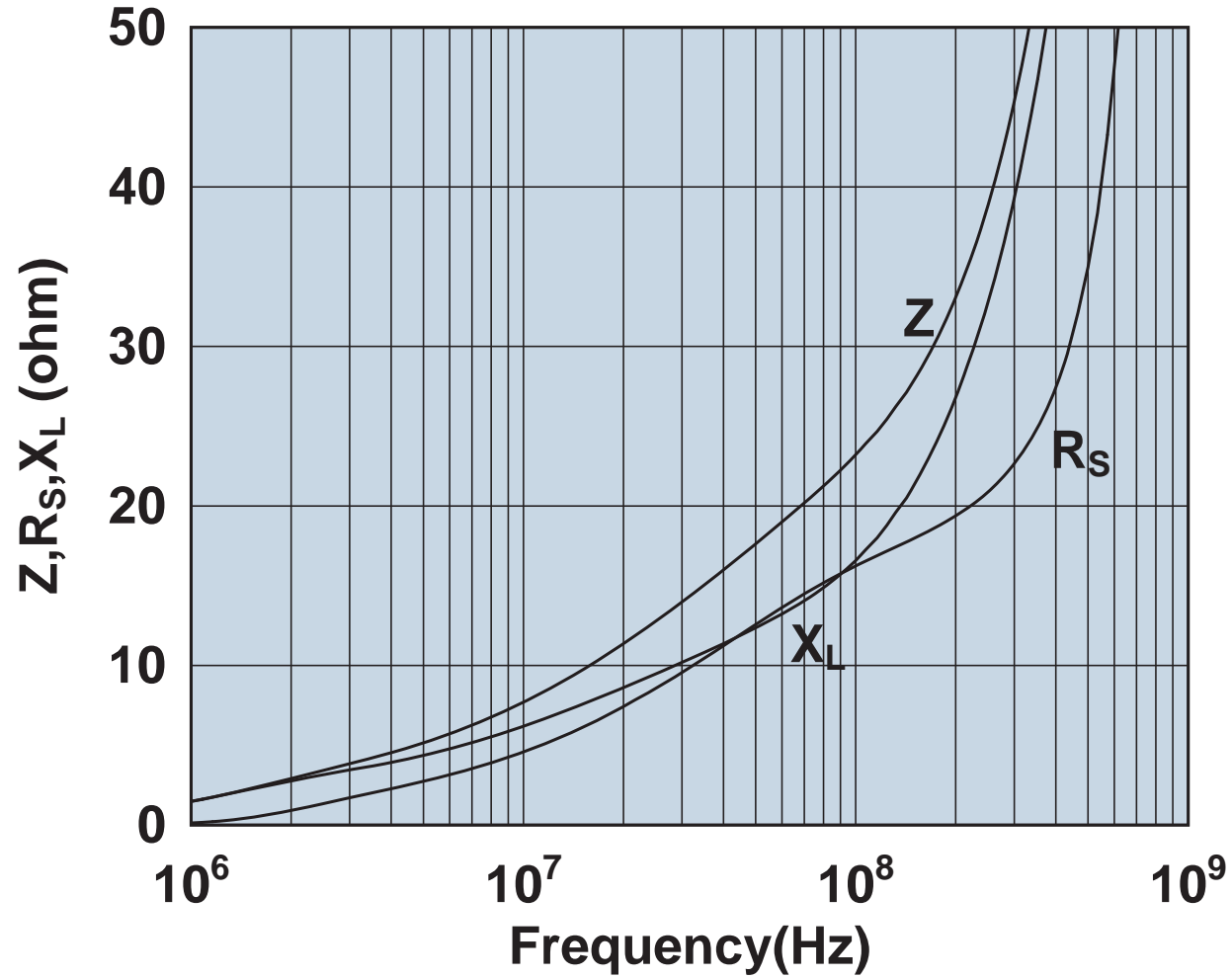

Impedance, reactance, and resistance vs. frequency.

2644246801

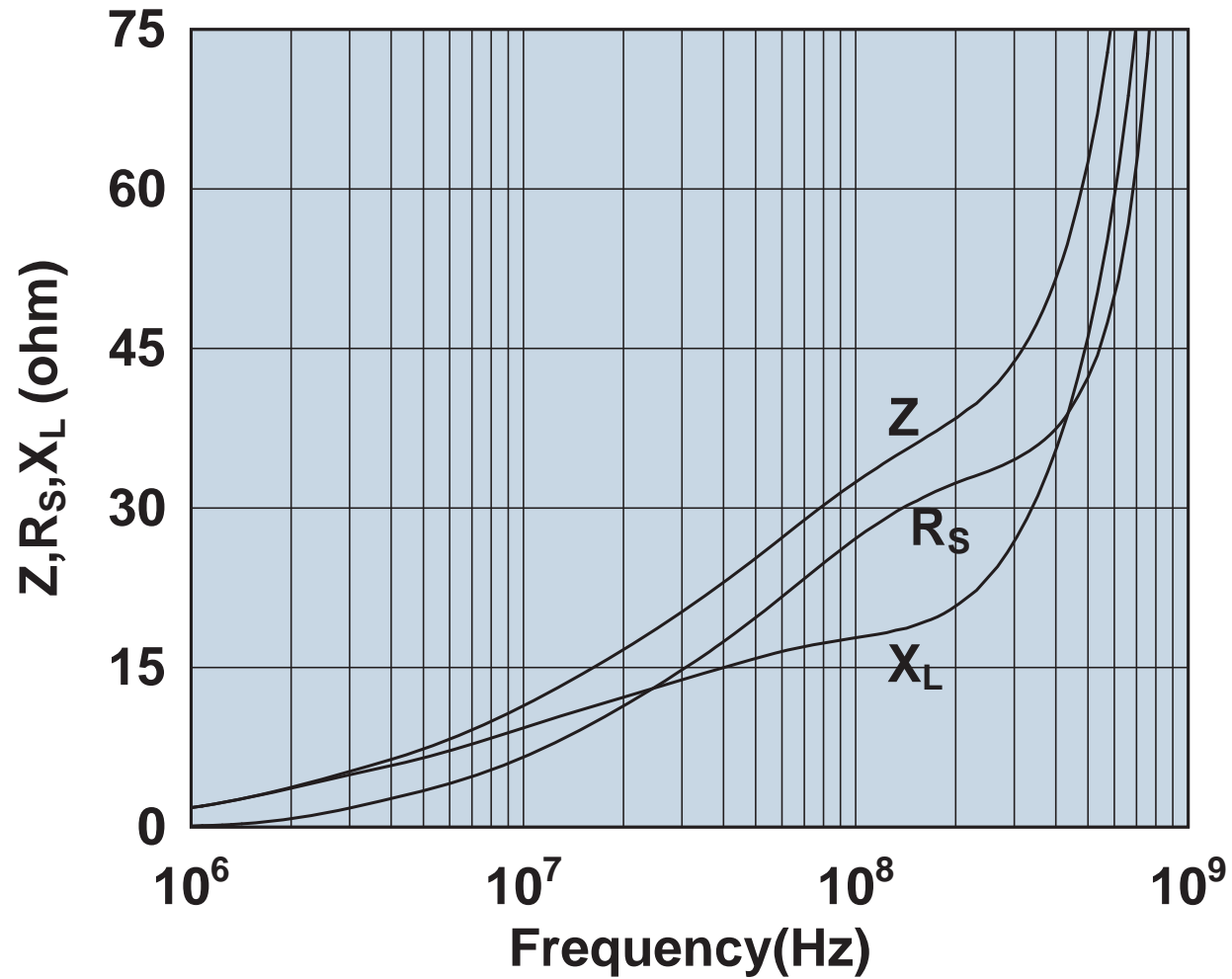

Impedance, reactance, and resistance vs. frequency.

2644246901

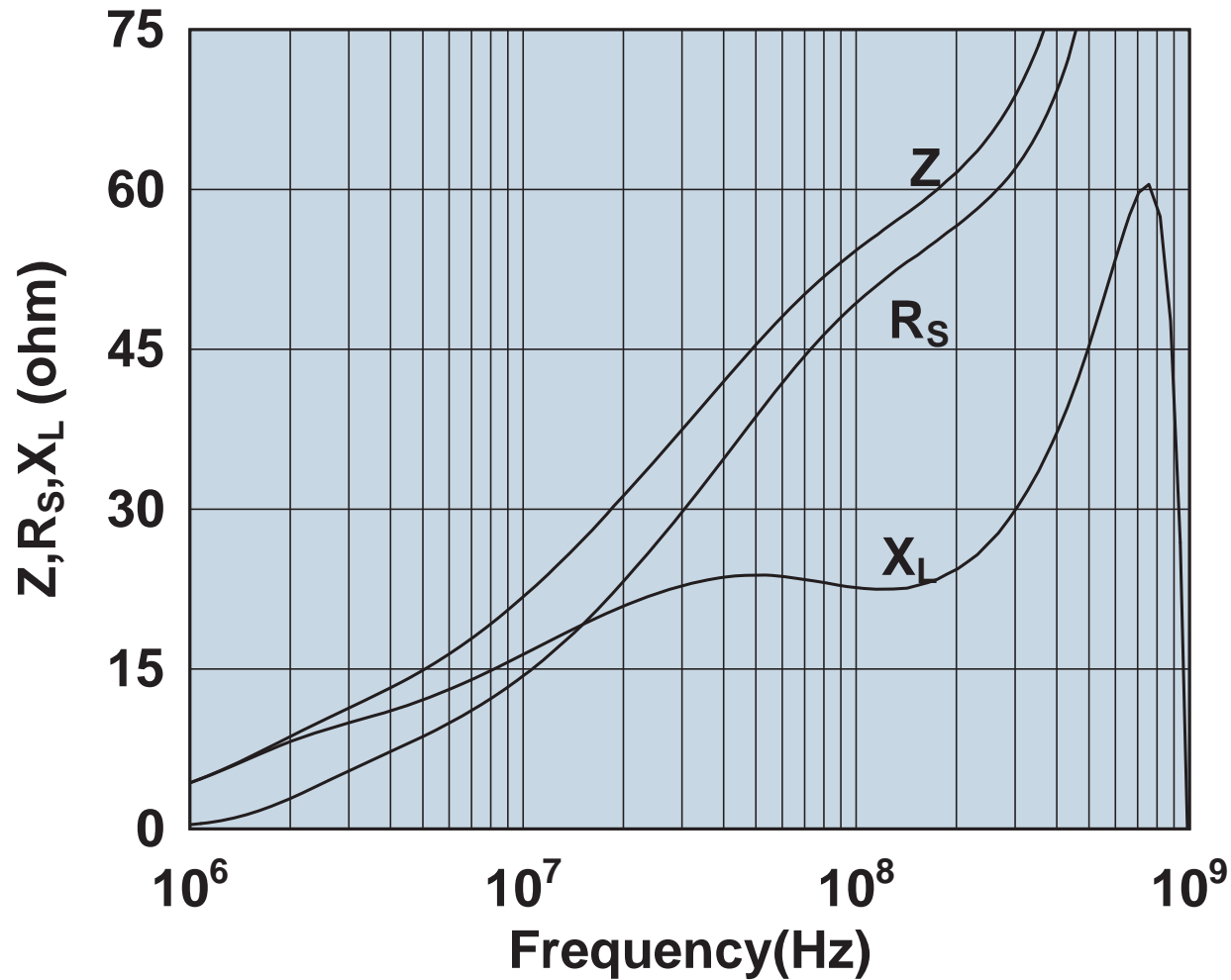

Impedance, reactance, and resistance vs. frequency.

2644247001



Impedance, reactance, and resistance vs. frequency.

2644247101

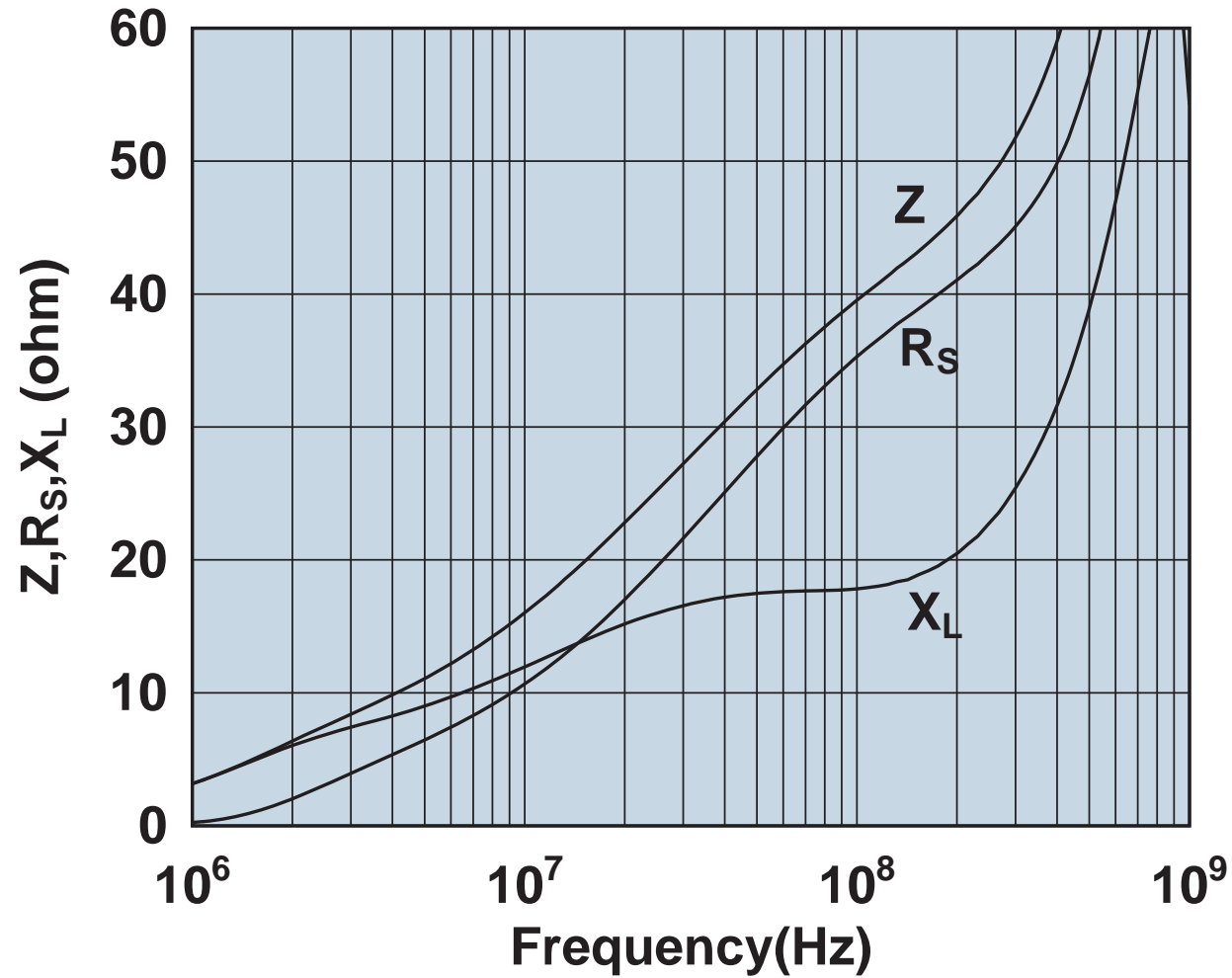

Impedance, reactance, and resistance vs. frequency.

2644247201

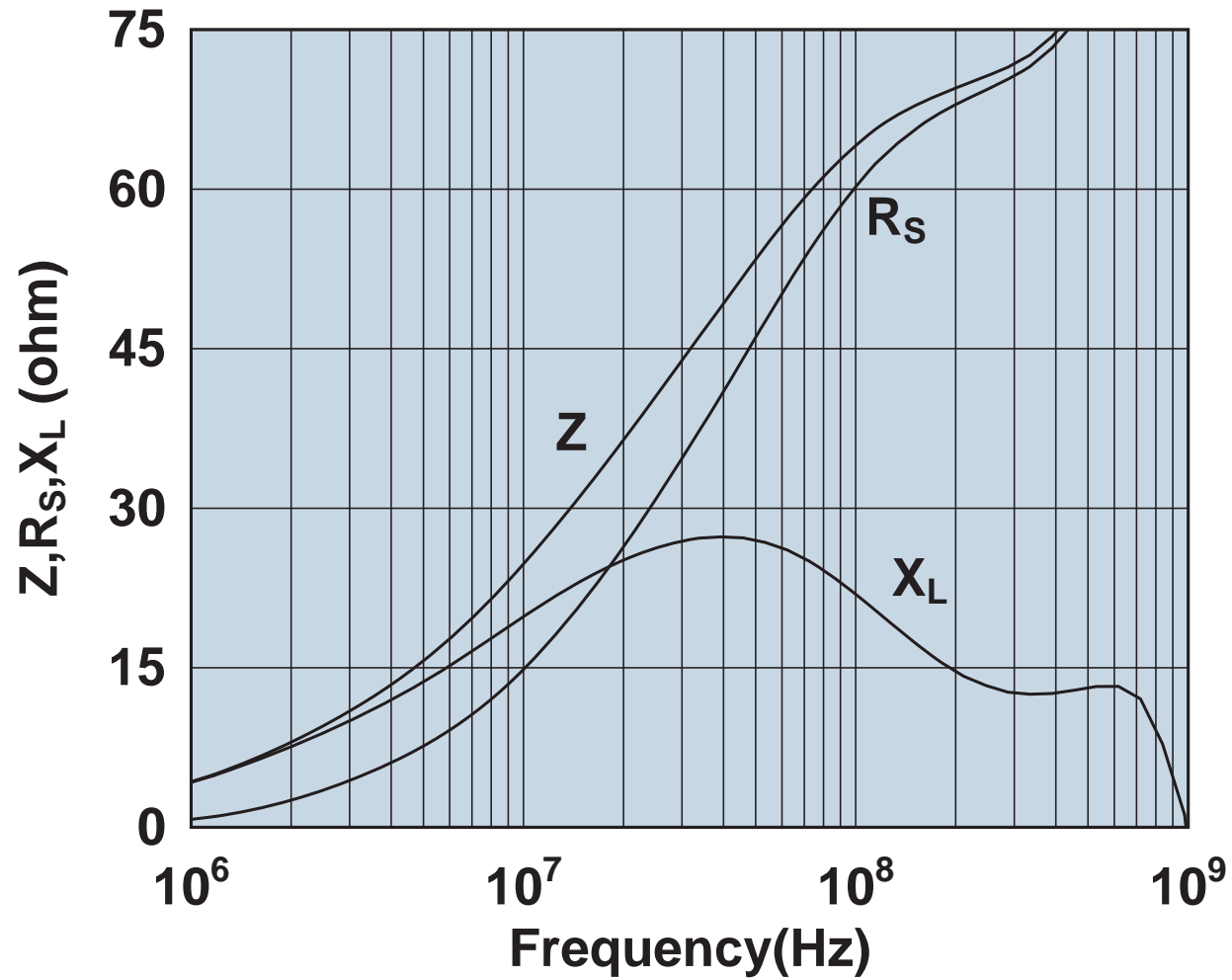

Impedance, reactance, and resistance vs. frequency.

2644247301

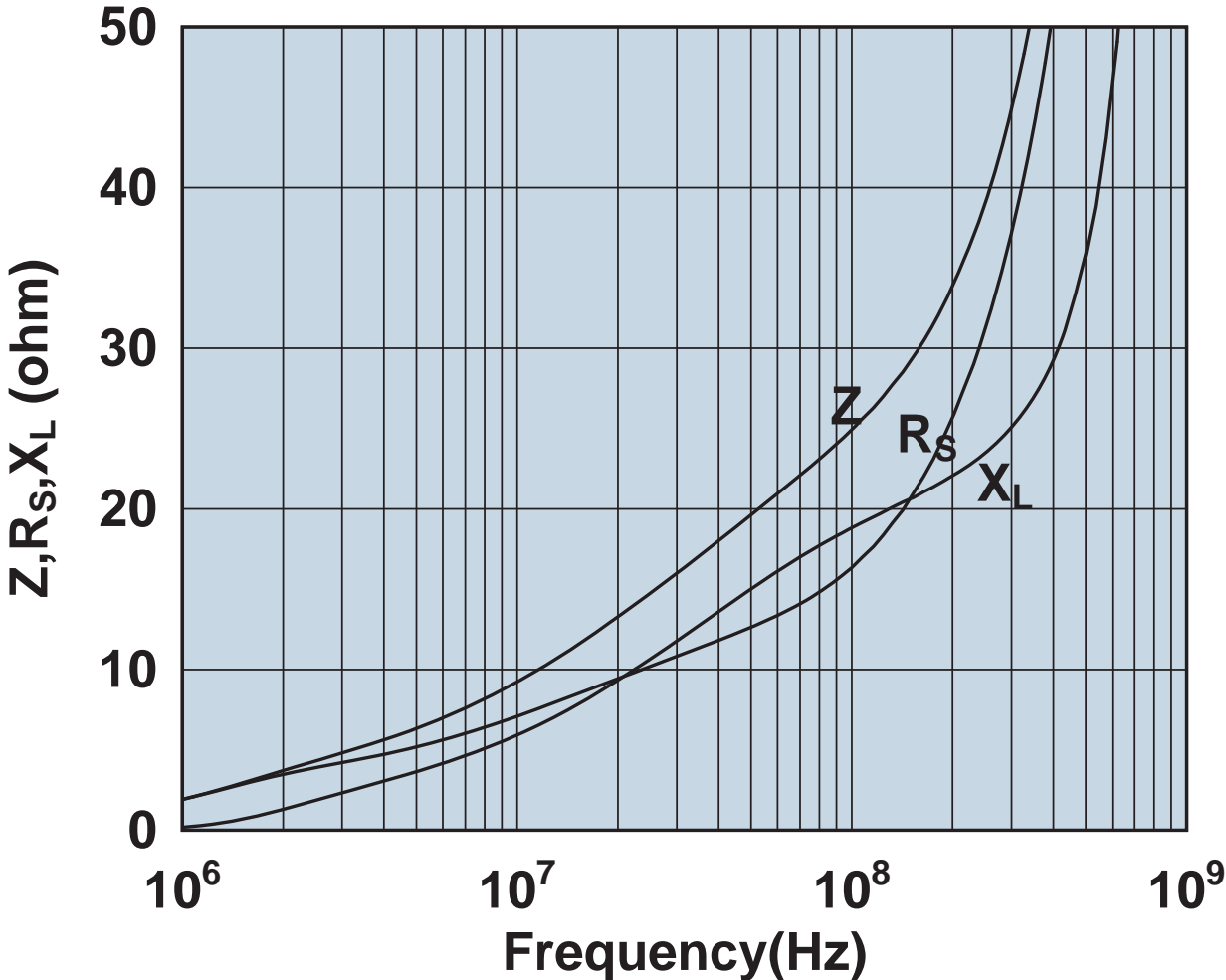

Impedance, reactance, and resistance vs. frequency.

2644247401

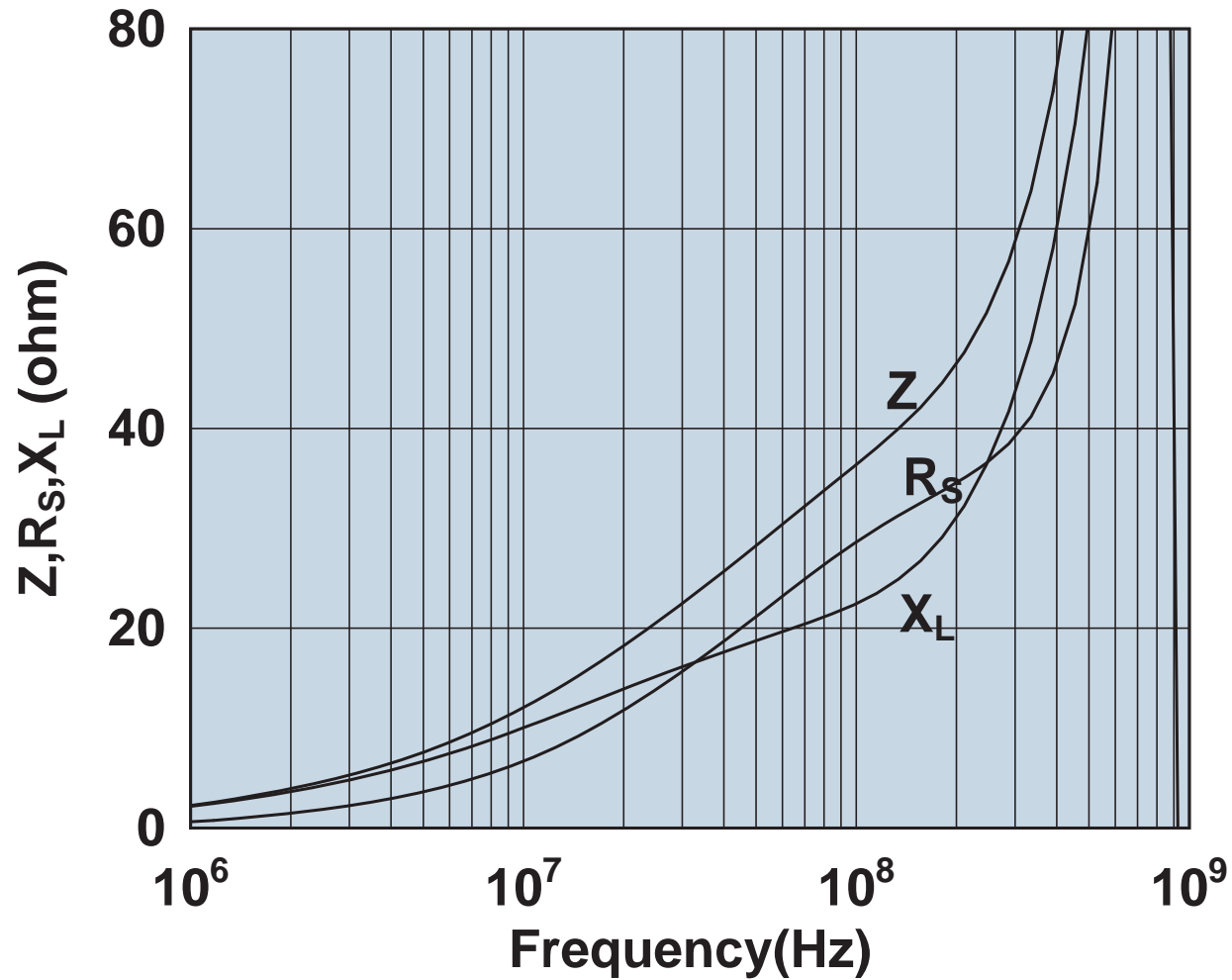

Impedance, reactance, and resistance vs. frequency.

2644247501

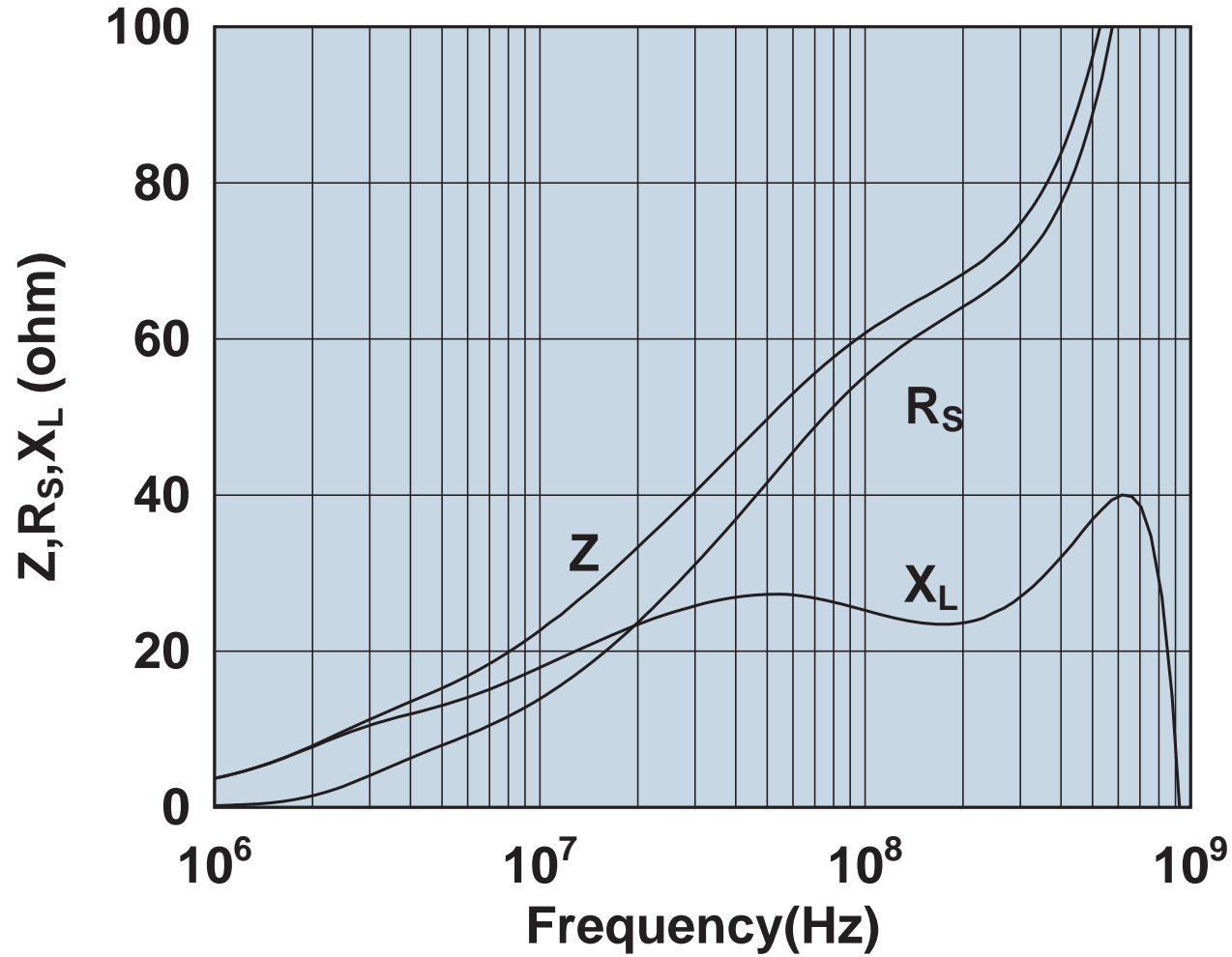

Impedance, reactance, and resistance vs. frequency.

2644251801

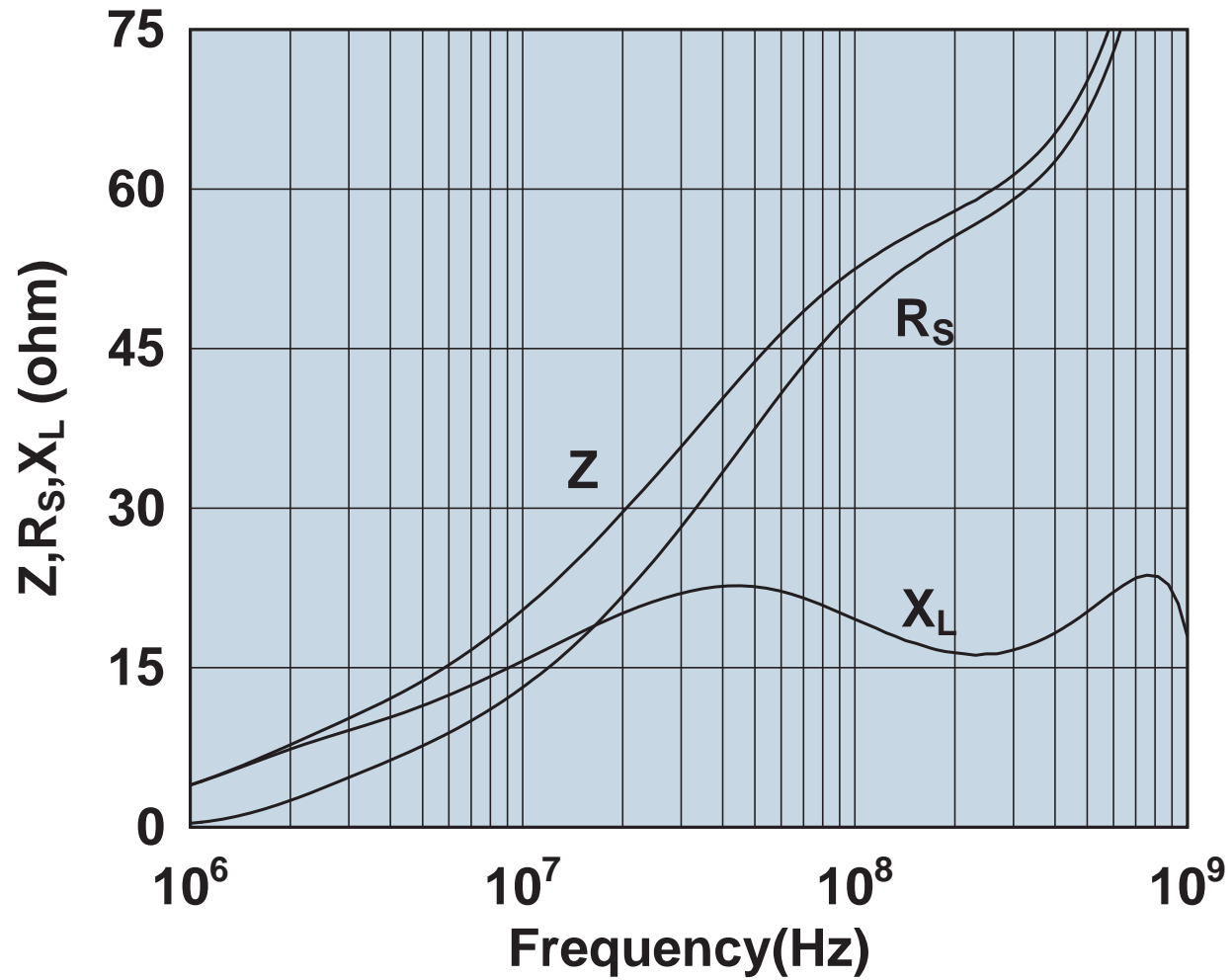

Impedance, reactance, and resistance vs. frequency.

2644251901

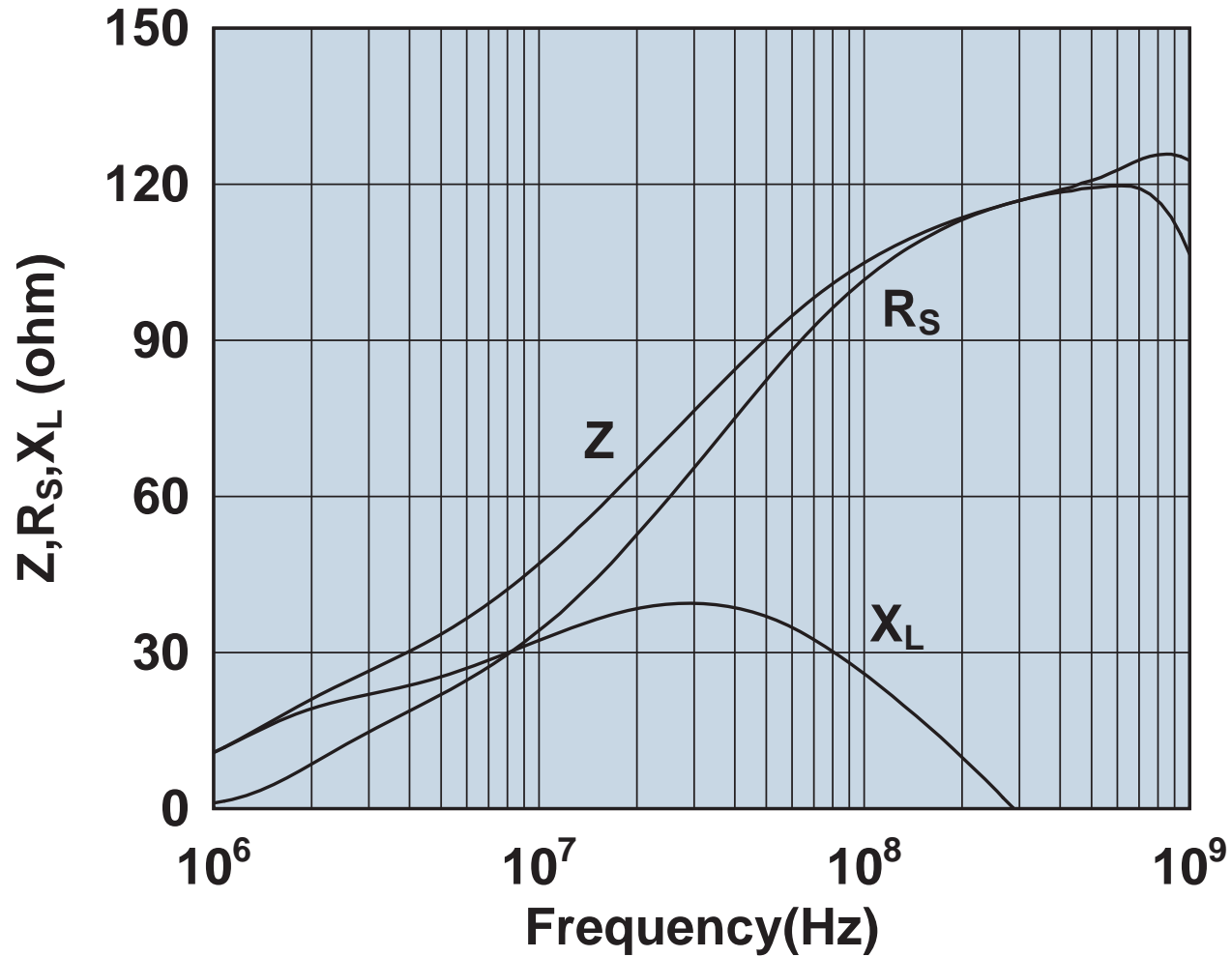

Impedance, reactance, and resistance vs. frequency.

2644373841

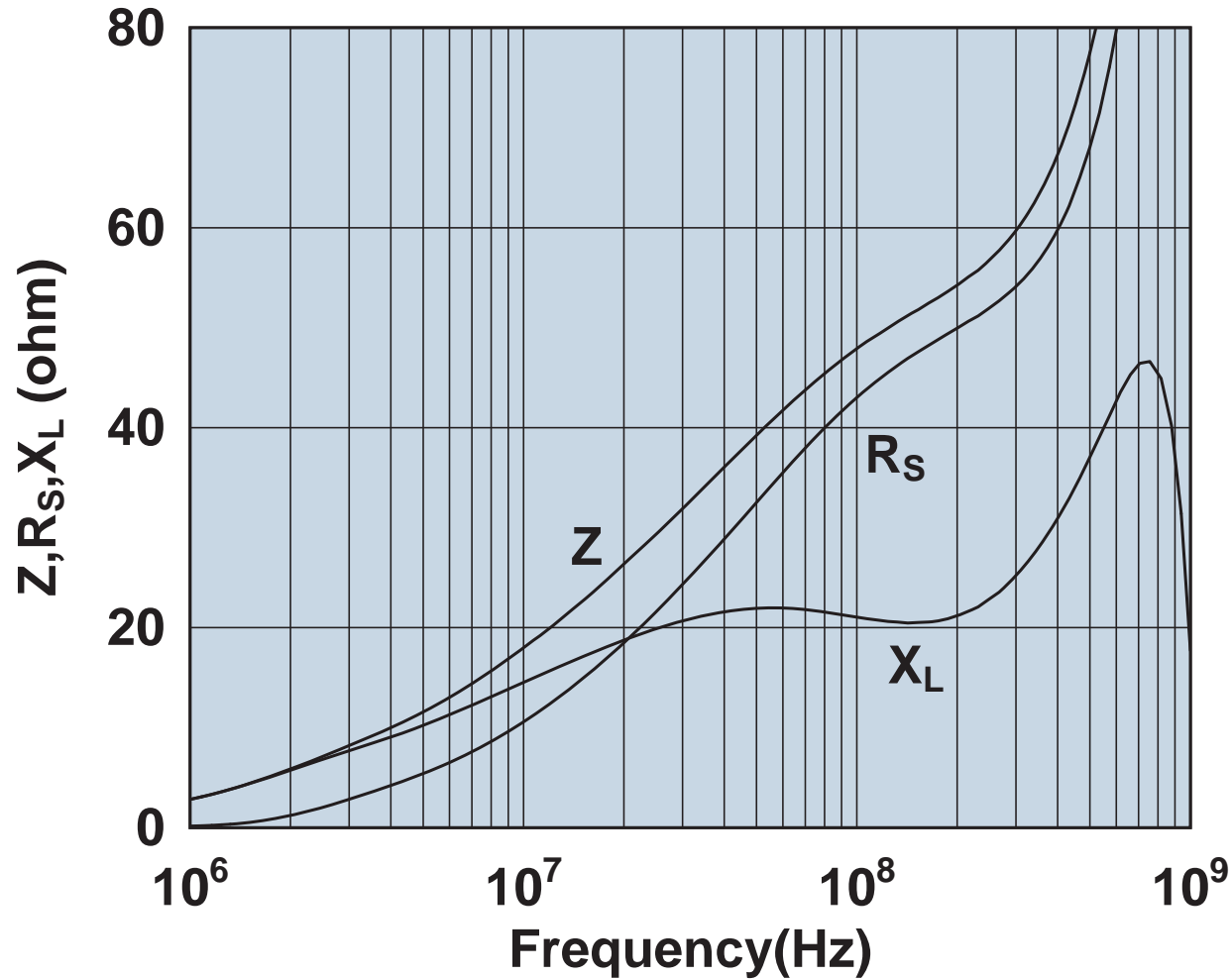

Impedance, reactance, and resistance vs. frequency.

2644373941

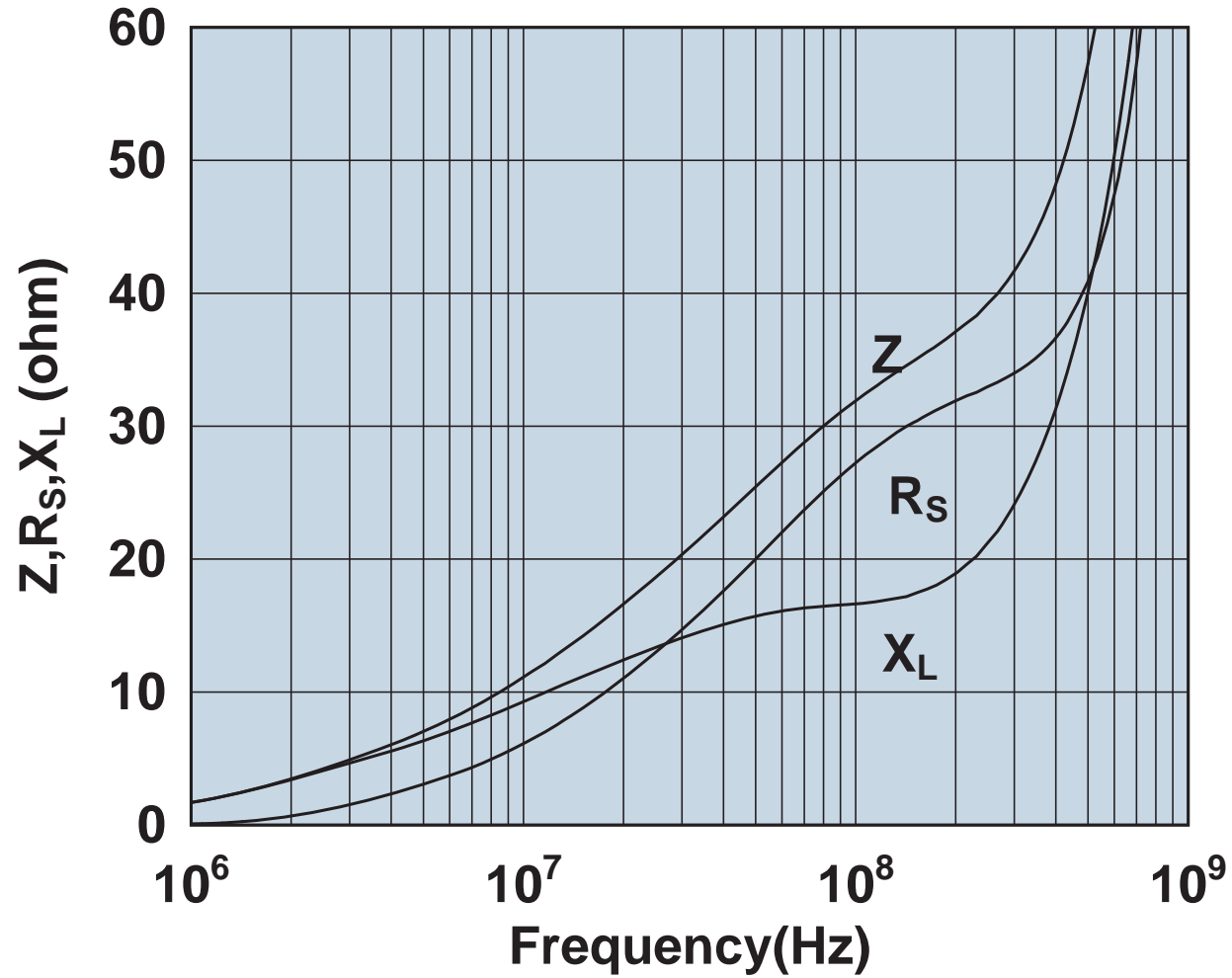

Impedance, reactance, and resistance vs. frequency.

2646101902

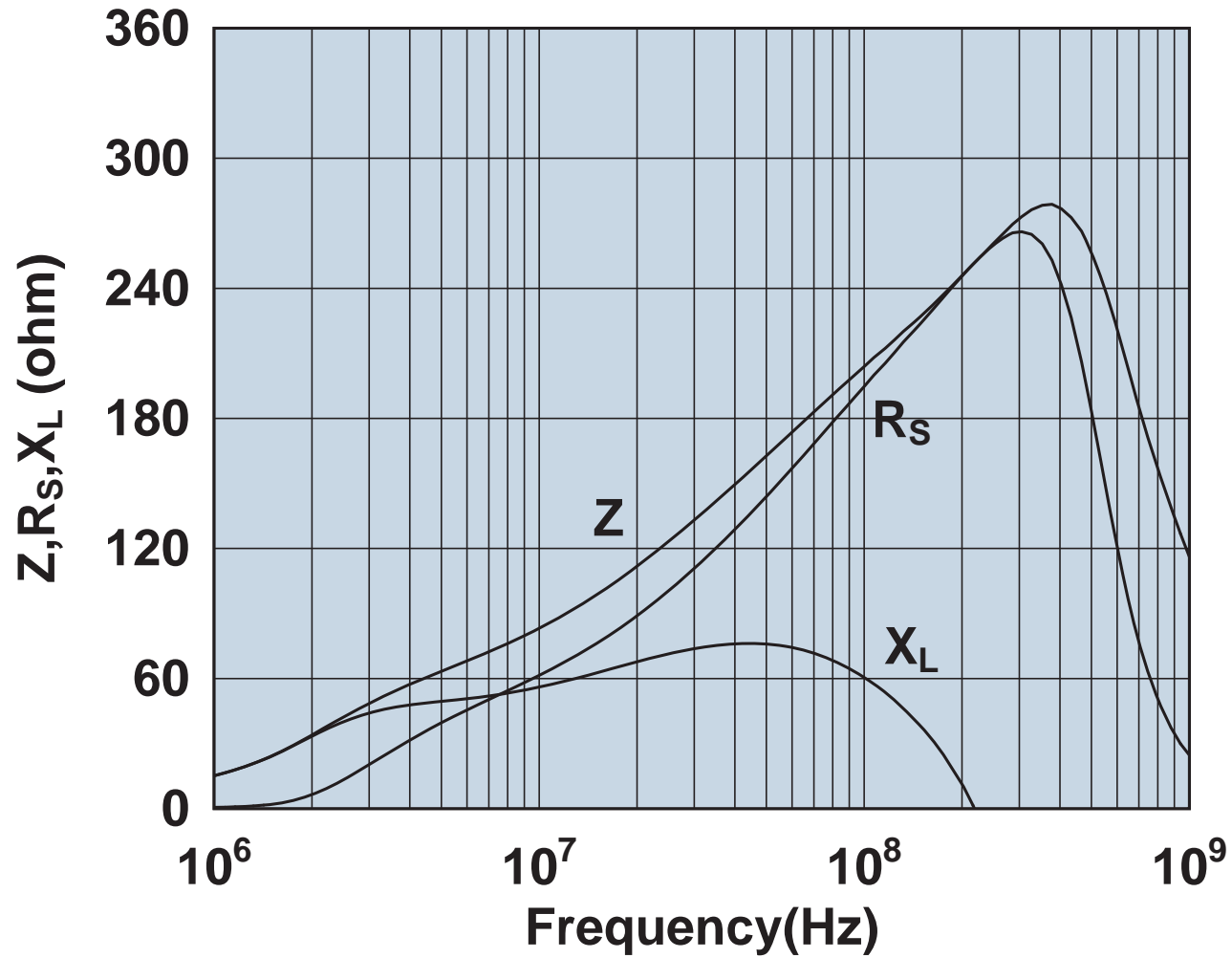

Impedance, reactance, and resistance vs. frequency.

2646102002

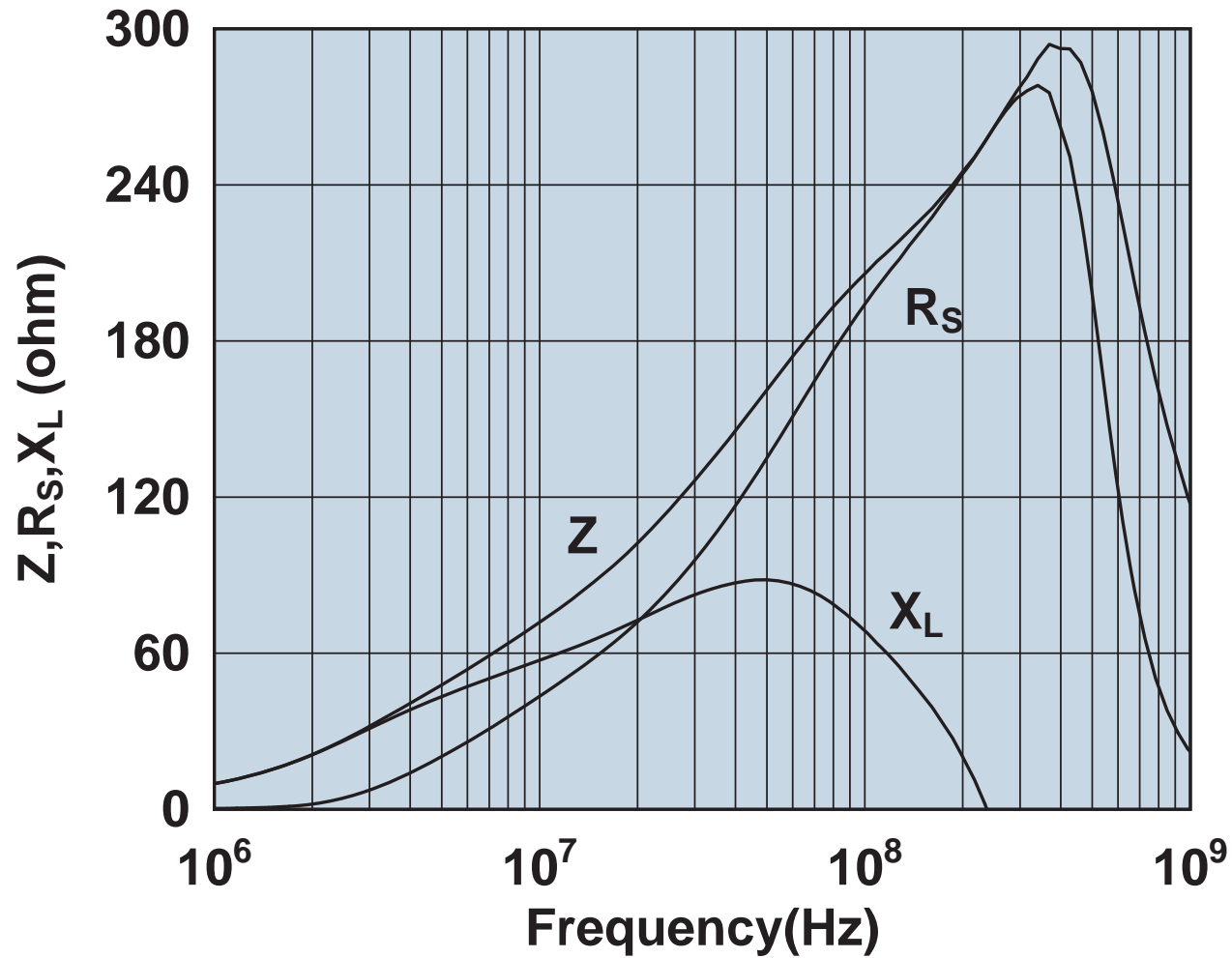

Impedance, reactance, and resistance vs. frequency.

2646102402

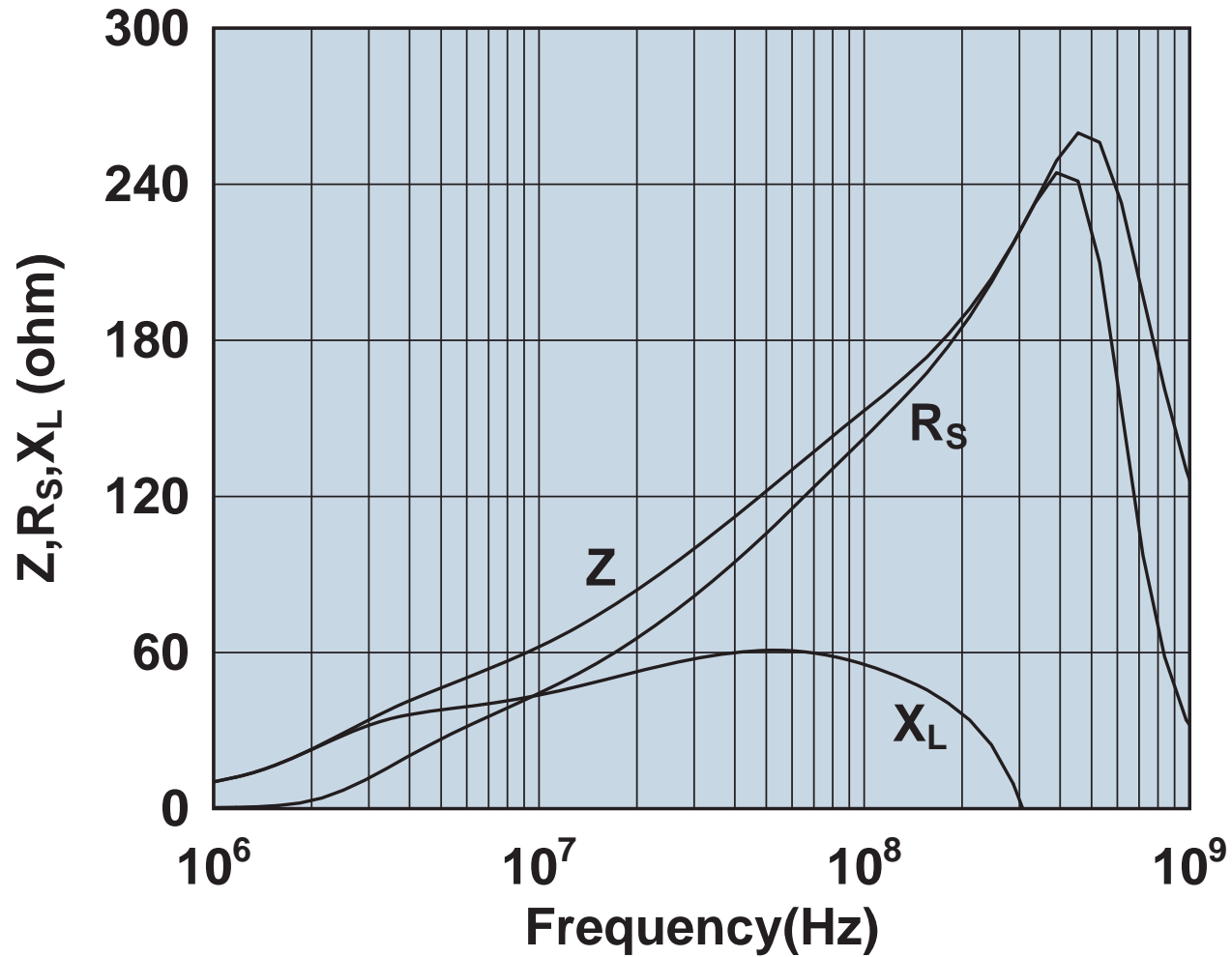

Impedance, reactance, and resistance vs. frequency.

2646103002

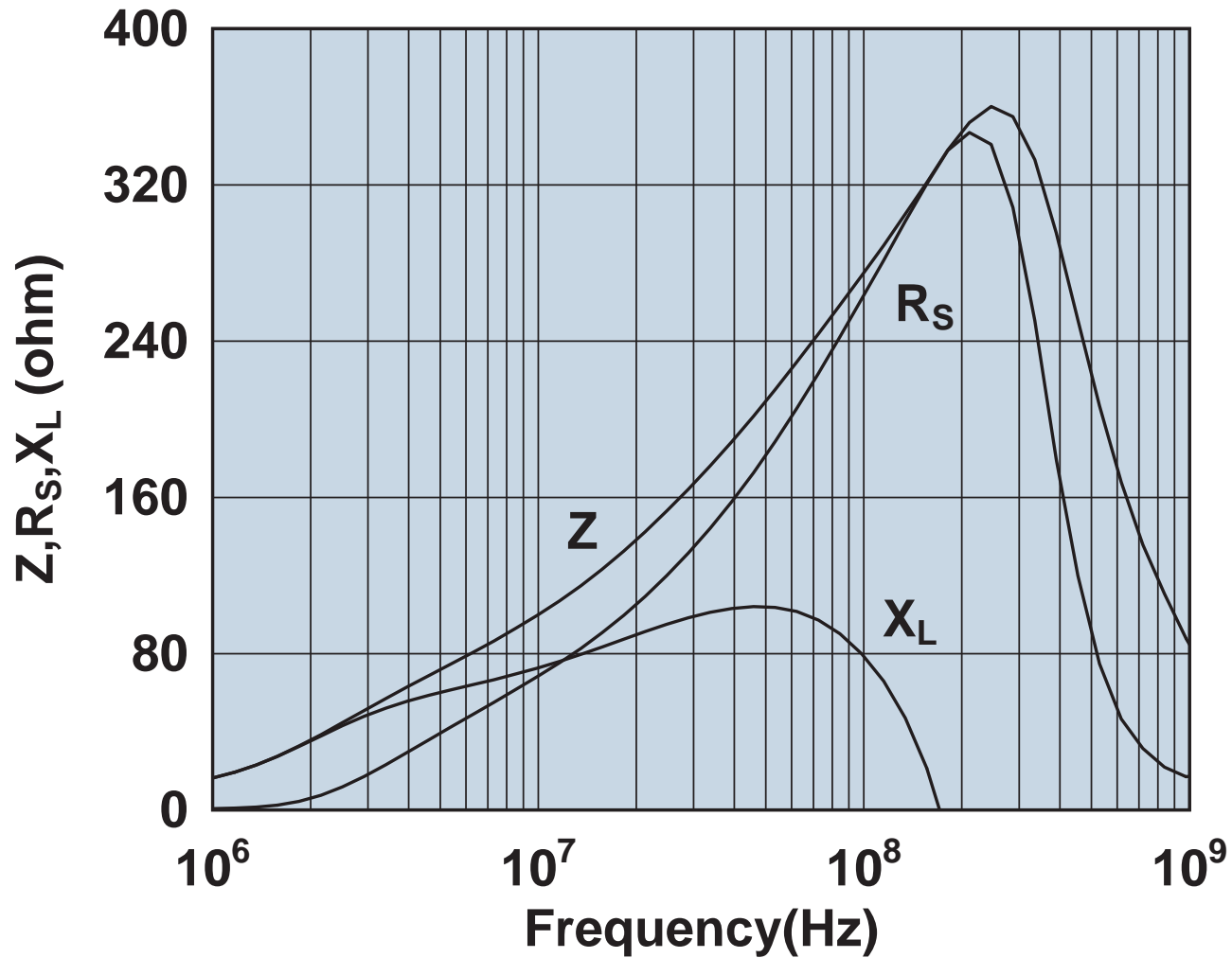

Impedance, reactance, and resistance vs. frequency.

2646164151

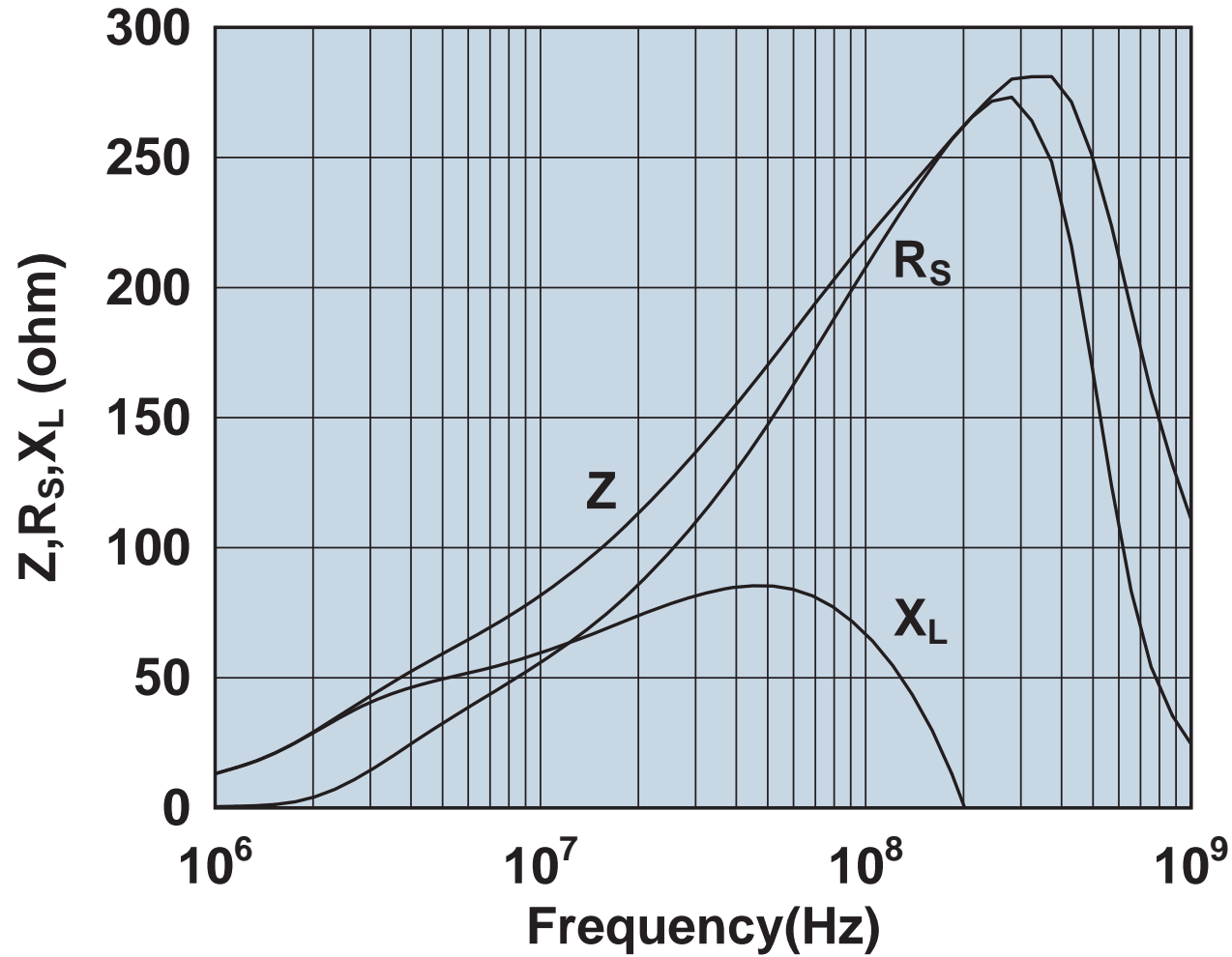

Impedance, reactance, and resistance vs. frequency.

2646164181

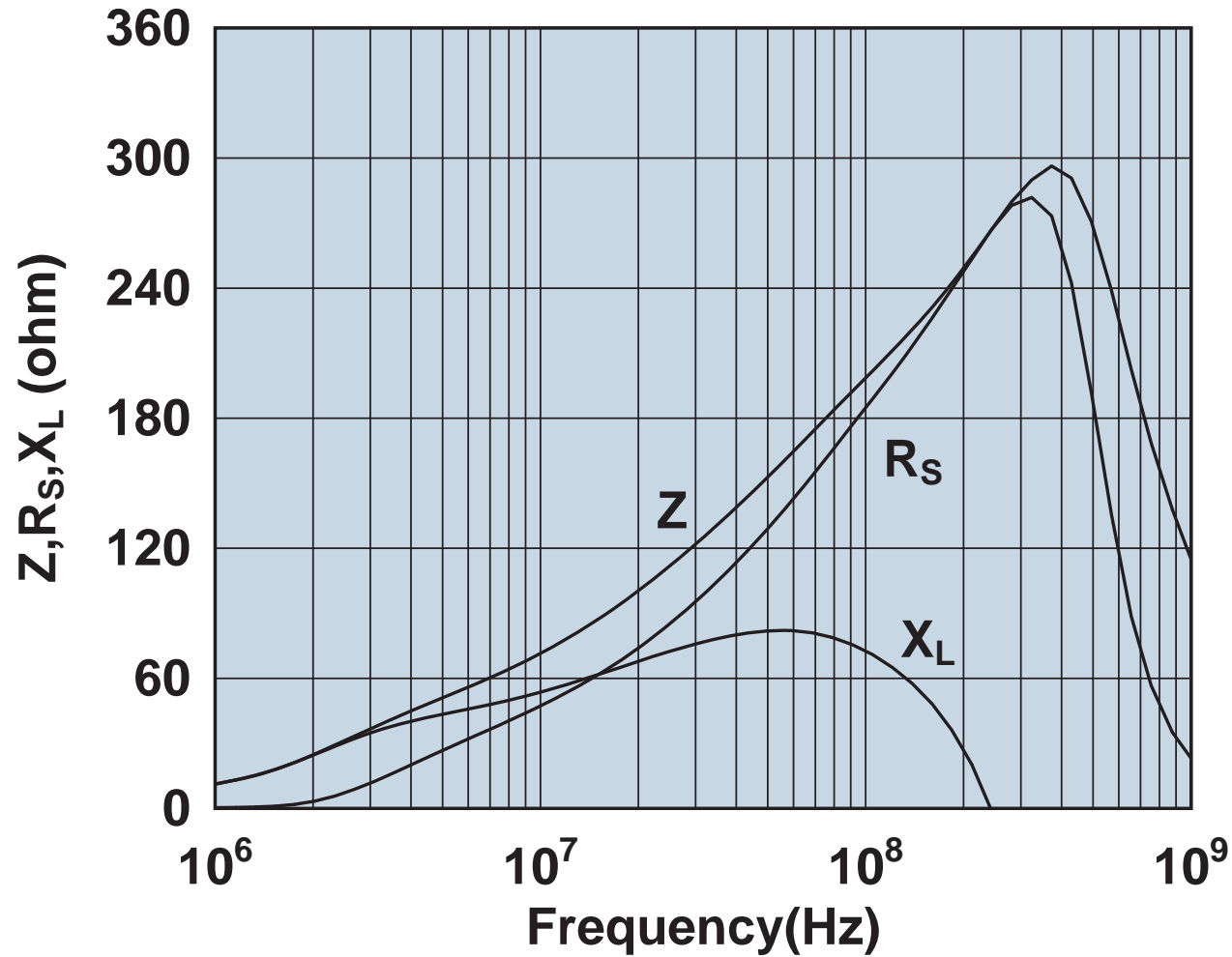

Impedance, reactance, and resistance vs. frequency.

2646164251

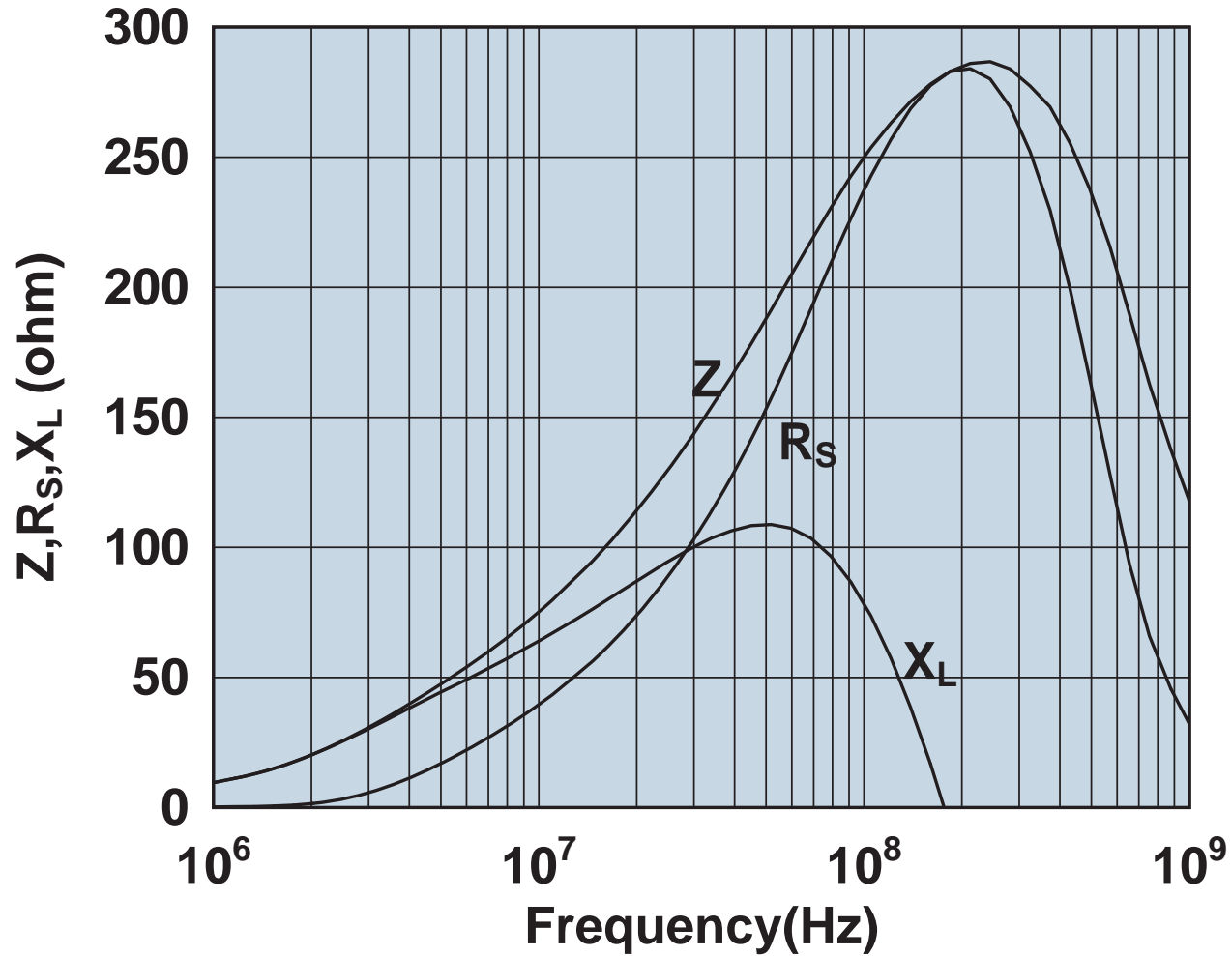

Impedance, reactance, and resistance vs. frequency.

2646164281

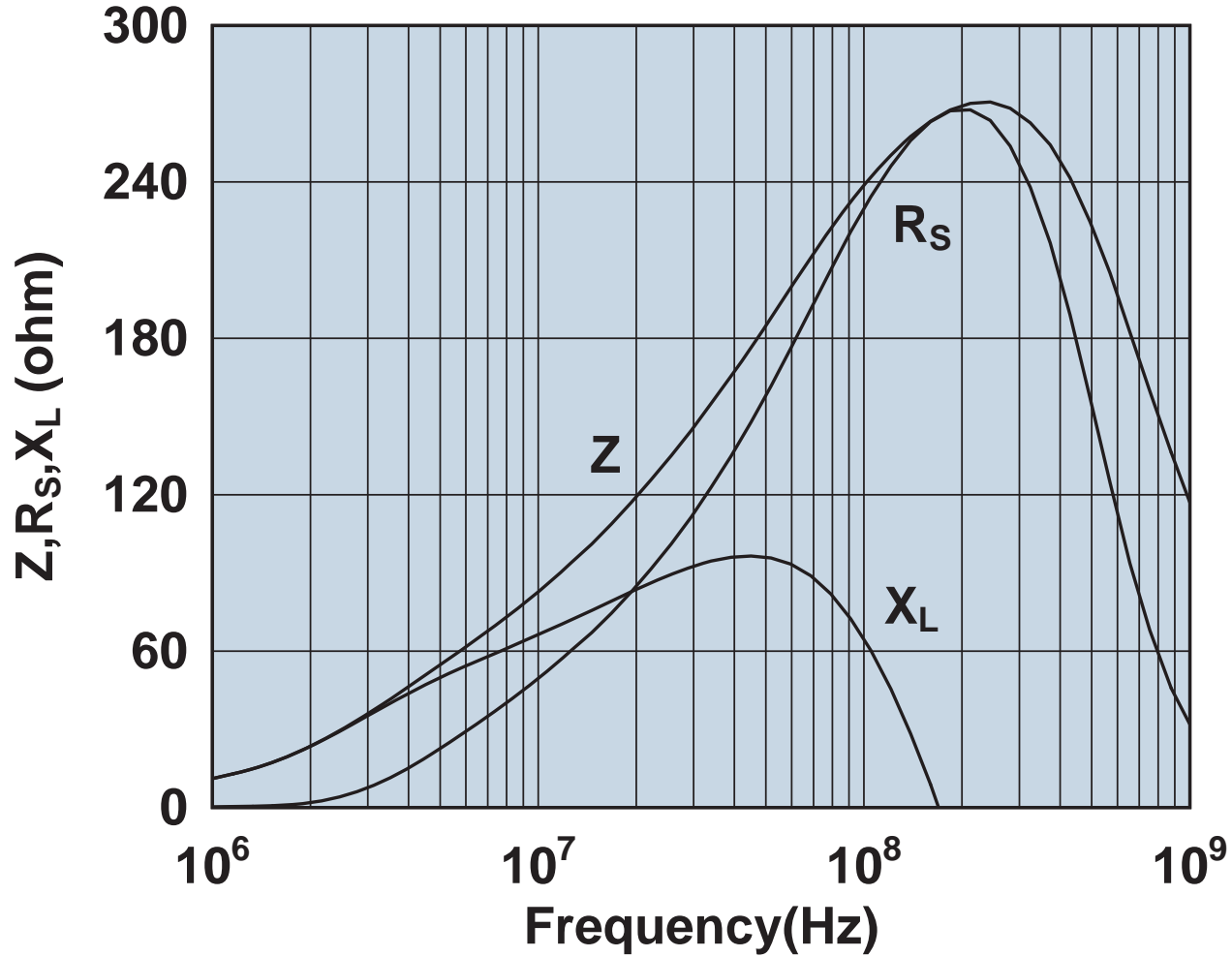

Impedance, reactance, and resistance vs. frequency.

2646164951

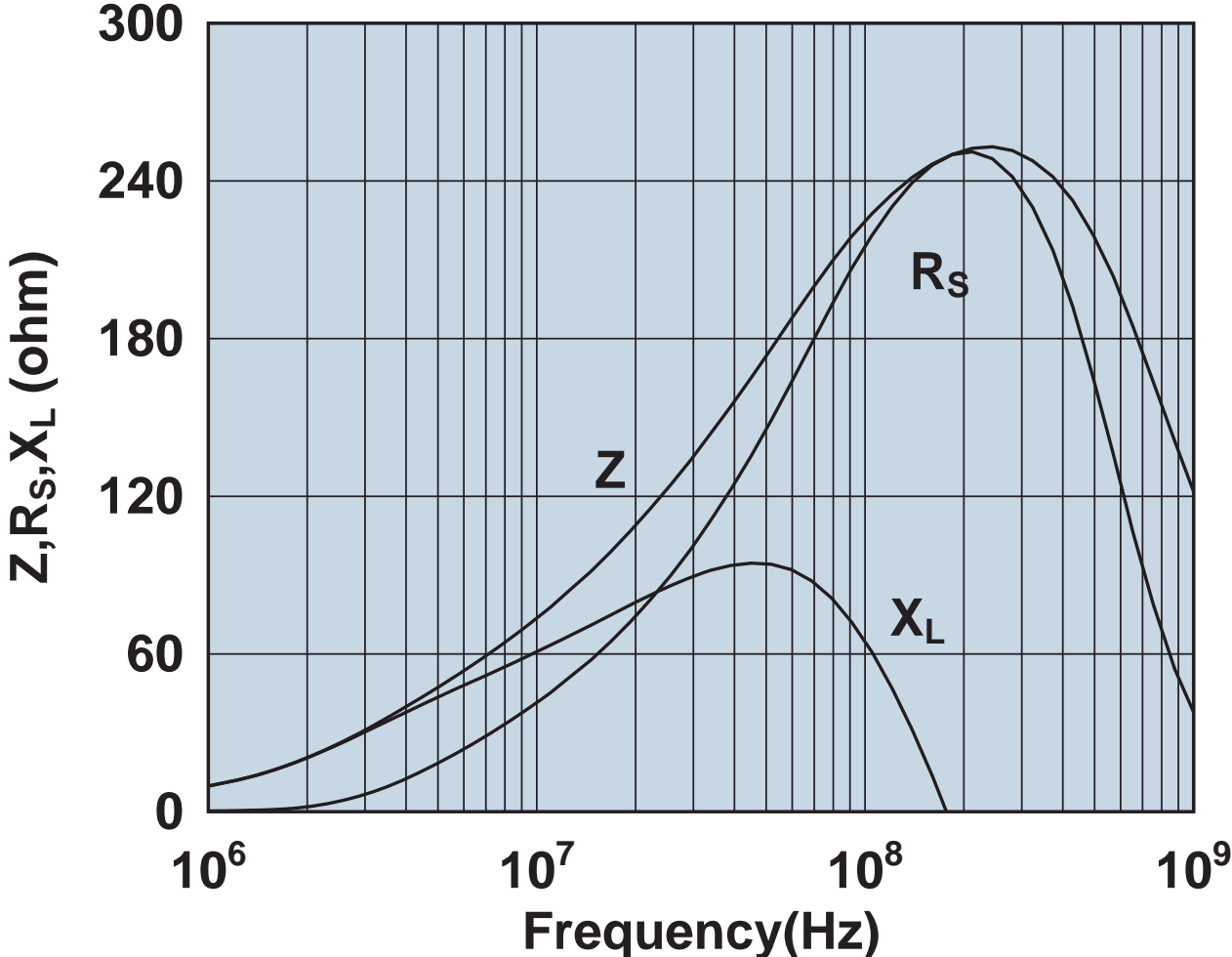

Impedance, reactance, and resistance vs. frequency.

2646167251

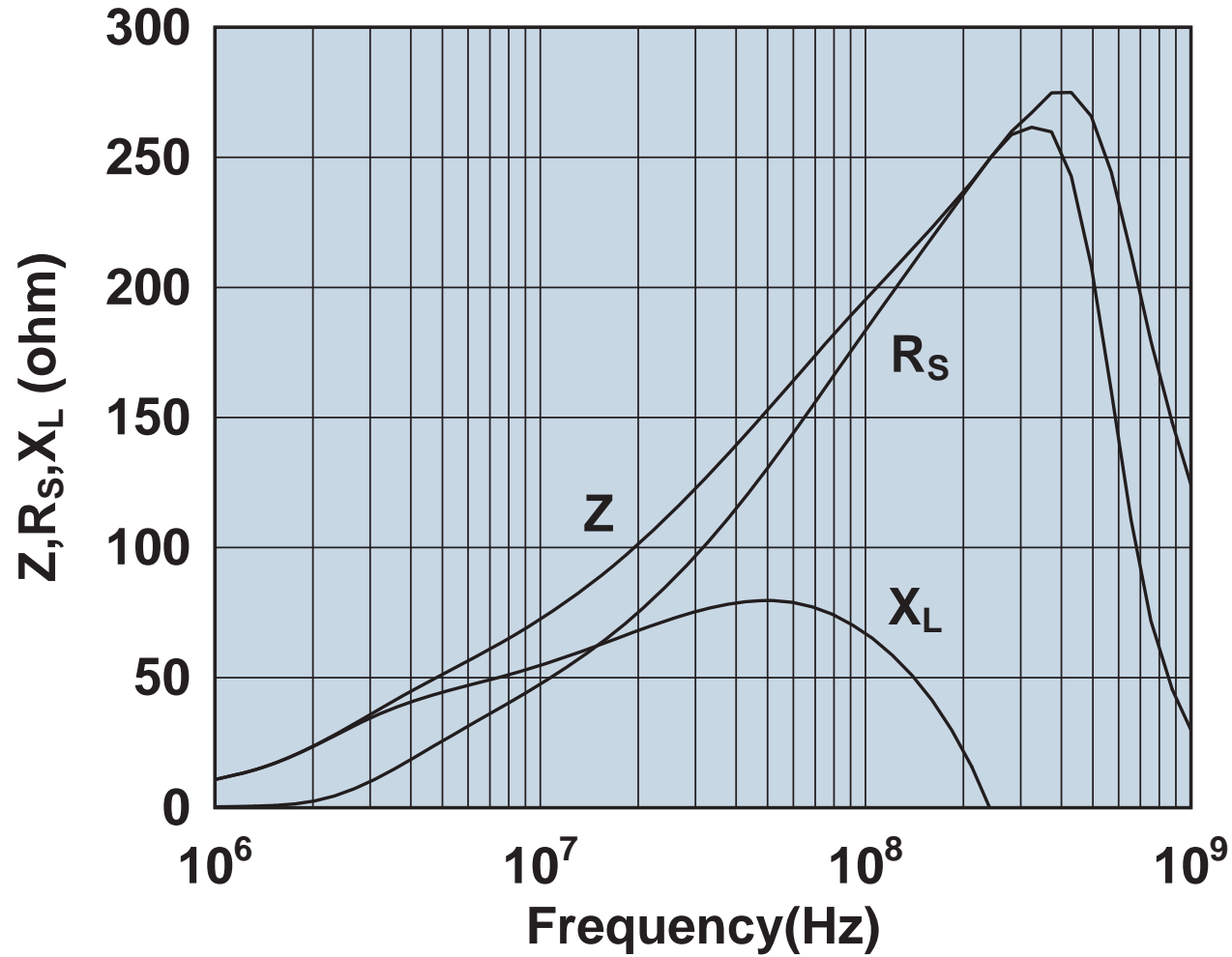

Impedance, reactance, and resistance vs. frequency.

2646167281

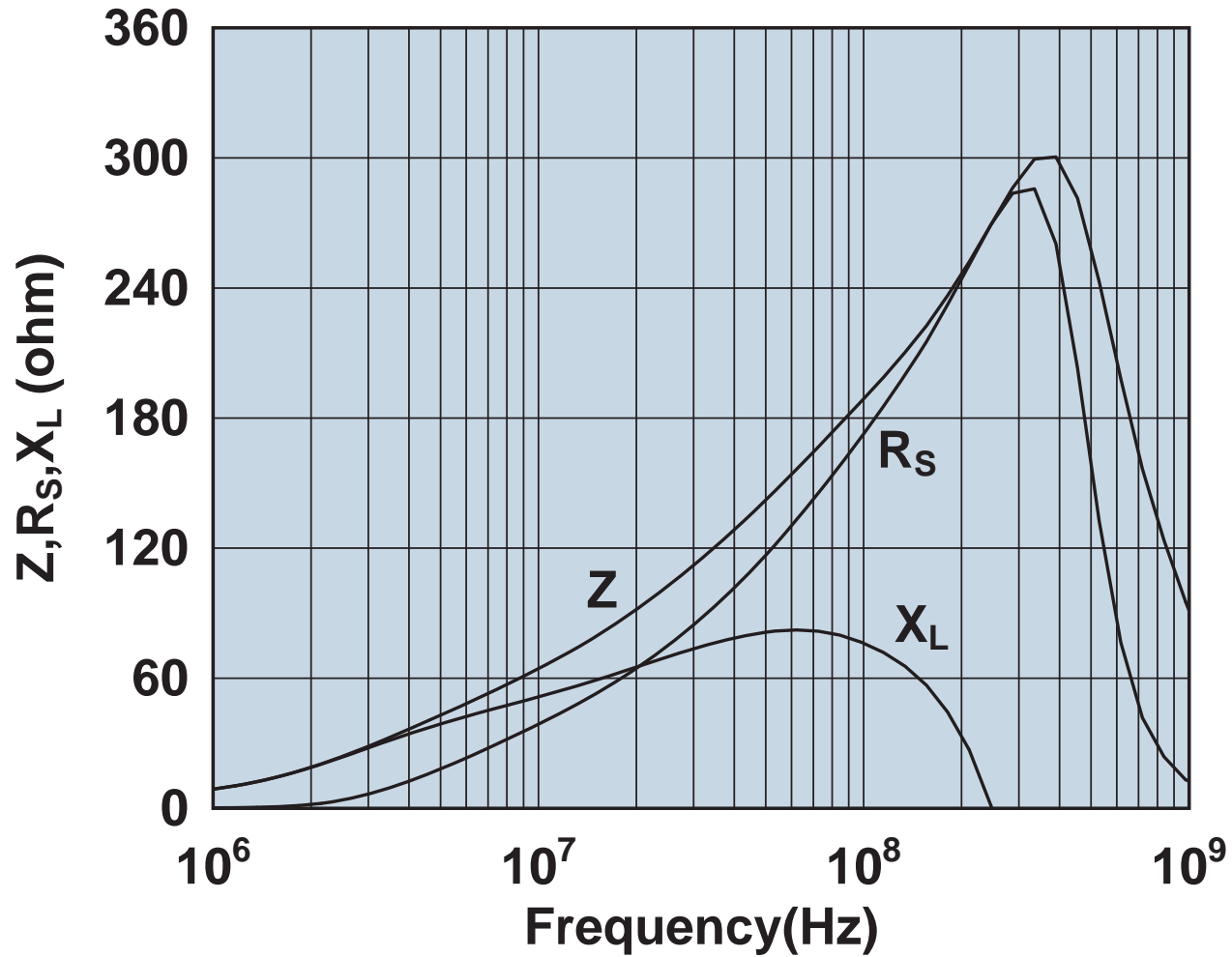

Impedance, reactance, and resistance vs. frequency.

2646173551

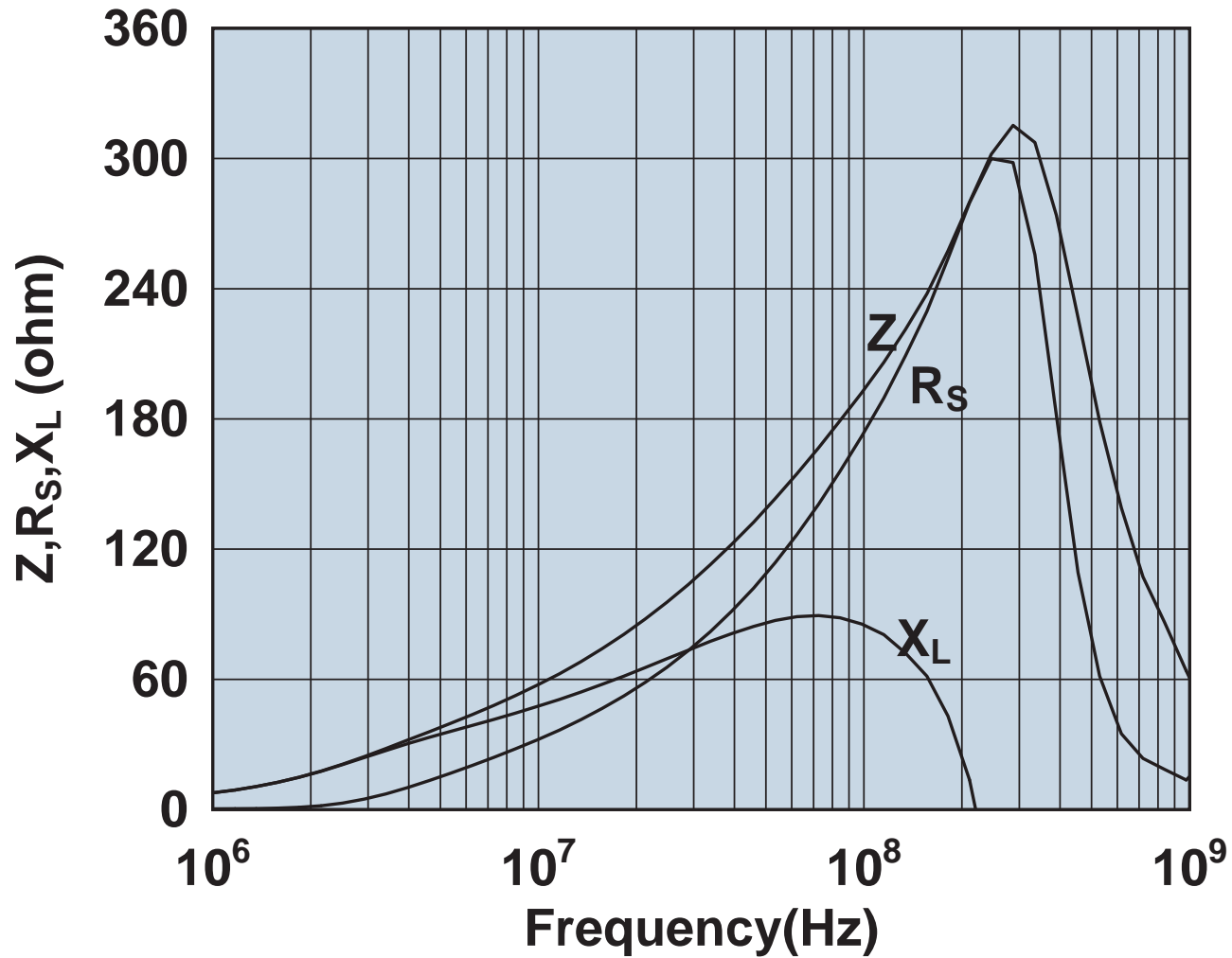

Impedance, reactance, and resistance vs. frequency.

2646173951

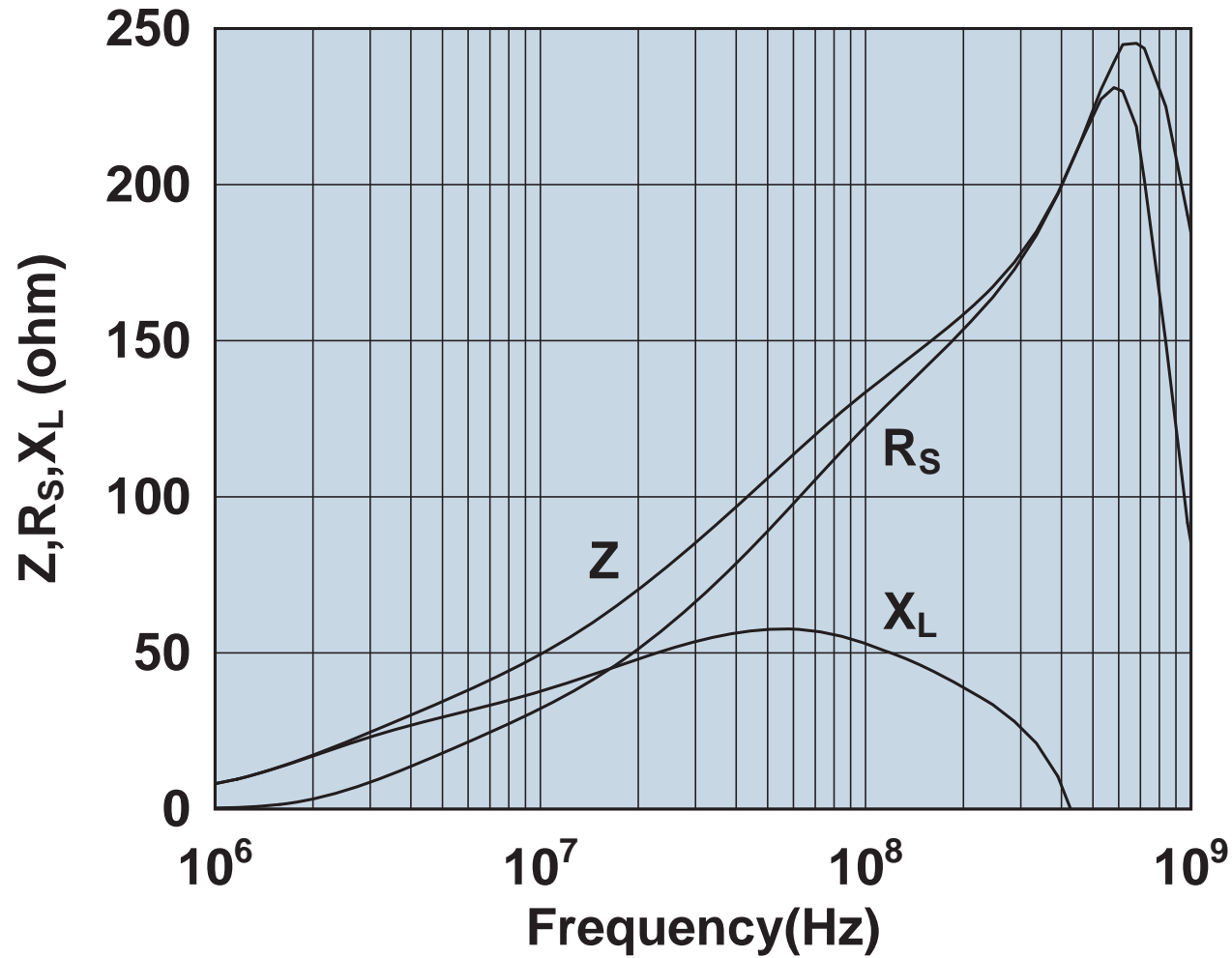

Impedance, reactance, and resistance vs. frequency.

2646176451

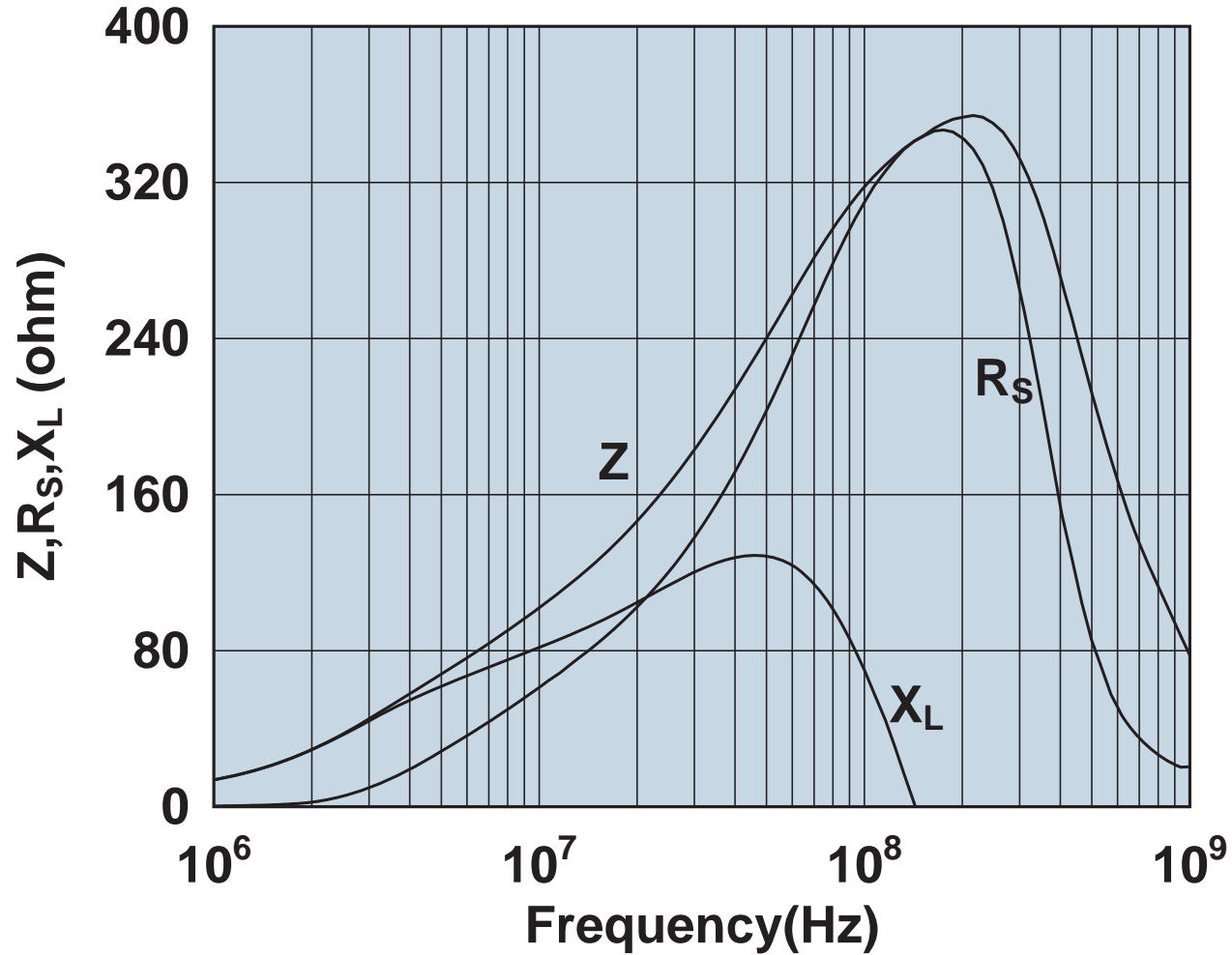

Impedance, reactance, and resistance vs. frequency.

2646177081

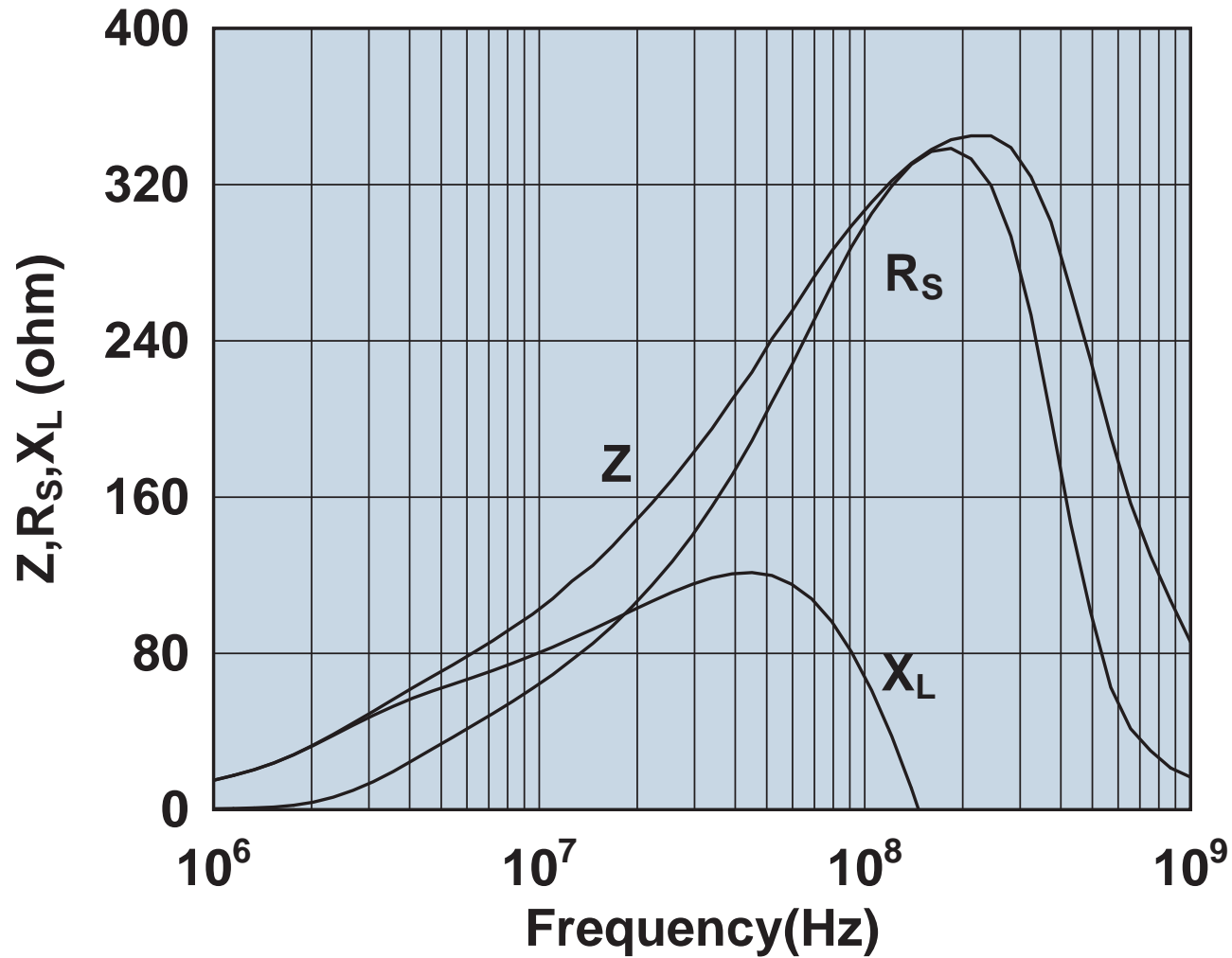

Impedance, reactance, and resistance vs. frequency.

2646480002

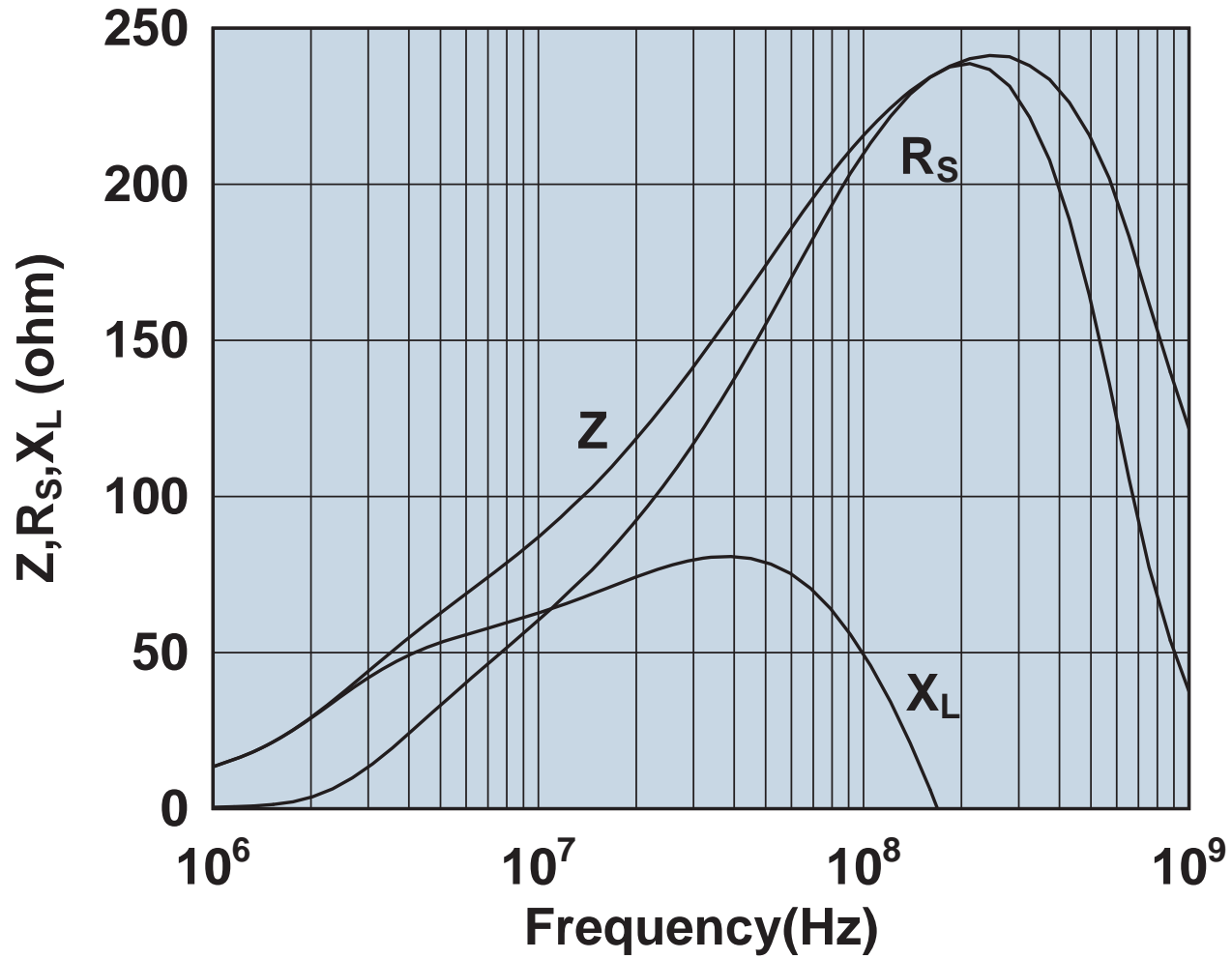

Impedance, reactance, and resistance vs. frequency.

2646480102

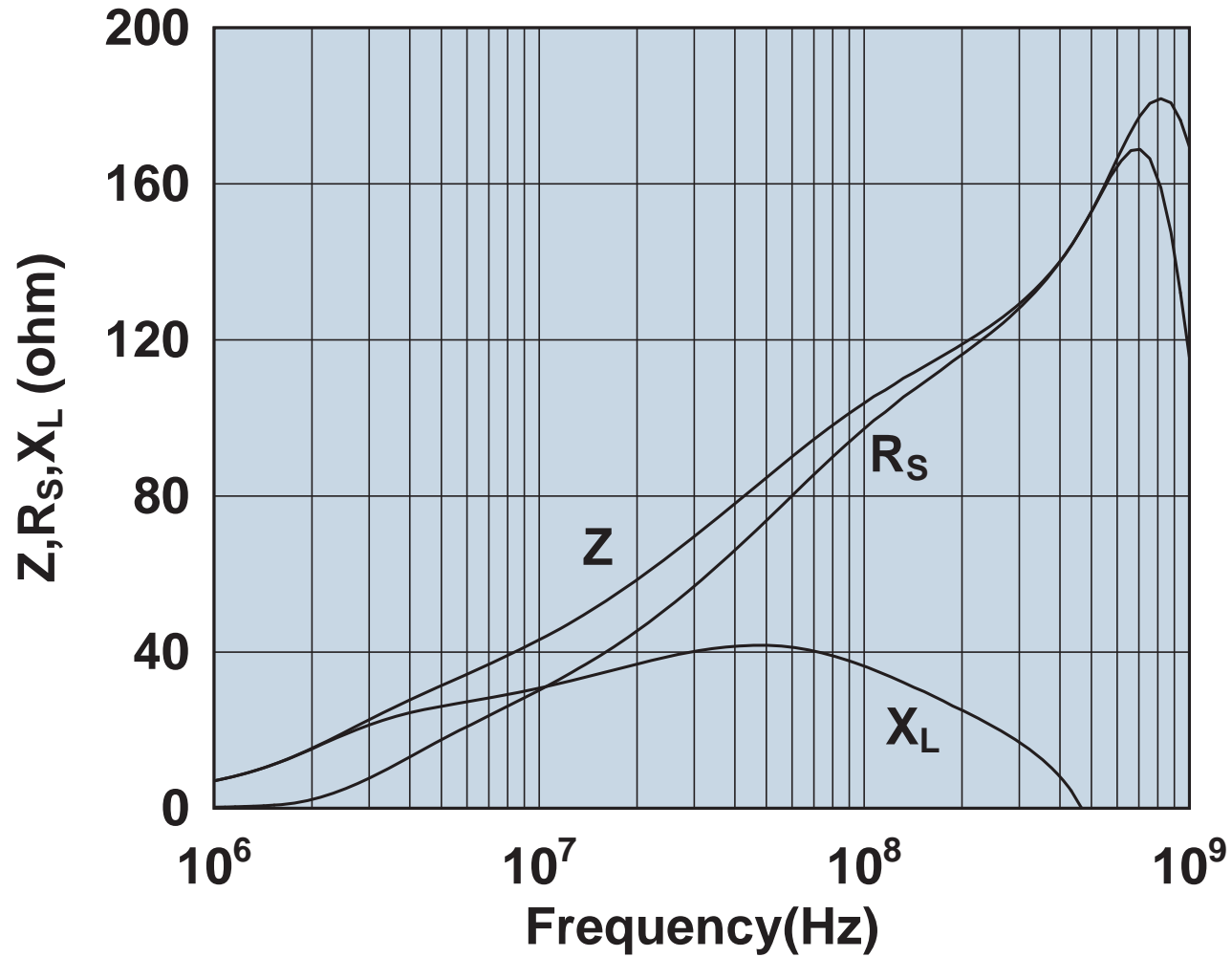

Impedance, reactance, and resistance vs. frequency.

2646540002

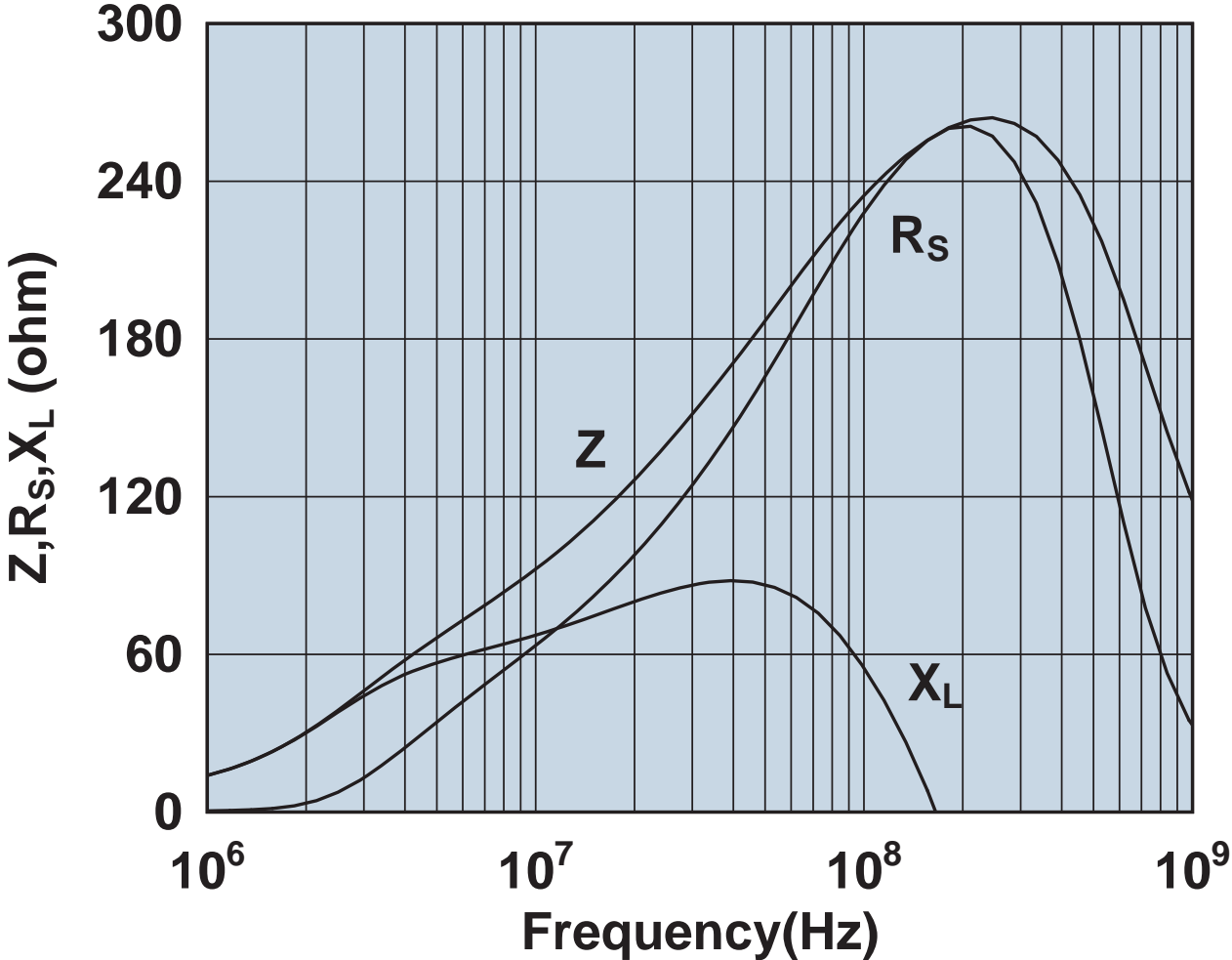

Impedance, reactance, and resistance vs. frequency.

2646540202

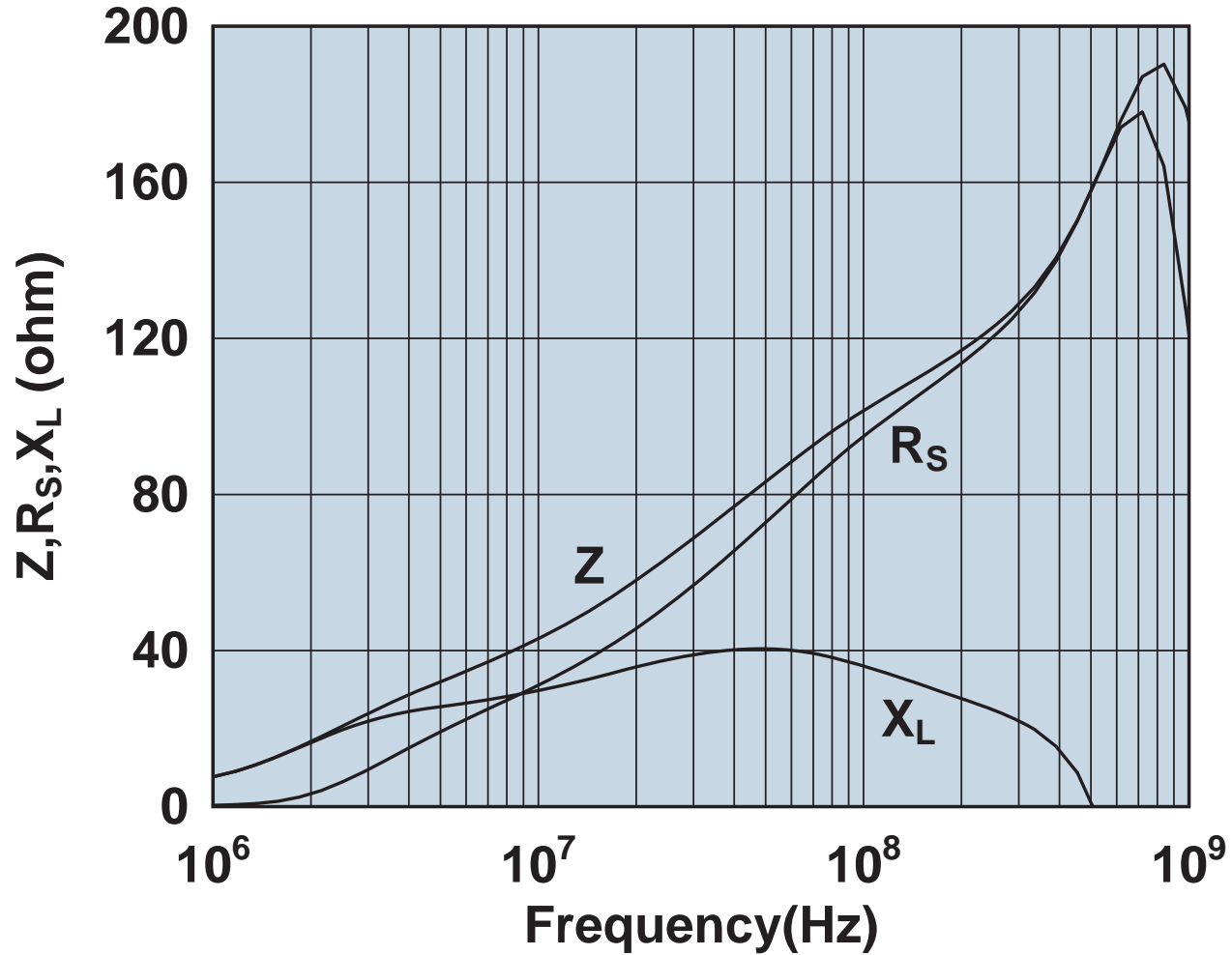

Impedance, reactance, and resistance vs. frequency.

2646625002

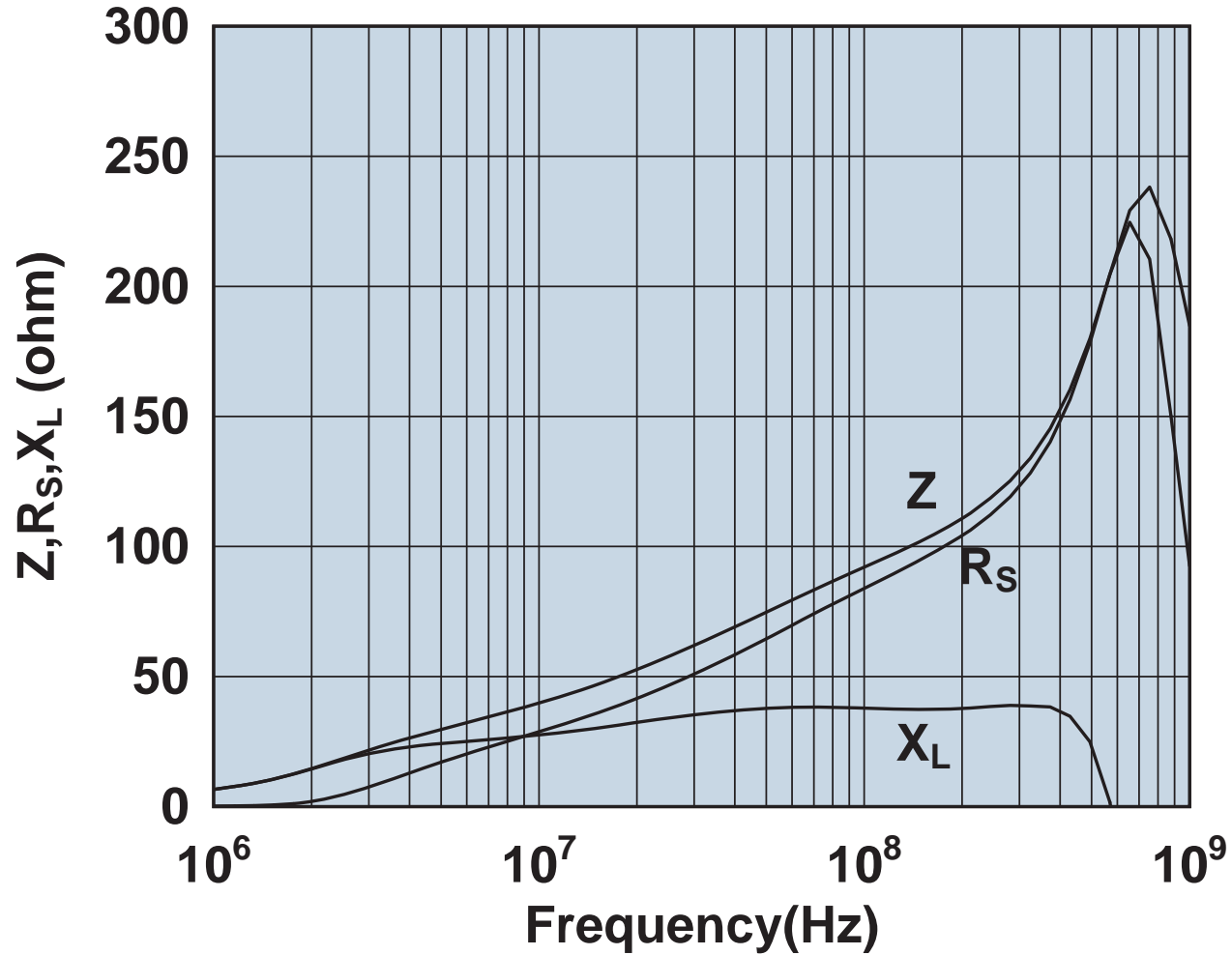

Impedance, reactance, and resistance vs. frequency.

2646625102

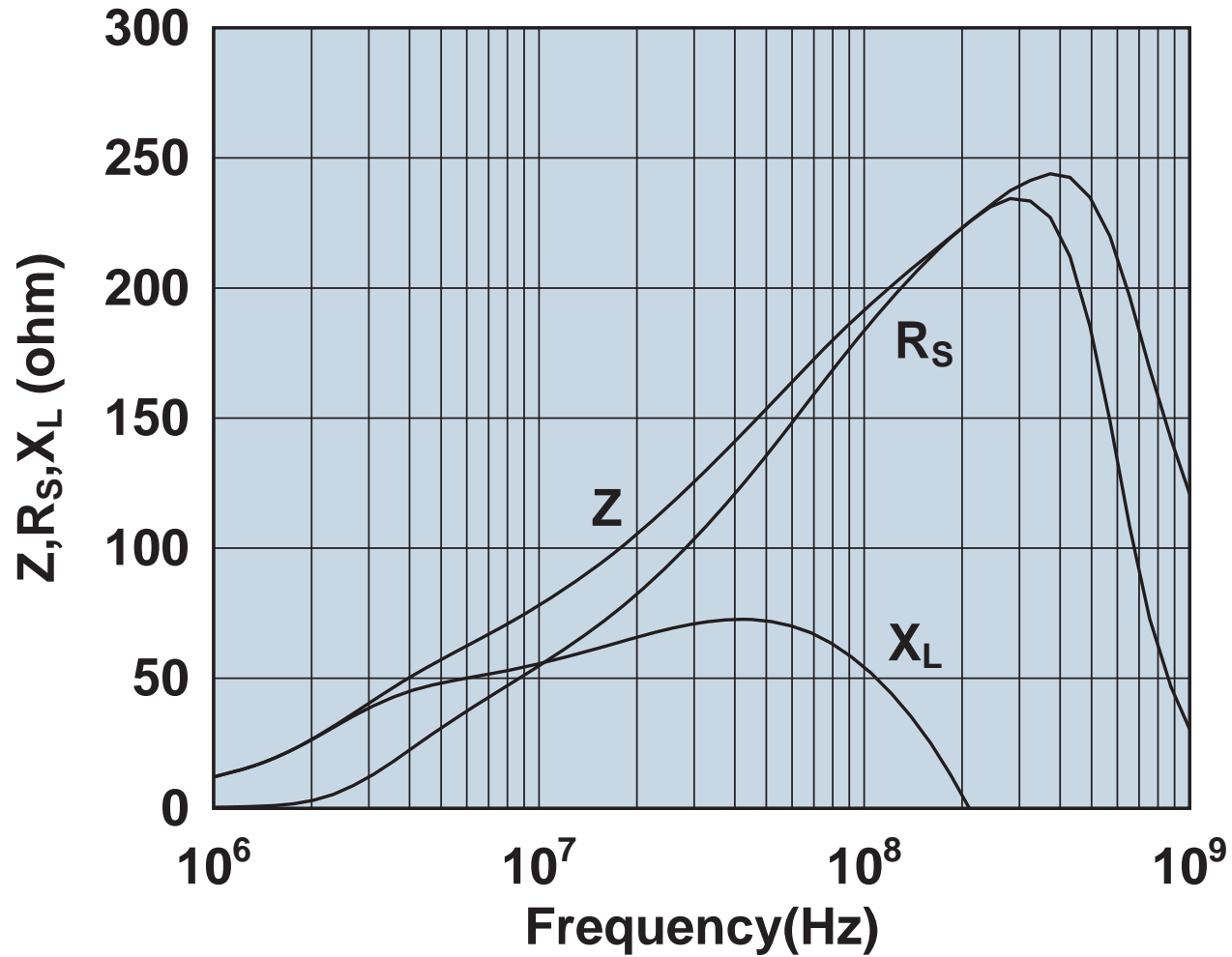

Impedance, reactance, and resistance vs. frequency.

2646625202

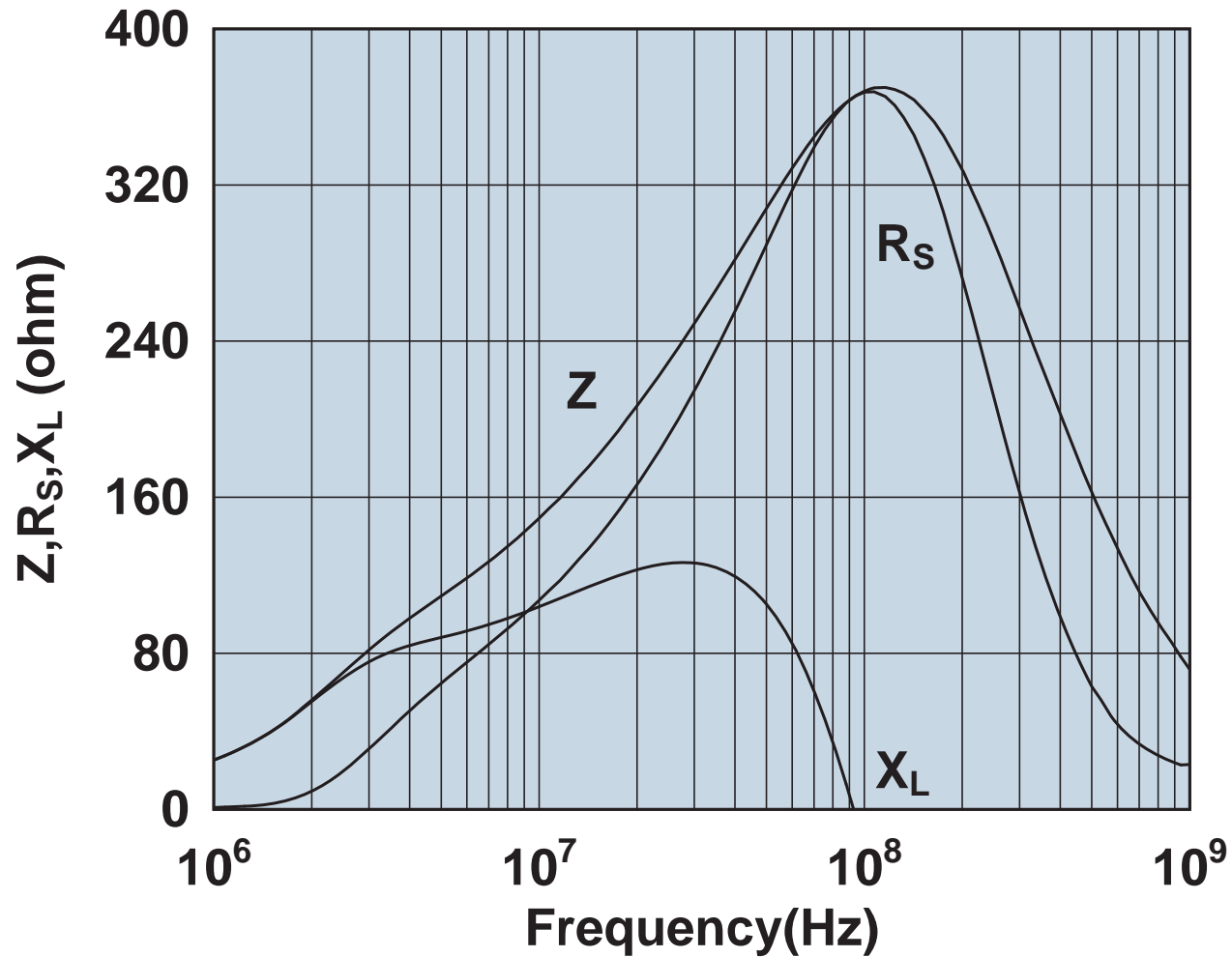

Impedance, reactance, and resistance vs. frequency.

2646626202

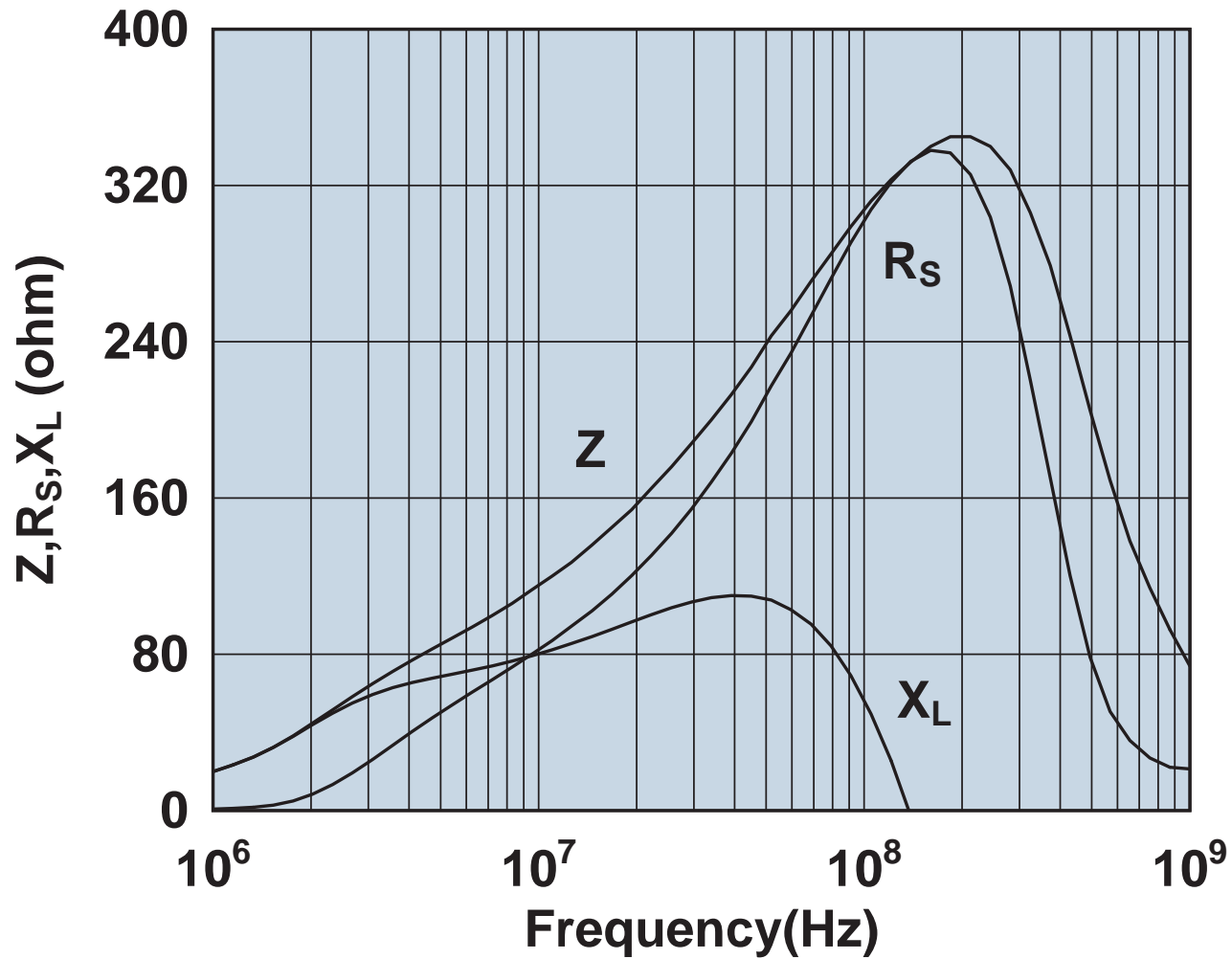

Impedance, reactance, and resistance vs. frequency.

2646665702

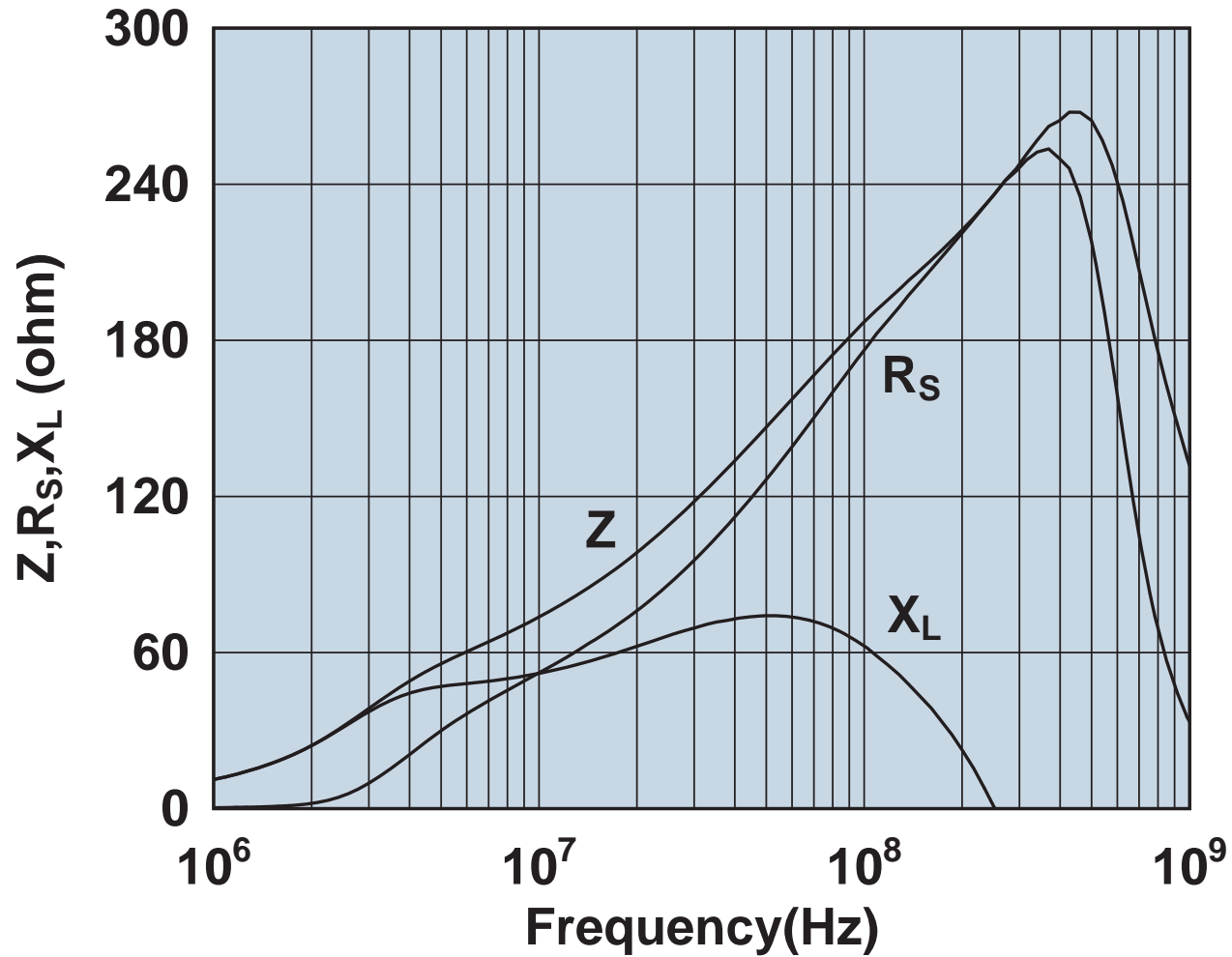

Impedance, reactance, and resistance vs. frequency.

2646665802

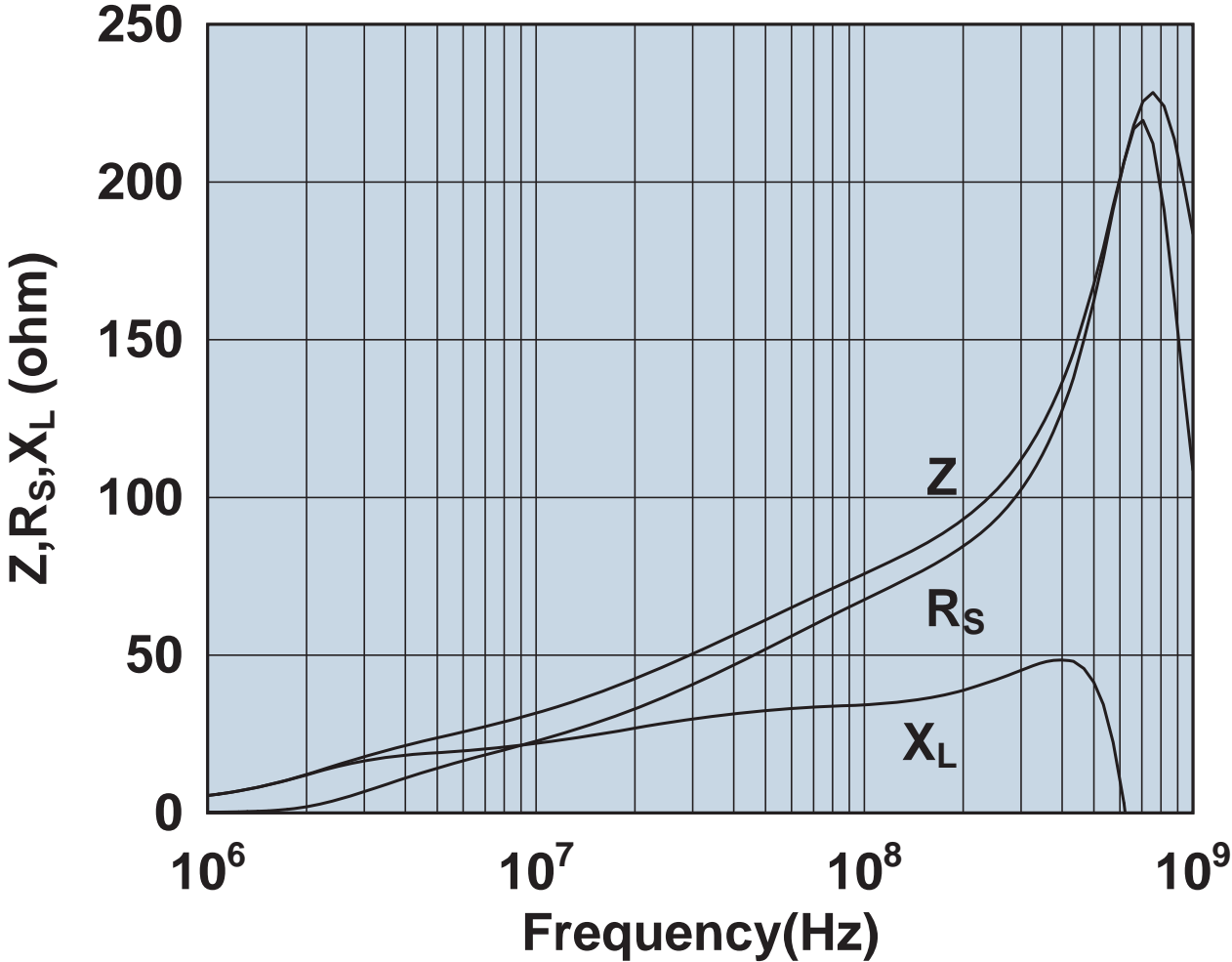

Impedance, reactance, and resistance vs. frequency.

2646803802

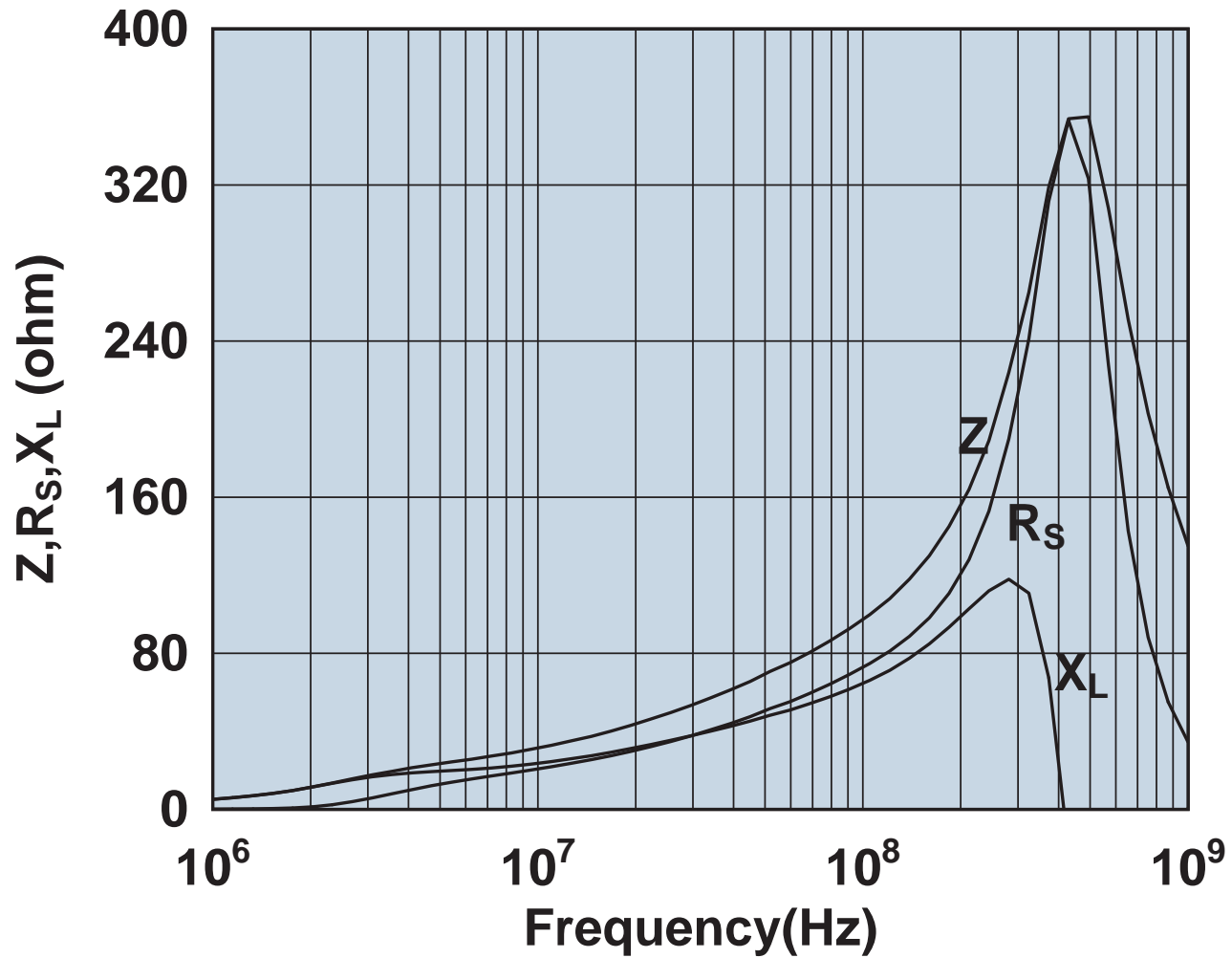

Impedance, reactance, and resistance vs. frequency.

2646804502

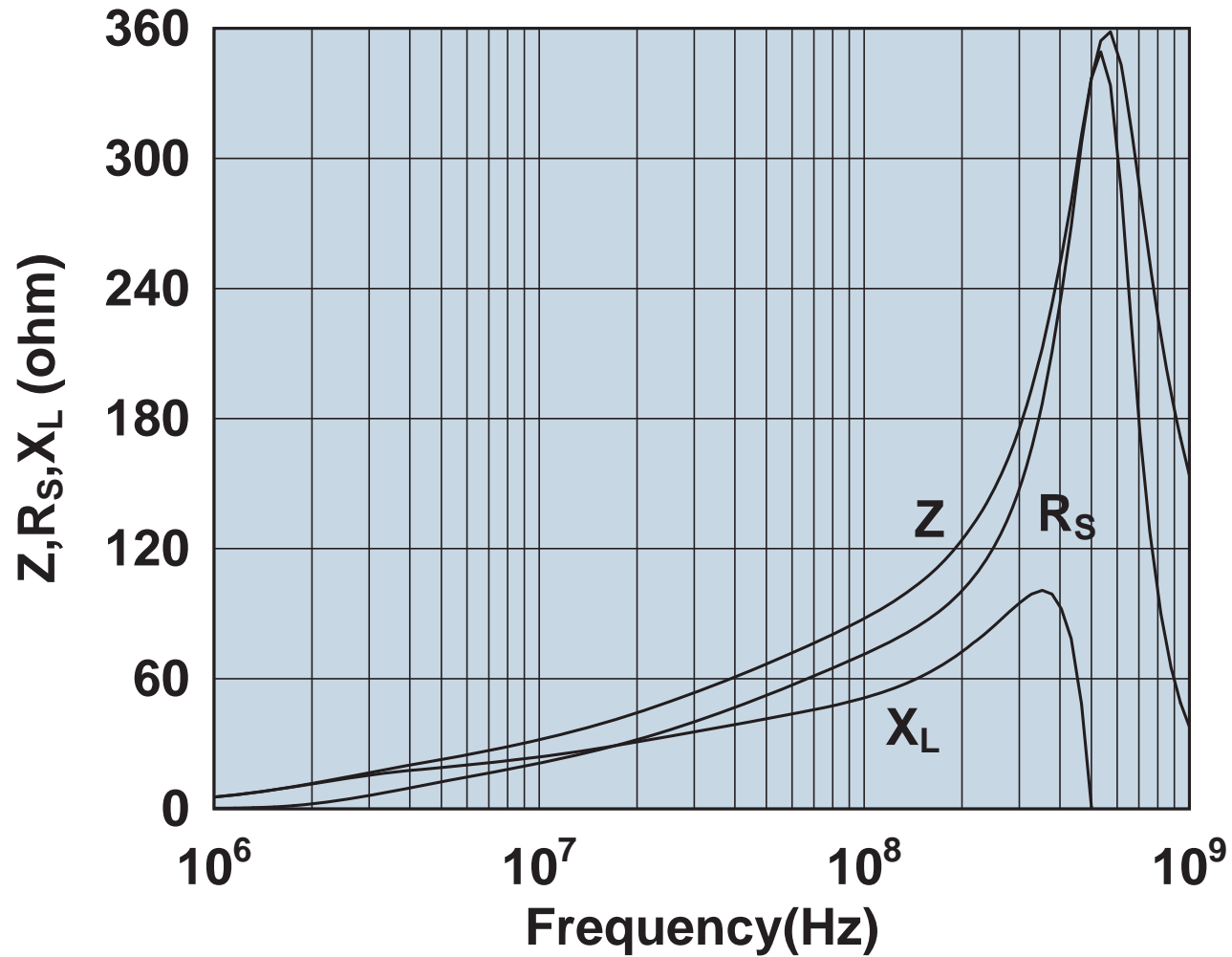

Impedance, reactance, and resistance vs. frequency.

2661102002

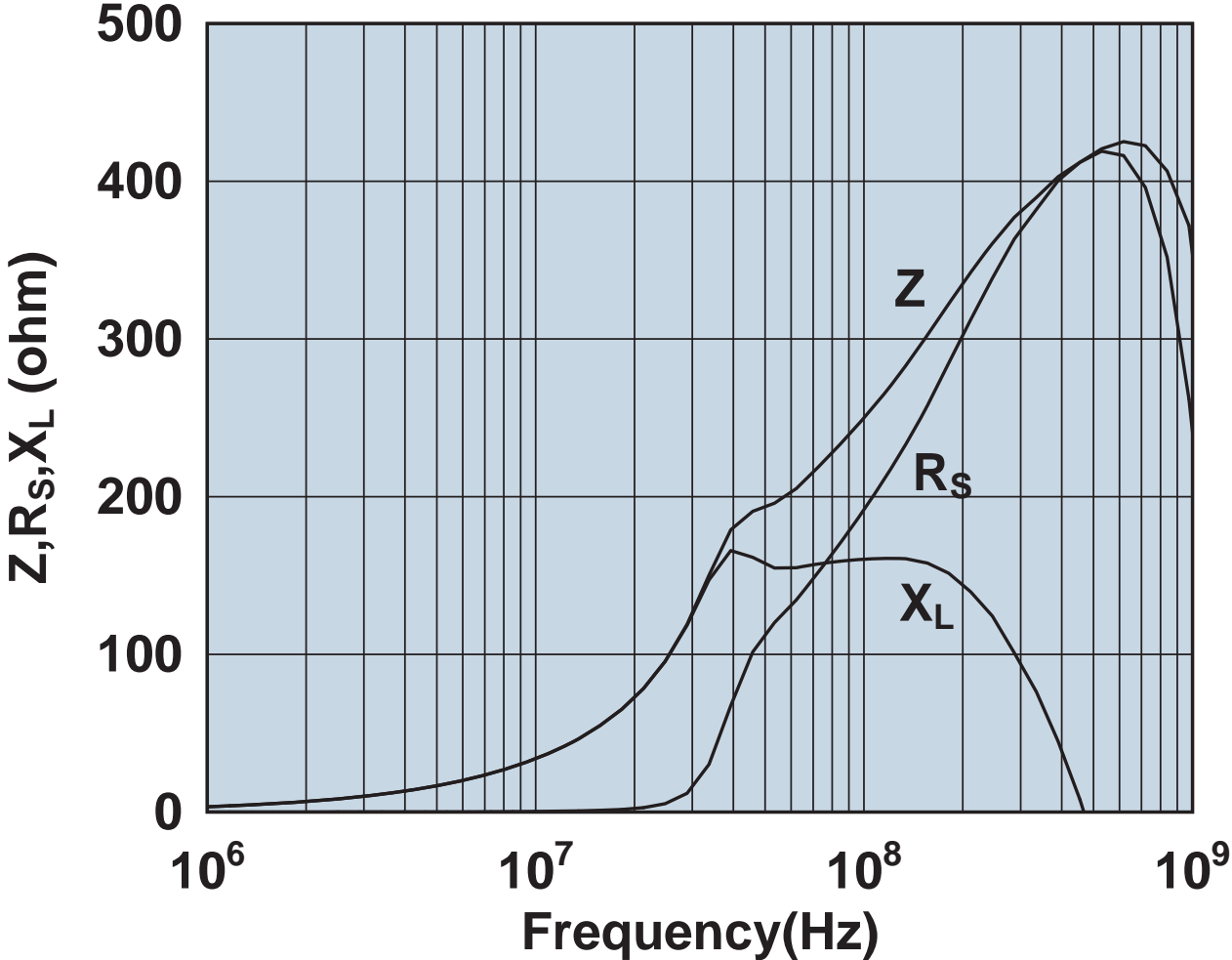

Impedance, reactance, and resistance vs. frequency.

2661102402

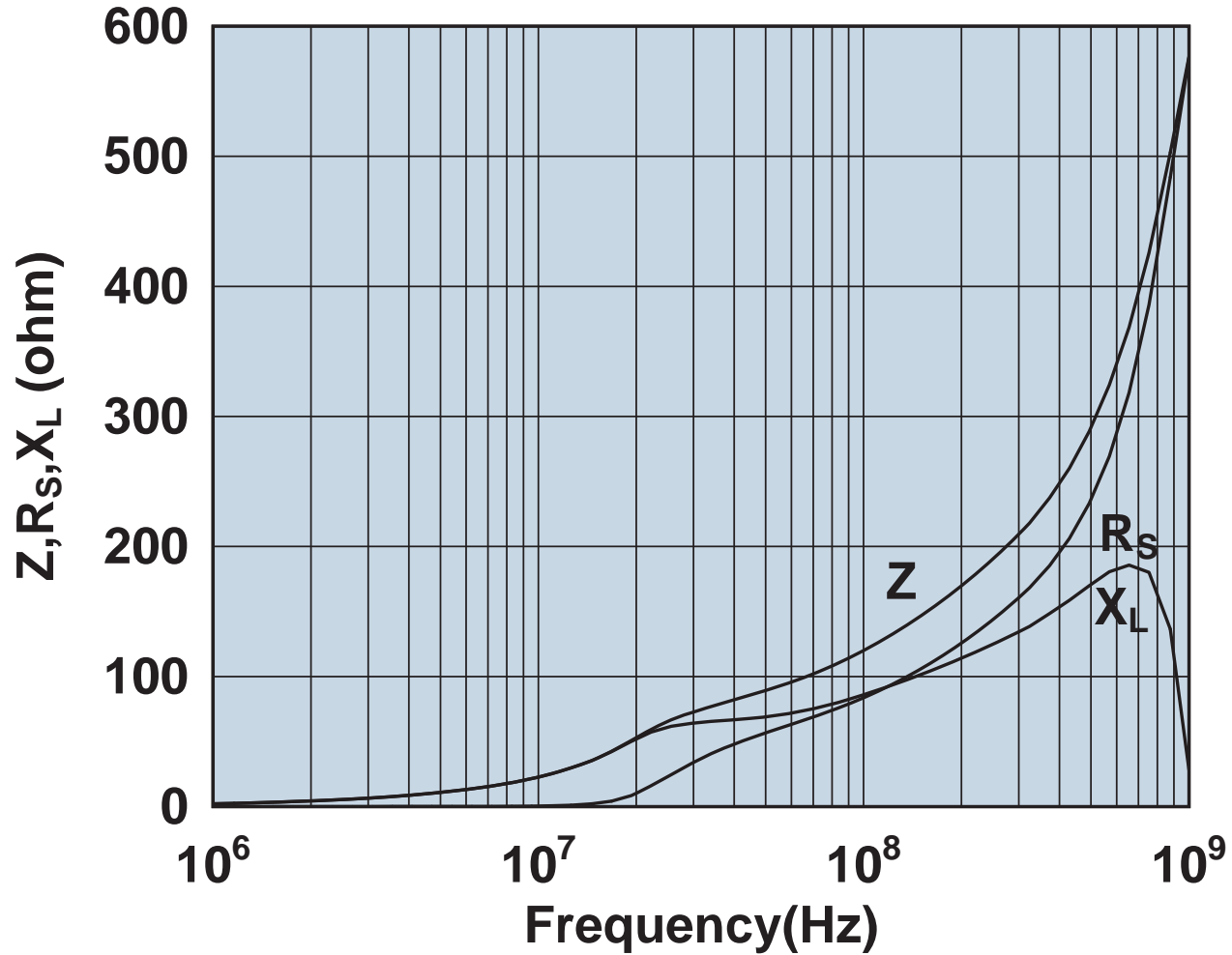

Impedance, reactance, and resistance vs. frequency.

2661164181

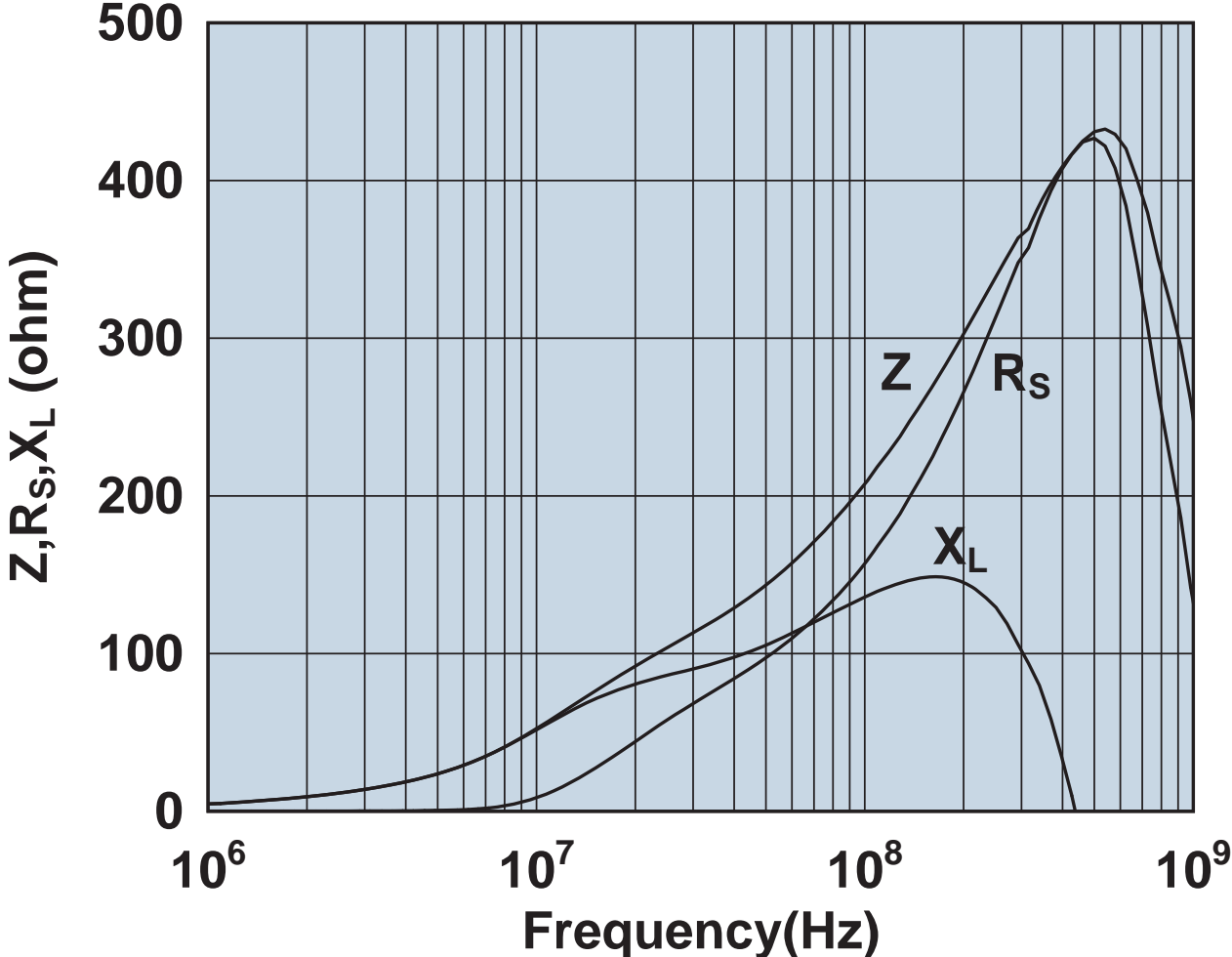

Impedance, reactance, and resistance vs. frequency.

2661164281

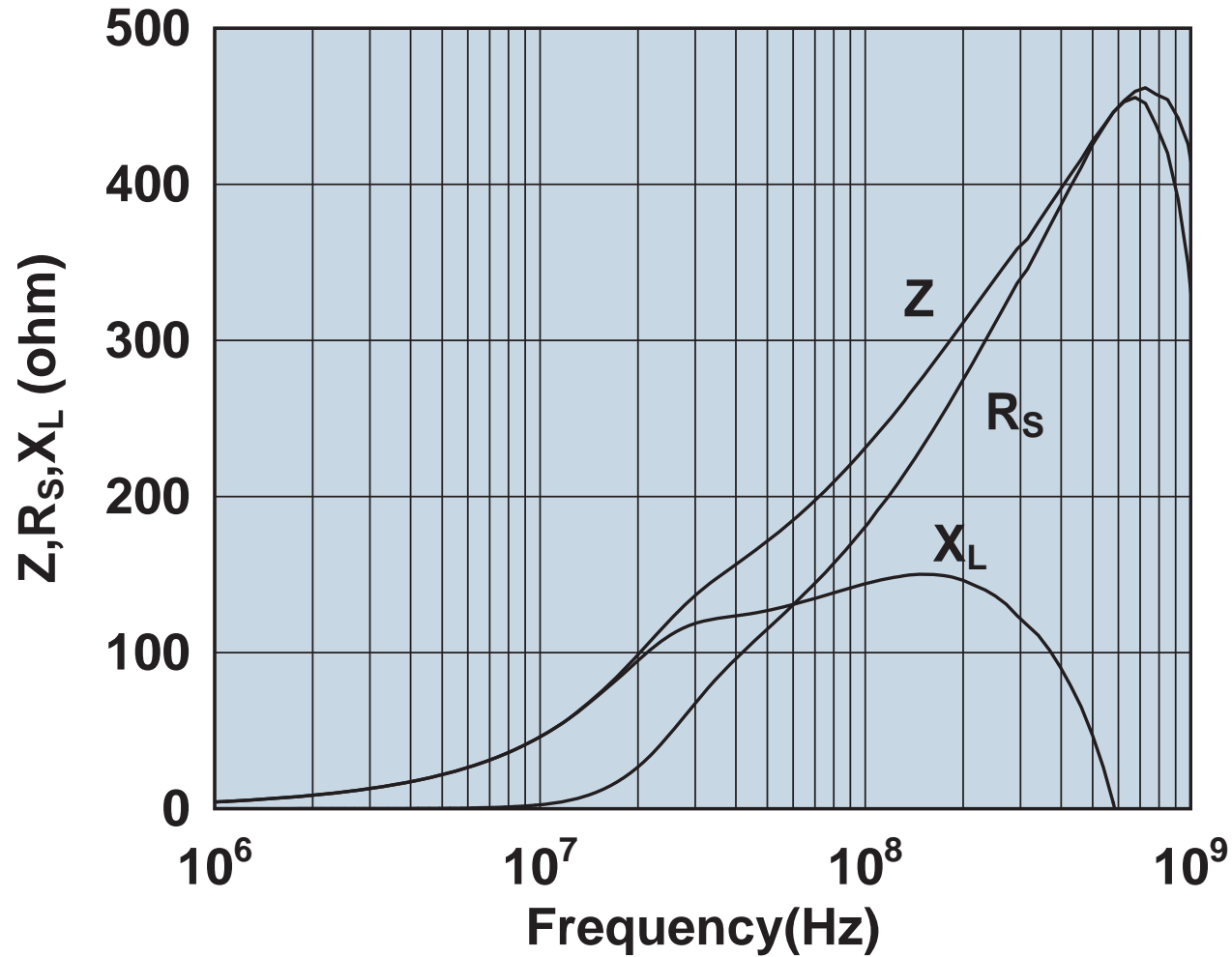

Impedance, reactance, and resistance vs. frequency.

2661164951

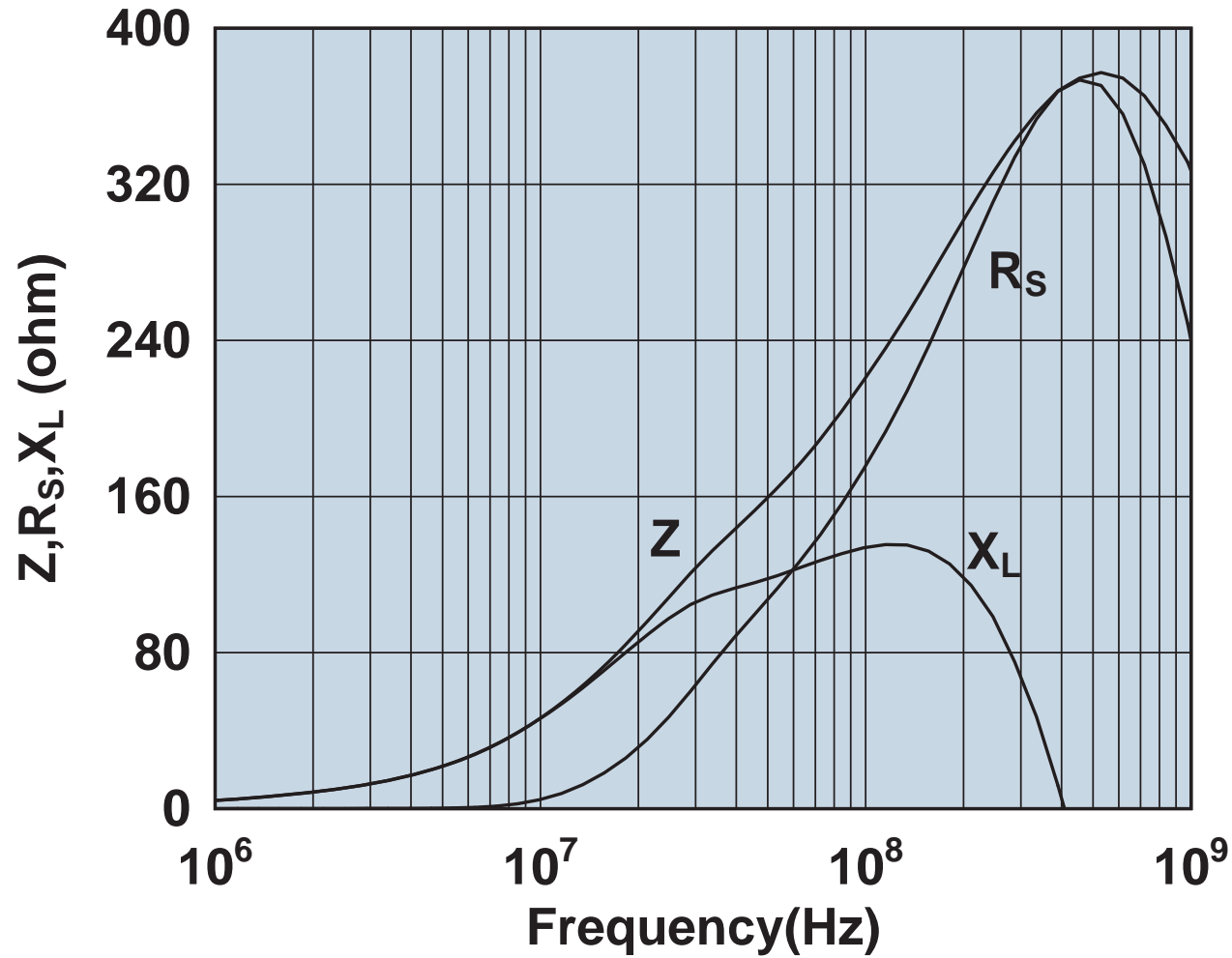

Impedance, reactance, and resistance vs. frequency.

2661167281

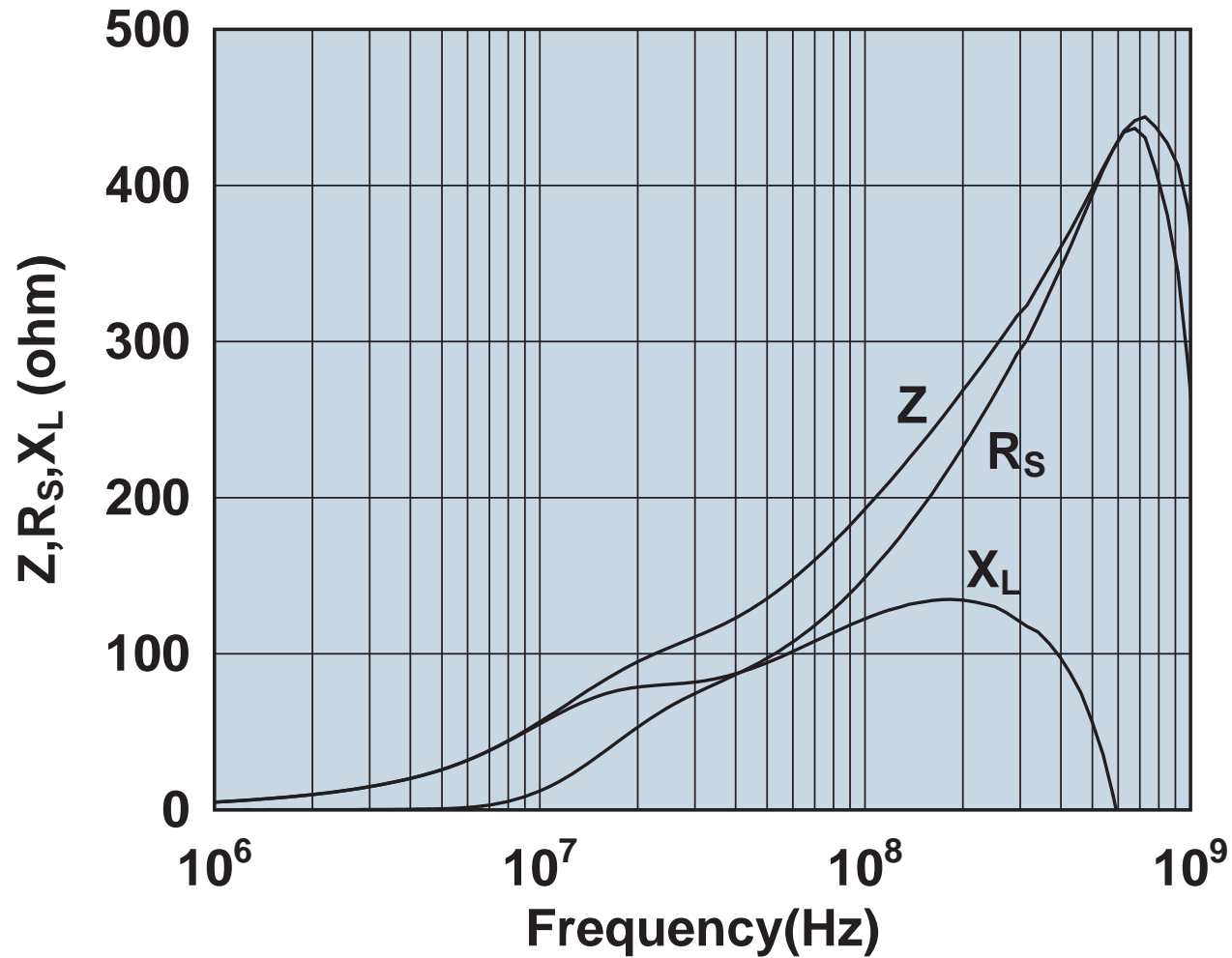

Impedance, reactance, and resistance vs. frequency.

2661176451

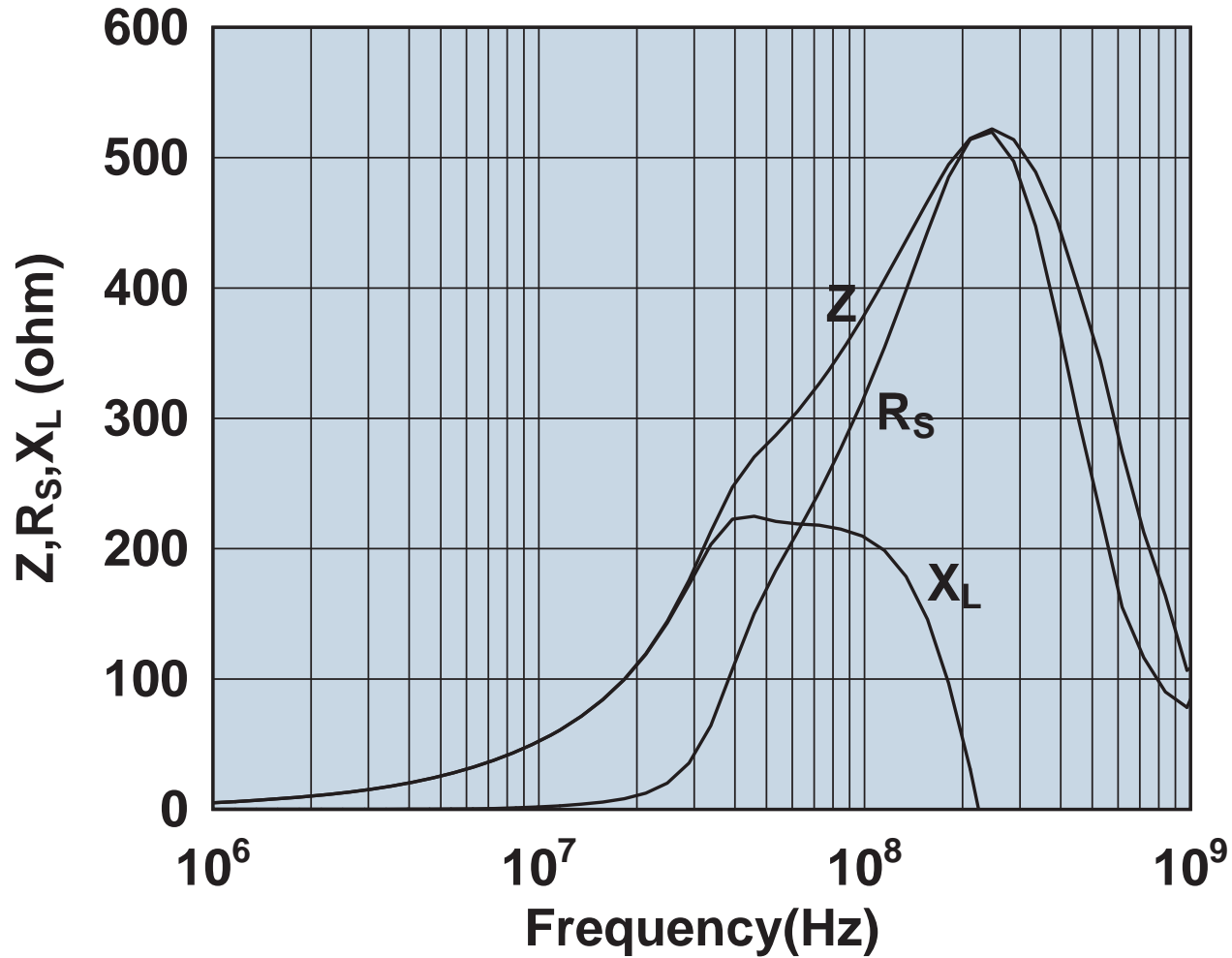

Impedance, reactance, and resistance vs. frequency.

2661178181

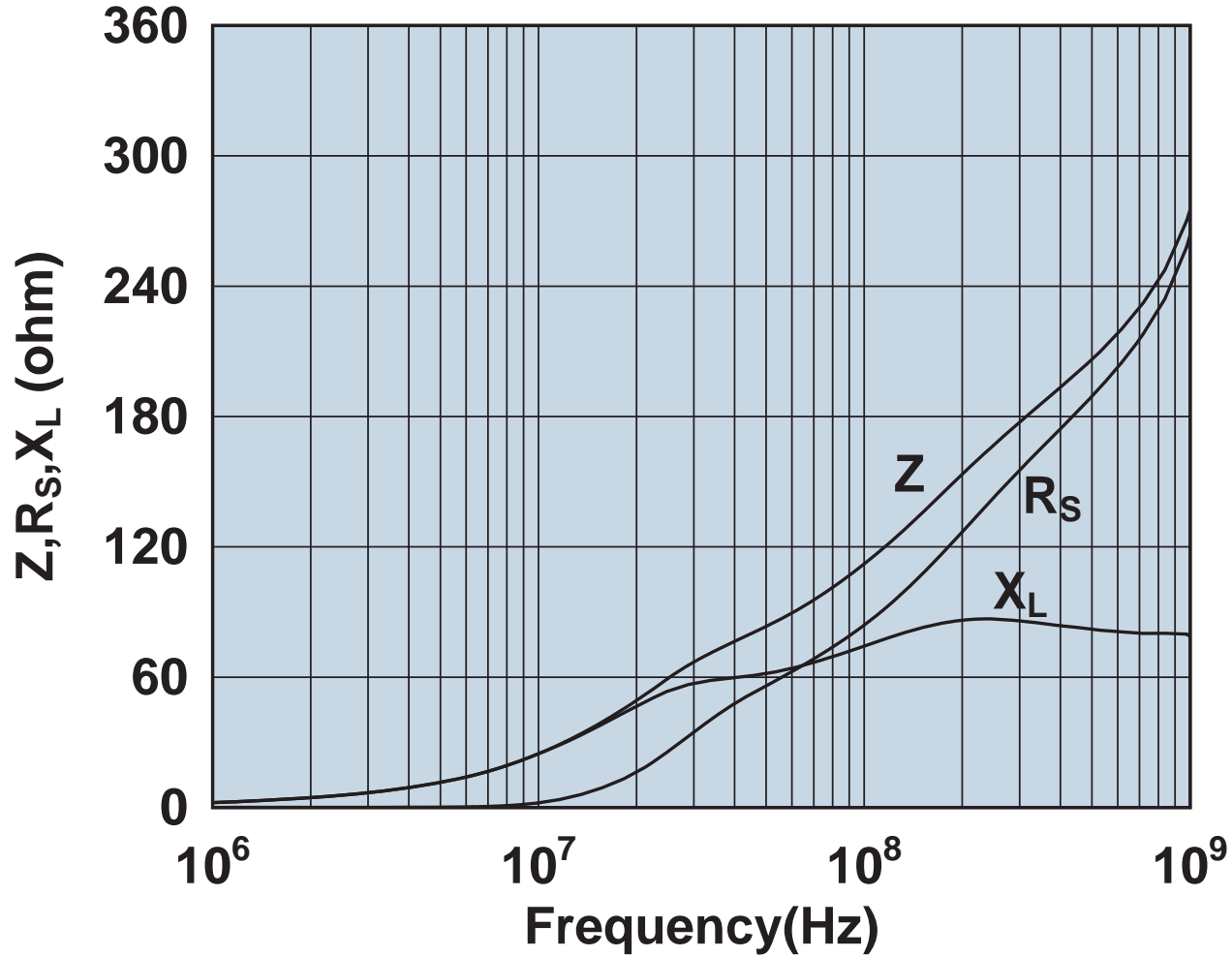

Impedance, reactance, and resistance vs. frequency.

2661178281

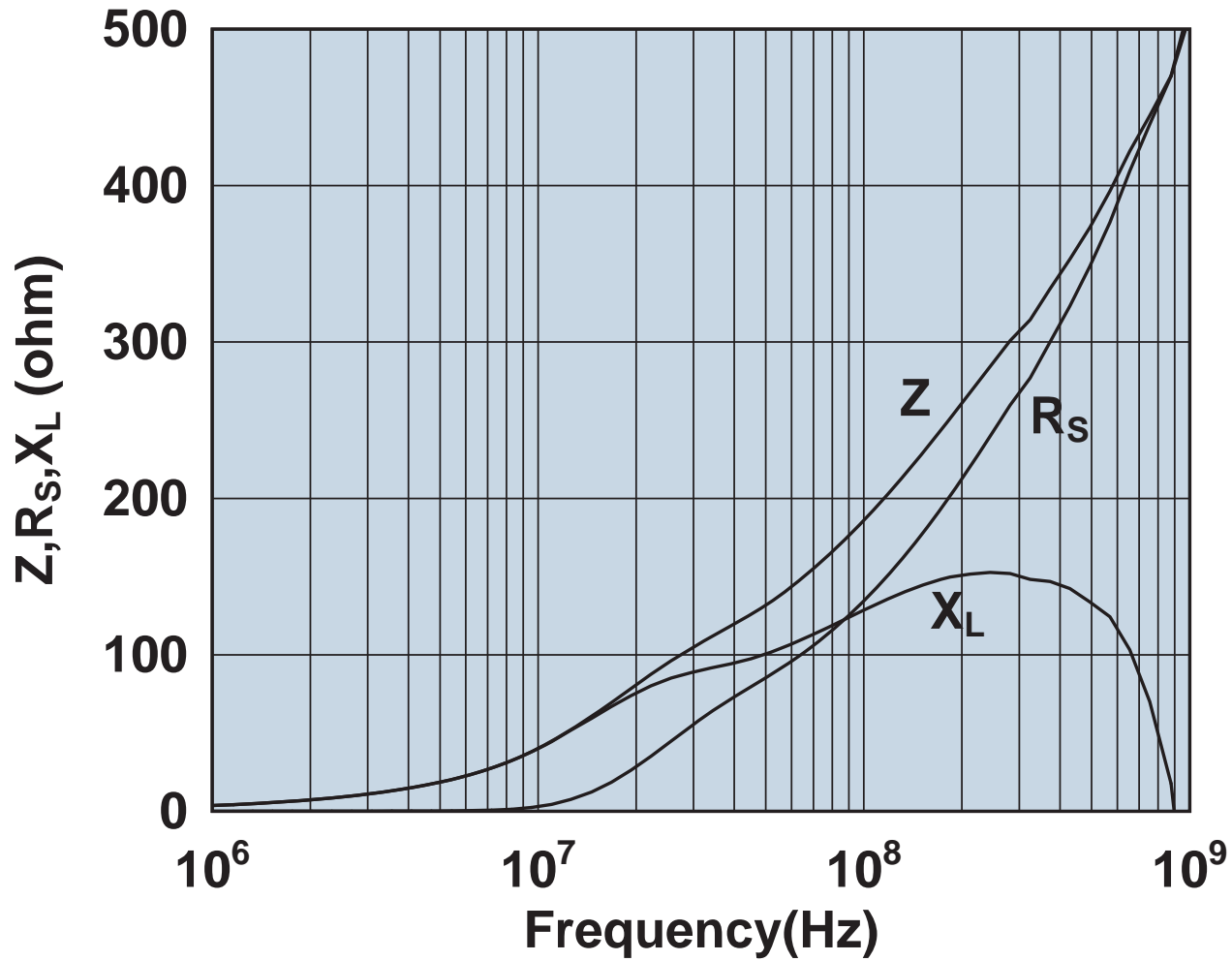

Impedance, reactance, and resistance vs. frequency.

2661540002

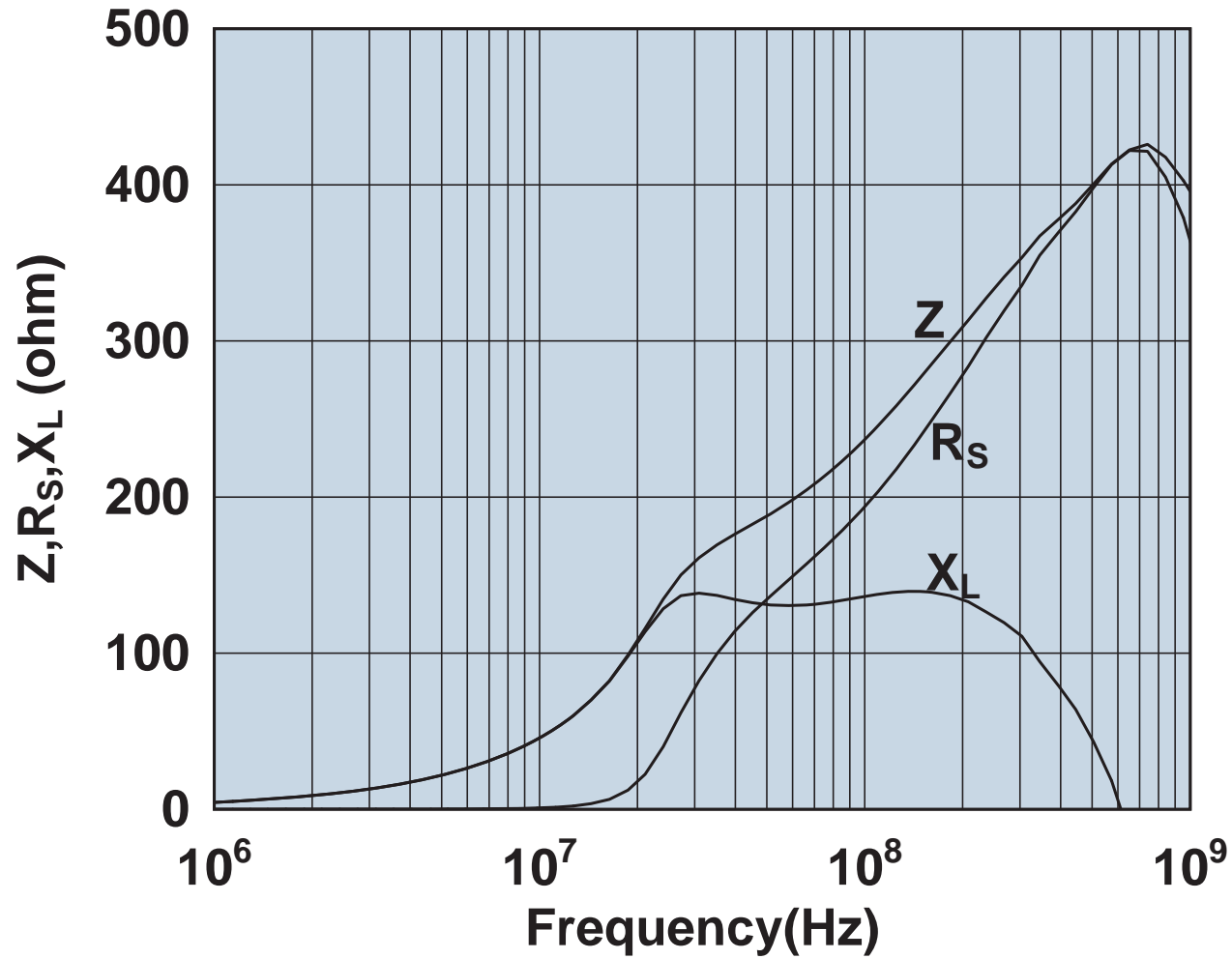

Impedance, reactance, and resistance vs. frequency.

2661540202

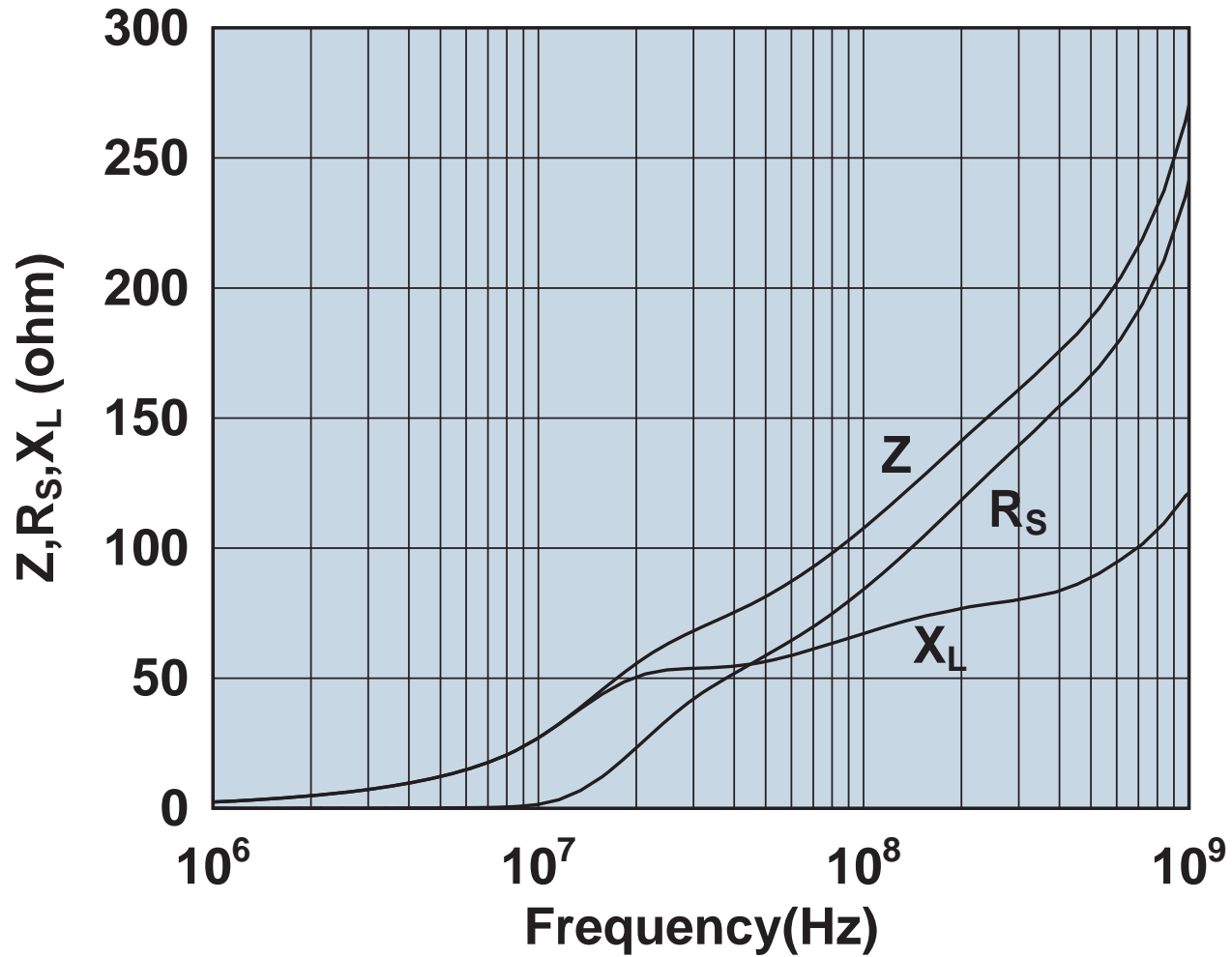

Impedance, reactance, and resistance vs. frequency.

2661626302

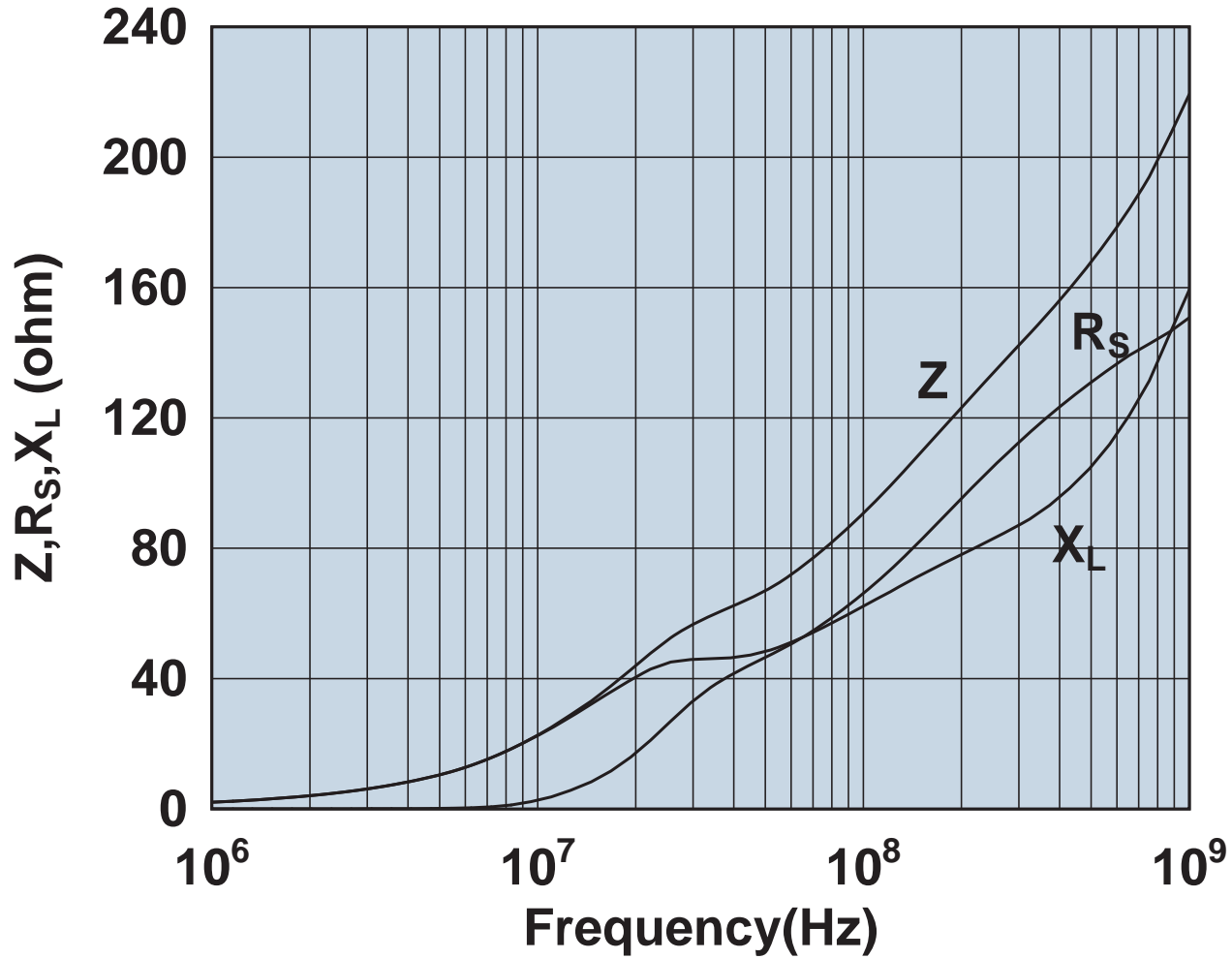

Impedance, reactance, and resistance vs. frequency.

2661626402

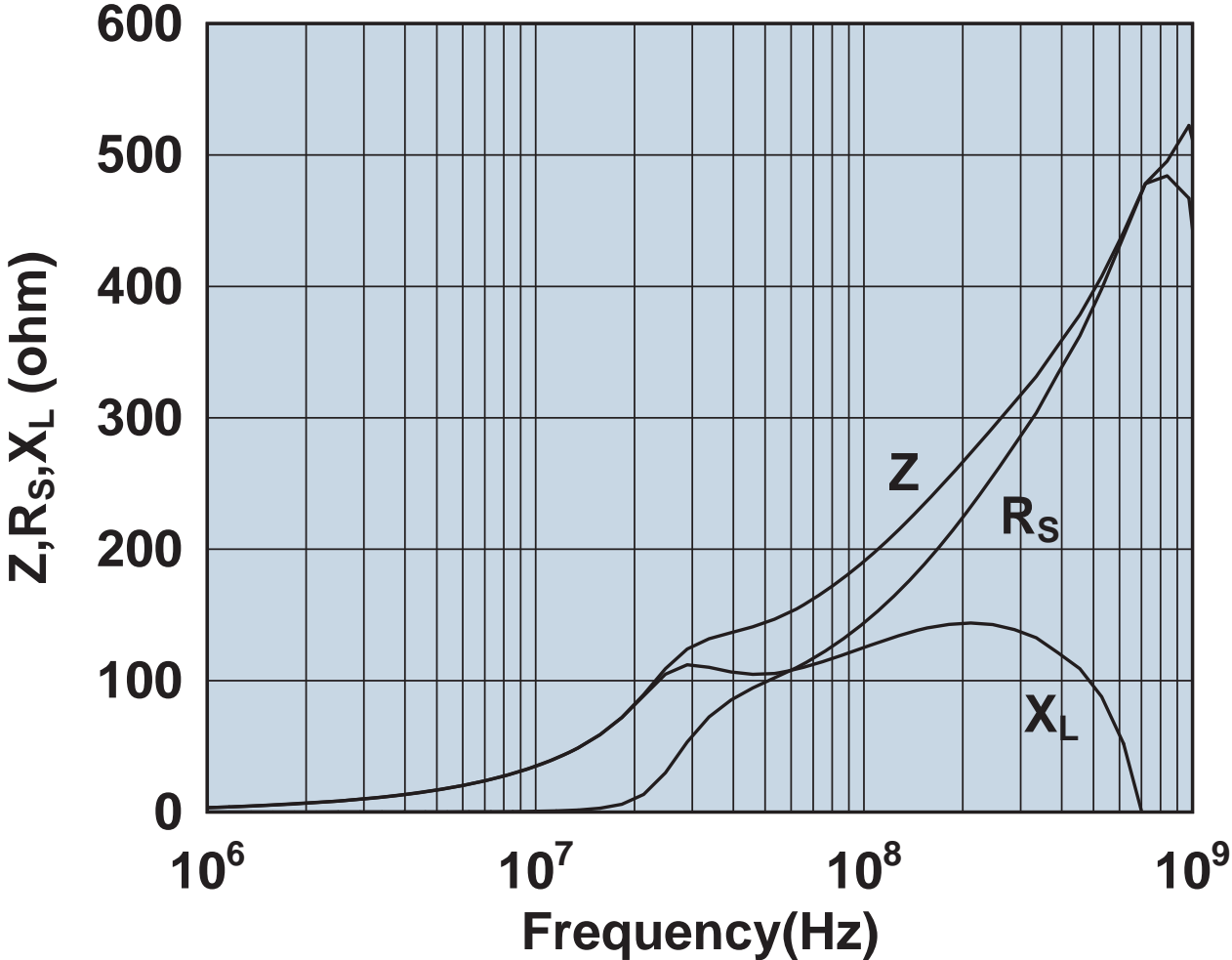

Impedance, reactance, and resistance vs. frequency.

2661665702

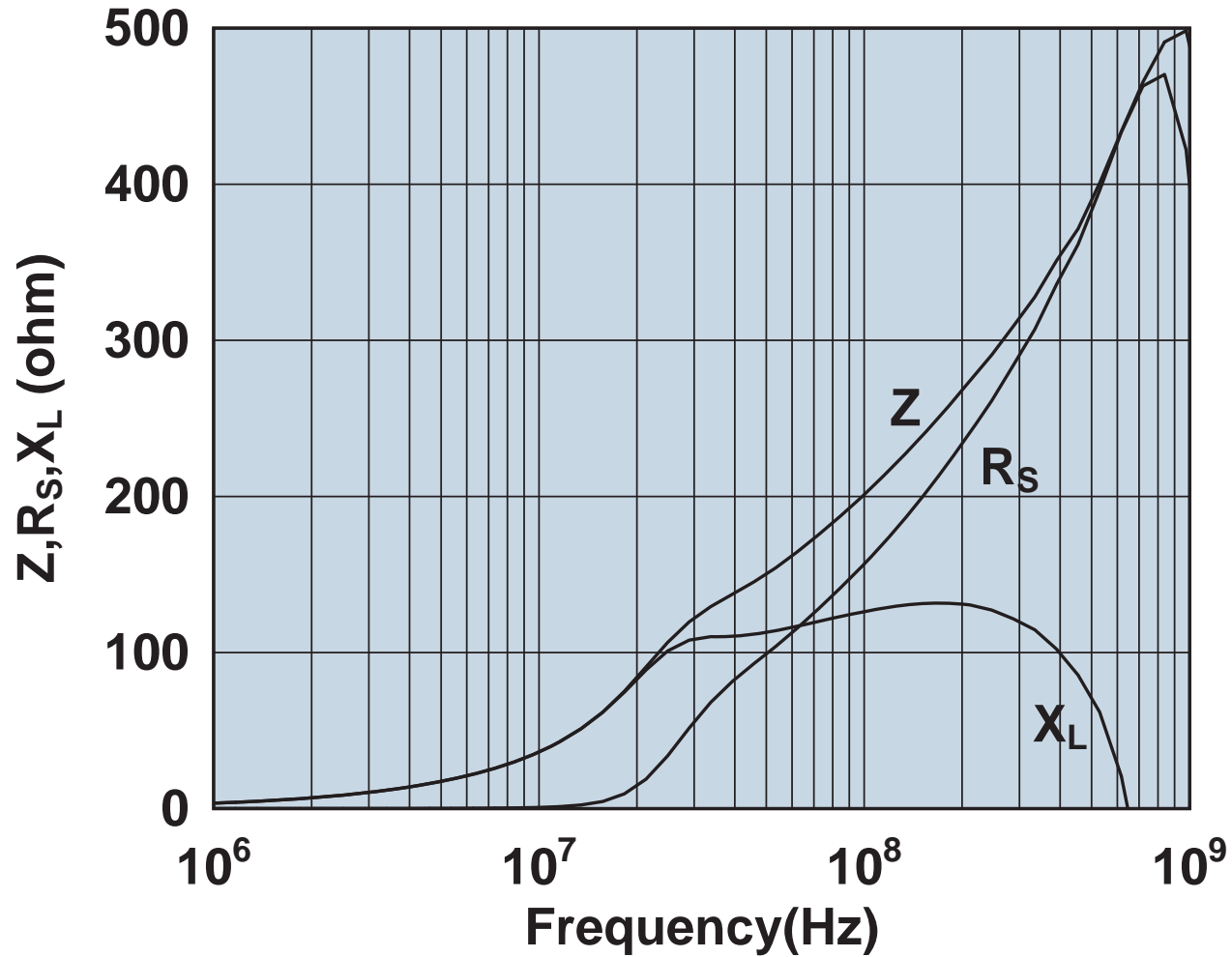

Impedance, reactance, and resistance vs. frequency.

2661665 802

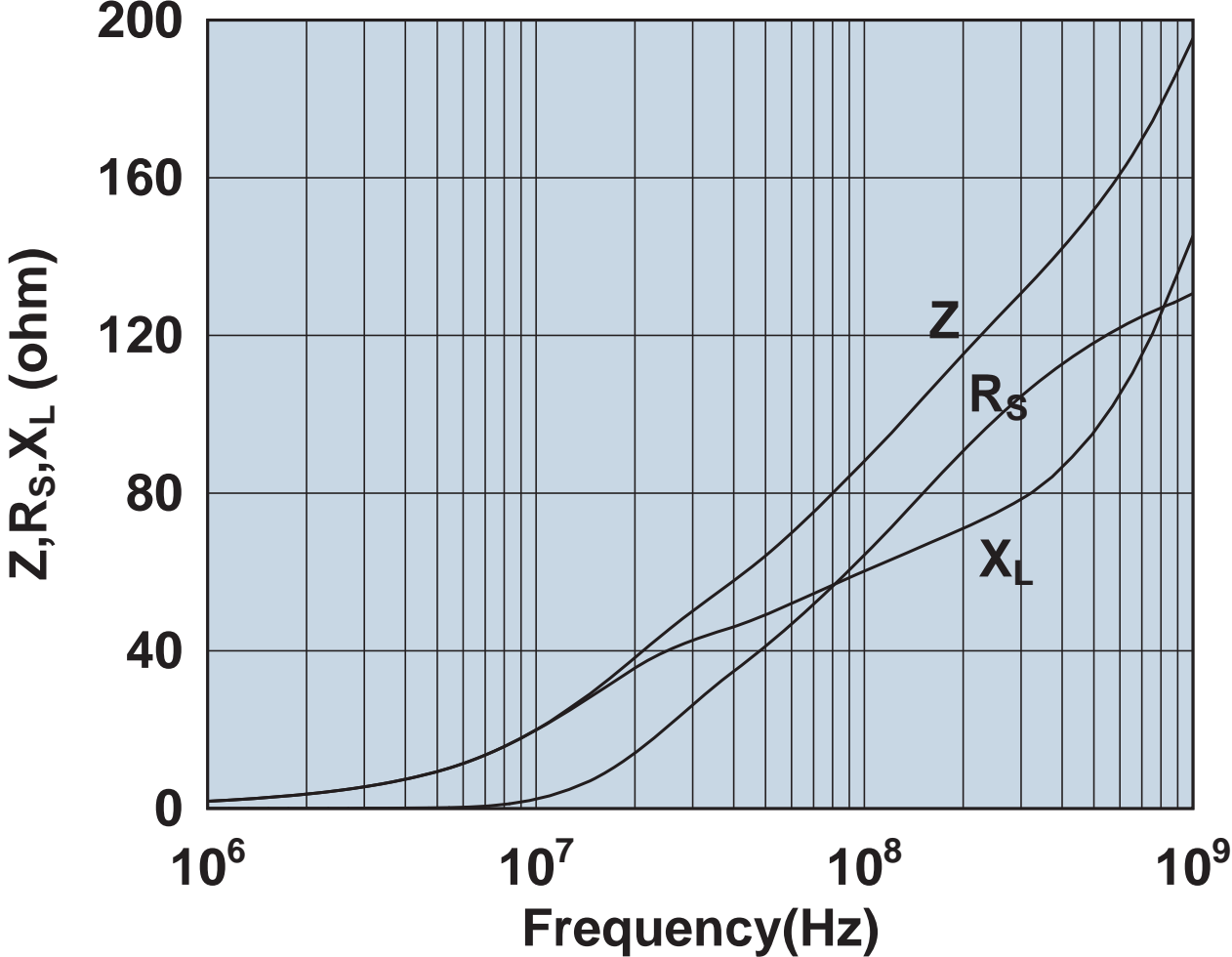

Impedance, reactance, and resistance vs. frequency.

2661801902

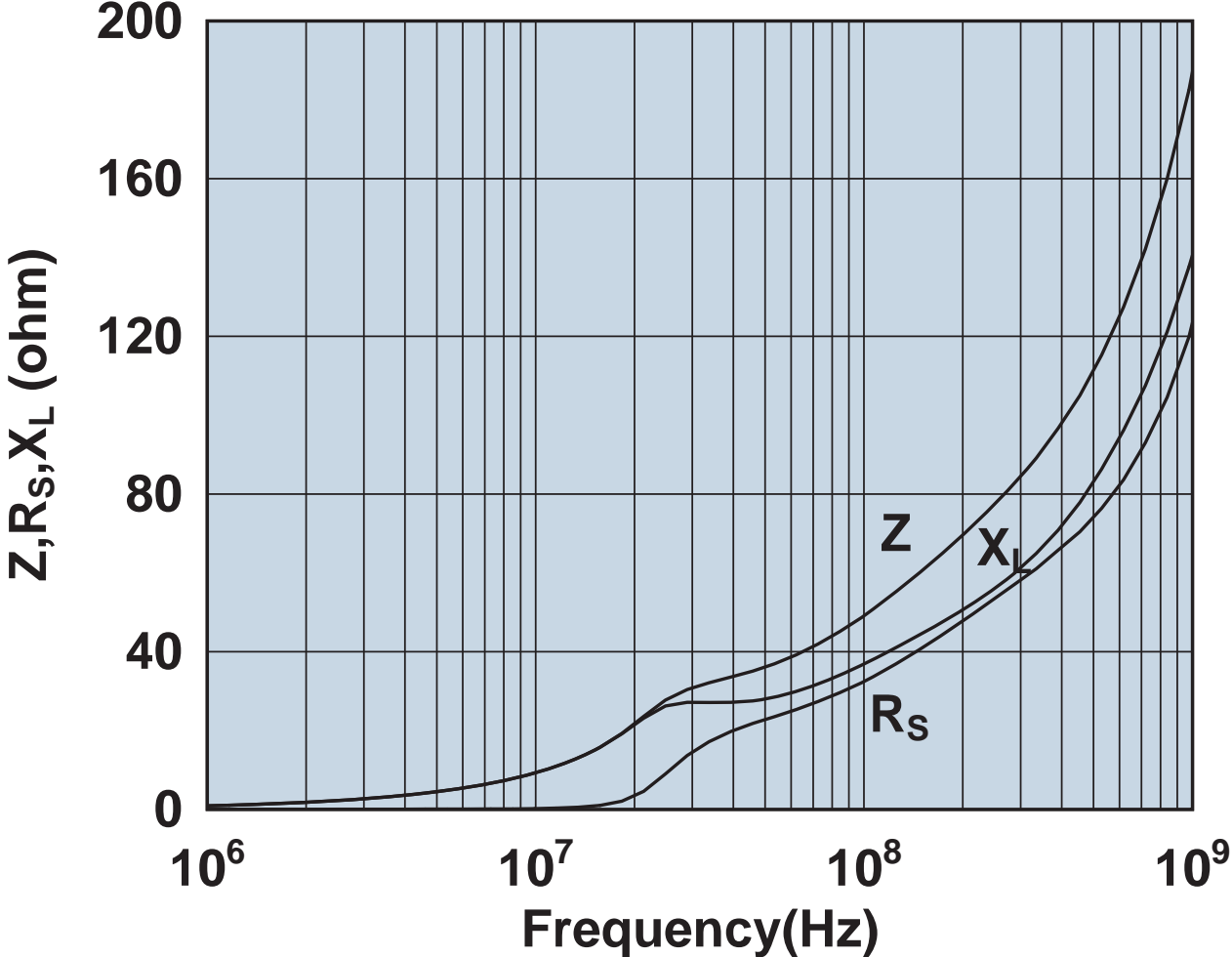

Impedance, reactance, and resistance vs. frequency.

2643101902

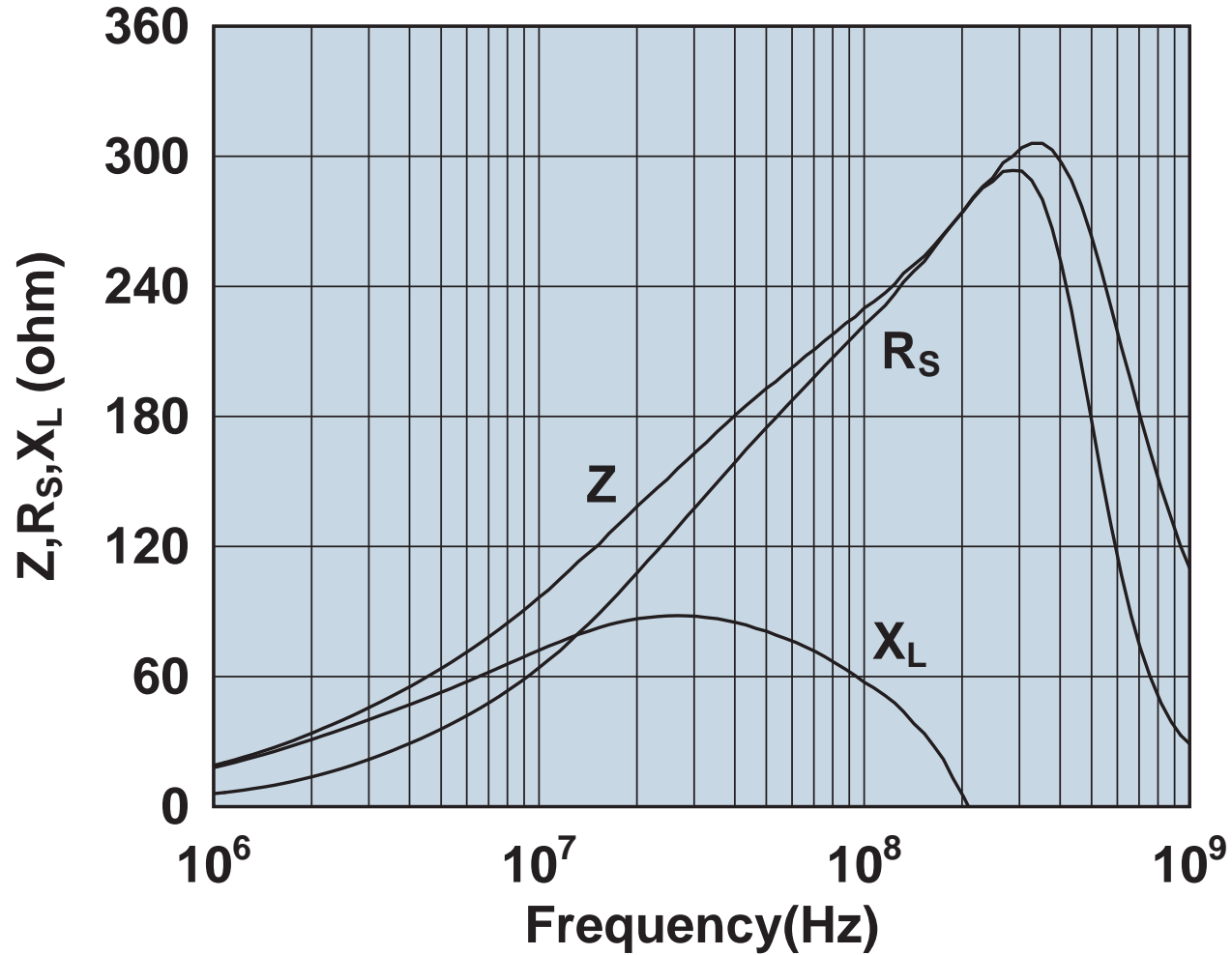

Impedance, reactance, and resistance vs. frequency.

2643023002

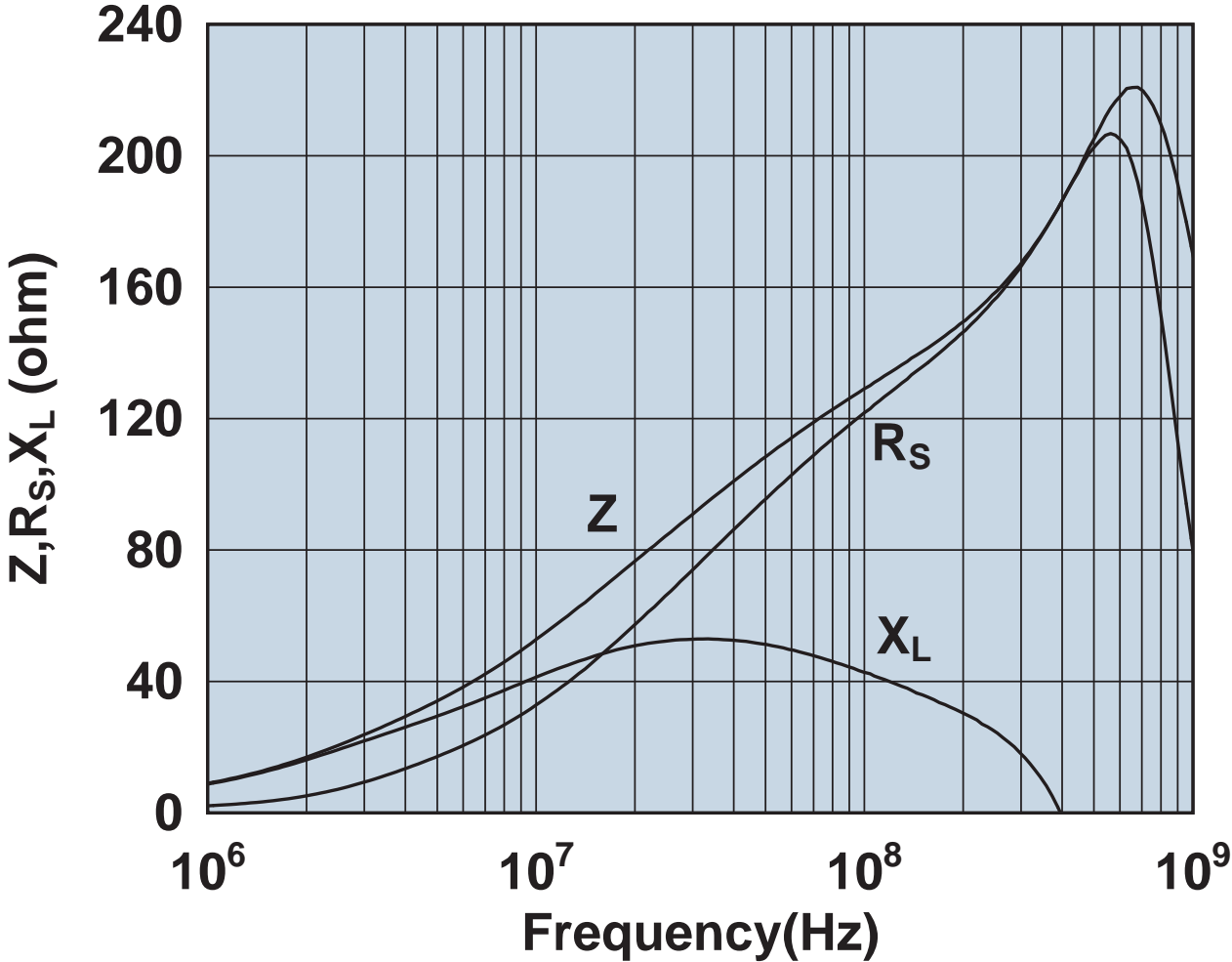

Impedance, reactance, and resistance vs. frequency.

2643000801

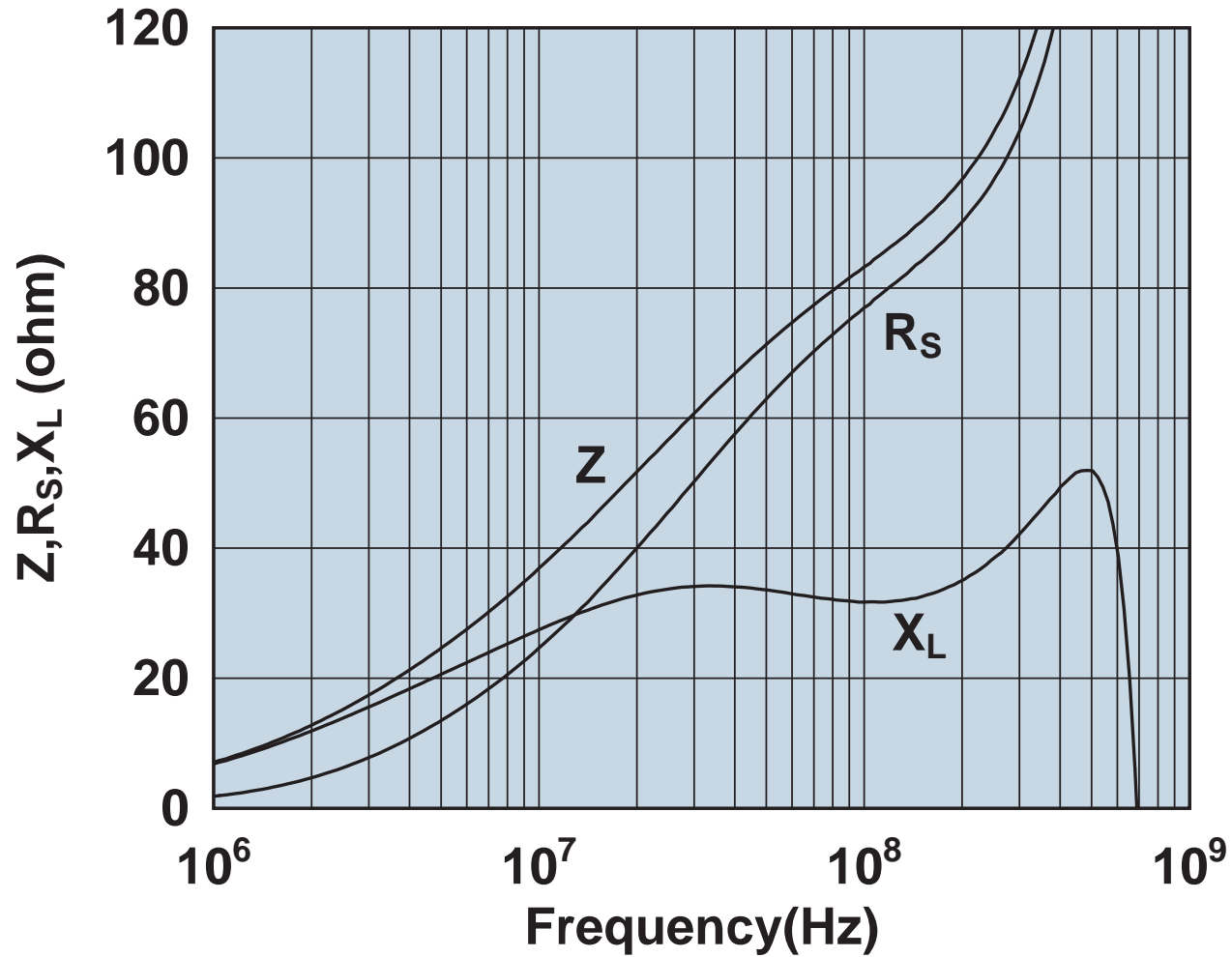

Impedance, reactance, and resistance vs. frequency.

2661480002

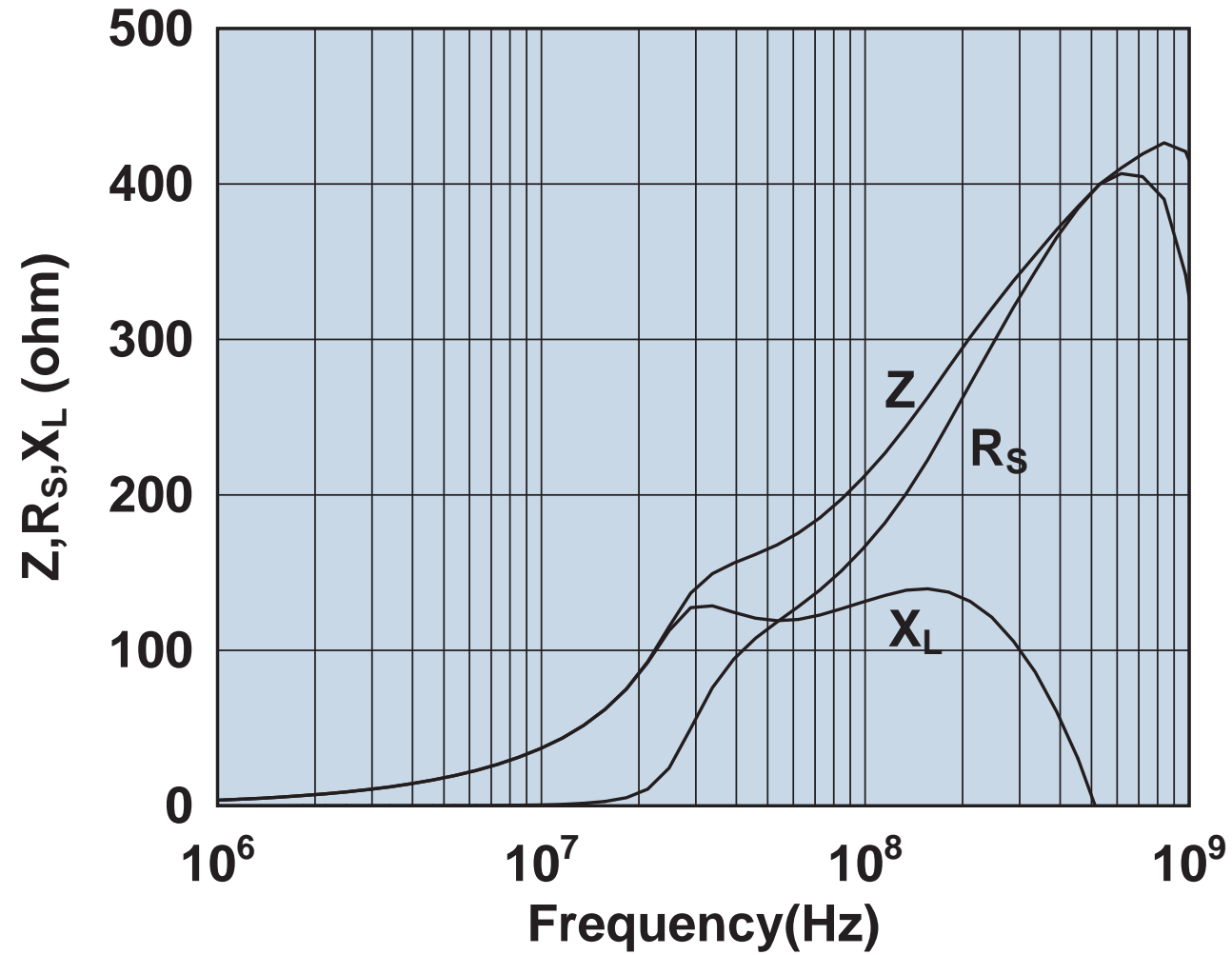

Impedance, reactance, and resistance vs. frequency.

2677006302

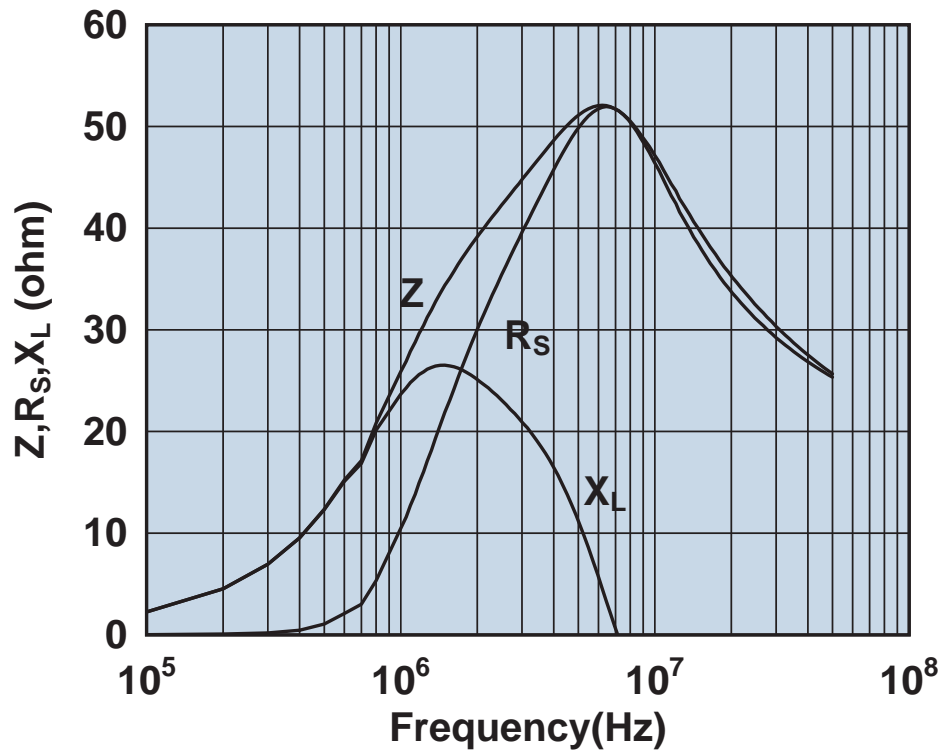

Impedance, reactance, and resistance vs. frequency.

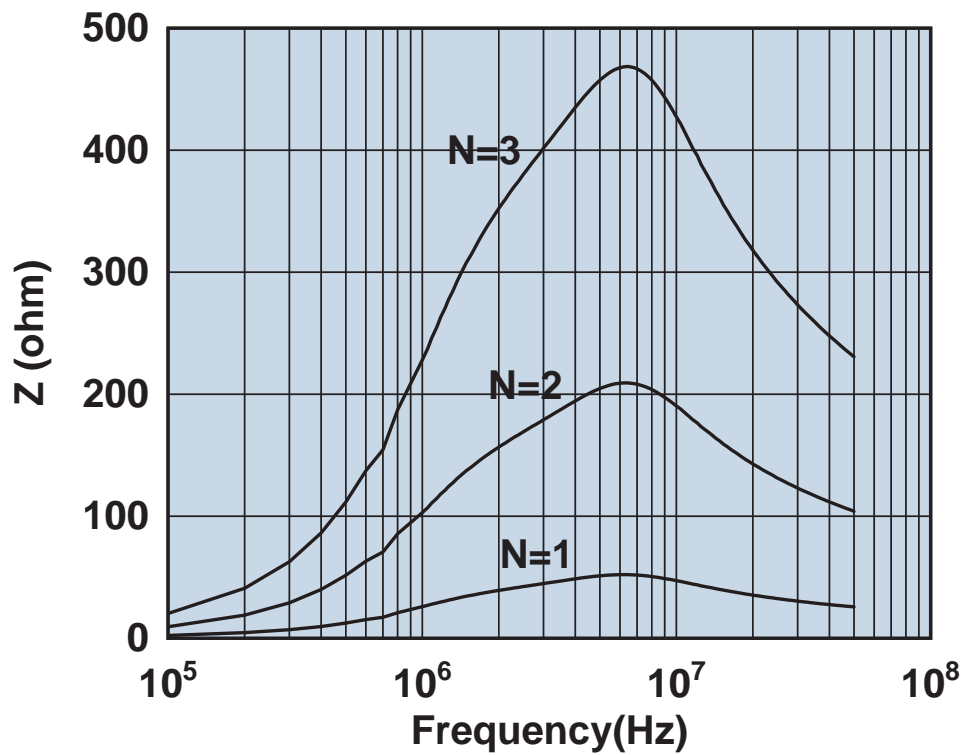

Impedance vs. frequency with one, two, and three turns.

2677102402

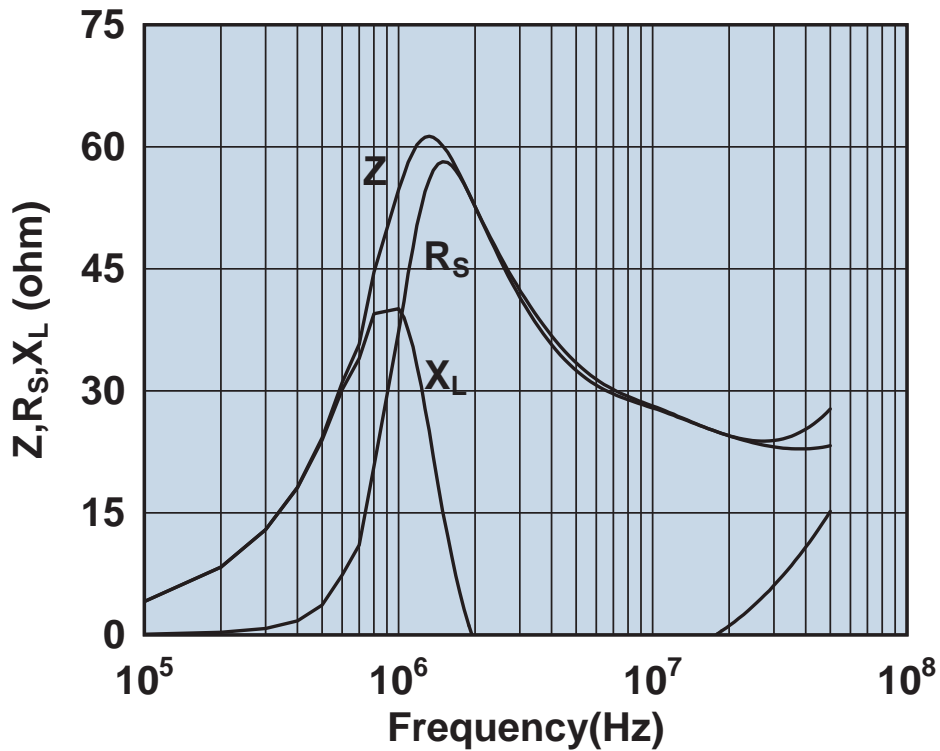

Impedance, reactance, and resistance vs. frequency.

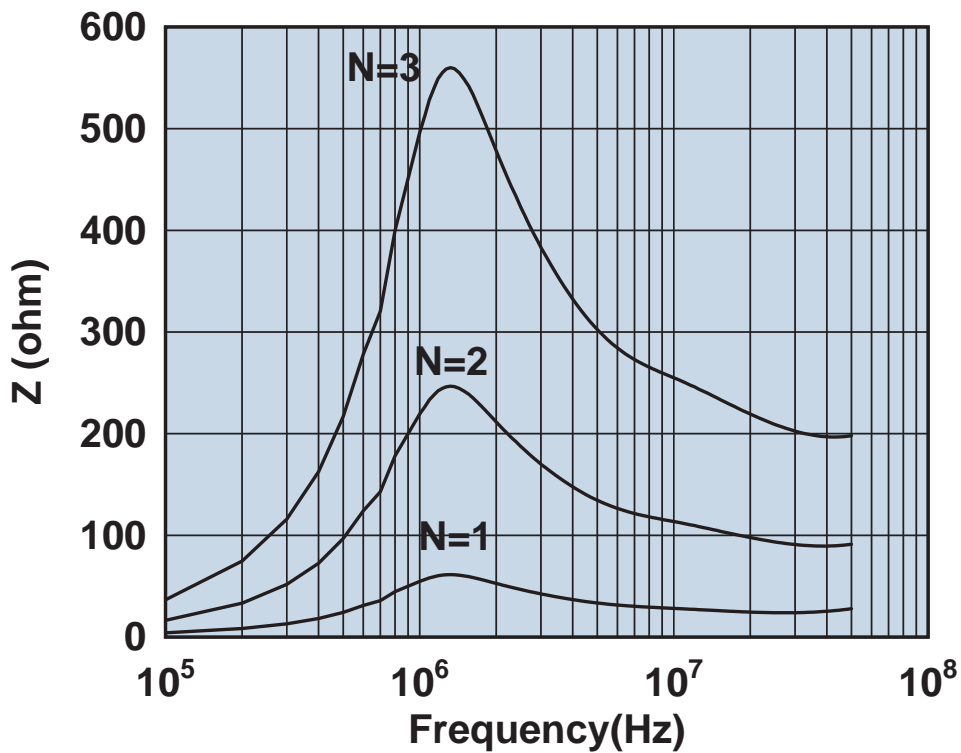

Impedance vs. frequency with one, two, and three turns.

Данный компонент на территории Российской Федерации

Вы можете приобрести в компании MosChip.

Для оперативного оформления запроса Вам необходимо перейти по данной ссылке:

<http://moschip.ru/get-element>

Вы можете разместить у нас заказ для любого Вашего проекта, будь то серийное производство или разработка единичного прибора.

В нашем ассортименте представлены ведущие мировые производители активных и пассивных электронных компонентов.

Нашей специализацией является поставка электронной компонентной базы двойного назначения, продукции таких производителей как XILINX, Intel (ex.ALTERA), Vicor, Microchip, Texas Instruments, Analog Devices, Mini-Circuits, Amphenol, Glenair.

Сотрудничество с глобальными дистрибьюторами электронных компонентов, предоставляет возможность заказывать и получать с международных складов практически любой перечень компонентов в оптимальные для Вас сроки.

На всех этапах разработки и производства наши партнеры могут получить квалифицированную поддержку опытных инженеров.

Система менеджмента качества компании отвечает требованиям в соответствии с ГОСТ Р ИСО 9001, ГОСТ РВ 0015-002 и ЭС РД 009

Офис по работе с юридическими лицами:

105318, г.Москва, ул.Щербаковская д.3, офис 1107, 1118, ДЦ «Щербаковский»

Телефон: +7 495 668-12-70 (многоканальный)

Факс: +7 495 668-12-70 (доб.304)

E-mail: info@moschip.ru

Skype отдела продаж:

moschip.ru

moschip.ru_4

moschip.ru_6

moschip.ru_9