

# Cable Components

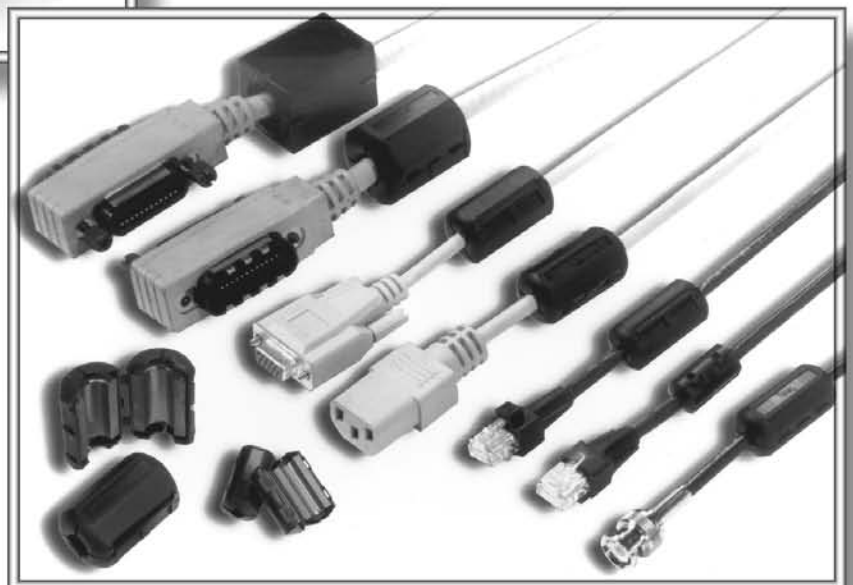

**Fair-Rite Products Corp.** PO Box J, One Commercial Row, Wallkill, NY 12589-0288

Phone: (888) FAIR RITE / (845) 895-2055 • FAX: (888) FERRITE / (845) 895-2629 • www.fair-rite.com  
(888) 324-7748 (888) 337-7483 • E-Mail: ferrites@fair-rite.com

# Engineering Kits

## Expanded Cable & Suppressor Kit

*Part Number 0199000005*

This is our most popular engineering kit. As the name implies, this kit contains a broad sampling of suppression cores to reduce conducted EMI over wires and cables.

## Chip Bead Kit

*Part Number 0199000018*

The chip bead kit has a number of different EIA size chip components with a range of impedance values and signal speeds. Also one of our chip arrays is included in this kit. Parts are RoHS compliant.

## Shield Bead Kit

*Part Number 0199000019*

The shield bead kit has 28 different beads in three suppression materials, 73, 43, and 61.

## Antenna/RFID Kit

*Part Number 0199000024*

The kit contains a range of rods in three low losses, high Q, materials, 78, 61 and 67, to cover frequencies from 10 kHz to 50 MHz.

## Surface Mount Bead Kit

*Part Number 0199000025*

An assortment of surface mount beads for differential and common-mode applications in 73 material for < 50 MHz, 43/44 material for 25-300 MHz and 52/61 material for 250-1000 MHz frequencies. Parts are RoHS compliant.

## Wound Bead Kit

*Part Number 0199000027*

The wound bead kit has twelve wound beads in two suppression materials, 44 and 61, wound in several winding configurations. Parts are RoHS compliant.

## Bead-On-Lead Kit

*Part Number 0199000028*

This bead-on-lead kit has three parts each in three materials, 73, 43 and 61, for through hole applications. Parts are RoHS compliant.

**Fair-Rite Products Corp.**

PO Box J, One Commercial Row, Wallkill, NY 12589-0288

Phone: (888) FAIR RITE / (845) 895-2055 • FAX: (888) FERRITE / (845) 895-2629  
(888) 324-7748 (888) 337-7483

• www.fair-rite.com  
• E-Mail: ferrites@fair-rite.com

# Engineering Kits

## Rod Kit (52 Matl)

Part Number 0199000029

A new rod kit in the new 52 material. Samples of seven sizes intended for open circuit applications that require a ferrite material with high saturation and Curie temperature.

## 31 Snap-It Kit

Part Number 0199000030

This 31 material snap-it kit has a range parts for different cable diameters. Suggested operating frequency 1-300 MHz.

## 43 Snap-It Kit

Part Number 0199000031

Snap-it assemblies suitable for the 25-300 MHz frequency range. Can accommodate cable diameters from .250 to .590 inches.

## 46 Core and Snap-It Kit

Part Number 0199000032

This kit has a selection of cable cores and snap-its in our new economical 46 material. This material has similar performance as our 43/44 grade materials over the 25-300 MHz frequency range.

## 61 Snap-It Kit

Part Number 0199000033

Our recommendation for suppressing conducted EMI in 200-1000 MHz is the 61 material. This kit has a selection of 61 snap-its.

## Chip Inductor Kit

Part Number 0199000035

The chip inductor kit has several EIA sizes in both ferrite and ceramic chip inductors. Parts are RoHS compliant.

## Multi-Aperture Core Kit

Part Number 0199000036

Kit contains several sizes in four materials, 73, 43, 61 and 67. This allows experimentation from a few kHz into the 50-100 MHz range.

# Round Cable EMI Suppression Cores

Listed by frequency range and in ascending order of "B" dimension.

Fair-Rite offers a broad selection of ferrite EMI suppression cable cores in several materials with guaranteed minimum impedance specifications.

. All cable cores have been burnished to remove the sharp edges.

. The column "H" (Oe) gives for each cable core the calculated dc bias field in oersted for 1 turn and 1 ampere direct current. The actual dc H field in the application, is this value of "H" times the actual NI (ampere-turns) product. For the effect of the dc bias on the impedance of the core material, see the material graphs on pages 145-146, Figures 18-23.

. Suppression cable cores are controlled for impedances only. The impedances listed are typical values. Minimum impedance values are specified for the + marked frequencies. The minimum guaranteed impedance is the listed impedance less 20%.

. Single turn impedance tests for 31, 43 and 46 material cores are performed on the 4193A Vector Impedance Meter. The 61 material parts are tested on the 4191A RF Impedance Analyzer. **Cores are tested with the shortest practical wire length.**

. Performance curves of all listed cable suppression cores are compiled on the Fair-Rite Products CD-ROM.

. For smaller suppression parts, refer to the section "EMI Suppression Beads" on pages 29-33.

. For any cable suppression core not listed here, feel free to contact our customer service group for availability and pricing.

. Our "Expanded Cable and Connector EMI Suppression Kit" (part number 0199000005) contains a selection of these suppression cores. See page 67.

. Explanation of Part Numbers: Digits 1&2 = product class, 3&4 material grade and last digit 2 = burnished.

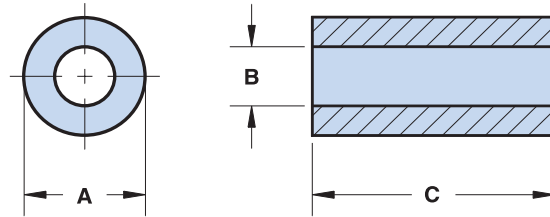

## Lower & Broadband Frequencies 1-300 MHz (31 material)

Dimensions (Bold numbers are in millimeters, light numbers are nominal in inches.)

Part Number	A	B	C*	Wt (g)	H (Oe)	Typical Impedance ( $\Omega$ )					
						1 MHz	5 MHz	10 MHz <sup>+</sup>	25 MHz <sup>+</sup>	100 MHz <sup>+</sup>	250 MHz
2631250202	6.35±0.15 .250	2.95±0.45 .125	25.4±0.75 1.000	2.9	.52	27	70	90	138	230	240
2631023002	9.5±0.25 .375	4.75±0.3 .193	19.05±0.7 .750	4.7	.52	19	49	62	95	160	185
2631480102	12.3±0.4 .485	4.95±0.25 .200	12.7±0.4 .500	6.0	.52	18	45	58	88	140	167
2631480002	12.3±0.4 .485	4.95±0.25 .200	25.4±0.75 1.000	12	.52	34	88	115	175	295	267
2631540202	14.3±0.45 .562	6.35±0.25 .250	13.8 - 0.7 .530	8.3	.43	17	44	58	88	140	160
2631540002	14.3±0.45 .562	6.35±0.25 .250	28.6±0.75 1.125	17.7	.43	35	91	119	181	300	280
2631625002	16.25 - 0.75 .625	7.9±0.25 .312	14.3±0.35 .562	10.3	.36	16	40	53	75	130	150
2631625102	16.25 - 0.75 .625	7.9±0.25 .312	28.6±0.75 1.125	20.5	.36	30	79	103	156	260	268
2631665802	17.45±0.4 .687	9.5±0.25 .375	12.7±0.5 .500	10.3	.32	13	31	38	60	115	137
2631665702	17.45±0.4 .687	9.5±0.25 .375	28.6±0.75 1.125	23.1	.32	27	69	89	138	225	265

\* This dimension may be modified to suit specific applications.

<sup>+</sup> Test frequency

## Fair-Rite Products Corp.

PO Box J, One Commercial Row, Wallkill, NY 12589-0288

Phone: (888) FAIR RITE / (845) 895-2055 • FAX: (888) FERRITE / (845) 895-2629  
(888) 324-7748 (888) 337-7483

• www.fair-rite.com  
• E-Mail: ferrites@fair-rite.com

# Round Cable EMI Suppression Cores

Listed by frequency range and in ascending order of "B" dimension.

## Lower & Broadband Frequencies 1-300 MHz (31 material)

Dimensions (Bold numbers are in millimeters, light numbers are nominal in inches.)

Part Number	A	B	C*	Wt (g)	H (Oe)	Typical Impedance ( $\Omega$ )					
						1 MHz	5 MHz	10 MHz <sup>+</sup>	25 MHz <sup>+</sup>	100 MHz <sup>+</sup>	250 MHz
2631626302	18.7±0.5 .735	10.15±0.25 .400	14.65 - 0.75 .562	13.3	.29	14	35	44	69	115	140
2631626402	18.7±0.5 .735	10.15±0.25 .400	28.6±0.75 1.125	26.6	.29	27	69	89	138	225	235
2631102002	25.9±0.75 1.020	12.8±0.25 .505	28.6±0.8 1.125	55	.22	31	79	103	156	260	280
2631101902	28.5±0.6 1.122	13.8±0.3 .543	28.6±0.8 1.125	68	.21	32	82	106	163	270	300
2631801202	29.0±0.75 1.142	19.0±0.5 .748	13.85±0.4 .545	25	.17	10	24	31	49	88	130
2631103002	31.1±0.85 1.225	19.05±0.6 .750	50.8±1.0 2.000	116	.17	37	98	120	205	340	315
2631626202	50.8±1.3 2.000	25.4±0.8 1.000	38.1±0.75 1.500	278	.11	40	103	140	215	365	290
2631803802	61.0±1.3 2.400	35.55±0.85 1.400	12.7±0.5 .500	118	.09	12	28	40	63	119	215

## Broadband Frequencies 25-300 MHz (43 material)

Part Number	A	B	C*	Wt (g)	H (Oe)	Typical Impedance ( $\Omega$ )			
						10 MHz	25 MHz <sup>+</sup>	100 MHz <sup>+</sup>	250 MHz
2643480102	12.3±0.4 .485	4.95±0.25 .200	12.7±0.4 .500	6.0	.52	52	84	121	145
2643480002	12.3±0.4 .485	4.95±0.25 .200	25.4±0.75 1.000	12	.52	102	165	236	233
2643540702	14.3±0.45 .562	6.35±0.25 .250	5.3 - 0.45 .200	3.1	.43	20	30	50	68
2643540102	14.3±0.45 .562	6.35±0.25 .250	10.15±0.4 .400	6.3	.43	39	61	89	104
2643540202	14.3±0.45 .562	6.35±0.25 .250	13.8 - 0.7 .530	8.3	.43	51	78	118	140
2643540002	14.3±0.45 .562	6.35±0.25 .250	28.6±0.75 1.125	17.7	.43	105	171	250	255
2643540302	14.3±0.45 .562	7.1±0.25 .280	15.25±0.4 .600	8.9	.41	50	75	118	137
2643800302	12.7±0.25 .500	7.15±0.2 .282	4.9 - 0.25 .188	2.0	.43	15	26	42	59
2643540402	14.3±0.45 .562	7.25±0.2 .286	28.6±0.75 1.125	16	.40	88	143	215	230
2643801102	12.7±0.25 .500	7.9±0.2 .312	6.35±0.2 .250	2.4	.40	16	26	41	59
2643801902	12.7±0.25 .500	7.9±0.2 .312	12.7±0.4 .500	4.7	.40	29	44	73	91

\* This dimension may be modified to suit specific applications.

<sup>+</sup> Test frequency

## Fair-Rite Products Corp.

PO Box J, One Commercial Row, Wallkill, NY 12589-0288

Phone: (888) FAIR RITE / (845) 895-2055 • FAX: (888) FERRITE / (845) 895-2629 • www.fair-rite.com  
(888) 324-7748 (888) 337-7483 • E-Mail: ferrites@fair-rite.com

# Round Cable EMI Suppression Cores

Listed by frequency range and in ascending order of "B" dimension.

## Broadband Frequencies 25-300 MHz (43 material)

Dimensions (Bold numbers are in millimeters, light numbers are nominal in inches.)

Part Number	A	B	C*	Wt (g)	H (Oe)	Typical Impedance ( $\Omega$ )			
						10 MHz	25 MHz <sup>+</sup>	100 MHz <sup>+</sup>	250 MHz
2643625002	<b>16.25 - 0.75</b> .625	<b>7.9±0.25</b> .312	<b>14.3±0.35</b> .562	10.3	.36	45	70	113	135
2643625102	<b>16.25 - 0.75</b> .625	<b>7.9±0.25</b> .312	<b>28.6±0.75</b> 1.125	20.5	.36	90	130	213	305
2643625202	<b>15.9±0.4</b> .625	<b>7.9±0.3</b> .312	<b>50.8±1.0</b> 2.000	36	.36	158	235	384	373
2643665902	<b>17.45±0.4</b> .687	<b>9.5±0.25</b> .375	<b>6.35±0.25</b> .250	5.1	.32	19	26	44	62
2643665802	<b>17.45±0.4</b> .687	<b>9.5±0.25</b> .375	<b>12.7±0.5</b> .500	10.3	.32	35	55	88	108
2643665702	<b>17.45±0.4</b> .687	<b>9.5±0.25</b> .375	<b>28.6±0.75</b> 1.125	23.1	.32	78	125	200	255
2643626302	<b>18.7±0.5</b> .735	<b>10.15±0.25</b> .400	<b>14.65 - 0.75</b> .562	13.3	.29	41	63	96	123
2643626402	<b>18.7±0.5</b> .735	<b>10.15±0.25</b> .400	<b>28.6±0.75</b> 1.125	26.6	.29	79	128	196	220
2643626502	<b>18.7±0.6</b> .735	<b>10.15±0.4</b> .400	<b>50.8±1.0</b> 2.000	47	.29	138	225	348	405
2643801502	<b>25.4±0.65</b> 1.000	<b>12.7±0.35</b> .500	<b>6.35±0.25</b> .250	11.6	.23	22	34	53	87
2643102402	<b>25.9±0.75</b> 1.020	<b>12.8±0.25</b> .505	<b>21.3±0.5</b> .840	41	.22	68	110	183	230
2643102002	<b>25.9±0.75</b> 1.020	<b>12.8±0.25</b> .505	<b>28.6±0.8</b> 1.125	55	.22	91	145	235	275
2643800602	<b>20.95±0.4</b> .825	<b>13.2±0.3</b> .520	<b>6.35±0.2</b> .250	6.3	.24	16	24	44	67
2643800502	<b>20.95±0.4</b> .825	<b>13.2±0.3</b> .520	<b>11.9±0.4</b> .468	11.9	.24	27	45	82	115
2643801802	<b>22.1±0.4</b> .870	<b>13.7±0.3</b> .540	<b>6.35±0.2</b> .250	7.2	.23	15	25	45	70
2643101902	<b>28.5±0.6</b> 1.122	<b>13.8±0.3</b> .543	<b>28.6±0.8</b> 1.125	67	.21	93	145	230	290
2643801402	<b>25.4±0.6</b> 1.000	<b>15.5±0.5</b> .610	<b>8.1±0.3</b> .320	12.4	.20	20	35	55	95
2643806402	<b>25.4±0.6</b> 1.000	<b>15.5±0.5</b> .610	<b>12.7±0.4</b> .500	19.4	.20	30	53	90	130
2643251002	<b>39.1±0.75</b> 1.540	<b>16.75±0.5</b> .660	<b>22.2±0.8</b> .875	104	.16	85	135	230	325
2643801002	<b>29.0±0.75</b> 1.142	<b>19.0±0.5</b> .748	<b>7.5±0.25</b> .295	13.6	.17	17	28	47	80
2643801202	<b>29.0±0.75</b> 1.142	<b>19.0±0.5</b> .748	<b>13.85±0.4</b> .545	25.1	.17	28	51	92	142
2643103102	<b>29.0±0.75</b> 1.142	<b>19.0±0.5</b> .748	<b>38.1±0.75</b> 1.500	69	.17	87	130	200	250

\* This dimension may be modified to suit specific applications.

<sup>+</sup> Test frequency

## Fair-Rite Products Corp.

PO Box J, One Commercial Row, Wallkill, NY 12589-0288

Phone: (888) FAIR RITE / (845) 895-2055 • FAX: (888) FERRITE / (845) 895-2629 • www.fair-rite.com  
(888) 324-7748 (888) 337-7483 • E-Mail: ferrites@fair-rite.com

# Round Cable EMI Suppression Cores

Listed by frequency range and in ascending order of "B" dimension.

## Broadband Frequencies 25-300 MHz (43 material)

Dimensions (Bold numbers are in millimeters, light numbers are nominal in inches.)

Part Number	A	B	C*	Wt (g)	H (Oe)	Typical Impedance ( $\Omega$ )			
						10 MHz	25 MHz <sup>+</sup>	100 MHz <sup>+</sup>	250 MHz
2643804502	<b>31.1±0.75</b> 1.225	<b>19.05±0.5</b> .750	<b>16.3 - 0.75</b> .627	36	.17	37	60	100	153
2643103002	<b>31.1±0.85</b> 1.225	<b>19.05±0.6</b> .750	<b>50.8 ± 1.0</b> 2.000	116	.17	105	195	330	310
2643802702	<b>35.55±0.75</b> 1.400	<b>22.85±0.5</b> .900	<b>12.7±0.5</b> .500	36	.14	28	48	80	135
2643626102	<b>50.8±1.0</b> 2.000	<b>25.4±0.5</b> 1.000	<b>25.4±0.75</b> 1.000	190	.11	80	128	224	310
2643625902	<b>50.8±1.0</b> 2.000	<b>25.4±0.5</b> 1.000	<b>28.7±0.75</b> 1.130	215	.11	90	145	254	373
2643626202	<b>50.8±1.3</b> 2.000	<b>25.4±0.8</b> 1.000	<b>38.1±0.75</b> 1.500	285	.11	118	193	336	280
2643626002	<b>50.8±1.3</b> 2.000	<b>25.4±0.8</b> 1.000	<b>50.8±1.0</b> 2.000	380	.11	157	240	360	257
2643803802	<b>61.0±1.3</b> 2.400	<b>35.55±0.85</b> 1.400	<b>12.7±0.5</b> .500	118	.09	33	58	108	218

## Broadband Frequencies 25-300 MHz (Economical 46 material)

Part Number	A	B	C*	Wt (g)	H (Oe)	Typical Impedance ( $\Omega$ )			
						10 MHz	25 MHz	100 MHz <sup>+</sup>	250 MHz
2646480102	<b>12.3±0.4</b> .485	<b>4.95±0.25</b> .200	<b>12.7±0.4</b> .500	6.0	.52	42	62	110	145
2646480002	<b>12.3±0.4</b> .485	<b>4.95±0.25</b> .200	<b>25.4±0.75</b> 1.000	12	.52	83	125	212	233
2646540202	<b>14.3±0.45</b> .562	<b>6.35±0.25</b> .250	<b>13.8 - 0.7</b> .530	8.3	.43	45	66	106	127
2646540002	<b>14.3±0.45</b> .562	<b>6.35±0.25</b> .250	<b>28.6±0.75</b> 1.125	17.7	.43	89	134	225	253
2646625002	<b>16.25 - 0.75</b> .625	<b>7.9±0.25</b> .312	<b>14.3±0.35</b> .562	10.3	.36	44	63	102	135
2646625102	<b>16.25 - 0.75</b> .625	<b>7.9±0.25</b> .312	<b>28.6±0.75</b> 1.125	20.5	.36	78	115	192	235
2646625202	<b>15.9±0.4</b> .625	<b>7.9±0.3</b> .312	<b>50.8±1.0</b> 2.000	36	.36	138	204	345	270
2646665802	<b>17.45±0.4</b> .687	<b>9.5±0.25</b> .375	<b>12.7±0.5</b> .500	10.3	.32	32	49	79	110
2646665702	<b>17.45±0.4</b> .687	<b>9.5±0.25</b> .375	<b>28.6±0.75</b> 1.125	23.1	.32	72	106	180	225
2646102402	<b>25.9±0.75</b> 1.020	<b>12.8±0.25</b> .505	<b>21.3±0.5</b> .840	41	.22	67	100	165	218
2646102002	<b>25.9±0.75</b> 1.020	<b>12.8±0.25</b> .505	<b>28.6±0.8</b> 1.125	55	.22	74	118	212	268
2646101902	<b>28.5±0.6</b> 1.122	<b>13.8±0.3</b> .543	<b>28.6±0.8</b> 1.125	67	.21	80	121	207	285

\* This dimension may be modified to suit specific applications.

<sup>+</sup> Test frequency

# Fair-Rite Products Corp.

PO Box J, One Commercial Row, Wallkill, NY 12589-0288

Phone: (888) FAIR RITE / (845) 895-2055 • FAX: (888) FERRITE / (845) 895-2629  
(888) 324-7748 (888) 337-7483

• www.fair-rite.com  
• E-Mail: ferrites@fair-rite.com



# Round Cable EMI Suppression Cores

Listed by frequency range and in ascending order of "B" dimension.

## Broadband Frequencies 25-300 MHz (Economical 46 material)

Dimensions (Bold numbers are in millimeters, light numbers are nominal in inches.)

Part Number	A	B	C*	Wt (g)	H (Oe)	Typical Impedance ( $\Omega$ )			
						10 MHz	25 MHz	100 MHz <sup>+</sup>	250 MHz
2646804502	<b>31.1±0.75</b> 1.225	<b>19.05±0.5</b> .750	<b>16.3 - 0.75</b> .627	36	.17	33	49	90	150
2646103002	<b>31.1±0.85</b> 1.225	<b>19.05±0.6</b> .750	<b>50.8 ± 1.0</b> 2.000	116	.17	95	155	297	310
2646626202	<b>50.8±1.3</b> 2.000	<b>25.4±0.8</b> 1.000	<b>38.1±0.75</b> 1.500	285	.11	102	165	302	280
2646803802	<b>61.0±1.3</b> 2.400	<b>35.55±0.85</b> 1.400	<b>12.7±0.5</b> .500	118	.09	30	44	100	200

## Higher Frequencies 200-1000 MHz (61 material)

Part Number	A	B	C*	Wt (g)	H (Oe)	Typical Impedance( $\Omega$ )			
						100 MHz	250 MHz <sup>+</sup>	500 MHz <sup>+</sup>	1000 MHz
2661480002	<b>12.3±0.4</b> .485	<b>4.95±0.25</b> .200	<b>25.4±0.75</b> 1.000	12	.52	???	???	???	???
2661540202	<b>14.3±0.45</b> .562	<b>6.35±0.25</b> .250	<b>13.8 - 0.7</b> .530	8.3	.43	100	145	185	260
2661540002	<b>14.3±0.45</b> .562	<b>6.35±0.25</b> .250	<b>28.6±0.75</b> 1.125	17.7	.43	205	295	370	350
2661801902	<b>12.7±0.25</b> .500	<b>7.9±0.25</b> .312	<b>12.7± 0.4</b> .500	4.7	.40	45	70	105	175
2661665802	<b>17.45±0.4</b> .687	<b>9.5±0.25</b> .375	<b>12.7±0.5</b> .500	10.3	.32	85	125	160	205
2661665702	<b>17.45±0.4</b> .687	<b>9.5±0.25</b> .375	<b>28.6±0.75</b> 1.125	23.1	.32	190	280	360	450
2661626302	<b>19.0 - 0.65</b> .735	<b>10.15±0.25</b> .400	<b>14.65 - 0.75</b> .562	13.3	.29	90	135	180	235
2661626402	<b>19.0 - 0.65</b> .735	<b>10.15±0.25</b> .400	<b>28.6±0.75</b> 1.125	26.6	.29	185	250	370	460
2661102402	<b>25.9±0.75</b> 1.020	<b>12.8±0.25</b> .505	<b>21.3±0.5</b> .840	41	.22	125	200	310	550
2661102002	<b>25.9±0.75</b> 1.020	<b>12.8±0.25</b> .505	<b>28.6±0.8</b> 1.125	55	.22	190	300	380	400

\* This dimension may be modified to suit specific applications.

<sup>+</sup> Test frequency

## Fair-Rite Products Corp.

PO Box J, One Commercial Row, Wallkill, NY 12589-0288

Phone: (888) FAIR RITE / (845) 895-2055 • FAX: (888) FERRITE / (845) 895-2629  
(888) 324-7748

• www.fair-rite.com  
• E-Mail: ferrites@fair-rite.com



# Round Cable Snap-its

Listed by frequency range and in ascending order of cable diameter.

Round cable snap-its can easily accommodate round cables or bundled wires with diameters from 2.5 mm (.100") to 25.4 mm (1.000"). These assemblies are available in four ferrite material grades to suppress differential or common-mode conducted EMI from 1 MHz into the GHz region.

The polypropylene cases are meeting the RoHS restrictions of hazardous substances and have a flammability rating of UL 94-V0.

- Round cable snap-it assemblies are controlled for impedances only. The impedances listed are typical values. Minimum impedance values are specified for the + marked frequencies. The minimum guaranteed impedance is the listed impedance less 20%.
- Single turn impedance tests for the 31, 43 and 44 material are performed on the 4193A Vector Impedance Analyzer. The 61 material parts are tested on the 4191A RF Impedance Analyzer. **Cores are tested with the shortest practical wire length.**
- Performance curves of all listed round cable snap-its are compiled on the Fair-Rite Products CD-ROM.
- Many of the snap-it parts have round core equivalents. See section Round Cable EMI Suppression Cores on pages 70-74.
- Round Cable Snap-it Kits are available for each of the four suppression materials. 31 Snap-It Kit (0199000030), 43 Snap-It Kit (0199000031), 46 Core and Snap-It Kit (0199000032) and 61 Snap-It Kit (0199000033). For additional details see page 68.
- Explanation of Part Numbers: Digits 1&2 = product class and 3&4 material grade.

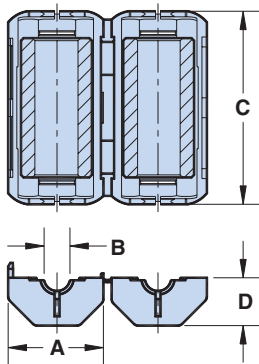

Figure 1

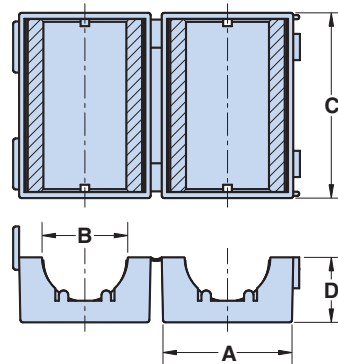

Figure 2

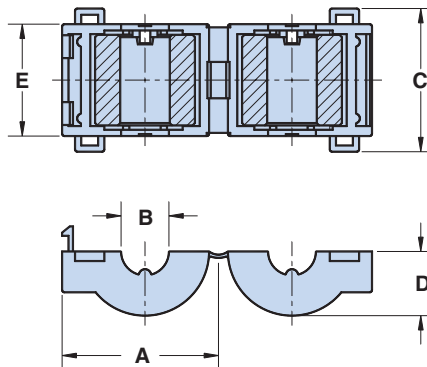

Figure 3

## Fair-Rite Products Corp.

PO Box J, One Commercial Row, Wallkill, NY 12589-0288

Phone: (888) FAIR RITE / (845) 895-2055 • FAX: (888) FERRITE / (845) 895-2629 • www.fair-rite.com  
 (888) 324-7748 (888) 337-7483 • E-Mail: ferrites@fair-rite.com

# Round Cable Snap-its

Listed by frequency range and in ascending order of cable diameter.

## Lower & Broadband Frequencies 1-300 MHz (31 material)

Dimensions (Bold numbers are in millimeters, light numbers are nominal in inches.)

Part Number	Fig.	Max. Cable Diameter	A	B**	C	D	Wt. (g)	Typical Impedance( $\Omega$ )						Solid Equivalent*
								1 MHz	5 MHz	10 MHz <sup>+</sup>	25 MHz <sup>+</sup>	100 MHz <sup>+</sup>	250 MHz	
0431178181	1	4.1 .161	11.8 .465	4.3 .169	23.2 .913	5.6 .221	4.2	12	43	60	90	160	183	
0431173951	1	4.9 .193	12.8 .504	5.1 .201	25.0 .984	5.6 .220	6.5	14	44	60	100	180	208	2631023002
0431164951	1	4.9 .193	17.3 .680	5.1 .201	36.2 1.420	8.4 .331	17	25	75	100	169	280	247	2631480002
0431164281	1	6.3 .250	20.0 .788	6.6 .260	39.4 1.550	9.8 .385	26	28	83	105	180	310	240	2631540002
0431178281	1	8.7 .343	21.5 .846	9.0 .354	39.4 1.550	10.55 .415	23	18	63	85	130	250	275	2631665702
0431167281	1	9.85 .388	23.7 .933	10.15 .400	39.4 1.550	11.7 .461	33	18	56	81	144	240	270	2631626402
0431164181	1	12.7 .500	31.0 1.220	13.05 .514	39.4 1.550	15.25 .600	61	25	71	100	156	260	260	2631102002
0431176451	1	18.0 .709	38.6 1.520	18.35 .722	47.5 1.870	19.15 .755	161	47	95	130	225	380	370	2631103002
0431173551	2	18.5 .728	29.2 1.150	18.8 .740	42.0 1.65	14.7 .579	78	16	48	69	125	220	310	2631103102
0431177081	1	25.4 1.000	56.4 2.220	25.9 1.020	42.95 1.690	27.45 1.080	308	45	90	125	218	375	340	2631626202

## Broadband Frequencies 25-300 MHz (43 & 44 materials)

Part Number	Fig.	Max. Cable Diameter	A	B**	C	D	E	Wt. (g)	Typical Impedance( $\Omega$ )				Solid Equivalent*
									10 MHz	25 MHz <sup>+</sup>	100 MHz <sup>+</sup>	250 MHz	
0443178181	1	4.1 .161	11.8 .465	4.3 .169	23.2 .913	5.6 .221		4.2	40	70	125	152	
0444173951	1	4.9 .193	12.8 .504	5.1 .201	25.0 .984	5.6 .220		6.5	54	94	150	187	2643023002
0444164951	1	4.9 .193	17.3 .680	5.1 .201	38.2 1.420	8.4 .331		17	90	144	245	257	2643480002
0443164251	2	6.3 .250	17.9 .705	6.6 .260	32.2 1.270	9.2 .362		31	100	163	275	275	2643540002
0444164281	1	6.3 .250	20.0 .788	6.6 .260	39.4 1.550	9.8 .385		26	95	156	260	270	2643540002
0443625006	3	7.6 .299	24.7 .972	7.9 .311	22.8 .898	10.2 .402	17.8 .701	13	27	50	113	188	2643625002
0443178281	1	8.7 .343	21.5 .846	9.0 .354	39.4 1.550	10.55 .415		24	65	120	230	265	2643665702
0443665806	3	9.2 .362	26.3 1.035	9.5 .374	21.4 .843	11.0 .433	16.4 .646	13	23	41	88	122	2643665802

\* For solid cable cores see pages 32 and 70-74

<sup>+</sup> Test frequency

\*\* "B" dimension is the core dimension.

# Fair-Rite Products Corp.

Phone: (888) FAIR RITE / (845) 895-2055 • FAX: (888) FERRITE / (845) 895-2629  
(888) 324-7748 (888) 337-7483

PO Box J, One Commercial Row, Wallkill, NY 12589-0288

• www.fair-rite.com  
• E-Mail: ferrites@fair-rite.com

# Round Cable Snap-its

Listed by frequency range and in ascending order of cable diameter.

## Broadband Frequencies 25-300 MHz (43 & 44 materials)

Dimensions (Bold numbers are in millimeters, light numbers are nominal in inches.)

Part Number	Fig.	Max. Cable Diameter	A	B**	C	D	E	Wt. (g)	Typical Impedance( $\Omega$ )				Solid Equivalent*
									10 MHz	25 MHz <sup>+</sup>	100 MHz <sup>+</sup>	250 MHz	
0443167251	2	<b>9.85</b> .388	<b>22.1</b> .870	<b>10.15</b> .400	<b>32.3</b> 1.272	<b>11.0</b> .433		42	79	138	225	285	2643626402
0444167281	1	<b>9.85</b> .388	<b>23.7</b> .933	<b>10.15</b> .400	<b>39.4</b> 1.550	<b>11.7</b> .460		33	77	125	210	260	2643626402
0443164151	2	<b>12.7</b> .500	<b>29.0</b> 1.142	<b>13.05</b> .514	<b>32.5</b> 1.280	<b>14.8</b> .583		84	90	156	250	305	2643102002
0444164181	1	<b>12.7</b> .500	<b>31.0</b> 1.220	<b>13.05</b> .514	<b>39.4</b> 1.550	<b>15.25</b> .600		61	76	138	230	280	2643102002
0443800506	3	<b>12.8</b> .504	<b>29.7</b> 1.169	<b>13.2</b> .520	<b>20.6</b> .811	<b>12.7</b> .500	<b>15.6</b> .614	16	18	35	75	120	2643800502
0443806406	3	<b>15.0</b> .591	<b>34.3</b> 1.360	<b>15.5</b> .610	<b>21.2</b> .835	<b>15.0</b> .591	<b>16.2</b> .638	23	24	43	90	147	2643806402
0444176451	1	<b>18.0</b> .709	<b>38.6</b> 1.520	<b>18.35</b> .722	<b>47.5</b> 1.870	<b>19.15</b> .755		161	100	175	365	365	2643103002
0444173551	2	<b>18.5</b> .728	<b>29.2</b> 1.150	<b>18.8</b> .740	<b>42.0</b> 1.650	<b>14.7</b> .579		78	50	95	195	322	2643103102
0444177081	1	<b>25.4</b> 1.000	<b>56.4</b> 2.220	<b>25.9</b> 1.020	<b>42.95</b> 1.690	<b>27.45</b> 1.080		308	115	194	335	330	2643626202

## Broadband Frequencies 25-300 MHz (Economical 46 material)

Part Number	Fig.	Max. Cable Diameter	A	B**	C	D	E	Wt. (g)	Typical Impedance( $\Omega$ )				Solid Equivalent*
									10 MHz	25 MHz	100 MHz <sup>+</sup>	250 MHz	
0446173951	1	<b>4.9</b> .193	<b>12.8</b> .504	<b>5.1</b> .201	<b>25.0</b> .984	<b>5.6</b> .220		6.5	46	82	135	185	
0446164951	1	<b>4.9</b> .193	<b>17.3</b> .680	<b>5.1</b> .201	<b>38.2</b> 1.420	<b>8.4</b> .331		17	72	120	220	250	2646480002
0446164281	1	<b>6.3</b> .250	<b>20.0</b> .788	<b>6.6</b> .260	<b>39.4</b> 1.550	<b>9.8</b> .385		26	81	131	235	265	2646540002
0446164251	2	<b>6.3</b> .250	<b>17.9</b> .705	<b>6.6</b> .260	<b>32.2</b> 1.270	<b>9.2</b> .362		31	81	134	245	273	2646540002
0446167281	1	<b>9.85</b> .388	<b>23.7</b> .933	<b>10.15</b> .400	<b>39.4</b> 1.550	<b>11.7</b> .460		33	66	105	190	275	
0446167251	2	<b>9.85</b> .388	<b>22.1</b> .870	<b>10.15</b> .400	<b>32.3</b> 1.272	<b>11.0</b> .433		42	72	116	202	247	
0446164181	1	<b>12.7</b> .500	<b>31.0</b> 1.220	<b>13.05</b> .514	<b>39.4</b> 1.550	<b>15.25</b> .600		61	73	115	205	275	2646102002
0446164151	2	<b>12.7</b> .500	<b>29.0</b> 1.142	<b>13.05</b> .514	<b>32.5</b> 1.280	<b>14.8</b> .583		84	84	127	225	270	2646102002
0446176451	1	<b>18.0</b> .709	<b>38.6</b> 1.520	<b>18.35</b> .722	<b>47.5</b> 1.870	<b>19.15</b> .755		161	85	137	330	360	2646103002
0446173551	2	<b>18.5</b> .728	<b>29.2</b> 1.150	<b>18.8</b> .740	<b>42.0</b> 1.650	<b>14.7</b> .579		78	48	85	176	300	
0446177081	1	<b>25.4</b> 1.000	<b>56.4</b> 2.220	<b>25.9</b> 1.020	<b>42.95</b> 1.690	<b>27.45</b> 1.080		308	97	169	330	330	2646626202

\* For solid cable cores see pages 70-74

<sup>+</sup> Test frequency

\*\* "B" dimension is the core dimension.

# Fair-Rite Products Corp.

PO Box J, One Commercial Row, Wallkill, NY 12589-0288

Phone: (888) FAIR RITE / (845) 895-2055 • FAX: (888) FERRITE / (845) 895-2629 • www.fair-rite.com  
(888) 324-7748 (888) 337-7483 • E-Mail: ferrites@fair-rite.com

# Round Cable Snap-its

Listed by frequency range and in ascending order of cable diameter.

## Higher Frequencies 200-1000 MHz (61 material)

Dimensions (Bold numbers are in millimeters, light numbers are nominal in inches.)

Part Number	Fig.	Max. Cable Diameter	A	B**	C	D	Wt. (g)	Typical Impedance( $\Omega$ )				Solid Equivalent*
								100 MHz	250 MHz <sup>+</sup>	500 MHz <sup>+</sup>	1000 MHz	
0461178181	1	4.1 .161	11.8 .465	4.3 .169	23.2 .913	5.6 .221	42	115	165	215	300	
0461164951	1	4.9 .193	17.3 .620	5.1 .201	38.2 1.420	8.4 .331	17	215	325	385	332	
0461164281	1	6.3 .250	20.0 .788	6.6 .260	39.4 1.550	9.8 .385	26	230	355	425	420	2661540002
0461178281	1	8.7 .343	21.5 .846	9.0 .354	39.4 1.550	10.55 .415	24	180	285	380	430	2661665702
0461167281	1	9.85 .388	23.7 .933	10.15 .400	39.4 1.550	11.7 .460	33	175	275	375	400	2661626402
0461164181	1	12.7 .500	31.0 1.220	13.05 .514	39.4 1.550	15.25 .600	61	205	320	435	257	2661102002
0461176451	1	18.0 .709	38.6 1.520	18.35 .722	47.5 1.870	19.15 .755	161	360	480	350	110	

\* For solid cable cores see pages 70-74

<sup>+</sup> Test frequency

\*\* "B" dimension is the core dimension.

## Fair-Rite Products Corp.

PO Box J, One Commercial Row, Wallkill, NY 12589-0288

Phone: (888) FAIR RITE / (845) 895-2055 • FAX: (888) FERRITE / (845) 895-2629  
(888) 324-7748 (888) 337-7483

• www.fair-rite.com  
• E-Mail: ferrites@fair-rite.com

# Split Round Cable EMI Suppression Cores

Listed by frequency and in ascending order of cable diameter.

Split round cable suppression cores can be used on cables and wire harnesses with diameters ranging from 2.5 mm (.100") to 25.4 mm (1.000"). These cores are available in three ferrite material grades to attenuate conducted differential and common-mode EMI from 1 MHz into the GHz region.

- Split round cable suppression cores are controlled for impedances only. The impedances listed are typical values. Minimum impedance values are specified for the + marked frequencies. The minimum guaranteed impedance is the listed impedance less 20%.
- Single turn impedance tests for the 31, 43, 44 and 46 material are performed on the 4193A Vector Impedance Analyzer. The 61 material parts are tested on the 4191A RF Impedance Analyzer. **Cores are tested with the shortest practical wire length.**
- Over-molding, heat shrink tubing or any other suitable mechanical arrangement can be utilized to clamp split cable cores together. Many of these split round cable cores can be supplied as Round Snap-It assemblies. The first two digits change from 26 to 04. See pages 75 - 78 for the listing of Round Cable Snap-Its.
- Many of the split round cable suppression cores have round cable core equivalents. See section Round Cable EMI Suppression Cores on pages 70-74.
- Performance curves of all listed split round cable suppression cores are compiled on the Fair-Rite CD-ROM.
- The "Expanded Cable and Suppressor Kit" (part number 0199000005) contains a selection of these split round cable suppression cores. For details see page 67.
- Explanation of Part Numbers: Digits 1&2 = product class and 3&4 material grade.

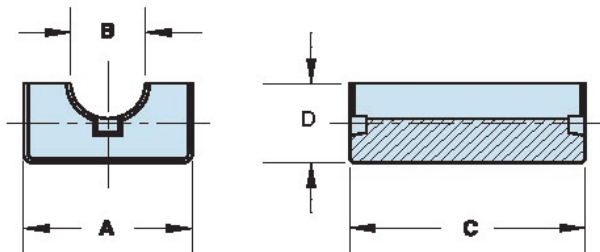

Figure 1

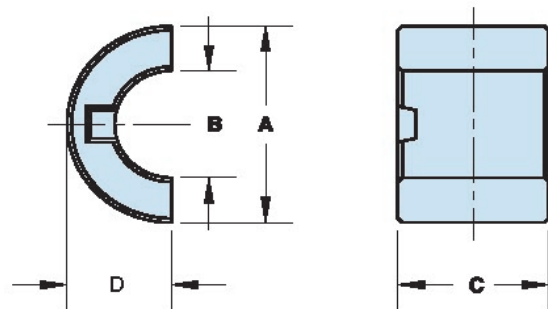

Figure 2

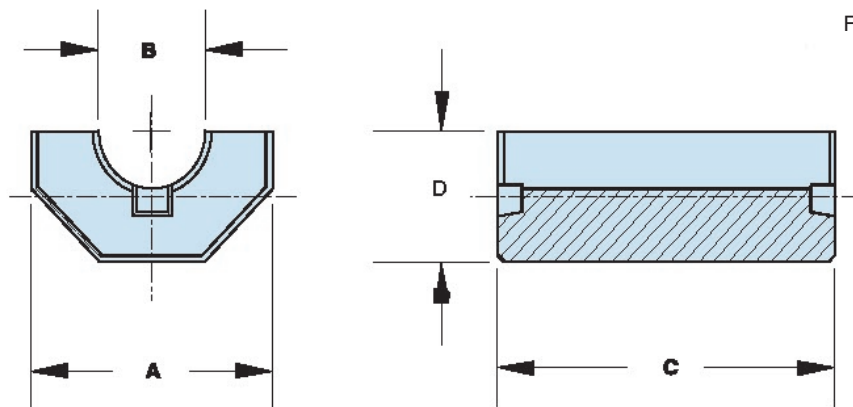

Figure 3

**Fair-Rite Products Corp.** PO Box J, One Commercial Row, Wallkill, NY 12589-0288

Phone: (888) FAIR RITE / (845) 895-2055 • FAX: (888) FERRITE / (845) 895-2629  
(888) 324-7748 (888) 337-7483

• www.fair-rite.com  
• E-Mail: ferrites@fair-rite.com

# Split Round Cable EMI Suppression Cores

Listed by frequency and in ascending order of cable diameter.

## Lower & Broadband Frequencies 1-300 MHz (31 material)

Dimensions (Bold numbers are in millimeters, light numbers are nominal in inches.)

Part Number	Fig.	Max. Cable Diameter	A	B**	C	D	Wt. (g)	Typical Impedance( $\Omega$ )						Solid Equivalent*
								1 MHz	5 MHz	10 MHz <sup>+</sup>	25 MHz <sup>+</sup>	100 MHz <sup>+</sup>	250 MHz	
2631178181	3	<b>4.1</b> .161	<b>9.0 ± 0.25</b> .354	<b>4.3 ± 0.2</b> .169	<b>18.0 ± 0.5</b> .709	<b>4.2 ± 0.15</b> .166	2.0	12	43	60	90	160	183	
2631173951	3	<b>4.9</b> .193	<b>10.0 ± 0.25</b> .394	<b>5.1 ± 0.2</b> .201	<b>19.8 ± 0.5</b> .780	<b>4.6 ± 0.15</b> .181	2.8	14	44	60	100	180	208	2631023002
2631164951	3	<b>4.9</b> .193	<b>12.3 ± 0.45</b> .484	<b>5.1 ± 0.2</b> .201	<b>25.4 ± 0.75</b> 1.000	<b>6.15 ± 0.2</b> .242	6.6	25	75	100	169	280	247	2631480002
2631164281	3	<b>6.3</b> .250	<b>15.0 ± 0.25</b> .590	<b>6.6 ± 0.3</b> .260	<b>28.9 ± 0.6</b> 1.125	<b>7.5 ± 0.15</b> .295	11	28	83	105	180	310	240	2631540002
2631178281	3	<b>8.7</b> .343	<b>16.5 ± 0.4</b> .648	<b>9.0 ± 0.3</b> .354	<b>28.6 ± 0.8</b> 1.126	<b>8.25 ± 0.15</b> .325	9.9	18	63	85	130	250	275	2631665702
2631167281	3	<b>9.85</b> .388	<b>18.6 ± 0.45</b> .732	<b>10.15 ± 0.3</b> 400	<b>28.9 ± 0.6</b> 1.138	<b>9.5 ± 0.25</b> .375	14	18	56	81	144	240	270	2631626402
2631164181	3	<b>12.7</b> .500	<b>25.9 ± 0.5</b> 1.020	<b>13.05 ± 0.3</b> .514	<b>28.9 ± 0.6</b> 1.138	<b>12.95 ± 0.25</b> .510	27	25	71	100	156	260	260	2631102002
2631176451	3	<b>18.0</b> .709	<b>34.9 ± 0.65</b> 1.374	<b>18.35 ± 0.35</b> .722	<b>44.35 ± 0.35</b> 1.746	<b>17.45 ± 0.3</b> .687	76	47	95	130	225	380	370	2631103002
2631173551	1	<b>18.5</b> .728	<b>25.9 ± 0.5</b> 1.020	<b>18.8 ± 0.3</b> .740	<b>38.9 ± 0.4</b> 1.532	<b>13.0 ± 0.25</b> .512	35	16	48	69	125	220	310	2631103102
2631177081	3	<b>25.4</b> 1.000	<b>50.8 ± 1.0</b> 2.000	<b>25.9 ± 0.5</b> 1.030	<b>37.45 ± 0.75</b> 1.474	<b>25.4 ± 0.5</b> 1.000	145	45	90	125	218	375	340	2631626202

## Broadband Frequencies 25-300 MHz (43 & 44 material)

Part Number	Fig.	Max. Cable Diameter	A	B**	C	D	Wt. (g)	Typical Impedance( $\Omega$ )				Solid Equivalent*
								10 MHz	25 MHz <sup>+</sup>	100 MHz <sup>+</sup>	250 MHz	
2643166751	1	<b>2.3</b> .090	<b>7.65 - 0.25</b> .296	<b>2.3 ± 0.25</b> .095	<b>7.8 - 0.5</b> .297	<b>3.9 - 0.25</b> .148	1.0	30	60	93	105	2643000801
2643178181	3	<b>4.1</b> .161	<b>9.0 ± 0.25</b> .354	<b>4.3 ± 0.2</b> .169	<b>18.0 ± 0.5</b> .709	<b>4.2 ± 0.15</b> .166	2.0	40	70	125	152	
2644173951	3	<b>4.9</b> .193	<b>10.0 ± 0.25</b> .394	<b>5.1 ± 0.2</b> .201	<b>19.8 ± 0.5</b> .780	<b>4.6 ± 0.15</b> .181	2.8	54	94	150	187	2643023002
2644164951	3	<b>4.9</b> .193	<b>12.3 ± 0.45</b> .484	<b>5.1 ± 0.2</b> .201	<b>25.4 ± 0.75</b> 1.000	<b>6.15 ± 0.2</b> .242	6.6	90	144	245	257	2643480002
2643164251	1	<b>6.3</b> .250	<b>15.0 ± 0.25</b> .590	<b>6.6 ± 0.3</b> .260	<b>28.6 ± 0.8</b> 1.125	<b>7.5 ± 0.15</b> .295	14	100	163	275	275	2643540002
2644164281	3	<b>6.3</b> .250	<b>15.0 ± 0.25</b> .590	<b>6.6 ± 0.3</b> .260	<b>28.9 ± 0.6</b> 1.125	<b>7.5 ± 0.15</b> .295	11	95	156	260	270	2643540002
2643165451	1	<b>6.3</b> .250	<b>15.0 ± 0.25</b> .590	<b>6.6 ± 0.3</b> .260	<b>15.25 ± 0.6</b> .600	<b>7.5 ± 0.15</b> .295	7.0	52	94	155	232	
2643625006	2	<b>7.6</b> .300	<b>15.9 ± 0.4</b> .626	<b>7.9 ± 0.3</b> .311	<b>14.3 ± 0.4</b> .563	<b>7.95 ± 0.2</b> .313	5.3	27	50	113	188	2643625002
2643178281	3	<b>8.7</b> .343	<b>16.5 ± 0.4</b> .648	<b>9.0 ± 0.3</b> .354	<b>28.6 ± 0.8</b> 1.126	<b>8.25 ± 0.15</b> .325	9.9	65	120	230	265	2643665702
2643665806	2	<b>9.3</b> .365	<b>17.5 ± 0.5</b> .689	<b>9.5 ± 0.3</b> .374	<b>12.7 ± 0.4</b> .500	<b>8.75 ± 0.25</b> .344	5.1	23	41	88	122	2643665802

\* For solid cable cores see pages 31-32 and 70-74

<sup>+</sup> Test frequency

\*\* "B" dimension is the core dimension.

## Fair-Rite Products Corp.

Phone: (888) FAIR RITE / (845) 895-2055 • FAX: (888) FERRITE / (845) 895-2629  
(888) 324-7748

PO Box J, One Commercial Row, Wallkill, NY 12589-0288

• www.fair-rite.com  
• E-Mail: ferrites@fair-rite.com



# Split Round Cable EMI Suppression Cores

Listed by frequency and in ascending order of cable diameter.

## Broadband Frequencies 25-300 MHz (43 & 44 material)

Dimensions (Bold numbers are in millimeters, light numbers are nominal in inches.)

Part Number	Fig.	Max. Cable Diameter	A	B**	C	D	Wt. (g)	Typical Impedance( $\Omega$ )				Solid Equivalent*
								10 MHz	25 MHz <sup>+</sup>	100 MHz <sup>+</sup>	250 MHz	
2643167251	1	9.85 .388	18.65±0.4 .735	10.15±0.3 .400	28.6±0.8 1.125	9.4±0.15 .370	19	79	138	225	285	2643626402
2644167281	3	9.85 .388	18.6±0.45 .732	10.15±0.3 .400	28.9±0.6 1.138	9.5±0.25 .375	14	77	125	210	260	2643626402
2643164151	1	12.7 .500	25.9±0.5 1.020	13.05±0.3 .514	28.6±0.8 1.125	12.95±0.25 .510	39	90	156	250	305	2643102002
2644164181	3	12.7 .500	25.9±0.5 1.020	13.05±0.3 .514	28.9±0.6 1.138	12.95±0.25 .510	27	76	138	230	280	2643102002
2643800506	2	12.8 .504	21.0±0.5 .827	13.2±0.4 .520	11.9±0.4 .469	10.5±0.25 .413	6.3	18	35	75	120	2643800502
2643806406	2	15.0 .591	25.4±0.6 1.000	15.5±0.5 .610	12.7±0.4 .500	12.7±0.3 .500	9.9	24	43	90	147	2643806402
2644176451	3	18.0 .709	34.9±0.65 1.374	18.35±0.35 .722	44.35±0.35 1.746	17.45±0.3 .687	76	100	175	365	365	2643103002
2644173551	1	18.5 .728	25.9±0.5 1.020	18.8±0.3 .740	38.9±0.4 1.532	13.0±0.25 .512	35	50	95	195	322	2643103102
2644177081	3	25.4 1.000	50.8±1.0 2.000	25.9±0.5 1.030	37.45±0.75 1.474	25.4±0.5 1.000	145	115	194	335	350	2643626202

## Broadband Frequencies 25-300 MHz (Economical 46 material)

Part Number	Fig.	Max. Cable Diameter	A	B**	C	D	Wt. (g)	Typical Impedance( $\Omega$ )				Solid Equivalent*
								10 MHz	25 MHz	100 MHz <sup>+</sup>	250 MHz	
2646173951	3	4.9 .193	10.0±0.25 .394	5.1±0.2 .201	19.8±0.5 .780	4.6±0.15 .181	2.8	46	82	135	185	
2646164951	3	4.9 .193	12.3±0.45 .484	5.1±0.2 .201	25.4±0.75 1.000	6.15±0.2 .242	6.6	72	120	220	250	2646800002
2646164251	1	6.3 .250	15.0±0.25 .590	6.6±0.3 .260	28.6±0.8 1.125	7.5±0.15 .295	14	81	134	245	273	2646540002
2646164281	3	6.3 .250	15.0±0.25 .590	6.6±0.3 .260	28.9±0.6 1.125	7.5±0.15 .295	11	81	131	235	265	2646540002
2646167281	3	9.85 .388	18.6±0.45 .732	10.15±0.3 .400	28.9±0.6 1.138	9.5±0.25 .375	14	66	105	190	275	
2646167251	1	9.85 .388	18.65±0.4 .735	10.15±0.3 .400	28.6±0.8 1.125	9.4±0.15 .370	19	72	116	202	247	
2646164181	3	12.7 .500	25.9±0.5 1.020	13.05±0.3 .514	28.9±0.6 1.138	12.95±0.25 .510	27	73	115	205	275	2646102002
2646164151	1	12.7 .500	25.9±0.5 1.020	13.05±0.3 .514	28.6±0.8 1.125	12.95±0.25 .510	39	84	127	225	270	2646102002
2646176451	3	18.0 .709	34.9±0.65 1.374	18.35±0.35 .722	44.35±0.35 1.746	17.45±0.3 .687	76	85	152	330	360	2646103002
2646173551	1	18.5 .728	25.9±0.5 1.020	18.8±0.3 .740	38.9±0.4 1.532	13.0±0.25 .512	35	48	85	176	300	
2646177081	3	25.4 1.000	50.8±1.0 2.000	25.9±0.5 1.030	37.45±0.75 1.474	25.4±0.5 1.000	145	97	169	330	330	2646626202

\* For solid cable cores see pages 70-74

<sup>+</sup> Test frequency

\*\* "B" dimension is the core dimension.

## Fair-Rite Products Corp.

PO Box J, One Commercial Row, Wallkill, NY 12589-0288

Phone: (888) FAIR RITE / (845) 895-2055 • FAX: (888) FERRITE / (845) 895-2629  
(888) 324-7748 (888) 337-7483

• www.fair-rite.com  
• E-Mail: ferrites@fair-rite.com



# Split Round Cable EMI Suppression Cores

Listed by frequency and in ascending order of cable diameter.

## Higher Frequencies 200-1000 MHz (61 material)

Dimensions (Bold numbers are in millimeters, light numbers are nominal in inches.)

Part Number	Fig.	Max. Cable Diameter	A	B**	C	D	Wt. (g)	Typical Impedance( $\Omega$ )				Solid Equivalent*
								100 MHz <sup>+</sup>	250 MHz <sup>+</sup>	500 MHz <sup>+</sup>	1000 MHz	
2661178181	3	<b>4.1</b> .161	<b>9.0±0.25</b> .354	<b>4.5±0.2</b> .169	<b>18.0±0.5</b> .709	<b>4.2±0.15</b> .166	2.0	115	165	215	300	
2661164951	3	<b>4.9</b> .193	<b>12.3±0.45</b> .484	<b>5.1±0.2</b> .201	<b>25.4±0.75</b> 1.000	<b>6.15±0.2</b> .242	6.6	215	325	385	332	
2661164281	3	<b>6.3</b> .250	<b>15.0±0.25</b> .590	<b>6.6±0.3</b> .260	<b>28.9±0.6</b> 1.125	<b>7.5±0.15</b> .295	11	230	355	425	420	<b>2661540002</b>
2661178281	3	<b>8.7</b> .343	<b>16.5±0.4</b> .648	<b>9.0±0.3</b> .354	<b>28.6±0.8</b> 1.126	<b>8.25±0.15</b> .325	9.9	180	285	380	430	<b>2661665702</b>
2661167281	3	<b>9.85</b> .388	<b>18.6±0.45</b> .732	<b>10.15±0.3</b> .400	<b>28.9±0.6</b> 1.138	<b>9.5±0.25</b> .375	14	175	275	375	400	<b>2661626402</b>
2661164181	3	<b>12.7</b> .500	<b>25.9±0.5</b> 1.020	<b>13.05±0.3</b> .514	<b>28.9±0.6</b> 1.138	<b>12.95±0.25</b> .510	27	205	320	435	257	<b>2661102002</b>
2661176451	3	<b>18.0</b> .709	<b>34.9±0.65</b> 1.374	<b>18.35±0.35</b> .722	<b>44.35±0.35</b> 1.746	<b>17.45±0.3</b> .687	76	360	400	350	110	

\* For solid cable cores see pages 70-74

<sup>+</sup> Test frequency

\*\* "B" dimension is the core dimension.

# Flat Cable EMI Suppression Cores

*Listed by frequency range and in ascending order of cable width.*

Flat cable suppression core can accommodate multi-conductors flat cables, in widths from 12.7 mm (.500") up to 78 mm (3.1"). These flat cable cores are available in two ferrite material grades to reduce conducted EMI from 1 MHz into the hundreds of MHz.

- Flat cable suppression cores, split or single cores, are controlled for impedances only. The impedances listed are typical values. Minimum impedance values are specified for the + marked frequencies. The minimum guaranteed impedance is the listed impedance less 20%.
- Single turn impedance tests for the 31 and 43 material are made on the 4193A Vector Impedance Analyzer.  
**All tests are made with the shortest practical wire length.**
- Performance curves for all flat cable parts are compiled on the Fair-Rite Products CD-ROM.
- Assembly clips are available for most of the split flat cable cores. See pages 86-87 for a listing of flat cable cores and the clips that can be used with these cores.
- Our "Expanded Cable & Connector EMI Suppressor Kit" (part number 0199000005) contains a selection of these flat cable cores and clips. See page 67.
- Explanation of Part Numbers: Digits 1&2 = product class and 3&4 = material grade.

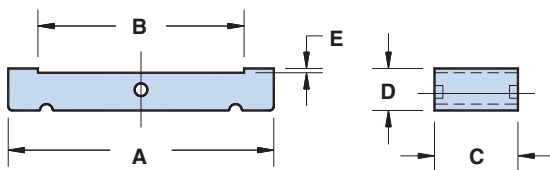

Figure 1

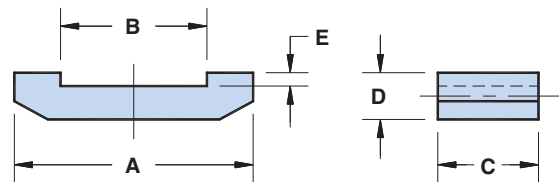

Figure 2

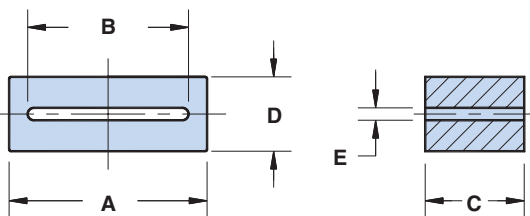

Figure 3

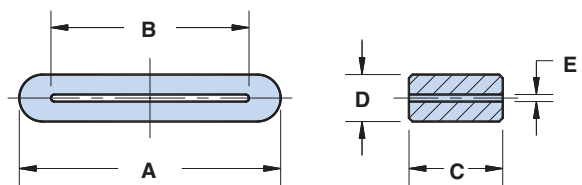

Figure 4

## Fair-Rite Products Corp.

PO Box J, One Commercial Row, Wallkill, NY 12589-0288

Phone: (888) FAIR RITE / (845) 895-2055 • FAX: (888) FERRITE / (845) 895-2629 • www.fair-rite.com  
(888) 324-7748 (888) 337-7483 • E-Mail: ferrites@fair-rite.com

# Flat Cable EMI Suppression Cores

Listed by frequency range in ascending order of cable width.

## Lower & Broadband Frequencies 1-300 MHz (31 material)

Dimensions (Bold numbers are in millimeters, light numbers are nominal in inches.)

Part Number	Fig.	Max. Cable Dimensions	A	B	C	D	E	Wt. (g)	Typical Impedance( $\Omega$ )					
									1 MHz	5 MHz	10 MHz <sup>+</sup>	25 MHz <sup>+</sup>	100 MHz <sup>+</sup>	250 MHz
2631163851	3	25.9 x 1.5 1.020 x .060	38.1±1.0 1.500	26.65±0.75 1.050	25.4±0.75 1.000	12.05±0.4 .475	1.9±0.4 .075	51	20	52	68	112	240	440
2631163951*	1	51.0 x 1.3 2.000 x .050	63.5±1.3 2.500	52.1±1.1 2.050	28.6±0.8 1.125	6.35±0.25 .250	0.85±0.2 .033	50	13	35	54	105	300	425
2631164051*	1	64.0 x 1.3 2.520 x .050	76.2±1.5 3.000	65.3±1.3 2.570	28.6±0.8 1.125	6.35±0.25 .250	0.85±0.2 .033	60	11	34	52	105	310	440

## Broadband Frequencies 25-300 MHz (43 material)

Part Number	Fig.	Max. Cable Dimensions	A	B	C	D	E	Wt. (g)	Typical Impedance( $\Omega$ )			
									10 MHz	25 MHz <sup>+</sup>	100 MHz <sup>+</sup>	250 MHz
2643170251	2	12.2 x 2.3 .480 x .091	22.75±0.65 .895	12.7±0.5 .500	12.7±0.5 .500	3.3 - 0.25 .125	1.15±0.25 .050	3.5	20	35	70	135
2643178451	4	13.1 x 1.35 .516 x .053	18.5±0.4 .728	13.5±0.4 .531	6.0±0.3 .236	6.6±0.25 .260	1.6±0.25 .063	2.9	15	25	48	90
2643178351	4	13.1 x 1.35 .516 x .053	18.5±0.4 .728	13.5±0.4 .531	12.0±0.3 .472	6.6±0.25 .260	1.6±0.25 .063	5.9	31	48	82	140
2643169552	3	13.95 x 0.75 .549 x .030	19.95±0.4 .785	14.2±0.25 .560	10.15±0.5 .400	6.35±0.25 .250	0.9±0.15 .035	5.7	25	40	90	160
2643168751	3	17.3 x 2.3 .681 x .091	25.4±0.75 1.000	17.8±0.5 .700	12.7±0.4 .500	10.15±0.25 .400	2.55±0.25 .100	13	31	50	95	200
2643173351	4	19.6 x 0.5 .772 x .020	24.5±0.4 .965	20.0±0.4 .787	12.0±0.3 .472	5.0±0.25 .197	0.75±0.25 .030	6.6	23	39	88	157
2643178651	4	21.1 x 1.35 .831 x .053	26.5±0.4 1.043	21.5±0.4 .846	6.0±0.3 .236	6.6±0.25 .260	1.6±0.25 .063	4.1	13	22	50	95
2643178551	4	21.1 x 1.35 .831 x .053	26.5±0.4 1.043	21.5±0.4 .846	12.0±0.3 .472	6.6±0.25 .260	1.6±0.25 .063	8.2	24	38	82	155
2643168651	2	25.4 x 12.2 1.000 x .480	38.85±0.75 1.530	26.15±0.75 1.030	28.6±0.7 1.125	13.0±0.3 .512	6.35±0.25 .255	45	57	100	188	295
2643164551	3	25.9 x 1.5 1.020 x .059	38.1±1.0 1.500	26.65±0.75 1.050	12.3±0.4 .485	12.05±0.4 .475	1.9±0.4 .075	25	33	53	105	215
2643171051*	1	25.9 x 1.3 1.020 x .051	38.1±1.0 1.500	26.65±0.75 1.050	12.7±0.4 .500	6.35±0.25 .250	0.85±0.2 .033	14	32	53	112	235

\* For assembly clips see page 86.

<sup>+</sup> Test frequency

## Fair-Rite Products Corp.

PO Box J, One Commercial Row, Wallkill, NY 12589-0288

Phone: (888) FAIR RITE / (845) 895-2055 • FAX: (888) FERRITE / (845) 895-2629 • www.fair-rite.com  
(888) 324-7748 (888) 337-7483 • E-Mail: ferrites@fair-rite.com

# Flat Cable EMI Suppression Cores

Listed by frequency range in ascending order of cable width.

## Broadband Frequencies 25-300 MHz (43 material)

Dimensions (Bold numbers are in millimeters, light numbers are nominal in inches.)

Part Number	Fig.	Max. Cable Dimensions	A	B	C	D	E	Wt. (g)	Typical Impedance( $\Omega$ )			
									10 MHz	25 MHz <sup>+</sup>	100 MHz <sup>+</sup>	250 MHz
2643166851*	1	<b>25.9 x 1.3</b> 1.020 x .051	<b>38.1±1.0</b> 1.500	<b>26.65±0.75</b> 1.050	<b>25.4±0.75</b> 1.000	<b>6.35±0.25</b> .250	<b>0.85±0.2</b> .033	27	66	115	235	410
2643163851	3	<b>25.9 x 1.5</b> 1.020 x .059	<b>38.1±1.0</b> 1.500	<b>26.65±0.75</b> 1.050	<b>25.4±0.75</b> 1.000	<b>12.05±0.4</b> .475	<b>1.9±0.4</b> .075	51	64	105	220	385
2643178851	4	<b>26.1 x 1.35</b> 1.028 x .053	<b>31.5±0.4</b> 1.240	<b>26.5±0.4</b> 1.043	<b>6.0±0.3</b> .236	<b>6.6±0.25</b> .260	<b>1.6±0.25</b> .063	4.8	12	22	55	94
2643178751	4	<b>26.1 x 1.35</b> 1.028 x .053	<b>31.5±0.4</b> 1.240	<b>26.5±0.4</b> 1.043	<b>12.0±0.3</b> .472	<b>6.6±0.25</b> .260	<b>1.6±0.25</b> .063	9.7	22	37	85	157
2643172551	4	<b>26.5 x 1.25</b> 1.043 x .049	<b>33.5±0.65</b> 1.319	<b>27.0±0.5</b> 1.063	<b>8.0±0.4</b> .315	<b>6.5±0.25</b> .256	<b>1.25±0.7</b> .063	6.8	12	22	58	106
2643169351	3	<b>27.0 x 1.1</b> 1.063 x .043	<b>33.65±0.75</b> 1.325	<b>27.5±0.5</b> 1.083	<b>13.2±0.5</b> .520	<b>6.7±0.4</b> .265	<b>1.35±0.25</b> .053	12	22	39	98	192
2643166451*	1	<b>26.95 x 3.05</b> 1.061 x .120	<b>38.35±1.0</b> 1.510	<b>27.95±1.0</b> 1.100	<b>28.6±0.7</b> 1.125	<b>9.0±0.3</b> .355	<b>3.3±0.25</b> .130	35	61	96	185	335
2643168051	1	<b>32.3 x 6.2</b> 1.272 x .244	<b>52.9±1.0</b> 2.083	<b>33.0±0.7</b> 1.299	<b>31.25±1.0</b> 1.230	<b>12.5±0.4</b> .492	<b>3.5±0.4</b> .138	84	81	140	265	400
2643167551	1	<b>32.3 x 6.2</b> 1.272 x .244	<b>52.9±1.0</b> 2.083	<b>33.0±0.7</b> 1.299	<b>63.5±1.8</b> 2.500	<b>12.5±0.4</b> .492	<b>3.5±0.4</b> .138	170	150	270	480	370
2643170951*	1	<b>33.7 x 1.3</b> 1.327 x .051	<b>45.1±0.75</b> 1.775	<b>34.4±0.7</b> 1.355	<b>12.7±0.4</b> .500	<b>6.35±0.25</b> .250	<b>0.85±0.2</b> .033	16	25	50	115	240
2643166551	3	<b>33.7 x 1.2</b> 1.327 x .047	<b>45.1±0.75</b> 1.775	<b>34.4±0.7</b> 1.355	<b>28.6±0.7</b> 1.125	<b>12.45±0.4</b> .490	<b>1.5±0.3</b> .060	71	67	115	300	415
2643166651	1	<b>33.7 x 1.3</b> 1.327 x .051	<b>45.1±0.75</b> 1.775	<b>34.4±0.7</b> 1.355	<b>28.6±0.7</b> 1.125	<b>6.35±0.25</b> .250	<b>0.85±0.2</b> .033	36	60	110	290	435
2643168251*	1	<b>51.0 x 1.3</b> 2.008 x .051	<b>63.5±1.3</b> 2.500	<b>52.1±1.1</b> 2.050	<b>12.7±0.4</b> .500	<b>6.35±0.25</b> .250	<b>0.85±0.2</b> .033	22	22	50	125	255
2643163951*	1	<b>51.0 x 1.3</b> 2.008 x .051	<b>63.5±1.3</b> 2.500	<b>52.1±1.1</b> 2.050	<b>28.6±0.8</b> 1.125	<b>6.35±0.25</b> .250	<b>0.85±0.2</b> .033	50	56	100	290	400
2643167751*	1	<b>64.0 x 1.3</b> 2.520 x .051	<b>76.2±1.5</b> 3.000	<b>65.3±1.3</b> 2.570	<b>12.7±0.4</b> .500	<b>6.35±0.25</b> .250	<b>0.85±0.2</b> .033	27	22	45	115	240
2643164051*	1	<b>64.0 x 1.3</b> 2.520 x .051	<b>76.2±1.5</b> 3.000	<b>65.3±1.3</b> 2.570	<b>28.6±0.8</b> 1.125	<b>6.35±0.25</b> .250	<b>0.85±0.2</b> .033	60	48	100	290	420
2643168351*	1	<b>76.7 x 1.3</b> 3.020 x .051	<b>88.9±1.8</b> 3.500	<b>78.2±1.5</b> 3.080	<b>28.6±0.8</b> 1.125	<b>6.5±0.35</b> .256	<b>0.95±0.3</b> .037	70	45	100	280	440

\*For assembly clips see page 86.

<sup>+</sup> Test frequency

## Fair-Rite Products Corp.

PO Box J, One Commercial Row, Wallkill, NY 12589-0288

Phone: (888) FAIR RITE / (845) 895-2055 • FAX: (888) FERRITE / (845) 895-2629  
(888) 324-7748 (888) 337-7483

• www.fair-rite.com  
• E-Mail: ferrites@fair-rite.com

# Flat Cable Cores Assembly Clips

Fair-Rite offers several clips to accommodate the assembly of the split flat cable suppression cores.

- Figures 1 and 2 are metal clips, made from 0.5mm (.020") high carbon steel with a zinc electroplate finish.
- Figure 3 clips are a polypropylene material RoHS compliant, with a flammability rating of UL94-V0.

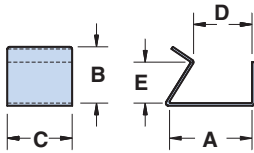

Figure 1

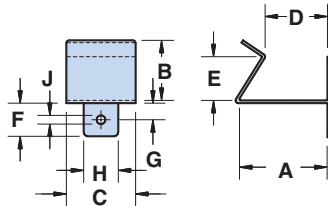

Figure 2

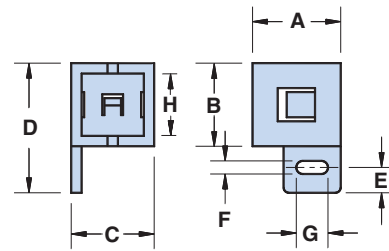

Figure 3

## Clips

Dimensions (Bold numbers are in millimeters, light numbers are nominal in inches.)

Part Number Clip	Fig.	A	B	C	D	E	F	G	H	J
0199001401	1	<b>16.1</b> .635	<b>11.0</b> .433	<b>12.7</b> .500	<b>11.4</b> .450	<b>8.0</b> .315	—	—	—	—
0199010301	2	<b>21.2</b> .835	<b>11.0</b> .433	<b>12.7</b> .500	<b>16.5</b> .650	<b>8.0</b> .315	<b>7.5</b> .295	<b>4.0</b> .157	<b>6.0</b> .236	<b>3.0</b> .118
0199016051	3	<b>16.7</b> .657	<b>15.9</b> .626	<b>15.9</b> .626	<b>24.6</b> .969	<b>4.4</b> .171	<b>3.2</b> .126	<b>6.4</b> .252	<b>13.1</b> .516	—
0199016551	3	<b>16.7</b> .657	<b>32.2</b> 1.27	<b>15.9</b> .626	<b>40.5</b> 1.59	<b>4.4</b> .171	<b>3.2</b> .126	<b>6.4</b> .252	<b>29.5</b> 1.161	—

# Flat Cable Cores Assembly Clips

	0199001401	0199010301	0199016051	0199016551
2631163951	X			X
2631164051	X			
2643163951	X			X
2643164051	X			X
2643166451		X		
2643166651	X			X
2643166851	X			
2643167751	X		X	
2643168251	X		X	
2643168351	X			X
2643170951	X		X	
2643171051	X		X	

## Fair-Rite Products Corp.

PO Box J, One Commercial Row, Wallkill, NY 12589-0288

Phone: (888) FAIR RITE / (845) 895-2055 • FAX: (888) FERRITE / (845) 895-2629  
 (888) 324-7748 (888) 337-7483

• www.fair-rite.com  
 • E-Mail: ferrites@fair-rite.com

# Flat Cable Snap-its

Listed by frequency range in ascending order of cable width.

Flat cable snap-its for use on multi-conductor flat cables to suppress common-mode conducted EMI from 1MHz to hundreds of MHz. These flat cable snap-its are available in two ferrite materials, 31 and 43.

The polypropylene cases are meeting the RoHS restrictions of hazardous substances and have a flammability rating of UL94-V0.

- Flat cable snap-it assemblies are controlled for impedances only. The impedances listed are typical values. Minimum impedance values are specified for the + marked frequencies. The minimum guaranteed impedance is the listed impedance less 20%.
- Single turn impedance tests on the 31 and 43 material parts are performed on the 4193A Vector Impedance Analyzer. **Cores are tested with the shortest practical wire length.**
- Performance curves of all listed flat cable snap-its are compiled on the Fair-Rite Products CD-ROM.
- The "Expanded Cable and Connector EMI Suppressor Kit" (part number 0199000005) contains several flat cable snap-it assemblies. See page 67.
- Explanation of Part Numbers: Digits 1&2 = product class and 3&4 material grade.

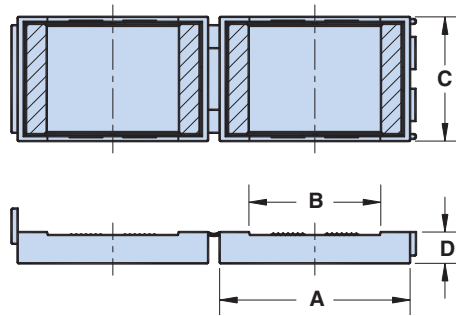

## Lower & Broadband Frequencies 1-300 MHz (31 material)

Dimensions (Bold numbers are in millimeters, light numbers are nominal in inches.)

Part Number	Max. Cable Dimensions	A	B	C	D	Wt. (g)	Typical Impedance( $\Omega$ )					
							1 MHz	5 MHz	10 MHz <sup>+</sup>	25 MHz <sup>+</sup>	100 MHz <sup>+</sup>	250 MHz
0431163951	<b>51.0 x 1.3</b> 2.000 x .050	<b>67.8</b> 2.670	<b>52.1</b> 2.050	<b>32.3</b> 1.272	<b>8.1</b> .320	110	13	35	54	105	300	425
0431164051	<b>64.0 x 1.3</b> 2.520 x .050	<b>80.8</b> 3.180	<b>65.3</b> 2.570	<b>32.3</b> 1.272	<b>8.1</b> .320	130	11	34	52	105	310	440

## Broadband Frequencies 25-300 MHz (43 material)

Part Number	Max. Cable Dimensions	A	B	C	D	Wt. (g)	Typical Impedance( $\Omega$ )			
							10 MHz	25 MHz <sup>+</sup>	100 MHz <sup>+</sup>	250 MHz
0443166651	<b>33.7 X 1.3</b> 1.325 X .050	<b>49.5</b> 1.950	<b>34.4</b> 1.350	<b>32.3</b> 1.272	<b>8.1</b> .320	80	60	110	290	435
0443163951	<b>51.0 X 1.3</b> 2.000 X .050	<b>67.8</b> 2.670	<b>52.1</b> 2.050	<b>32.3</b> 1.272	<b>8.1</b> .320	110	56	100	290	400
0443164051	<b>64.0 X 1.3</b> 2.520 X .050	<b>80.8</b> 3.180	<b>65.3</b> 2.570	<b>32.3</b> 1.272	<b>8.1</b> .320	130	48	100	290	420

<sup>+</sup> Test frequency

# Fair-Rite Products Corp.

PO Box J, One Commercial Row, Wallkill, NY 12589-0288

Phone: (888) FAIR RITE / (845) 895-2055 • FAX: (888) FERRITE / (845) 895-2629  
(888) 324-7748 (888) 337-7483

• www.fair-rite.com  
• E-Mail: ferrites@fair-rite.com



# Connector EMI Suppression Plates

To provide suppression of conducted EMI at critical interfaces Fair-Rite has available a line of suppression plates that can be used with many types of connectors. All connector plates are supplied in the NiZn 44 grade ideally suited for this application because of its high impedance along with a high resistivity.

- Connector plates are controlled for impedance only. The impedances listed are typical values. Minimum impedance values are specified for the + marked frequencies. The minimum guaranteed impedance is the listed typical impedance less 20%. Single turn impedance tests are performed on the 4193A Vector Impedance Analyzer.
- Performance curves of all listed connector plates are included on the Fair-Rite Products CD-ROM.
- For any connector EMI suppression plate requirement not listed here, feel free to contact our customer service group for availability and pricing.
- Explanation of Part Numbers: Digits 1&2 = product class and 3&4 = the 44 material grade.

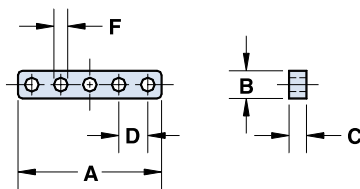

Figure 1

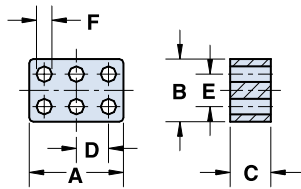

Figure 2

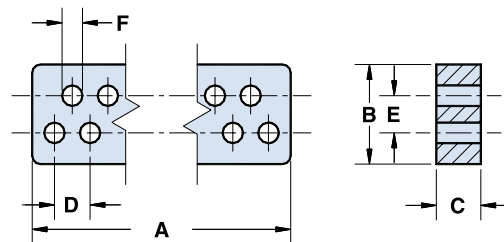

Figure 3

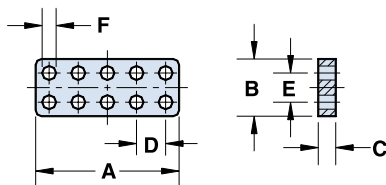

Figure 4

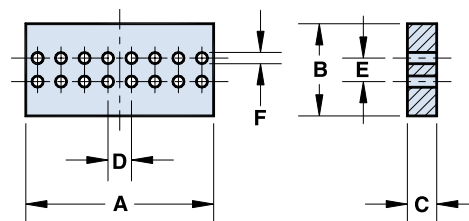

Figure 5

**Fair-Rite Products Corp.**

PO Box J, One Commercial Row, Wallkill, NY 12589-0288

Phone: (888) FAIR RITE / (845) 895-2055 • FAX: (888) FERRITE / (845) 895-2629  
(888) 324-7748 (888) 337-7483

• www.fair-rite.com  
• E-Mail: ferrites@fair-rite.com

# Connector EMI Suppression Plates

Dimensions (Bold numbers are in millimeters, light numbers are nominal in inches.)

Part Number	Figure	Total Holes	Number of Rows	A	B	C*	D	E	F	Wt (g)	Typical Impedance( $\Omega$ )	
											25 MHz <sup>+</sup>	100 MHz <sup>+</sup>
2644246701	1	5	1	<b>12.52±0.13</b> .493	<b>2.54 Max.</b> .100 Max.	<b>1.52±0.13</b> .060	<b>2.54±0.13</b> .100	—	<b>1.22±0.07</b> .048	.18	13	28
2644246201	2	6	2	<b>5.86±0.10</b> .231	<b>3.86±0.10</b> .152	<b>1.52±0.13</b> .060	<b>2.00±0.08</b> .079	<b>2.00±0.08</b> .079	<b>0.82±0.1</b> .034	.14	14	28
2644245701	2	6	2	<b>7.44±0.10</b> .293	<b>4.90±0.10</b> .193	<b>1.52±0.13</b> .060	<b>2.54±0.13</b> .100	<b>2.54±0.10</b> .100	<b>1.22±0.07</b> .048	.22	13	28
2644236101	3	9	2	<b>14.40±0.15</b> .567	<b>7.75 0.25</b> .300	<b>3.43±0.13</b> .135	<b>2.75±0.13</b> .108	<b>2.85±0.13</b> .112	<b>1.60±0.08</b> .062	1.6	30	51
2644236401	3	9	2	<b>14.40±0.15</b> .567	<b>7.75 0.25</b> .300	<b>6.86±0.13</b> .270	<b>2.75±0.13</b> .108	<b>2.85±0.13</b> .112	<b>1.60±0.08</b> .062	3.2	56	91
2644247001	4	10	2	<b>12.52±0.13</b> .493	<b>4.90±0.10</b> .193	<b>1.52±0.13</b> .060	<b>2.54±0.13</b> .100	<b>2.54±0.10</b> .100	<b>1.22±0.07</b> .048	.37	13	28
2644247101	4	10	2	<b>12.52±0.13</b> .493	<b>4.90±0.10</b> .193	<b>3.05±0.13</b> .120	<b>2.54±0.13</b> .100	<b>2.54±0.10</b> .100	<b>1.22±0.07</b> .048	.74	23	40
2644236301	3	15	2	<b>22.55±0.25</b> .888	<b>7.75 0.25</b> .300	<b>3.43±0.13</b> .135	<b>2.75±0.13</b> .108	<b>2.85±0.13</b> .112	<b>1.60±0.08</b> .062	2.4	30	51
2644236501	3	15	2	<b>22.55±0.25</b> .888	<b>7.75 0.25</b> .300	<b>6.86±0.13</b> .270	<b>2.75±0.13</b> .108	<b>2.85±0.13</b> .112	<b>1.60±0.08</b> .062	4.9	56	91
2644373941	5	16	2	<b>21.60±0.25</b> .850	<b>11.65 0.40</b> .451	<b>1.52±0.13</b> .060	<b>2.54±0.13</b> .100	<b>7.62±0.15</b> .300	<b>1.00±0.15</b> .042	2.9	19	36
2644373841	5	16	2	<b>20.30±0.25</b> .800	<b>10.15 0.40</b> .392	<b>3.18±0.13</b> .125	<b>2.54±0.13</b> .100	<b>2.54±0.10</b> .100	<b>1.22±0.07</b> .048	2.8	30	51
2644236001	3	25	2	<b>36.3±0.4</b> 1.430	<b>7.75 0.25</b> .300	<b>3.43±0.13</b> .135	<b>2.75±0.13</b> .108	<b>2.85±0.13</b> .112	<b>1.60±0.08</b> .062	3.6	30	51
2644236601	3	25	2	<b>36.3±0.4</b> 1.430	<b>7.75 0.25</b> .300	<b>6.86±0.13</b> .270	<b>2.75±0.13</b> .108	<b>2.85±0.13</b> .112	<b>1.60±0.08</b> .062	7.2	56	91

\* This dimension may be modified to suit specific applications.

<sup>+</sup> Test Frequency

## Fair-Rite Products Corp.

PO Box J, One Commercial Row, Walkill, NY 12589-0288

Phone: (888) FAIR RITE / (845) 895-2055 • FAX: (888) FERRITE / (845) 895-2629 • www.fair-rite.com  
(888) 324-7748 (888) 337-7483 • E-Mail: ferrites@fair-rite.com

# Miscellaneous Suppression Cores

Fair-Rite has tooled several special core geometries in the 43 & 77 material for suppression of conducted EMI.

- These suppression cores are controlled for impedance only. The impedances listed are typical values. Single turn tests are performed on the 4193A Vector Impedance Analyzer **with the shortest practical wire length**.
- Performance curves on these miscellaneous cores are included on the Fair-Rite Products CD-ROM.
- For any non-catalog suppression core design feel free to contact our customer service or application group for feasibility and availability.
- Explanation of Part Numbers: Digits 1&2 = product class and 3&4 = the material grade.

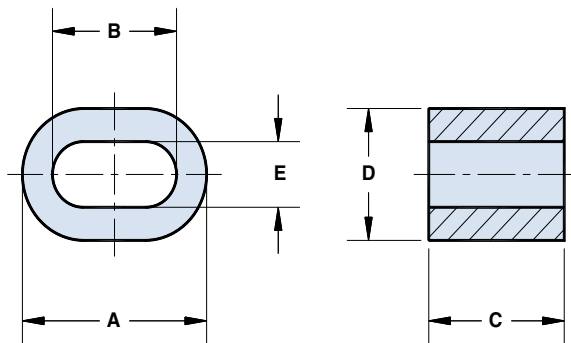

Figure 1

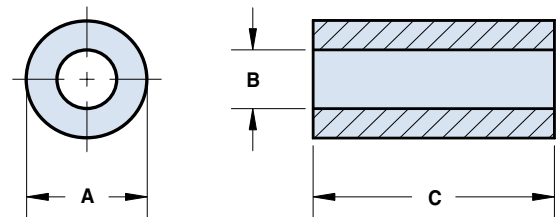

Figure 2

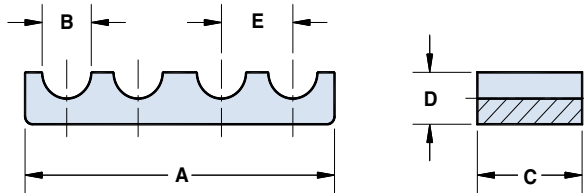

Figure 3

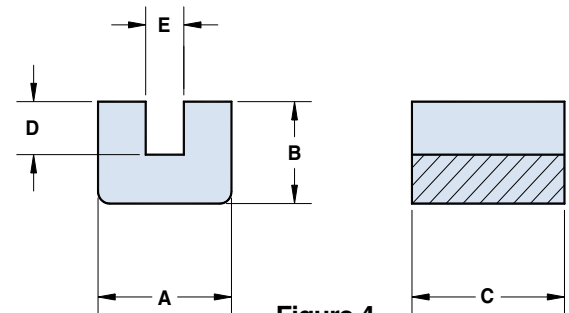

Figure 4

Dimensions (Bold numbers are in millimeters, light numbers are nominal in inches.)

Part Number	Fig.	A	B	C*	D	E	Typical Impedance ( $\Omega$ )				
							1 MHz	10 MHz	25 MHz	100 MHz	250 MHz
2643167851	1	<b>38.85±0.75</b> 1.530	<b>26.15±0.75</b> 1.030	<b>28.6±0.7</b> 1.125	<b>26.0±0.6</b> 1.025	<b>12.95±0.25</b> .510	---	60	94	169	250
2643165151	3	<b>82.6±1.6</b> 3.250	<b>13.1±0.3</b> .516	<b>28.0±0.7</b> 1.100	<b>12.95±0.25</b> .510	<b>19.05±0.4</b> .750	---	100	163	280	340
2643175451	4	<b>17.8±0.4</b> .700	<b>12.7±0.5</b> .500	<b>20.32±0.5</b> .800	<b>6.6±0.25</b> .260	<b>5.08±0.25</b> .200	---	75	119	180	270
2677006302	2	<b>9.5±0.25</b> .375	<b>4.75±0.3</b> .193	<b>10.4±0.25</b> .410	---	---	25	48	33	---	---
2677102402	2	<b>25.9±0.75</b> 1.020	<b>12.8±0.25</b> .505	<b>21.3±0.5</b> .840	---	---	52	28	24	---	---

\*This dimension may be modified to suit specific applications.

**Fair-Rite Products Corp.**

PO Box J, One Commercial Row, Wallkill, NY 12589-0288

Phone: (888) FAIR RITE / (845) 895-2055 • FAX: (888) FERRITE / (845) 895-2629 • www.fair-rite.com  
 (888) 324-7748 (888) 337-7483 • E-Mail: ferrites@fair-rite.com

0431163951

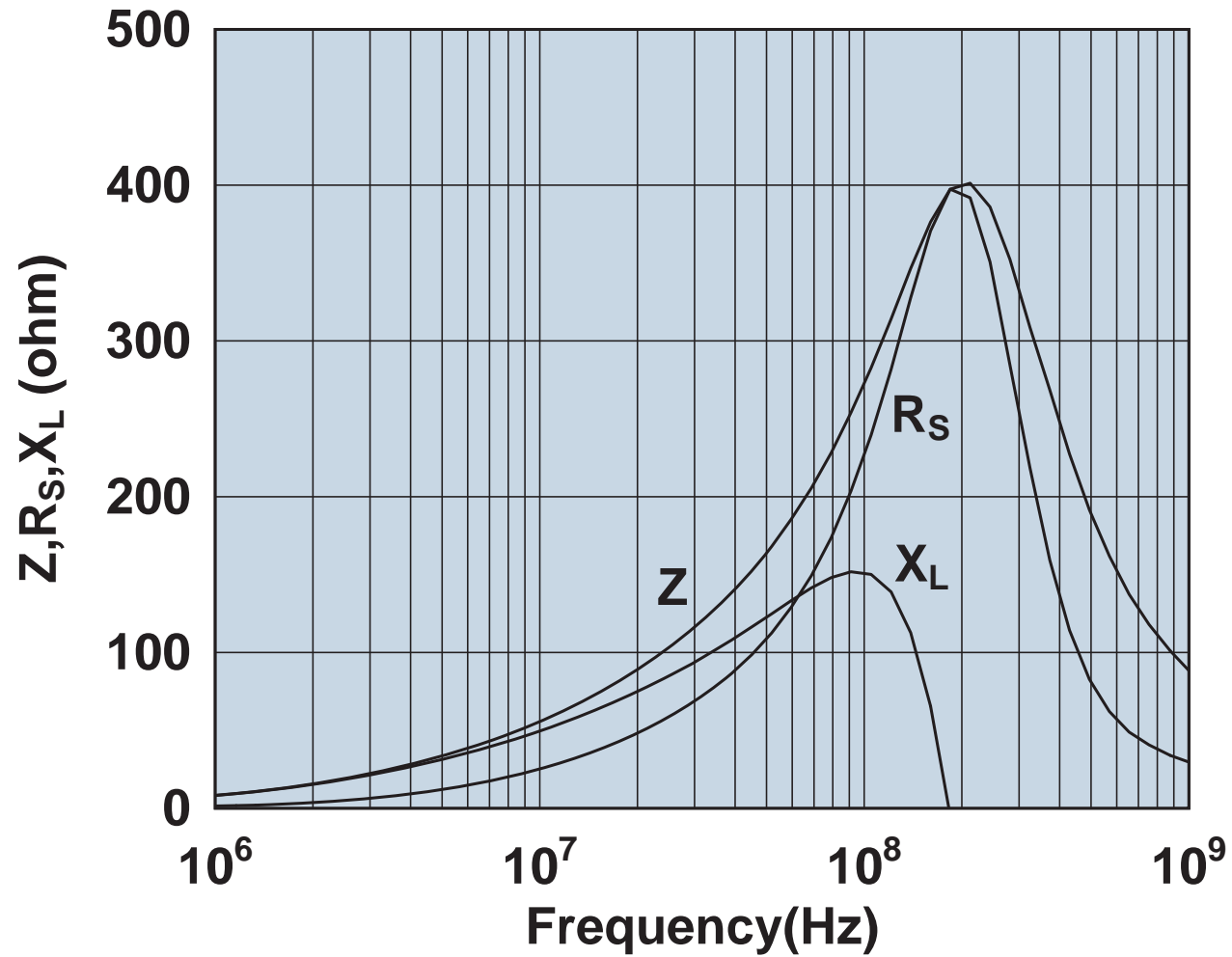

Impedance, reactance, and resistance vs. frequency.

0431164051

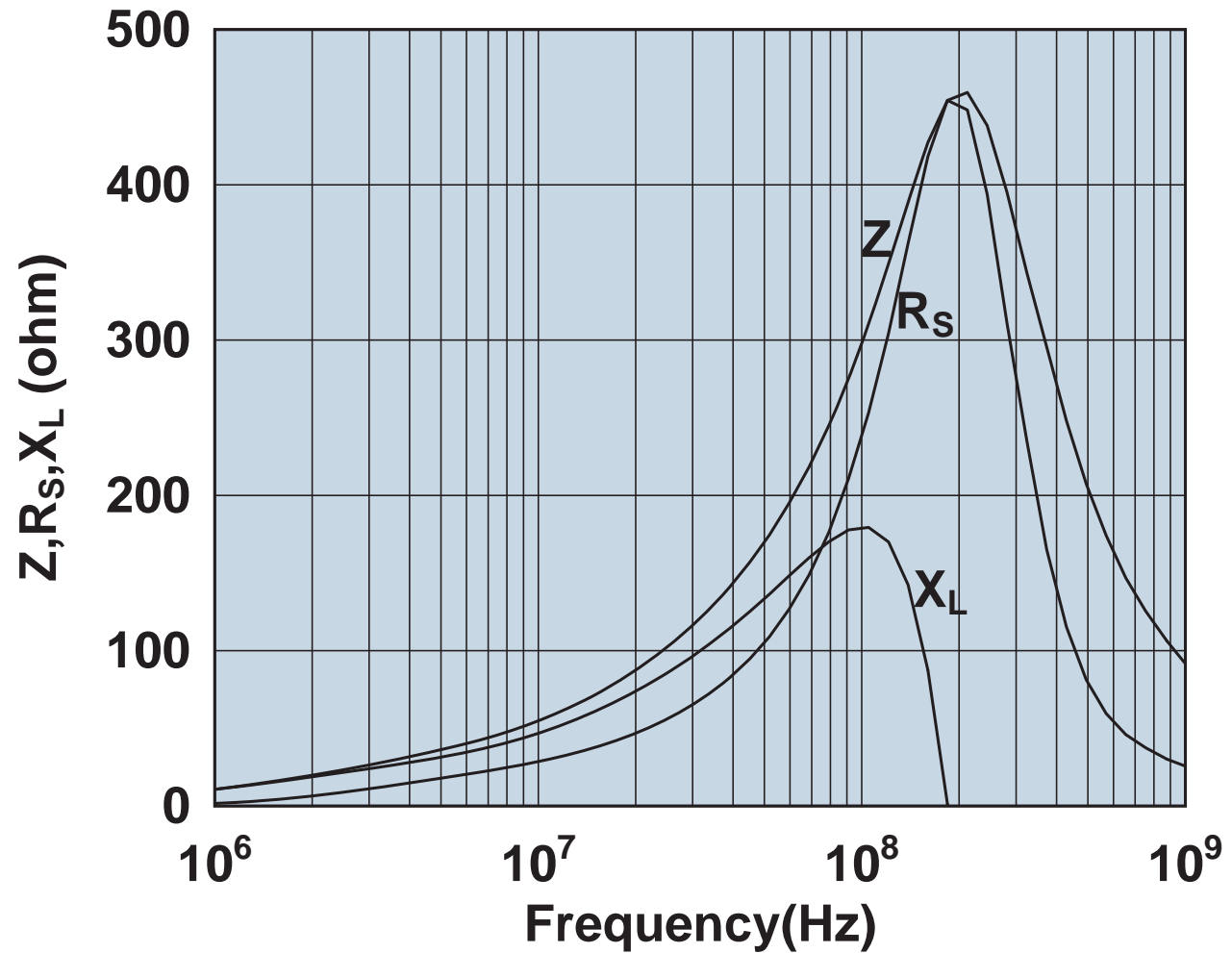

Impedance, reactance, and resistance vs. frequency.

0431164181

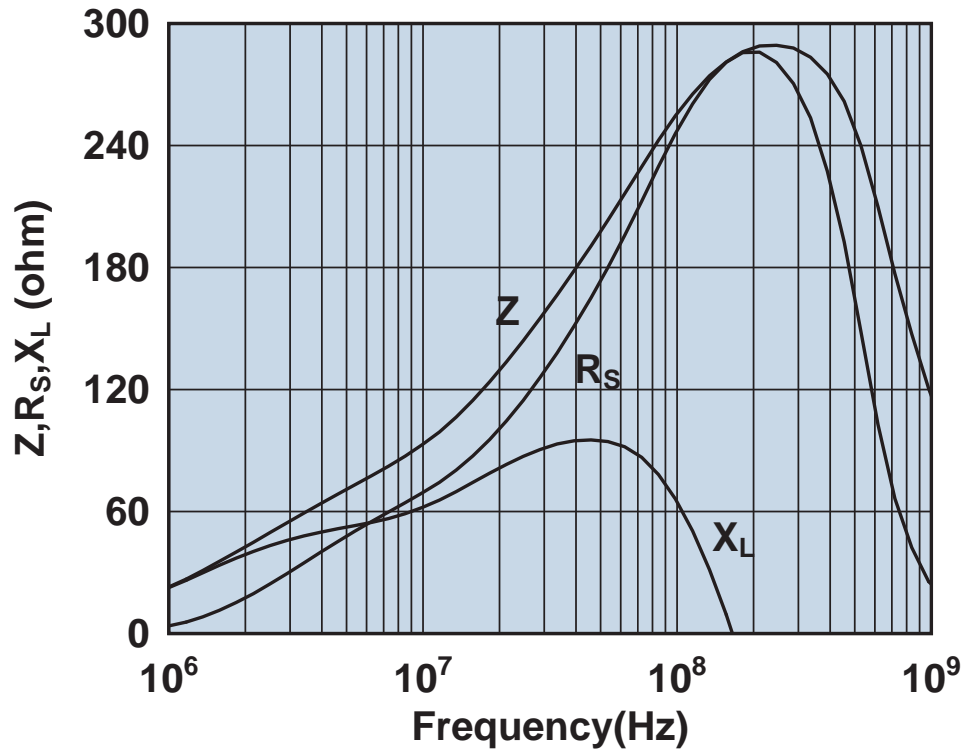

Impedance, reactance, and resistance vs. frequency.

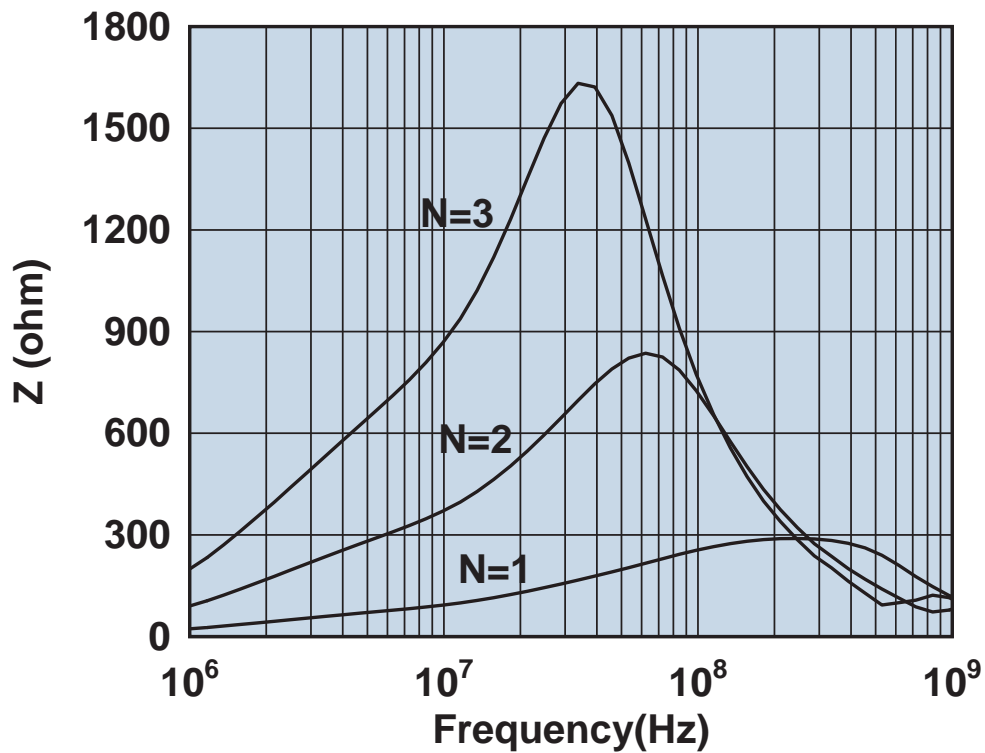

Impedance vs. frequency with one, two, and three turns.

0431164281

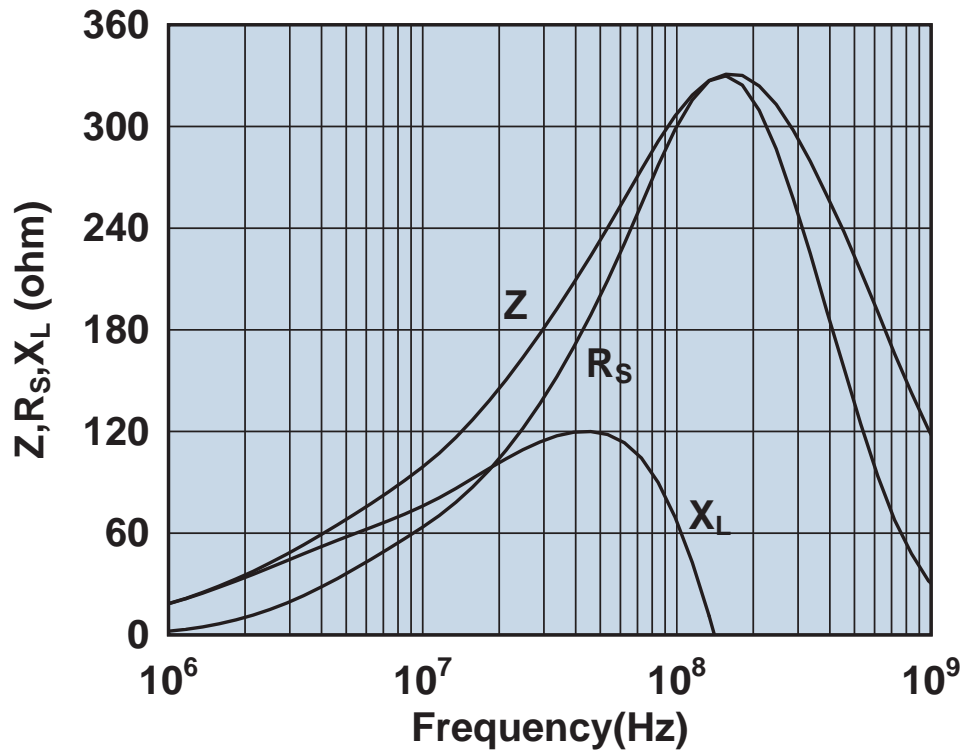

Impedance, reactance, and resistance vs. frequency.

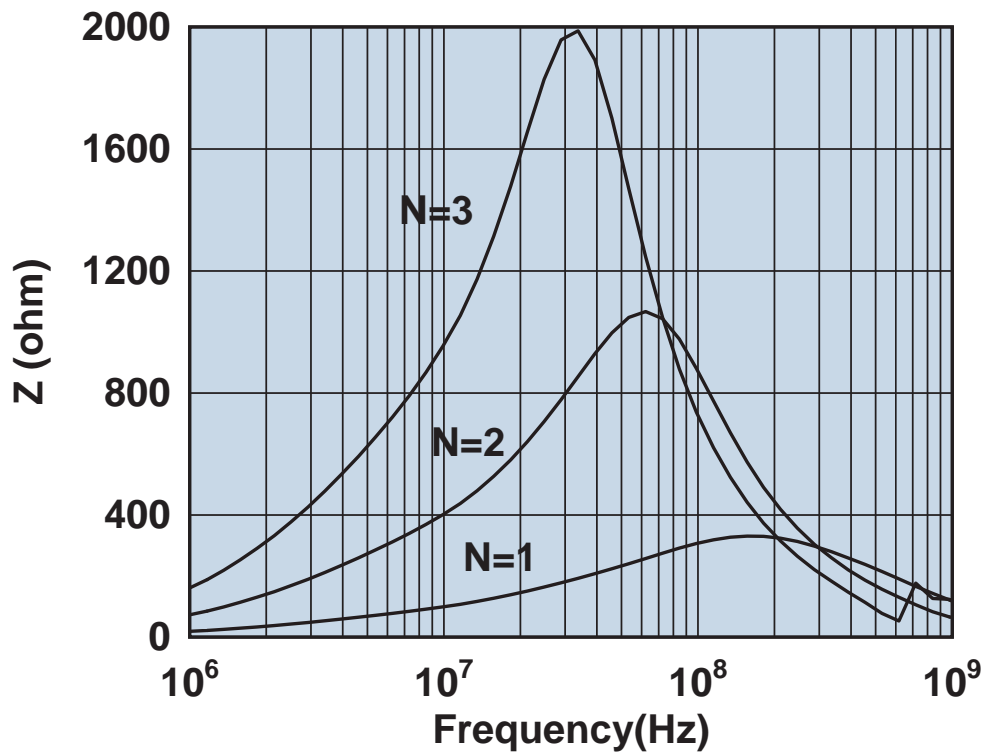

Impedance vs. frequency with one, two, and three turns.



0431164951

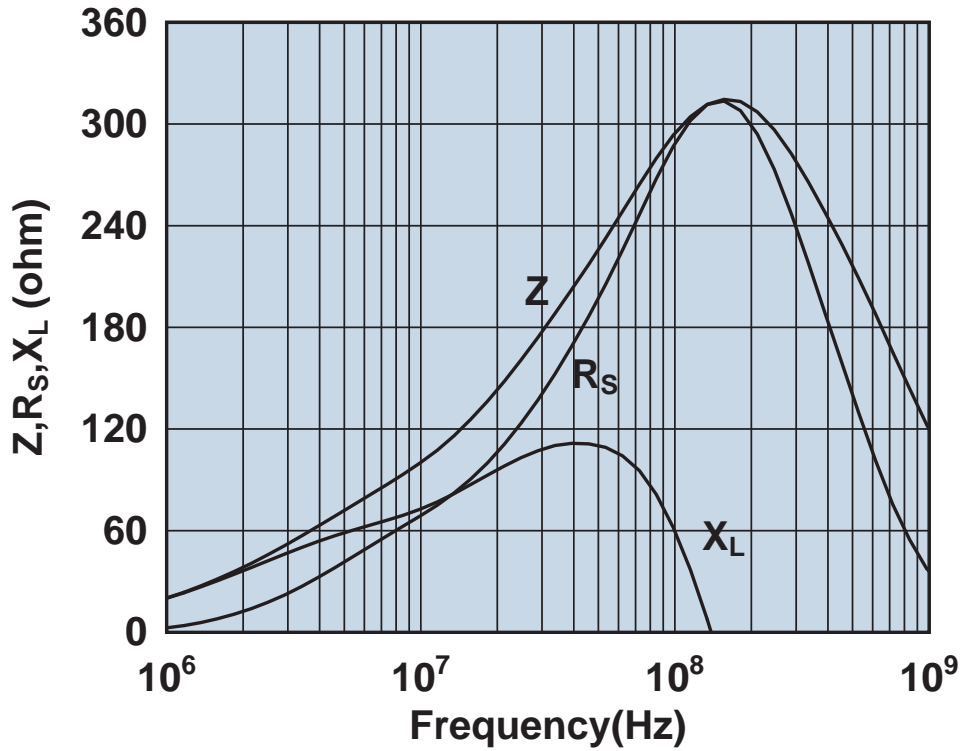

Impedance, reactance, and resistance vs. frequency.

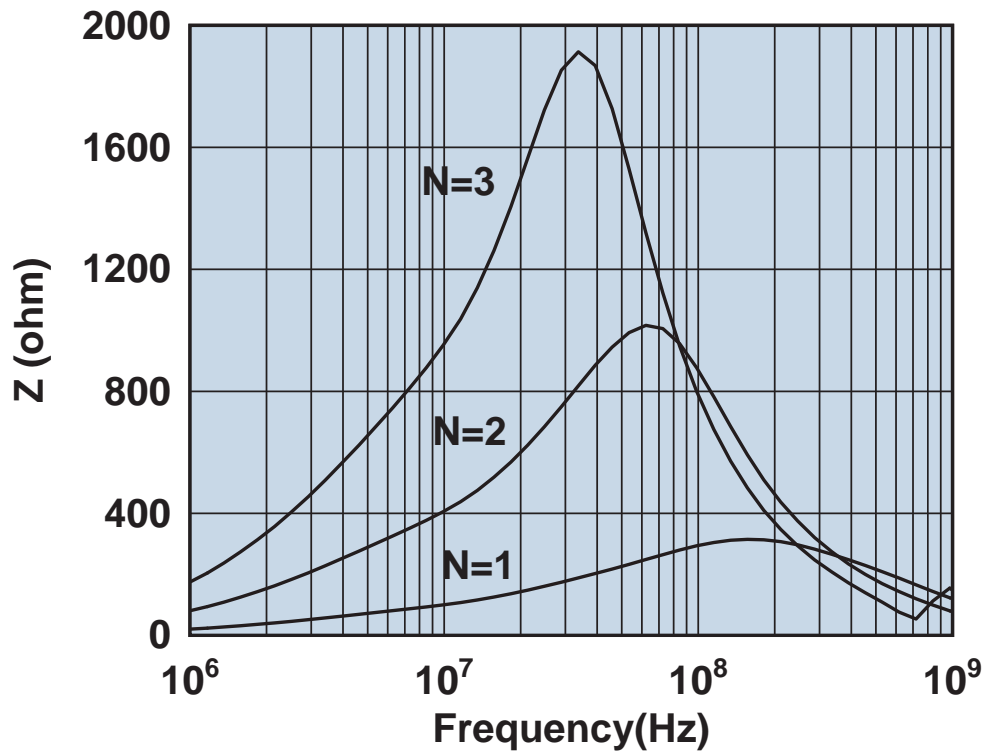

Impedance vs. frequency with one, two, and three turns.

0431167281

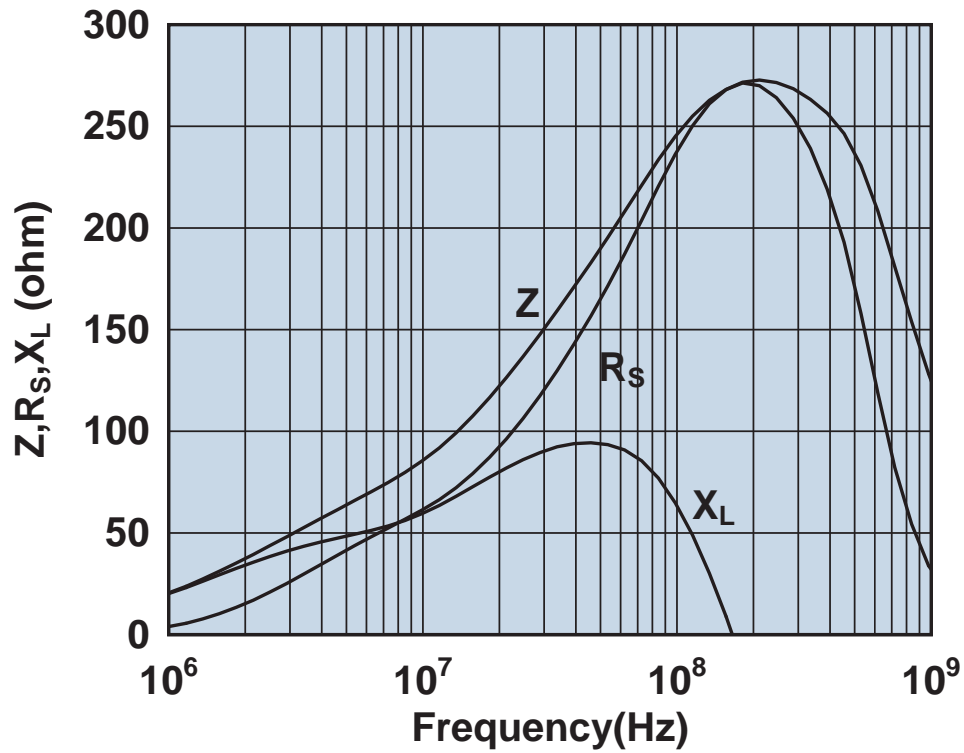

Impedance, reactance, and resistance vs. frequency.

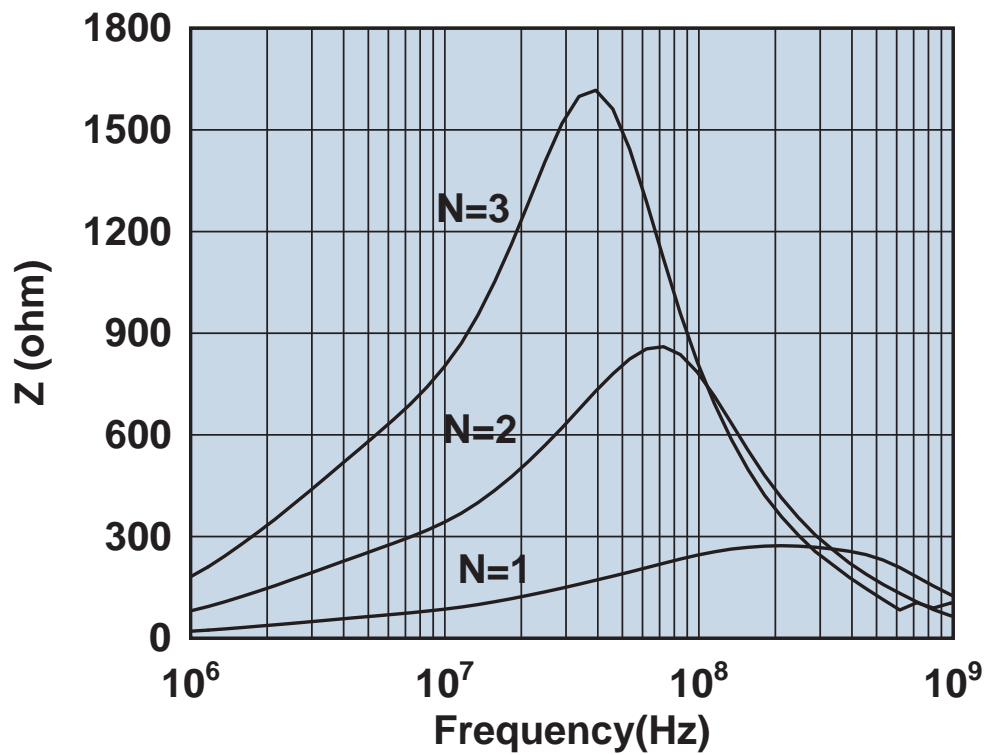

Impedance vs. frequency with one, two, and three turns.

0431173551

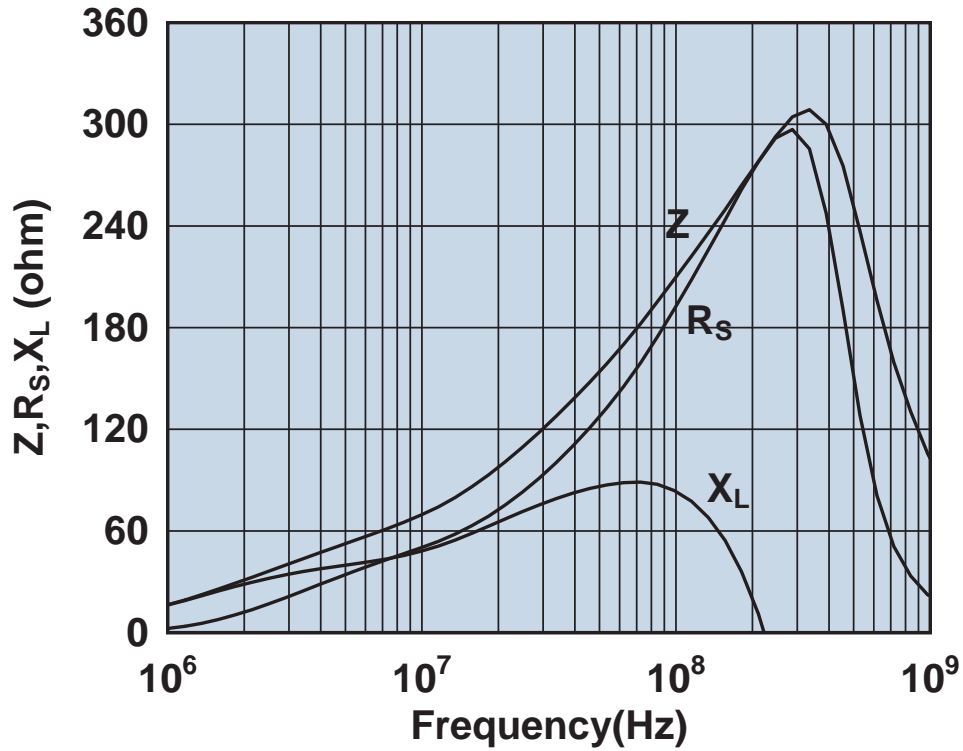

Impedance, reactance, and resistance vs. frequency.

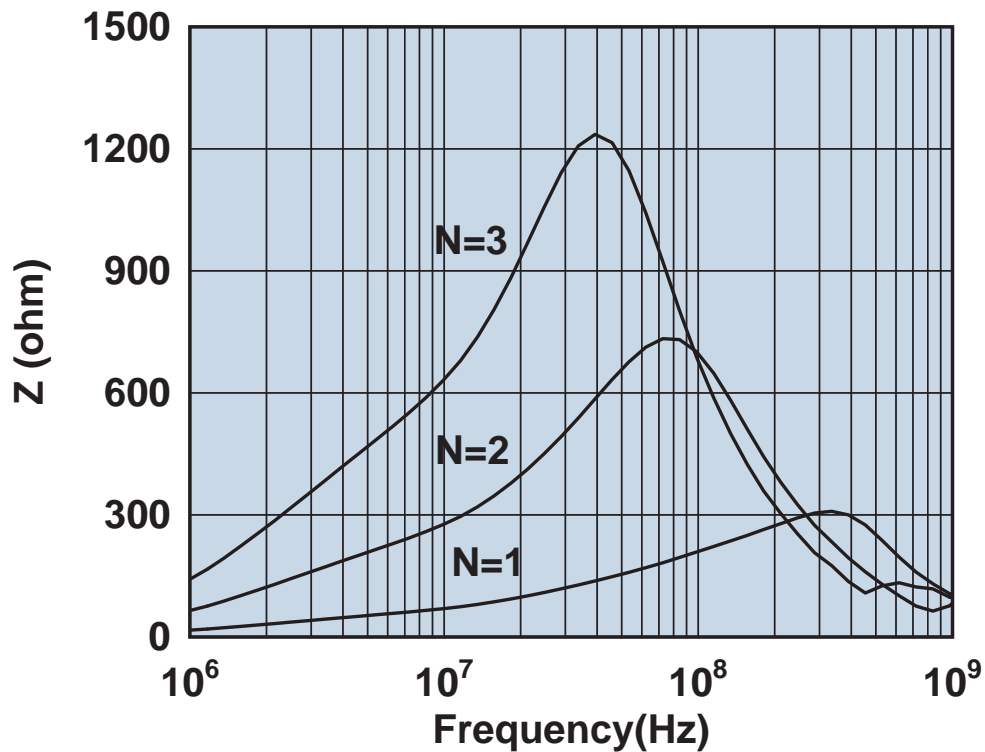

Impedance vs. frequency with one, two, and three turns.

0431173951

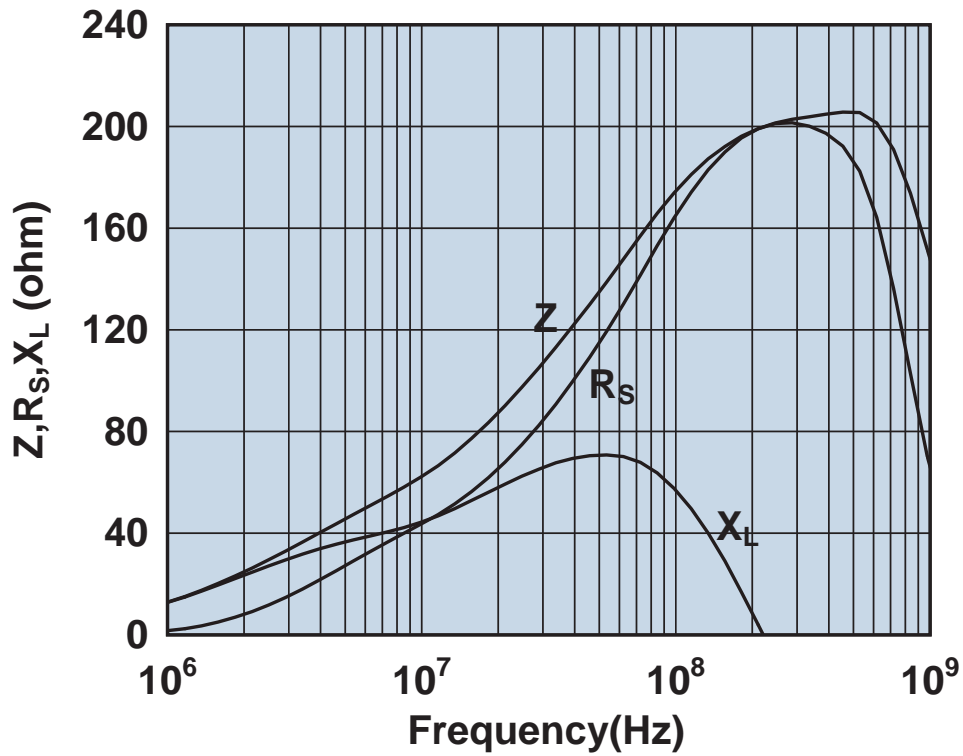

Impedance, reactance, and resistance vs. frequency.

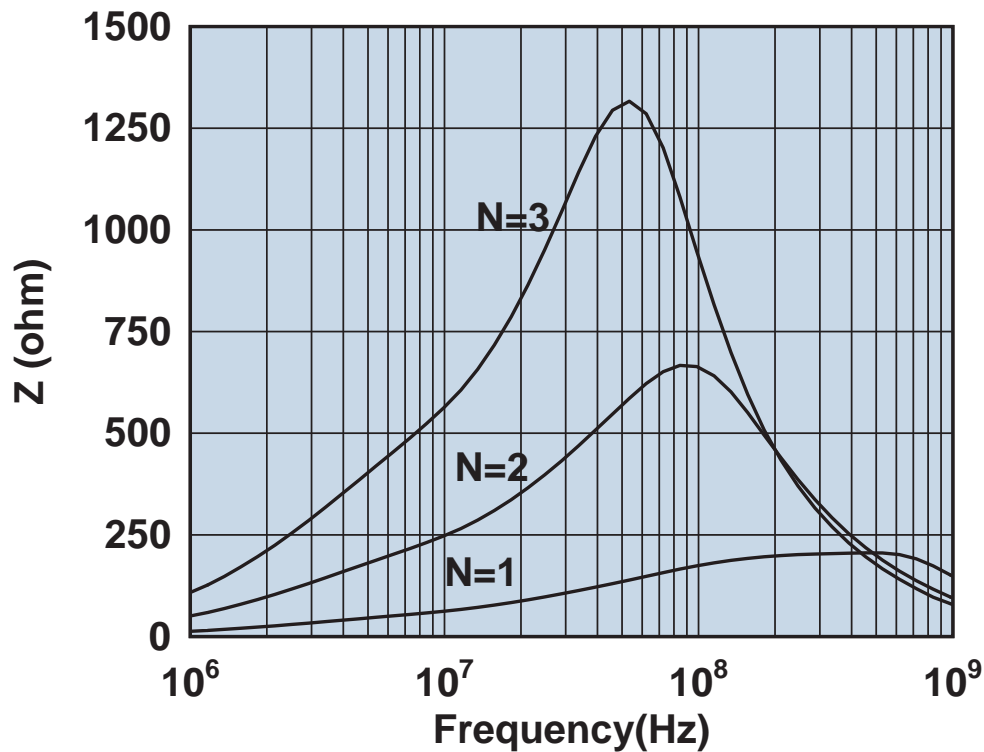

Impedance vs. frequency with one, two, and three turns.

0431176451

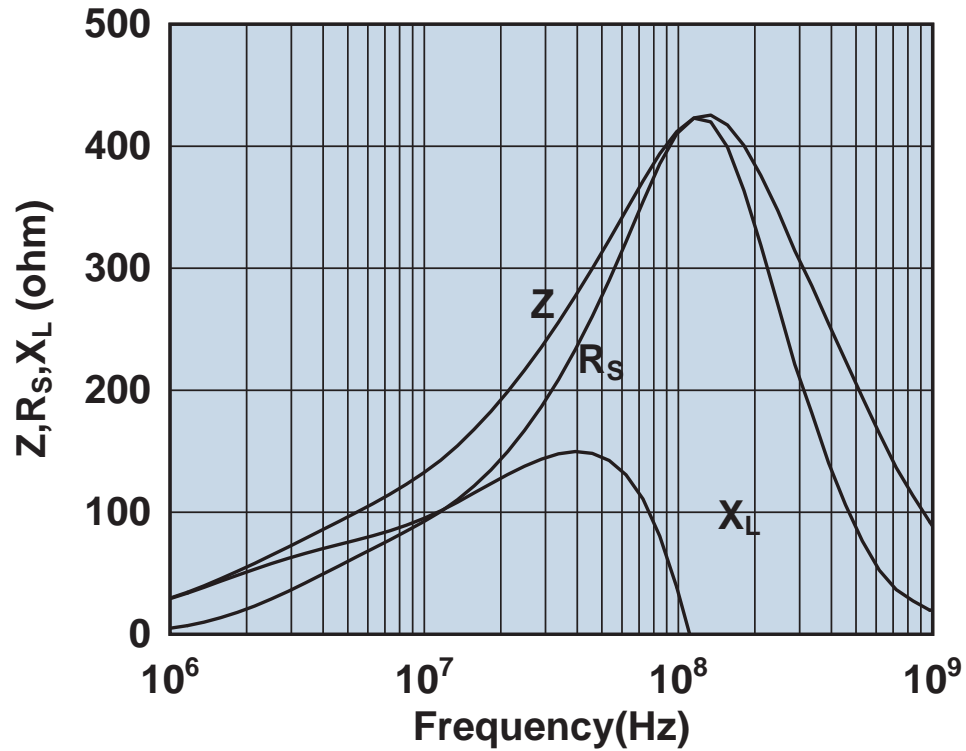

Impedance, reactance, and resistance vs. frequency.

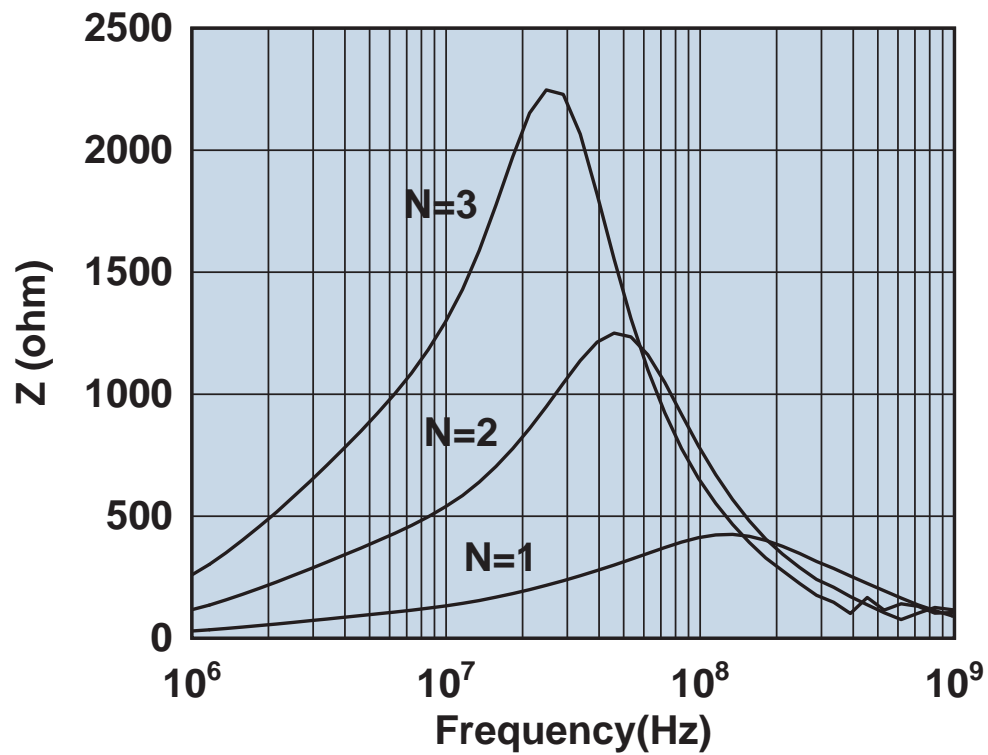

Impedance vs. frequency with one, two, and three turns.

0431177081

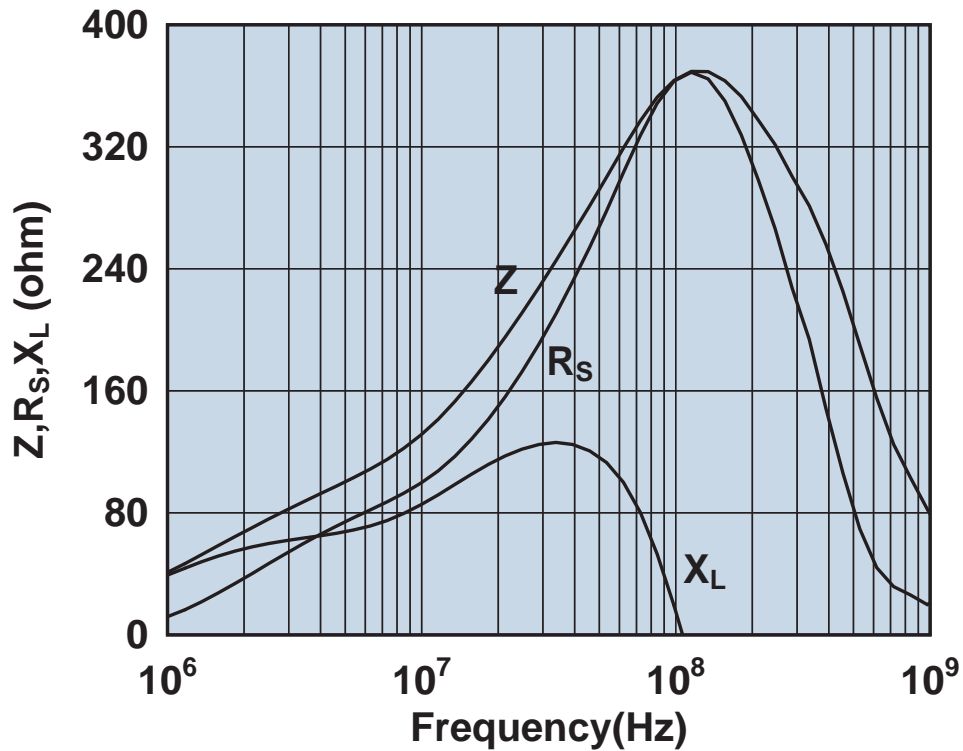

Impedance, reactance, and resistance vs. frequency.

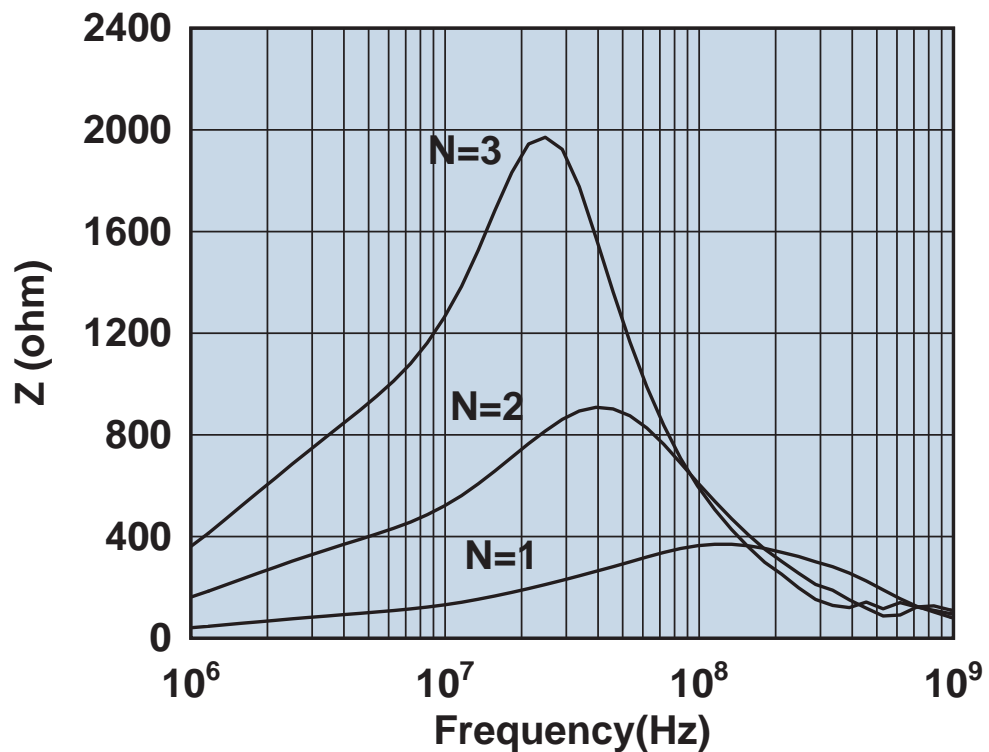

Impedance vs. frequency with one, two, and three turns.

0431178181

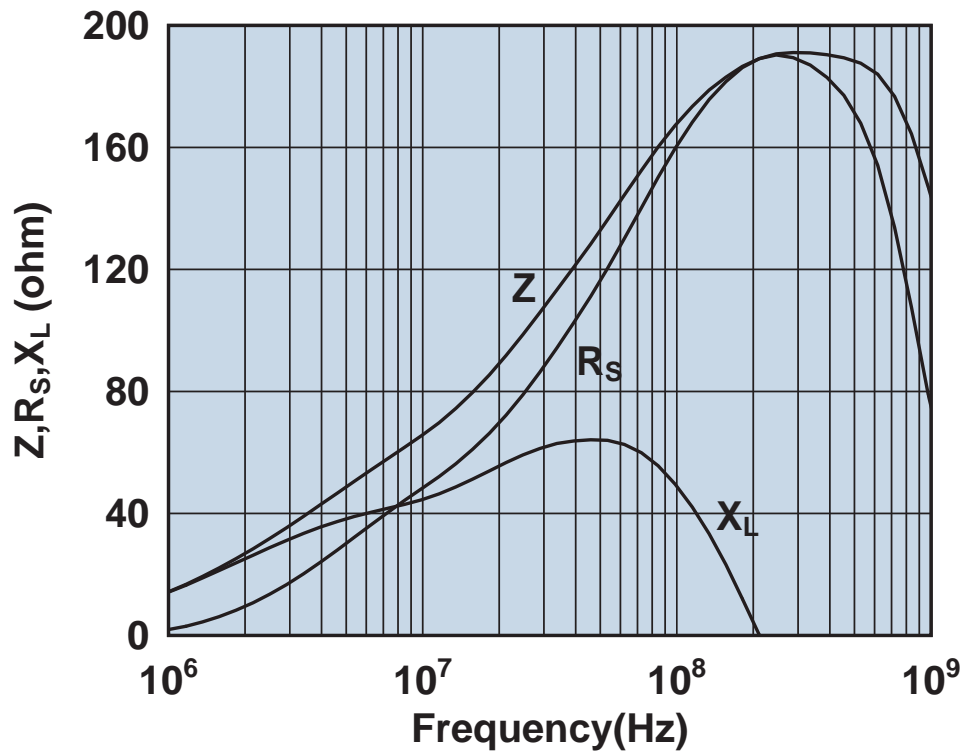

Impedance, reactance, and resistance vs. frequency.

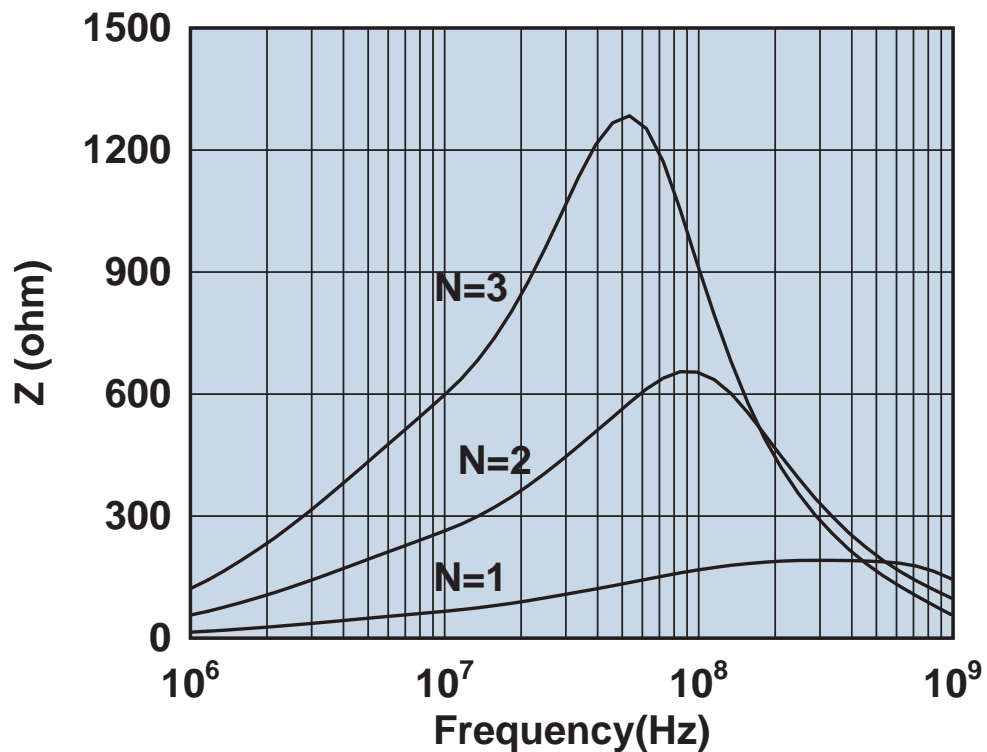

Impedance vs. frequency with one, two, and three turns.



0431178281

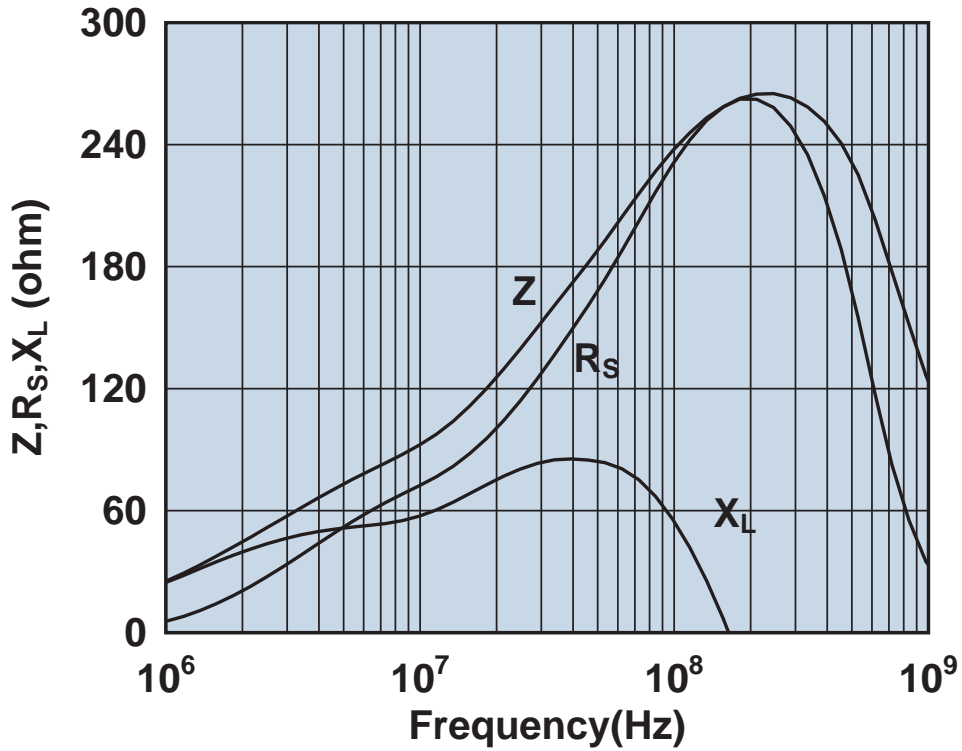

Impedance, reactance, and resistance vs. frequency.

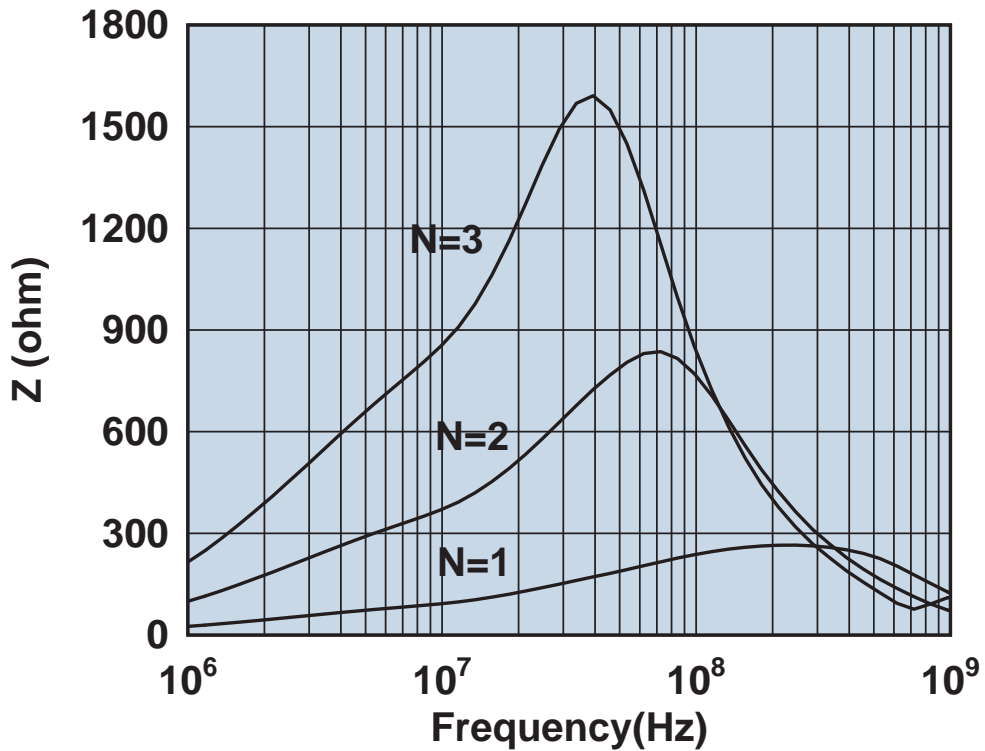

Impedance vs. frequency with one, two, and three turns.

0443163951

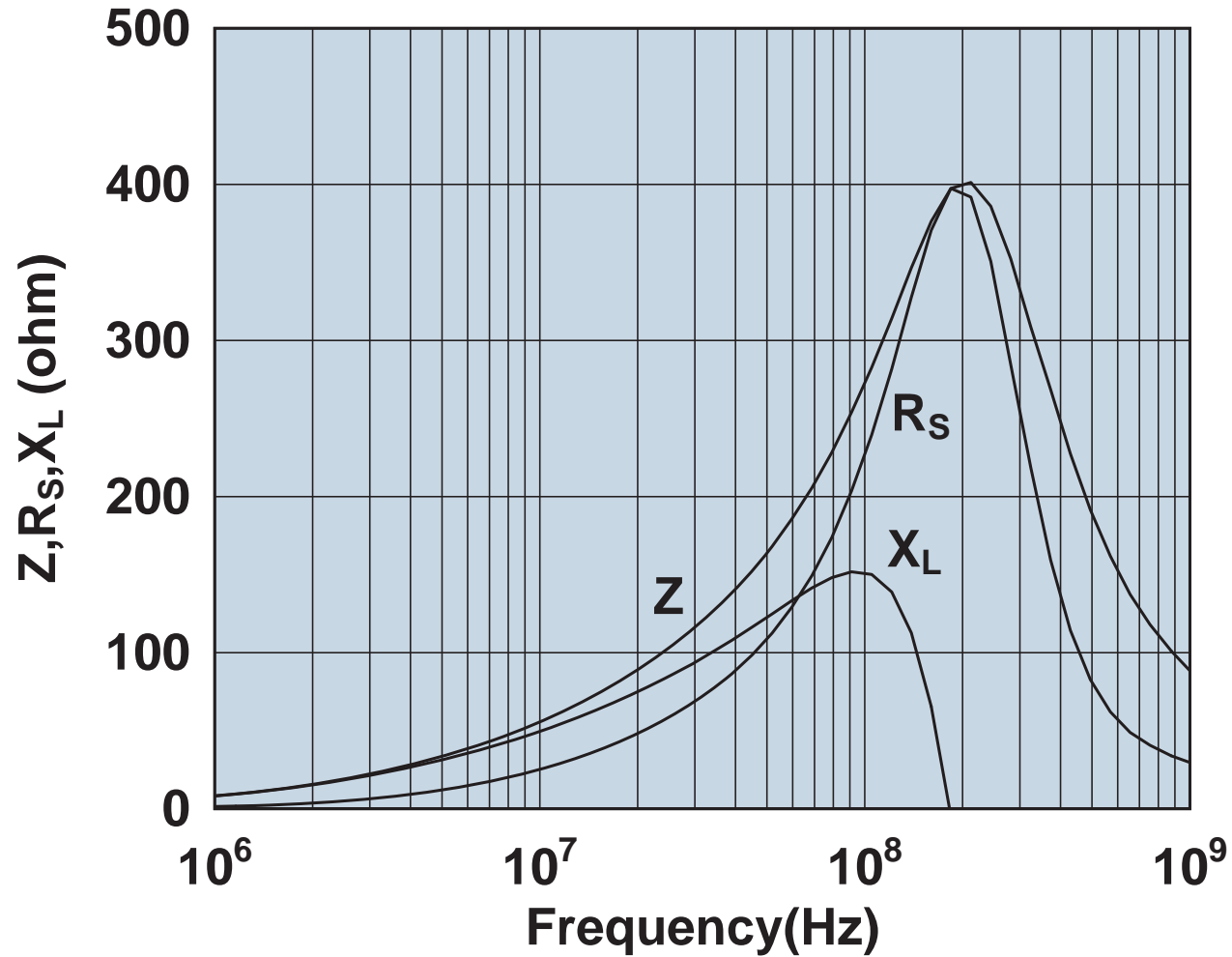

Impedance, reactance, and resistance vs. frequency.

0443164051

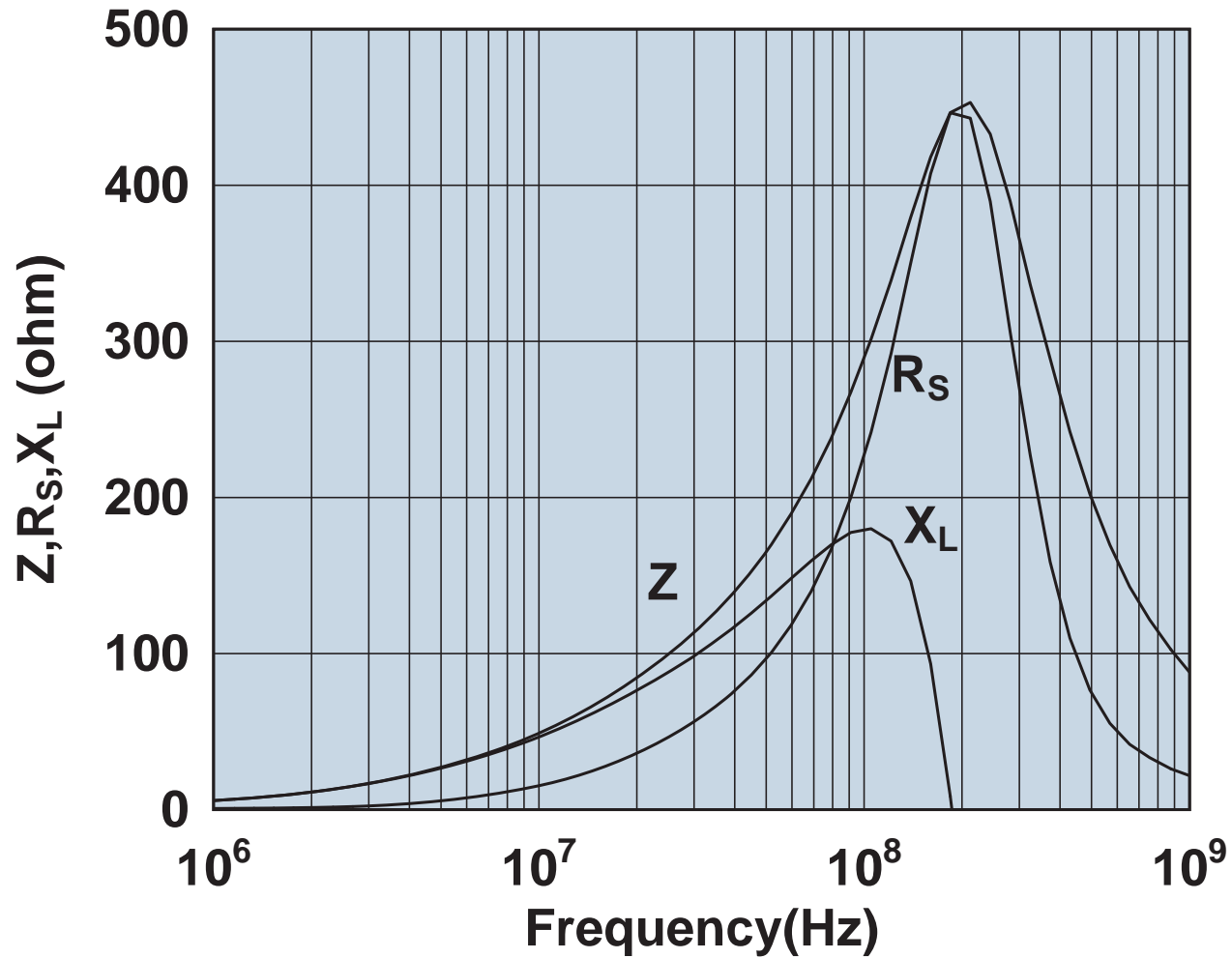

Impedance, reactance, and resistance vs. frequency.

0443164151

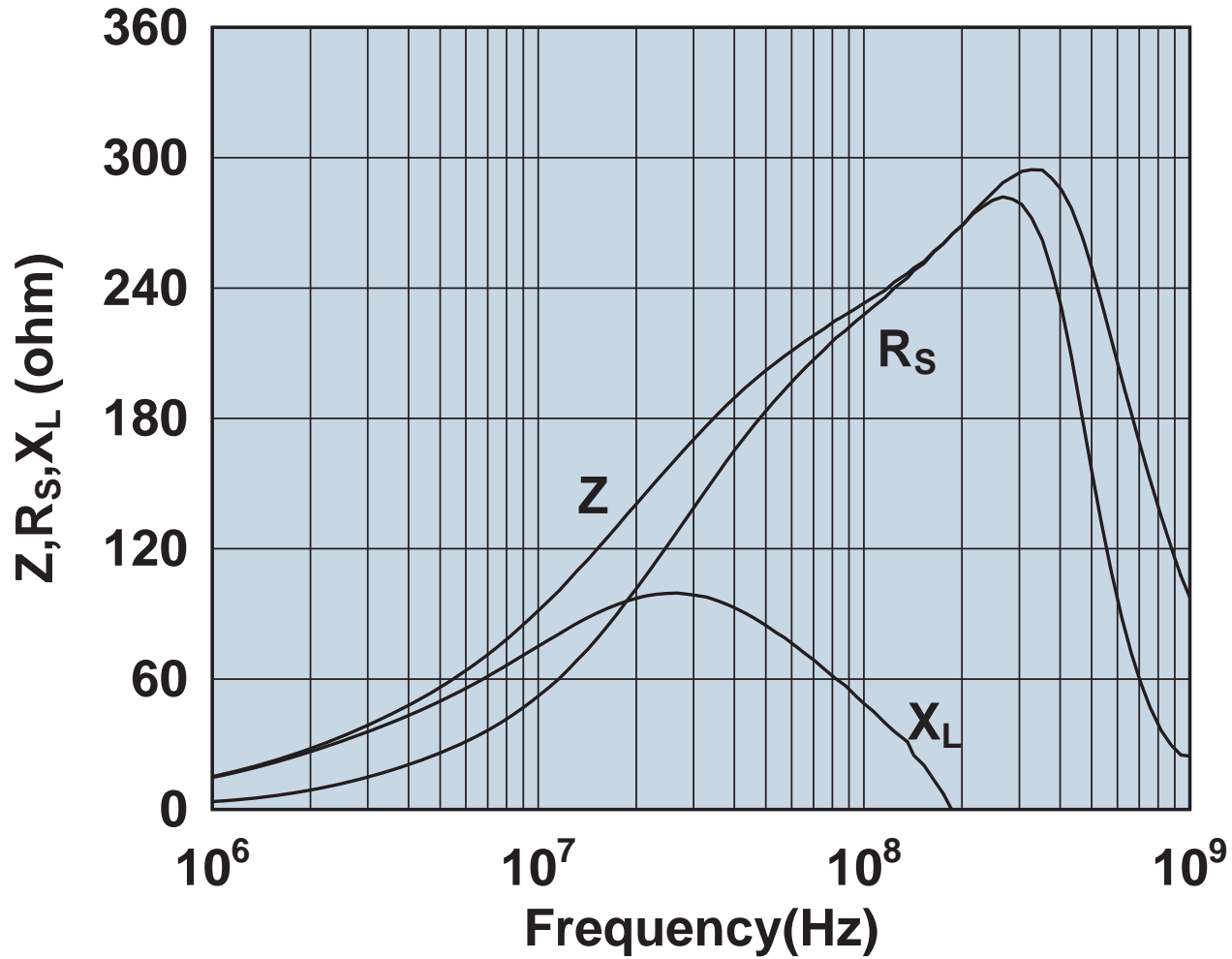

Impedance, reactance, and resistance vs. frequency.

0443164251

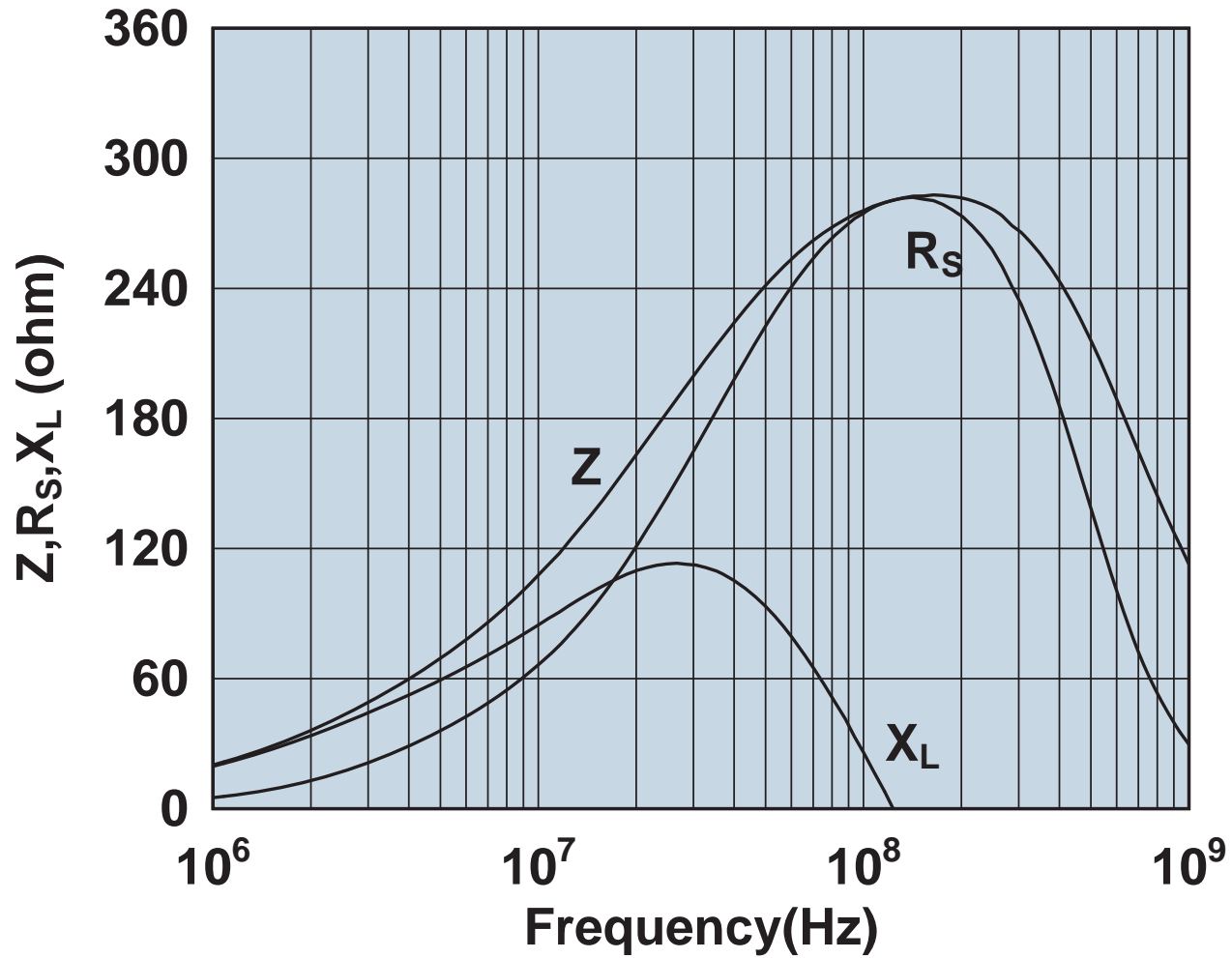

Impedance, reactance, and resistance vs. frequency.

0443166651

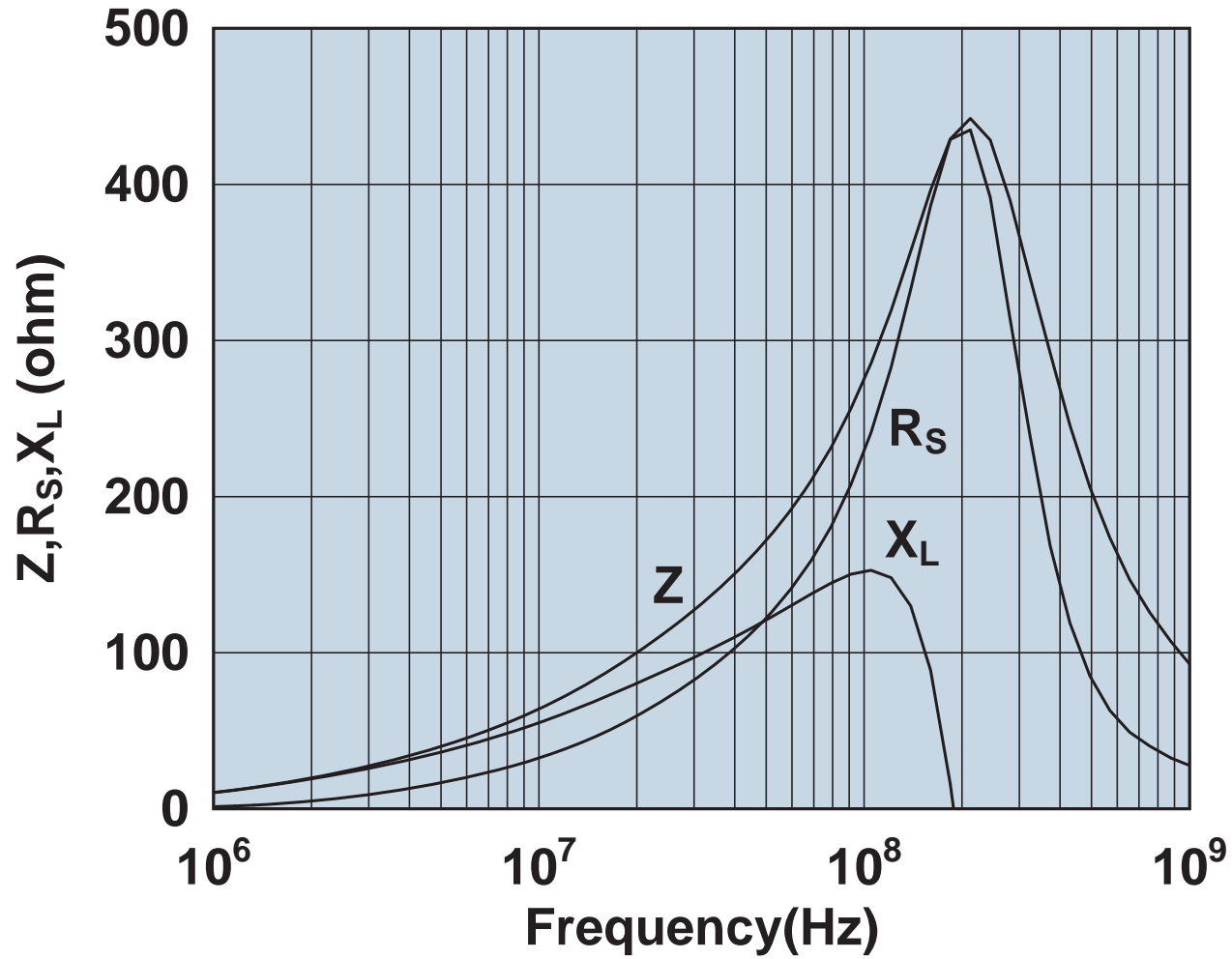

Impedance, reactance, and resistance vs. frequency.

0443167251

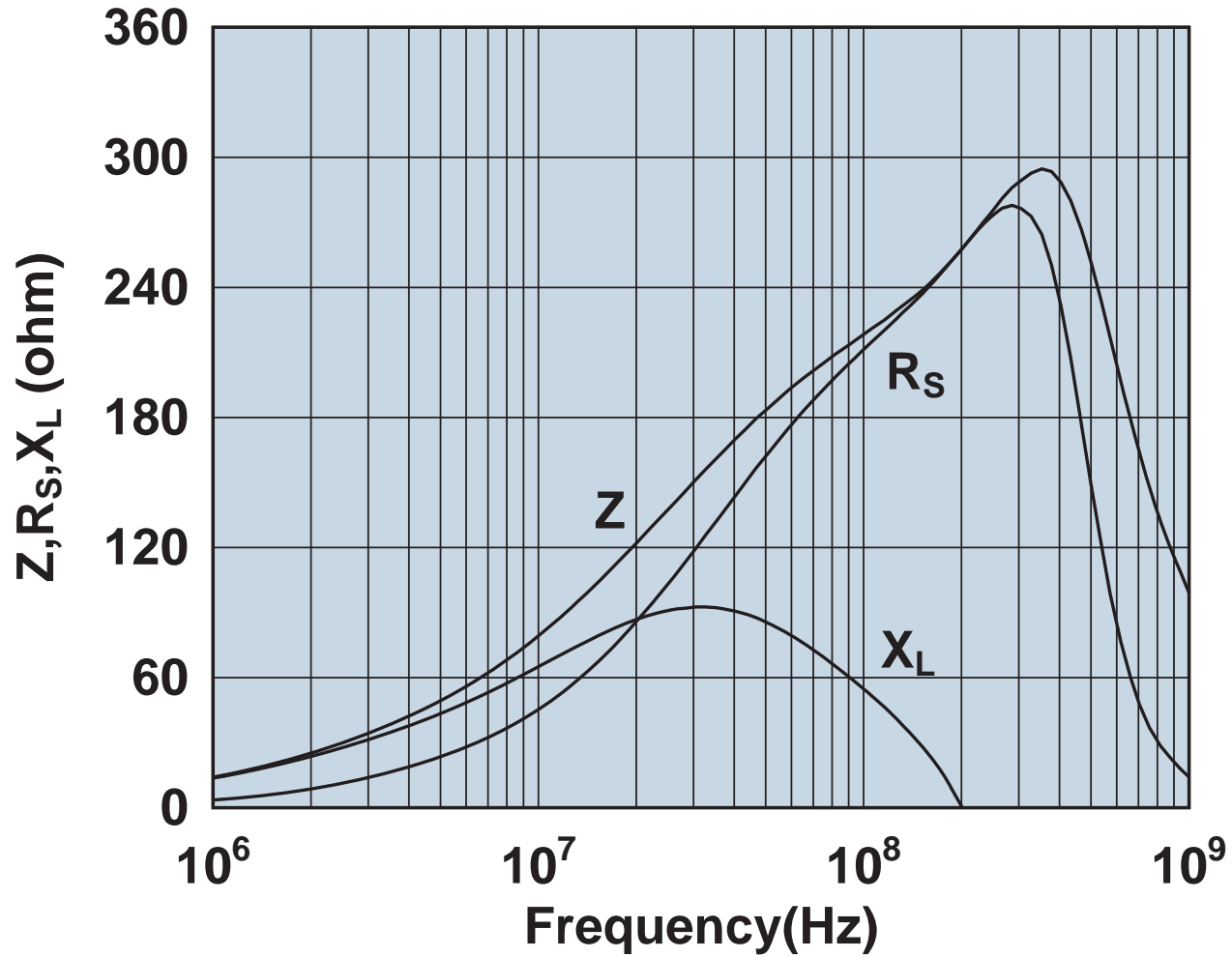

Impedance, reactance, and resistance vs. frequency.

0443178181

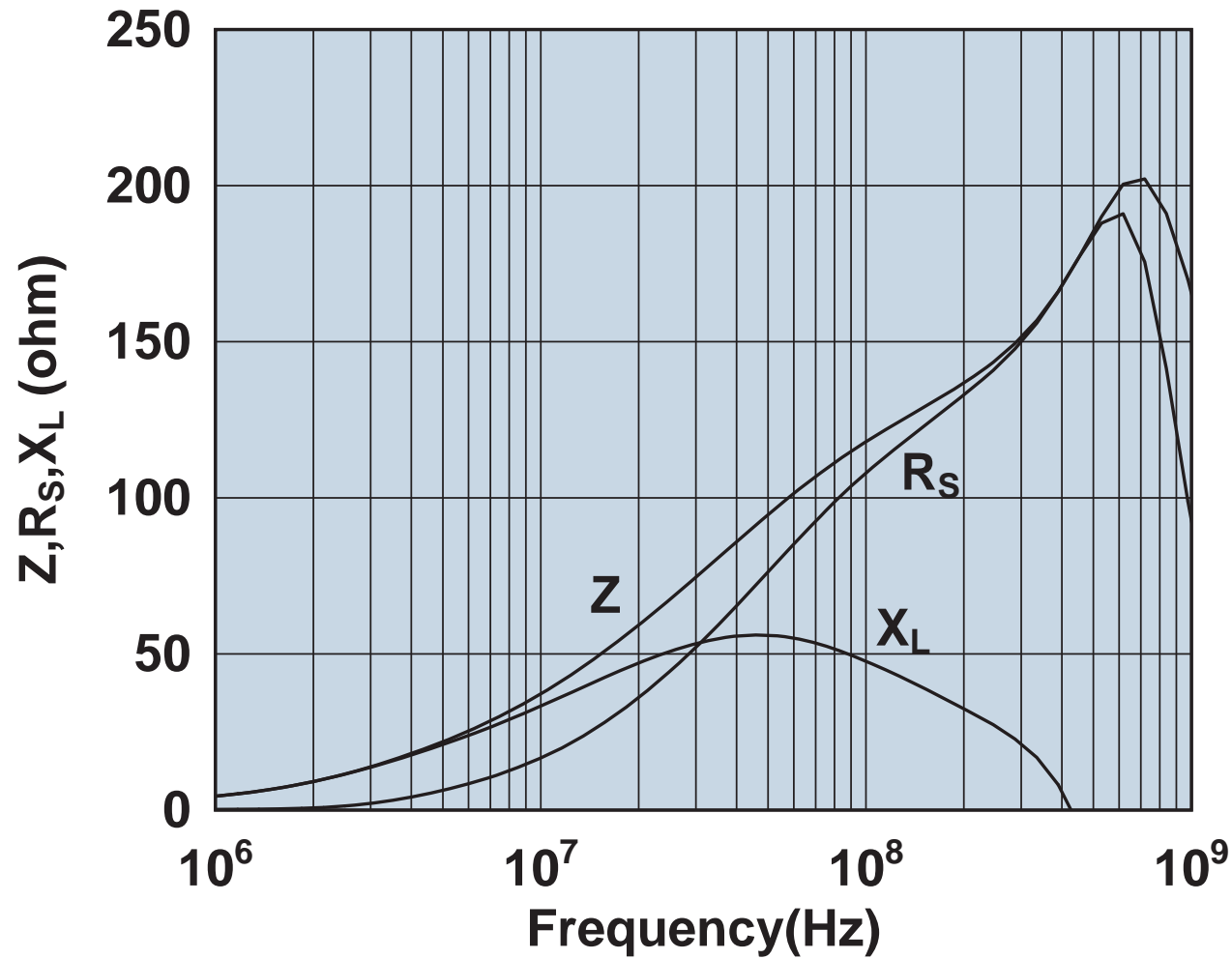

Impedance, reactance, and resistance vs. frequency.



0443178281

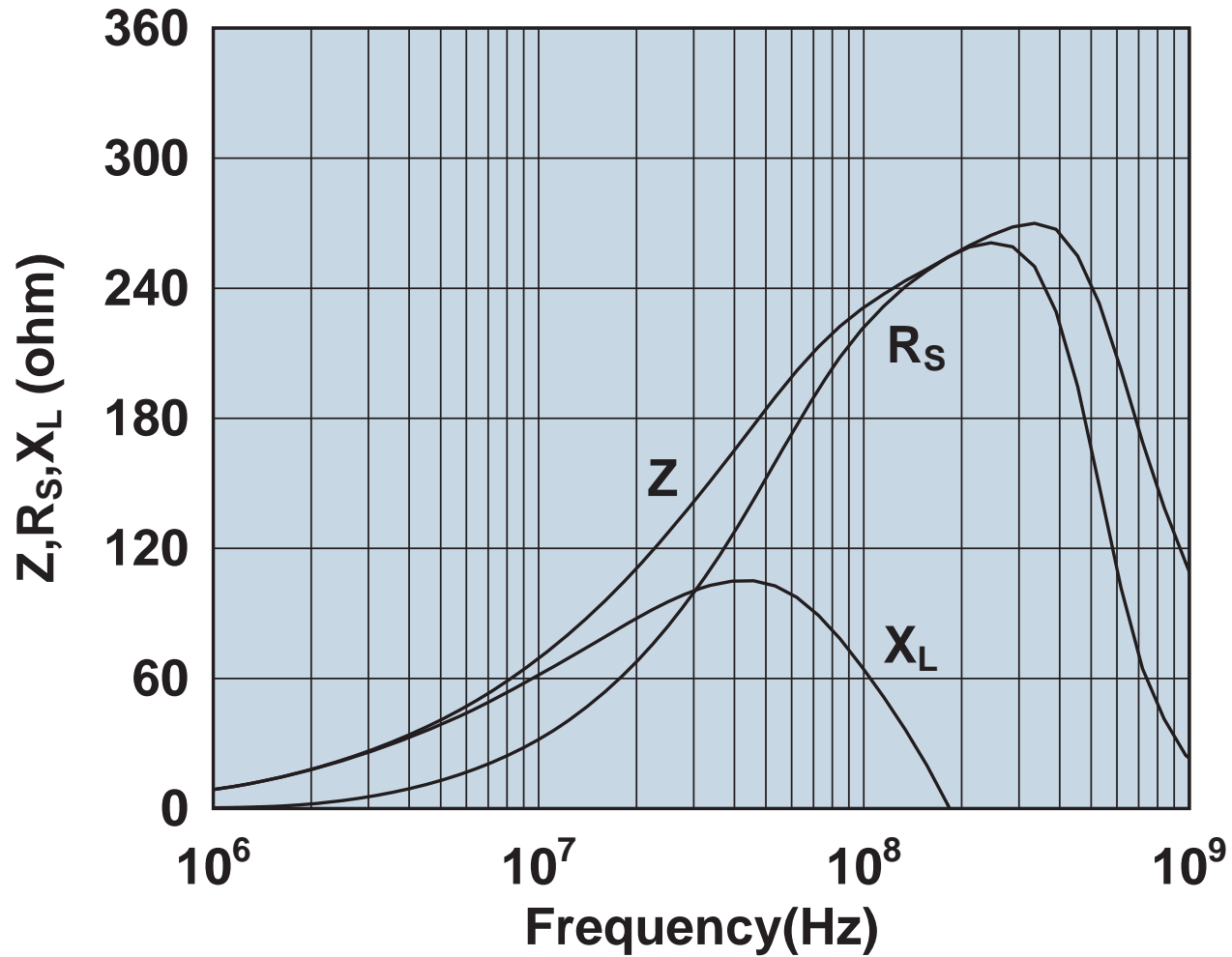

Impedance, reactance, and resistance vs. frequency.

0443625006

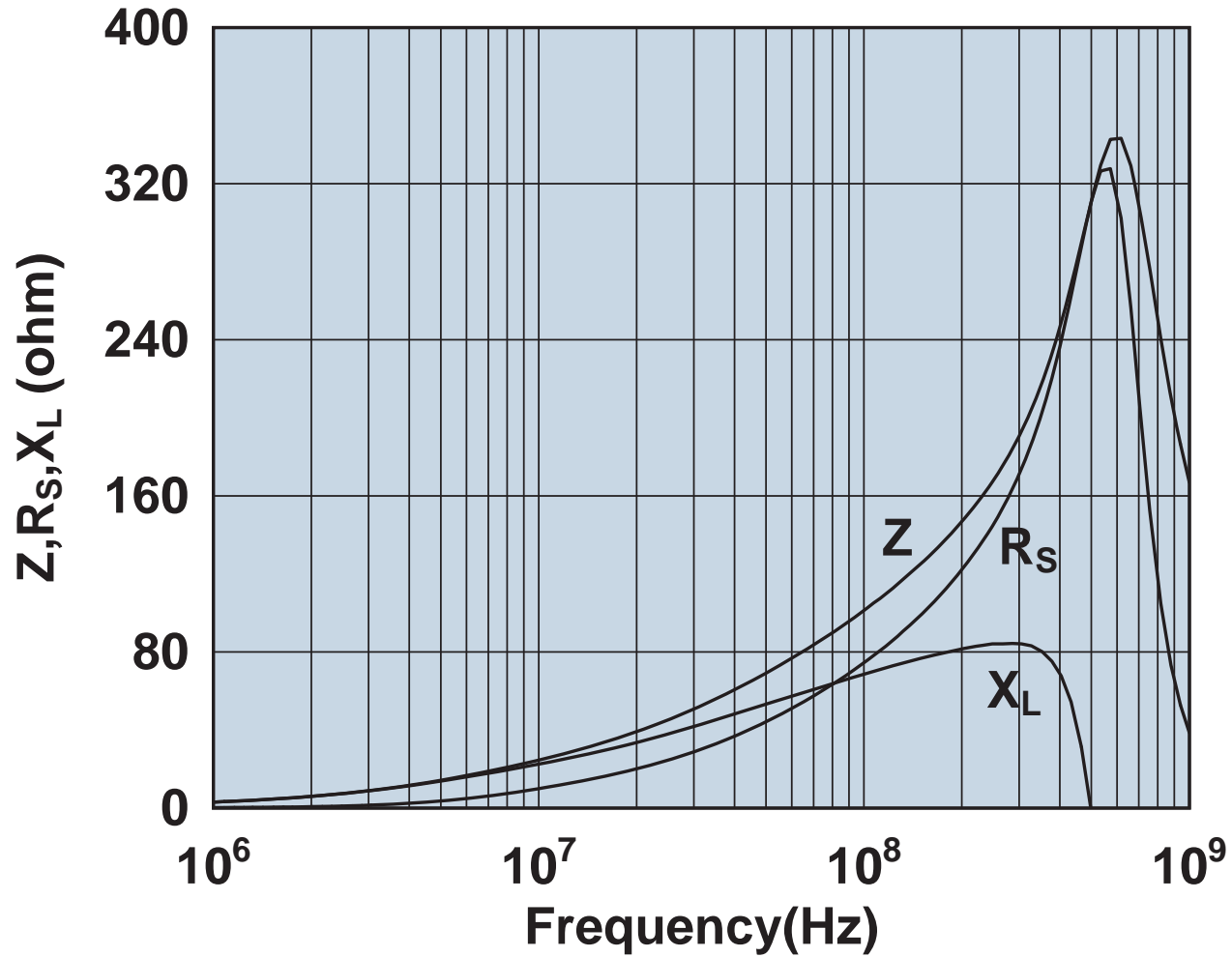

Impedance, reactance, and resistance vs. frequency.

0443665806

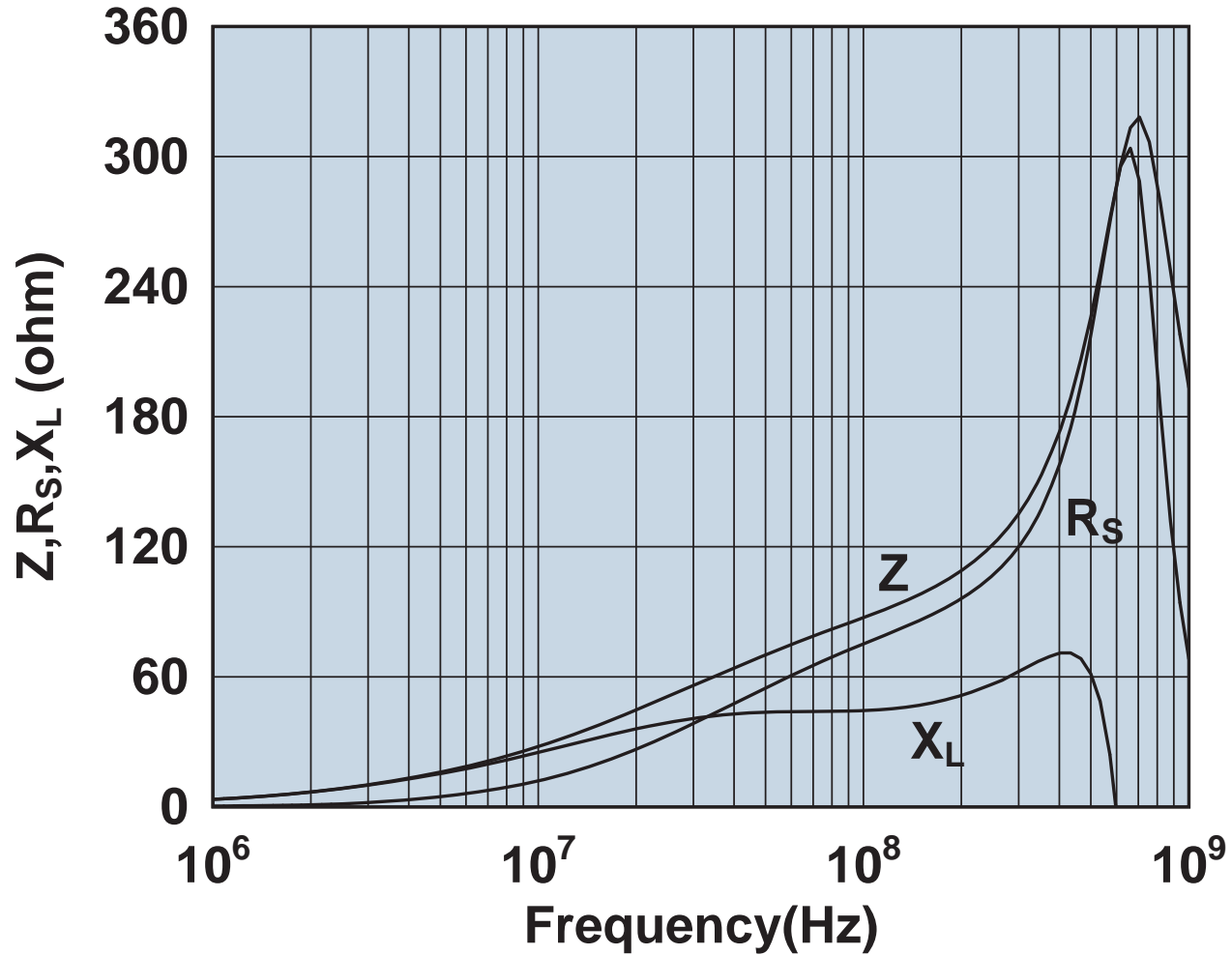

Impedance, reactance, and resistance vs. frequency.

0443800506

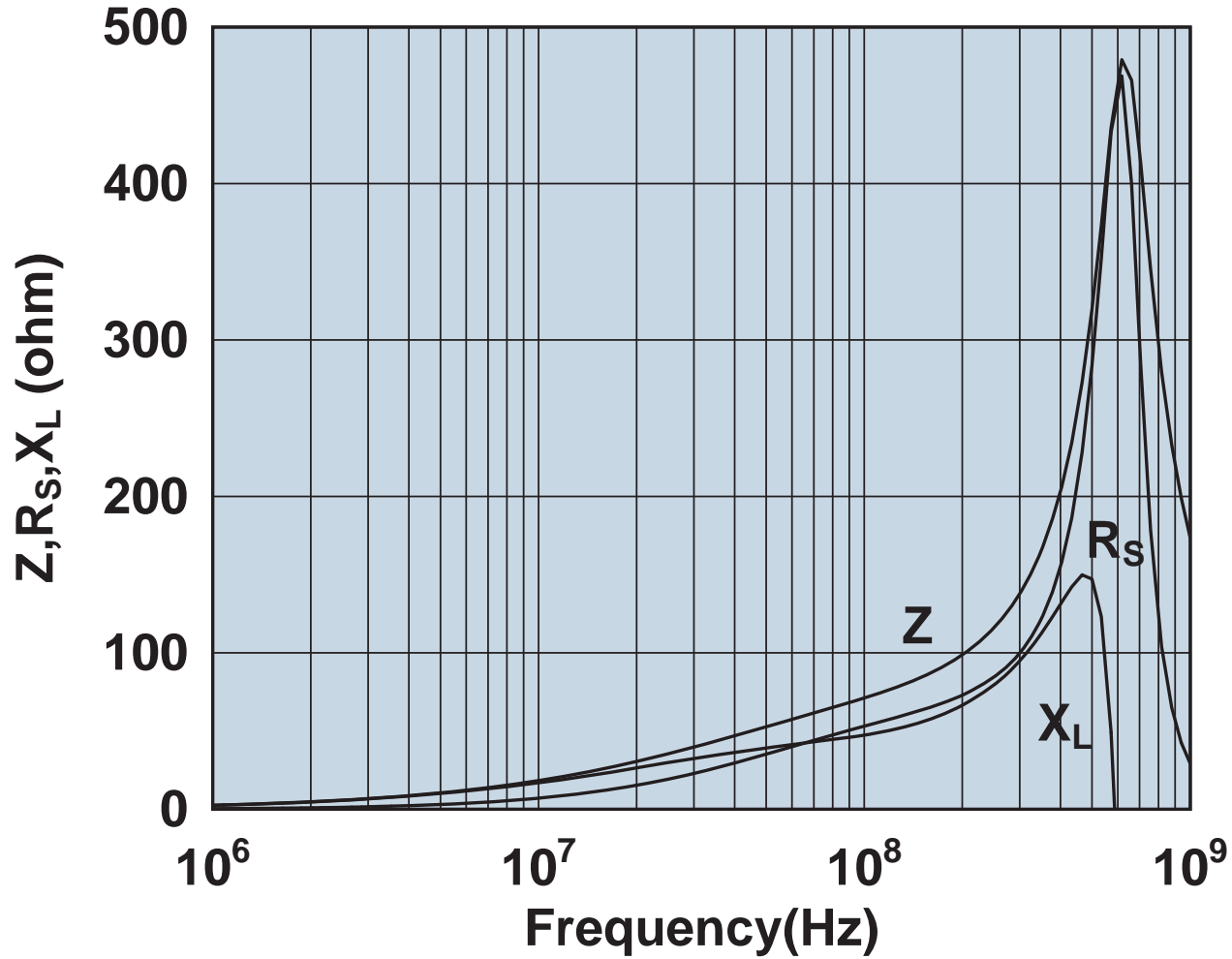

Impedance, reactance, and resistance vs. frequency.

0443806406

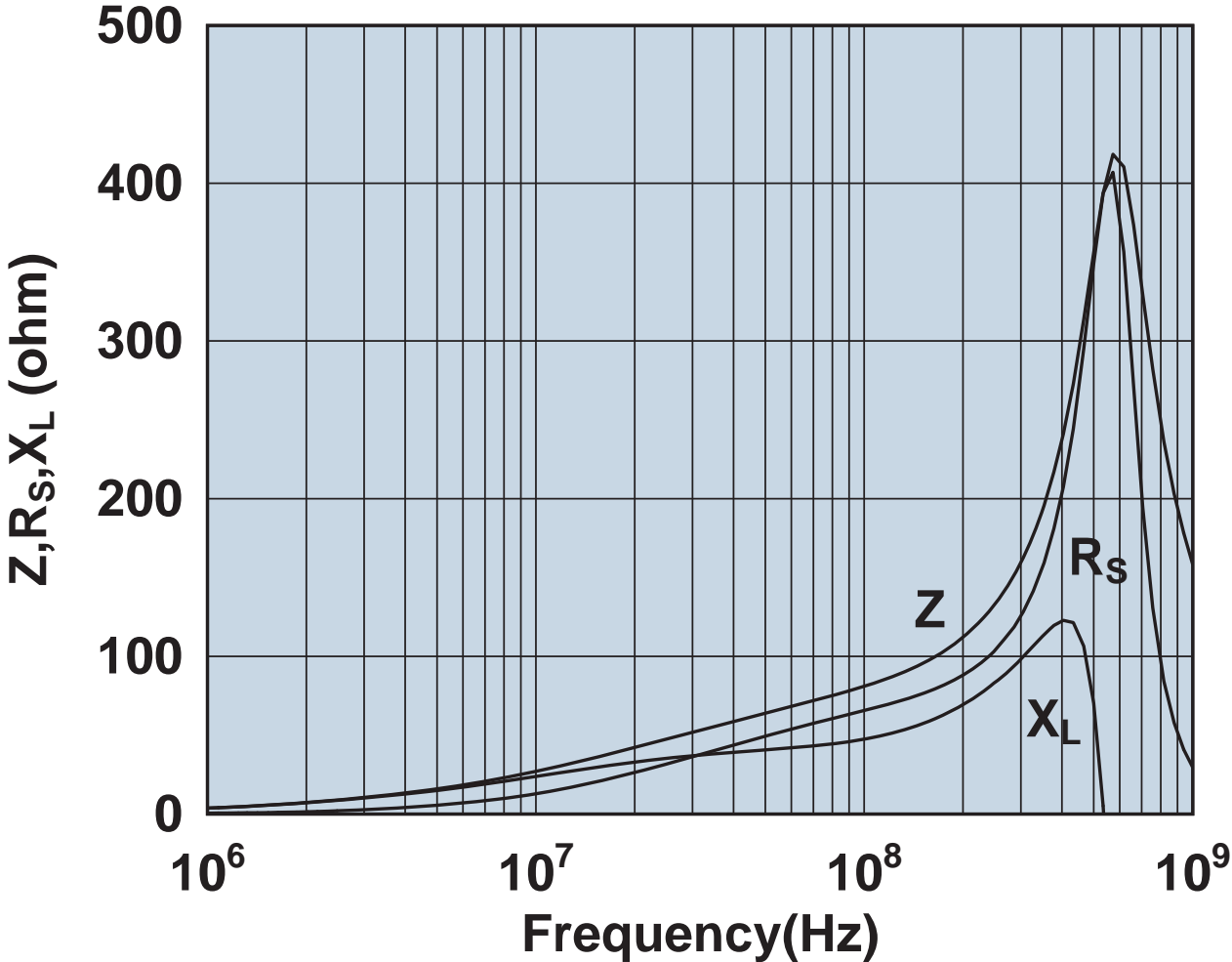

Impedance, reactance, and resistance vs. frequency.

0444164181

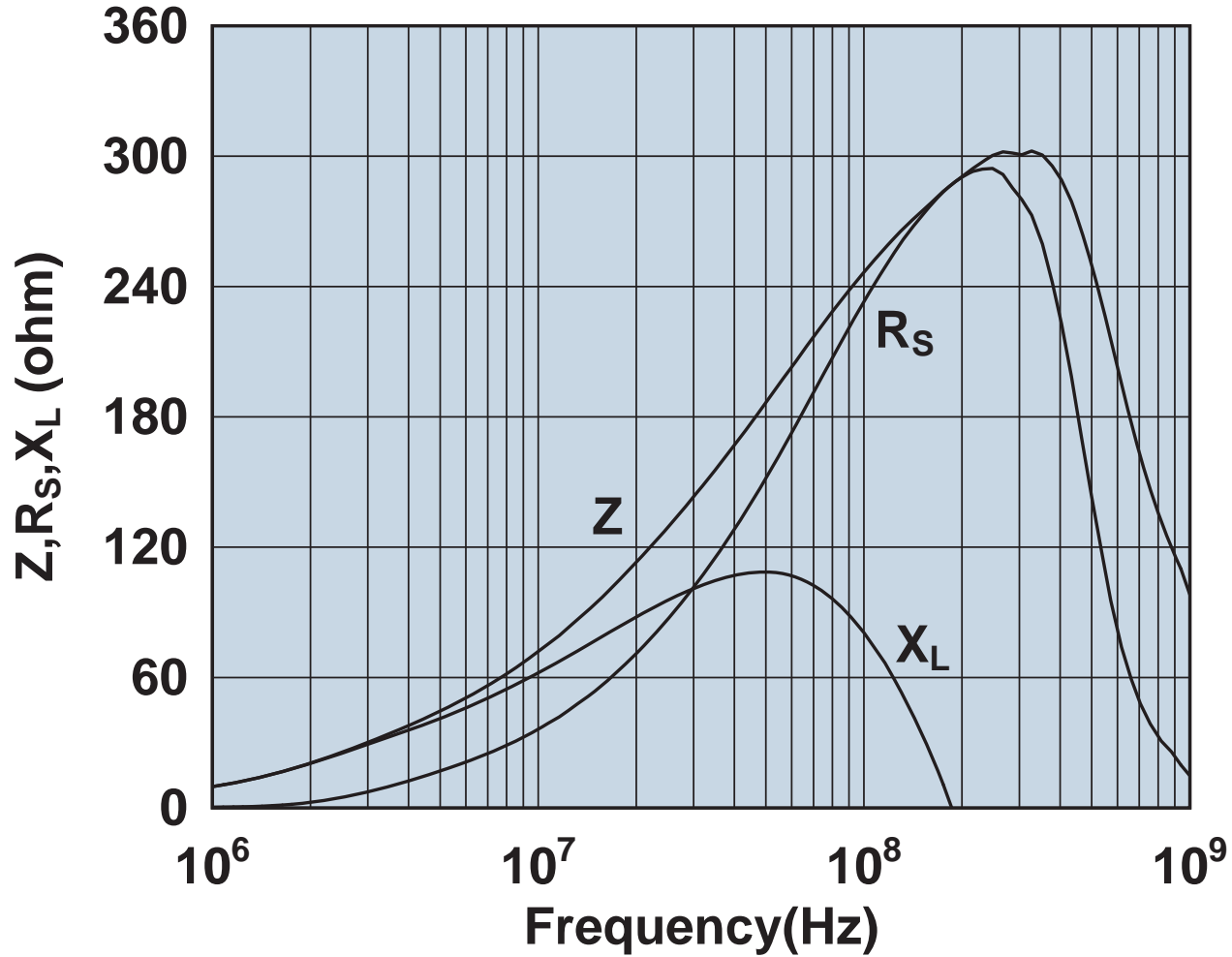

Impedance, reactance, and resistance vs. frequency.

0444164281

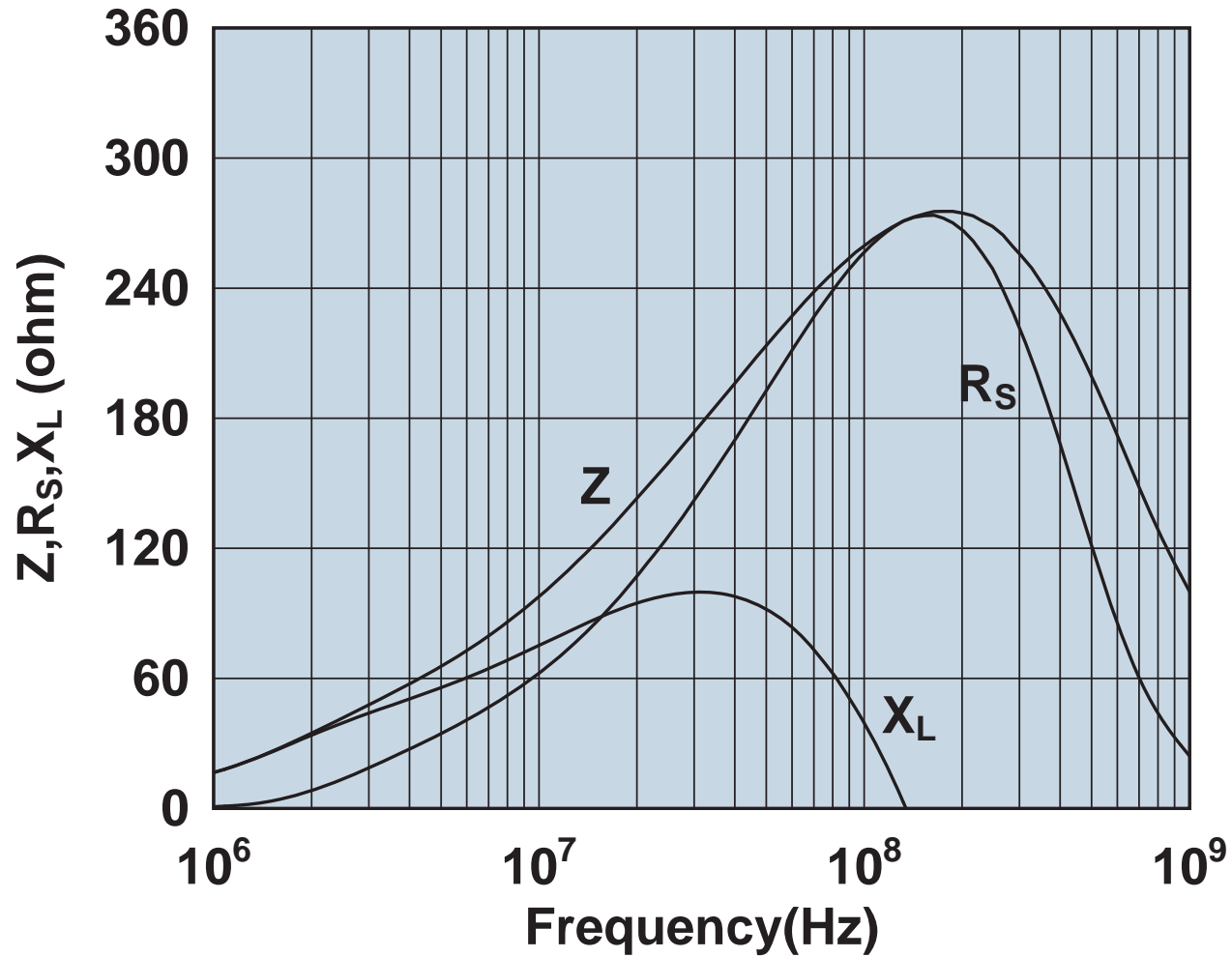

Impedance, reactance, and resistance vs. frequency.

0444164951

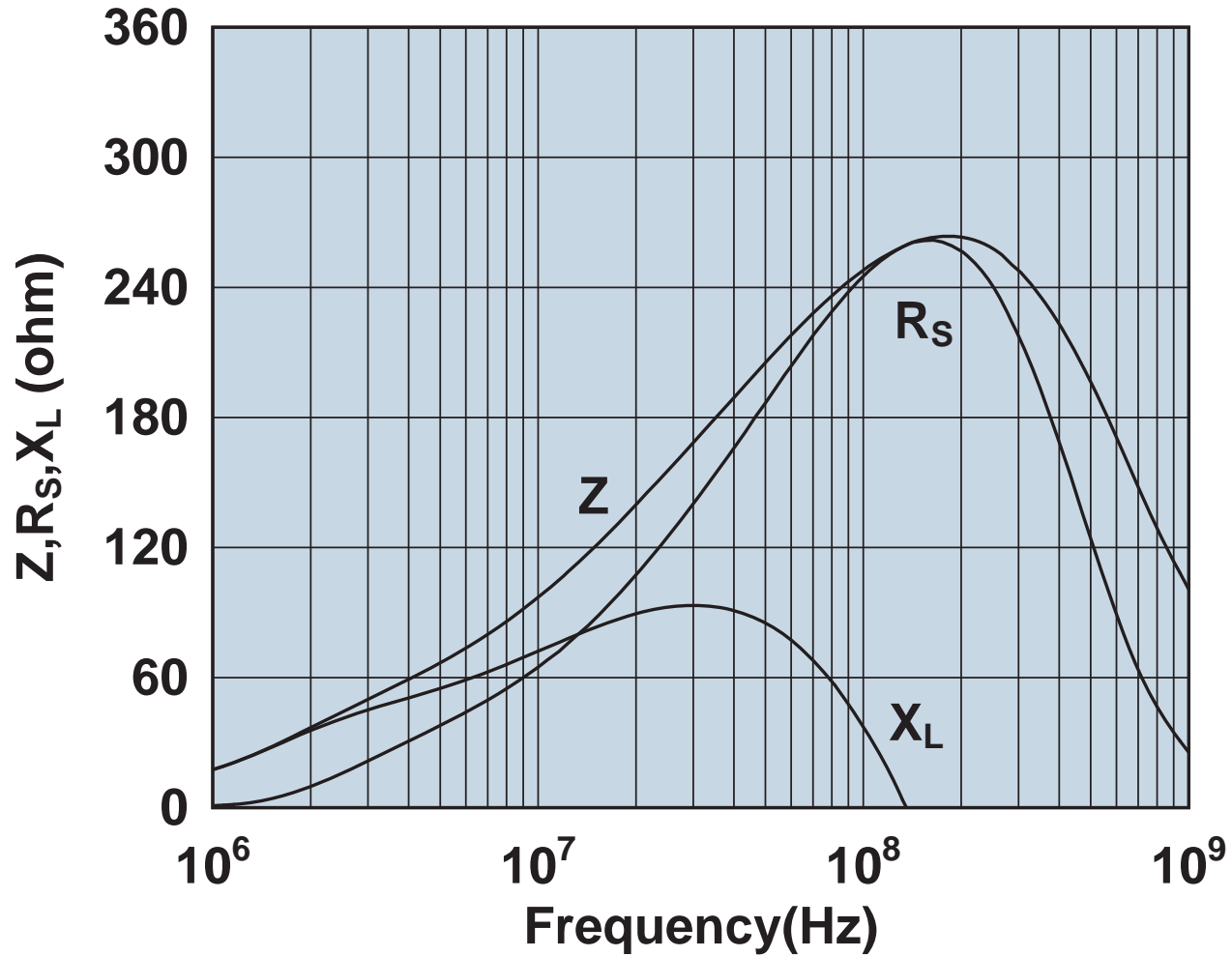

Impedance, reactance, and resistance vs. frequency.



0444167281

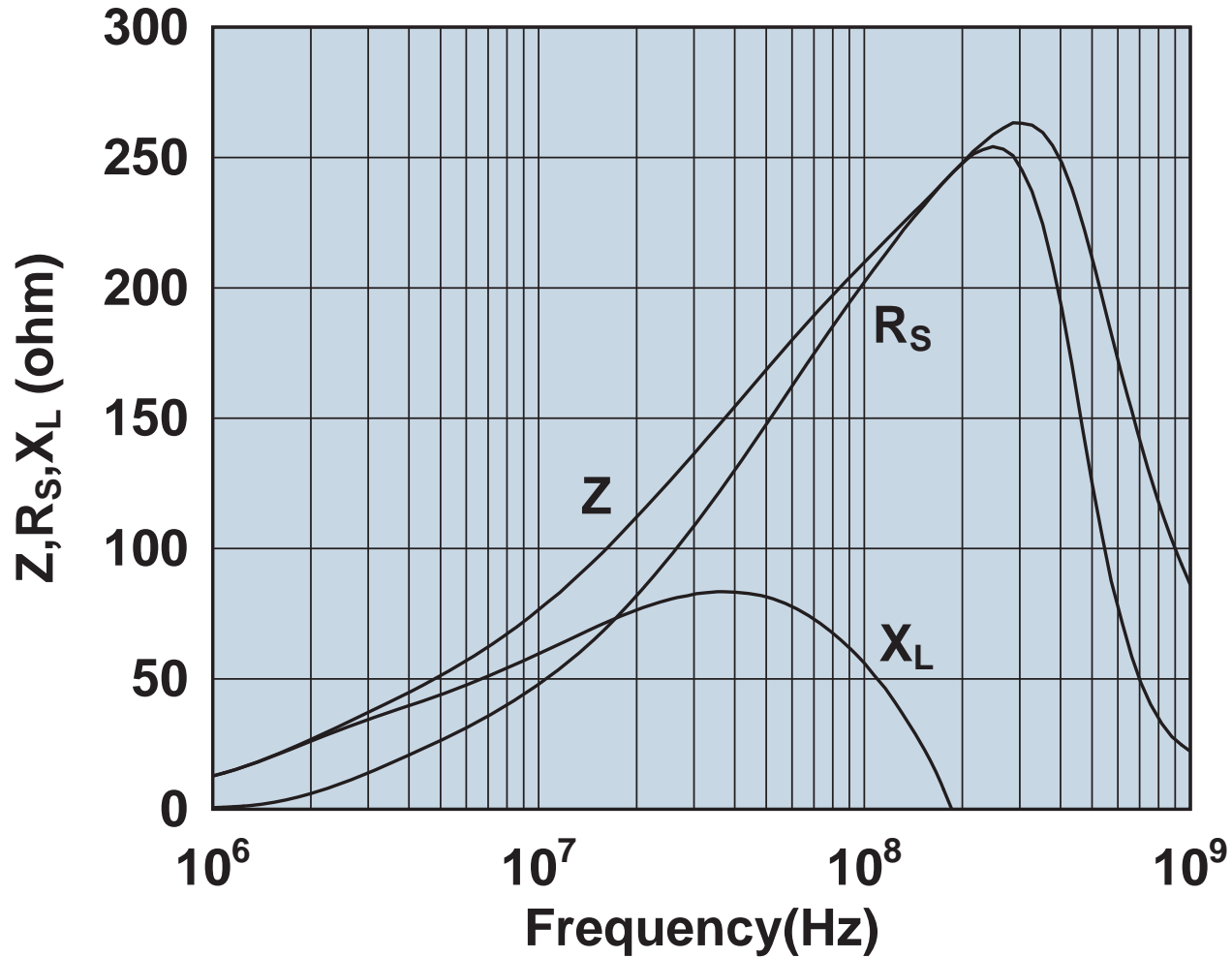

Impedance, reactance, and resistance vs. frequency.

0444173551

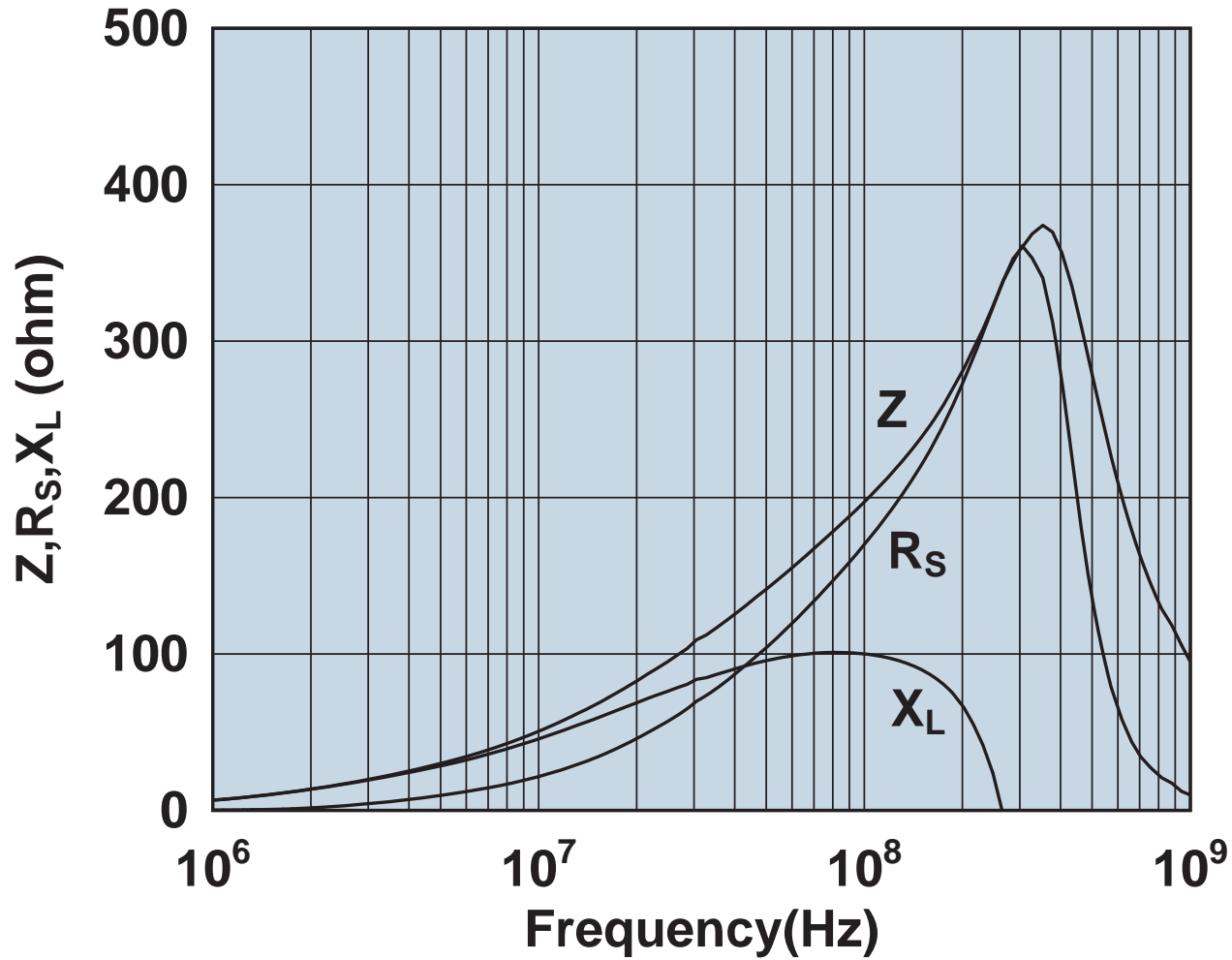

Impedance, reactance, and resistance vs. frequency.

0444173951

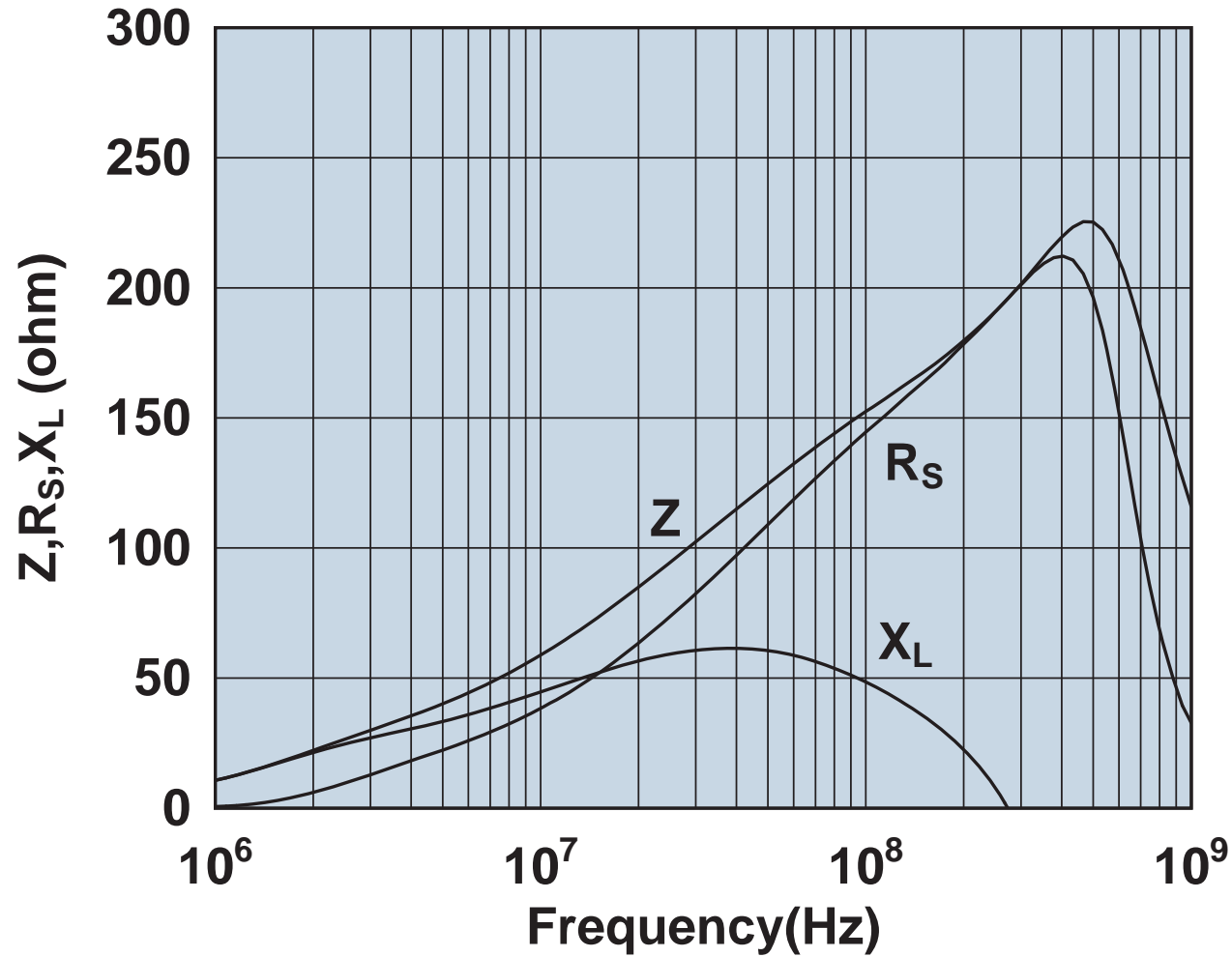

Impedance, reactance, and resistance vs. frequency.

0444176451

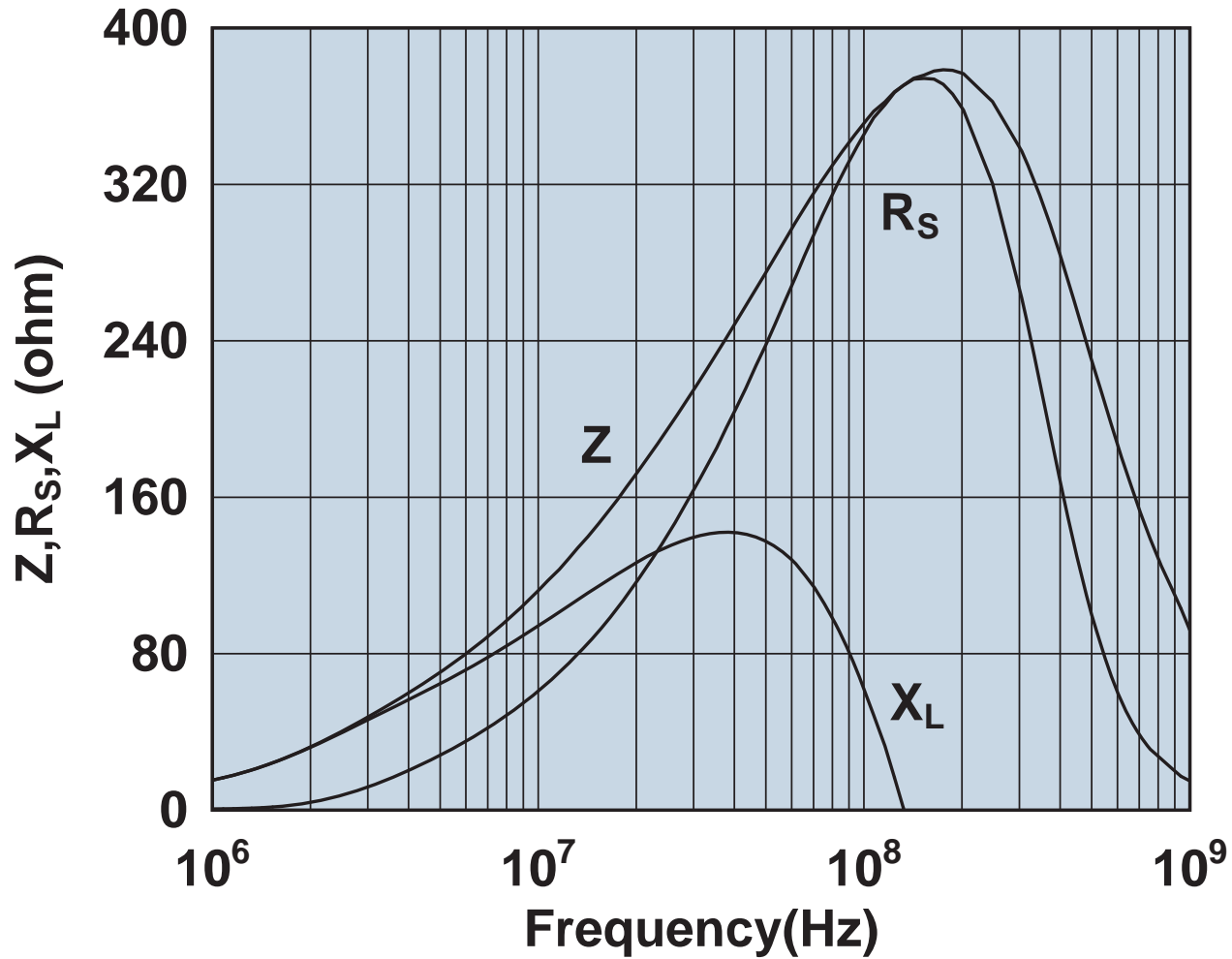

Impedance, reactance, and resistance vs. frequency.

0444177081

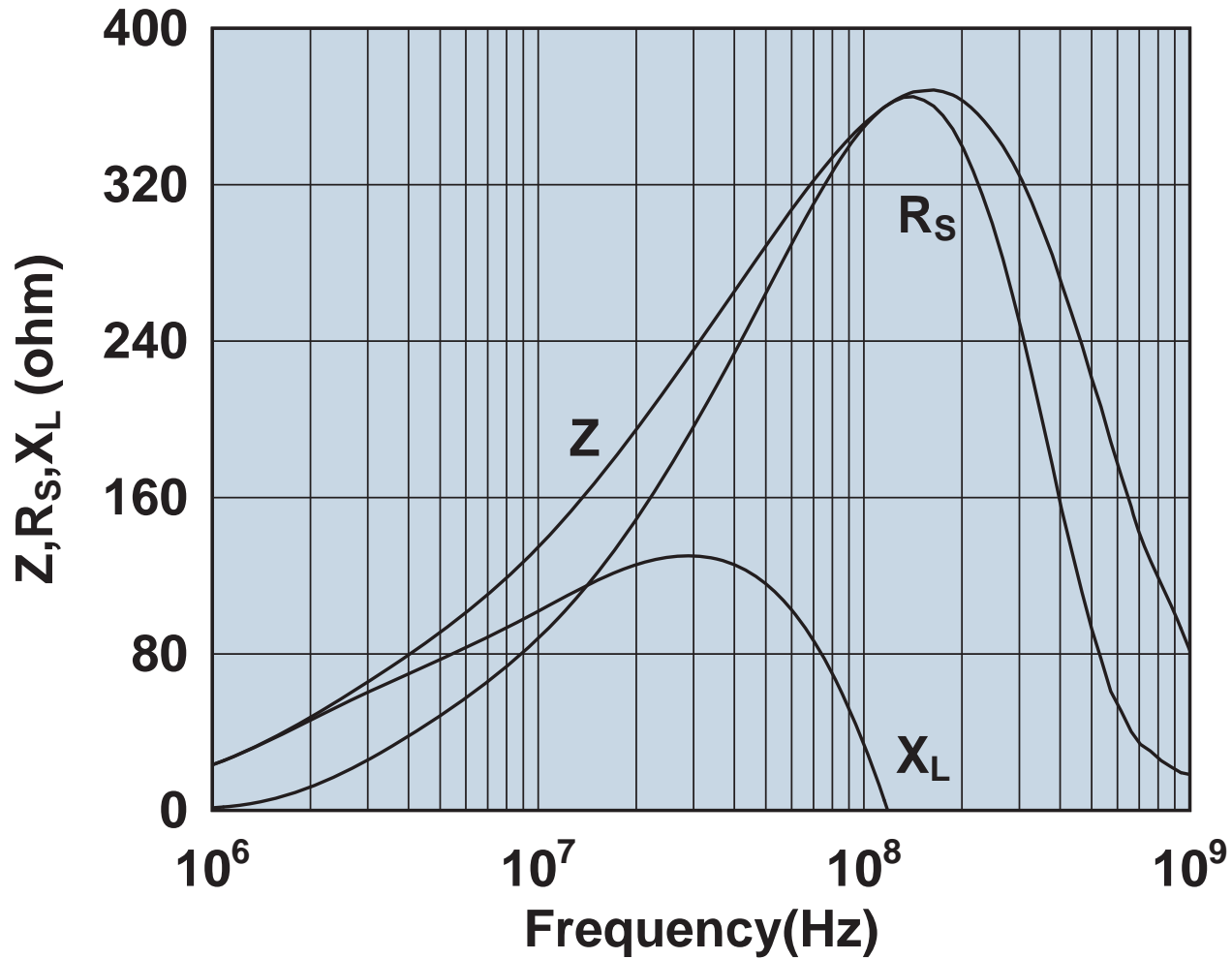

Impedance, reactance, and resistance vs. frequency.

0446164151

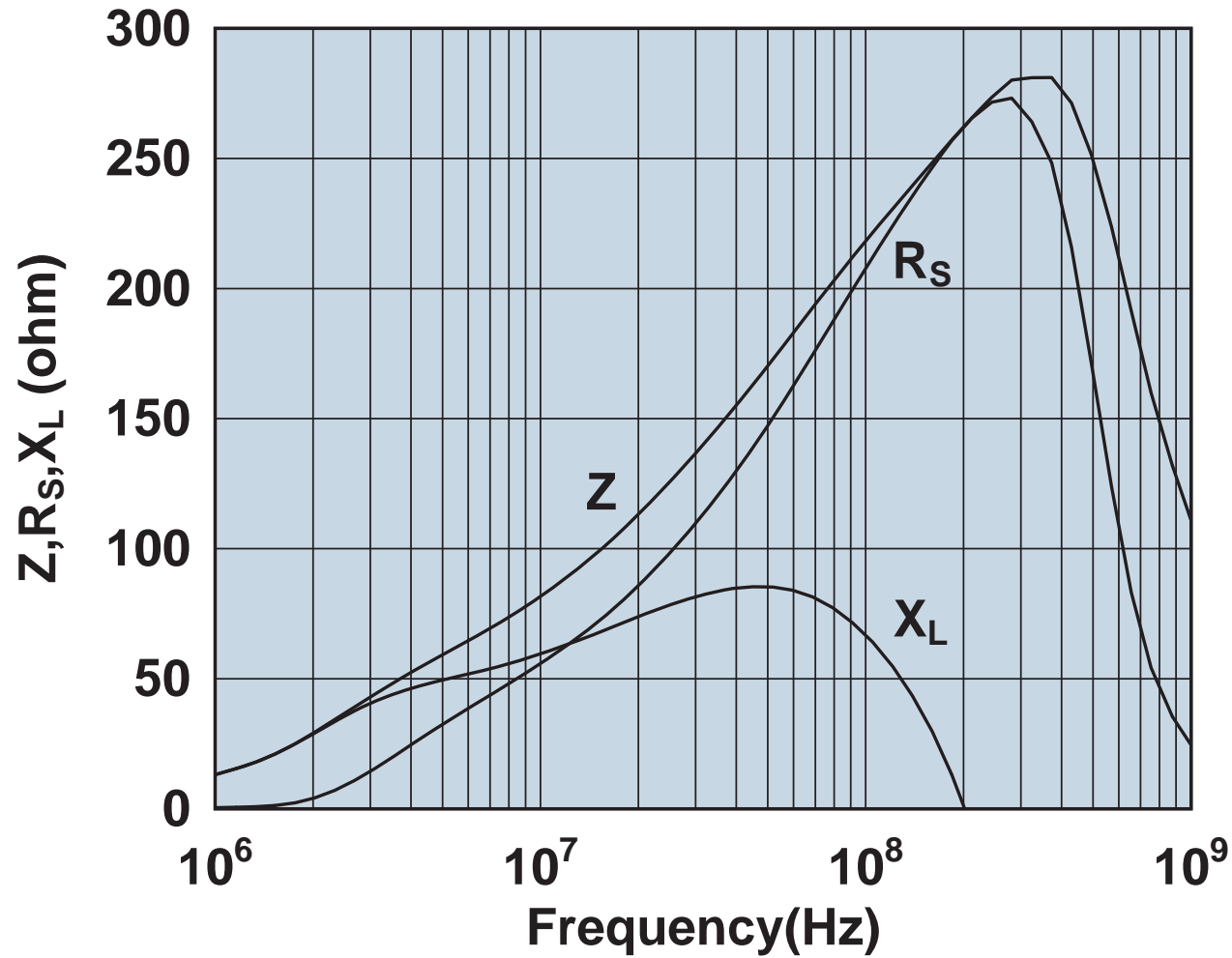

Impedance, reactance, and resistance vs. frequency.

0446164181

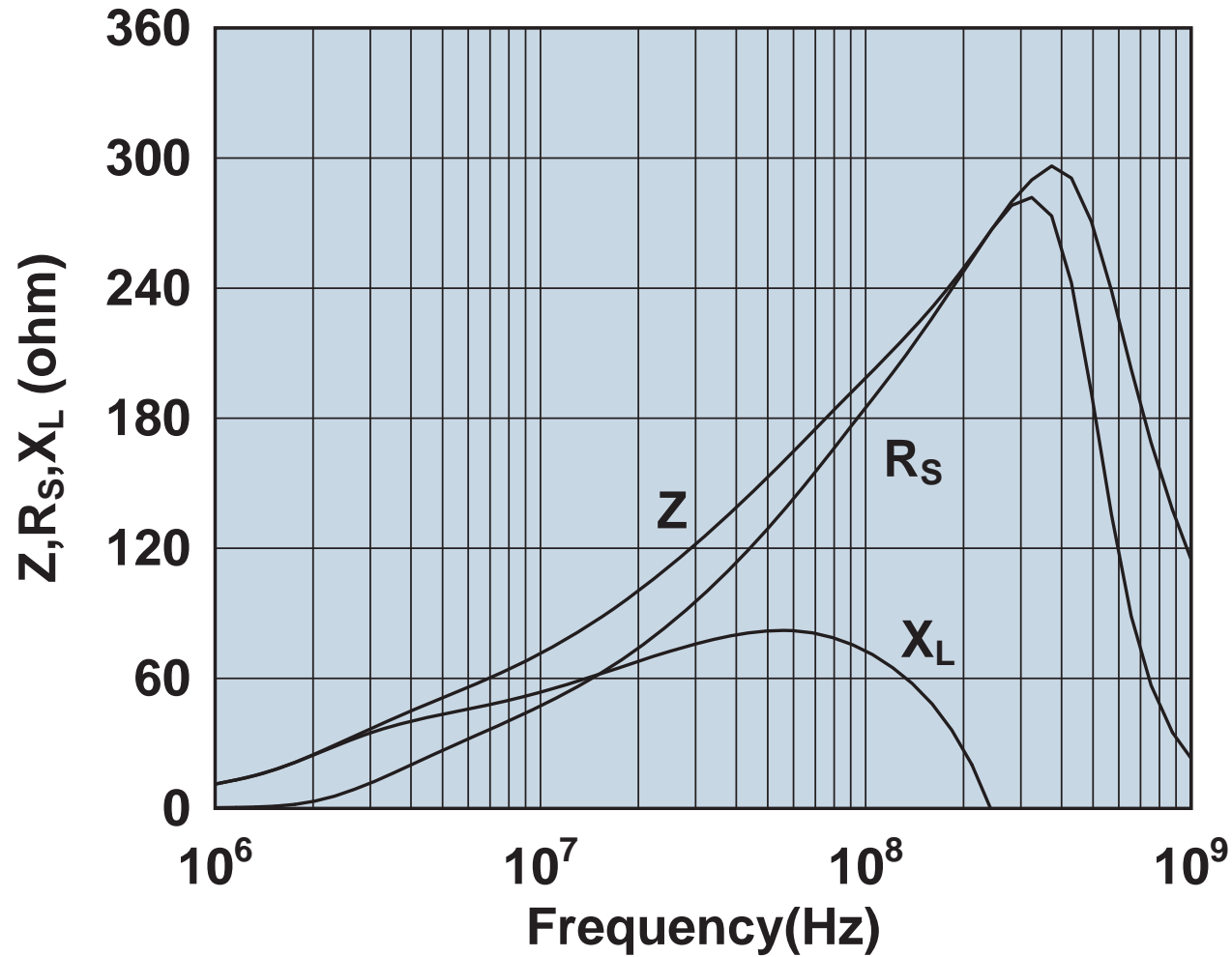

Impedance, reactance, and resistance vs. frequency.

0446164251

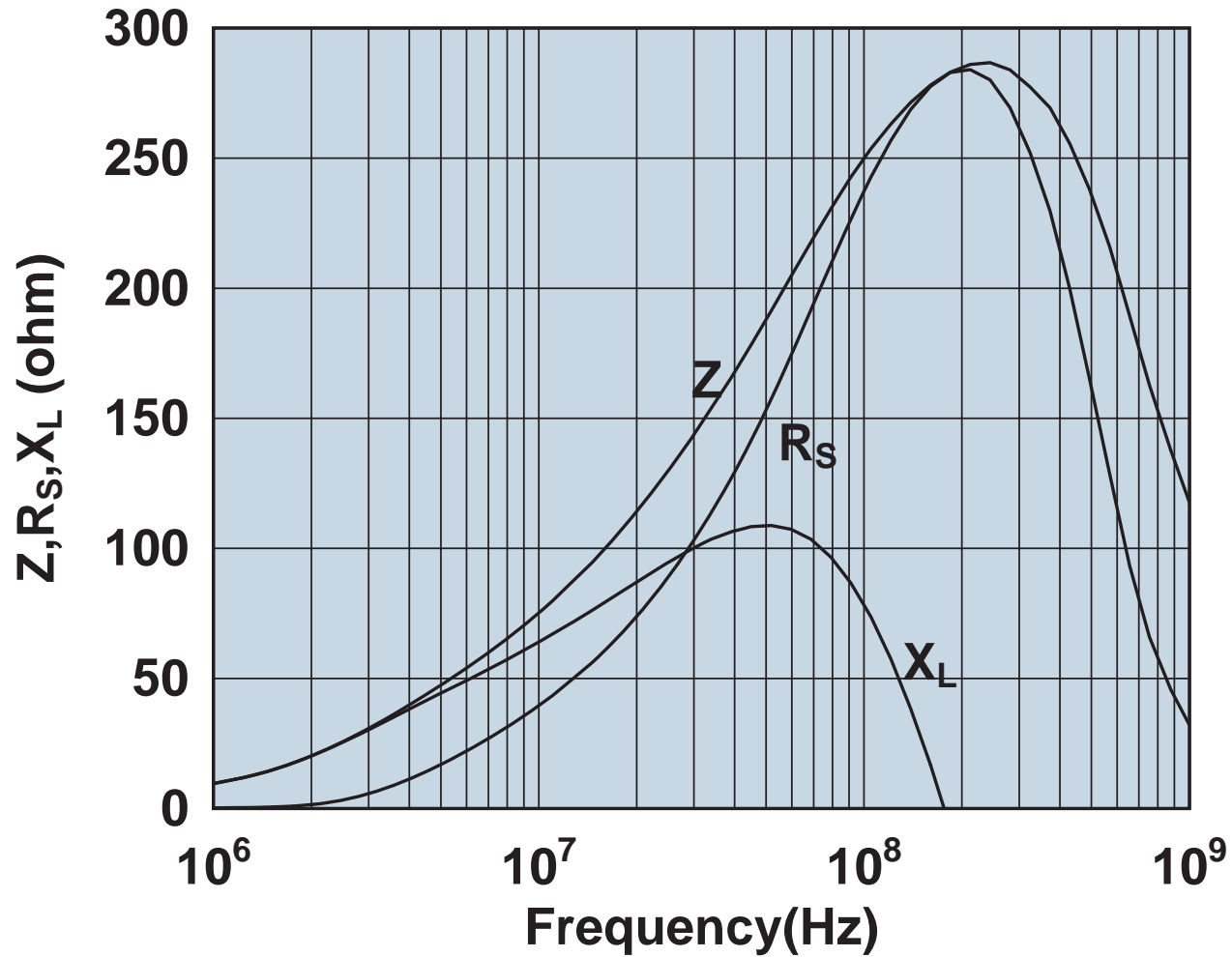

Impedance, reactance, and resistance vs. frequency.



0446164281

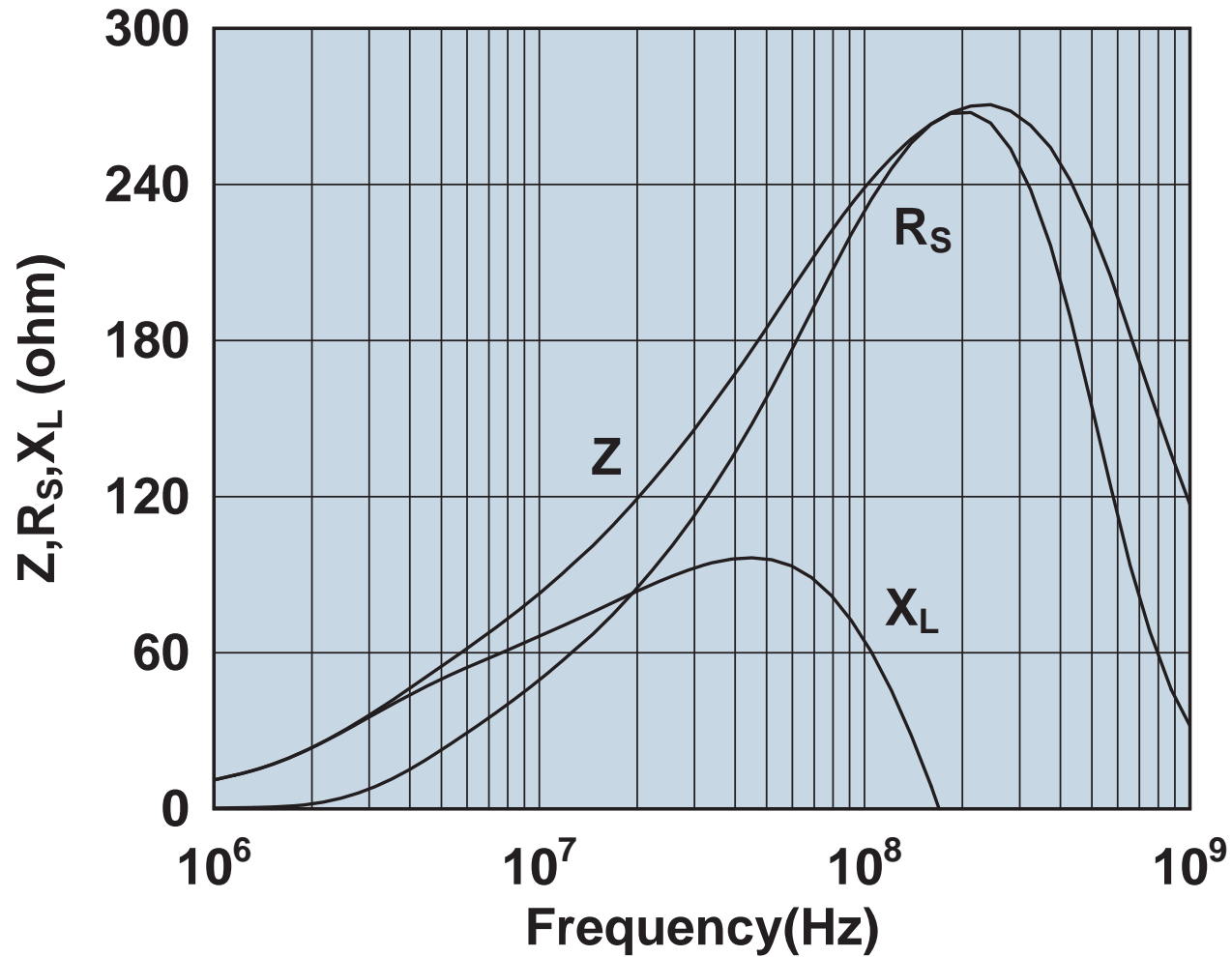

Impedance, reactance, and resistance vs. frequency.

0446164951

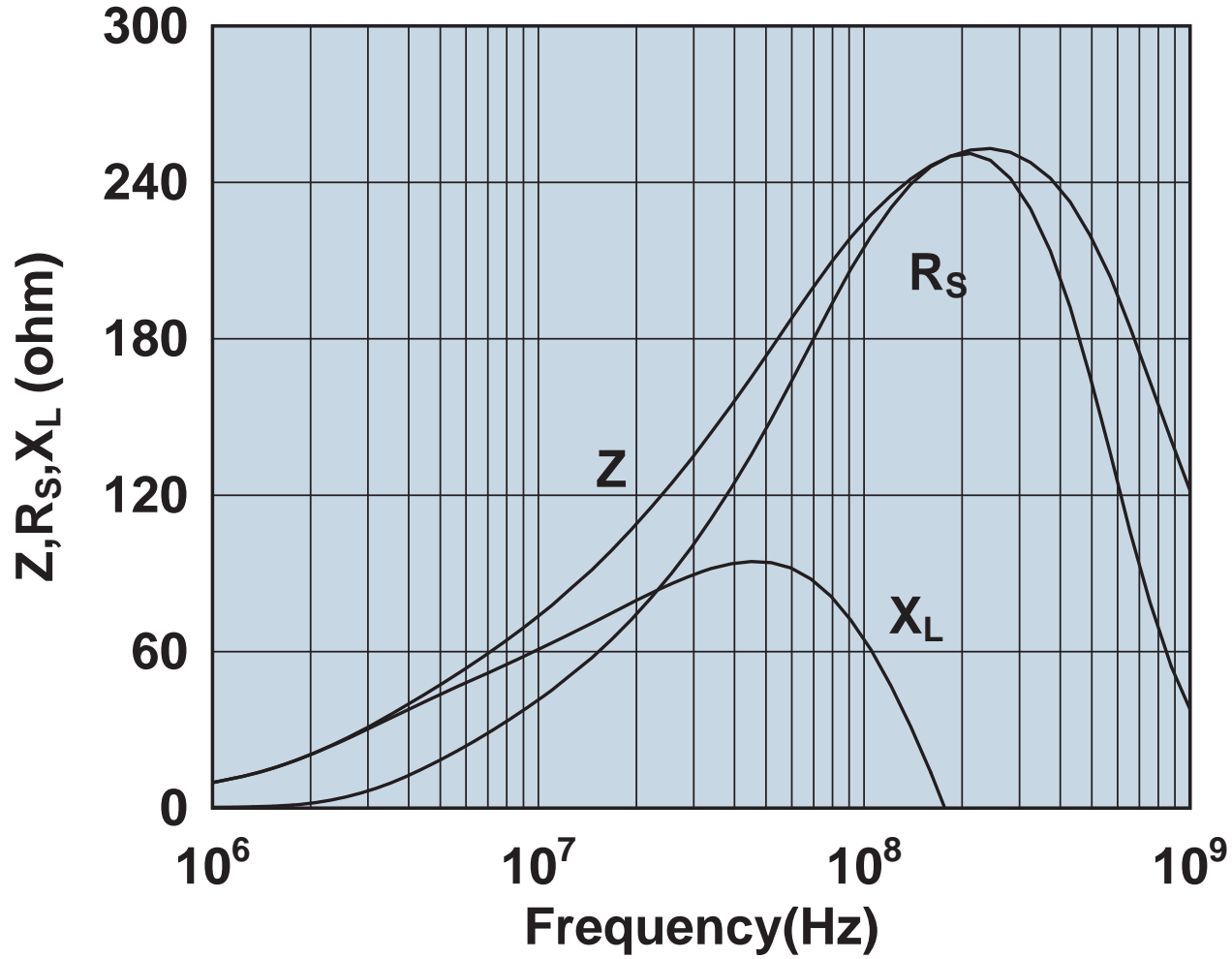

Impedance, reactance, and resistance vs. frequency.

0446167251

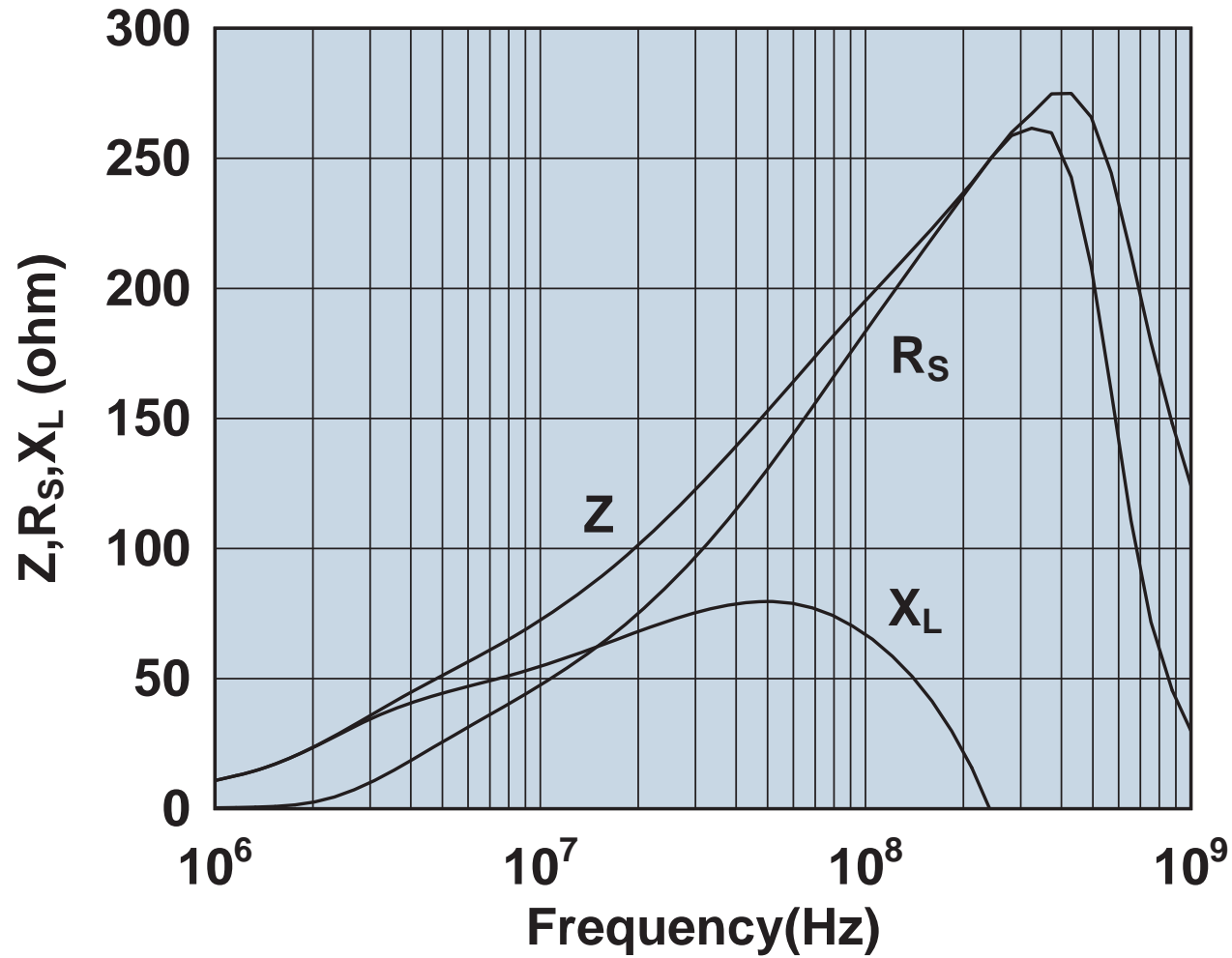

Impedance, reactance, and resistance vs. frequency.

0446167281

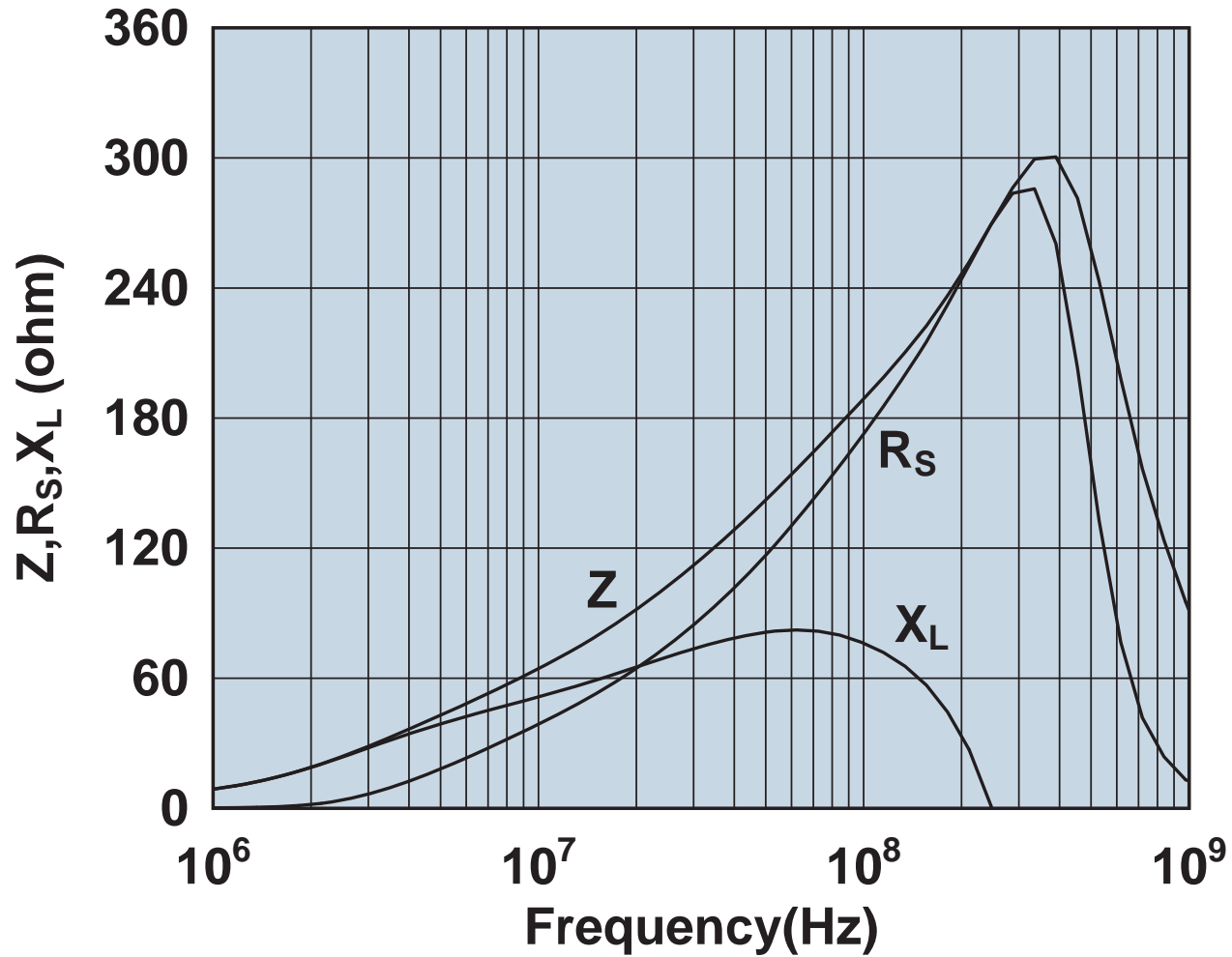

Impedance, reactance, and resistance vs. frequency.

0446173551

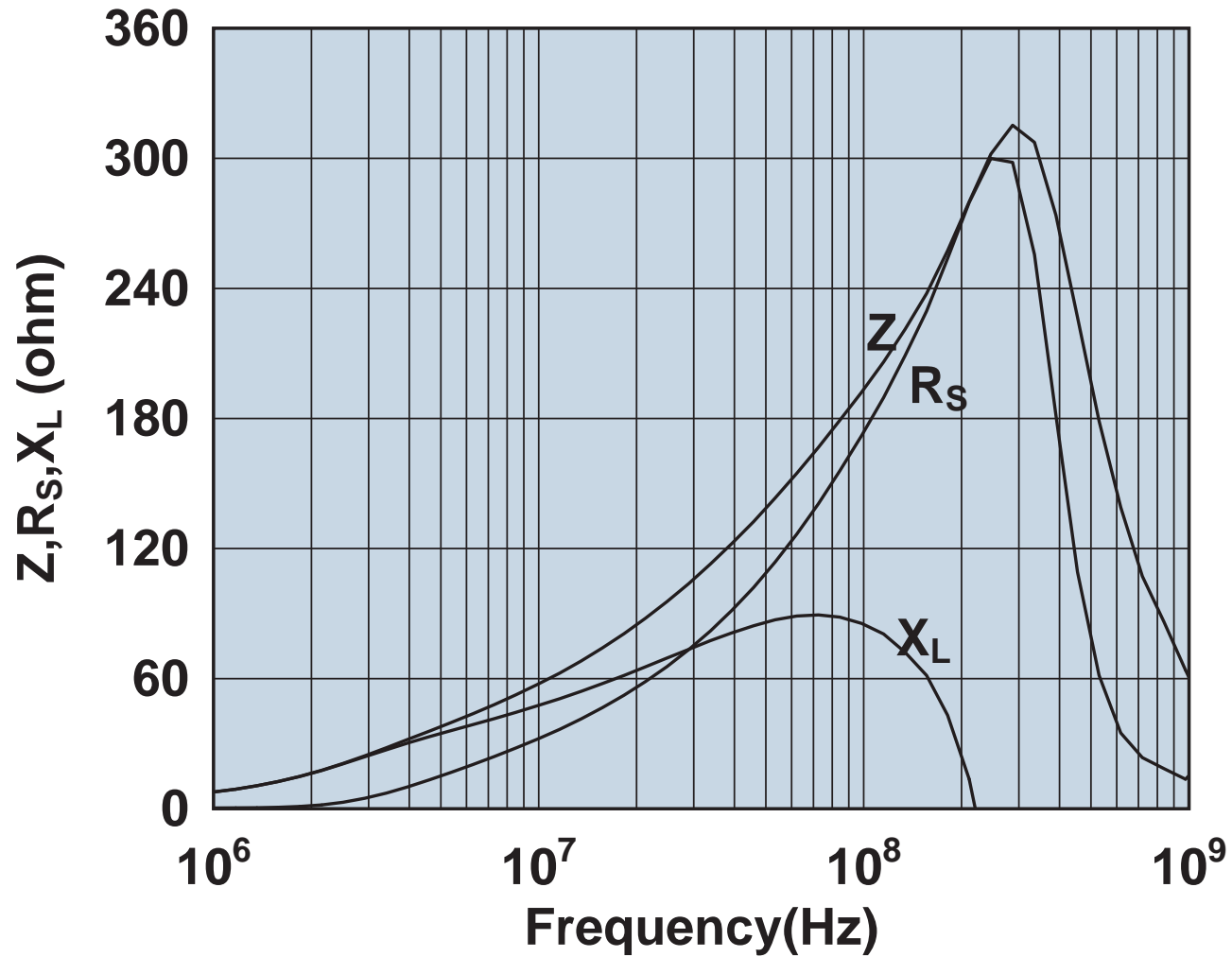

Impedance, reactance, and resistance vs. frequency.

0446173951

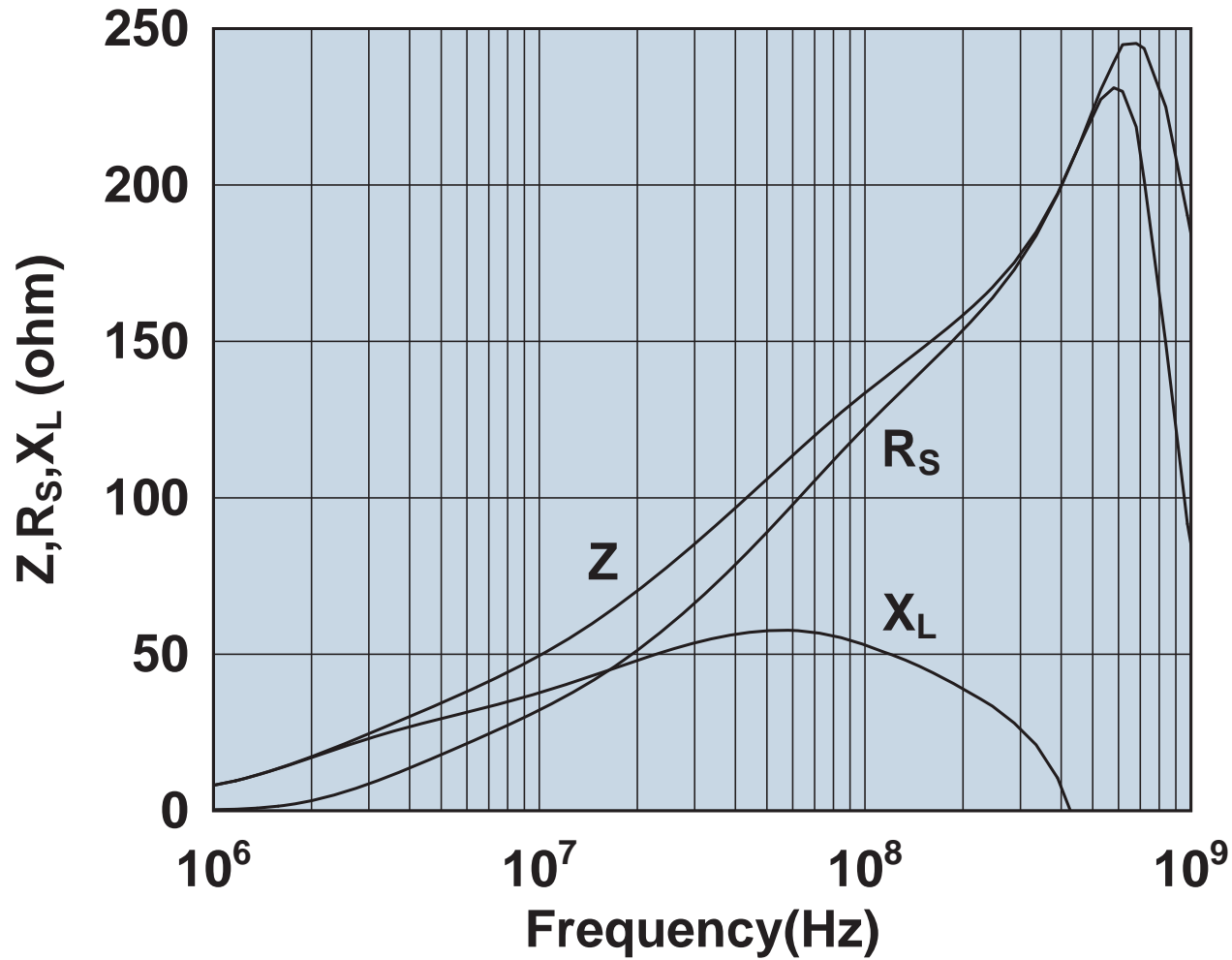

Impedance, reactance, and resistance vs. frequency.

0446176451

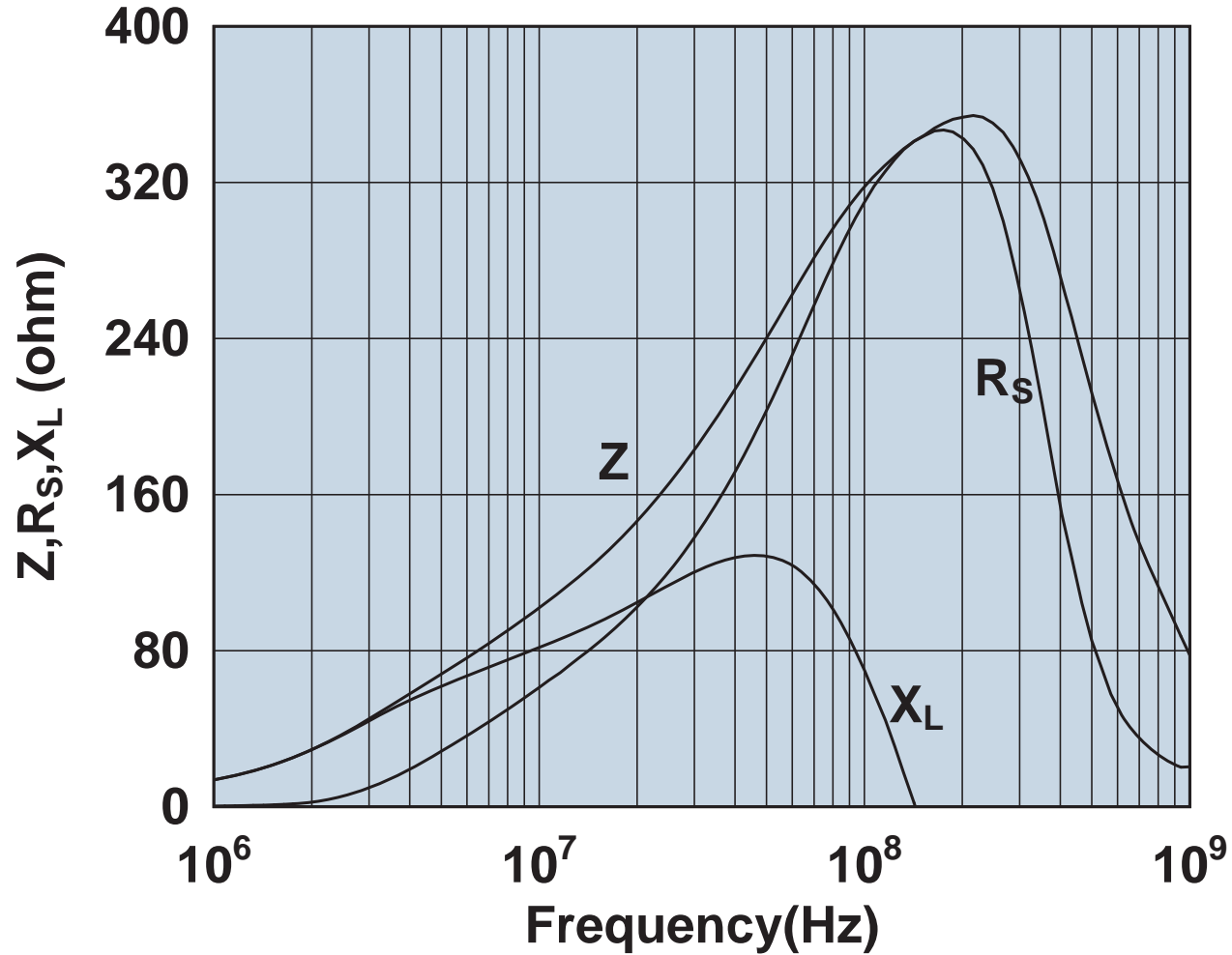

Impedance, reactance, and resistance vs. frequency.

0446177081

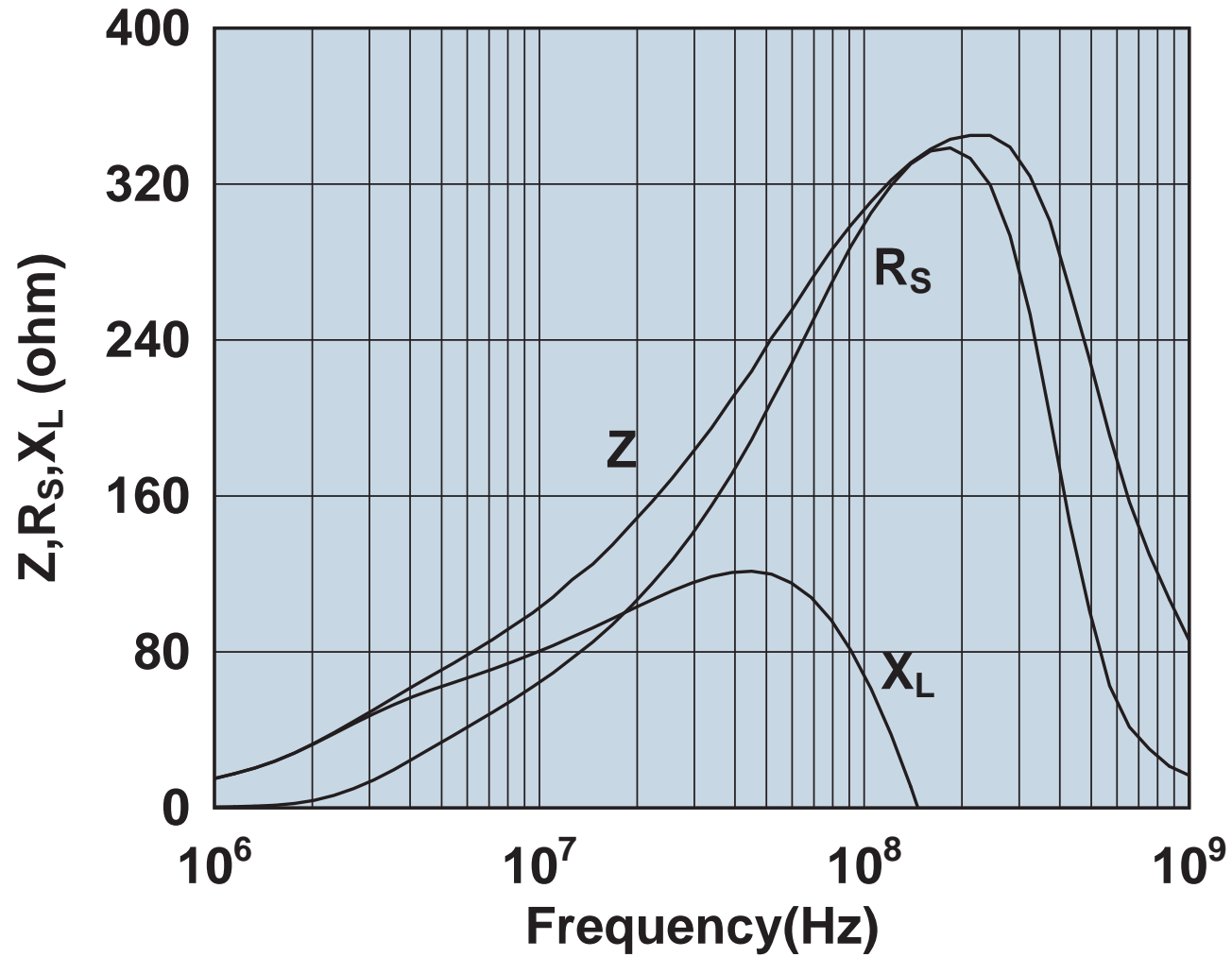

Impedance, reactance, and resistance vs. frequency.



0461164181

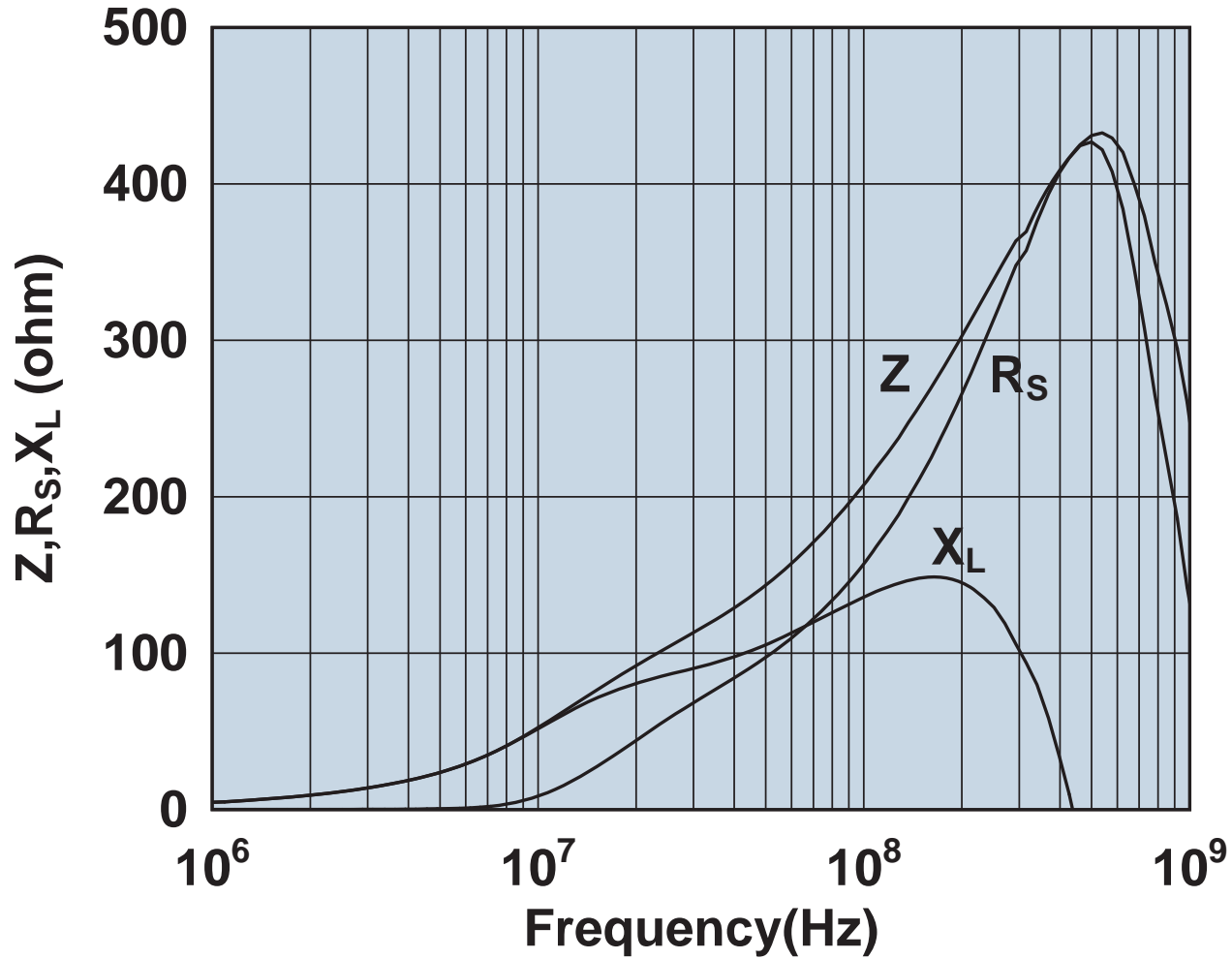

Impedance, reactance, and resistance vs. frequency.

0461164281

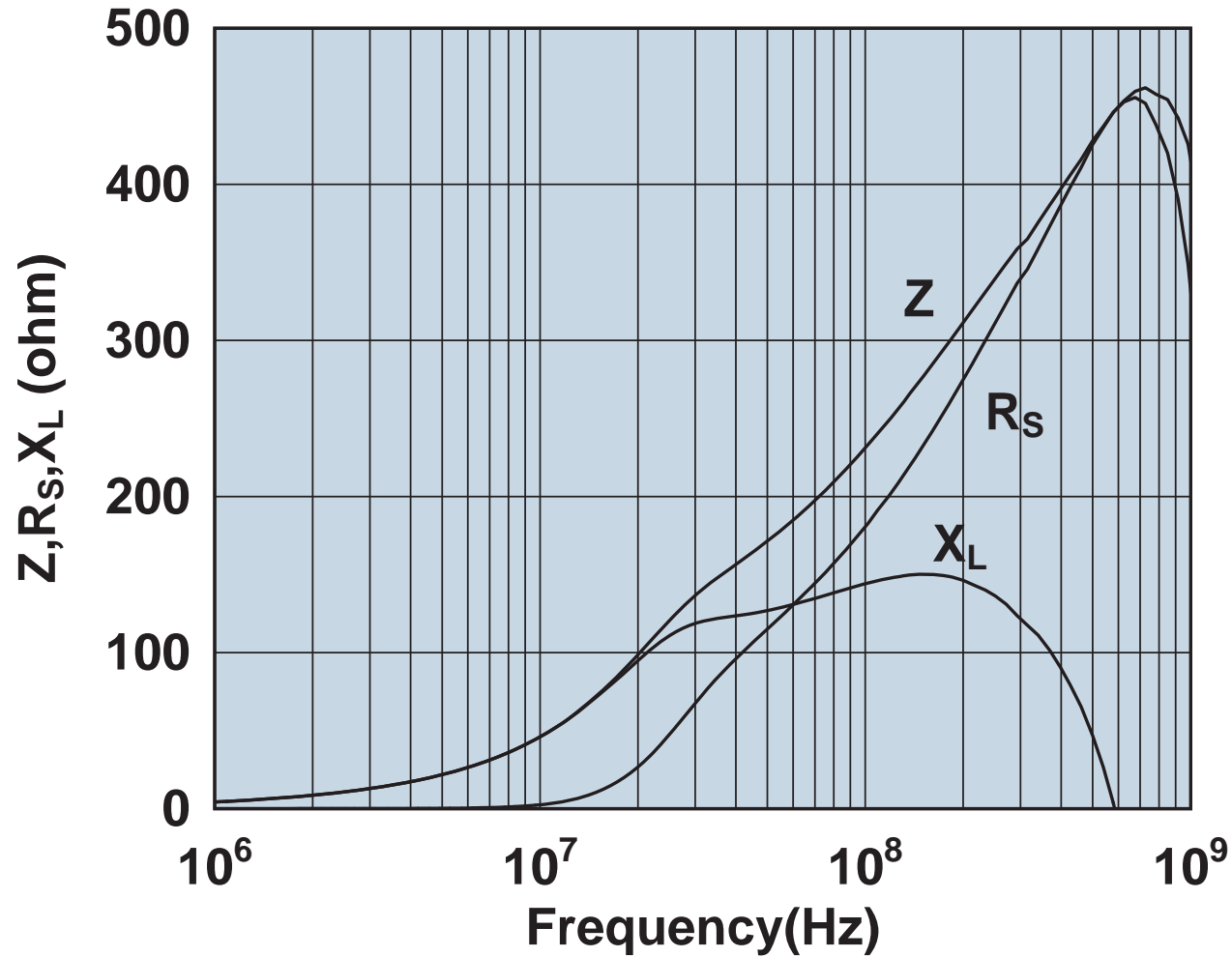

Impedance, reactance, and resistance vs. frequency.

0461164951

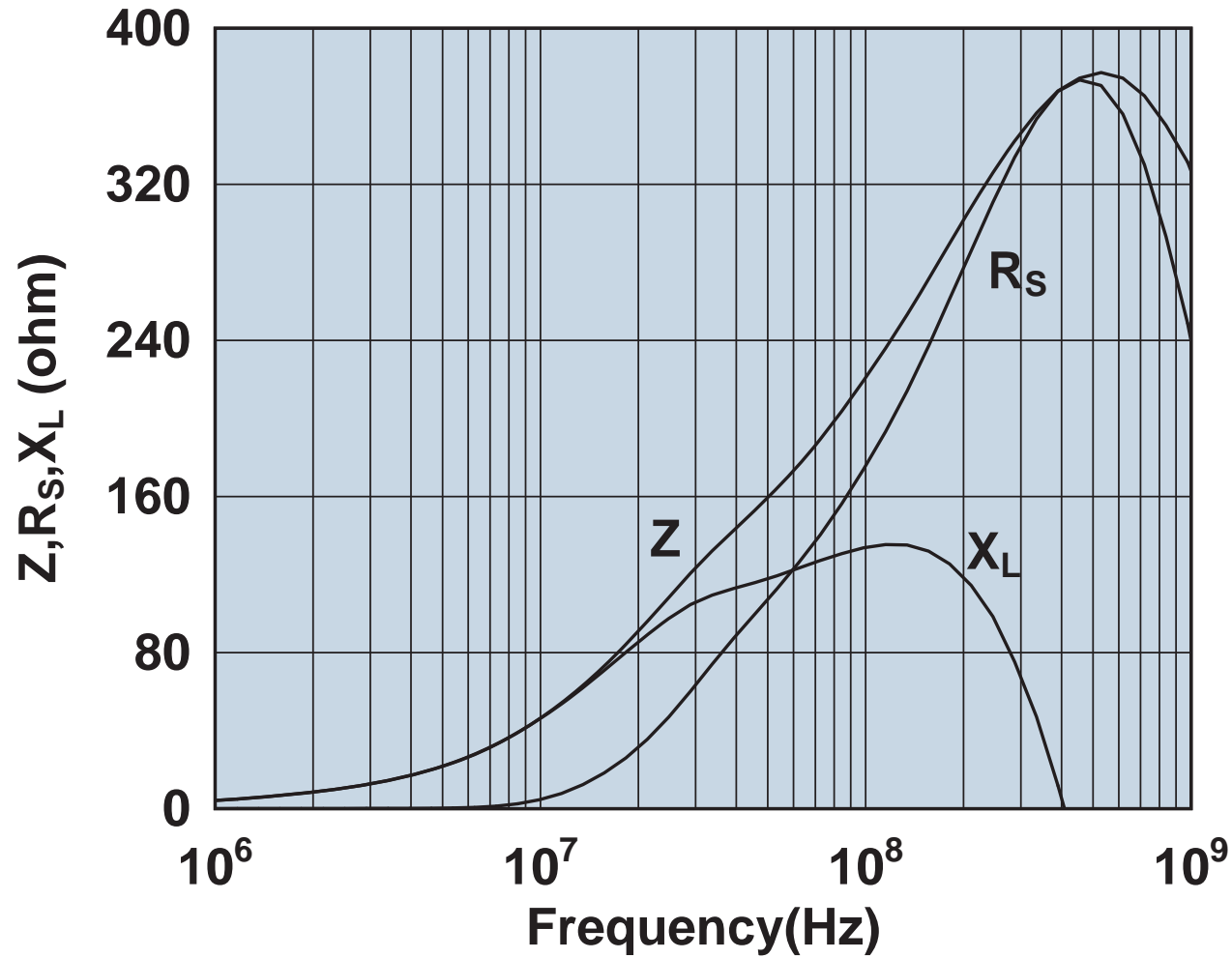

Impedance, reactance, and resistance vs. frequency.

0461167281

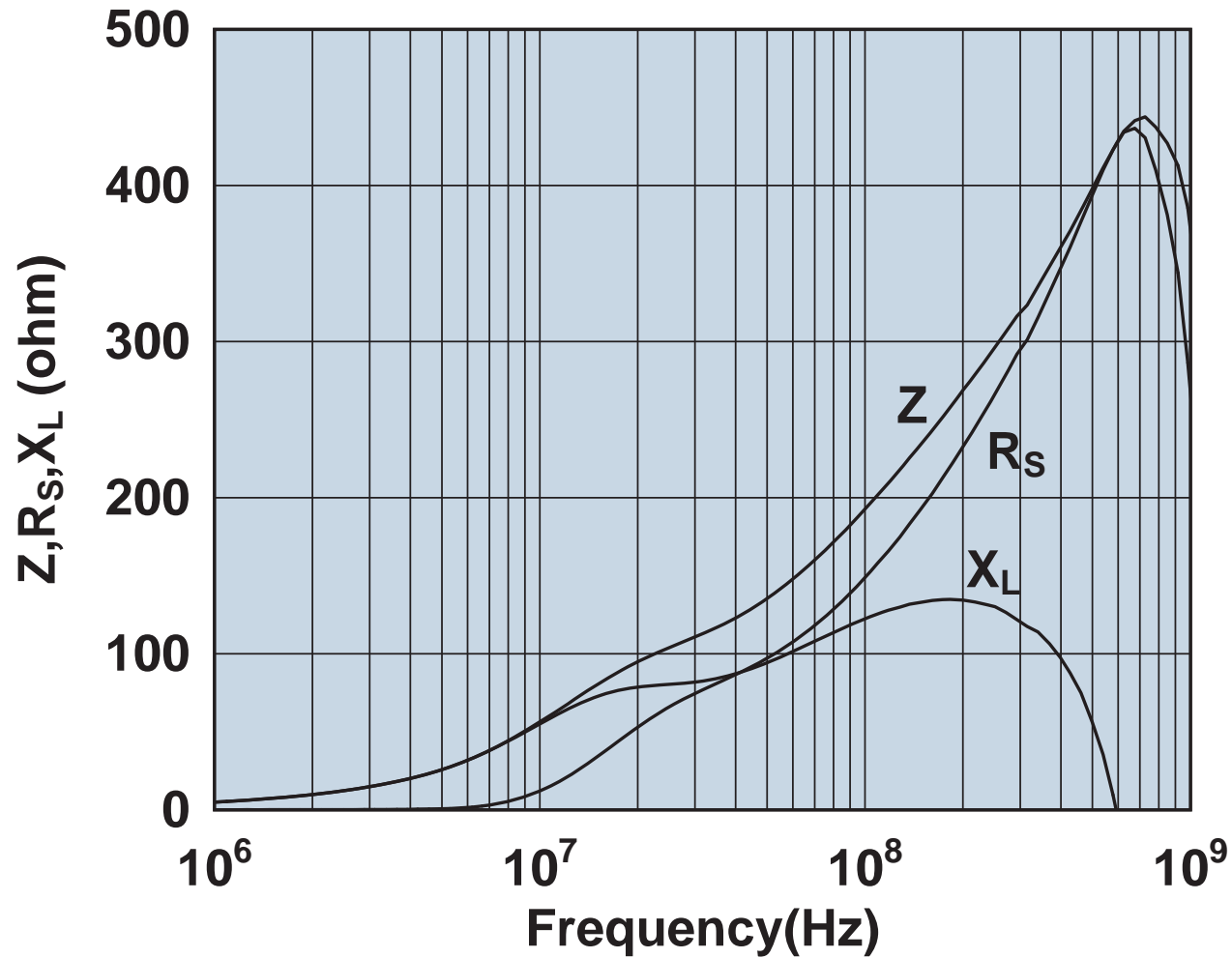

Impedance, reactance, and resistance vs. frequency.

0461176451

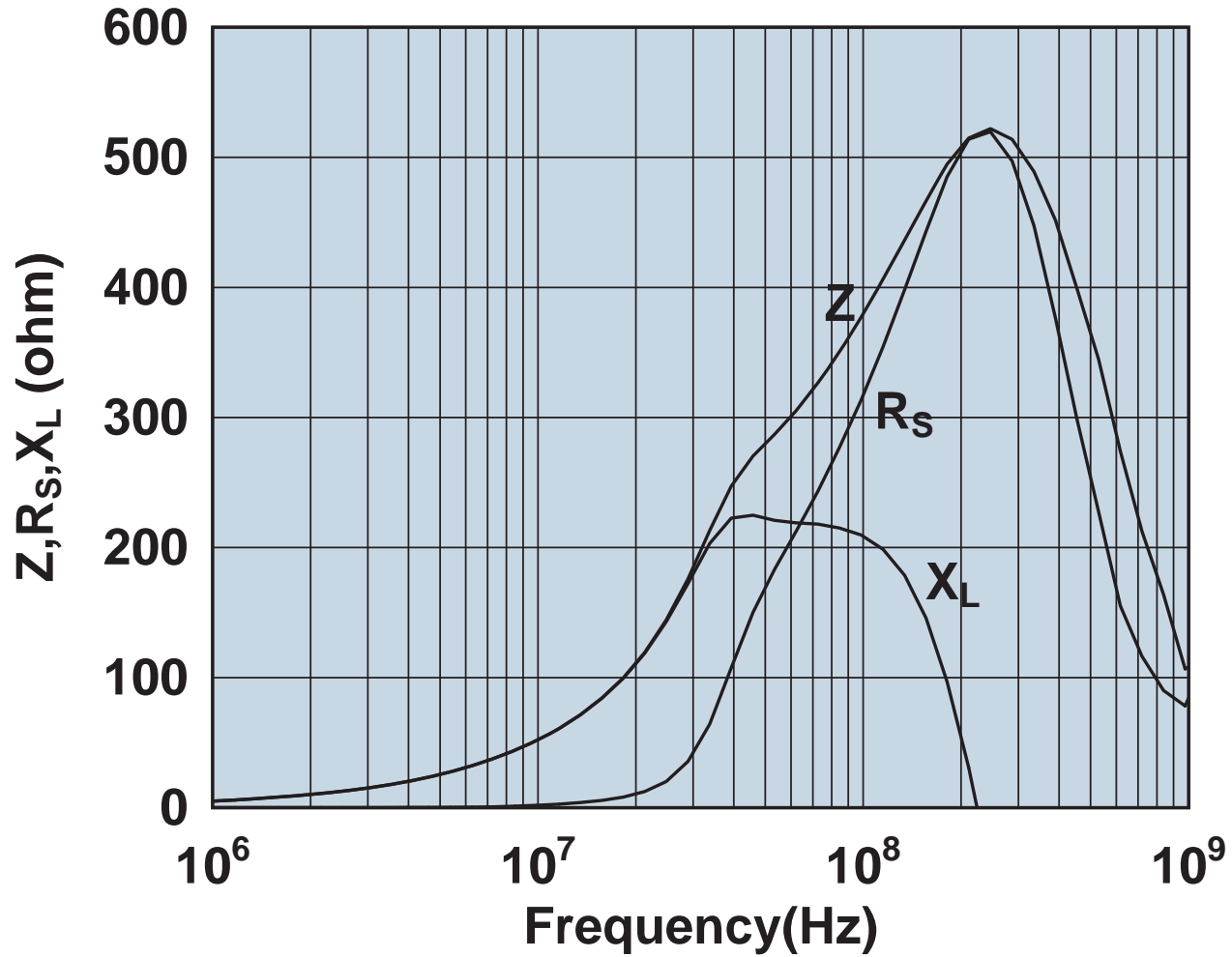

Impedance, reactance, and resistance vs. frequency.

0461178181

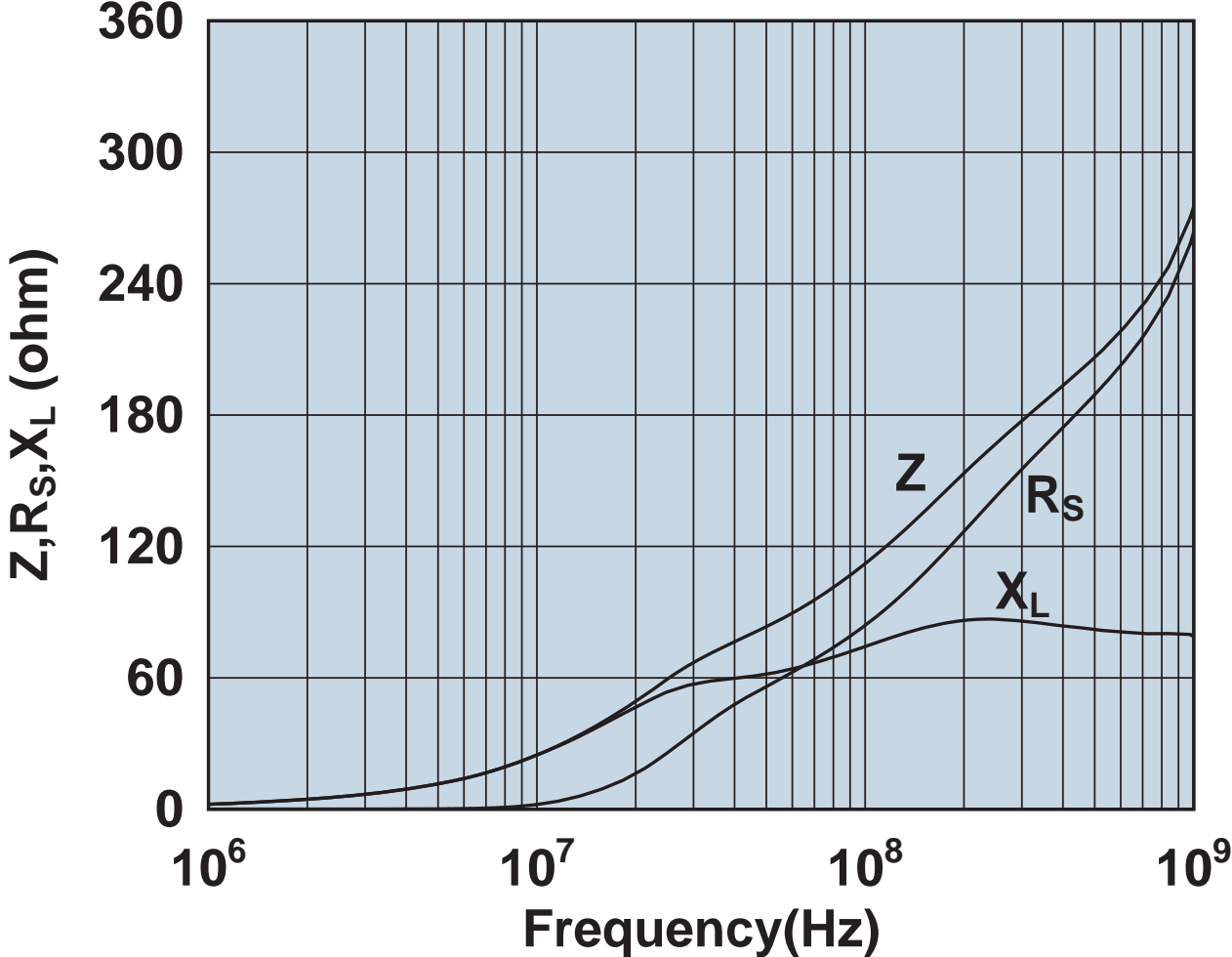

Impedance, reactance, and resistance vs. frequency.

0461178281

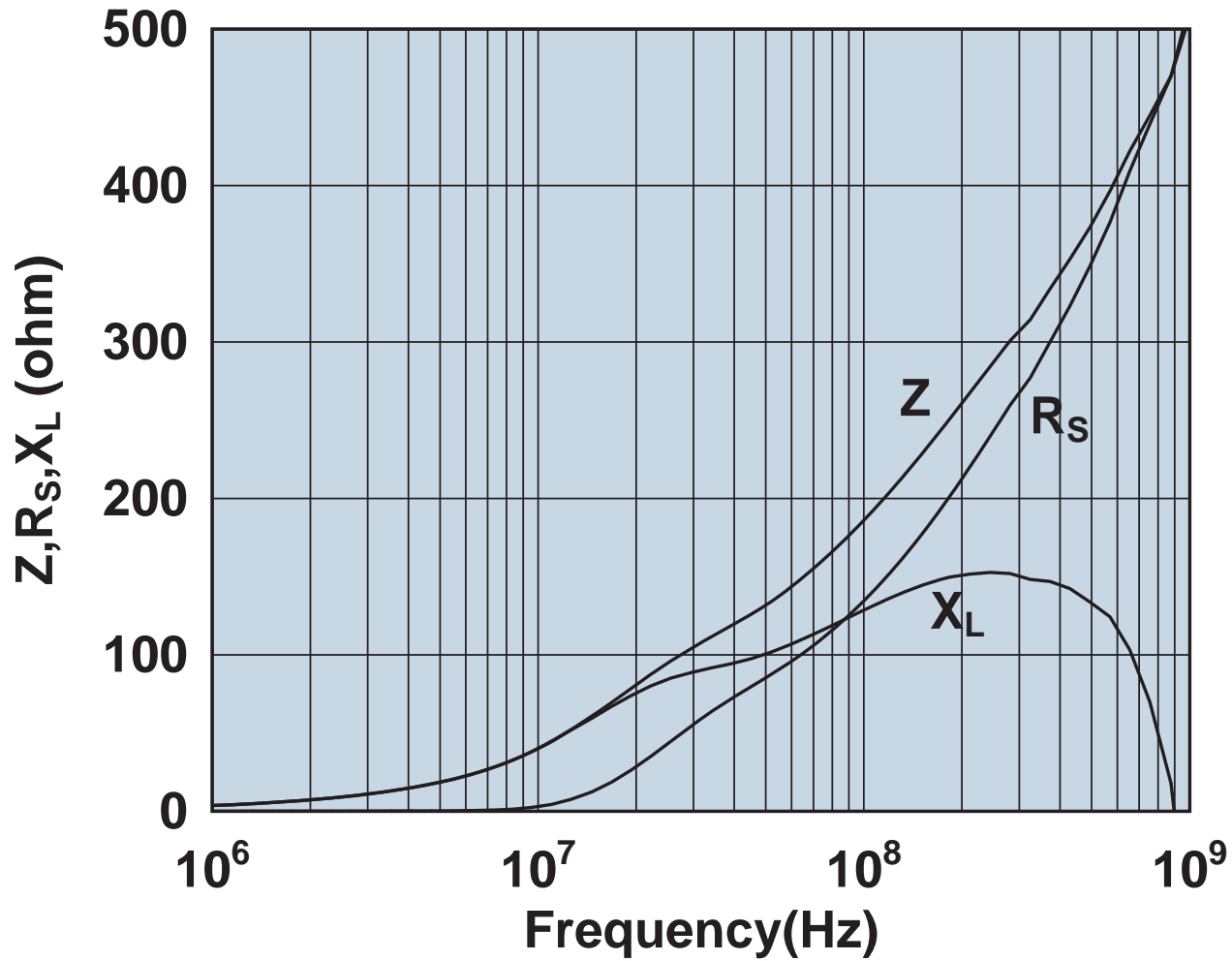

Impedance, reactance, and resistance vs. frequency.

2631023002

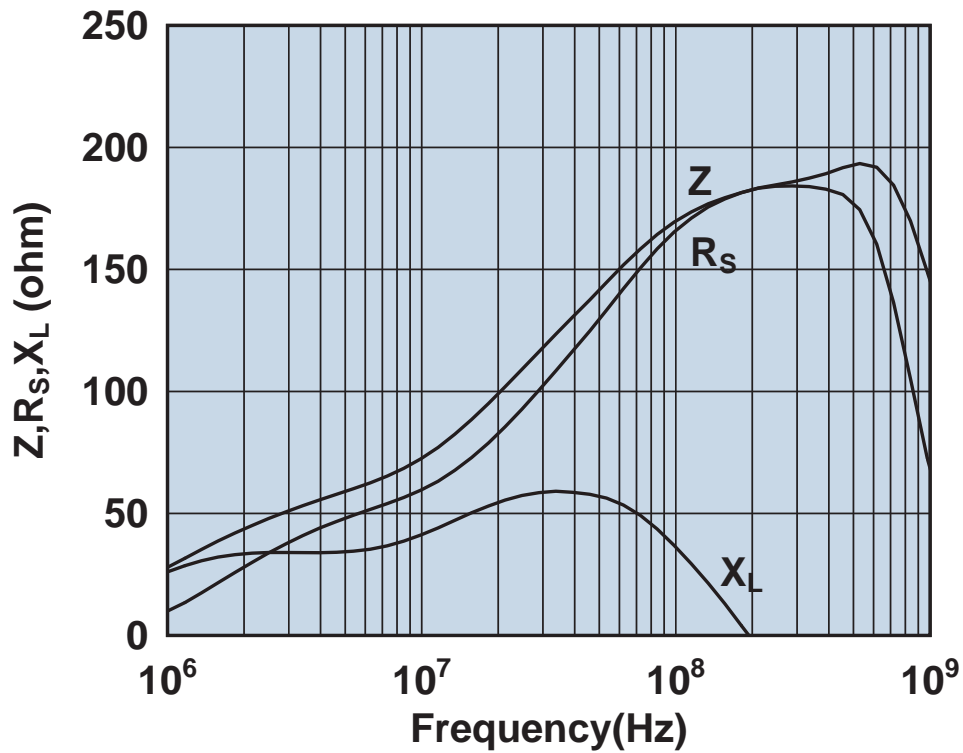

Impedance, reactance, and resistance vs. frequency.

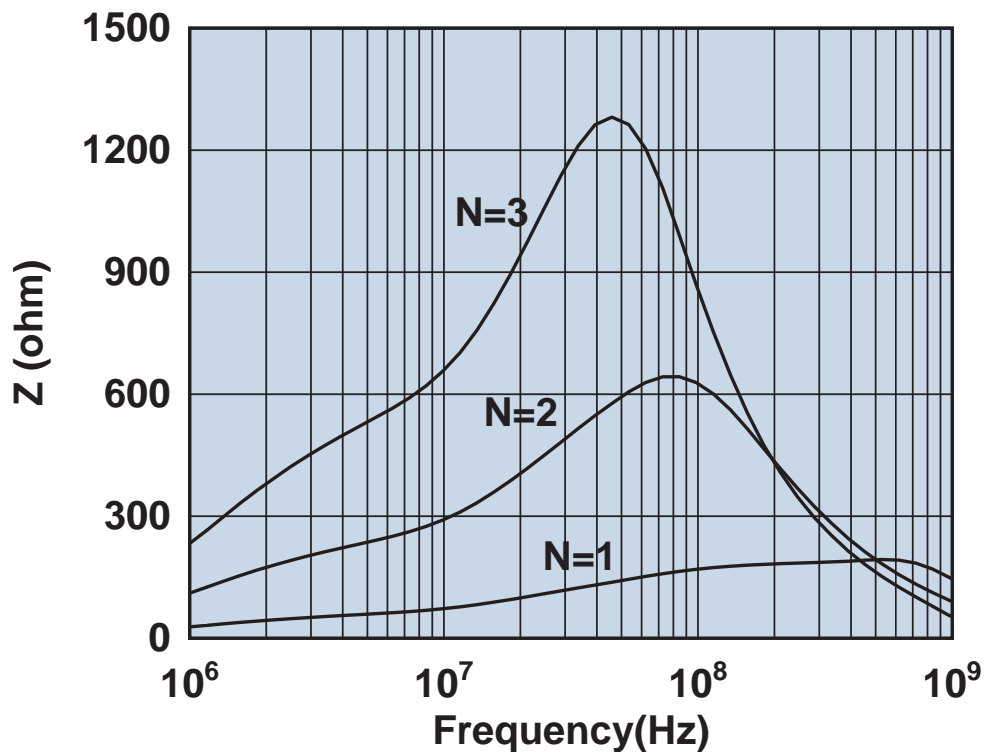

Impedance vs. frequency with one, two, and three turns.



2631101902

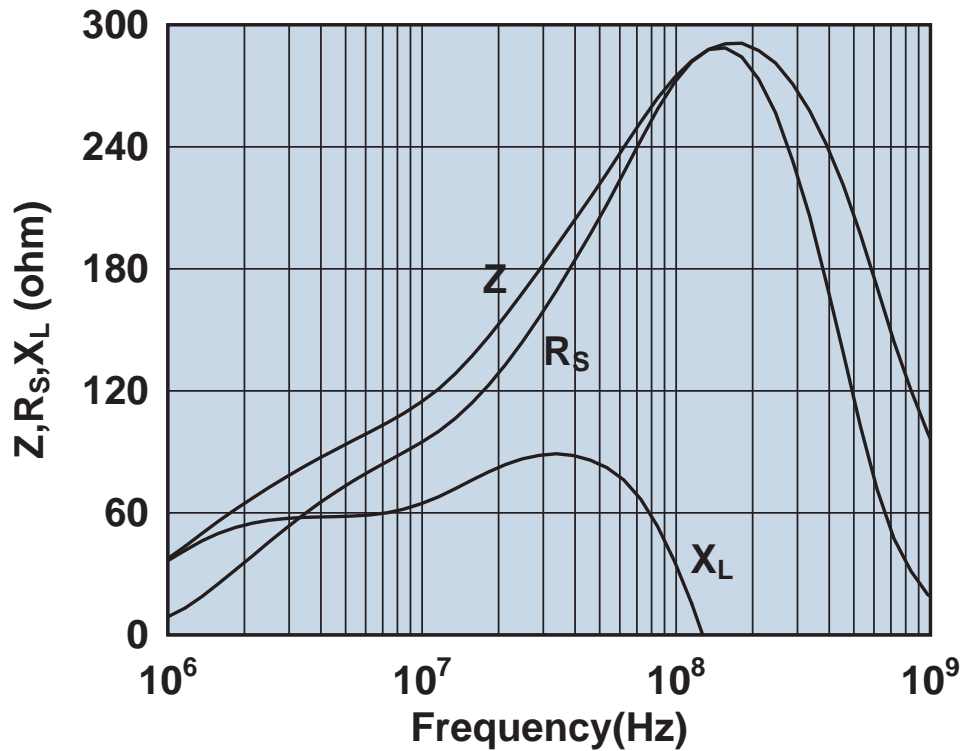

Impedance, reactance, and resistance vs. frequency.

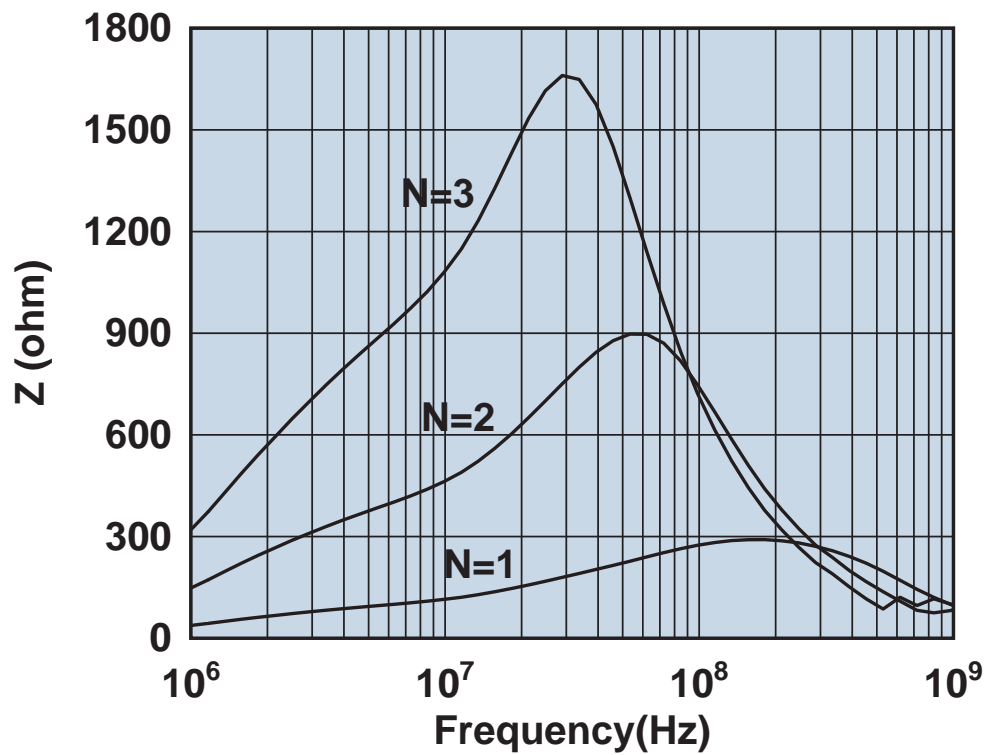

Impedance vs. frequency with one, two, and three turns.

2631102002

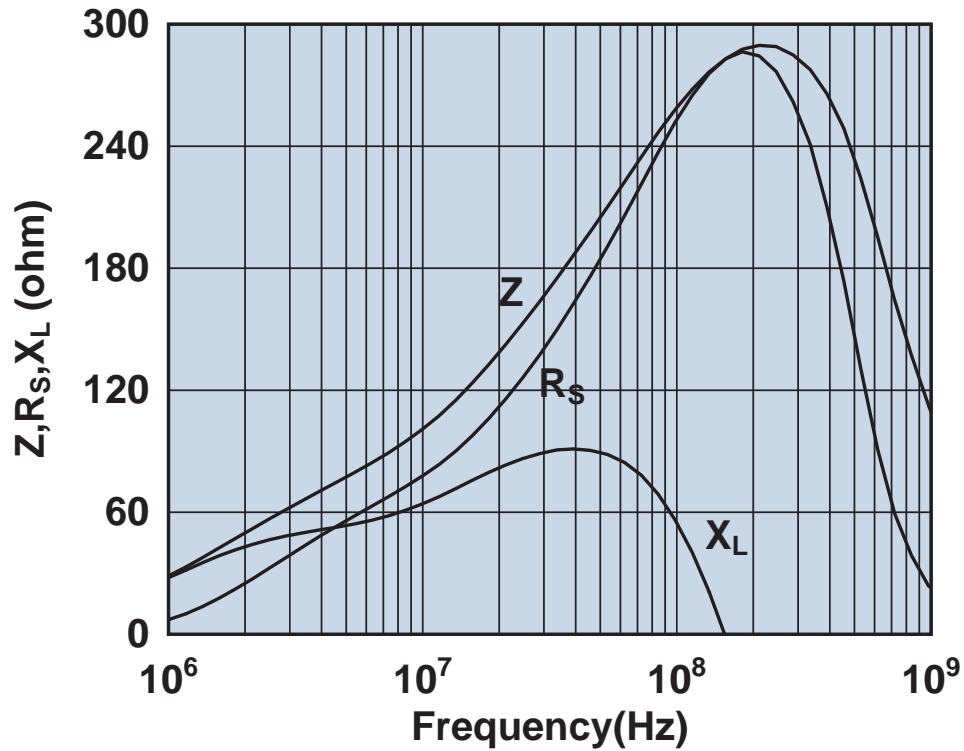

Impedance, reactance, and resistance vs. frequency.

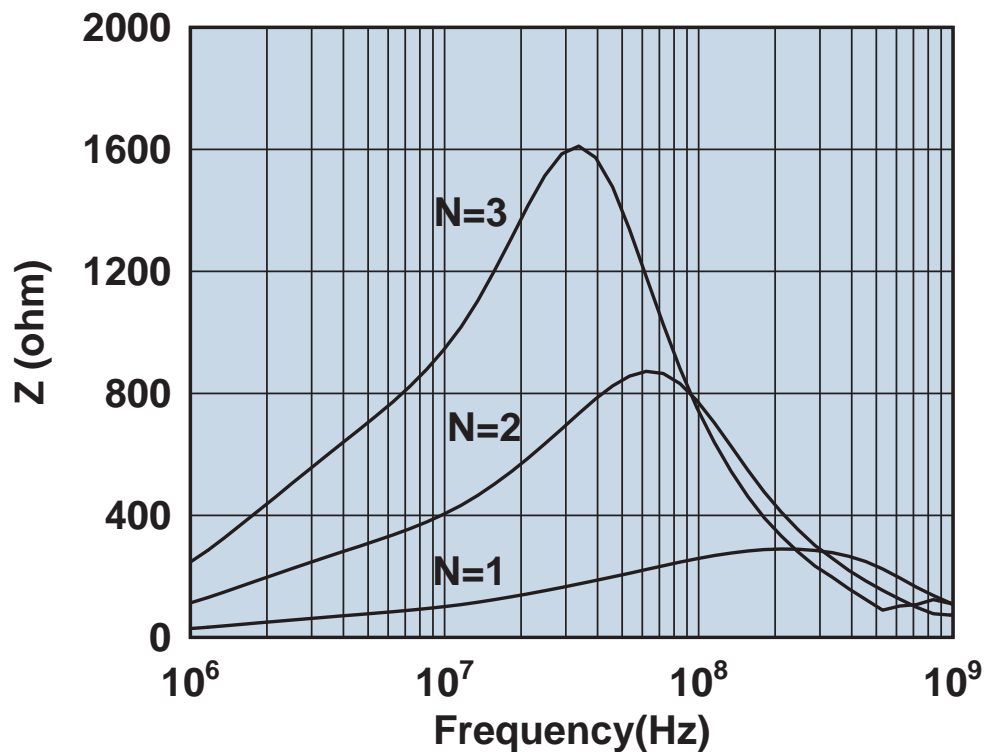

Impedance vs. frequency with one, two, and three turns.

2631103002

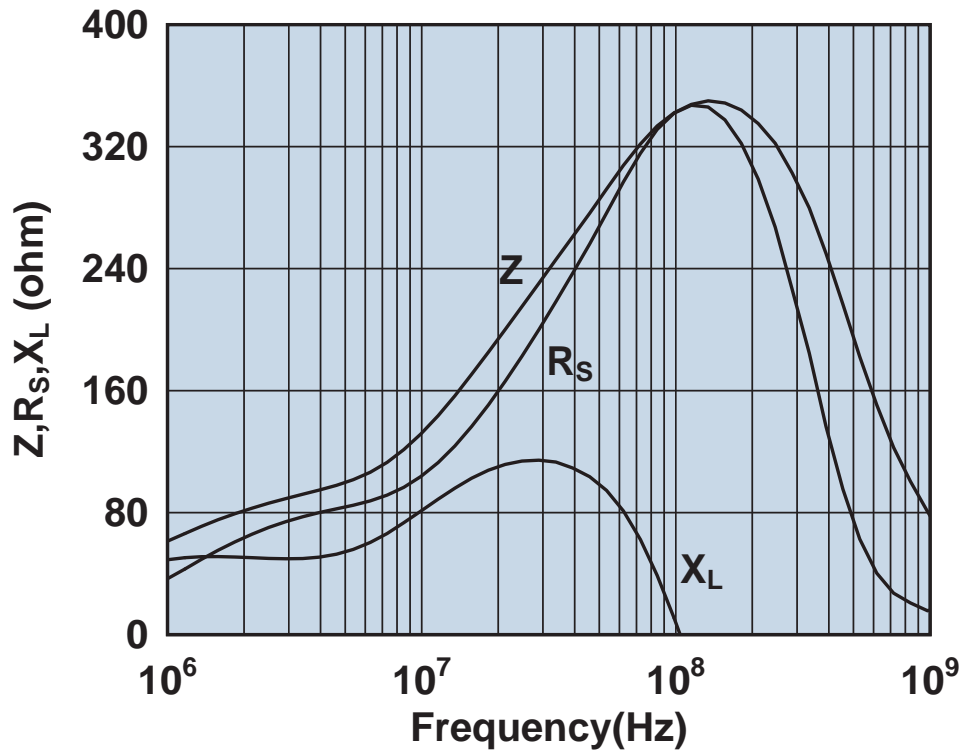

Impedance, reactance, and resistance vs. frequency.

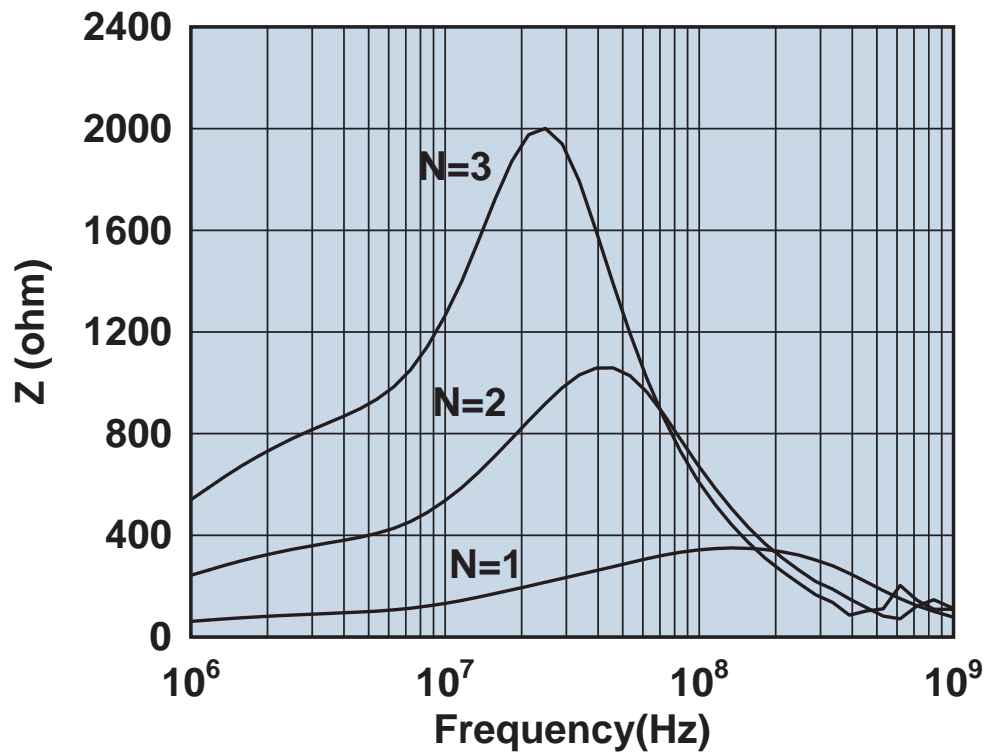

Impedance vs. frequency with one, two, and three turns.

2631163851

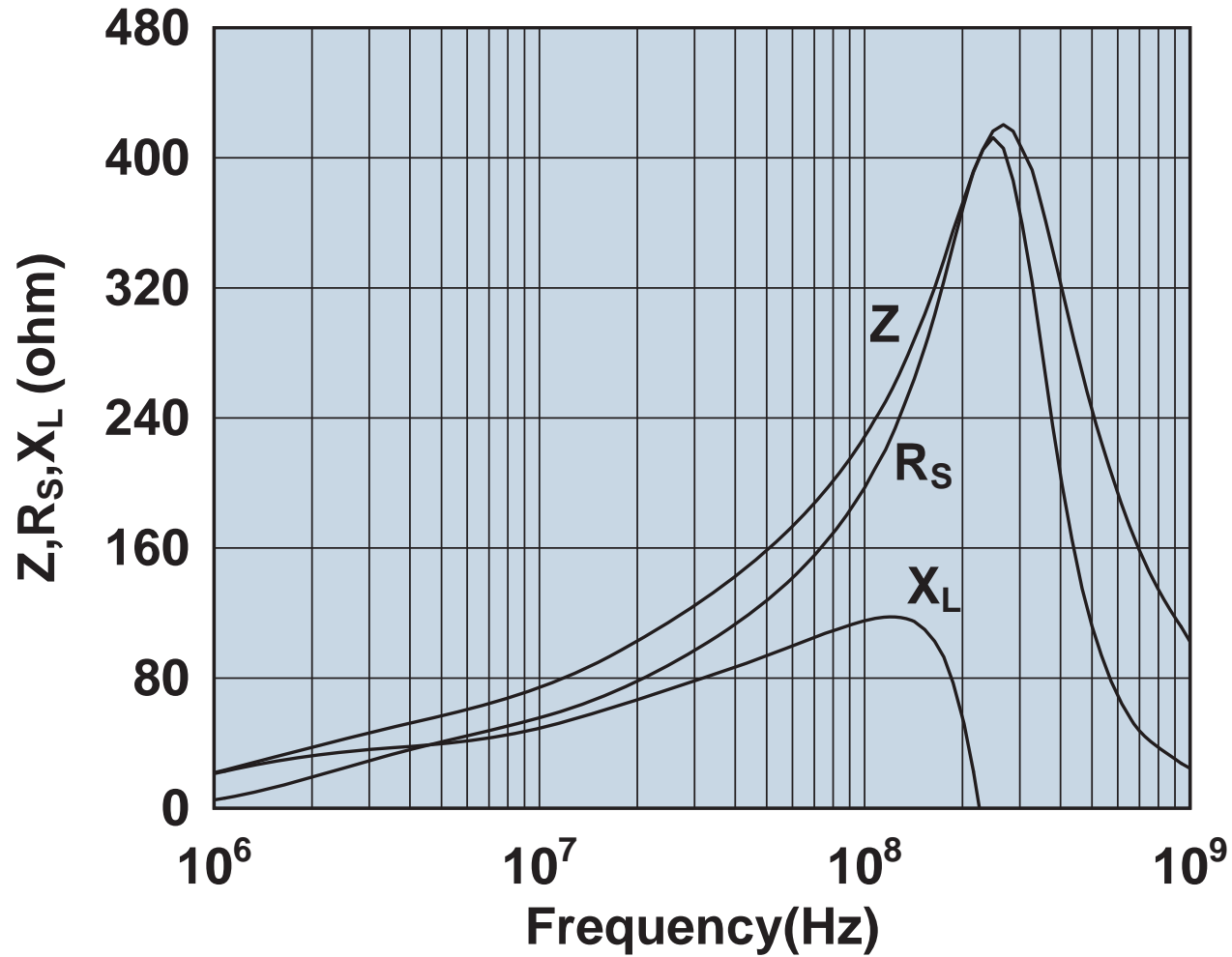

Impedance, reactance, and resistance vs. frequency.

2631163951

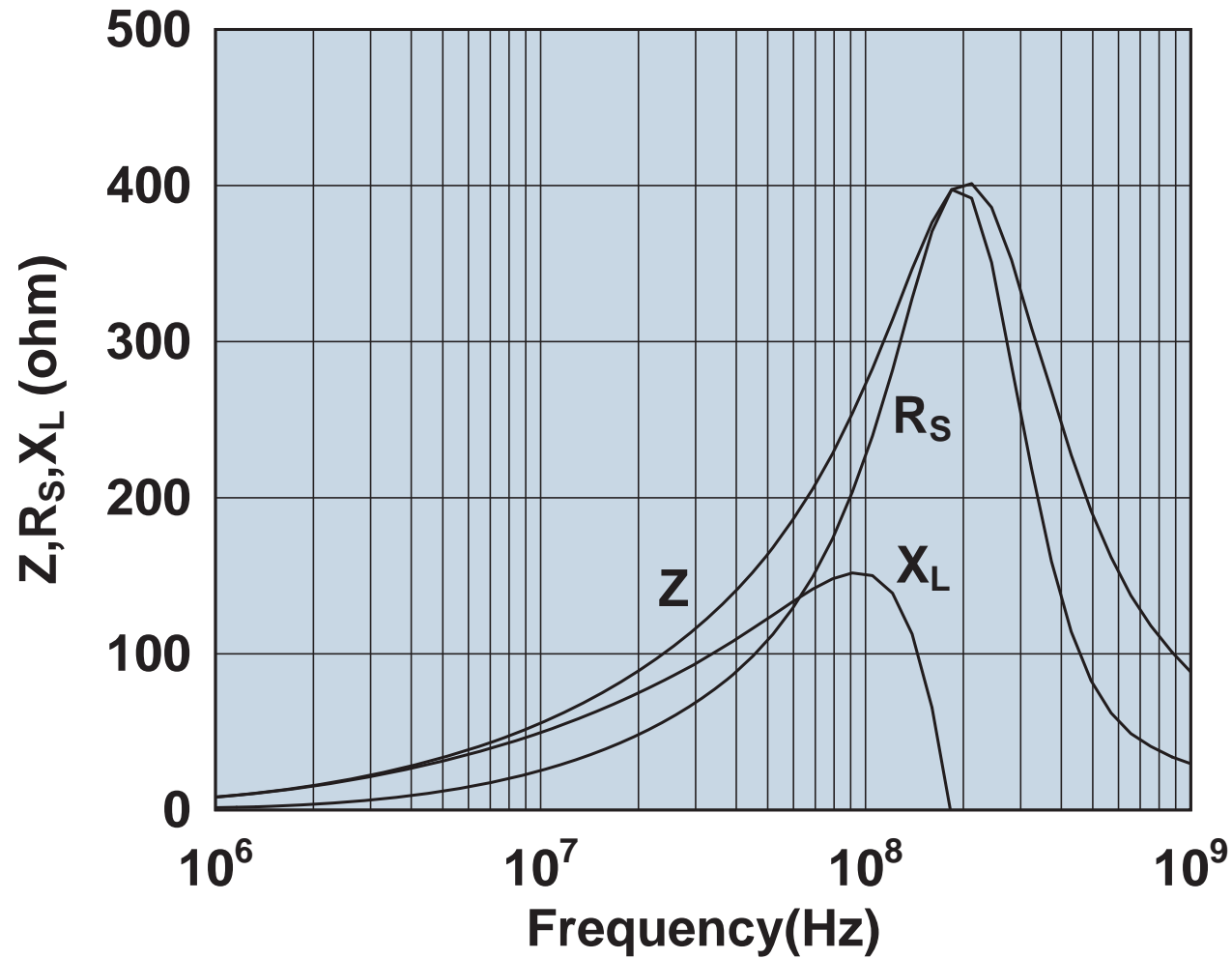

Impedance, reactance, and resistance vs. frequency.

2631164051

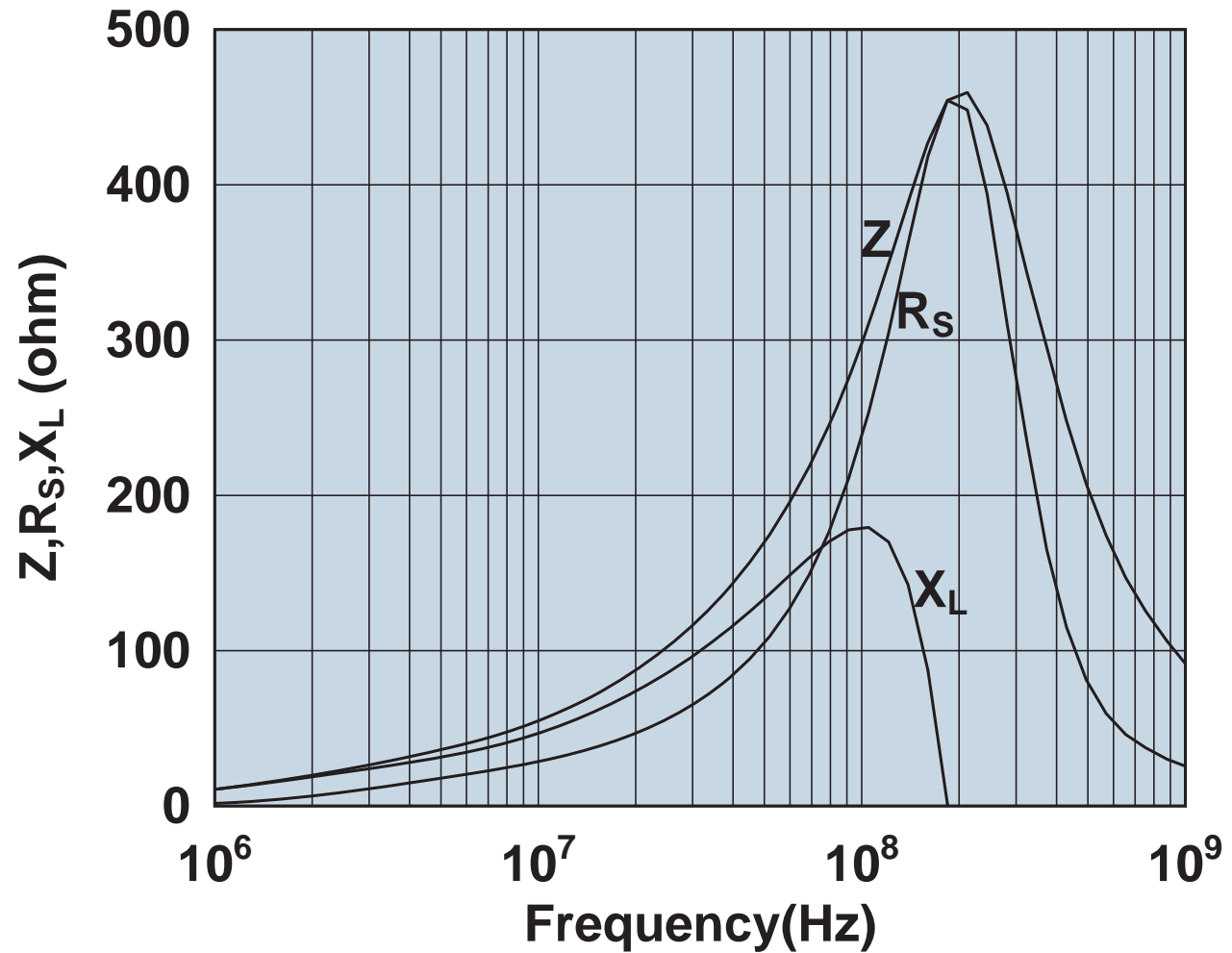

Impedance, reactance, and resistance vs. frequency.

2631164181

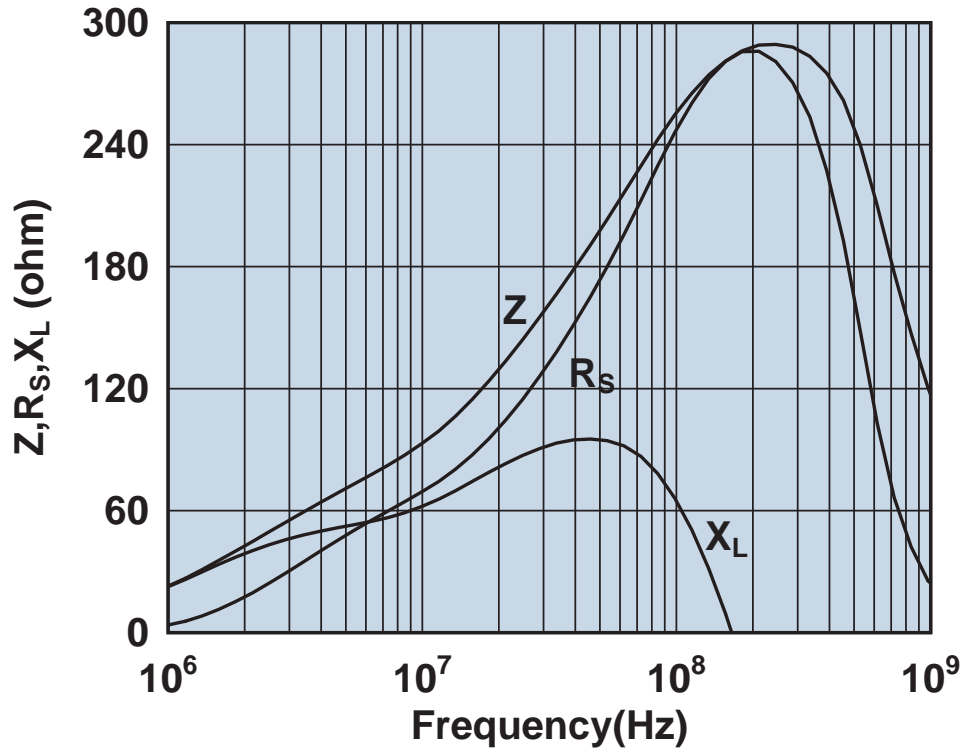

Impedance, reactance, and resistance vs. frequency.

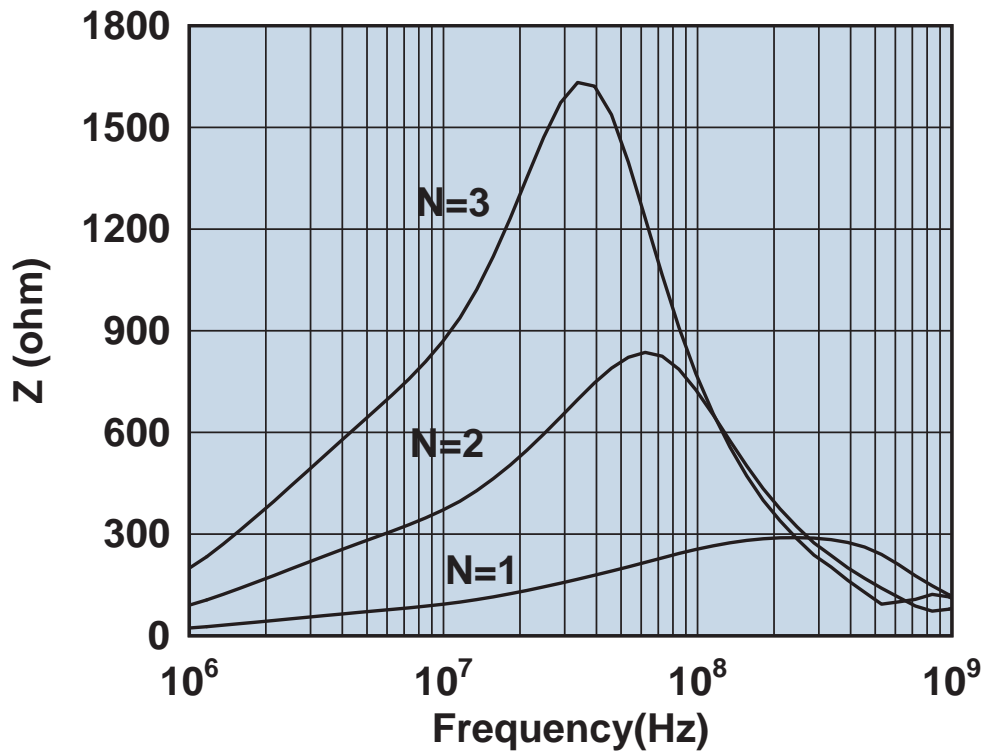

Impedance vs. frequency with one, two, and three turns.

2631164281

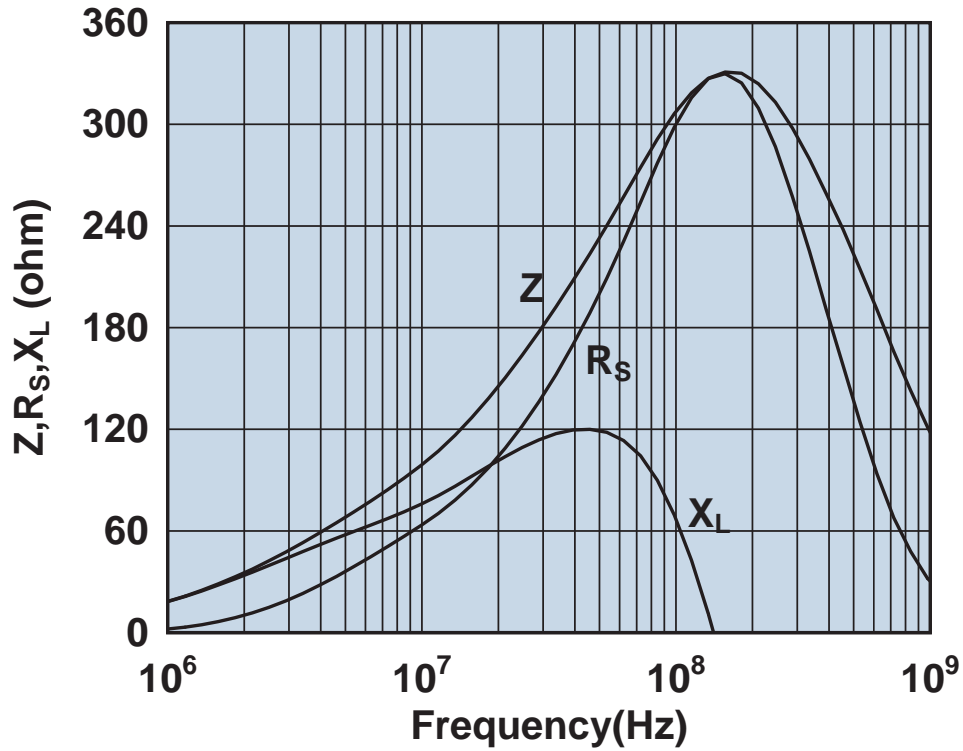

Impedance, reactance, and resistance vs. frequency.

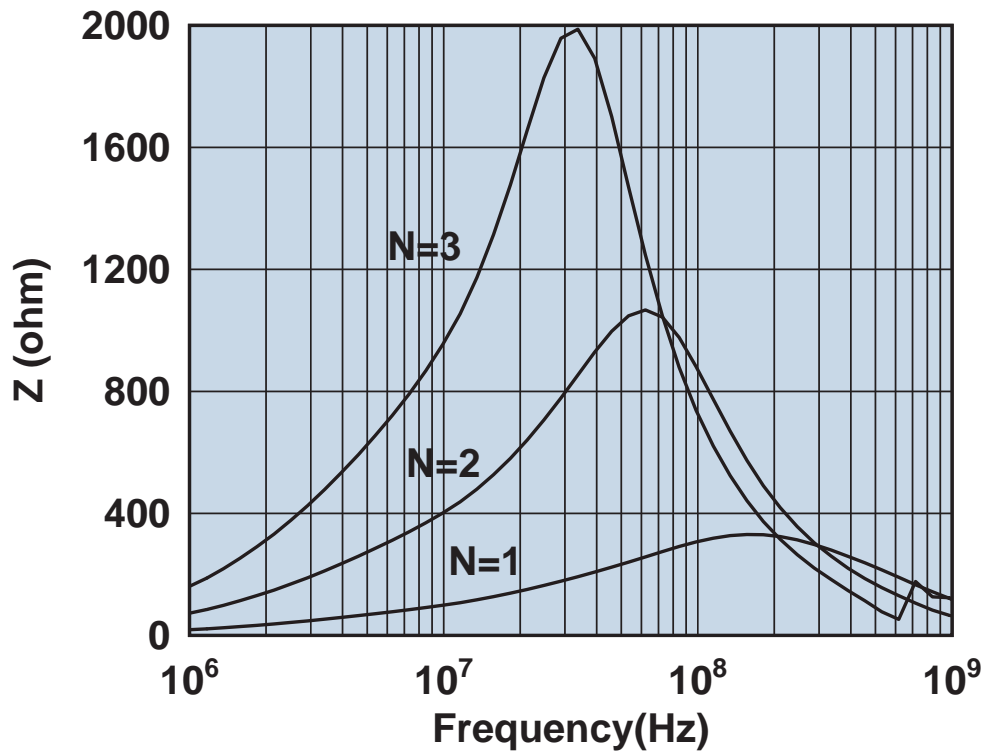

Impedance vs. frequency with one, two, and three turns.



2631164951

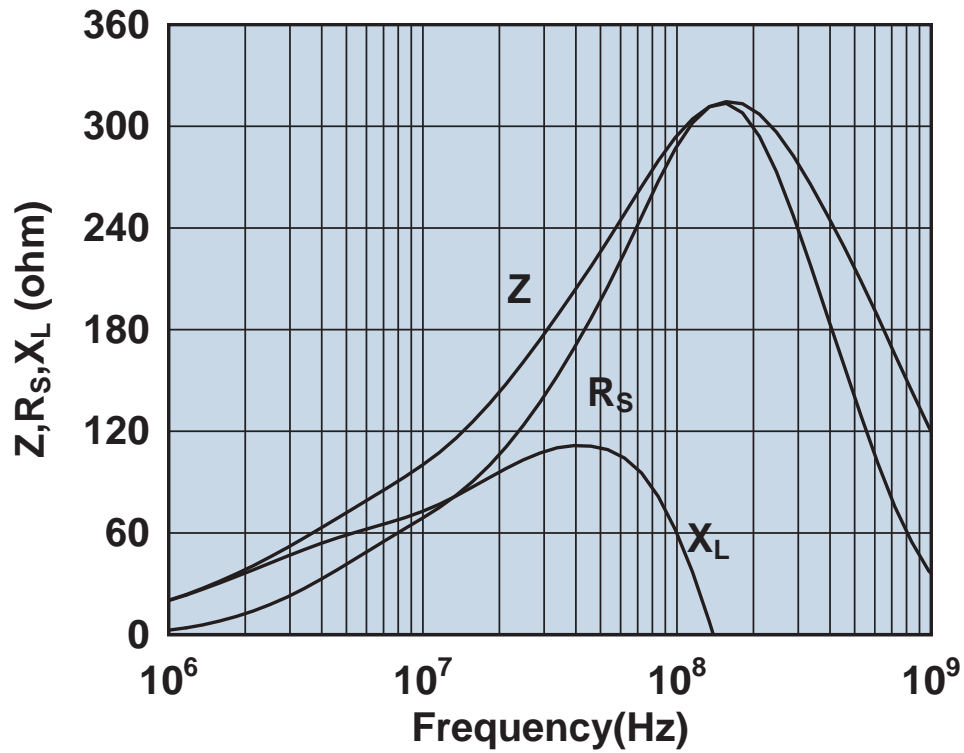

Impedance, reactance, and resistance vs. frequency.

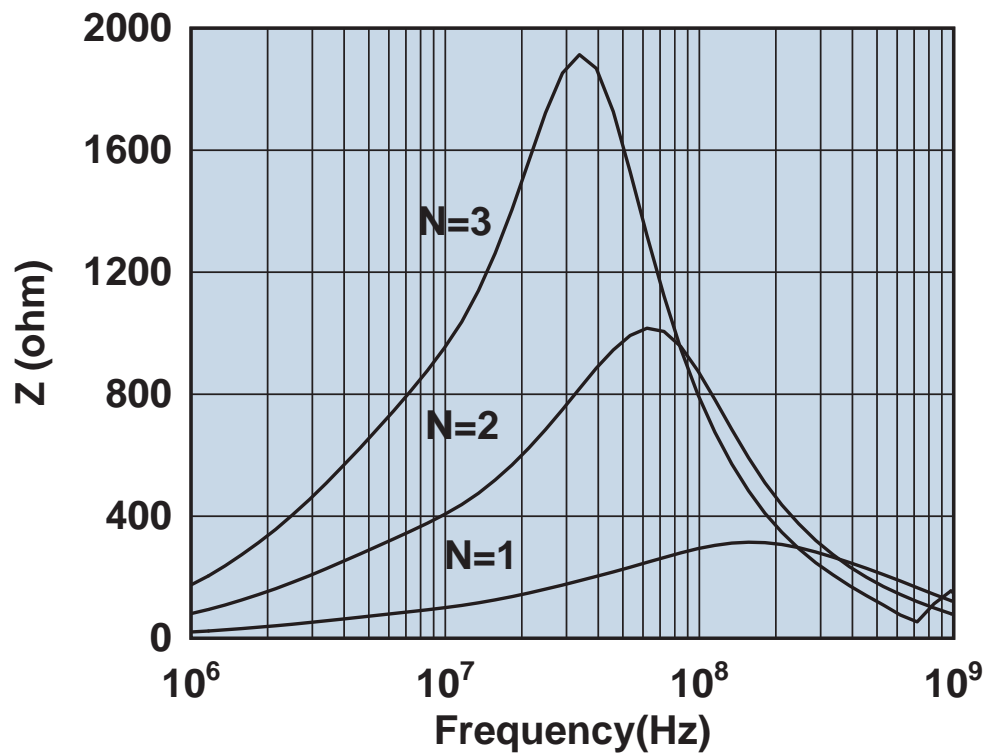

Impedance vs. frequency with one, two, and three turns.

2631167281

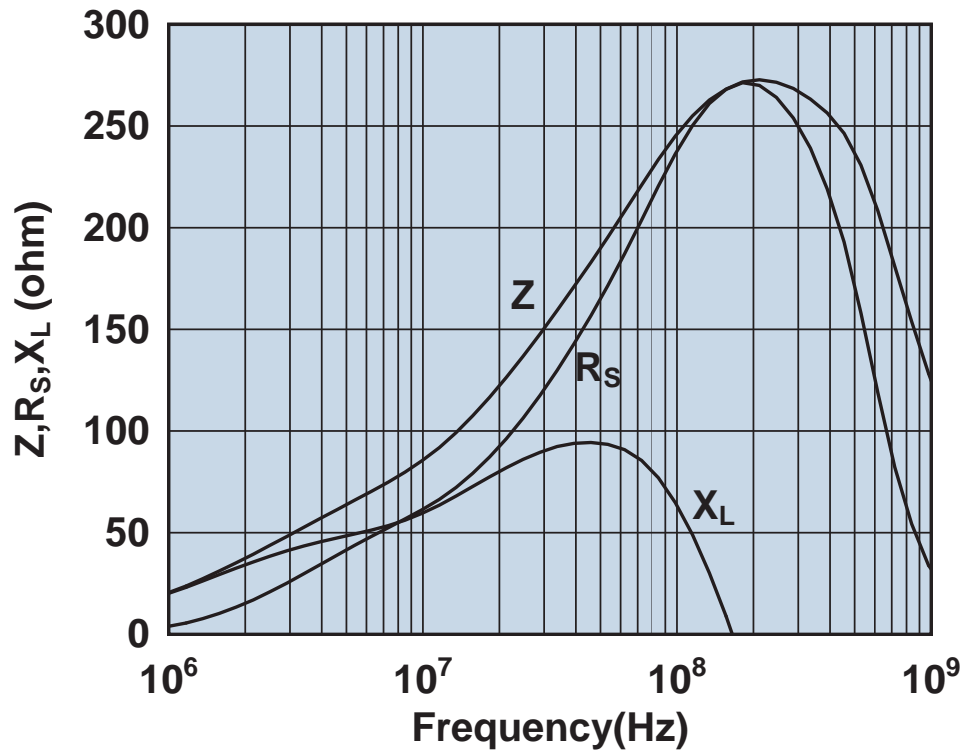

Impedance, reactance, and resistance vs. frequency.

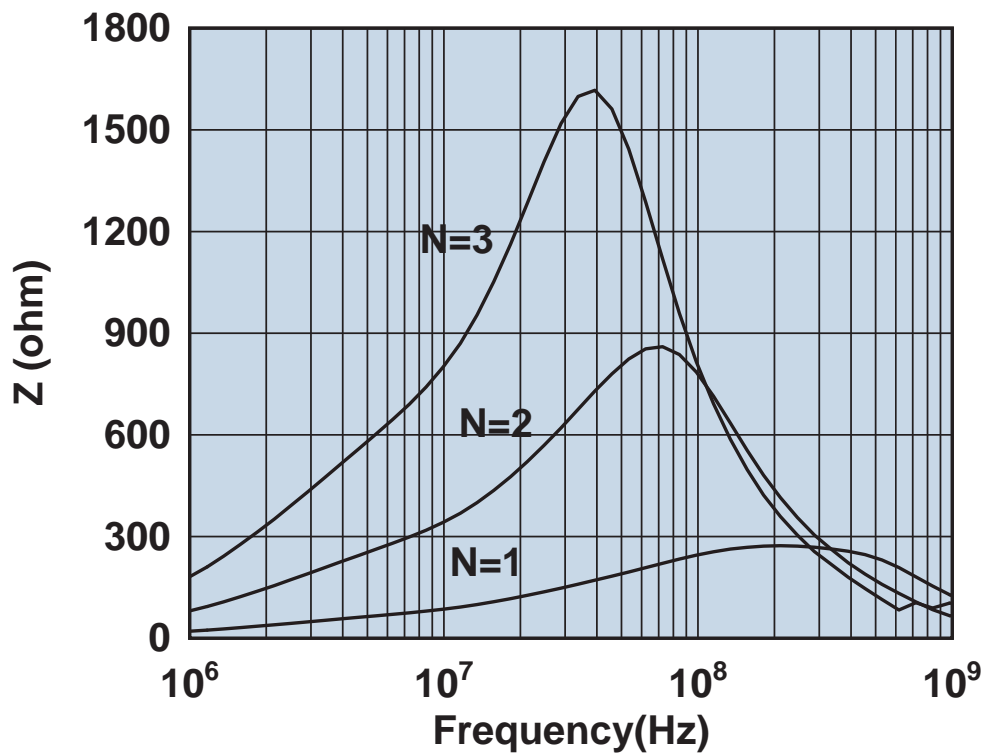

Impedance vs. frequency with one, two, and three turns.

2631173551

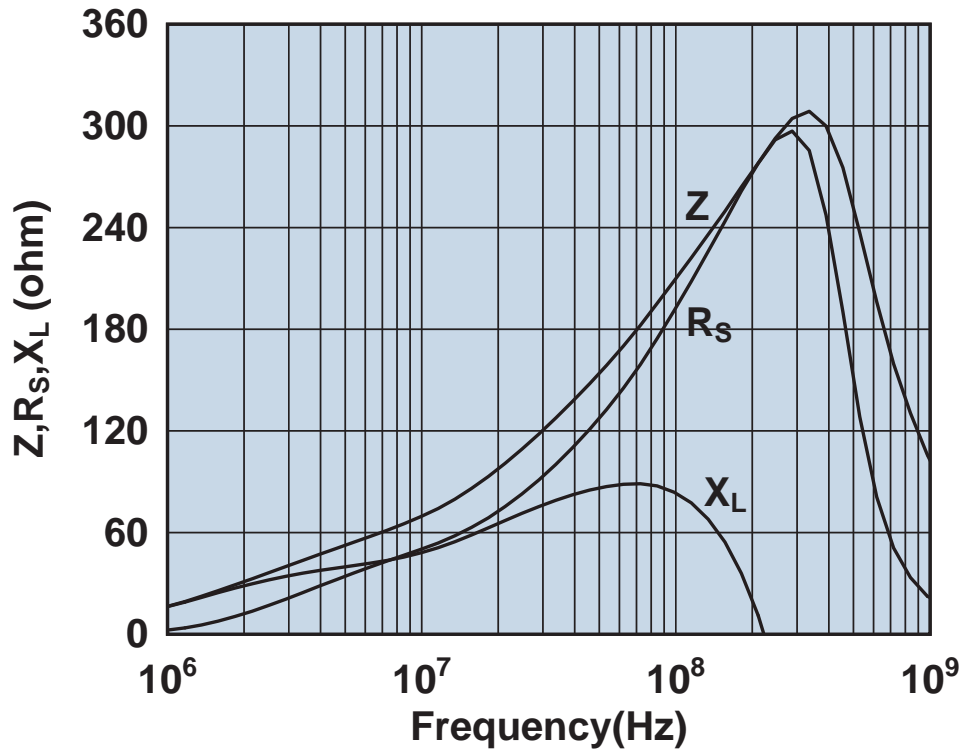

Impedance, reactance, and resistance vs. frequency.

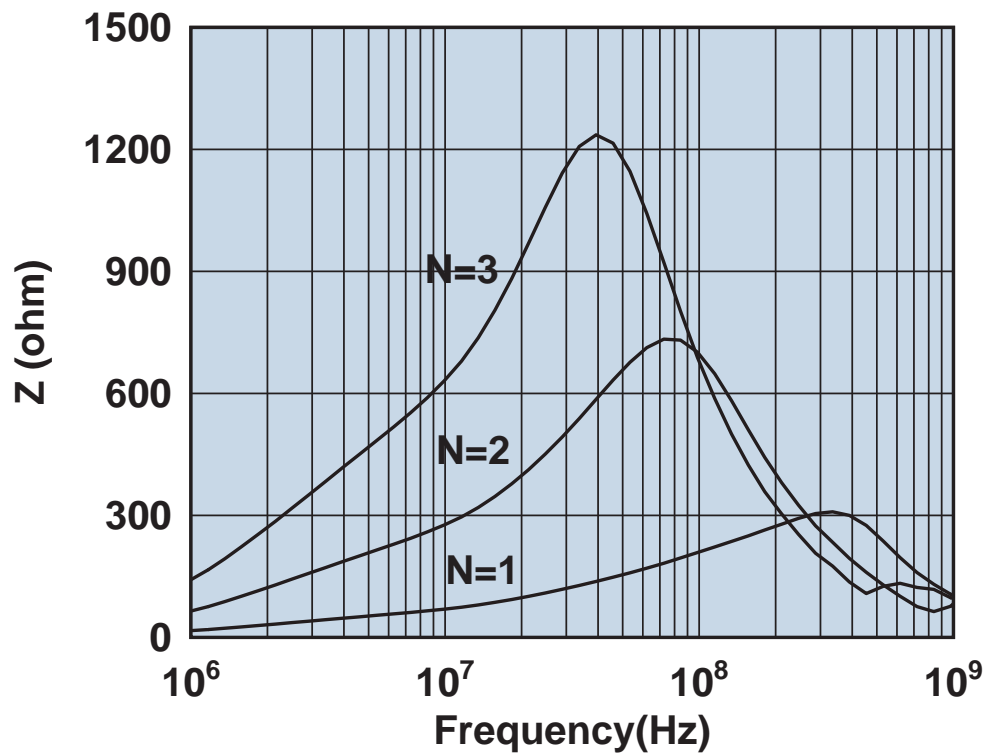

Impedance vs. frequency with one, two, and three turns.

2631173951

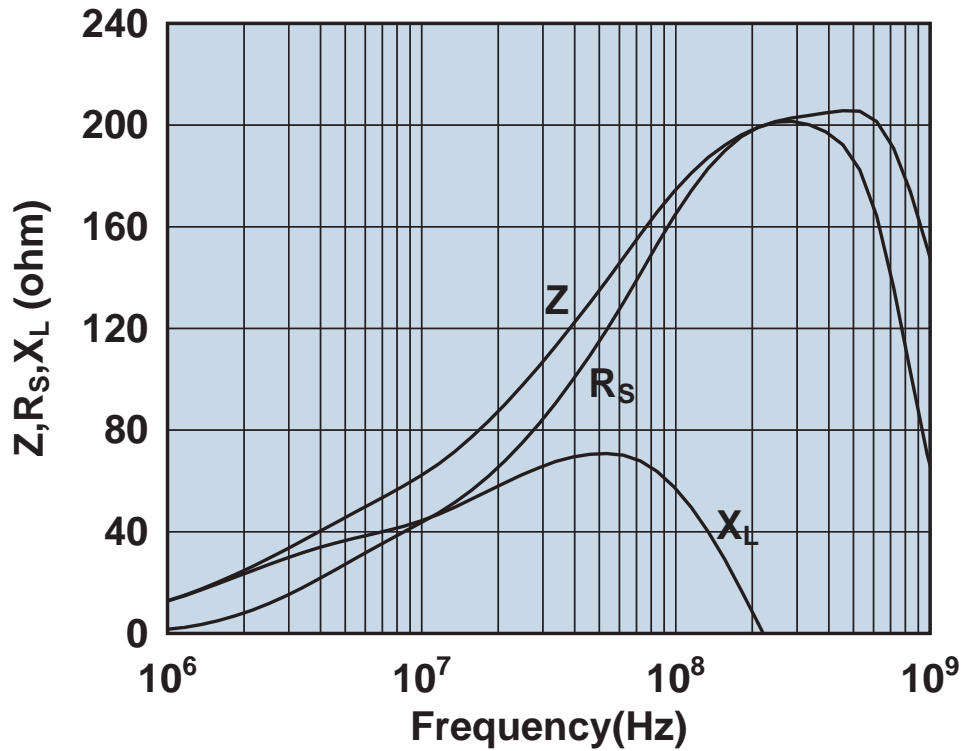

Impedance, reactance, and resistance vs. frequency.

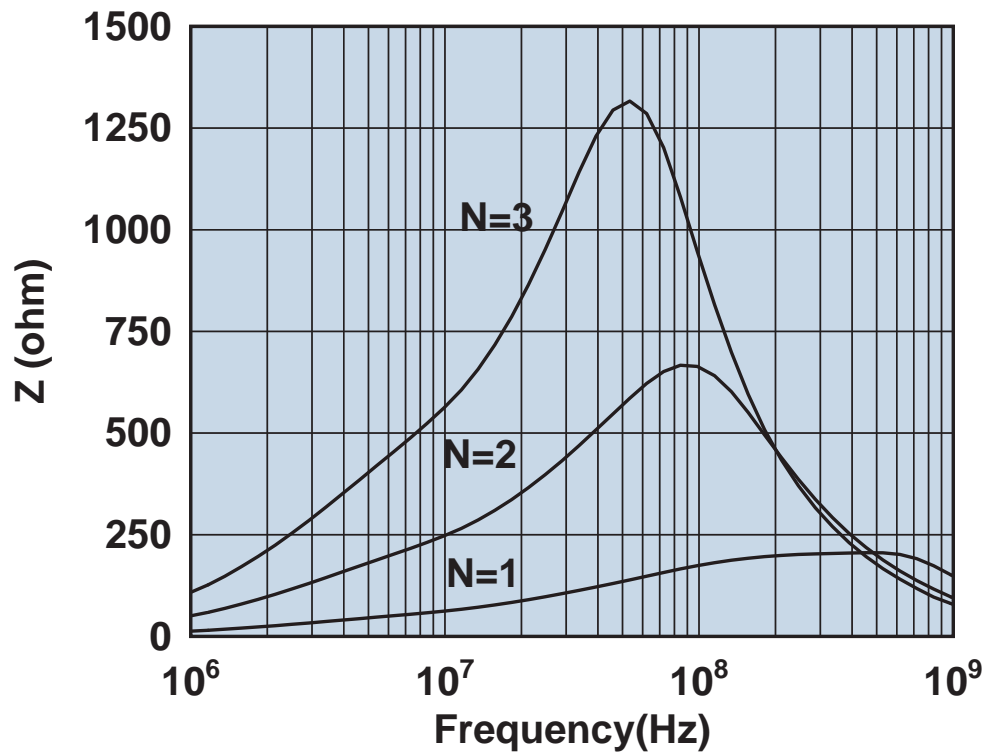

Impedance vs. frequency with one, two, and three turns.

2631176451

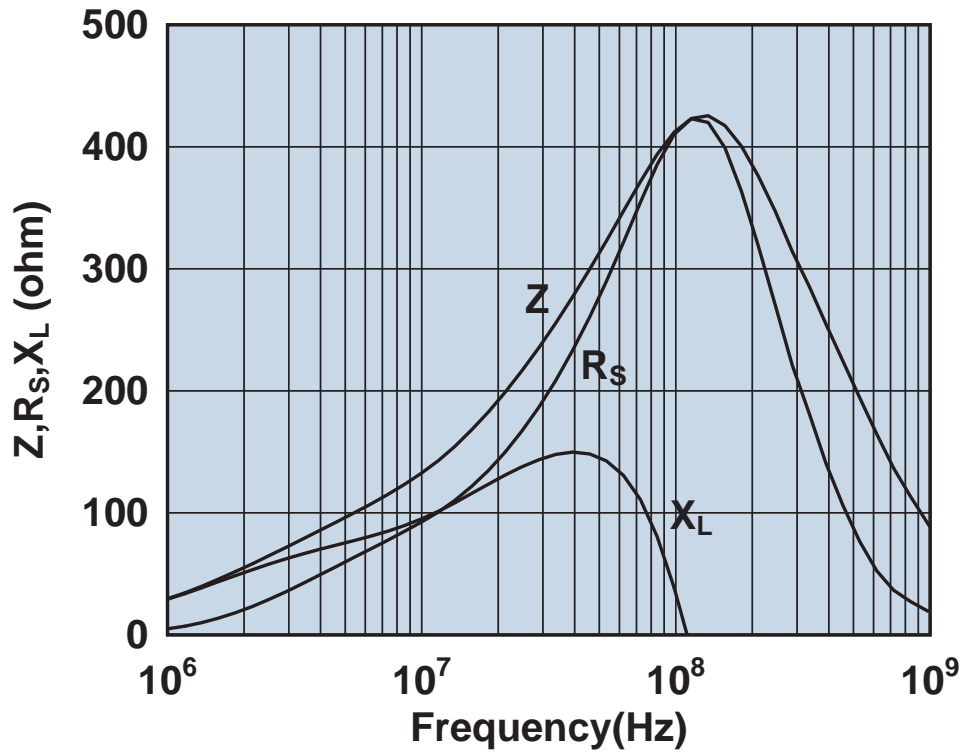

Impedance, reactance, and resistance vs. frequency.

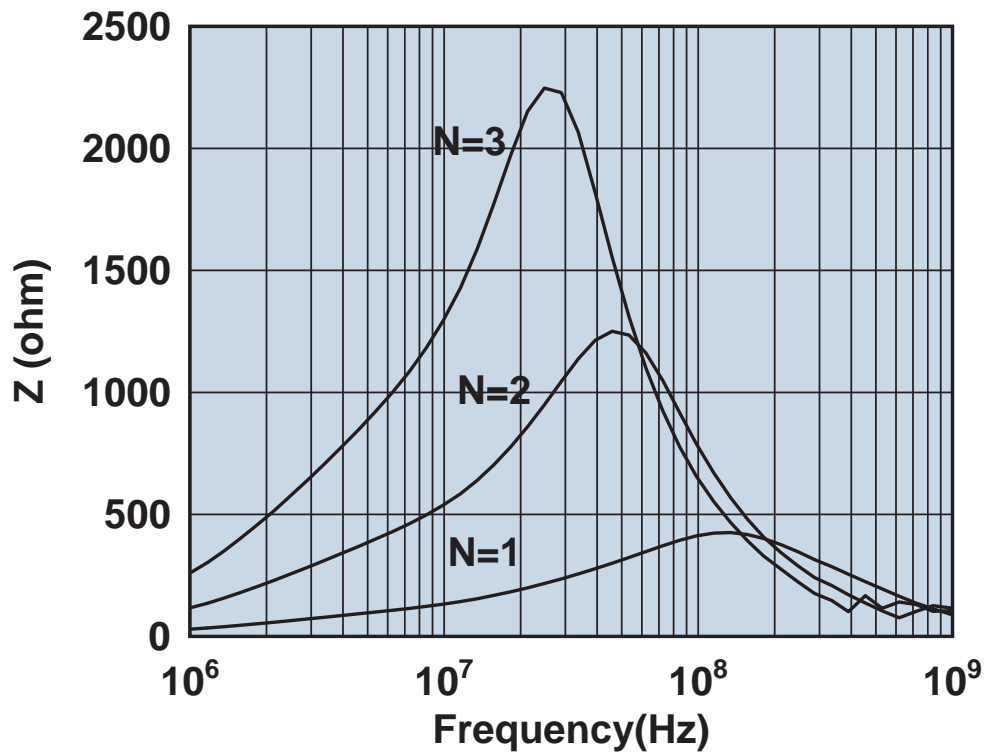

Impedance vs. frequency with one, two, and three turns.

2631177081

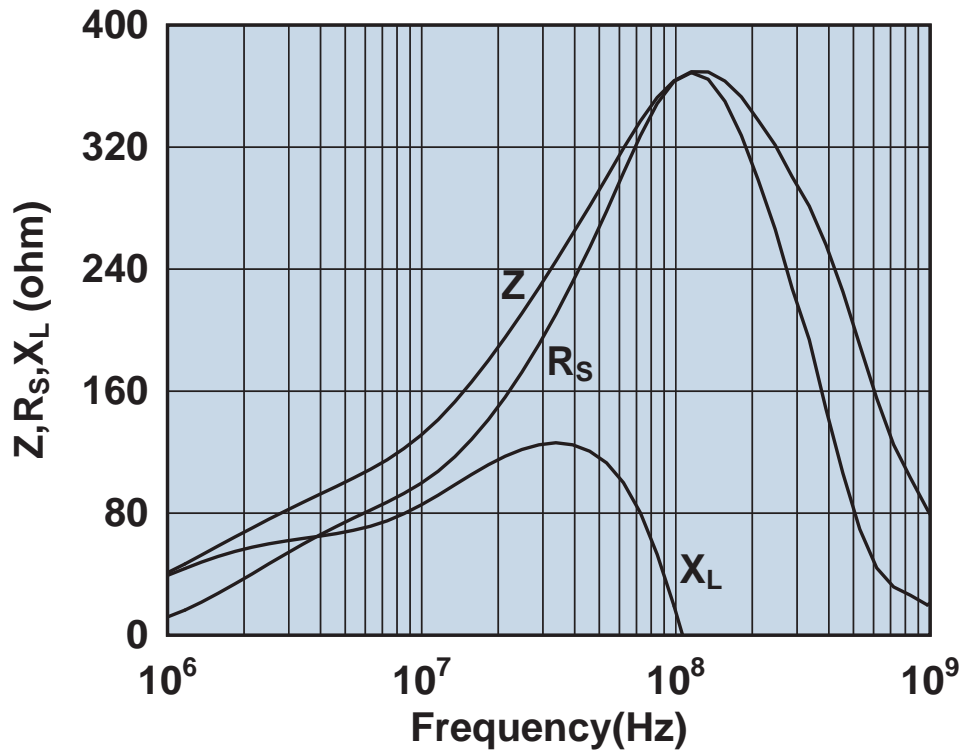

Impedance, reactance, and resistance vs. frequency.

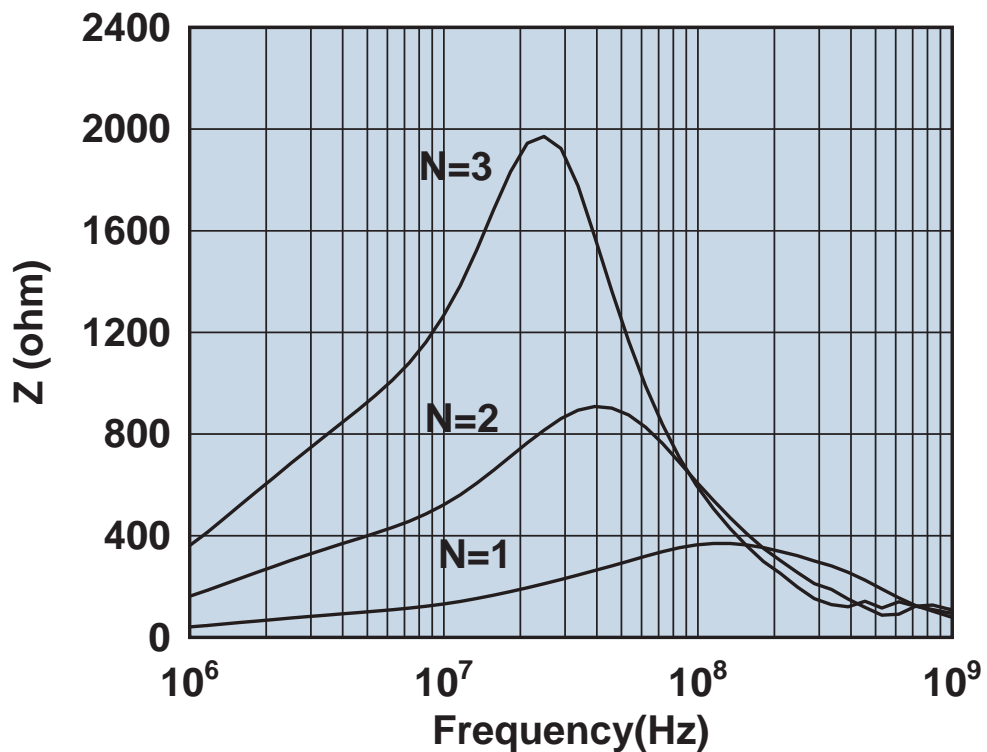

Impedance vs. frequency with one, two, and three turns.

2631178181

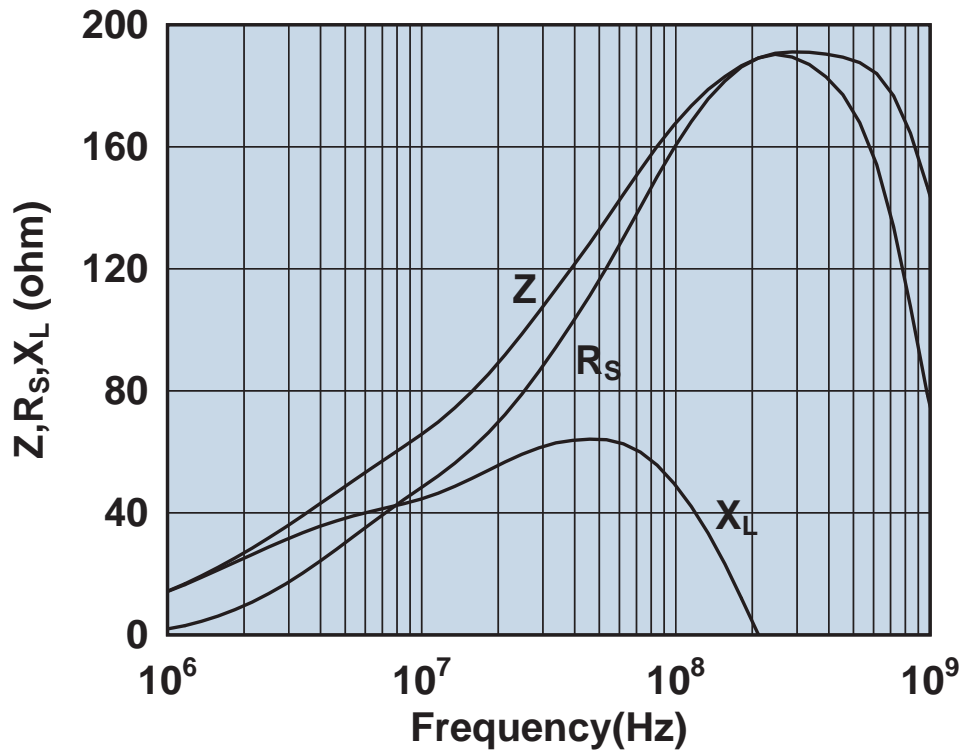

Impedance, reactance, and resistance vs. frequency.

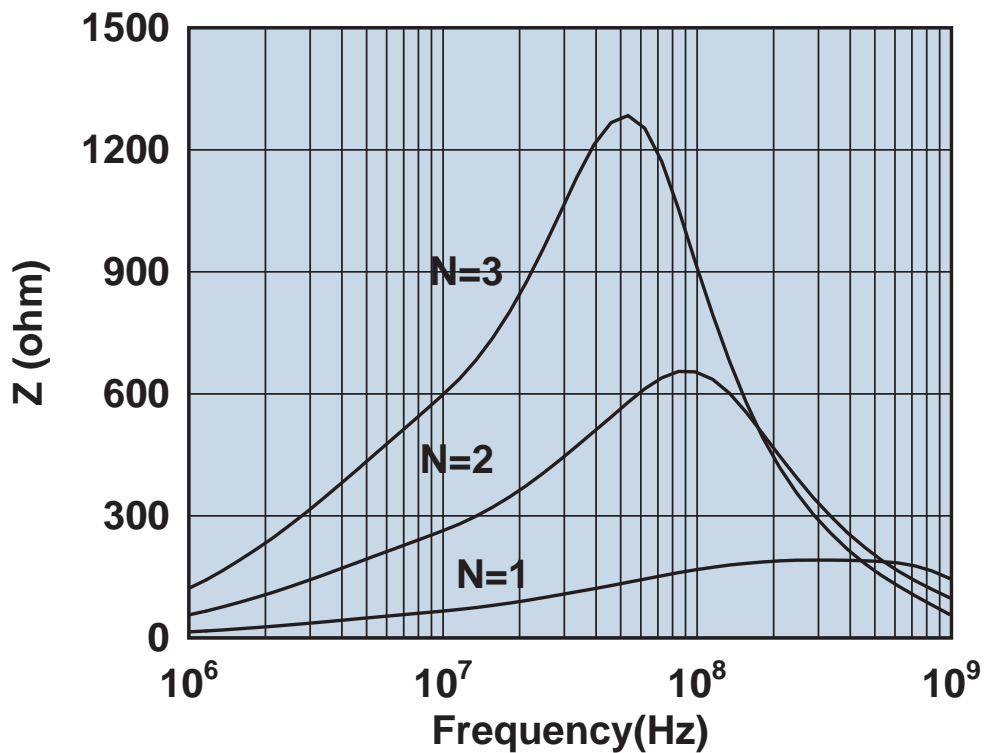

Impedance vs. frequency with one, two, and three turns.

2631178281

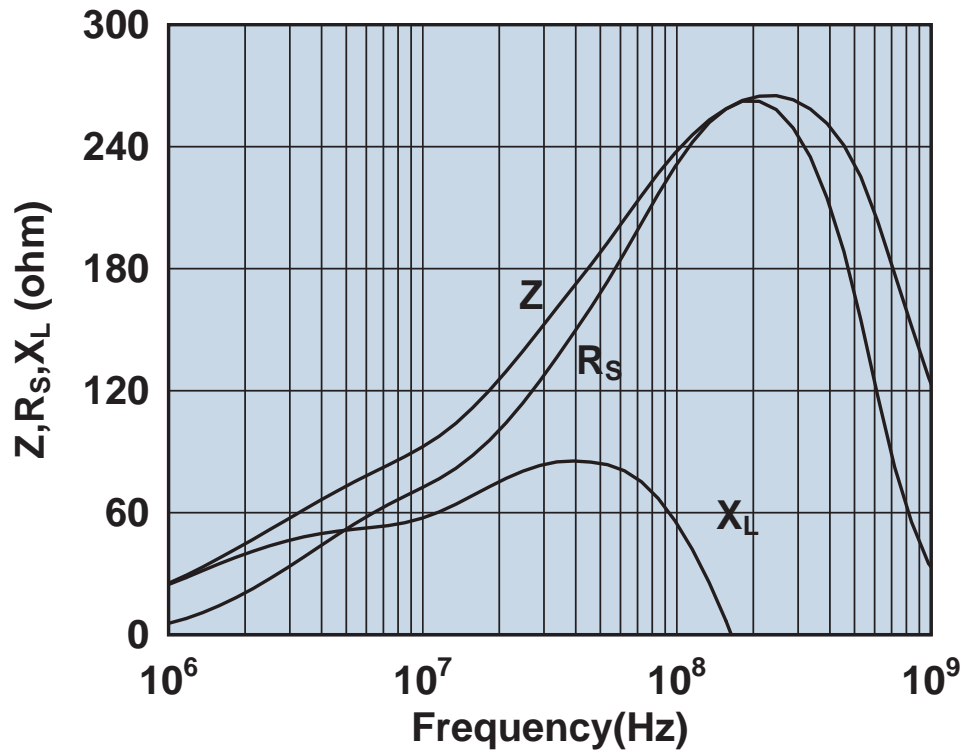

Impedance, reactance, and resistance vs. frequency.

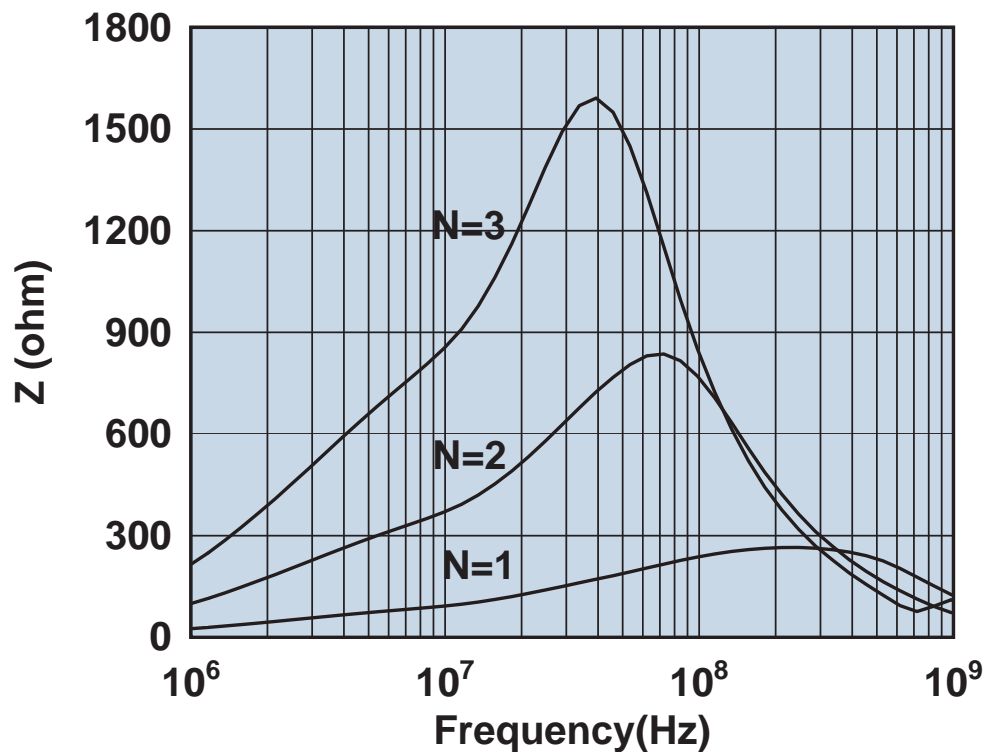

Impedance vs. frequency with one, two, and three turns.



2631250202

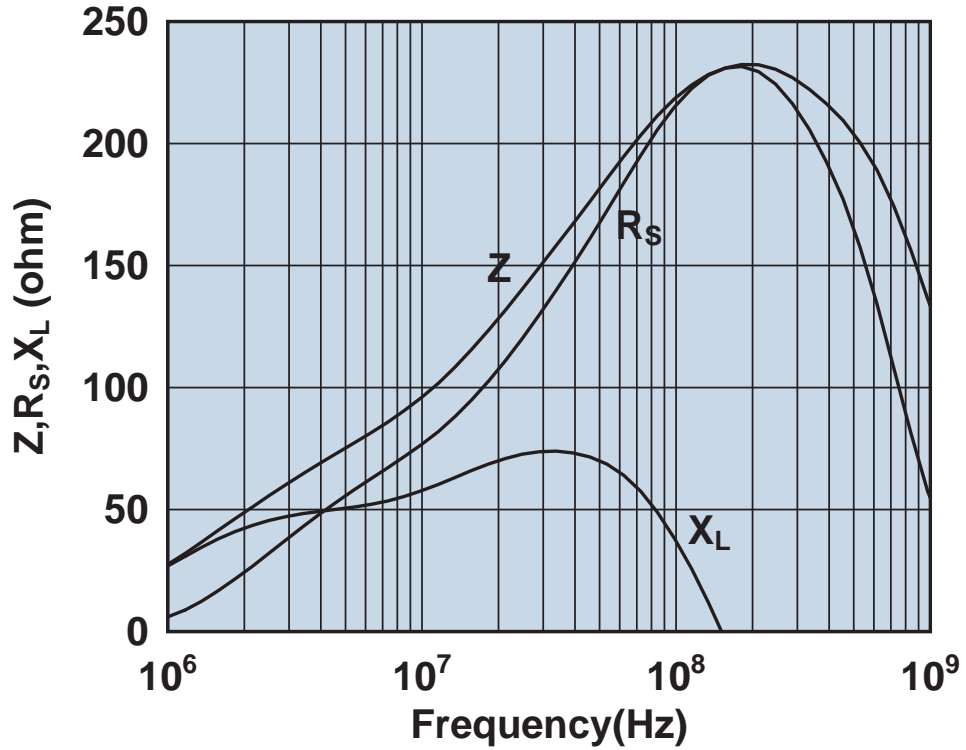

Impedance, reactance, and resistance vs. frequency.

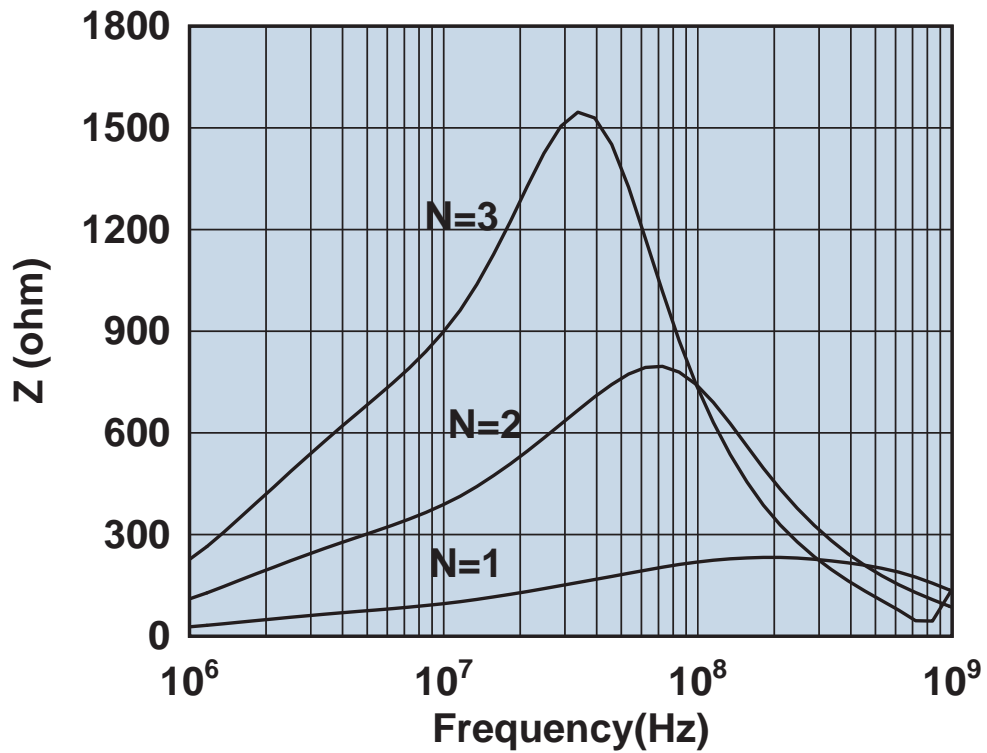

Impedance vs. frequency with one, two, and three turns.

2631480002

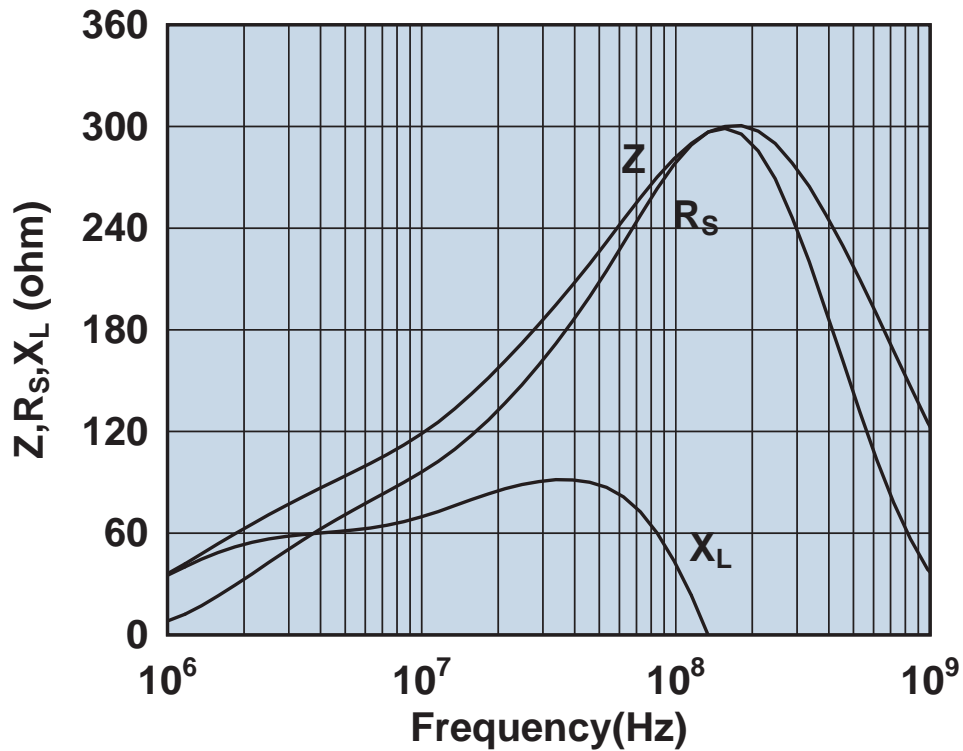

Impedance, reactance, and resistance vs. frequency.

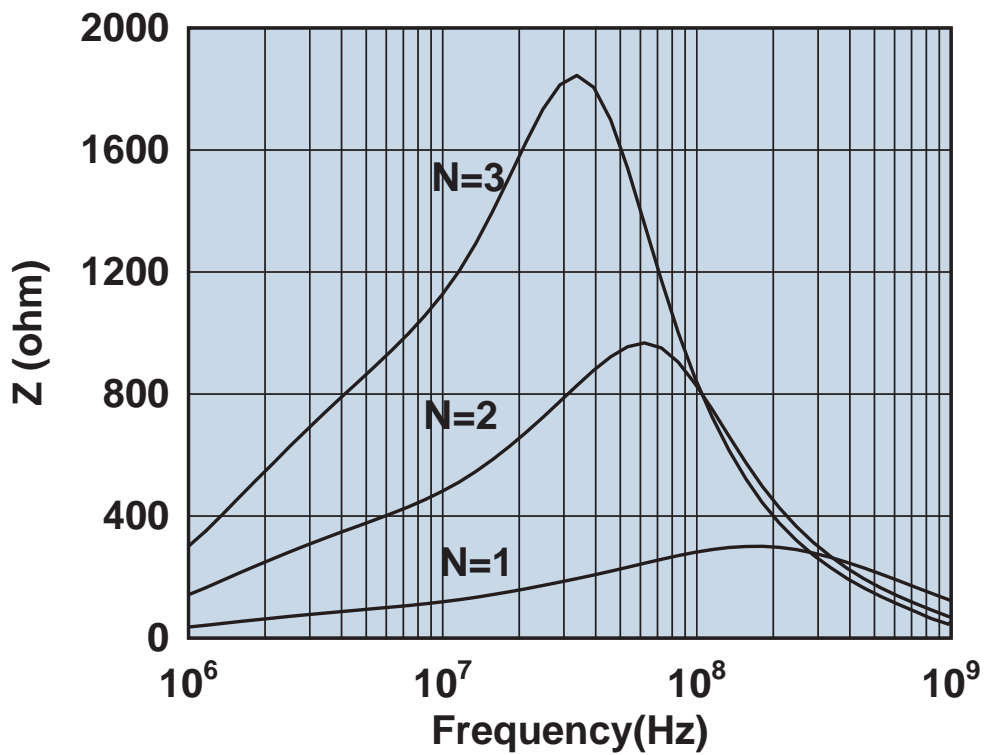

Impedance vs. frequency with one, two, and three turns.

2631480102

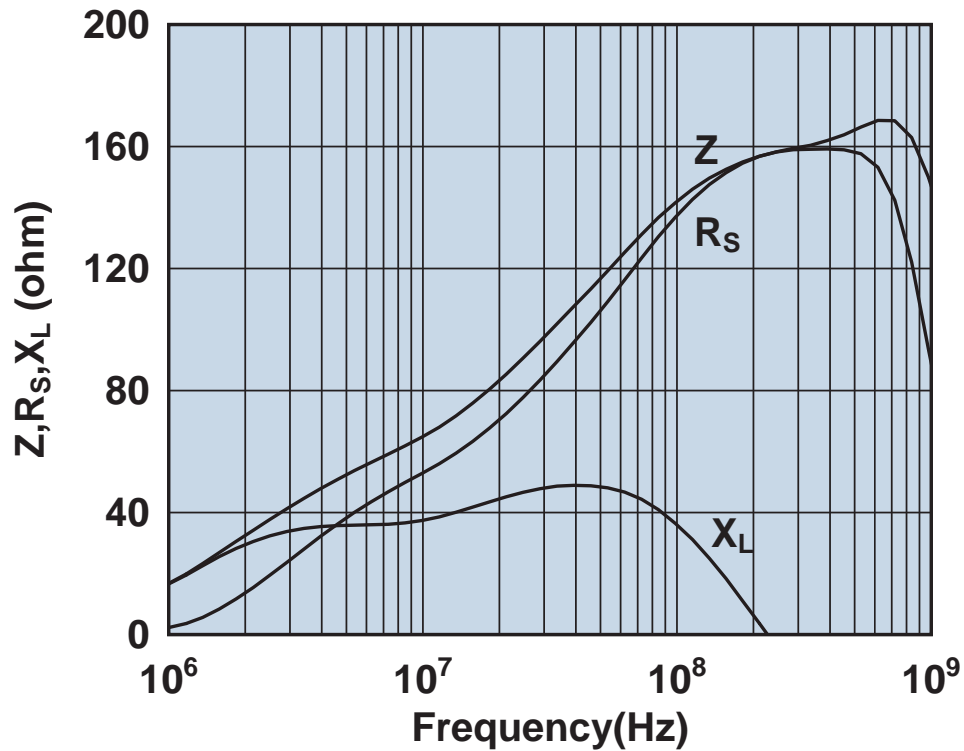

Impedance, reactance, and resistance vs. frequency.

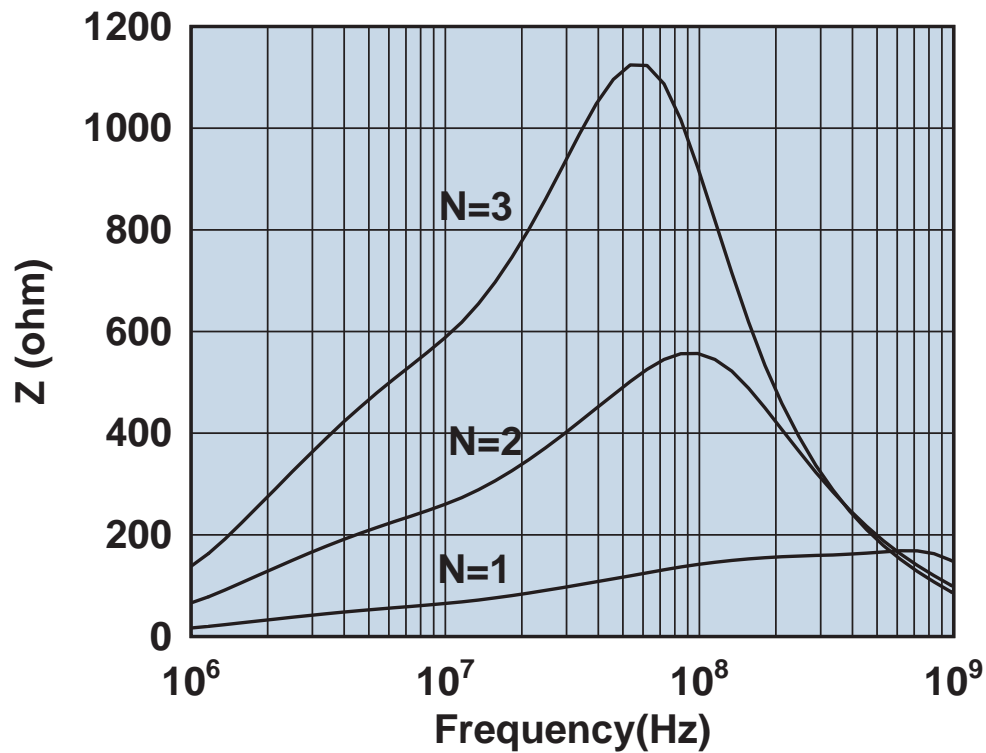

Impedance vs. frequency with one, two, and three turns.

2631540002

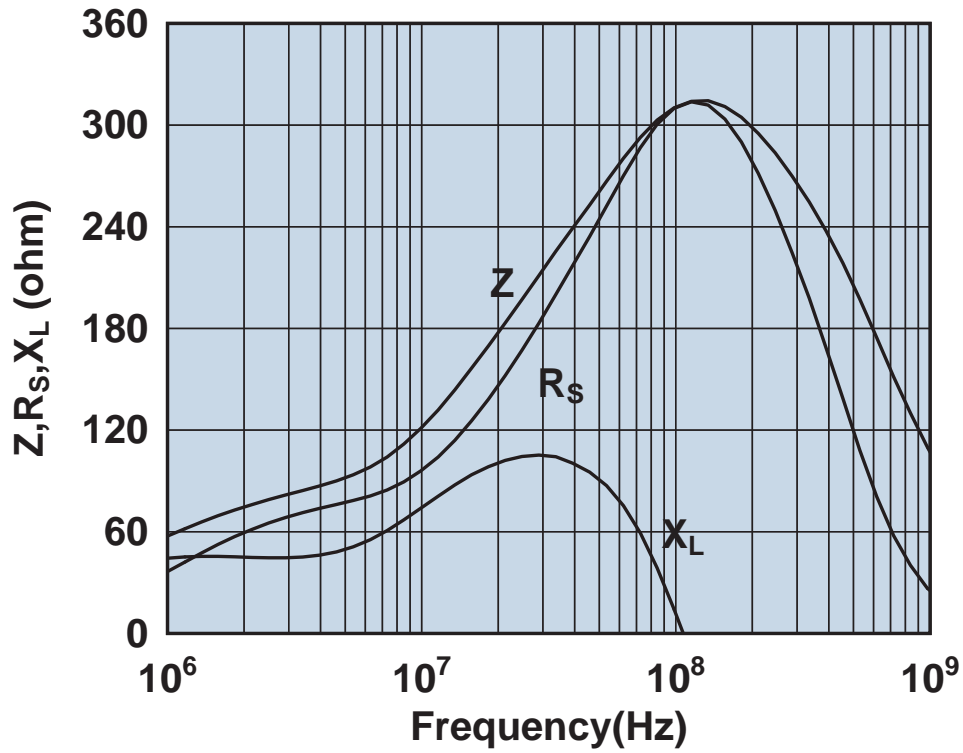

Impedance, reactance, and resistance vs. frequency.

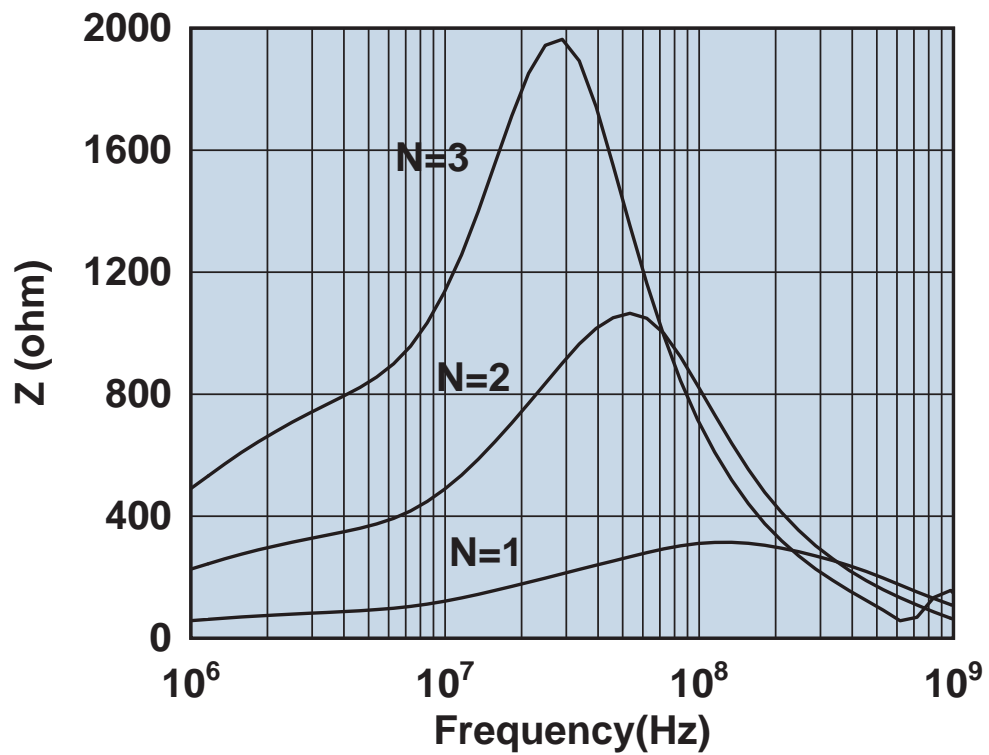

Impedance vs. frequency with one, two, and three turns.

2631540202

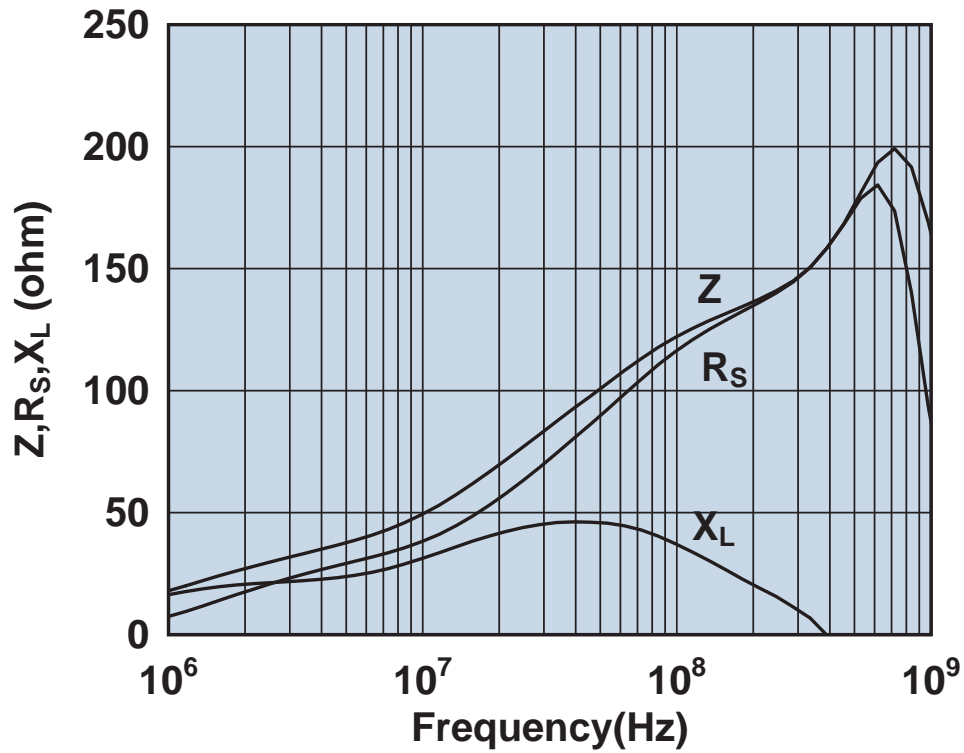

Impedance, reactance, and resistance vs. frequency.

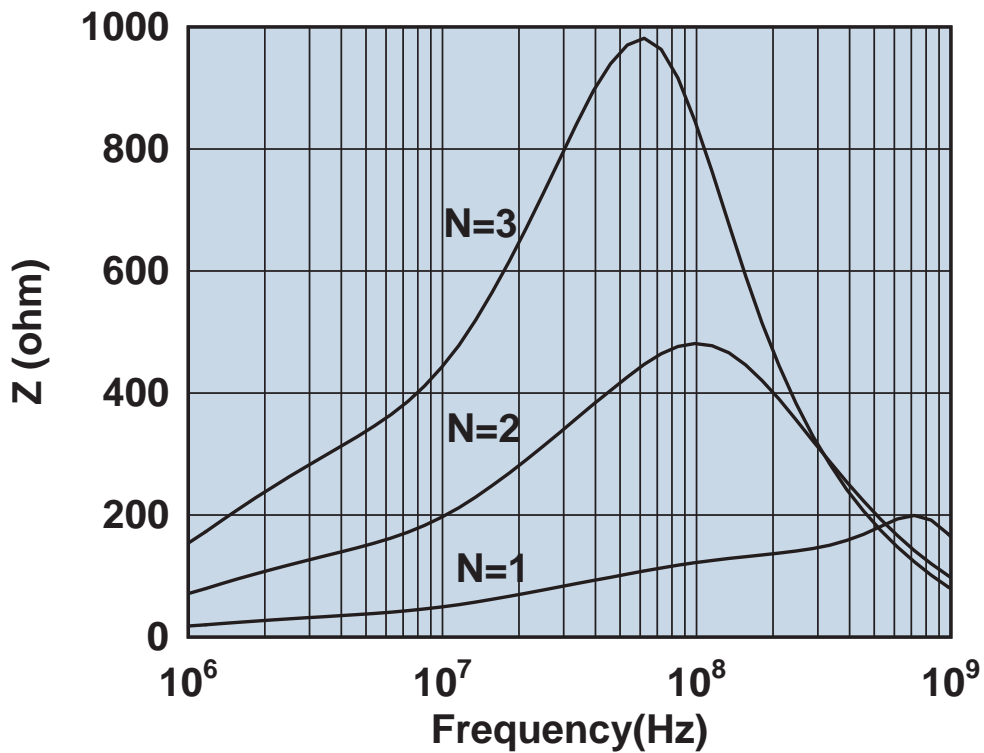

Impedance vs. frequency with one, two, and three turns.

2631625002

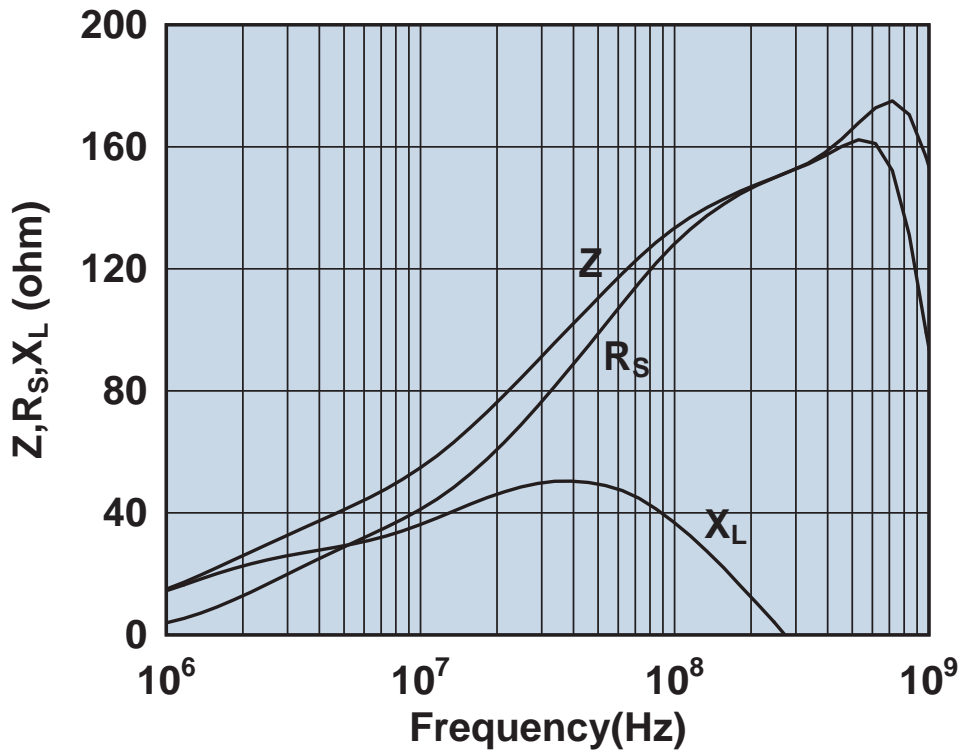

Impedance, reactance, and resistance vs. frequency.

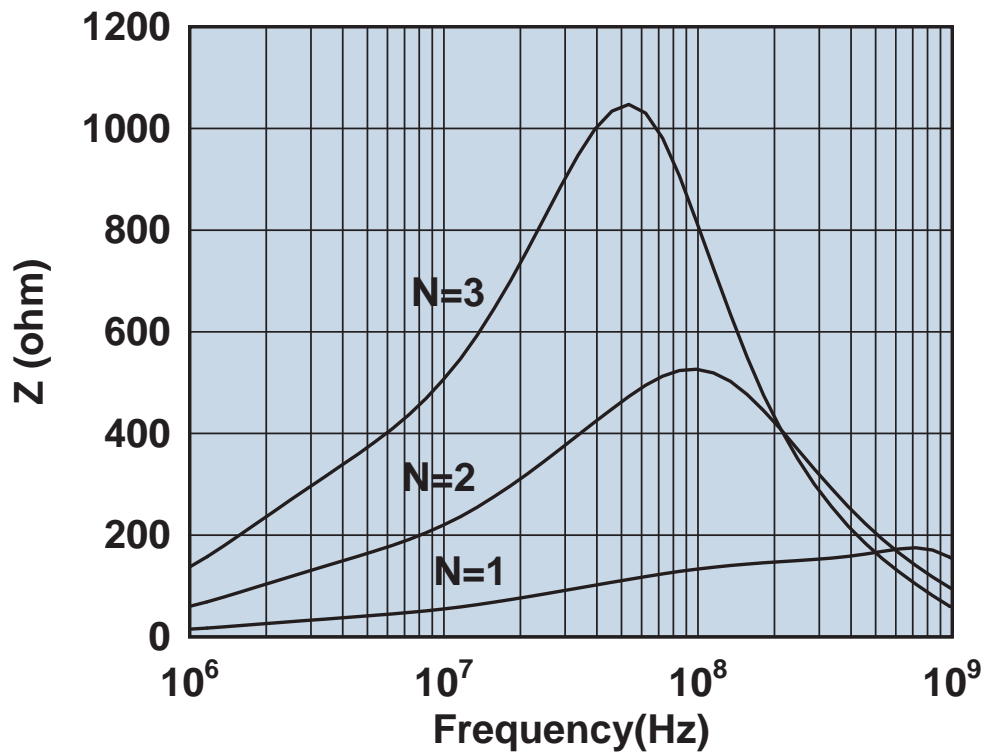

Impedance vs. frequency with one, two, and three turns.

2631625102

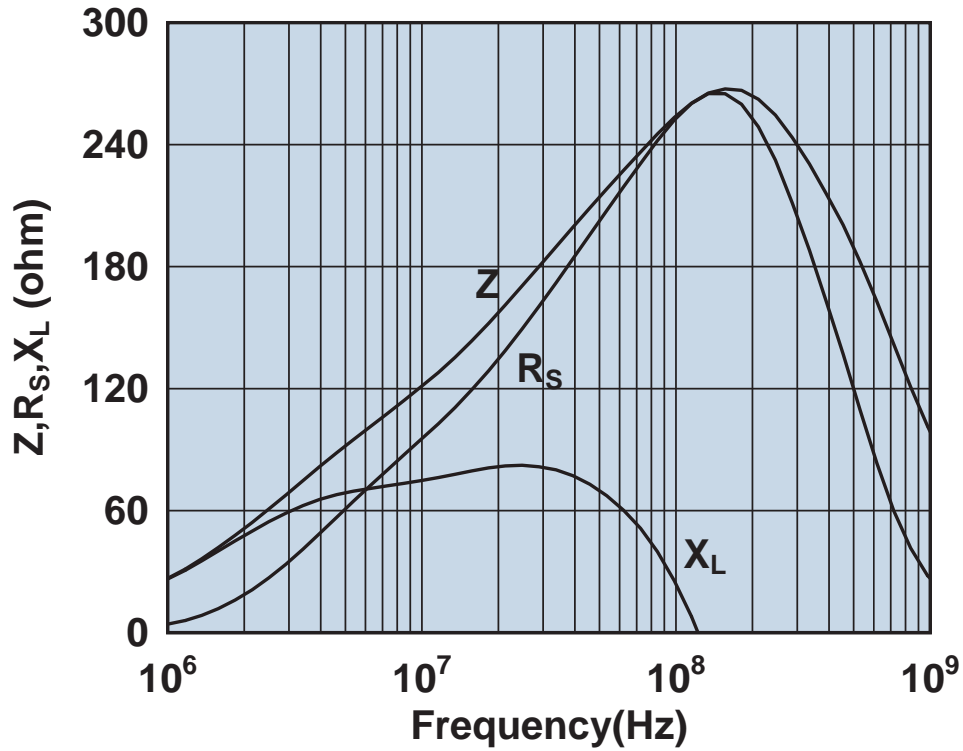

Impedance, reactance, and resistance vs. frequency.

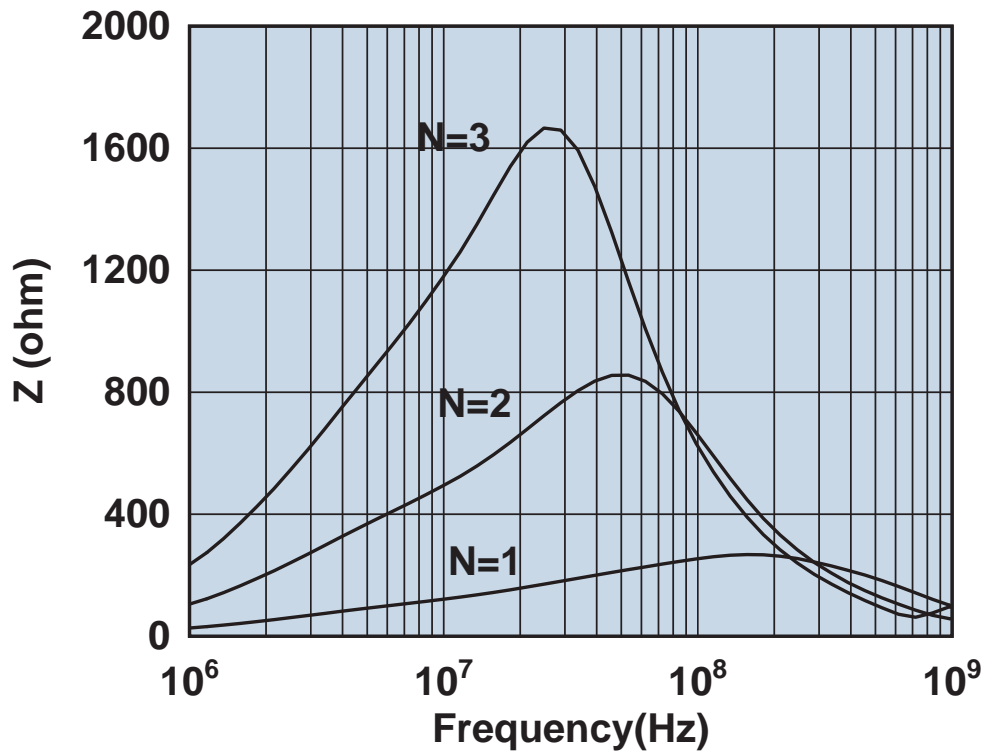

Impedance vs. frequency with one, two, and three turns.

2631626202

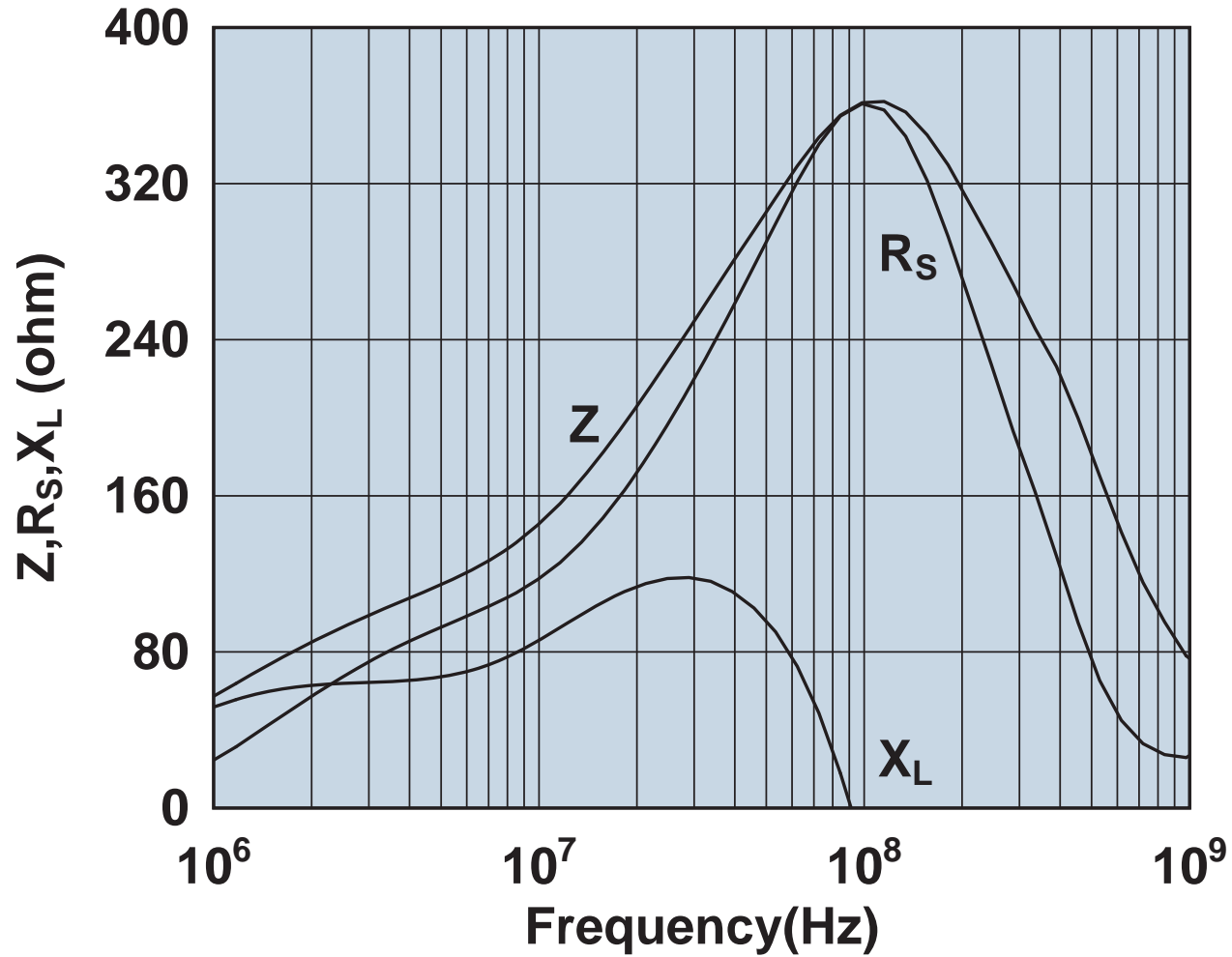

Impedance, reactance, and resistance vs. frequency.



2631626302

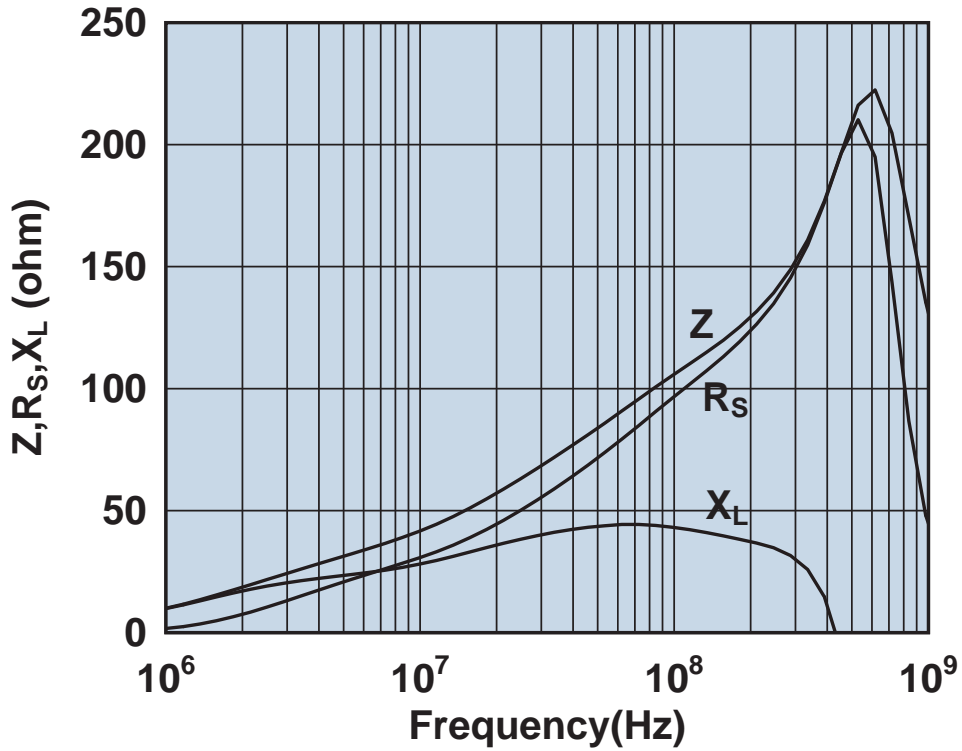

Impedance, reactance, and resistance vs. frequency.

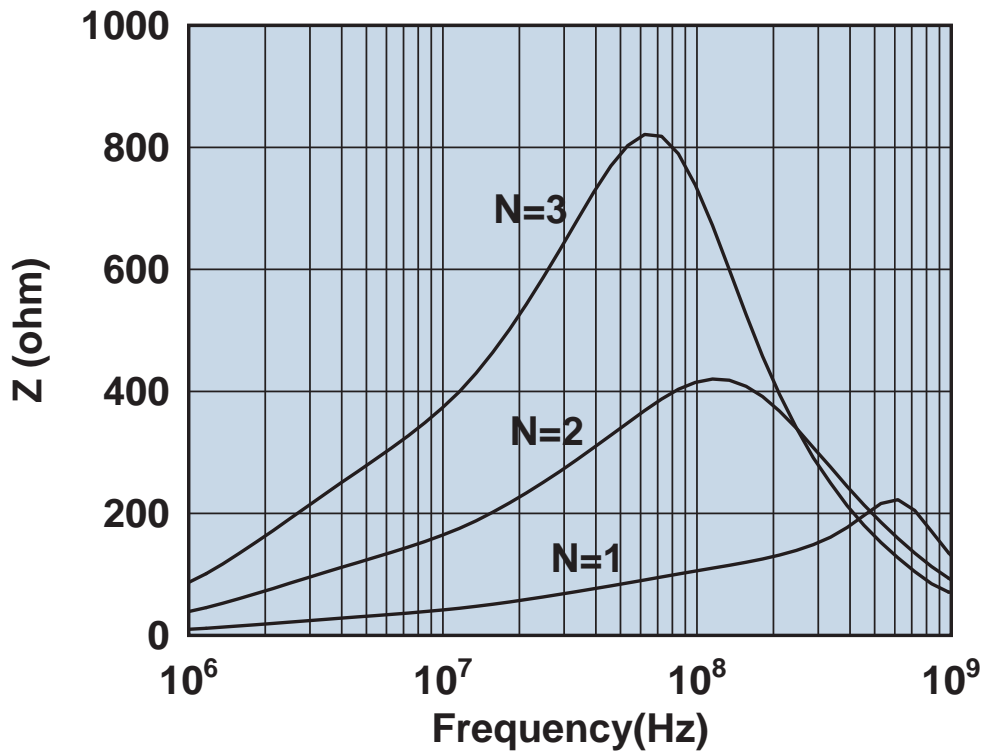

Impedance vs. frequency with one, two, and three turns.

2631626402

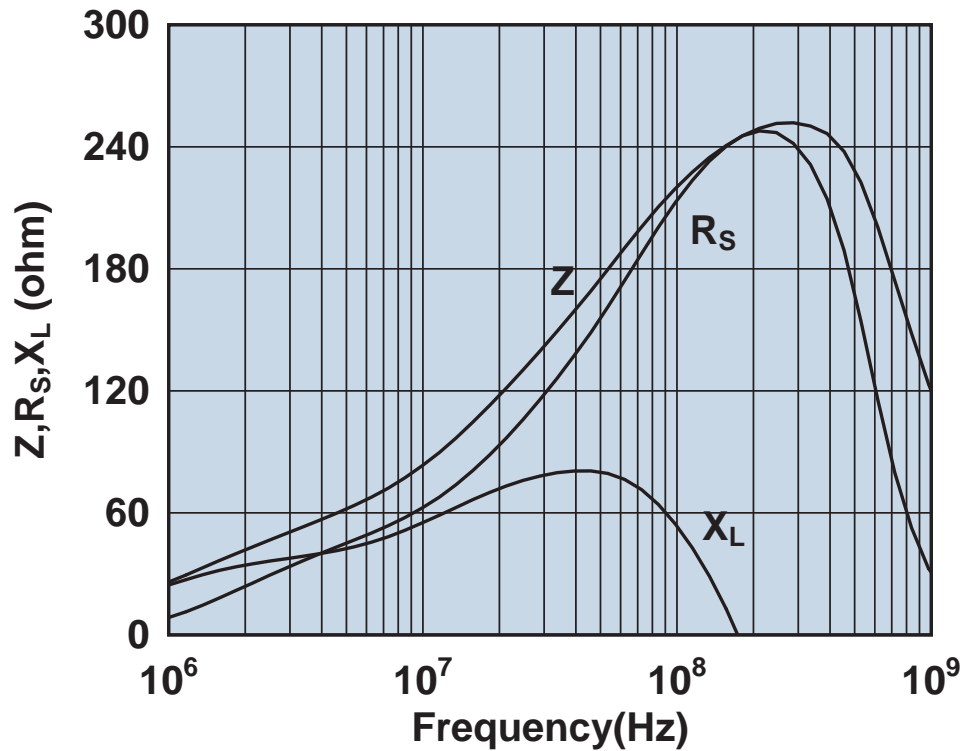

Impedance, reactance, and resistance vs. frequency.

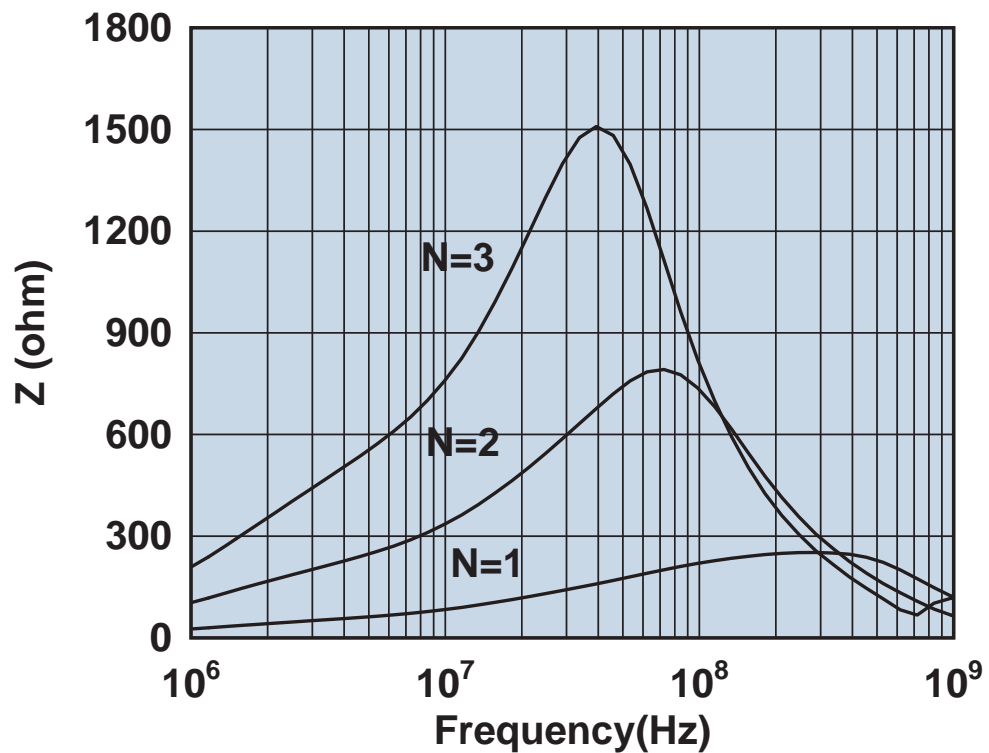

Impedance vs. frequency with one, two, and three turns.

2631665702

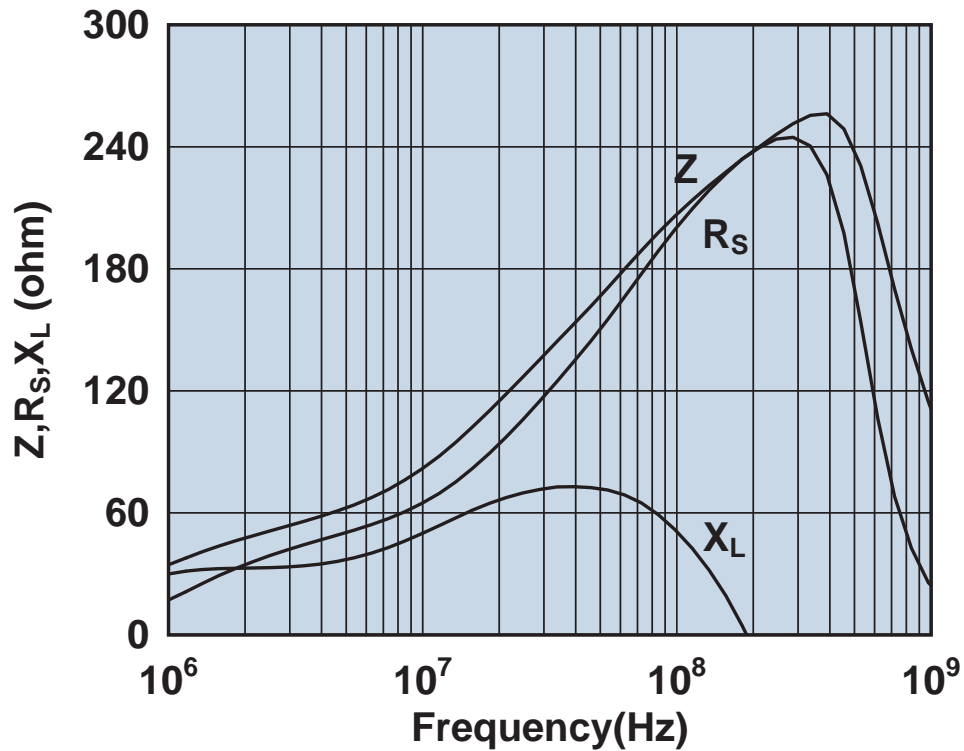

Impedance, reactance, and resistance vs. frequency.

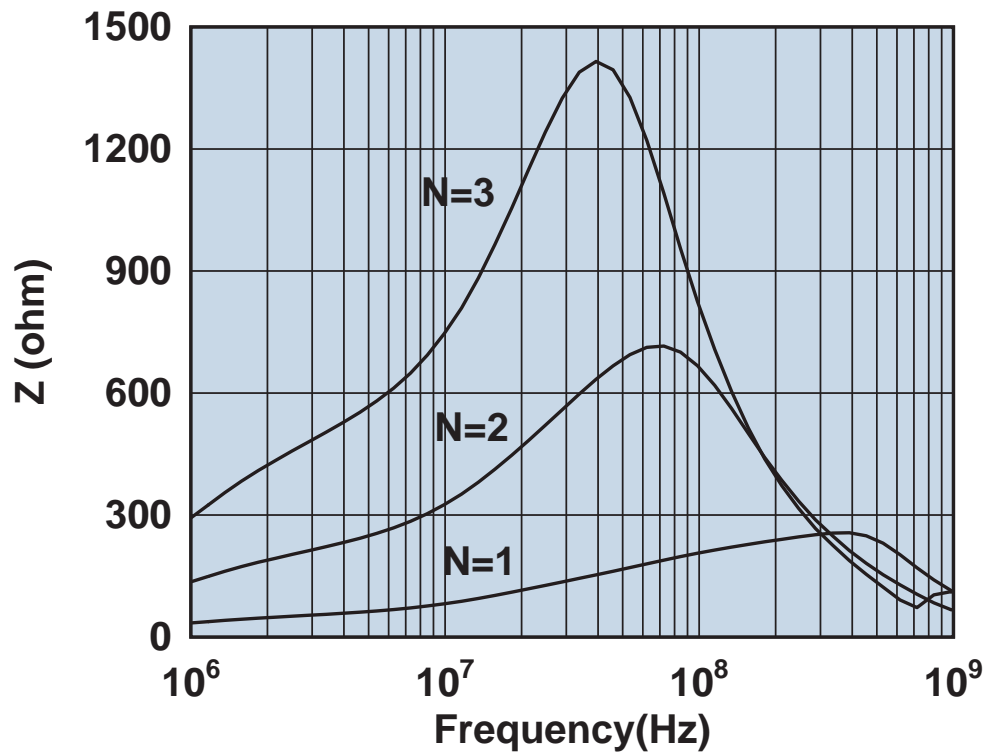

Impedance vs. frequency with one, two, and three turns.

2631665802

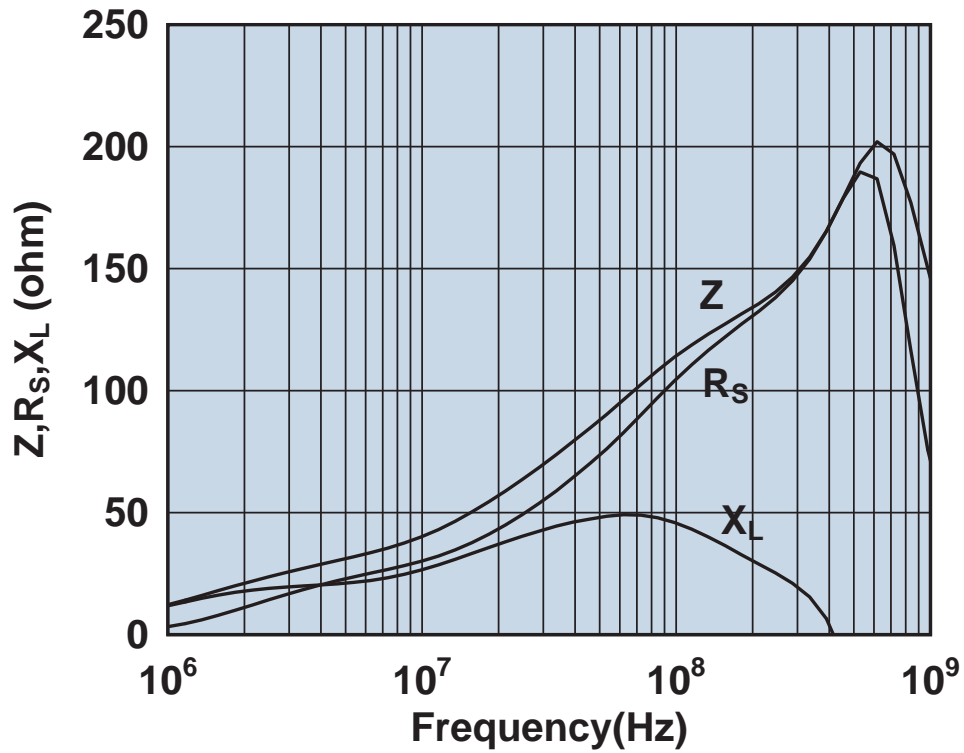

Impedance, reactance, and resistance vs. frequency.

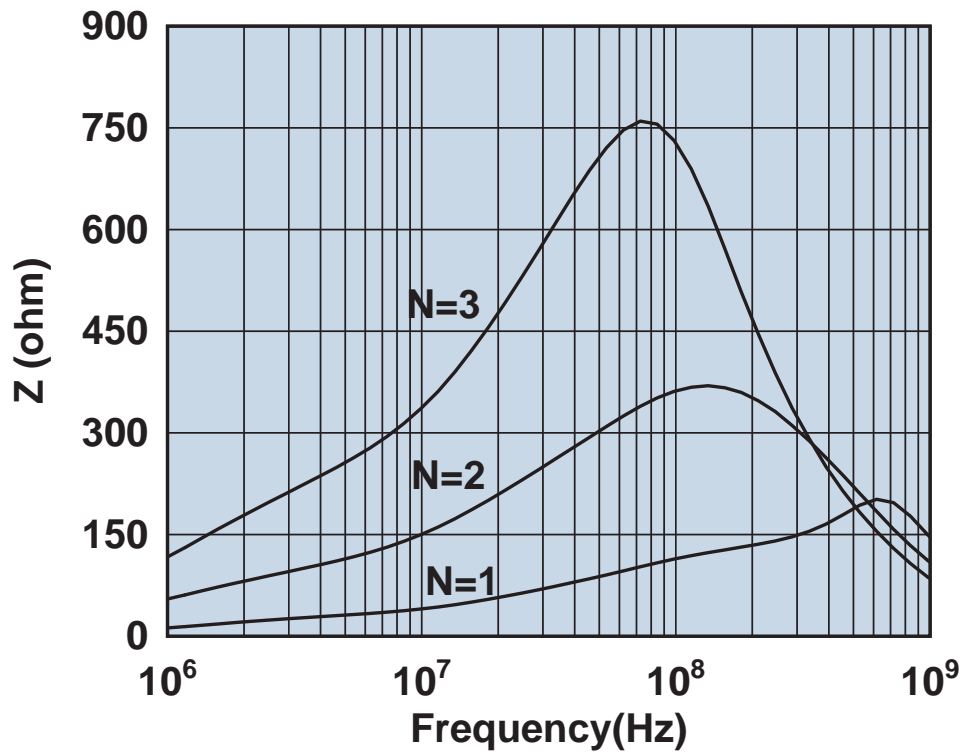

Impedance vs. frequency with one, two, and three turns.

2631801202

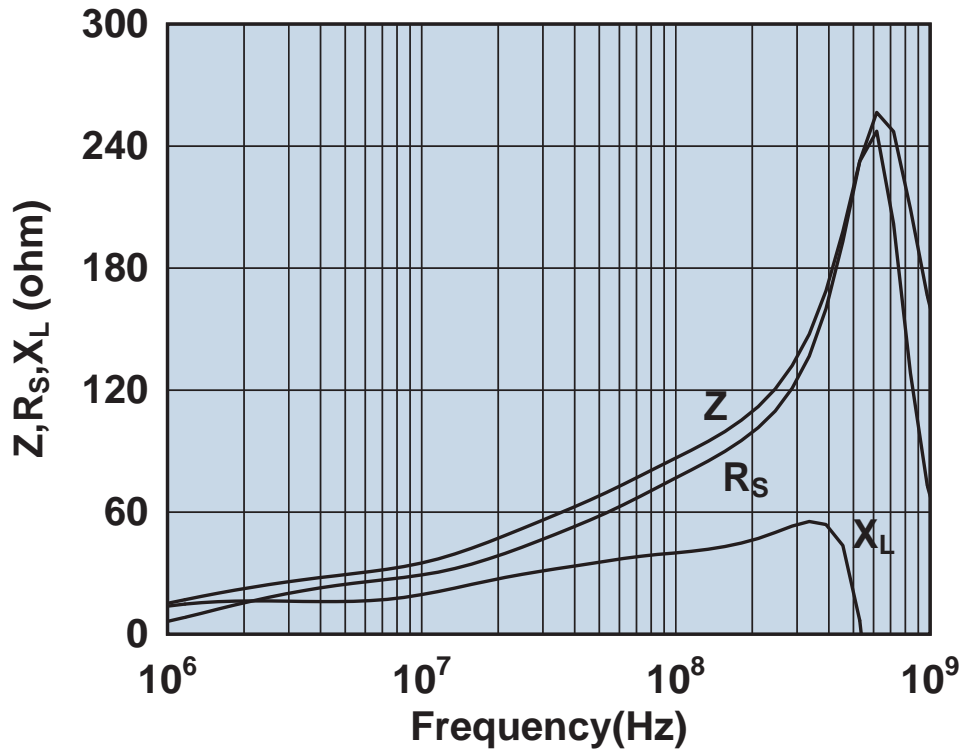

Impedance, reactance, and resistance vs. frequency.

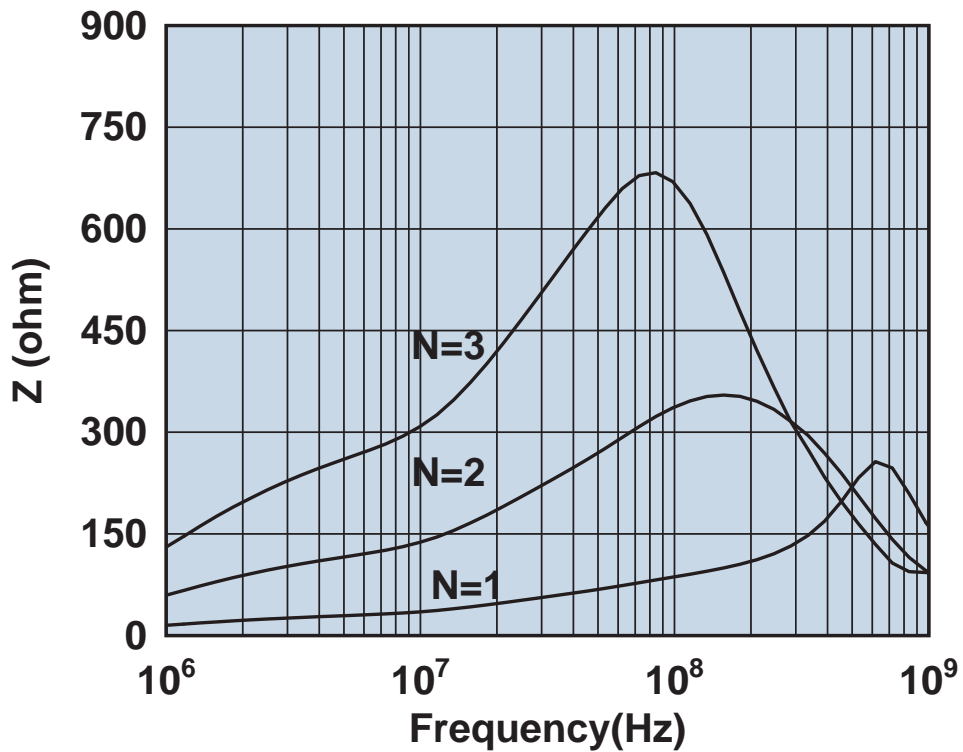

Impedance vs. frequency with one, two, and three turns.

2631803802

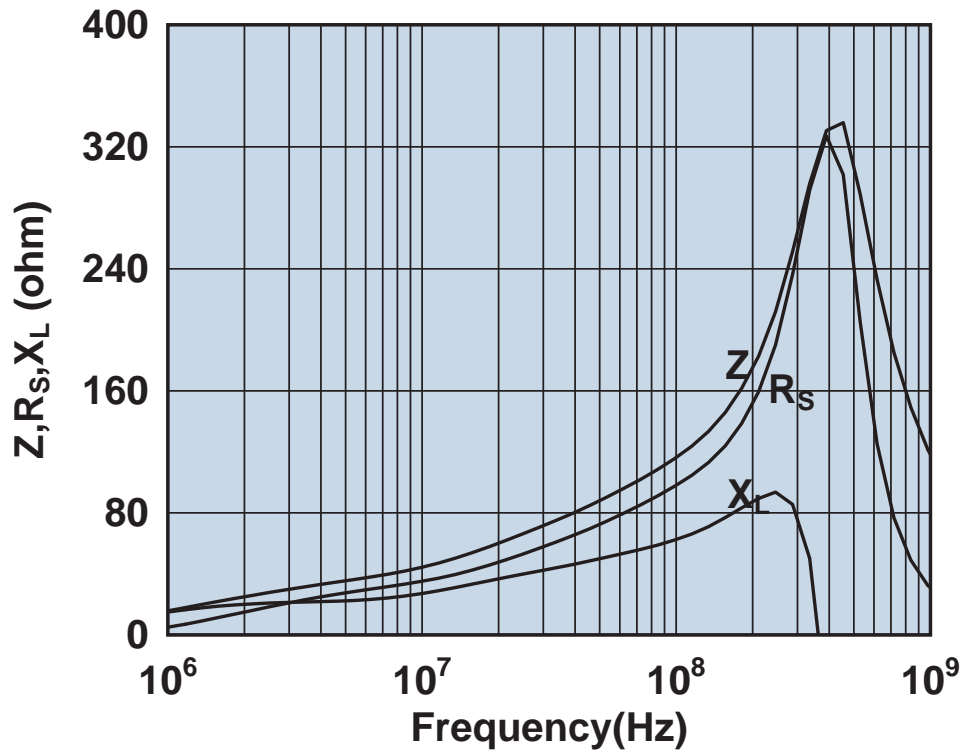

Impedance, reactance, and resistance vs. frequency.

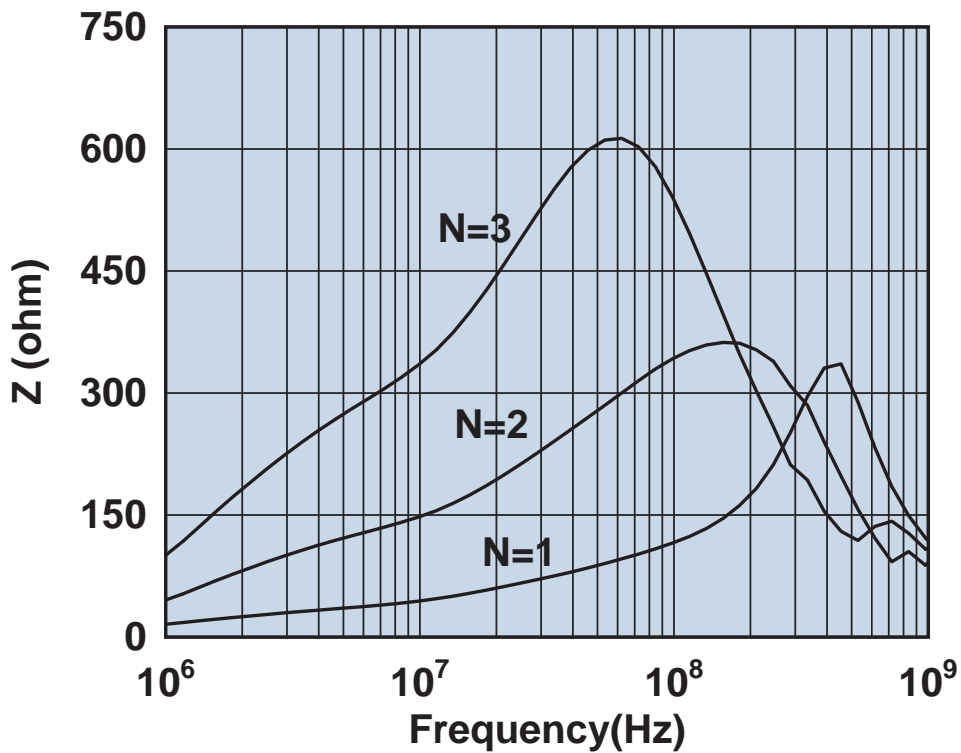

Impedance vs. frequency with one, two, and three turns.

2643102002

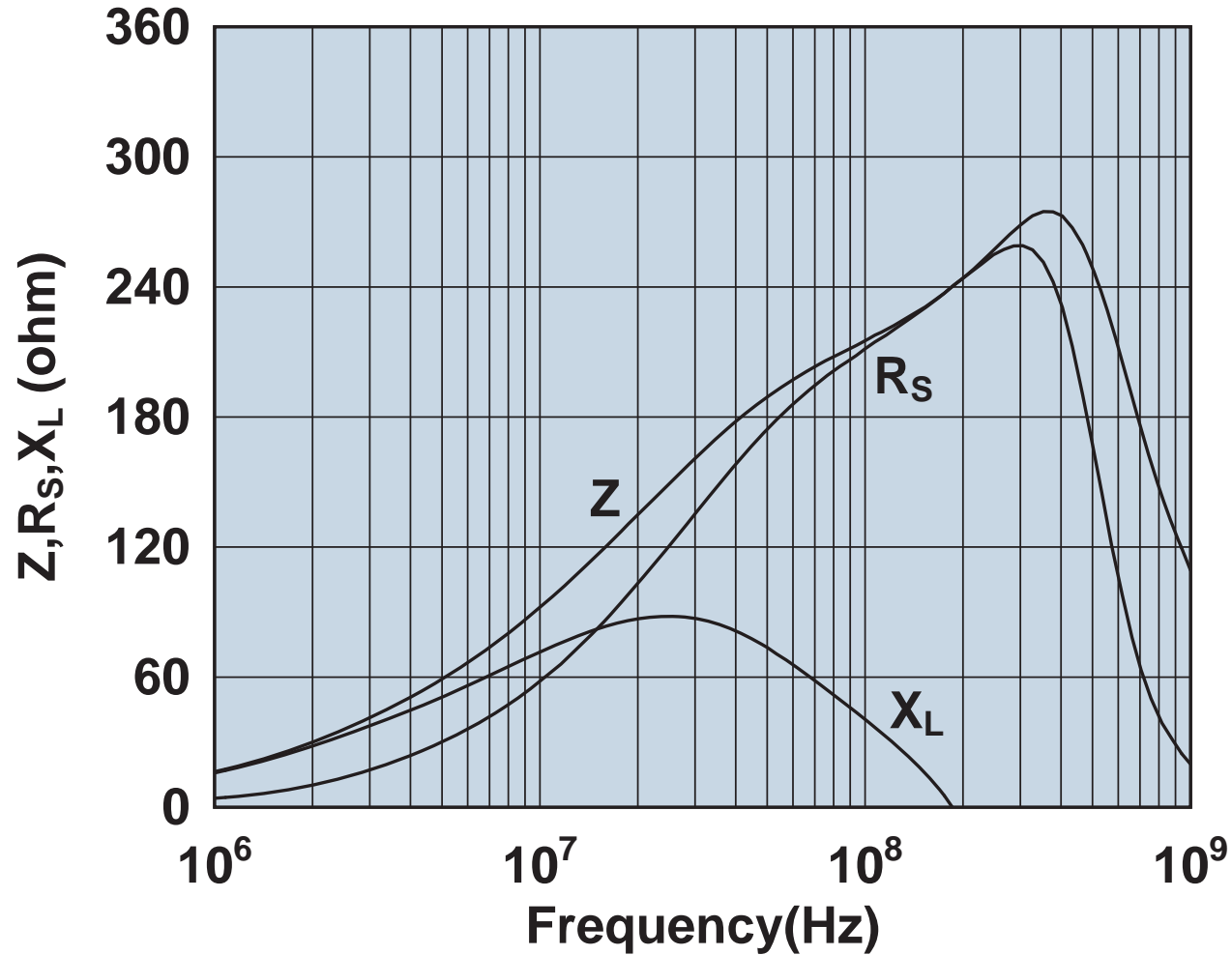

Impedance, reactance, and resistance vs. frequency.

2643102402

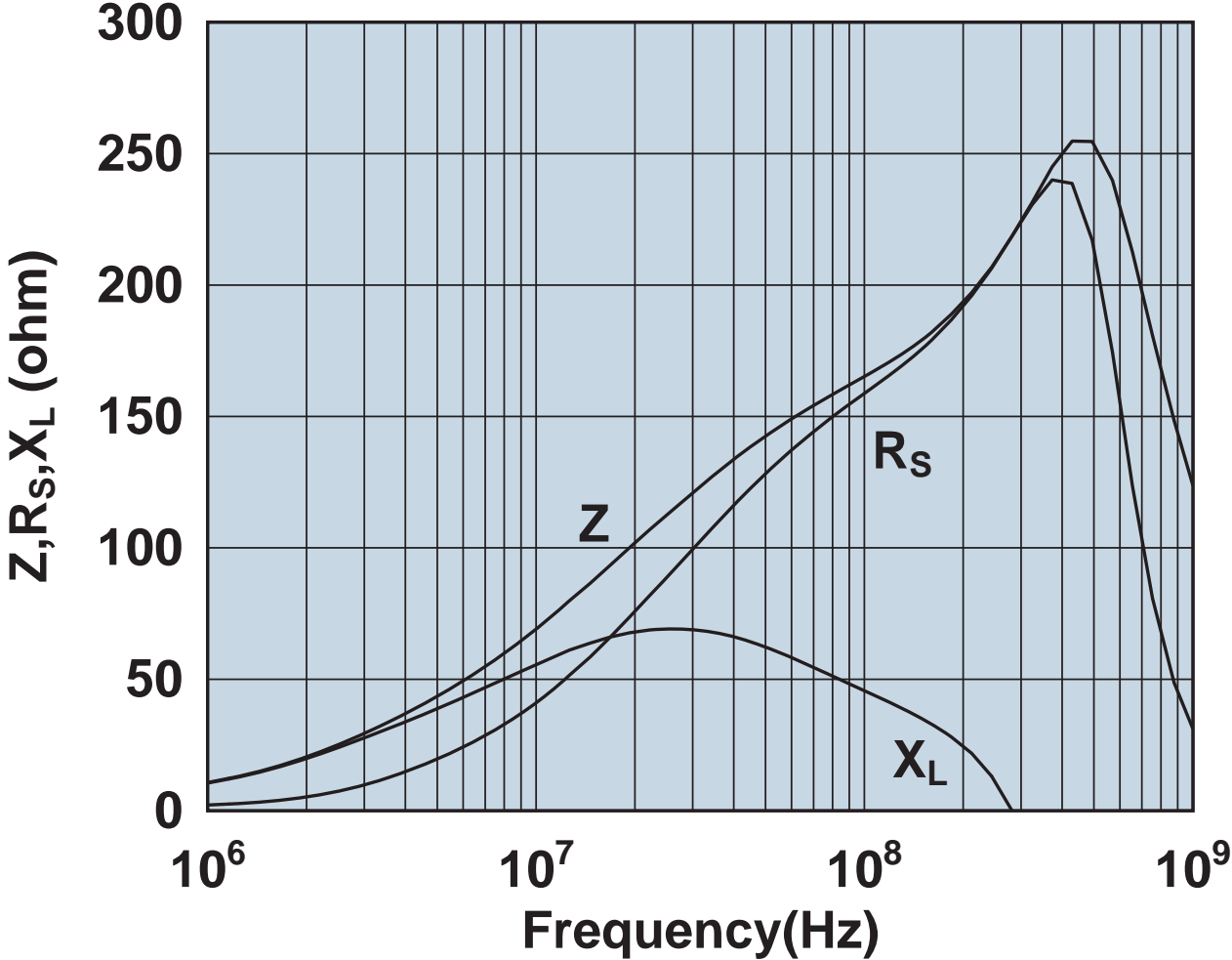

Impedance, reactance, and resistance vs. frequency.



2643103002

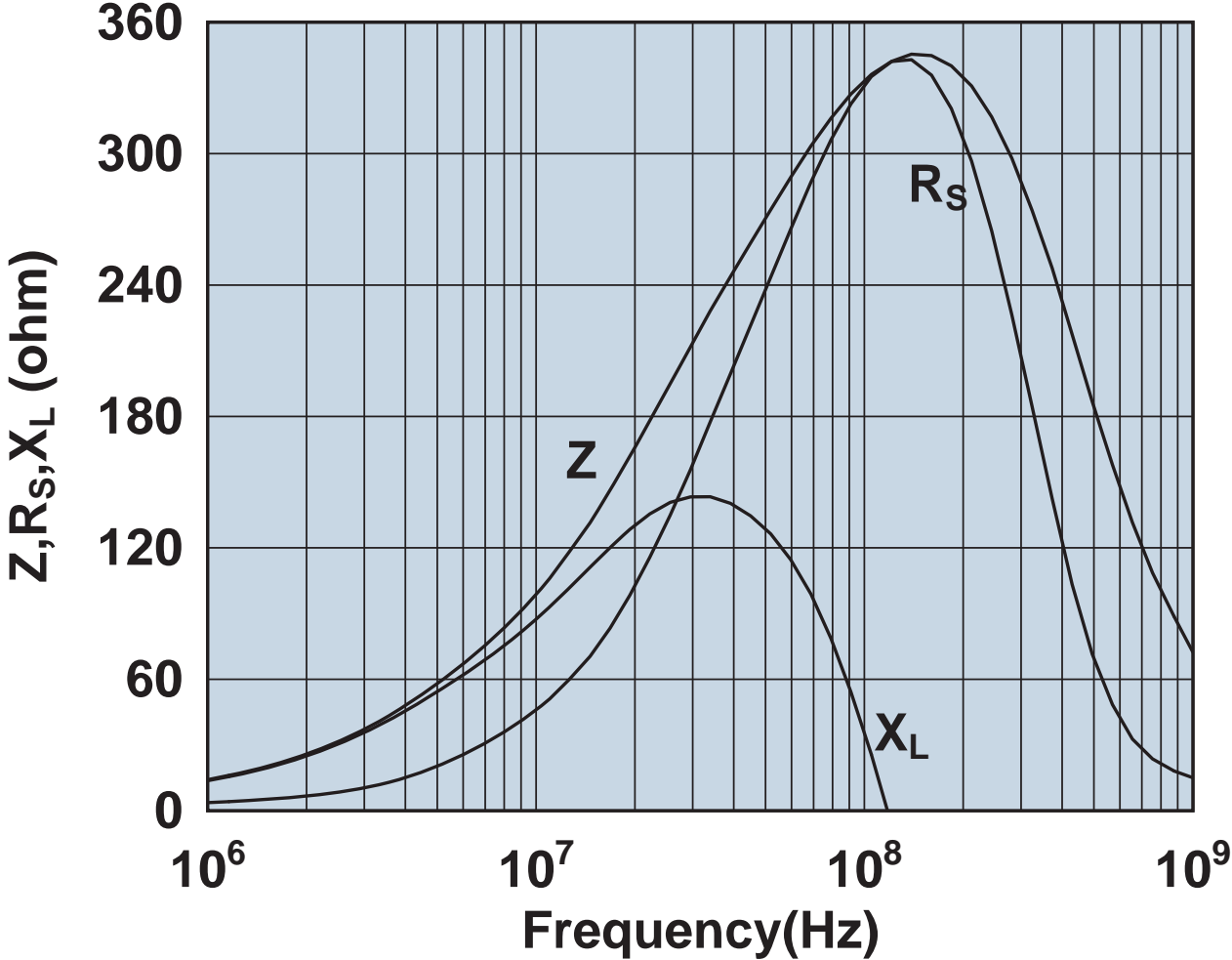

Impedance, reactance, and resistance vs. frequency.

2643103102

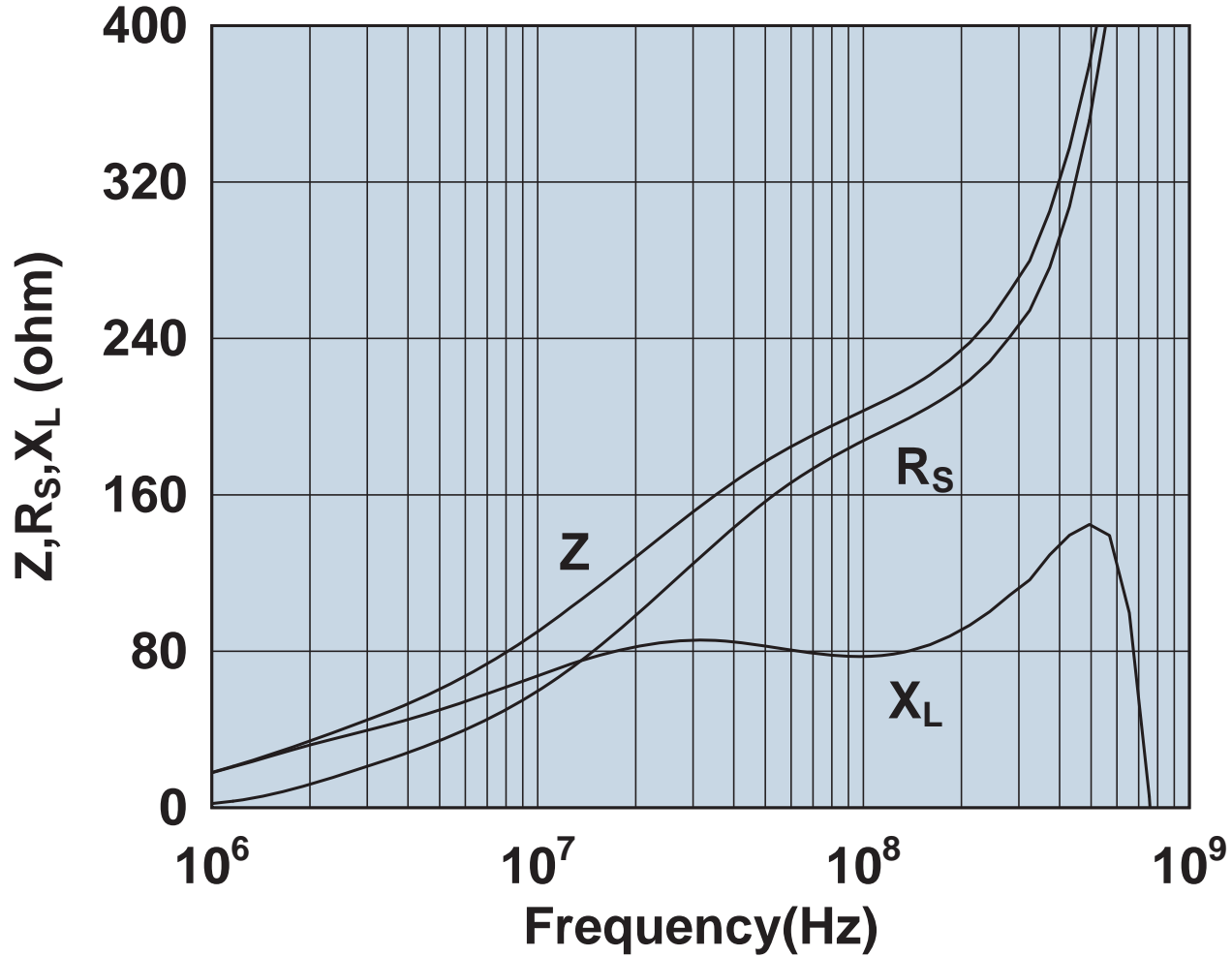

Impedance, reactance, and resistance vs. frequency.

2643163851

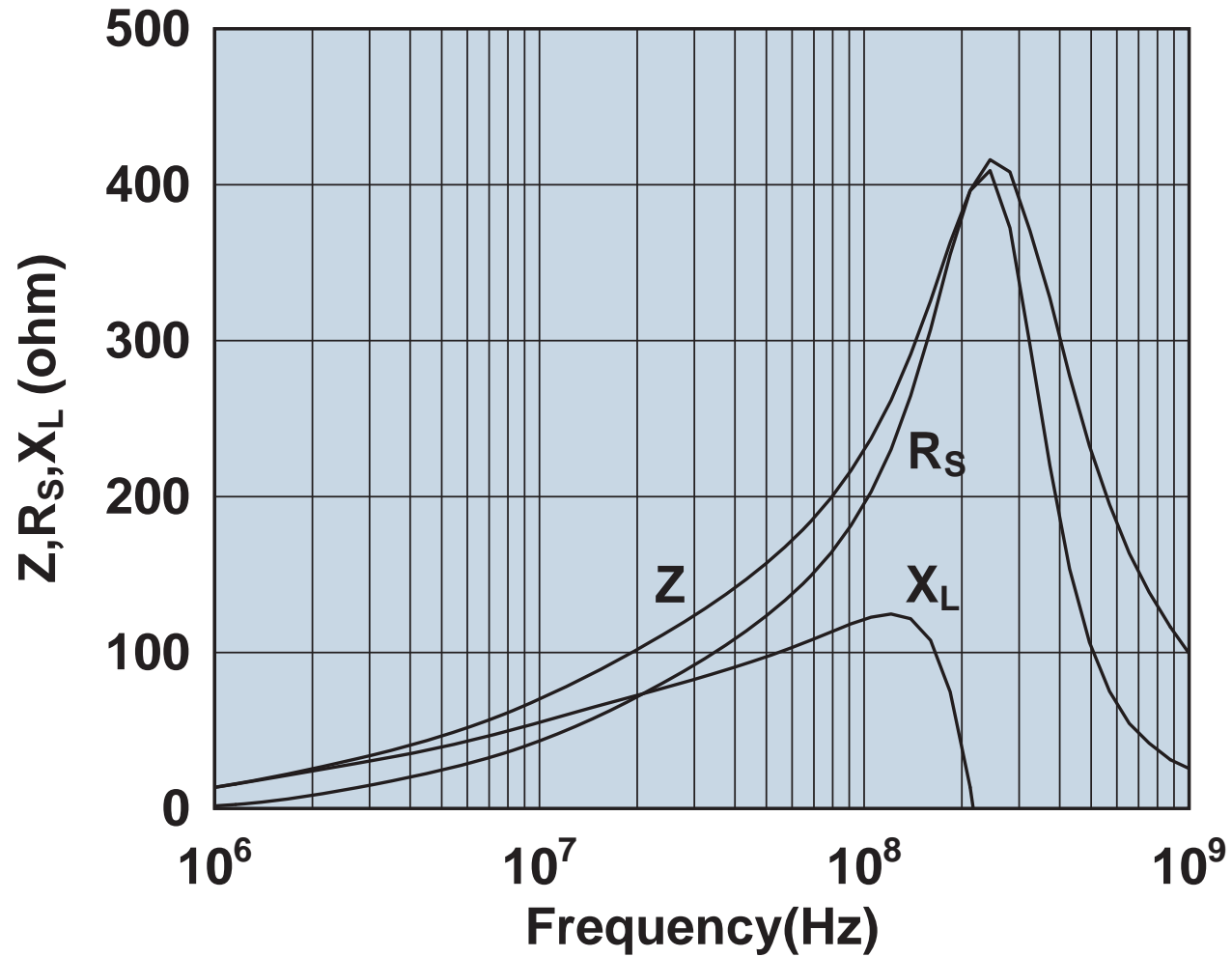

Impedance, reactance, and resistance vs. frequency.

2643163951

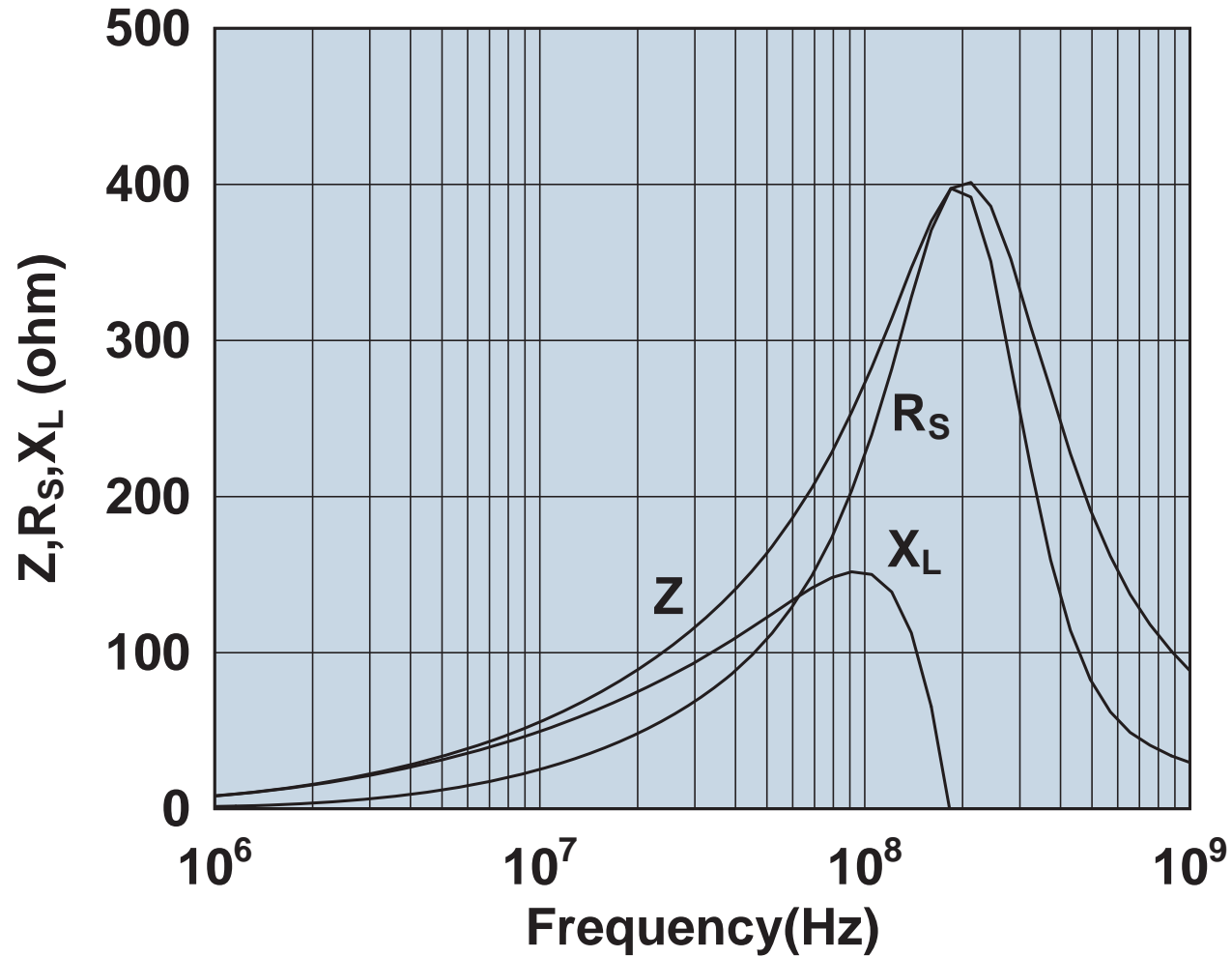

Impedance, reactance, and resistance vs. frequency.

2643164051

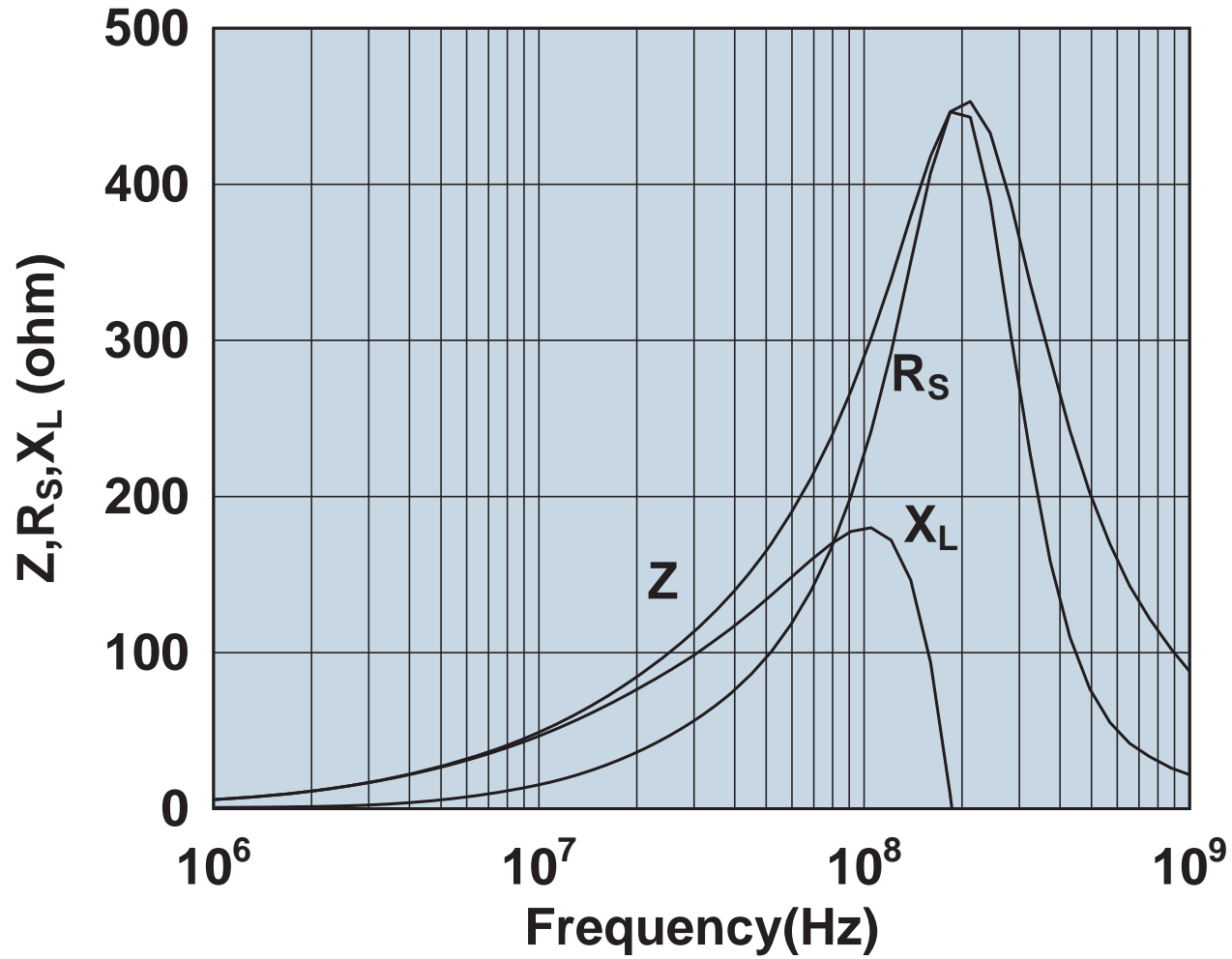

Impedance, reactance, and resistance vs. frequency.

2643164151

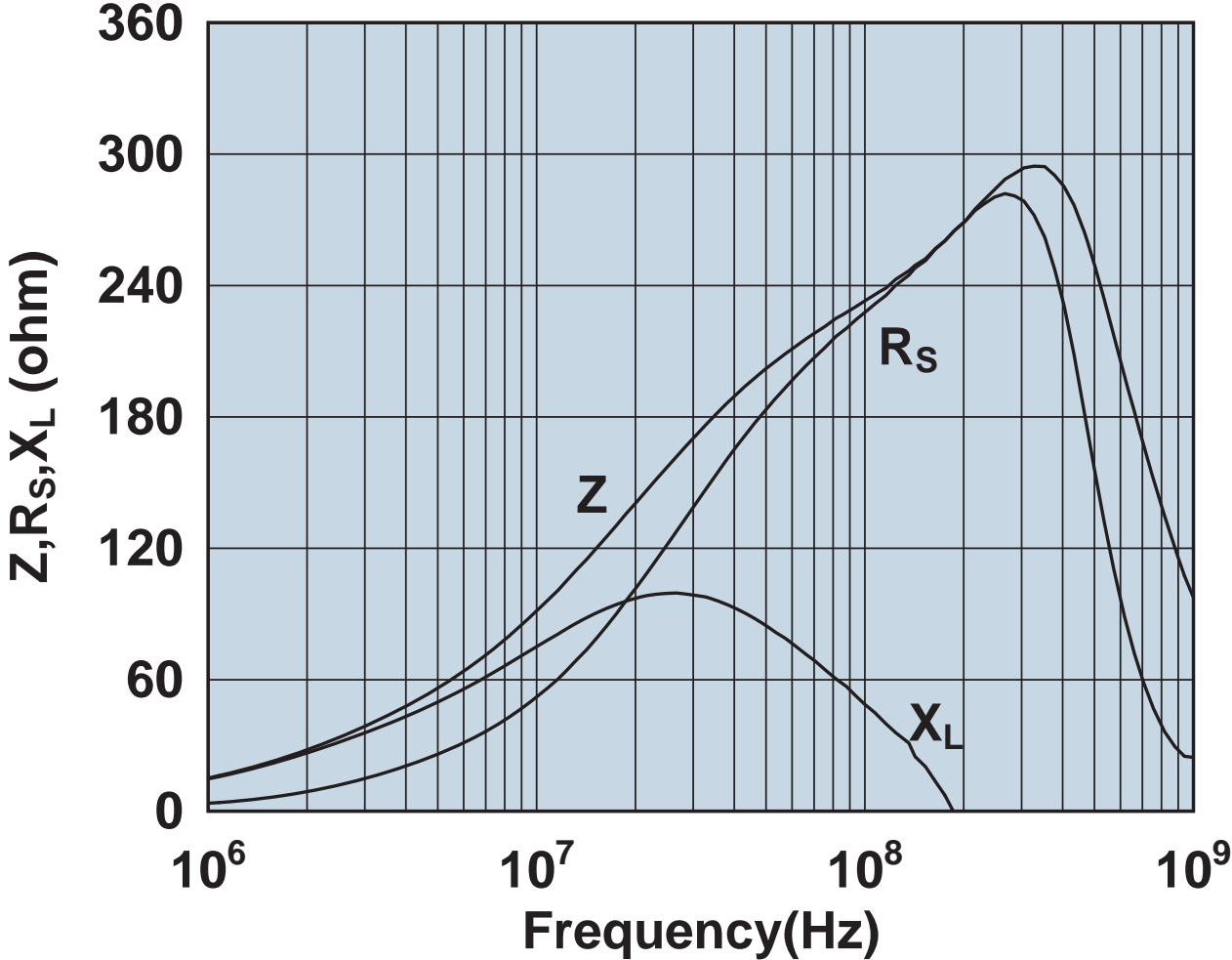

Impedance, reactance, and resistance vs. frequency.

2643164251

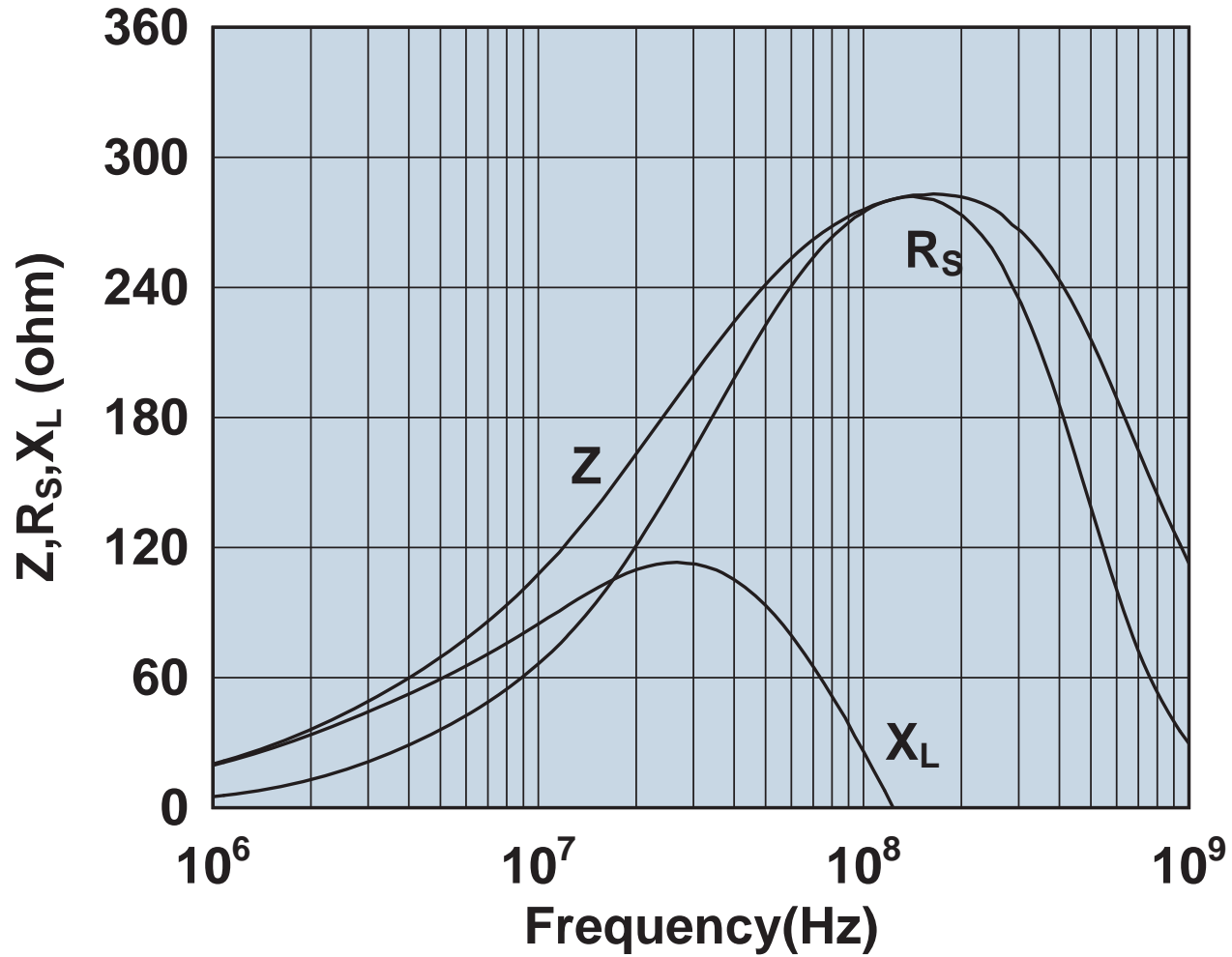

Impedance, reactance, and resistance vs. frequency.

2643164551

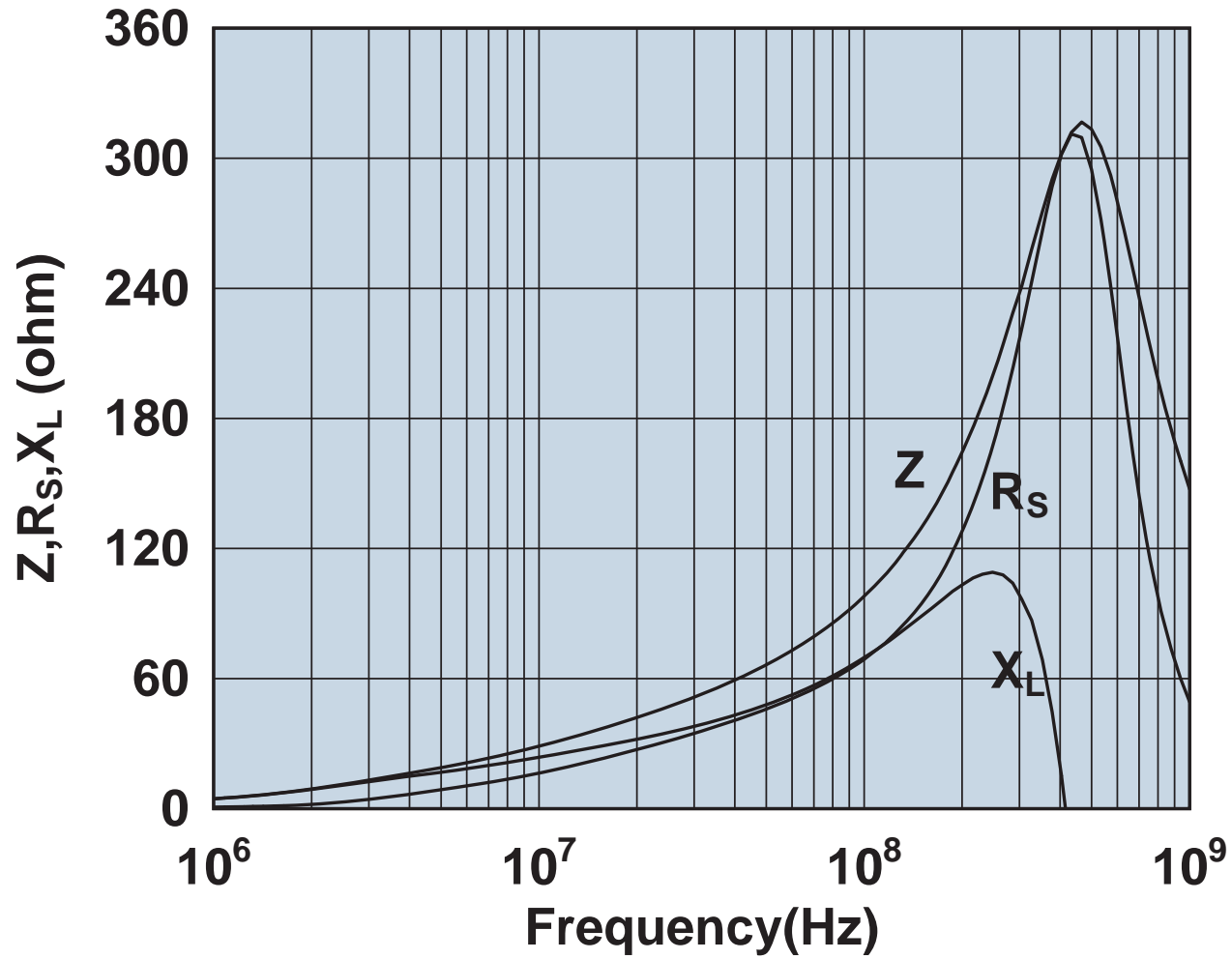

Impedance, reactance, and resistance vs. frequency.



2643165151

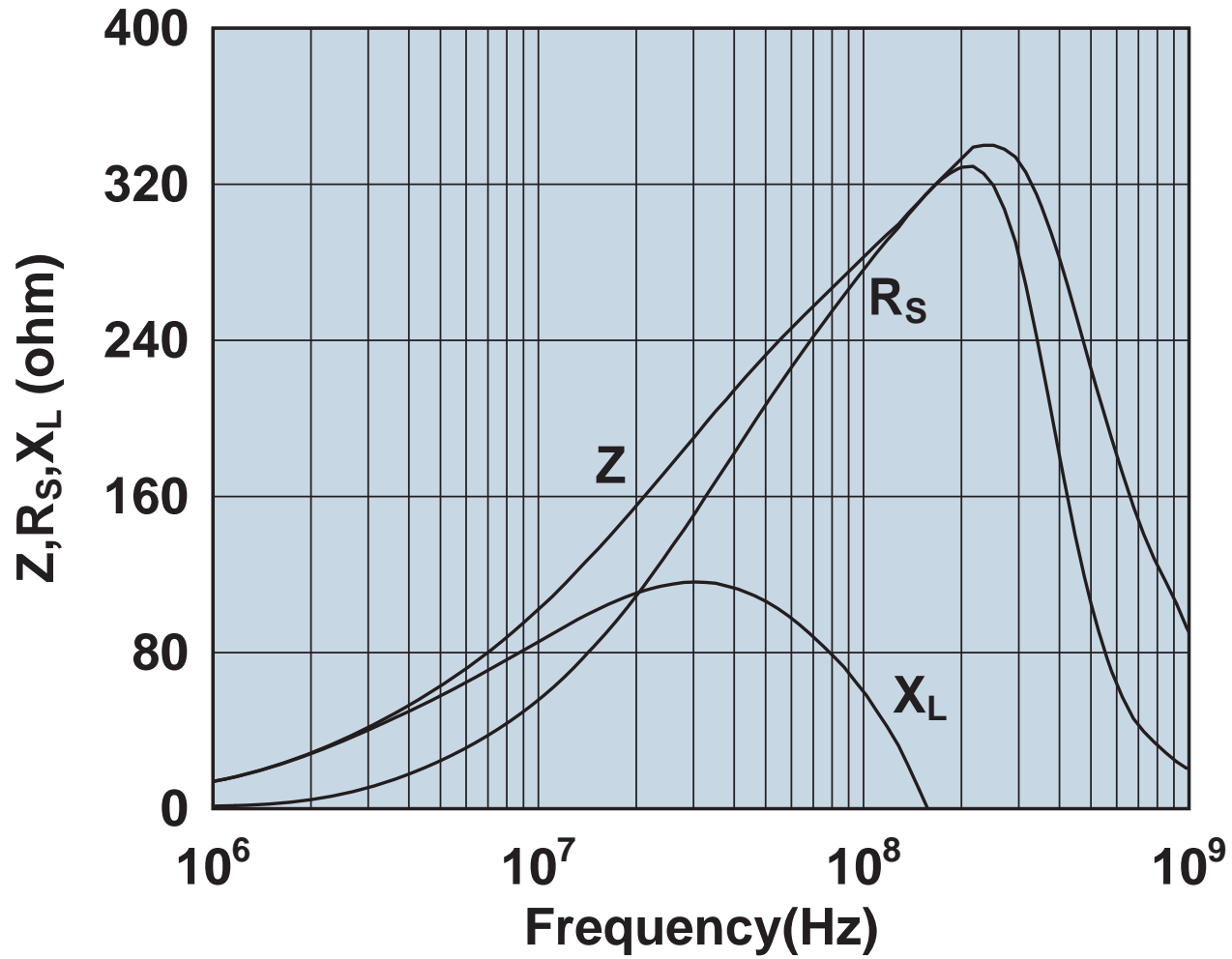

Impedance, reactance, and resistance vs. frequency.

2643165451

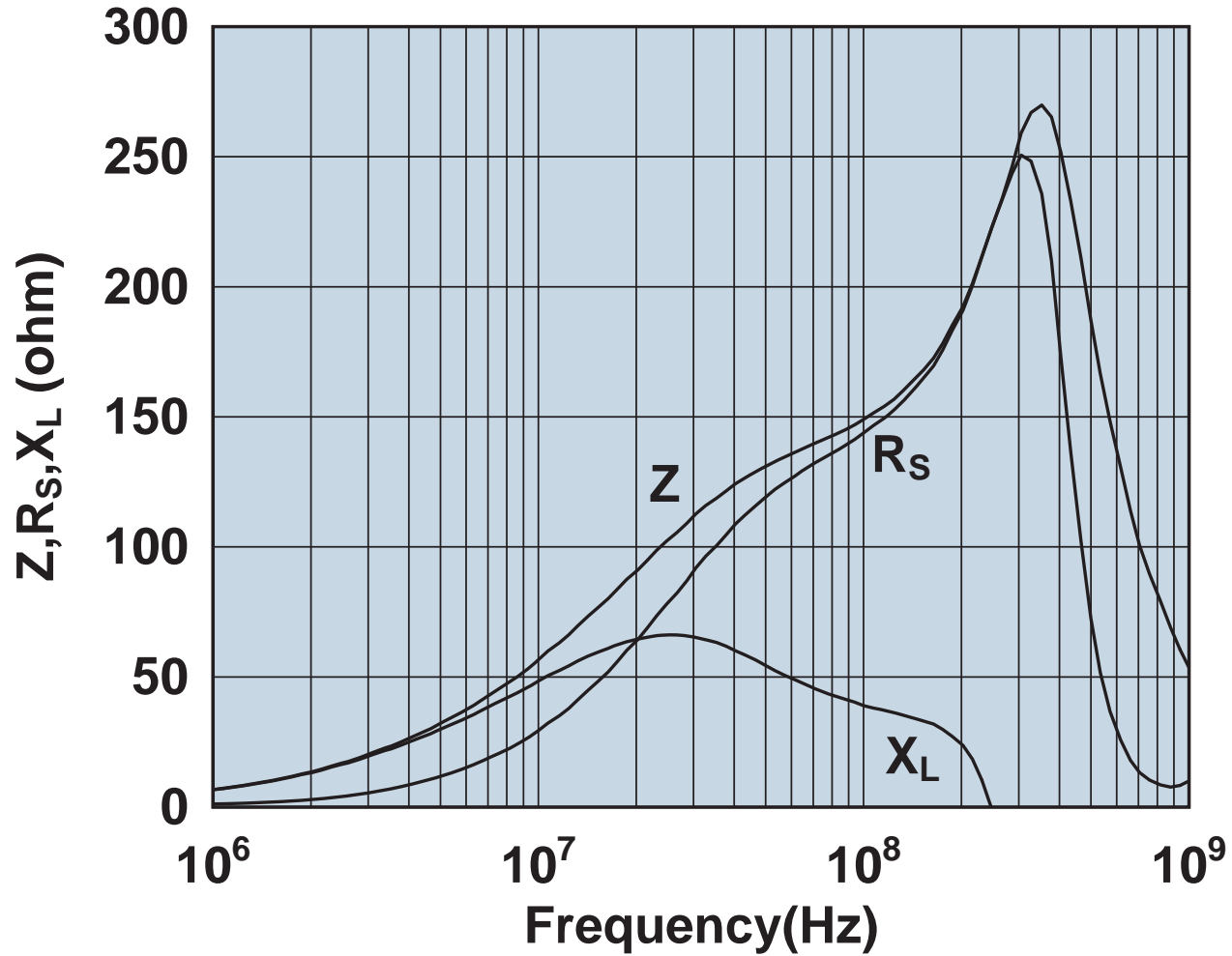

Impedance, reactance, and resistance vs. frequency.

2643166251

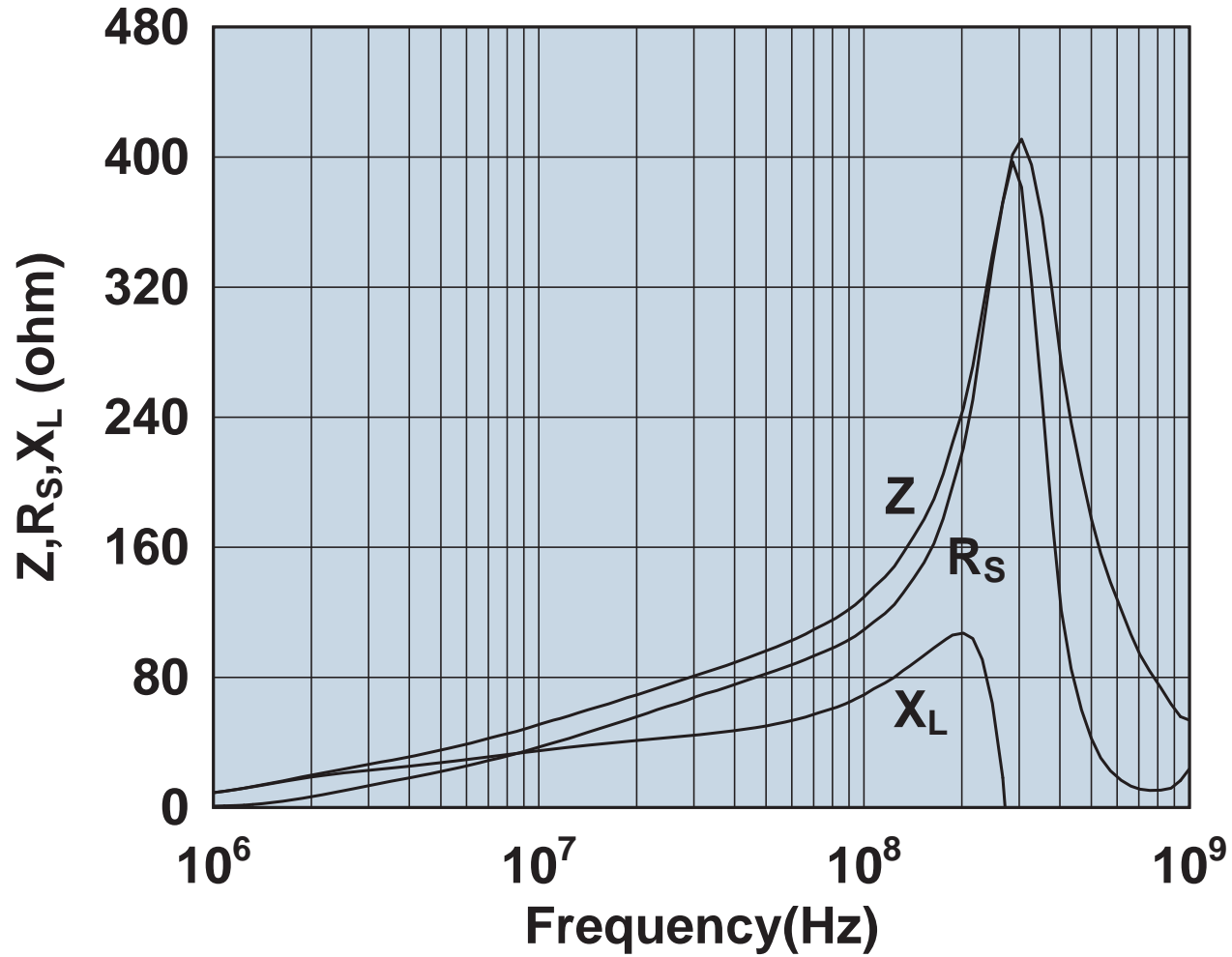

Impedance, reactance, and resistance vs. frequency.

2643166451

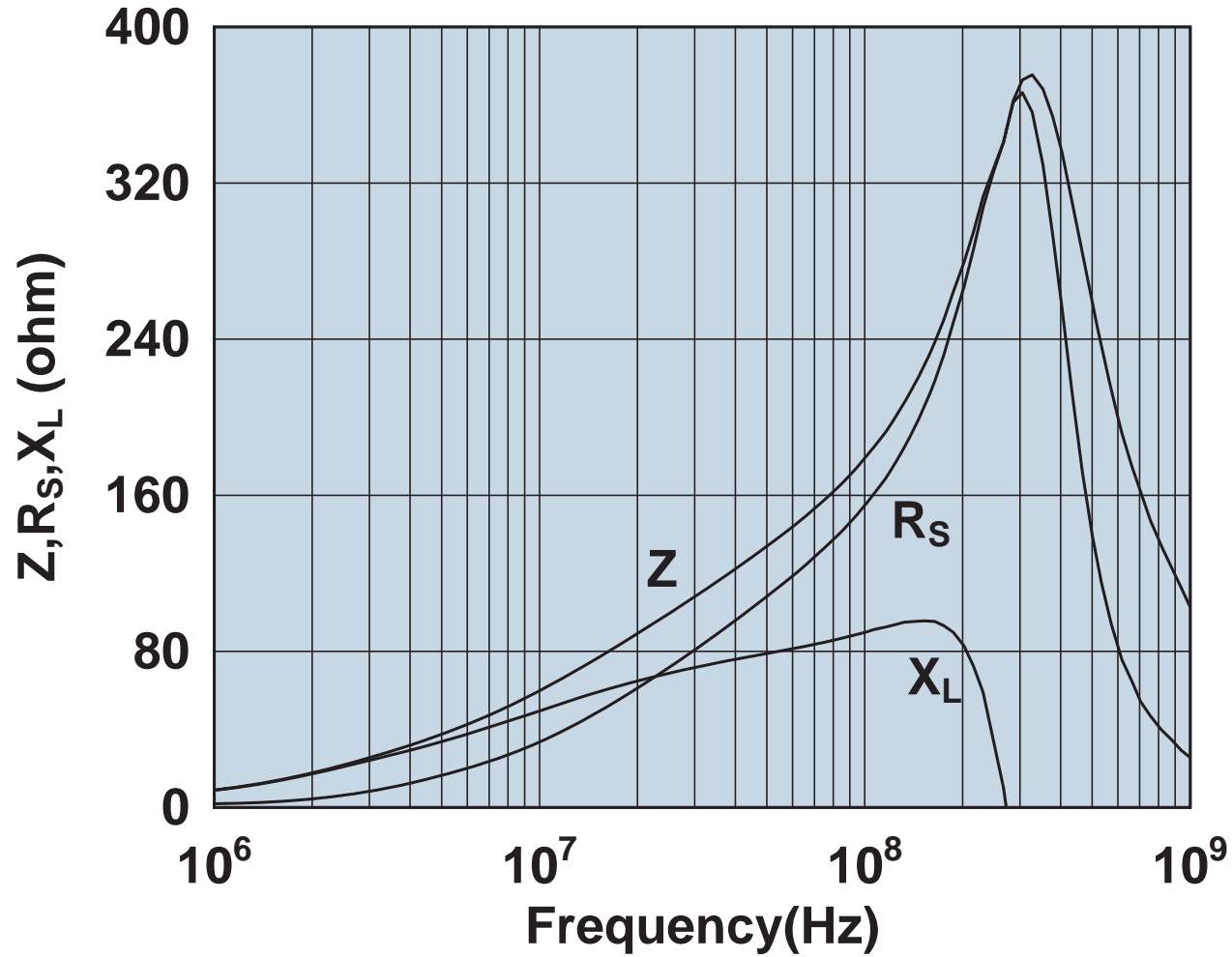

Impedance, reactance, and resistance vs. frequency.

2643166551

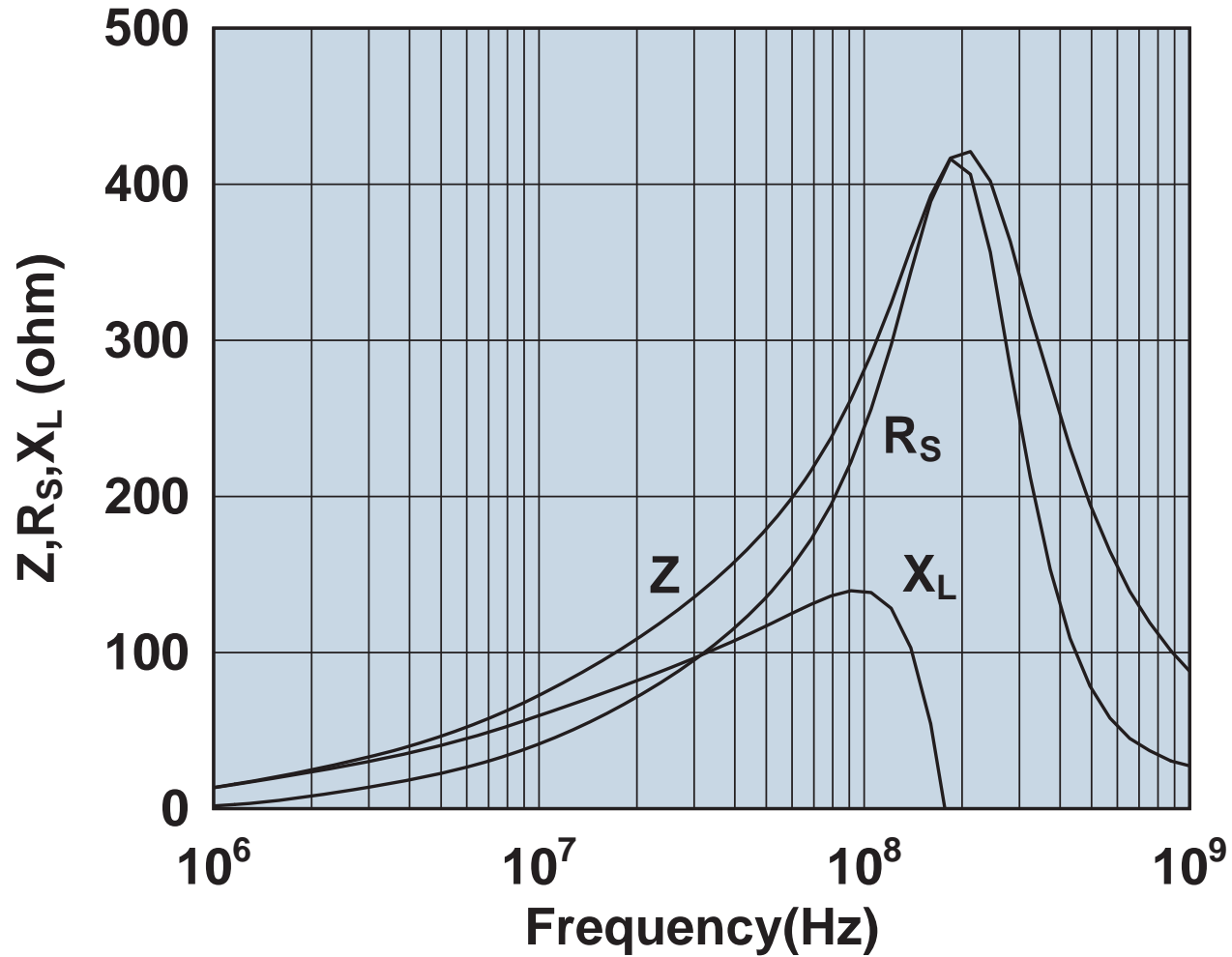

Impedance, reactance, and resistance vs. frequency.

2643166651

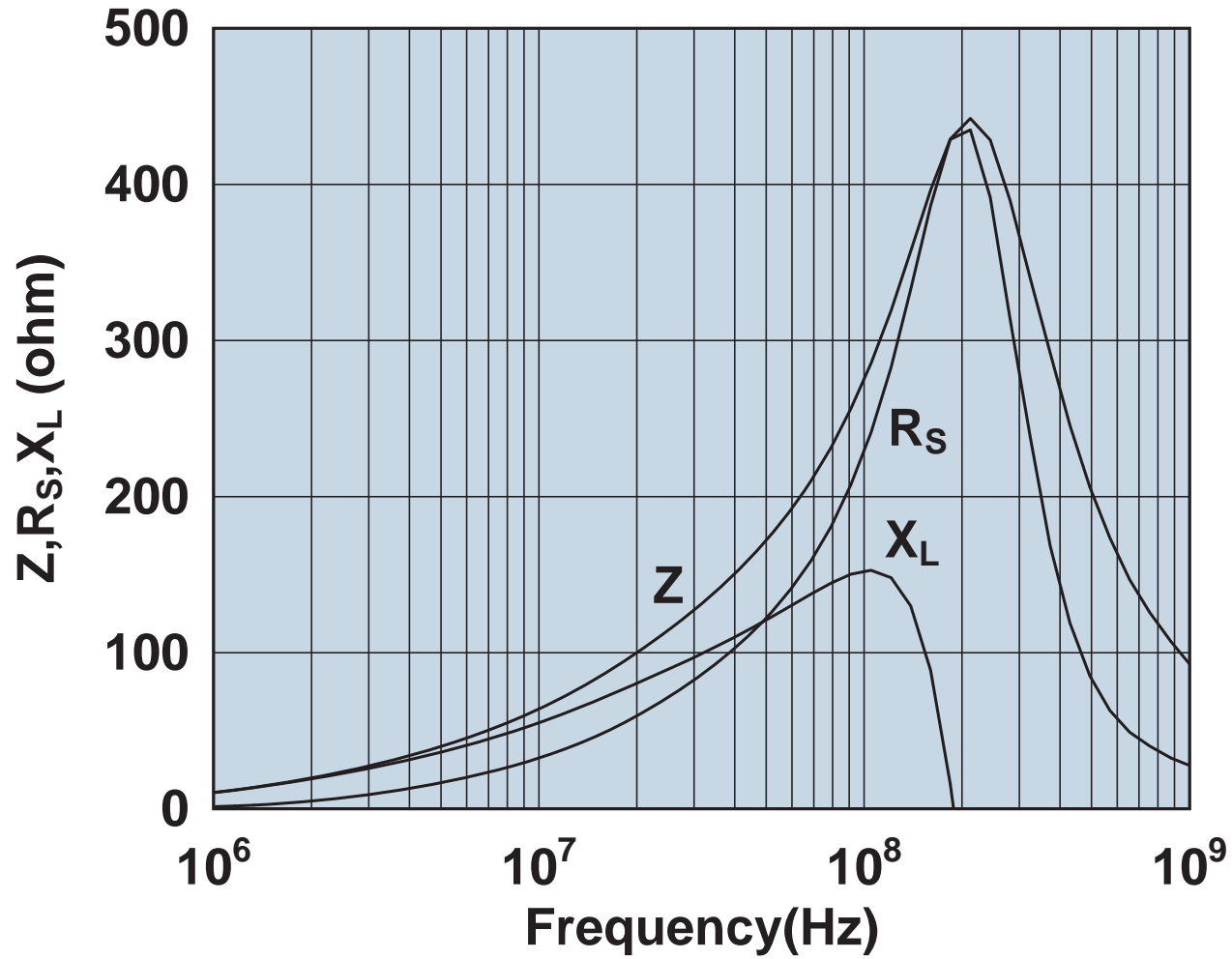

Impedance, reactance, and resistance vs. frequency.

2643166751

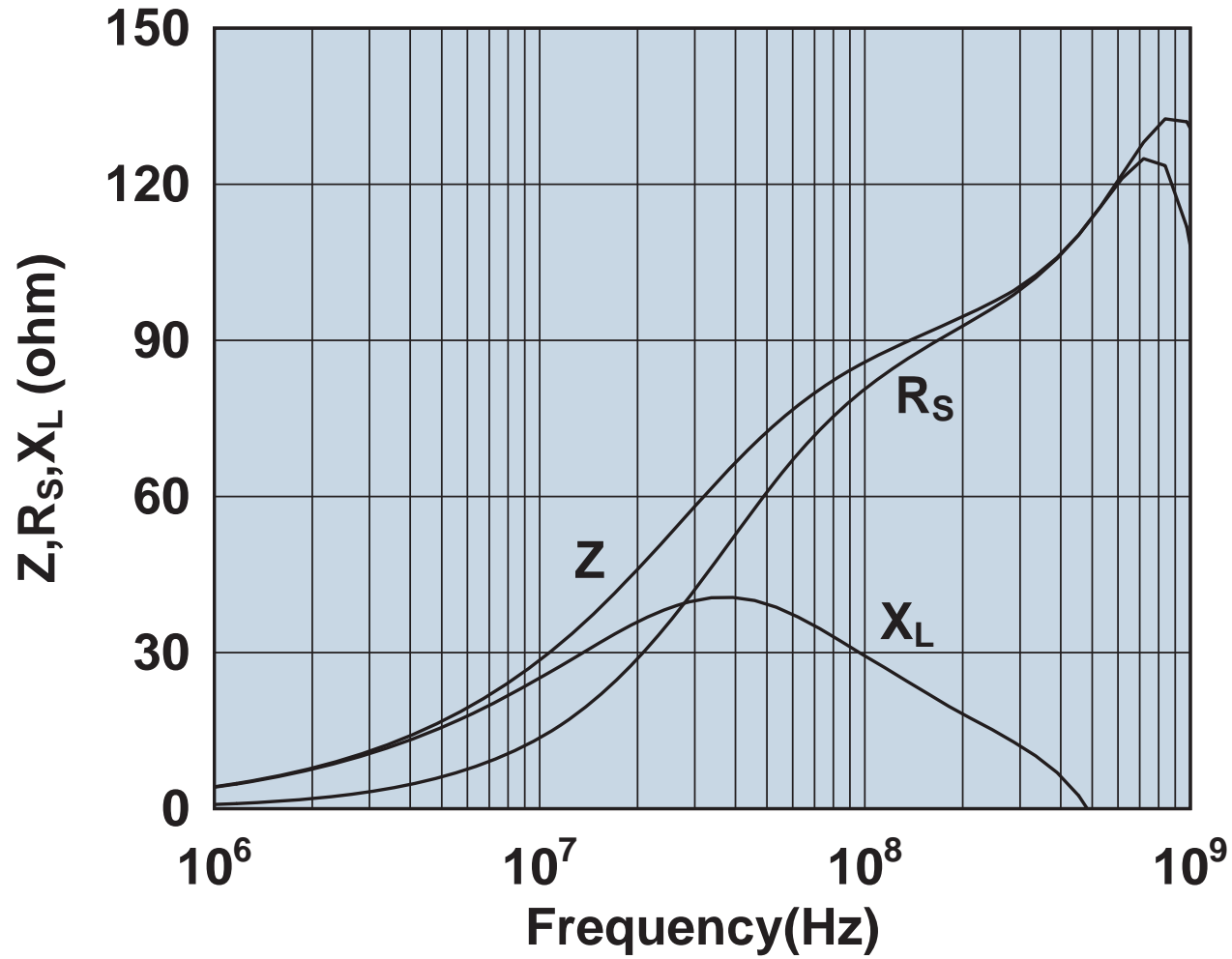

Impedance, reactance, and resistance vs. frequency.

2643166851

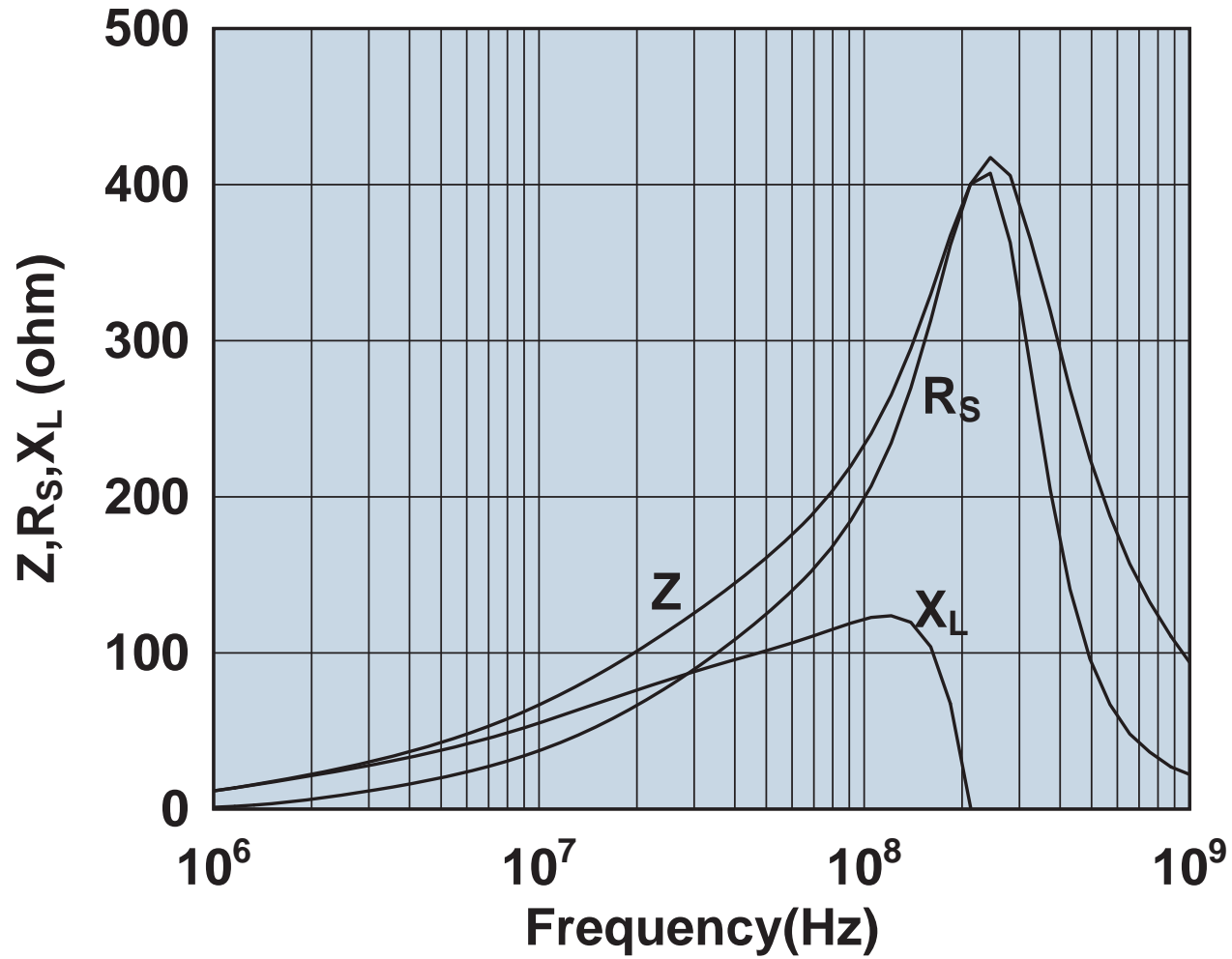

Impedance, reactance, and resistance vs. frequency.



2643167251

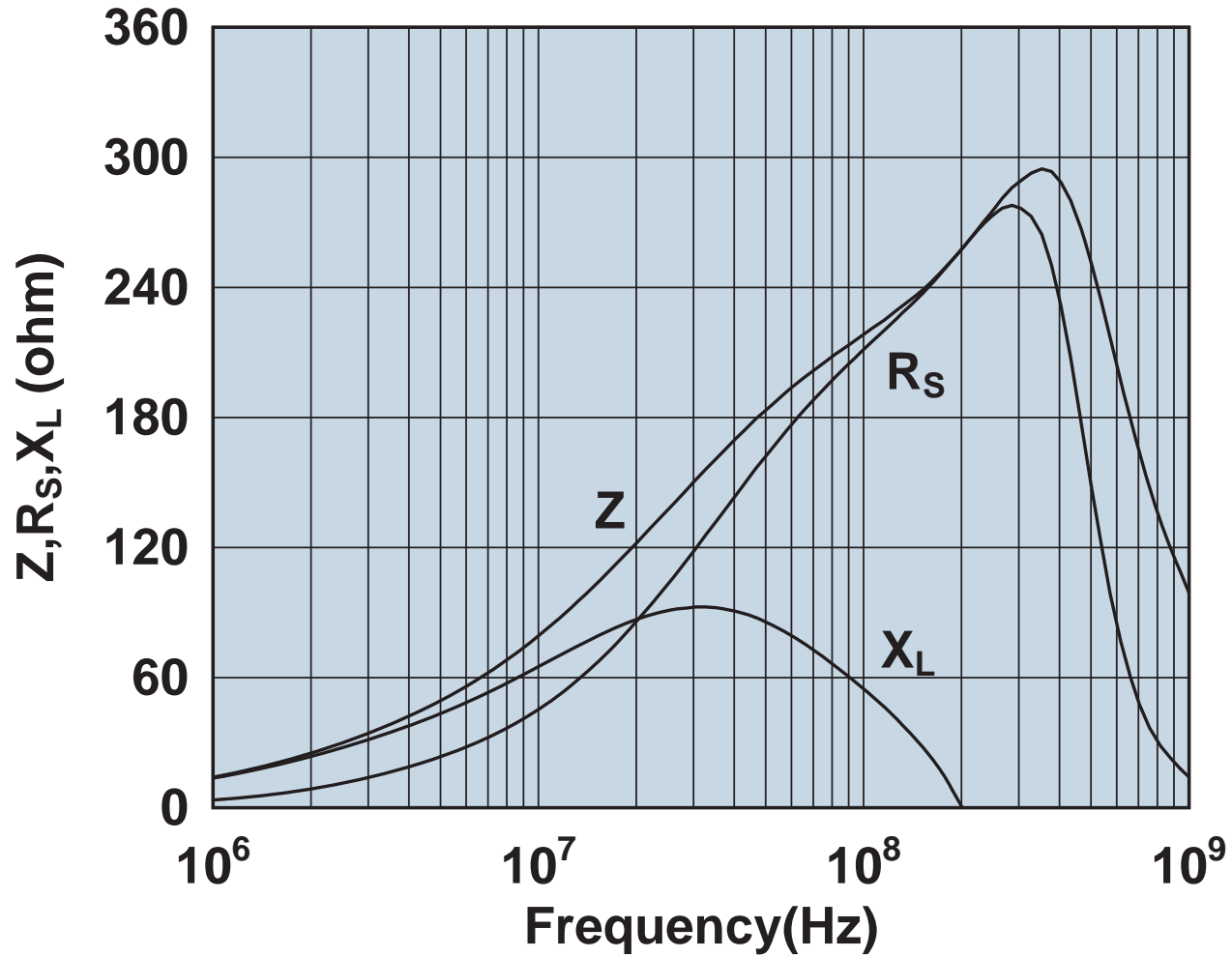

Impedance, reactance, and resistance vs. frequency.

2643167551

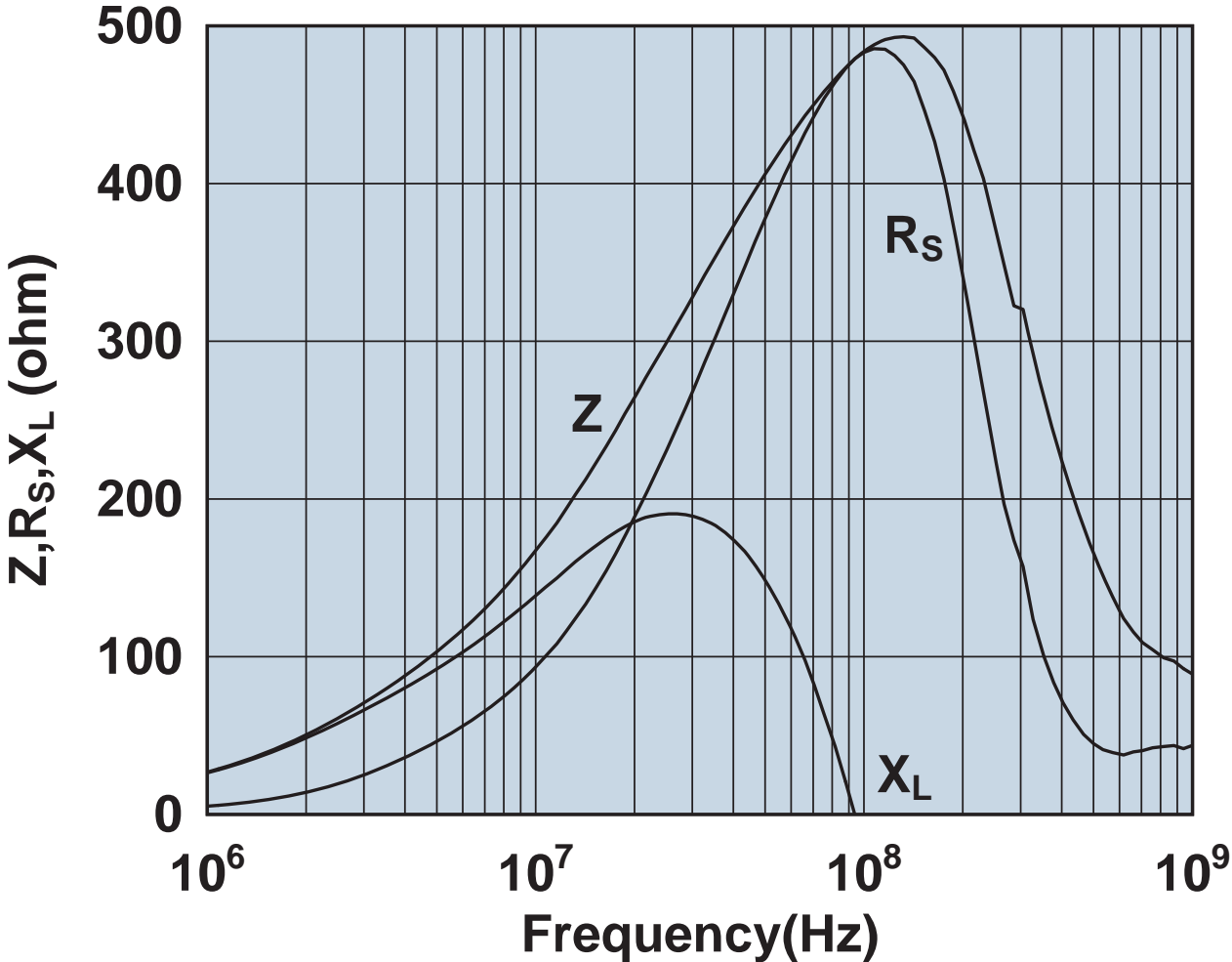

Impedance, reactance, and resistance vs. frequency.

2643167751

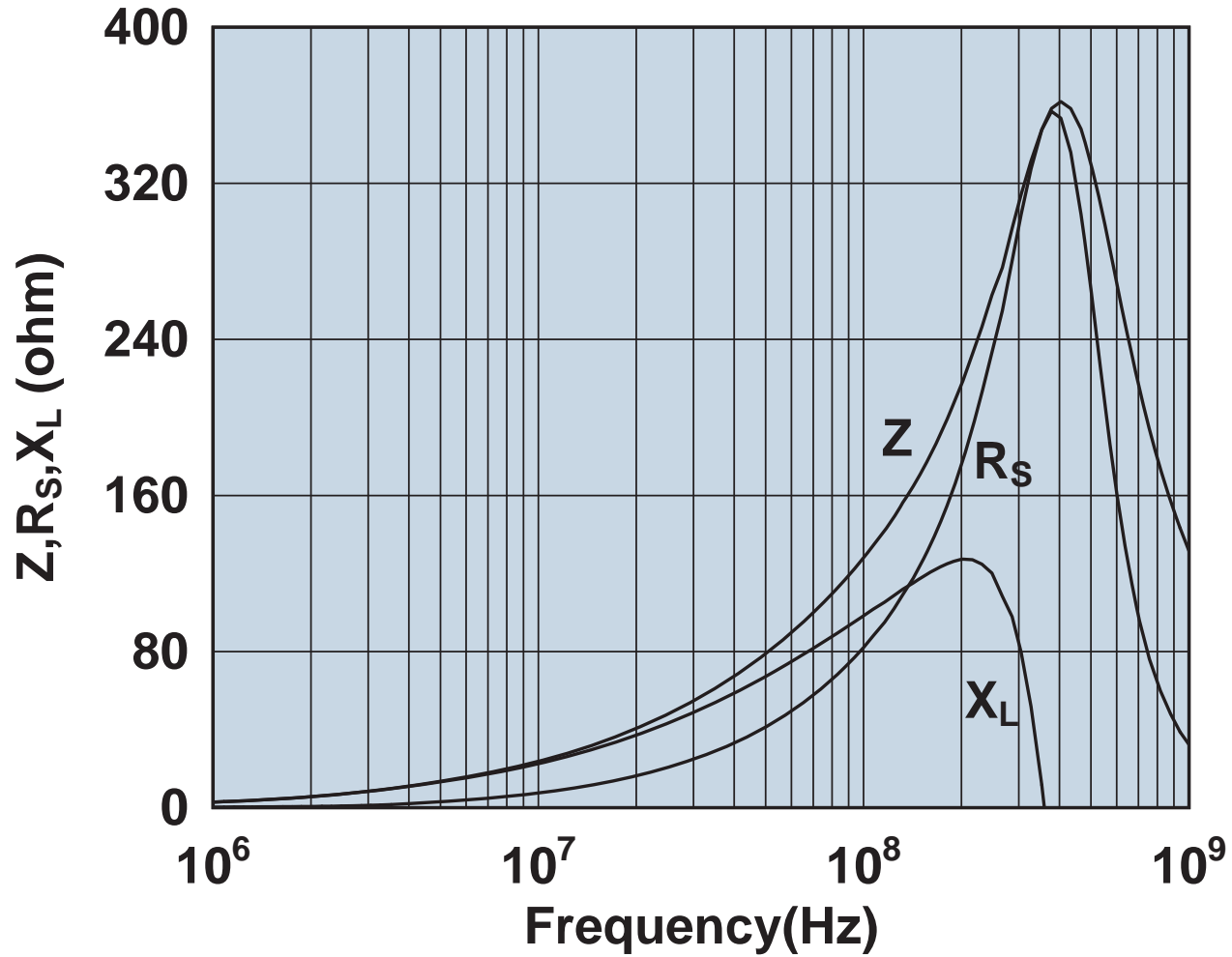

Impedance, reactance, and resistance vs. frequency.

2643167851

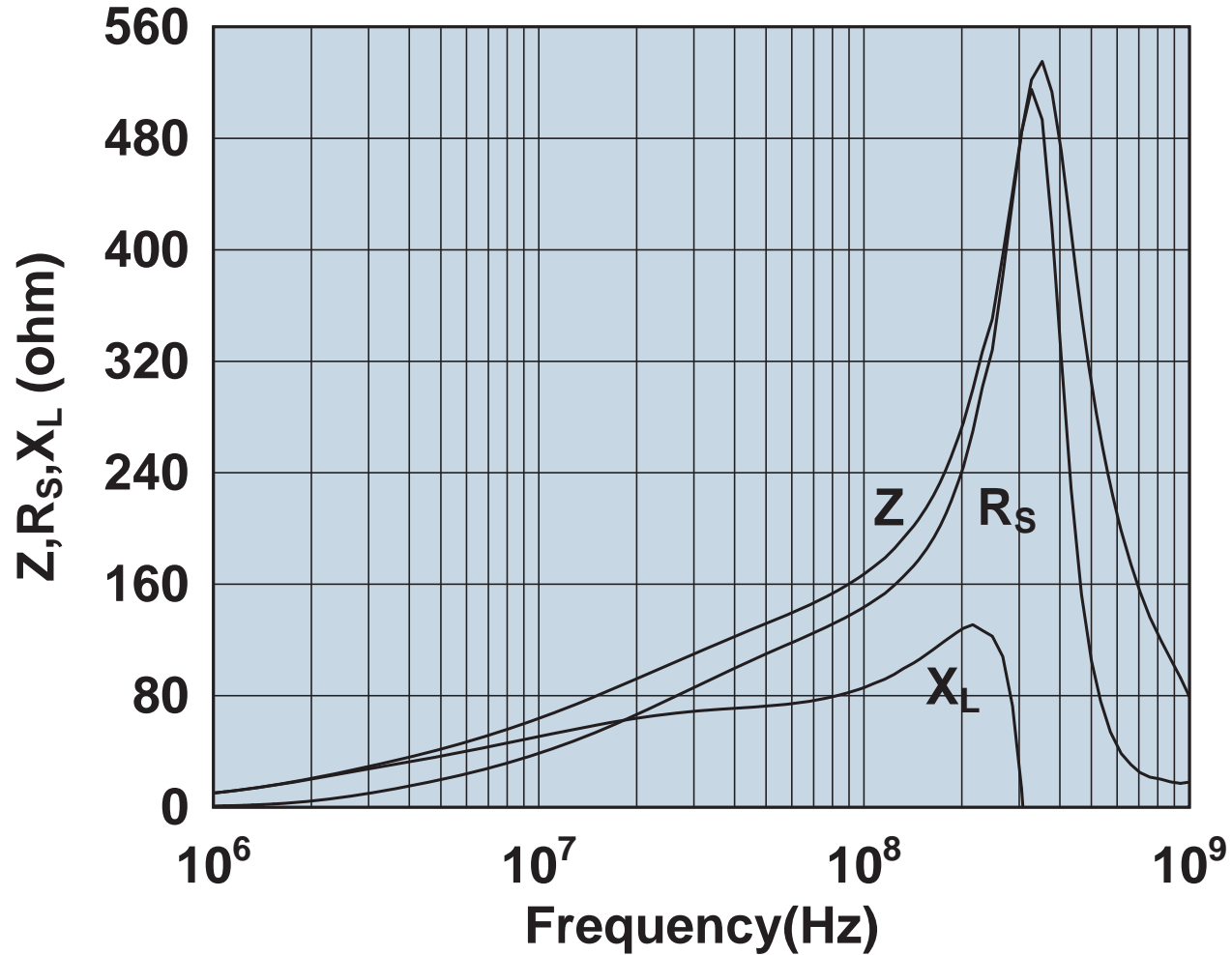

Impedance, reactance, and resistance vs. frequency.

2643168051

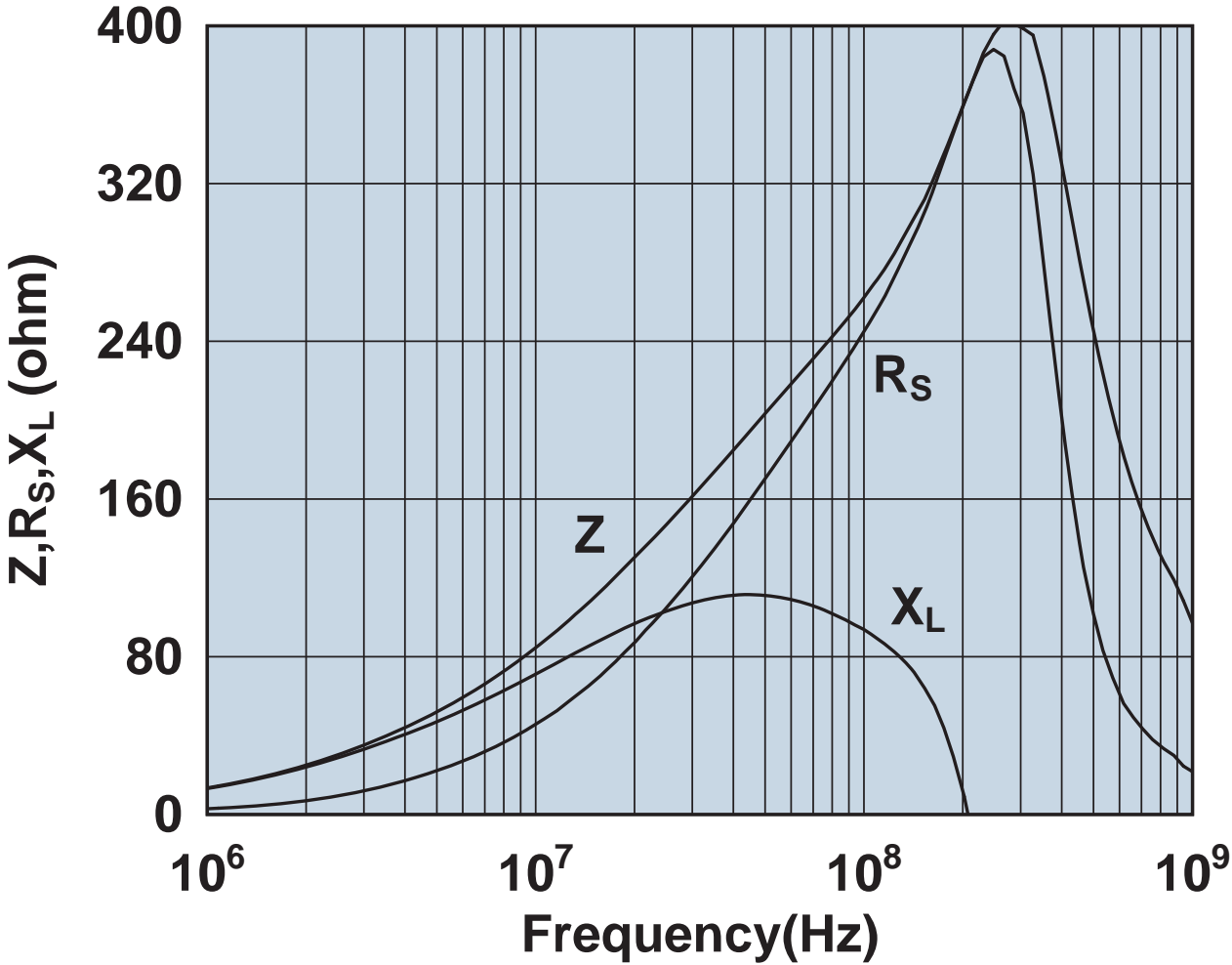

Impedance, reactance, and resistance vs. frequency.

2643168251

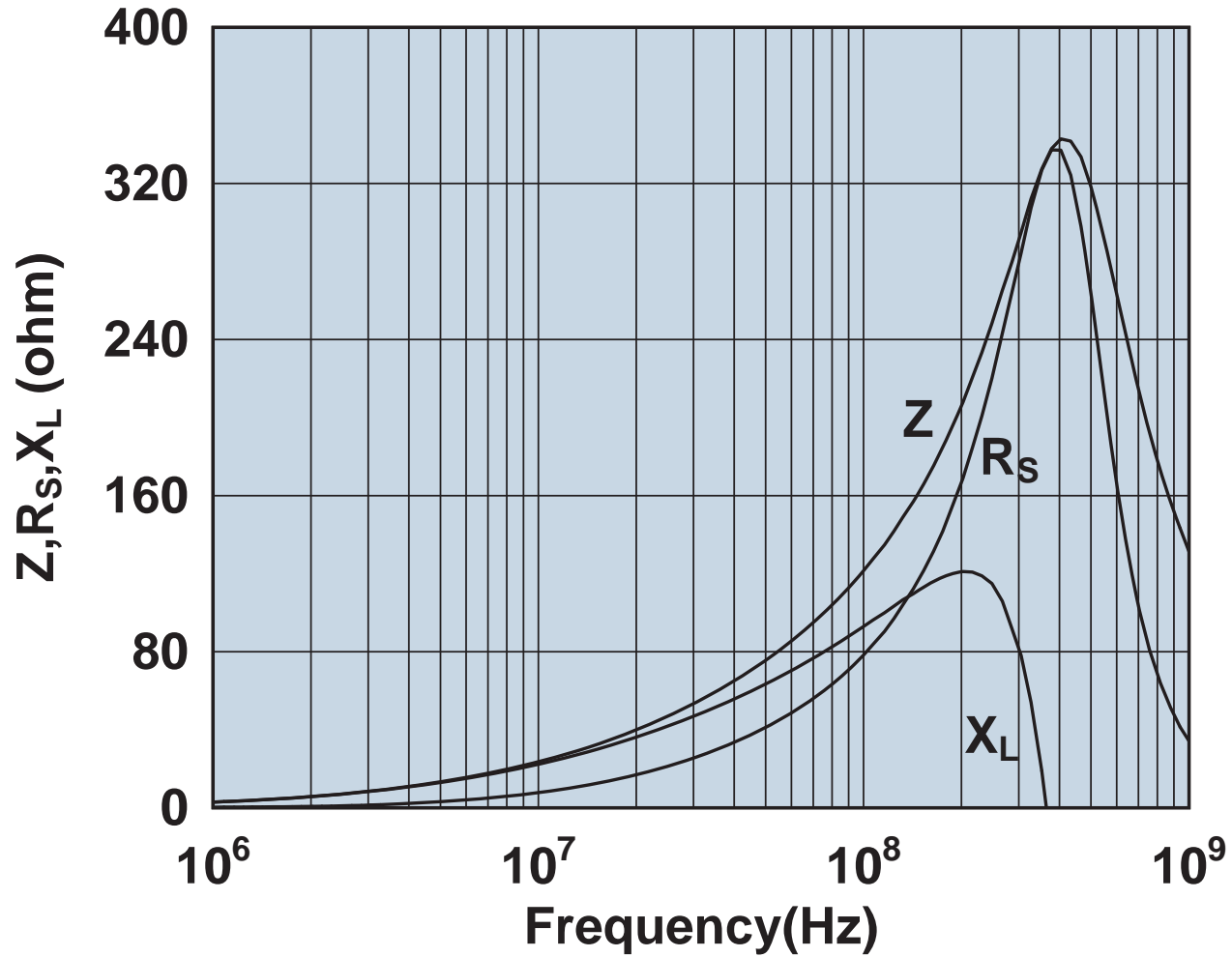

Impedance, reactance, and resistance vs. frequency.

2643168351

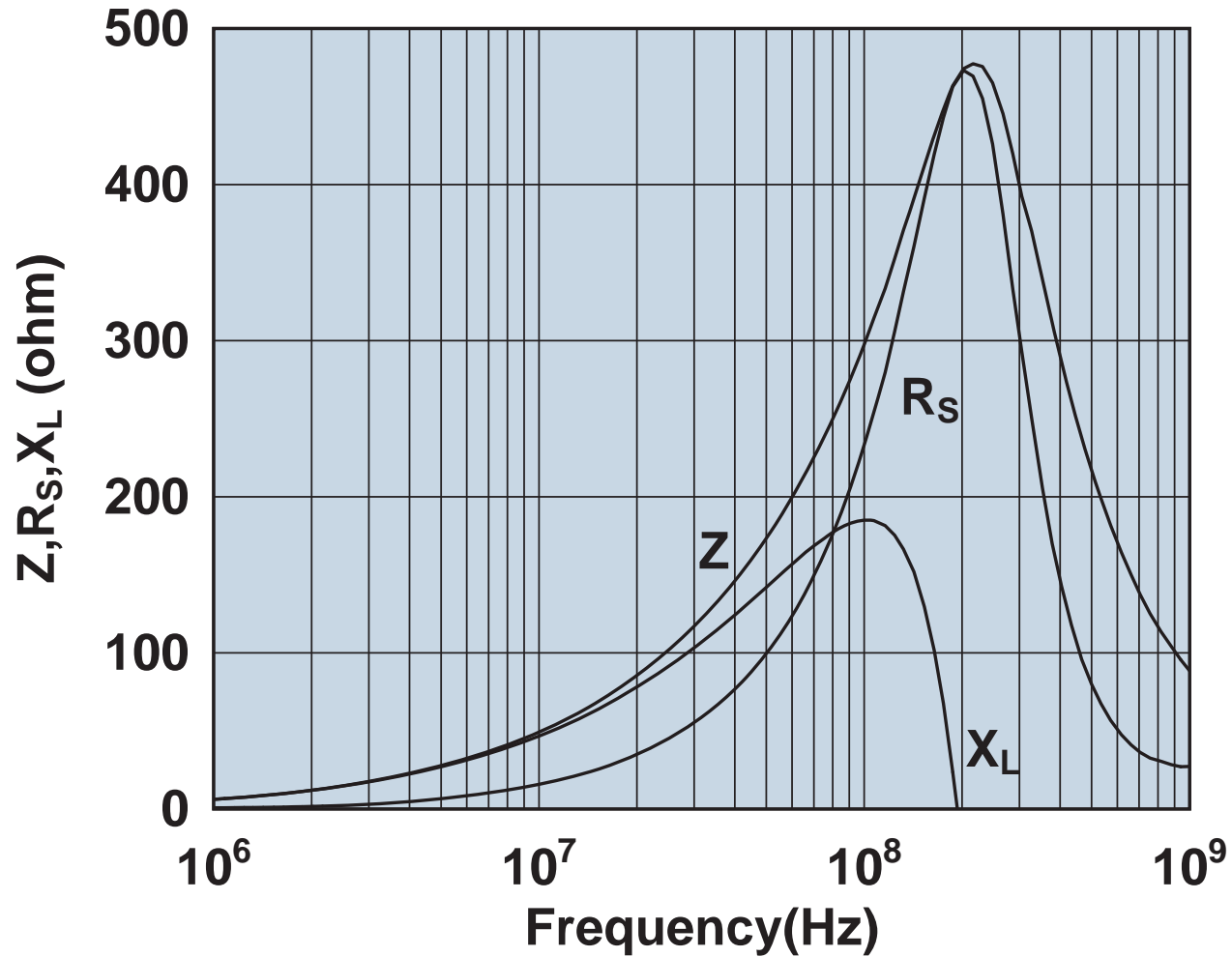

Impedance, reactance, and resistance vs. frequency.

2643168651

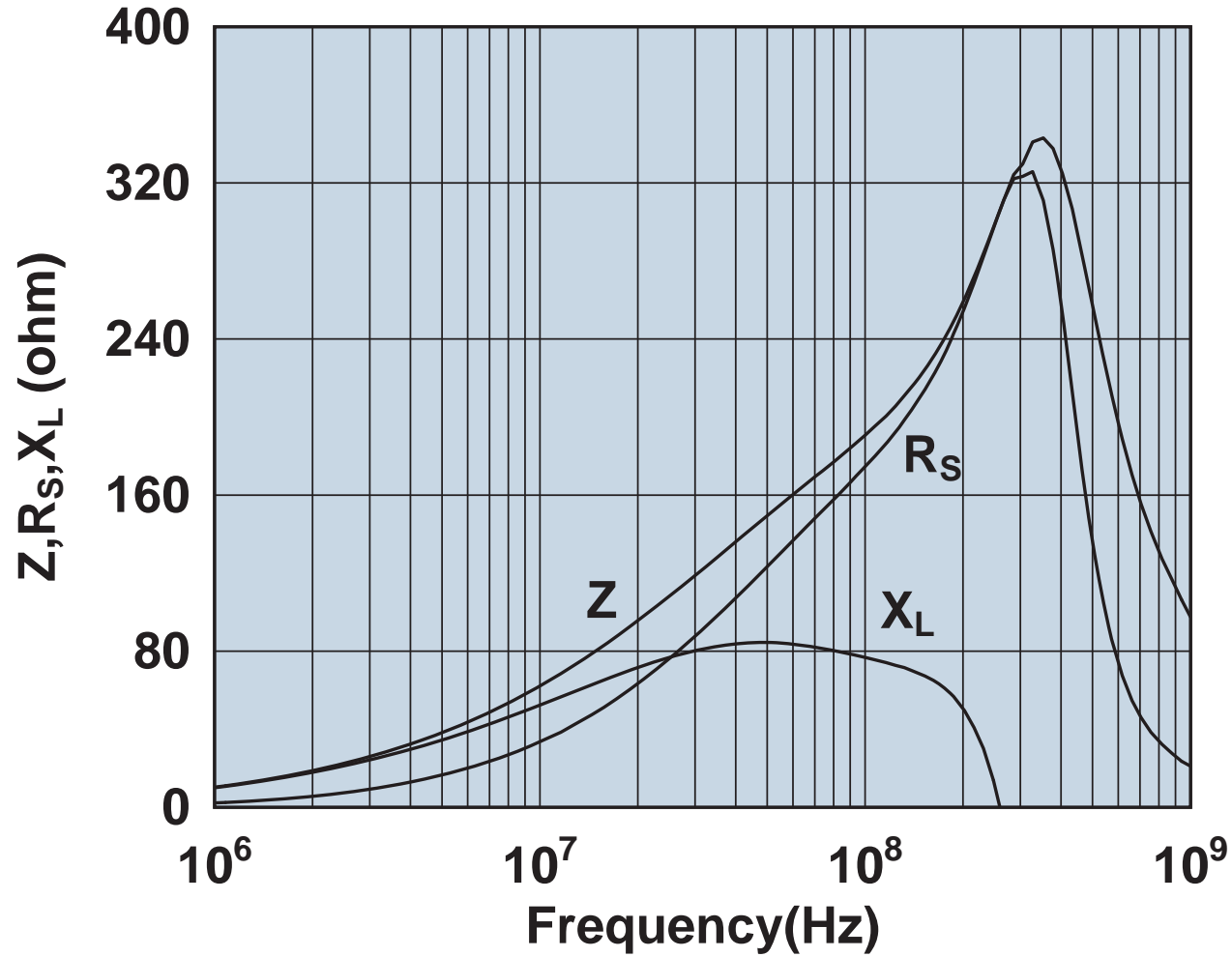

Impedance, reactance, and resistance vs. frequency.



2643168751

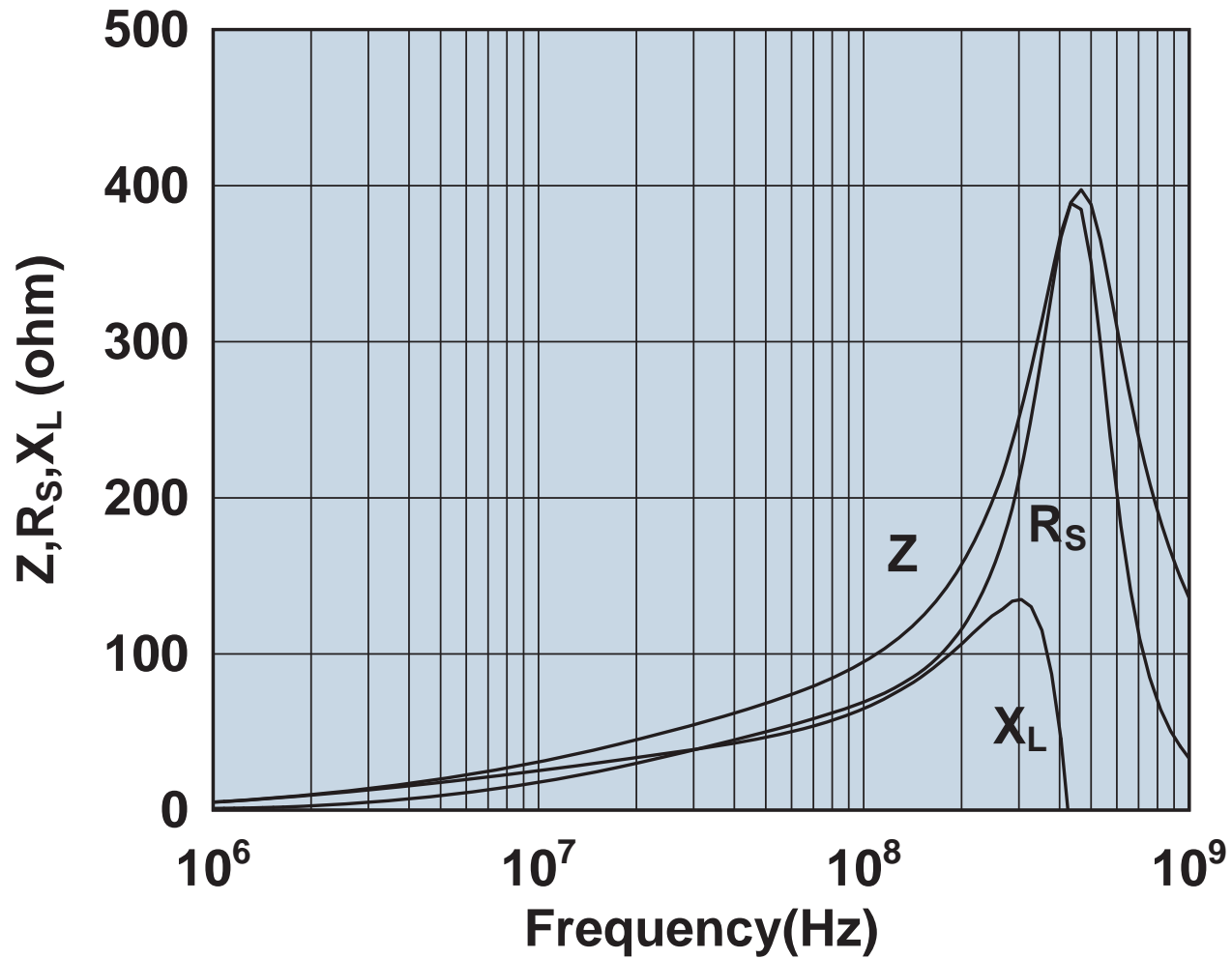

Impedance, reactance, and resistance vs. frequency.

2643169351

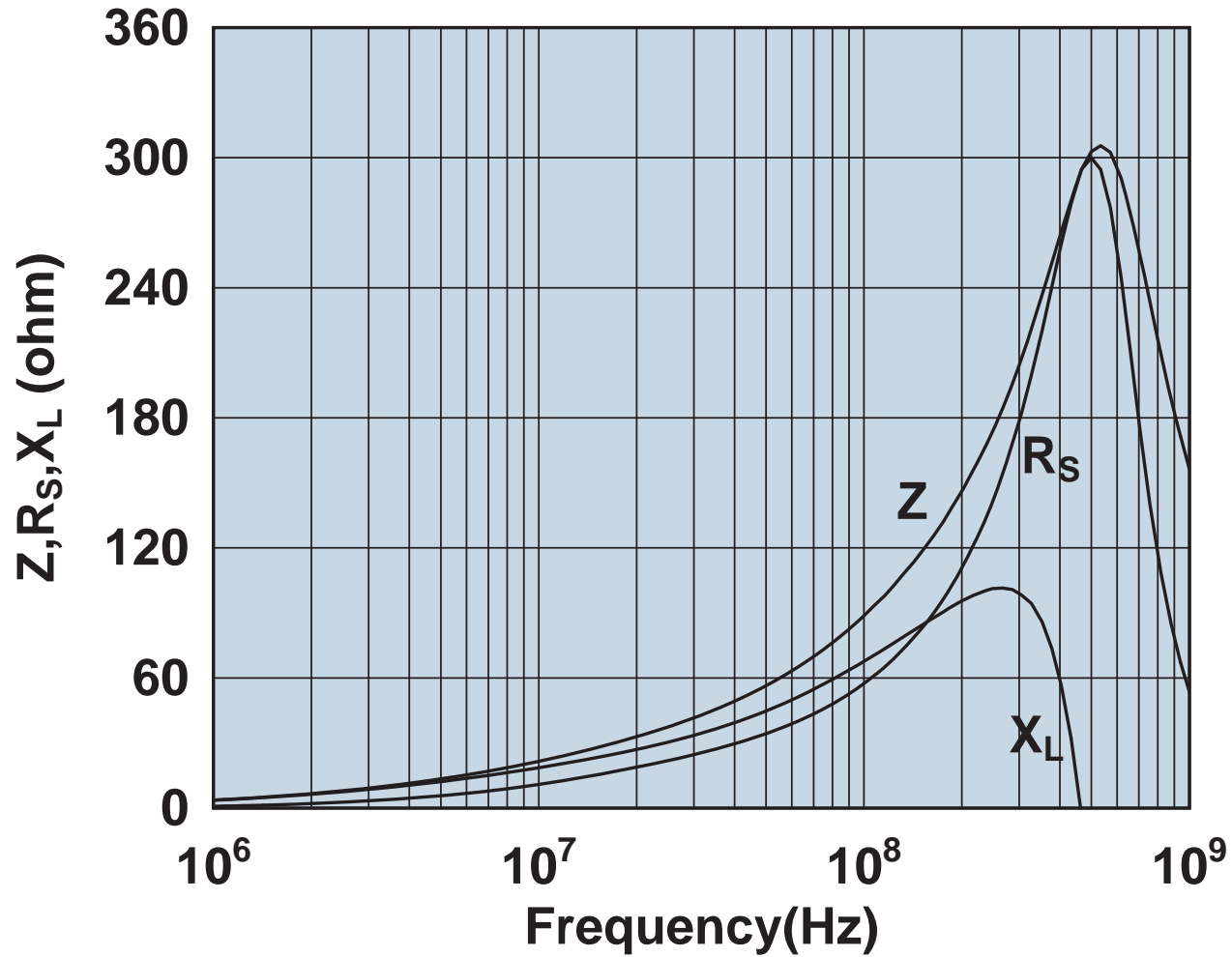

Impedance, reactance, and resistance vs. frequency.

2643169552

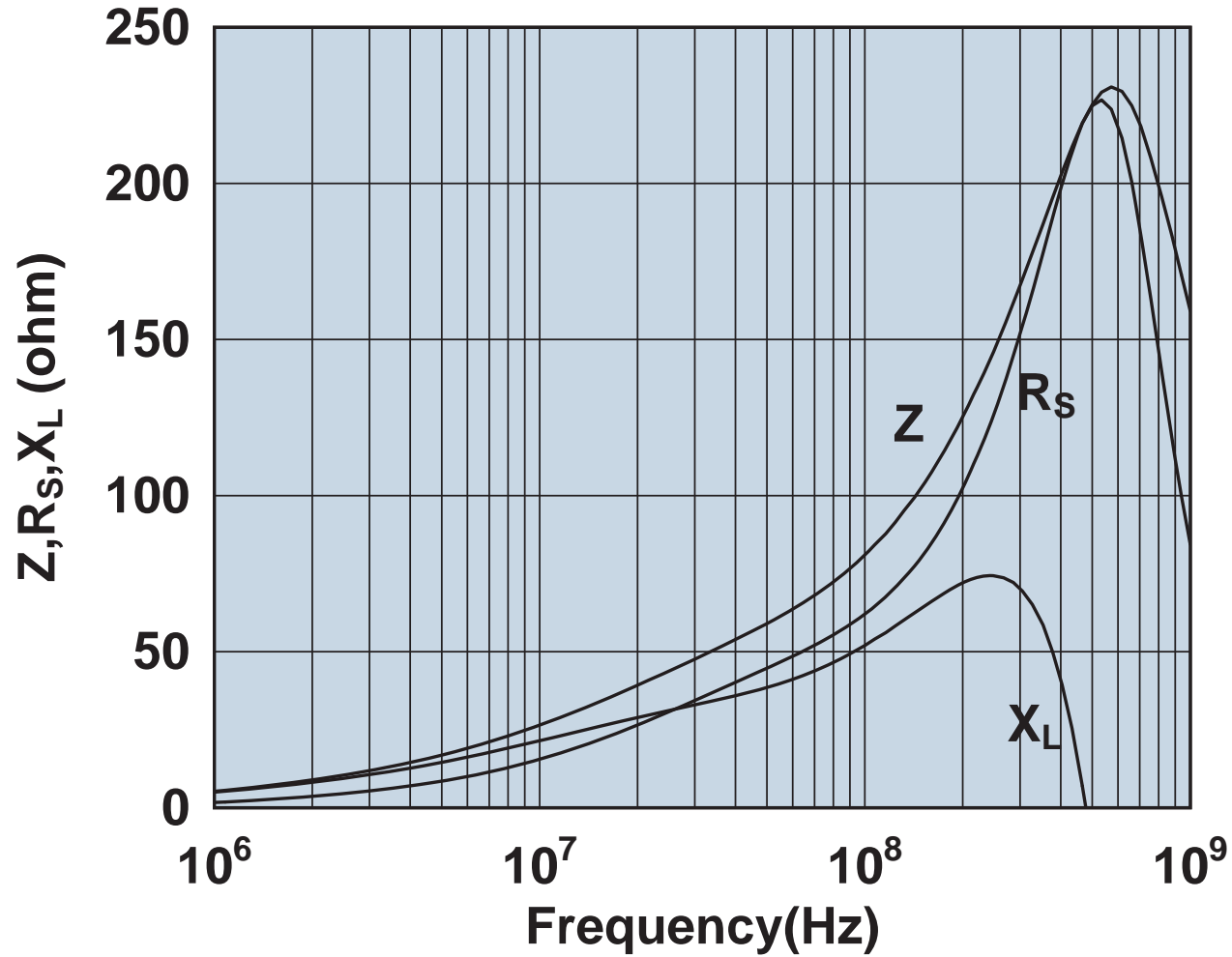

Impedance, reactance, and resistance vs. frequency.

2643170251

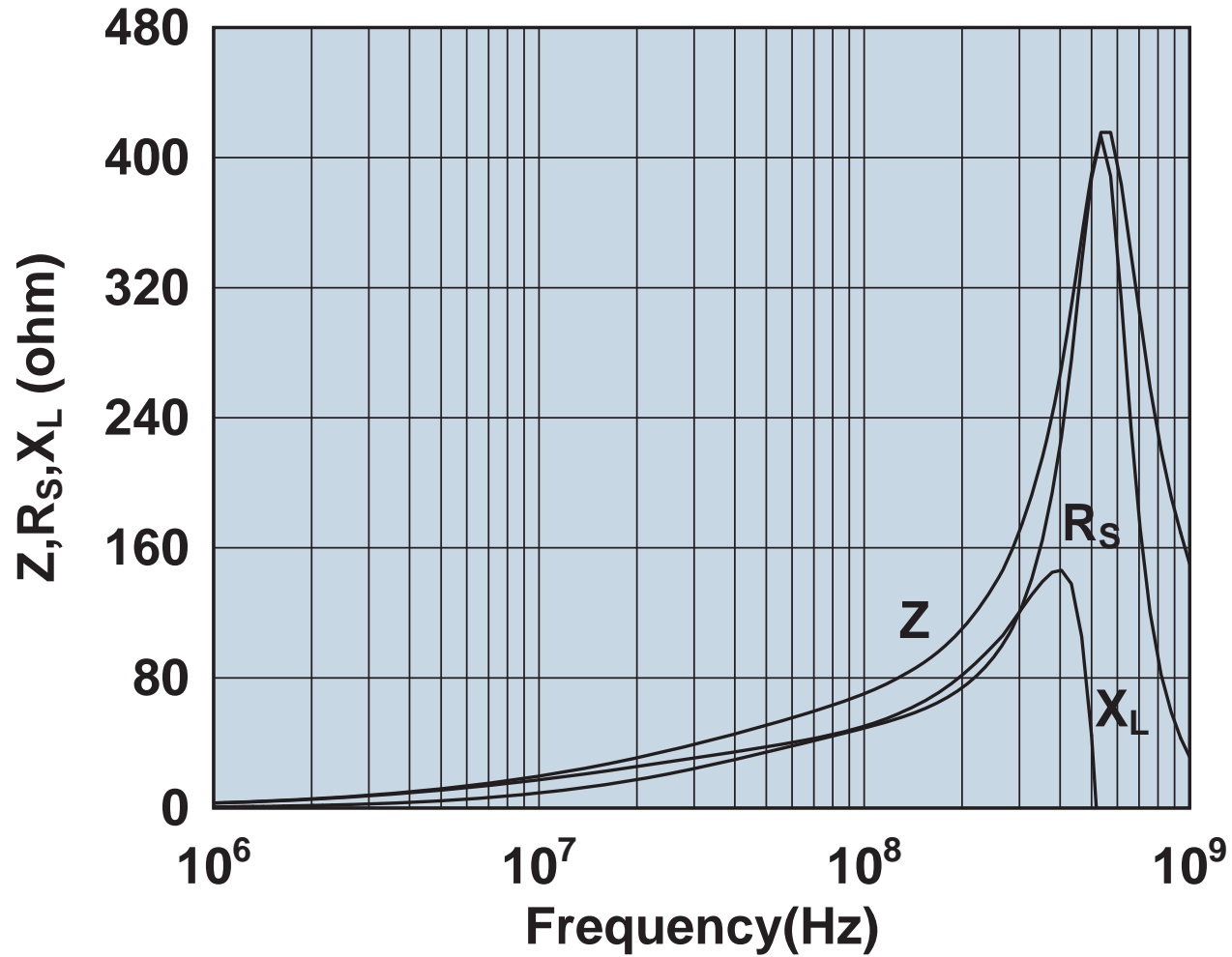

Impedance, reactance, and resistance vs. frequency.

2643170951

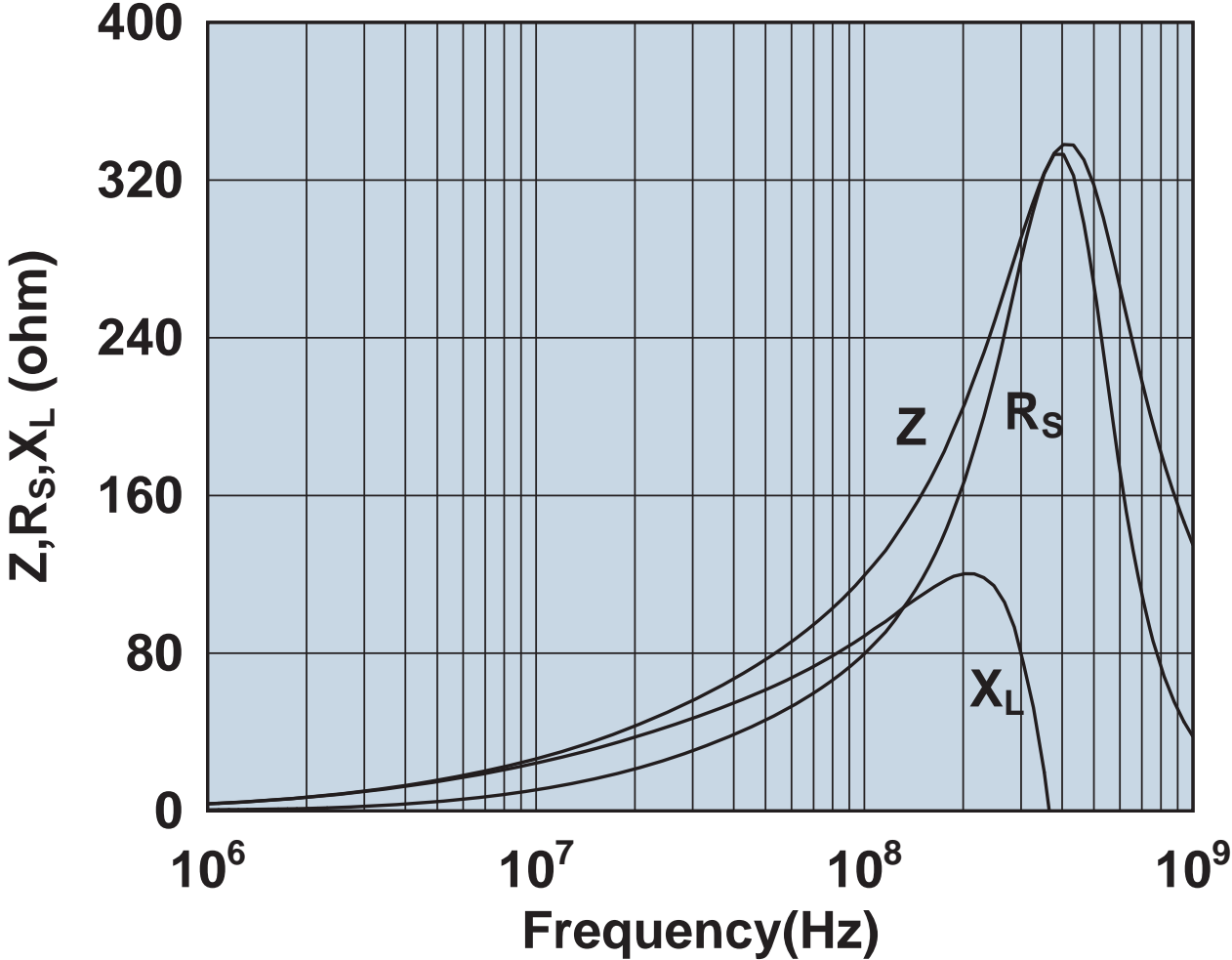

Impedance, reactance, and resistance vs. frequency.

2643171051

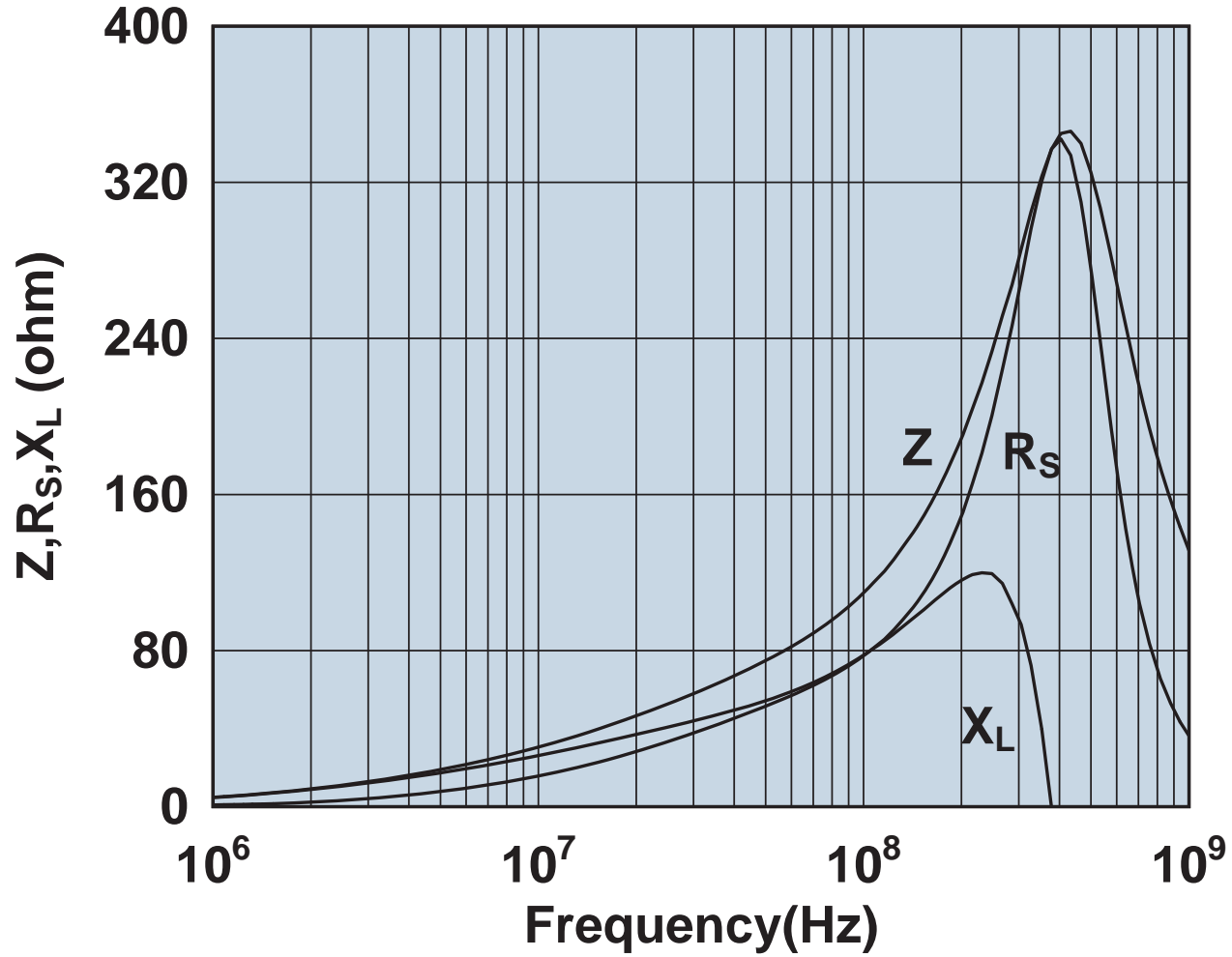

Impedance, reactance, and resistance vs. frequency.

2643172551

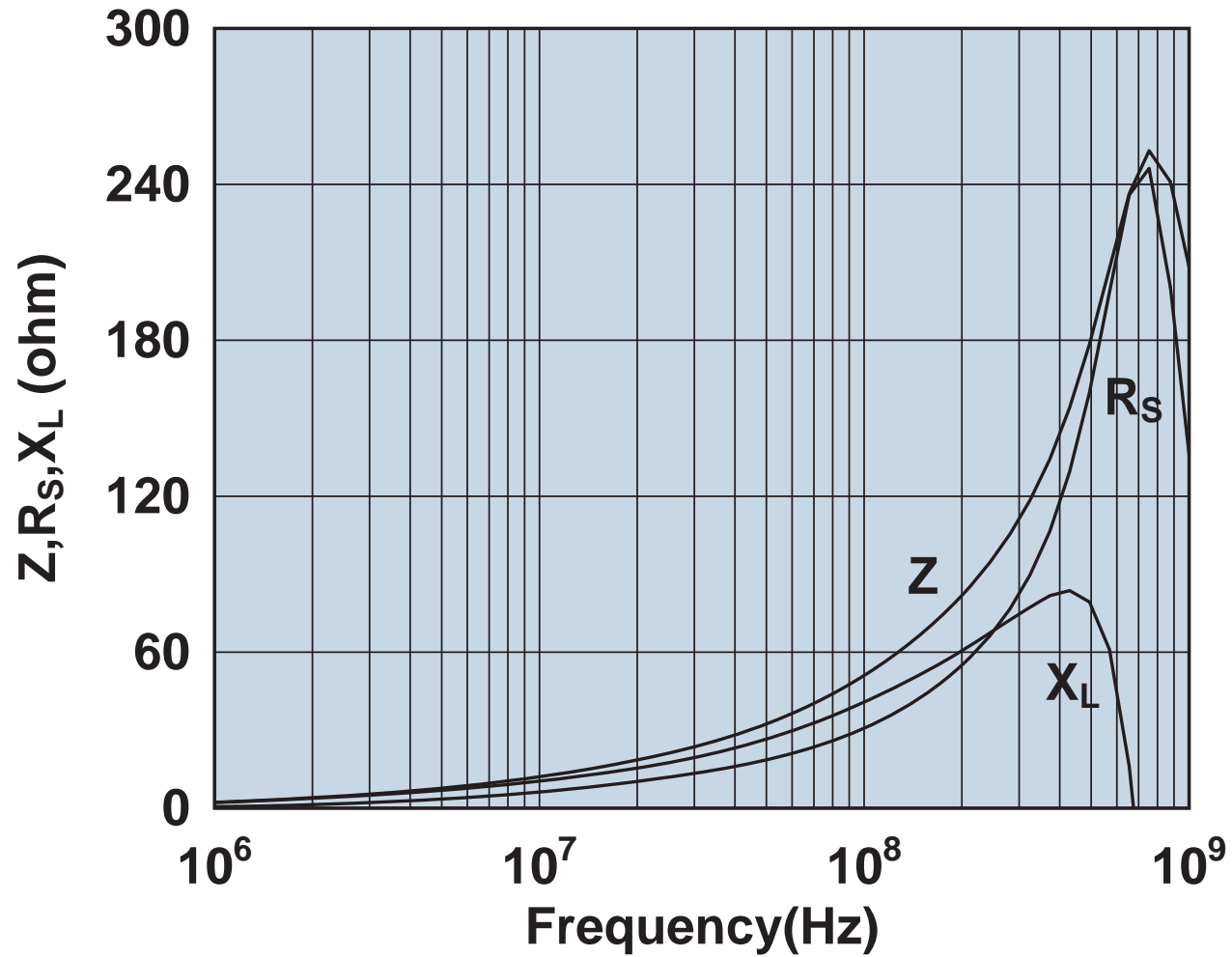

Impedance, reactance, and resistance vs. frequency.

2643173351

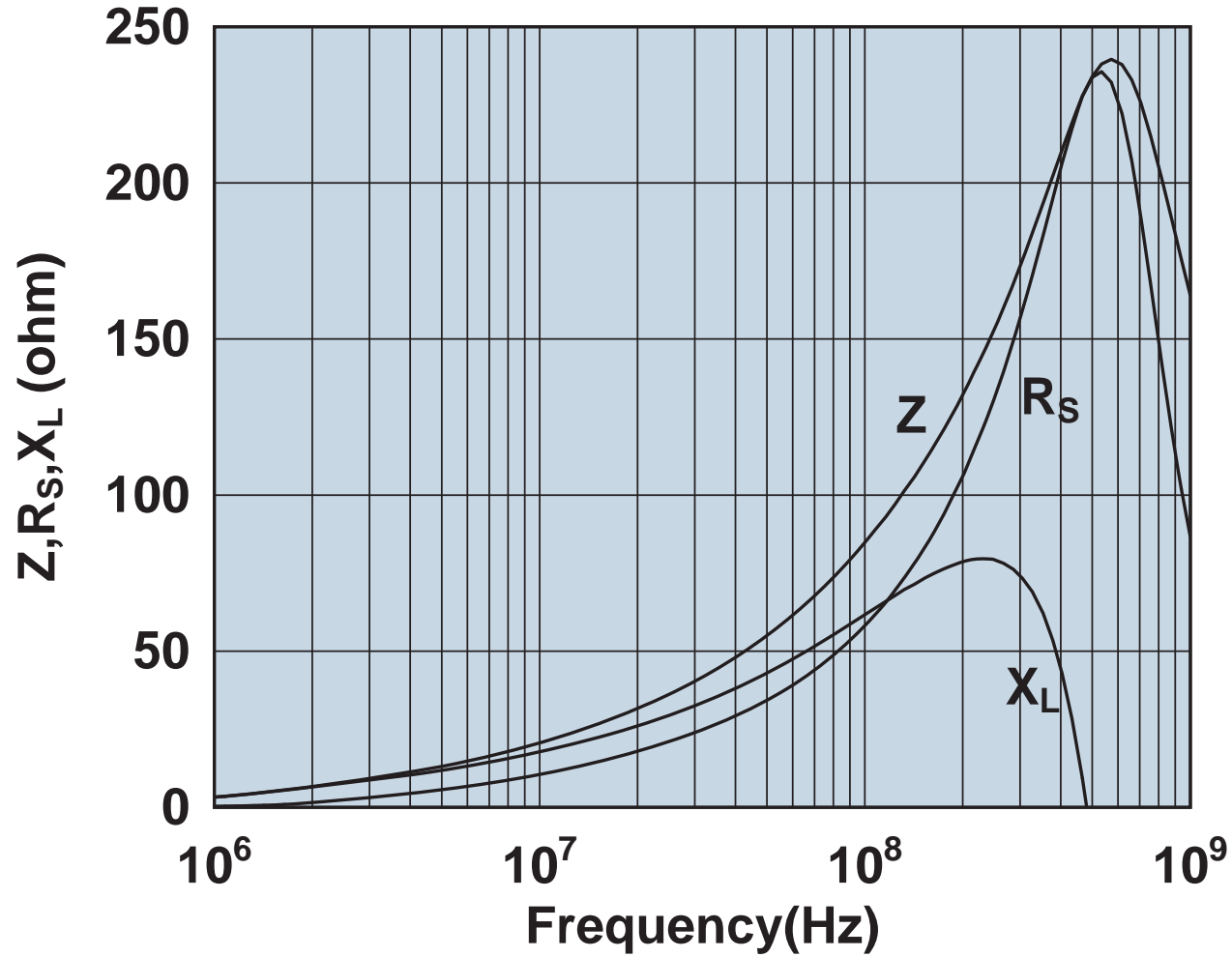

Impedance, reactance, and resistance vs. frequency.



2643175451

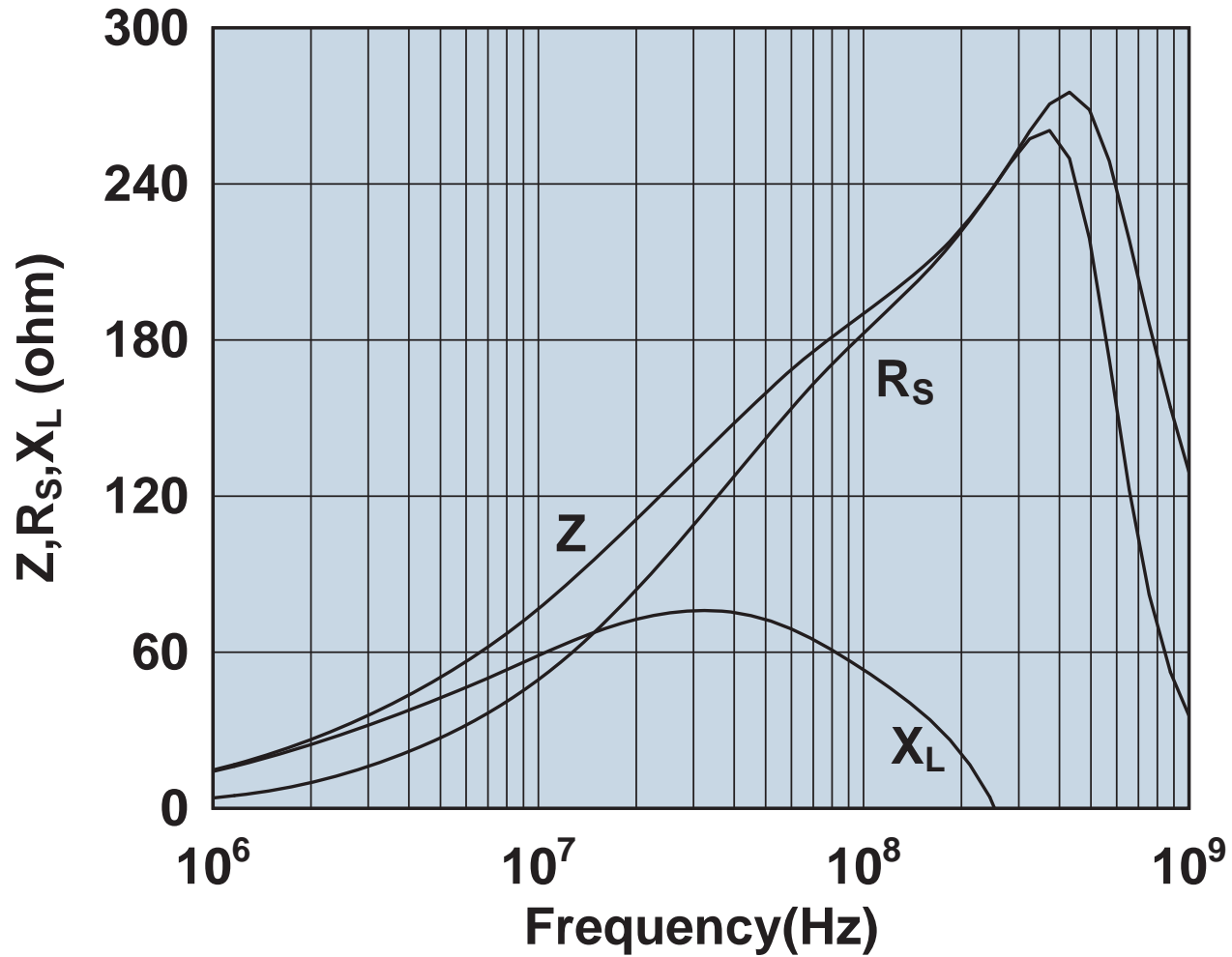

Impedance, reactance, and resistance vs. frequency.

2643178181

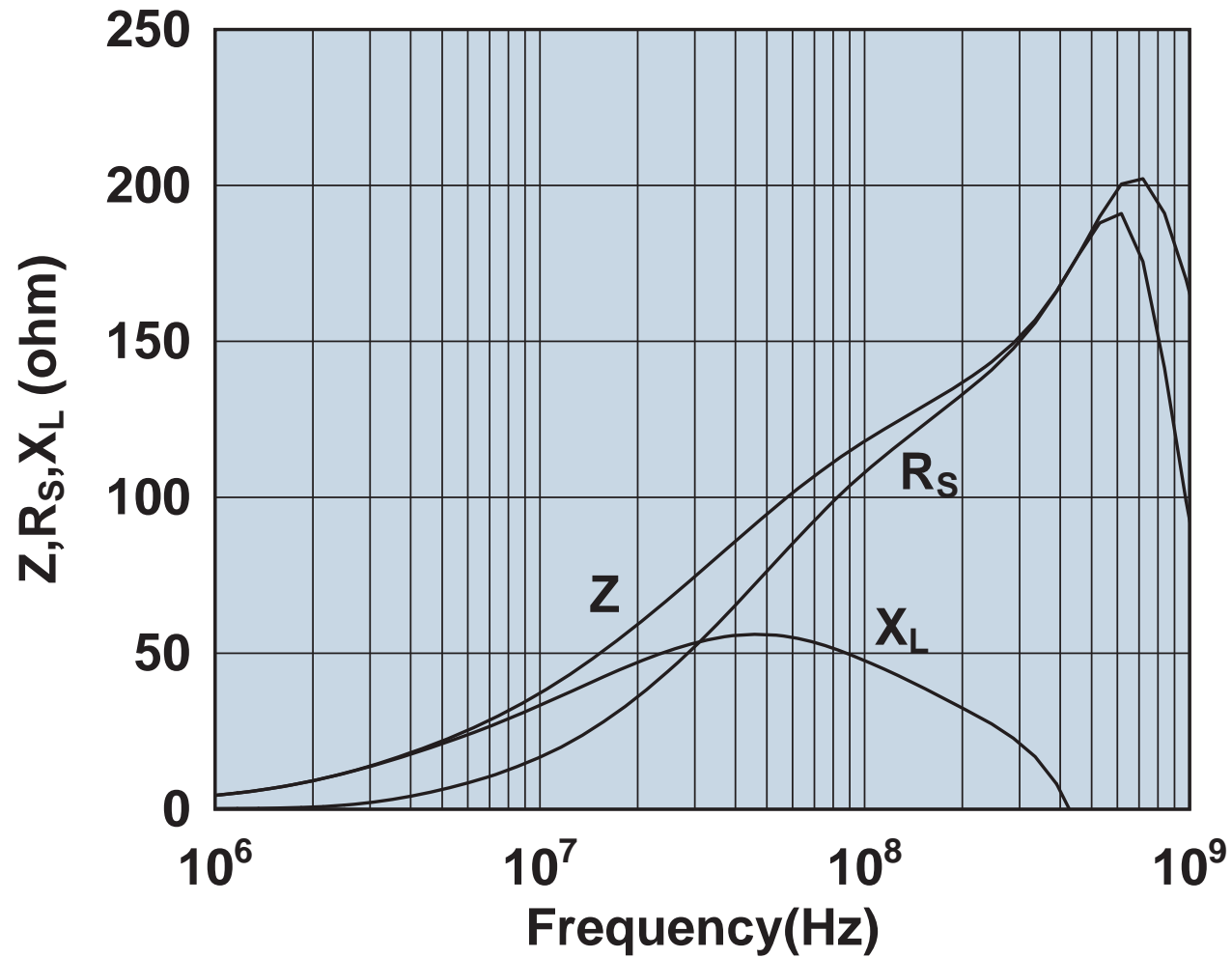

Impedance, reactance, and resistance vs. frequency.

2643178281

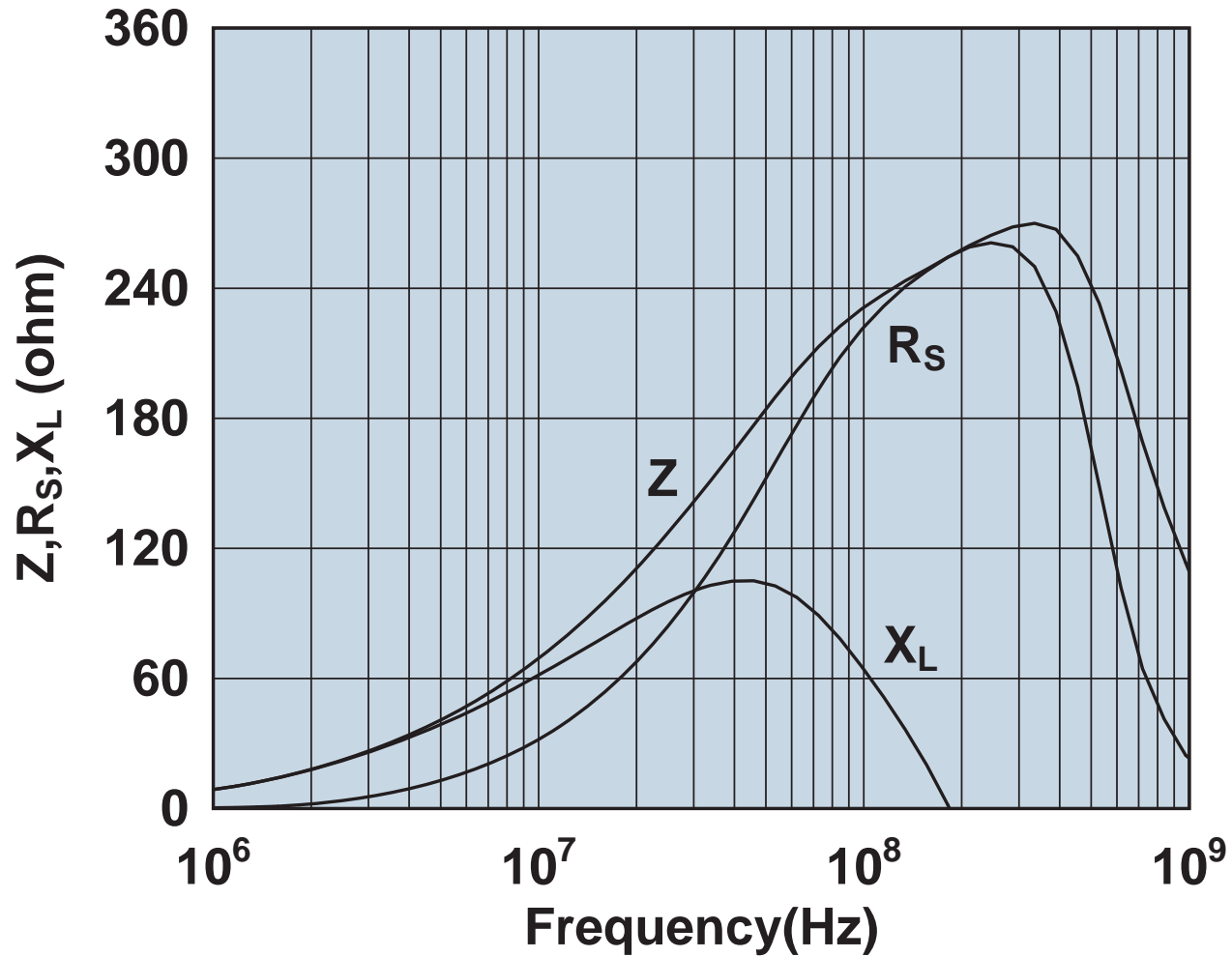

Impedance, reactance, and resistance vs. frequency.

2643178351

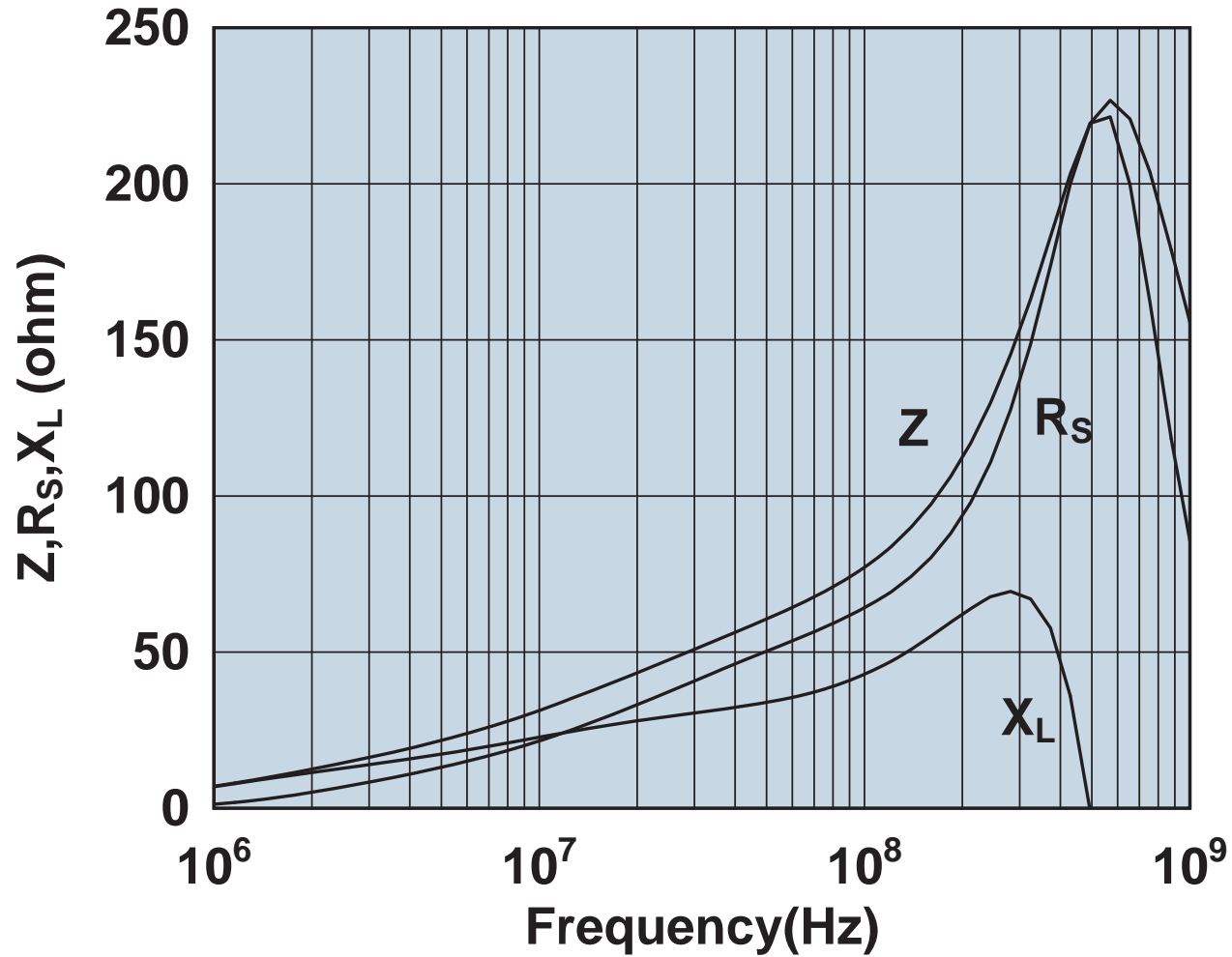

Impedance, reactance, and resistance vs. frequency.

2643178451

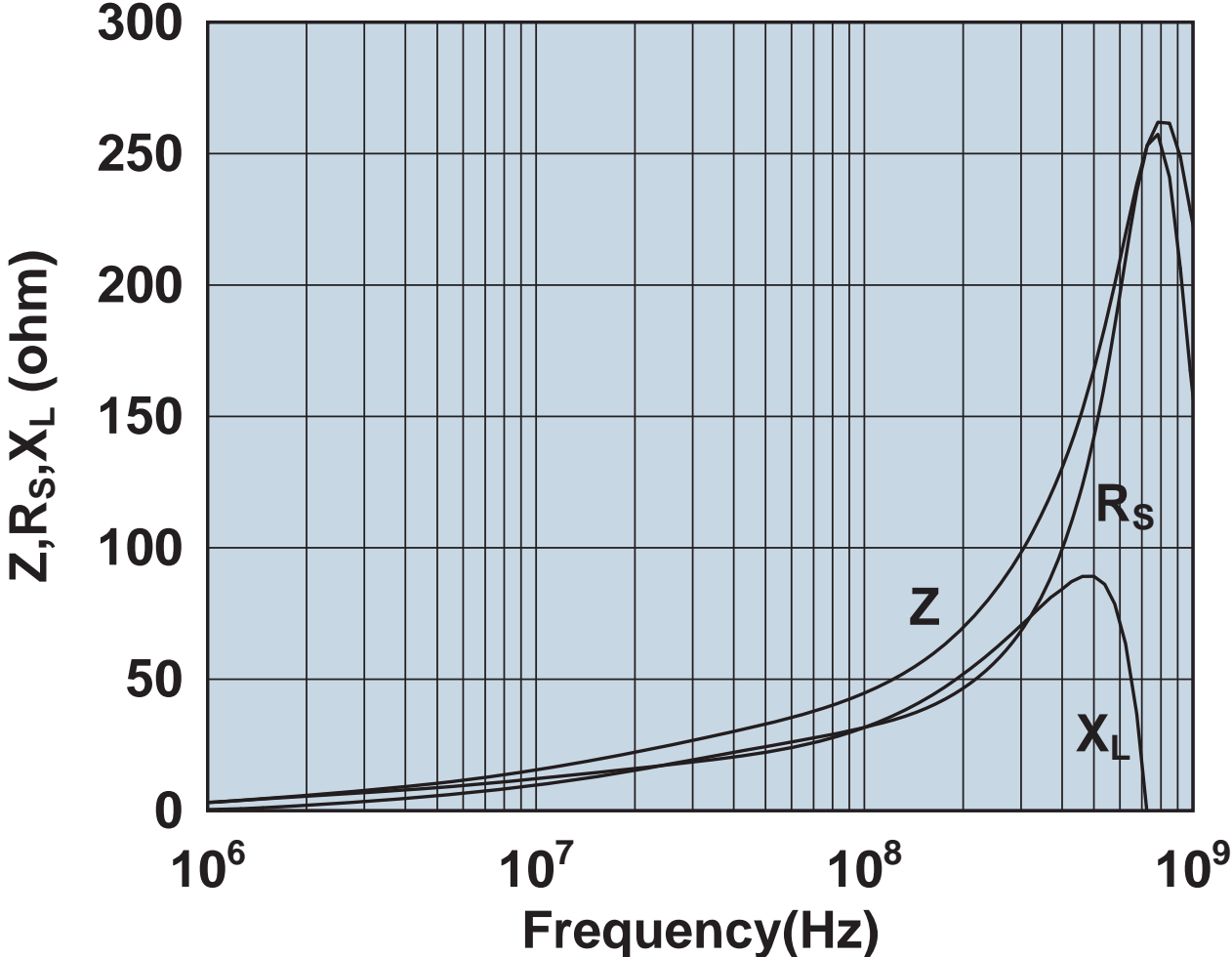

Impedance, reactance, and resistance vs. frequency.

2643178551

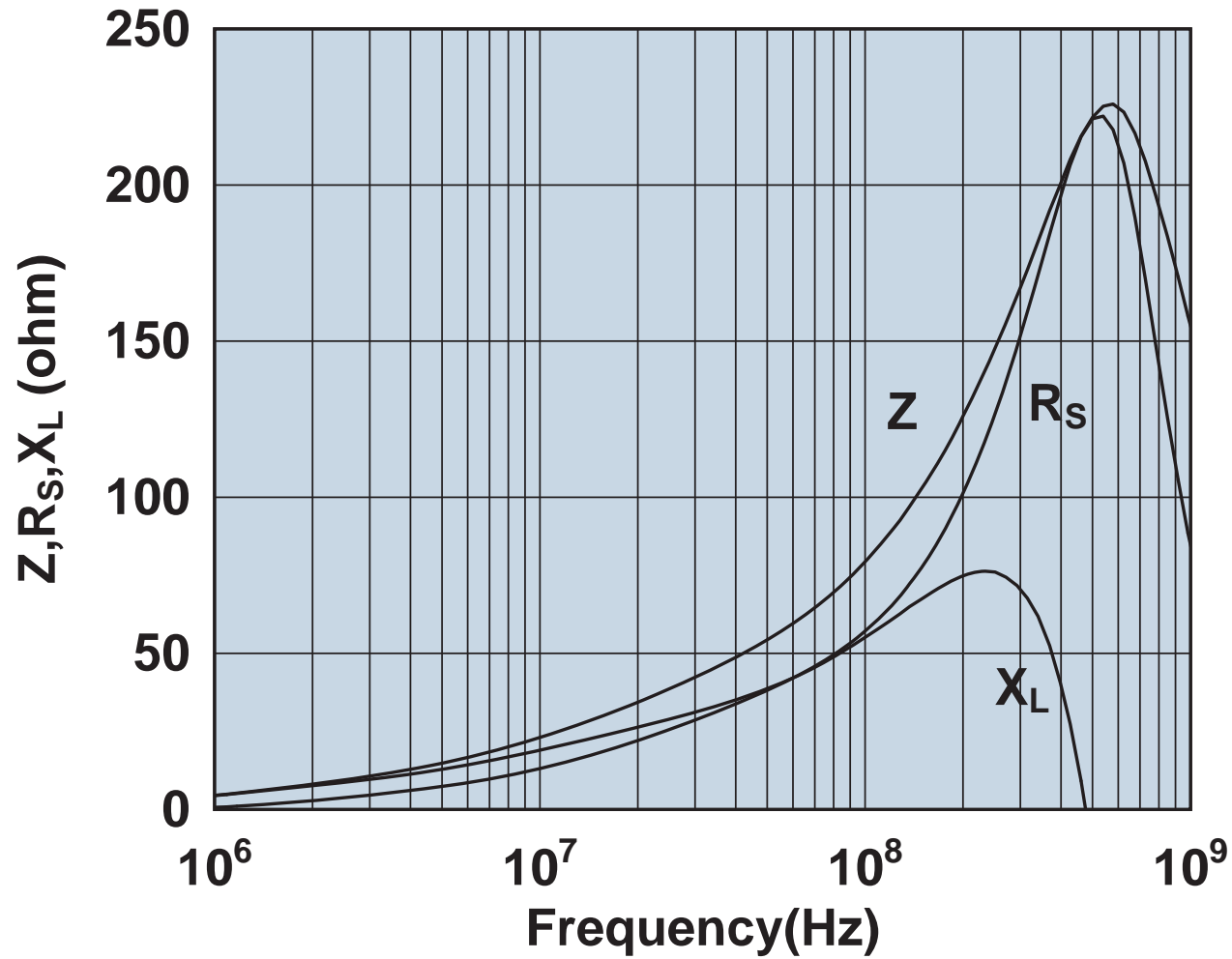

Impedance, reactance, and resistance vs. frequency.

2643178651

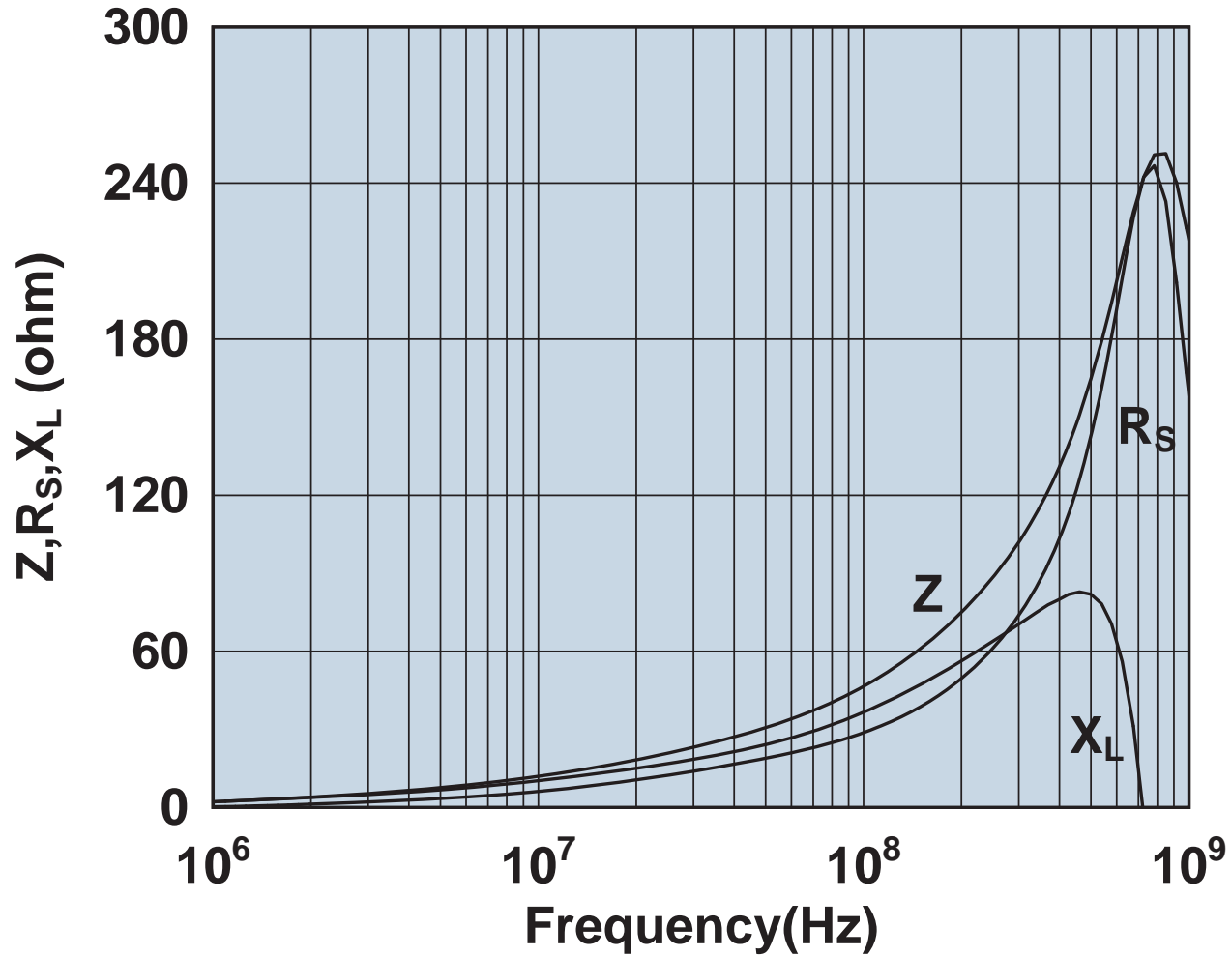

Impedance, reactance, and resistance vs. frequency.

2643178751

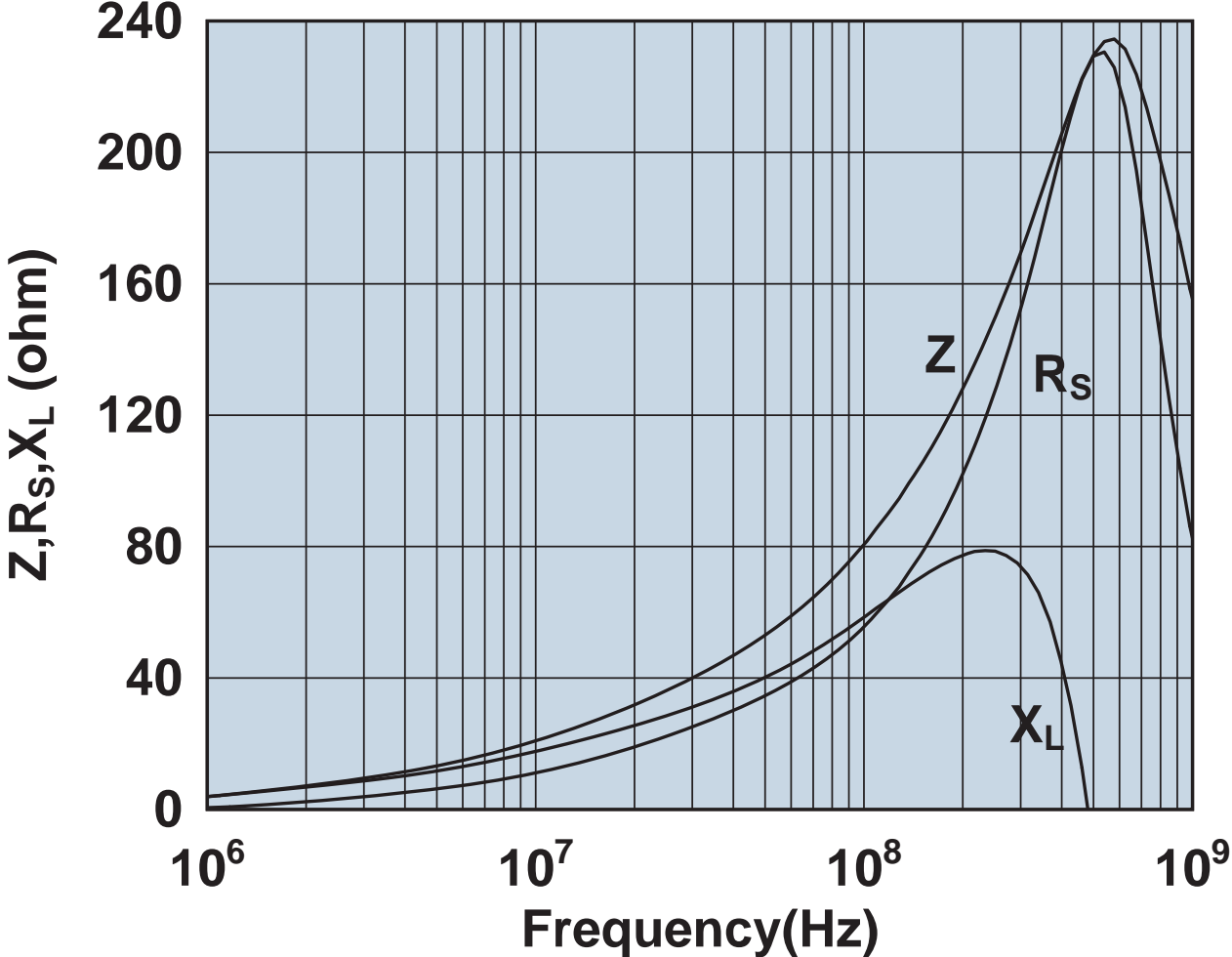

Impedance, reactance, and resistance vs. frequency.



2643178851

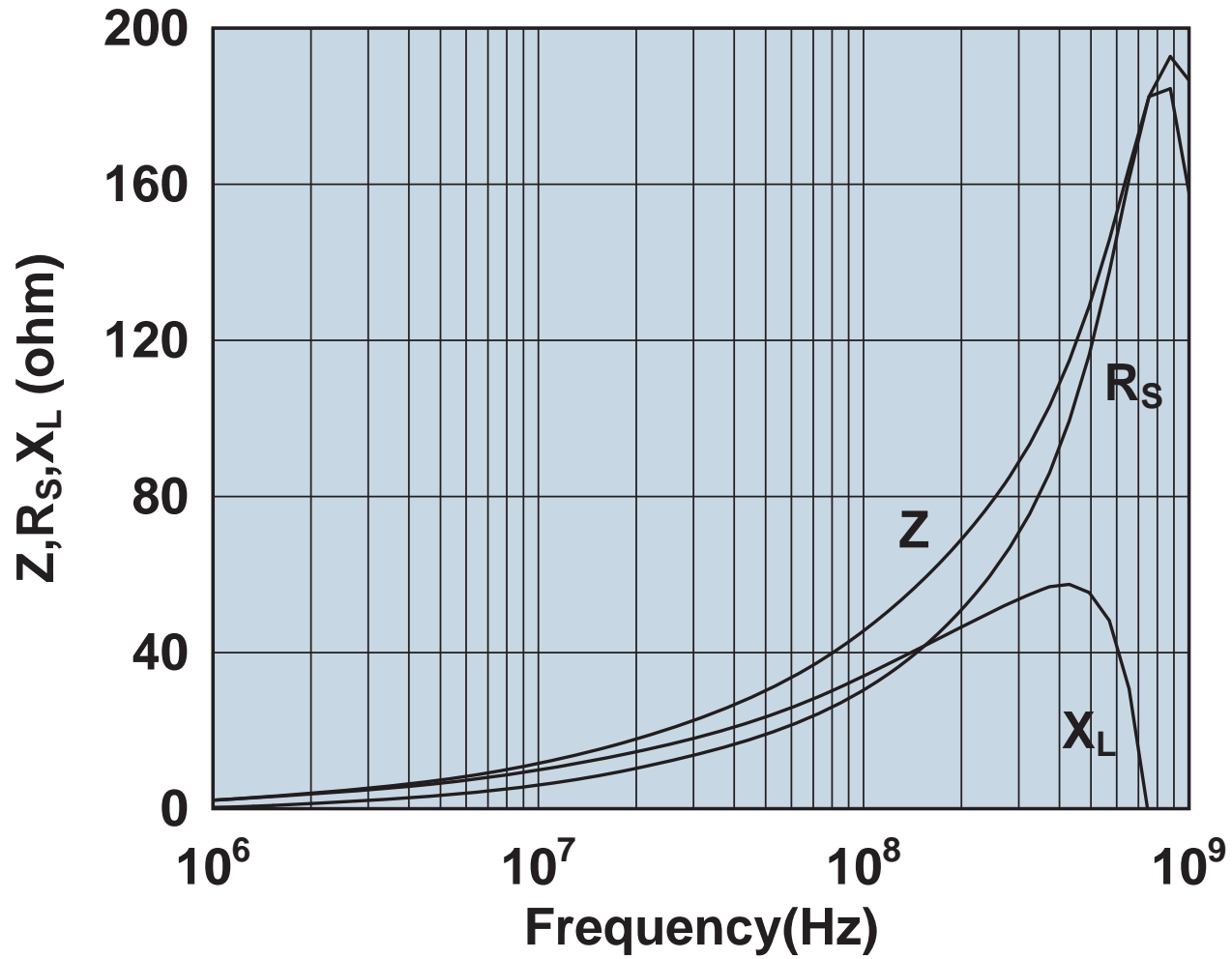

Impedance, reactance, and resistance vs. frequency.

2643251002

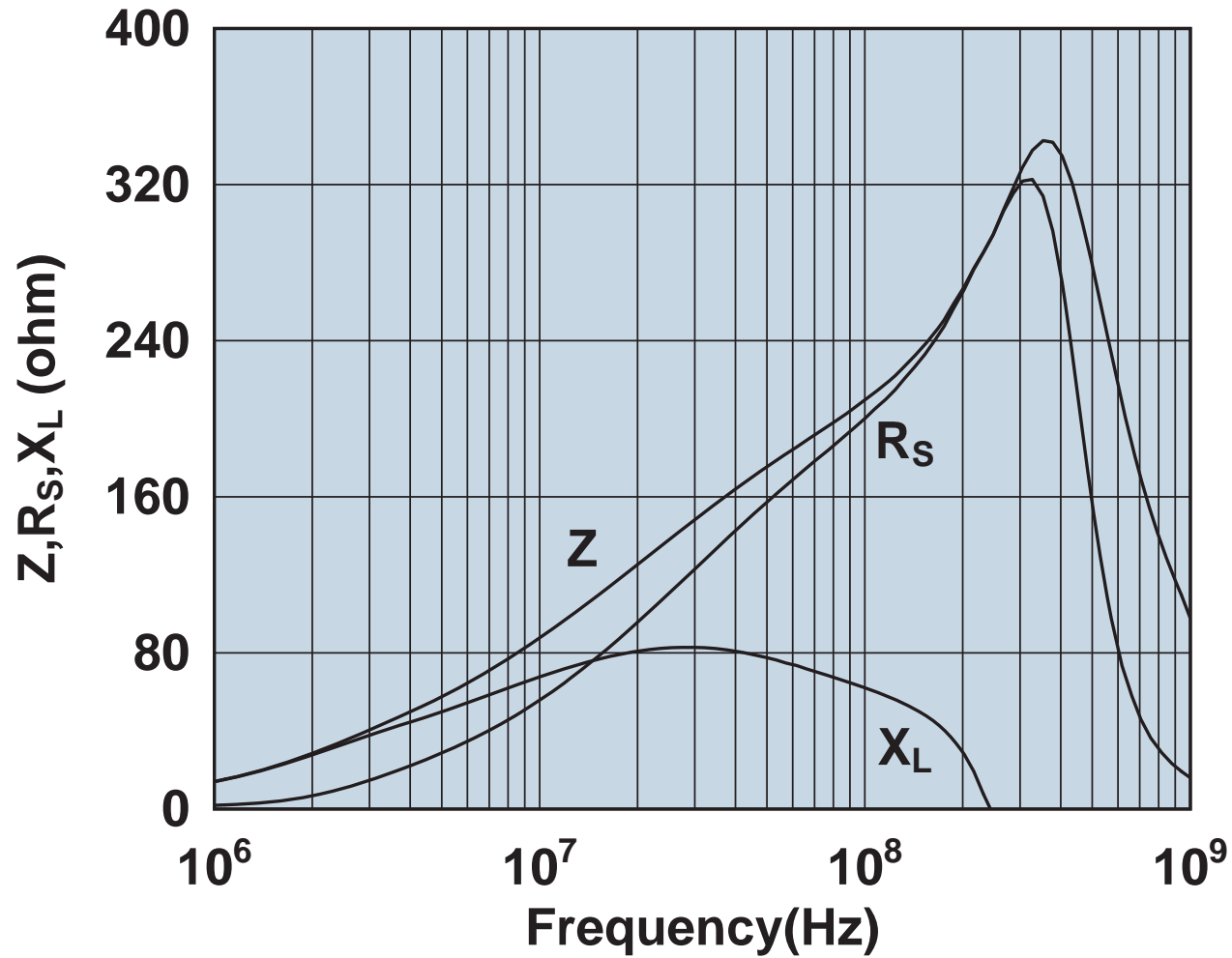

Impedance, reactance, and resistance vs. frequency.

2643480002

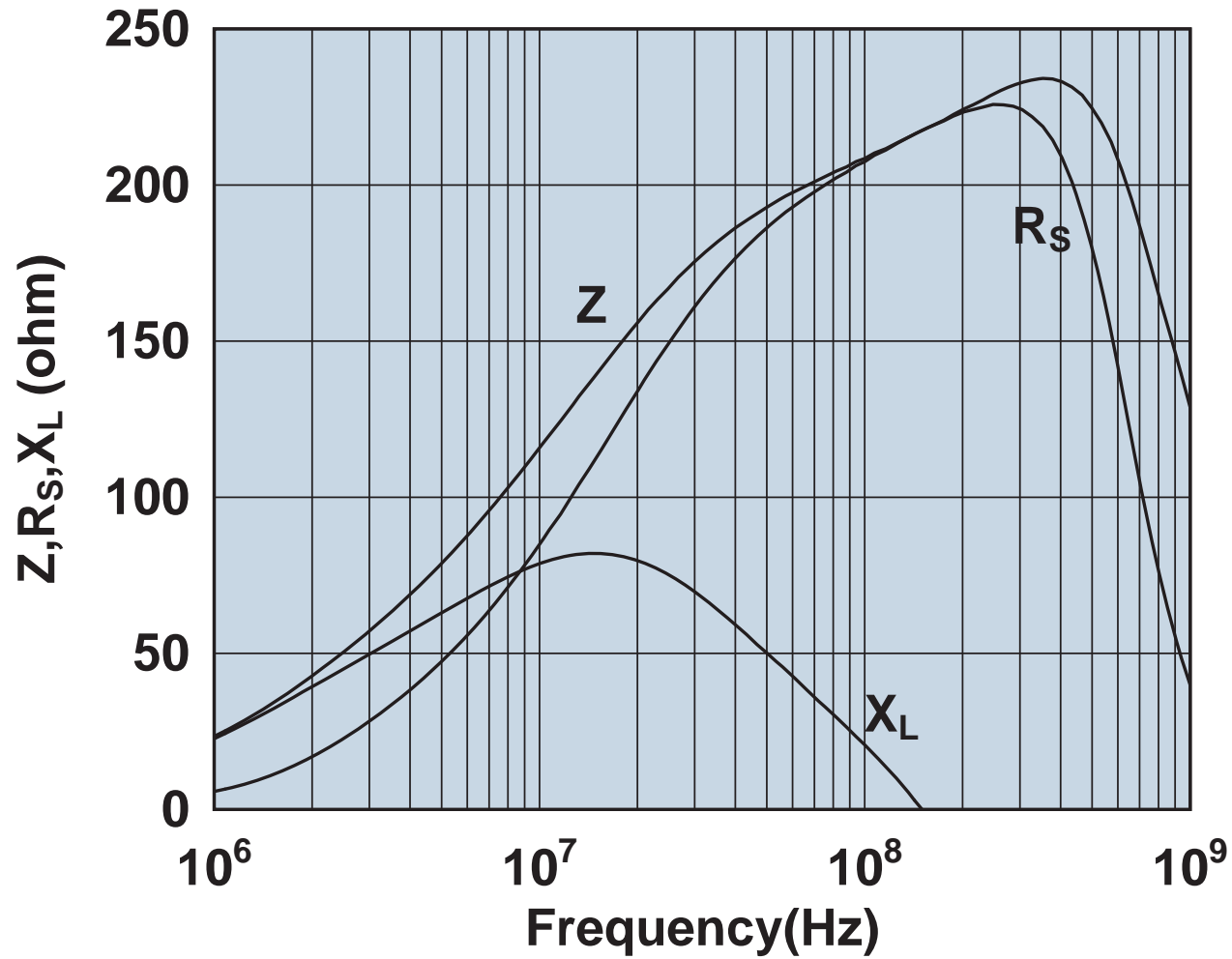

Impedance, reactance, and resistance vs. frequency.

2643480102

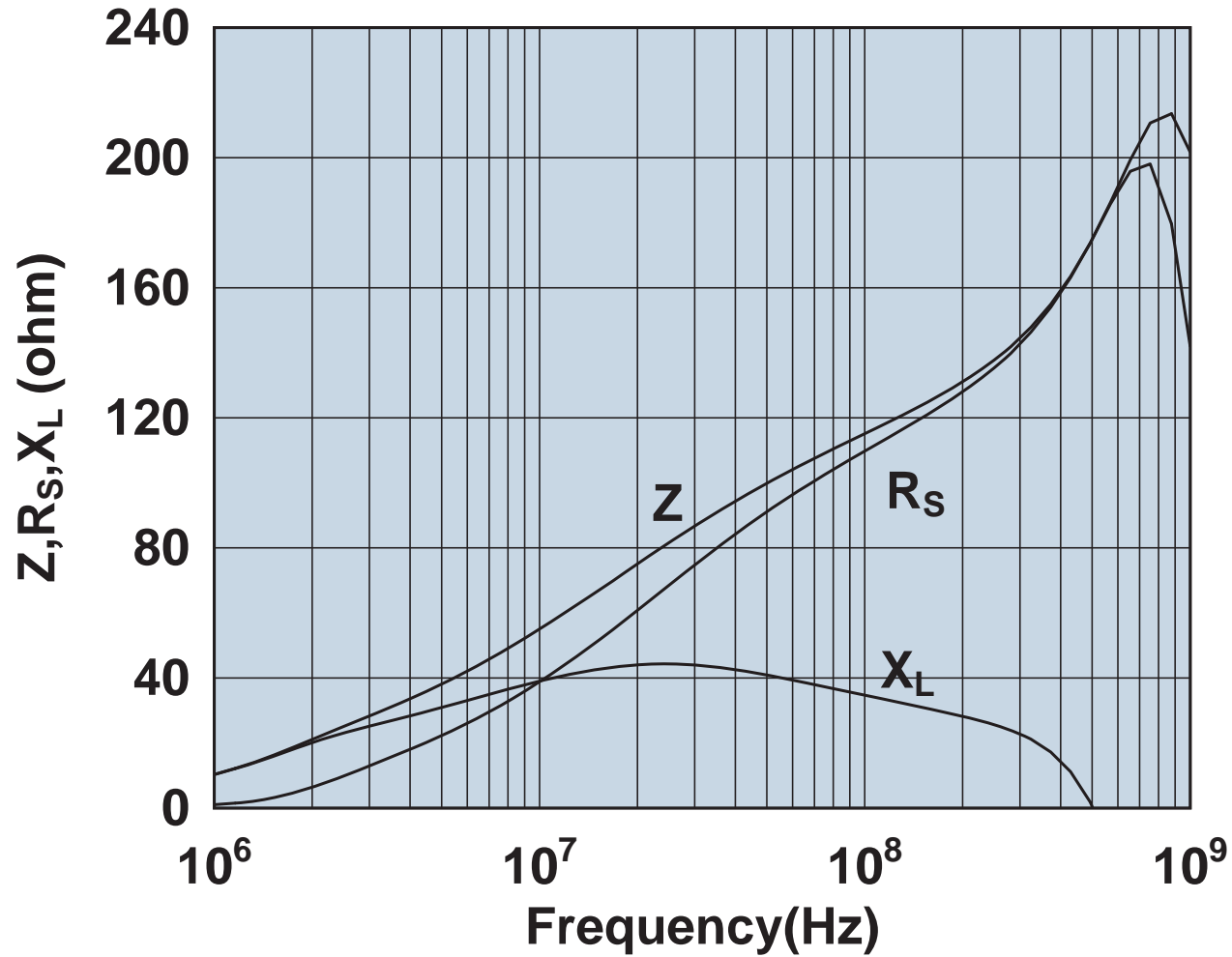

Impedance, reactance, and resistance vs. frequency.

2643540002

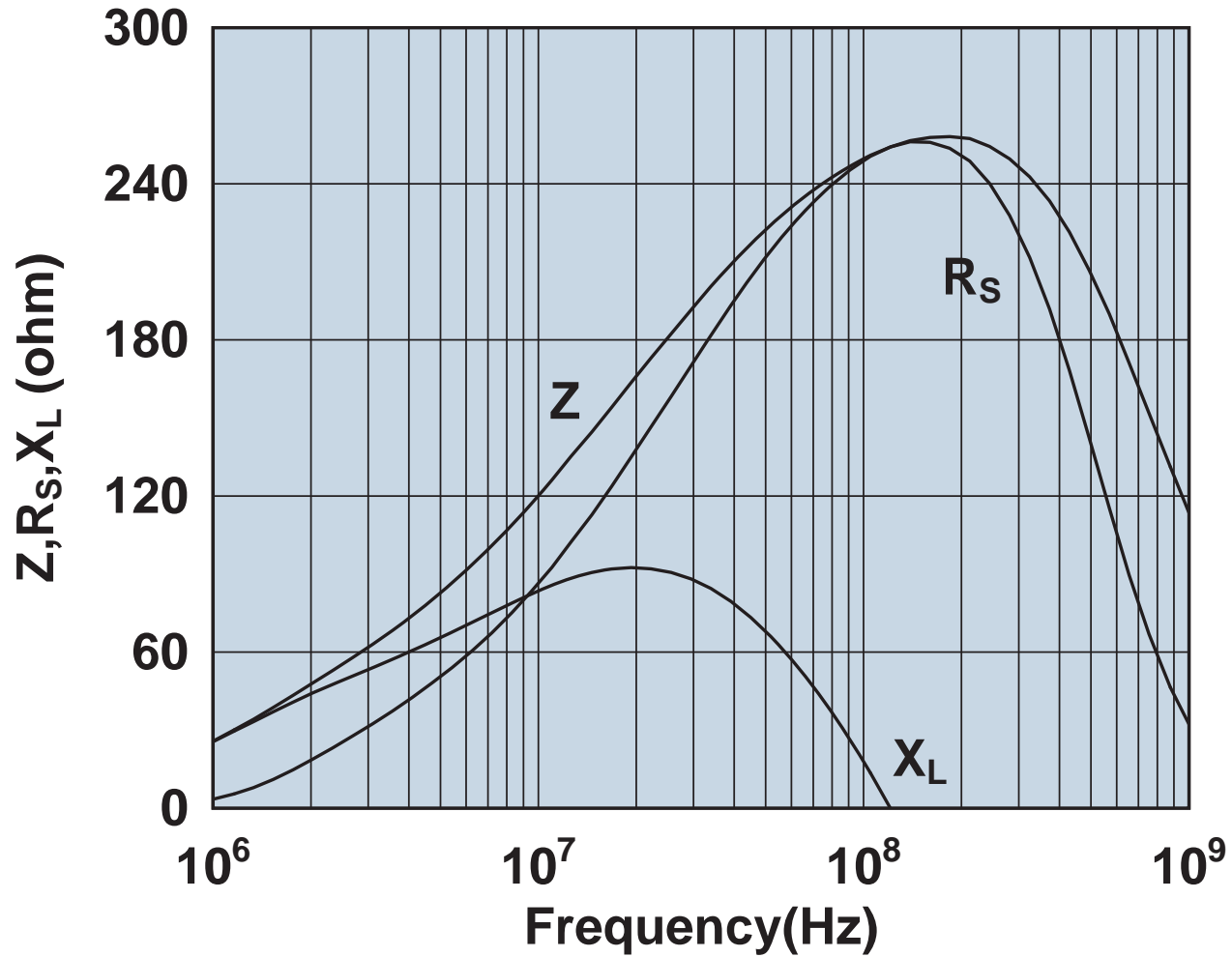

Impedance, reactance, and resistance vs. frequency.

2643540102

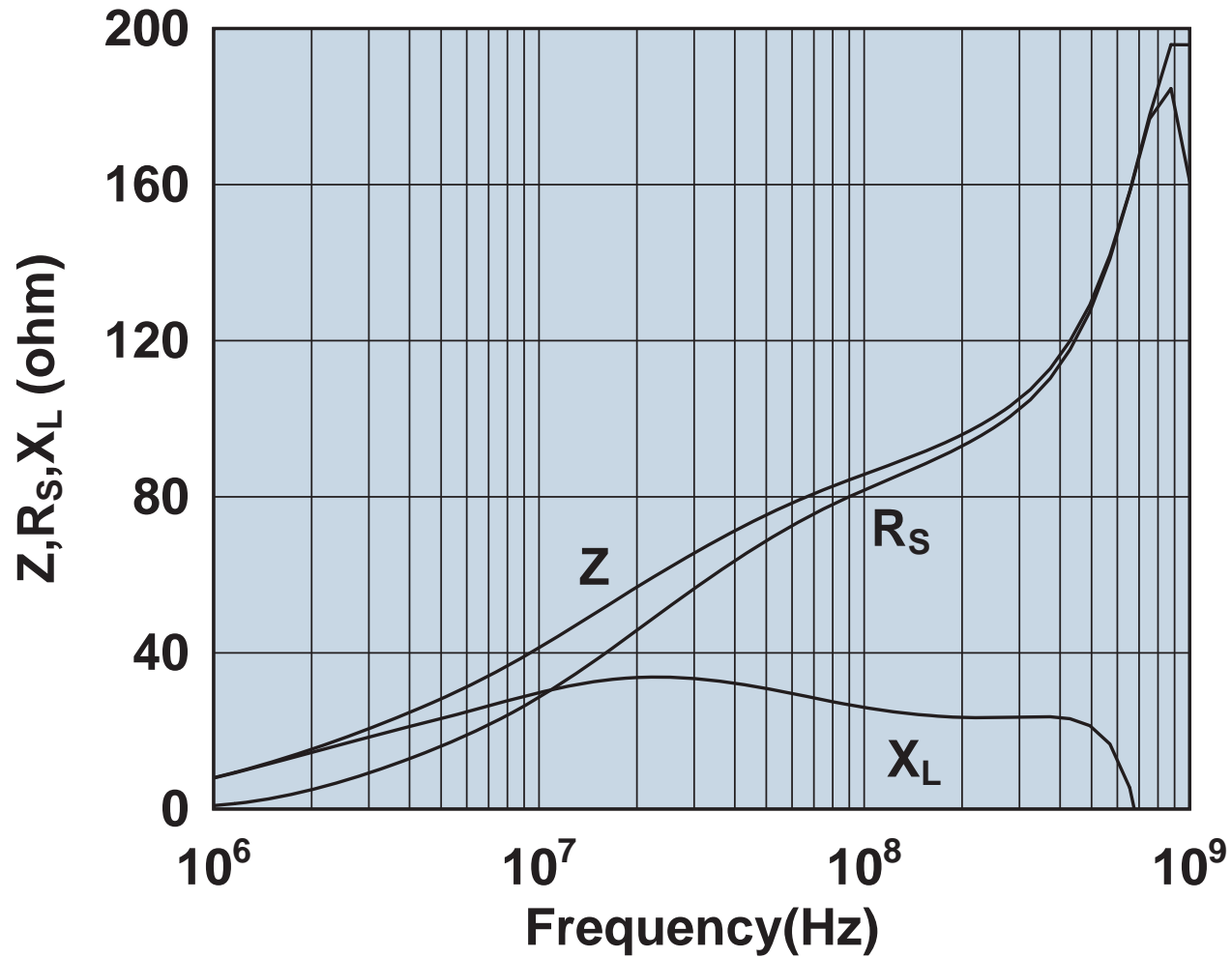

Impedance, reactance, and resistance vs. frequency.

2643540202

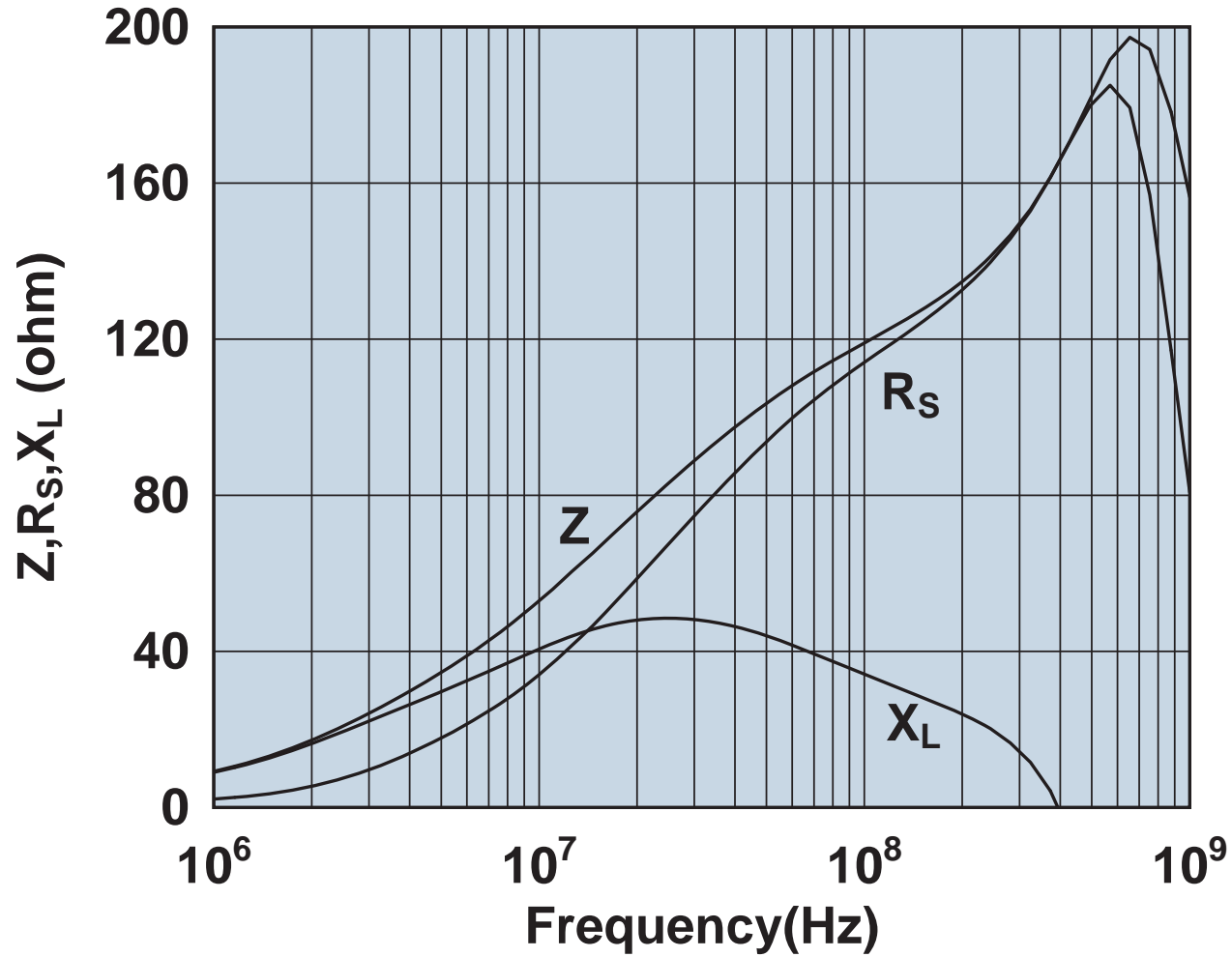

Impedance, reactance, and resistance vs. frequency.

2643540302

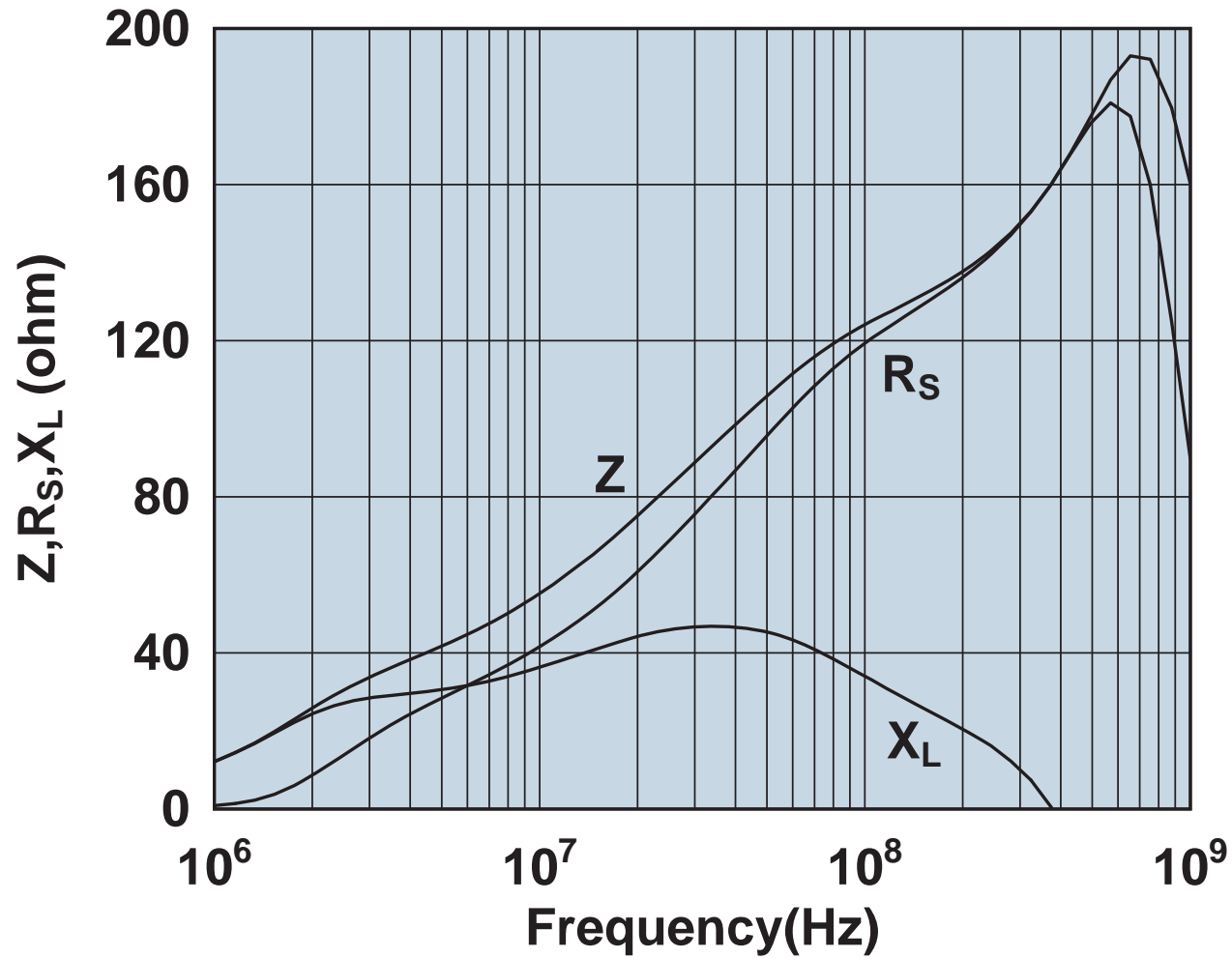

Impedance, reactance, and resistance vs. frequency.



2643540402

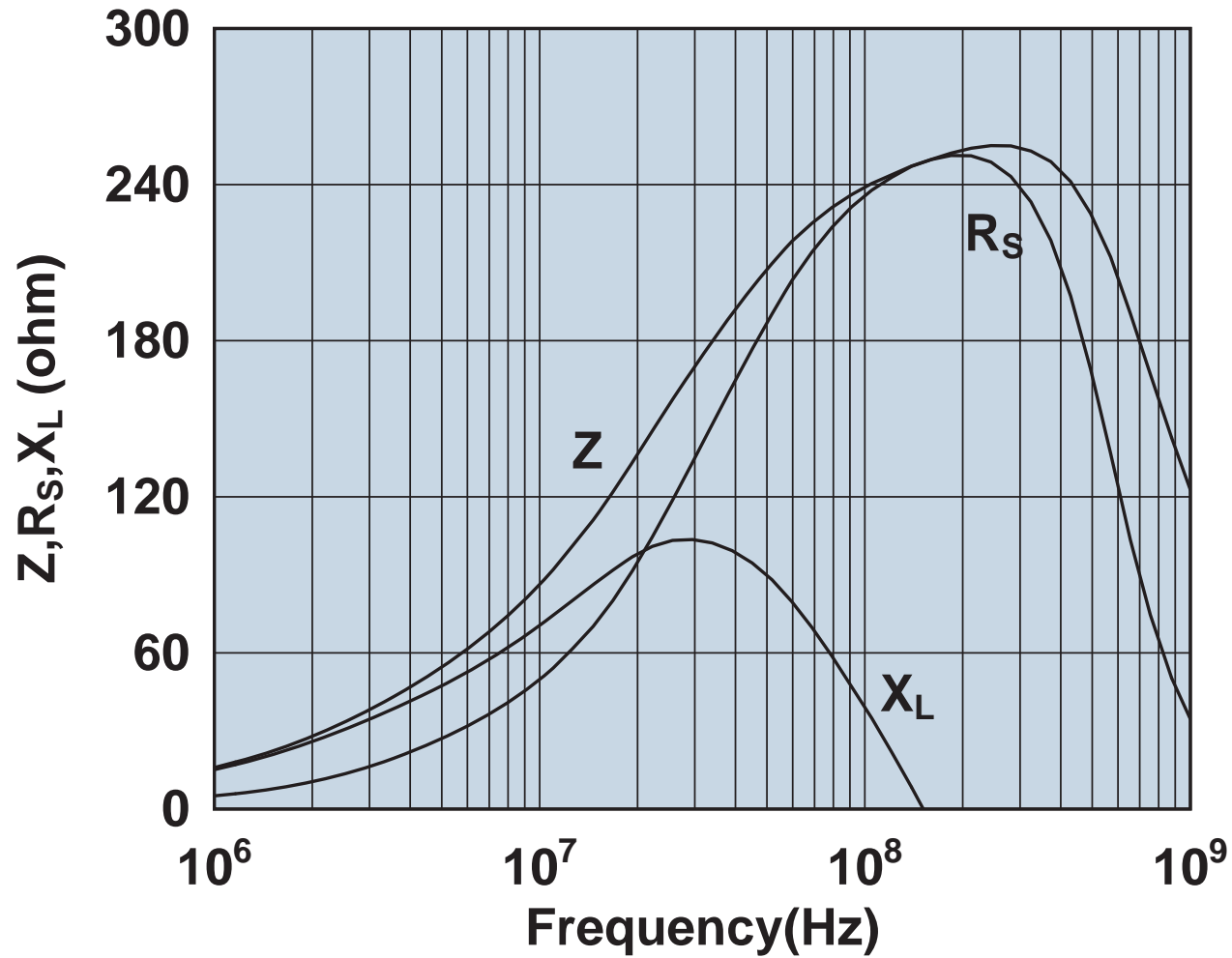

Impedance, reactance, and resistance vs. frequency.

2643540702

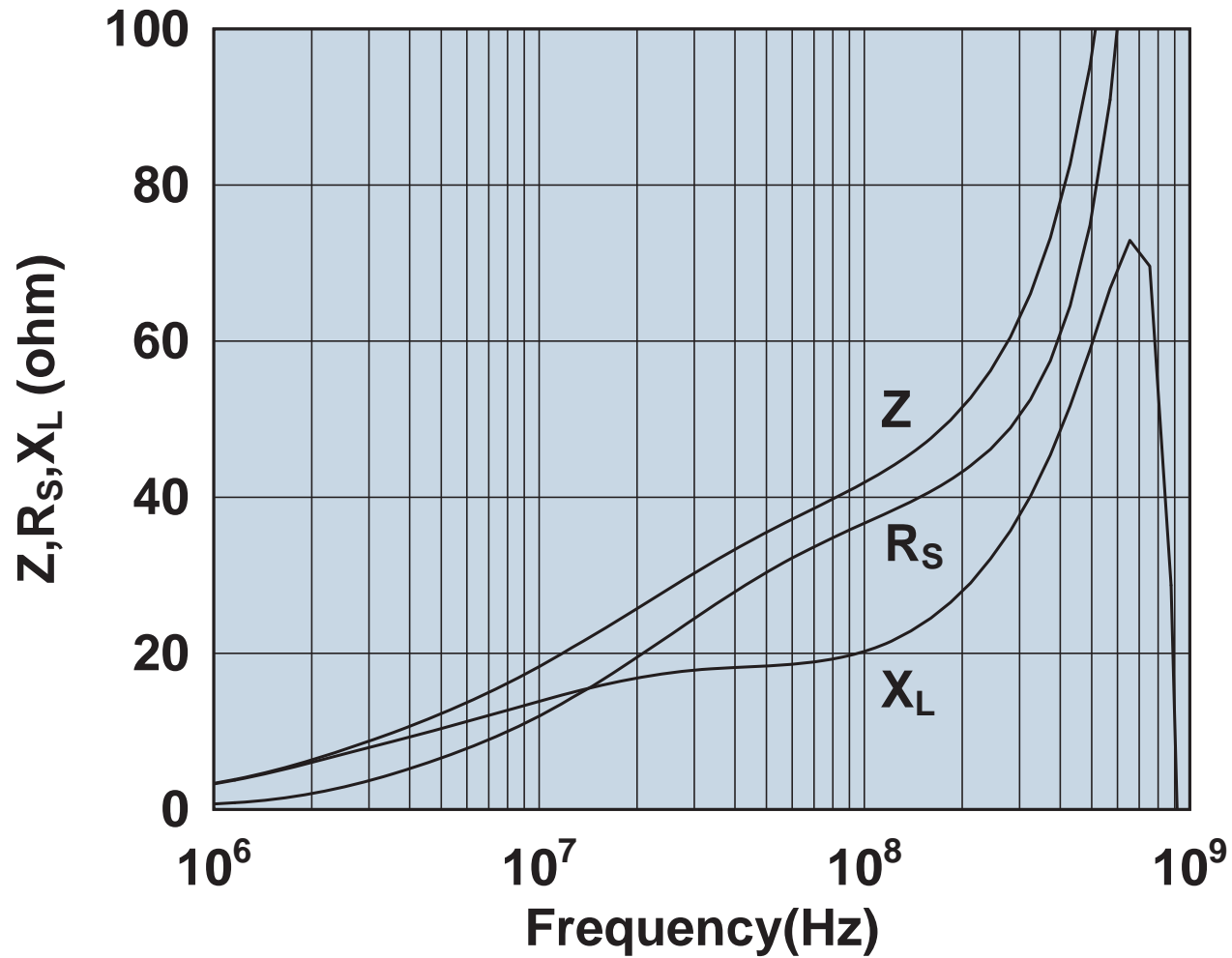

Impedance, reactance, and resistance vs. frequency.

2643625002

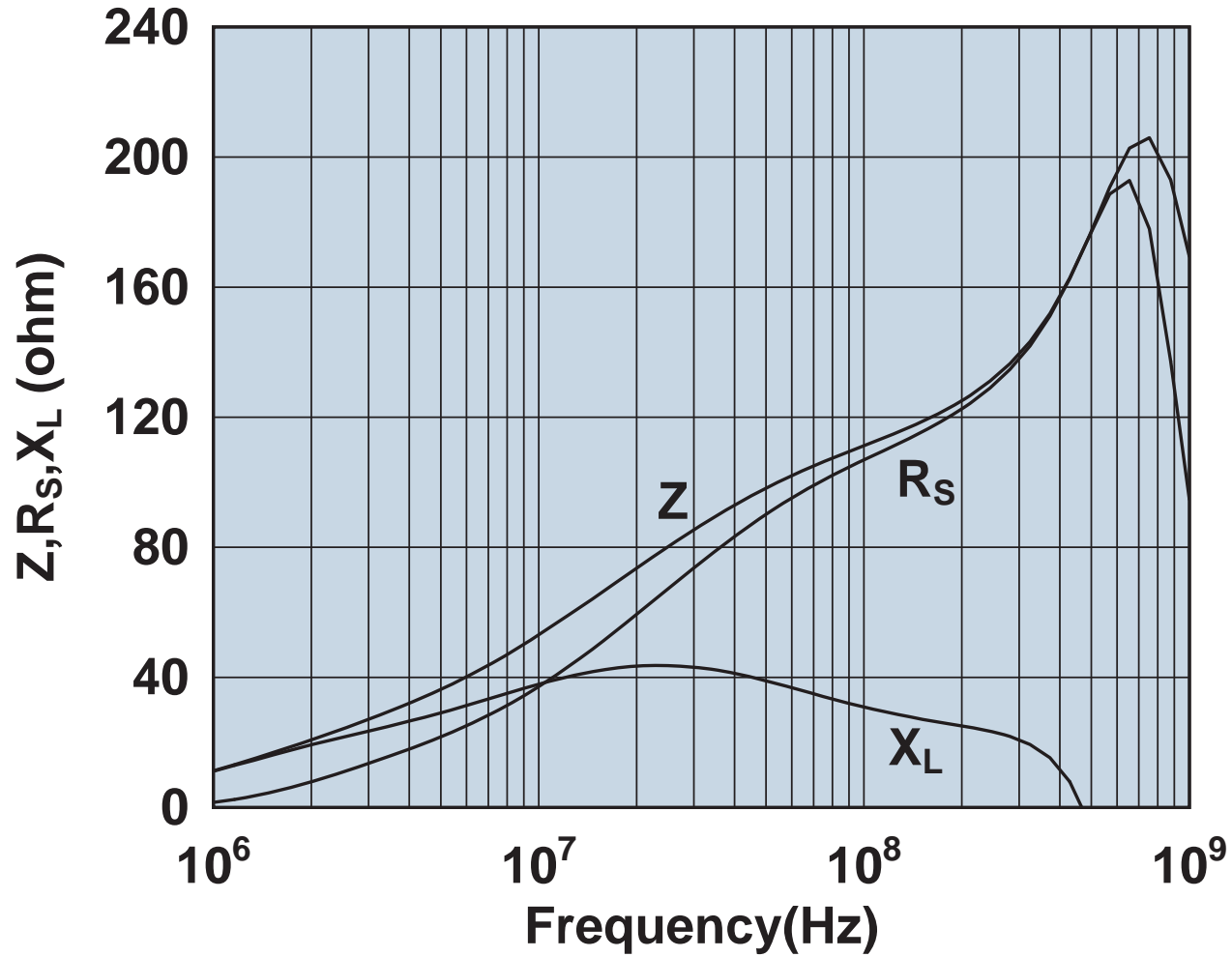

Impedance, reactance, and resistance vs. frequency.

2643625006

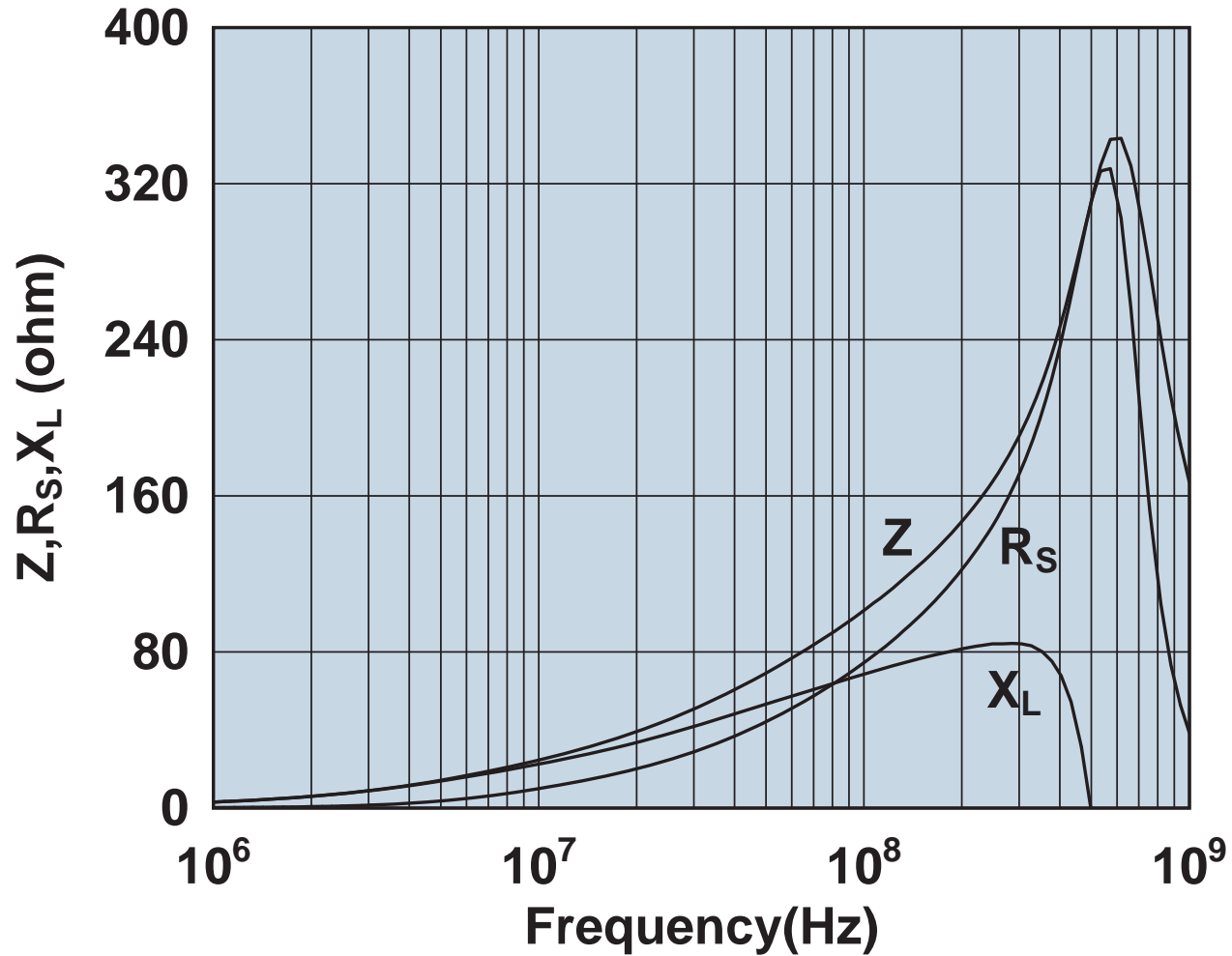

Impedance, reactance, and resistance vs. frequency.

2643625102

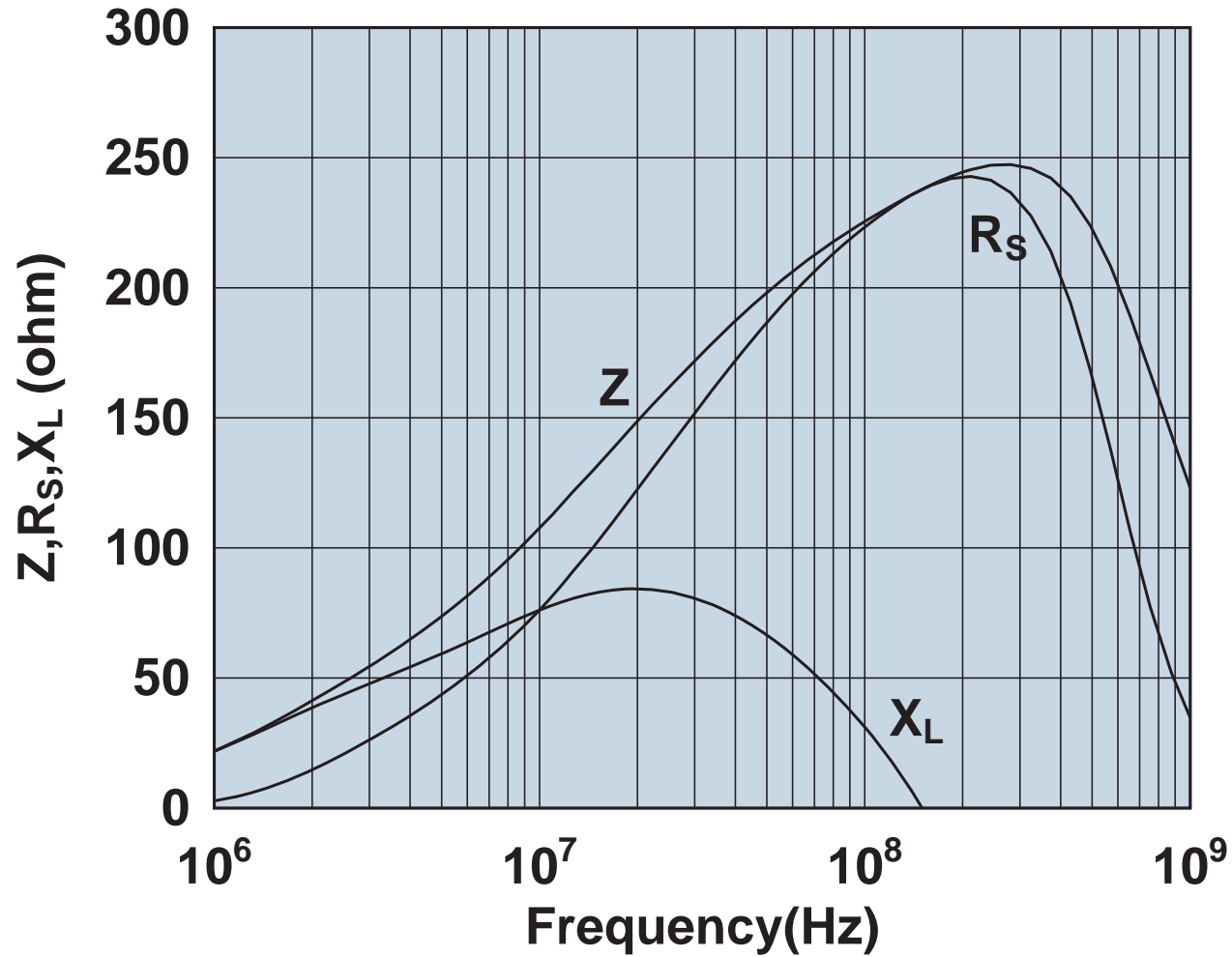

Impedance, reactance, and resistance vs. frequency.

2643625202

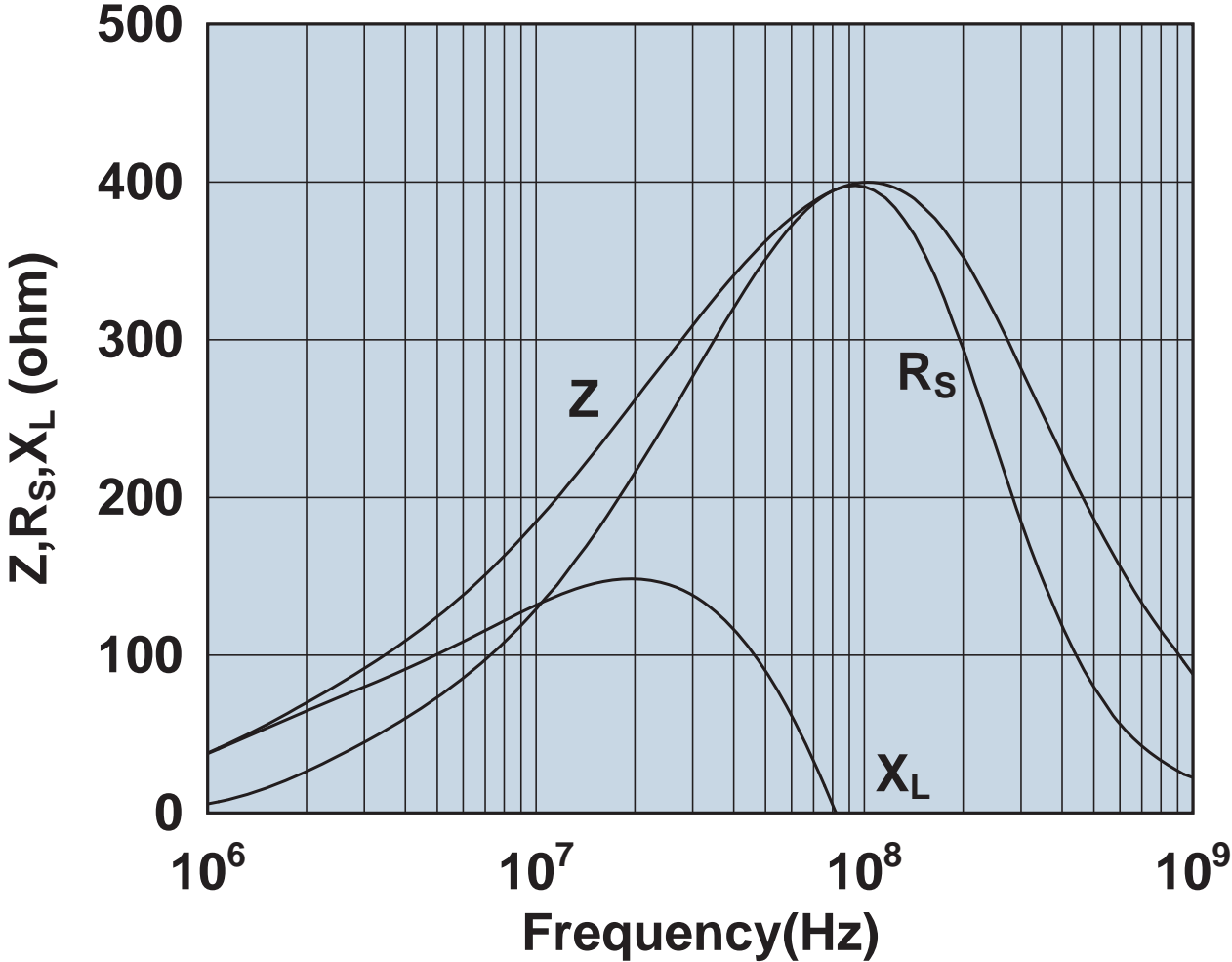

Impedance, reactance, and resistance vs. frequency.

2643625902

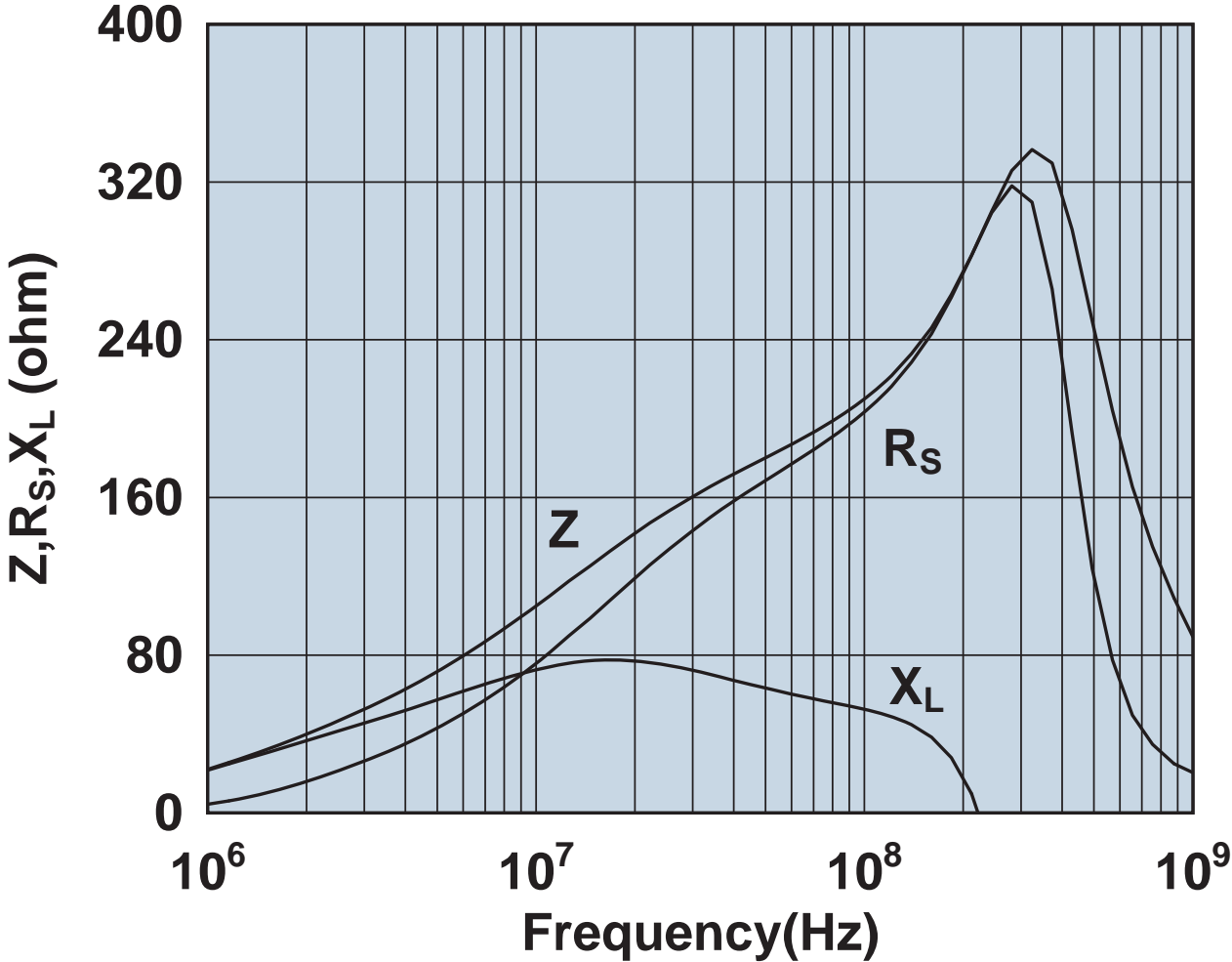

Impedance, reactance, and resistance vs. frequency.

2643626002

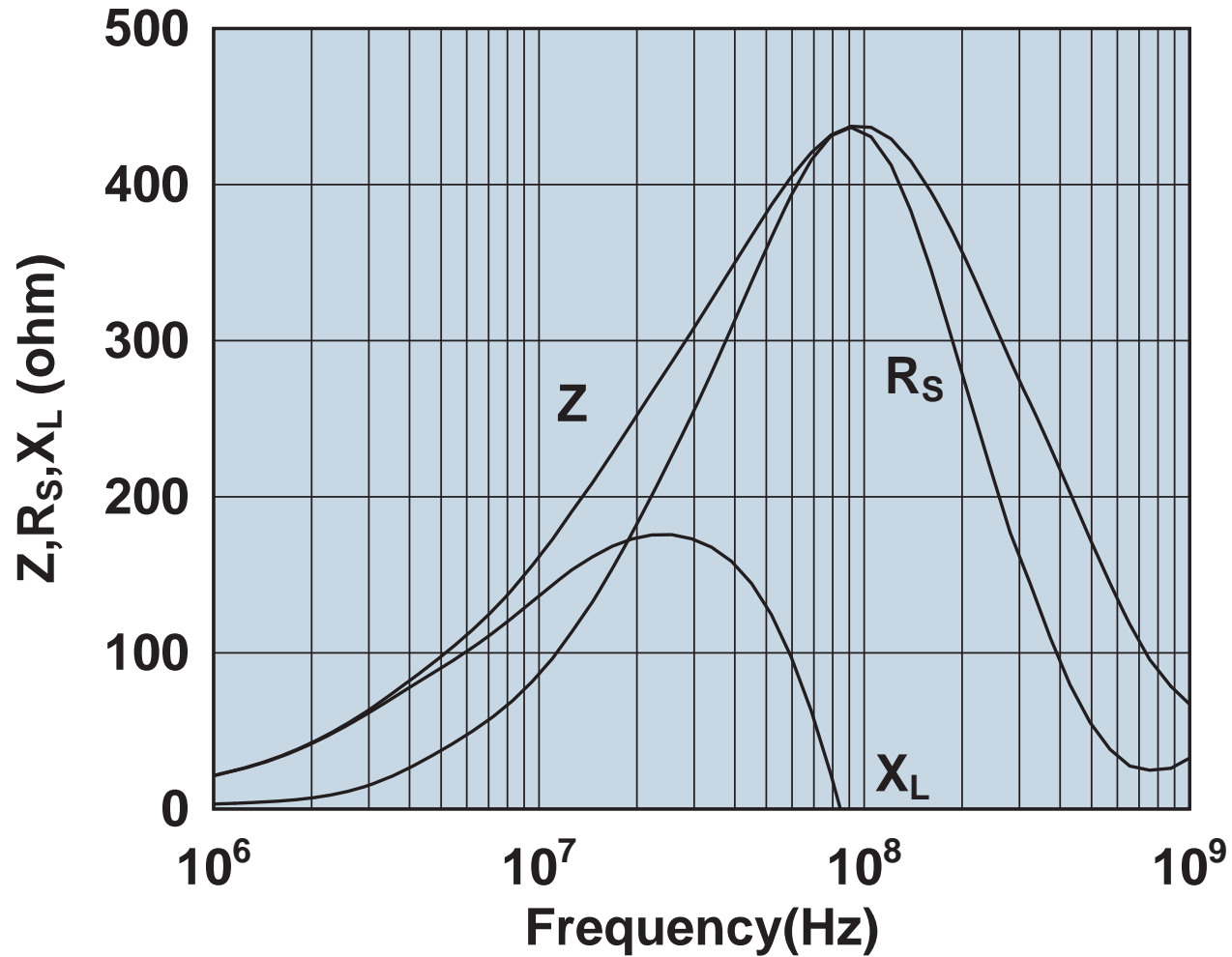

Impedance, reactance, and resistance vs. frequency.



2643626102

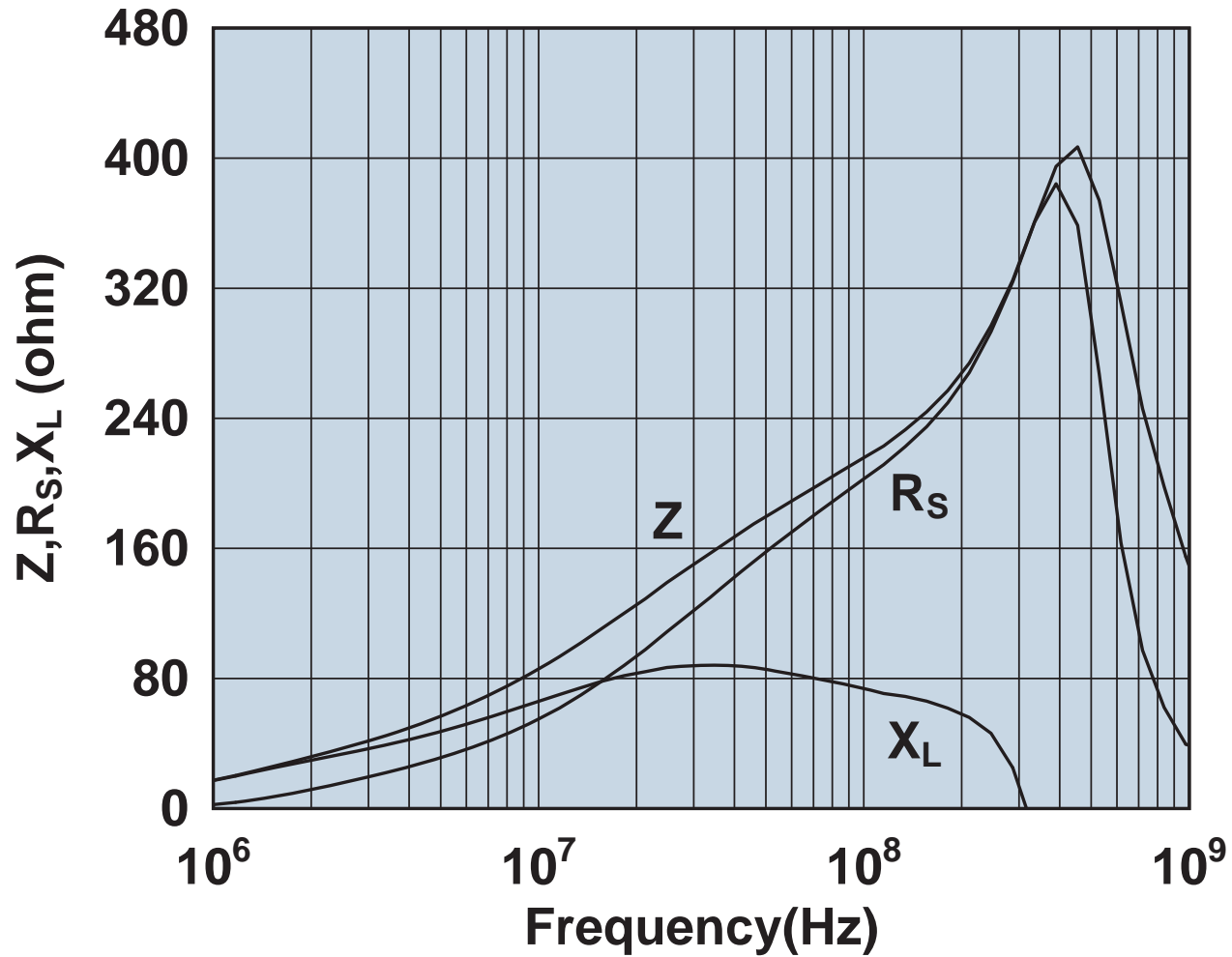

Impedance, reactance, and resistance vs. frequency.

2643626202

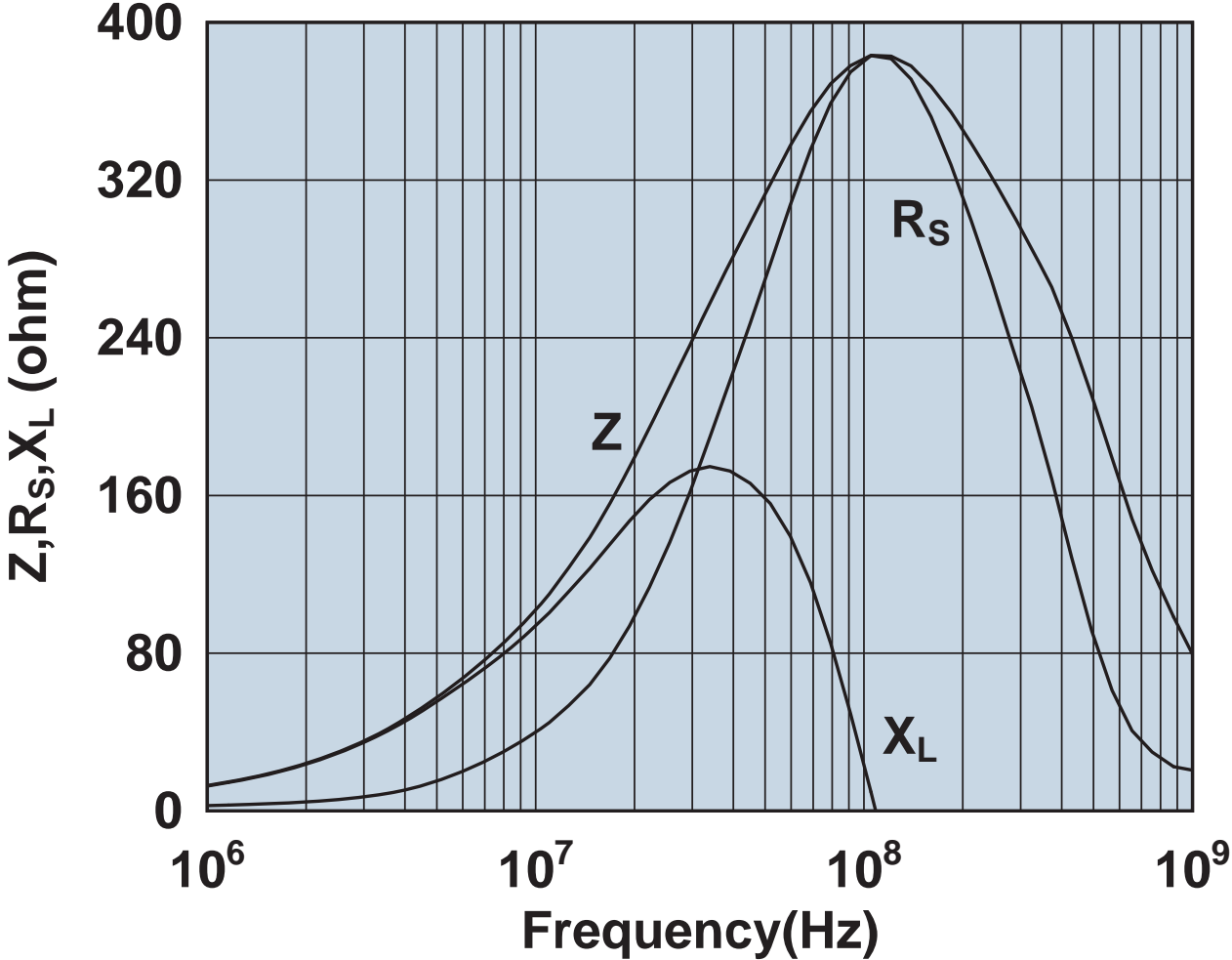

Impedance, reactance, and resistance vs. frequency.

2643626302

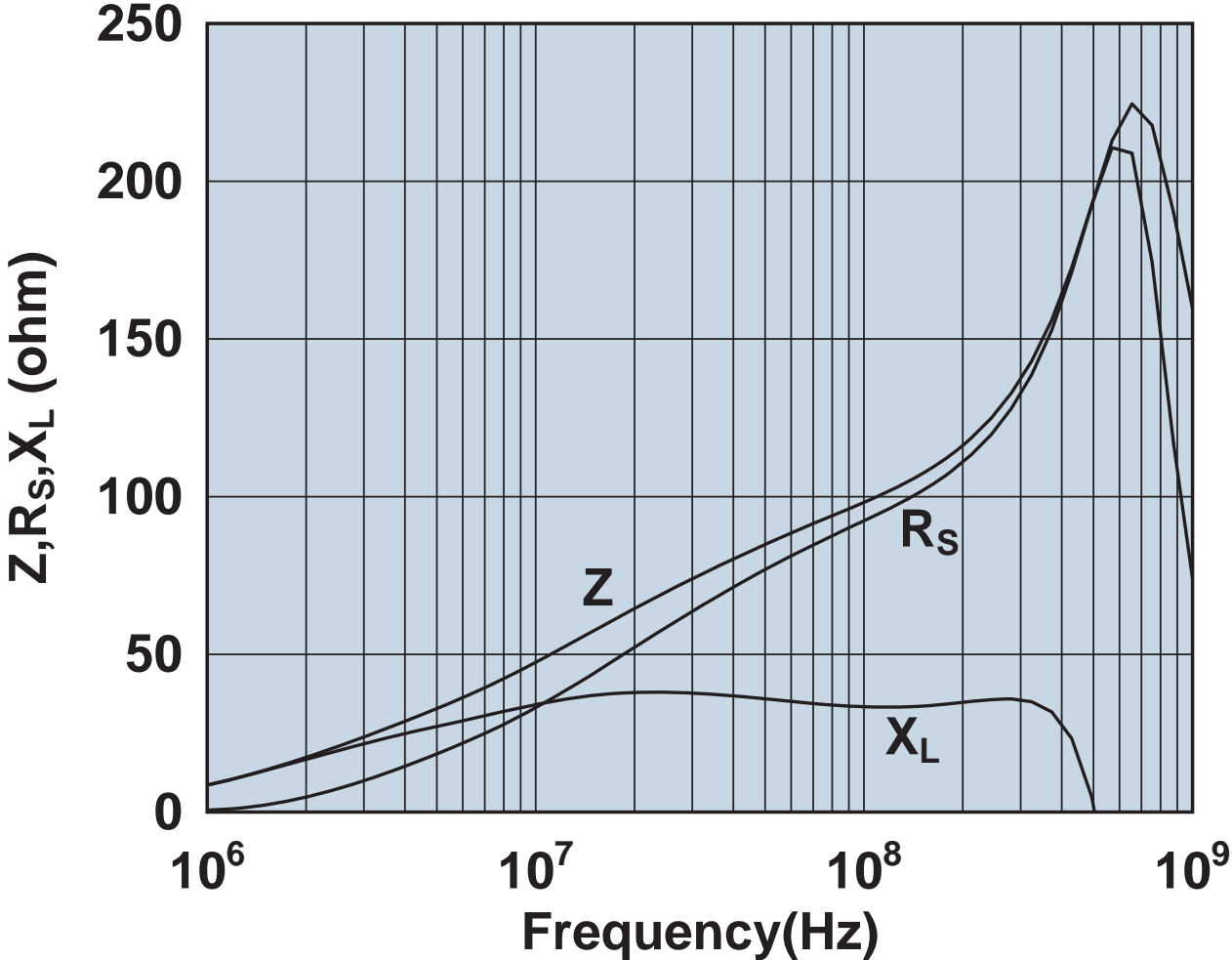

Impedance, reactance, and resistance vs. frequency.

2643626402

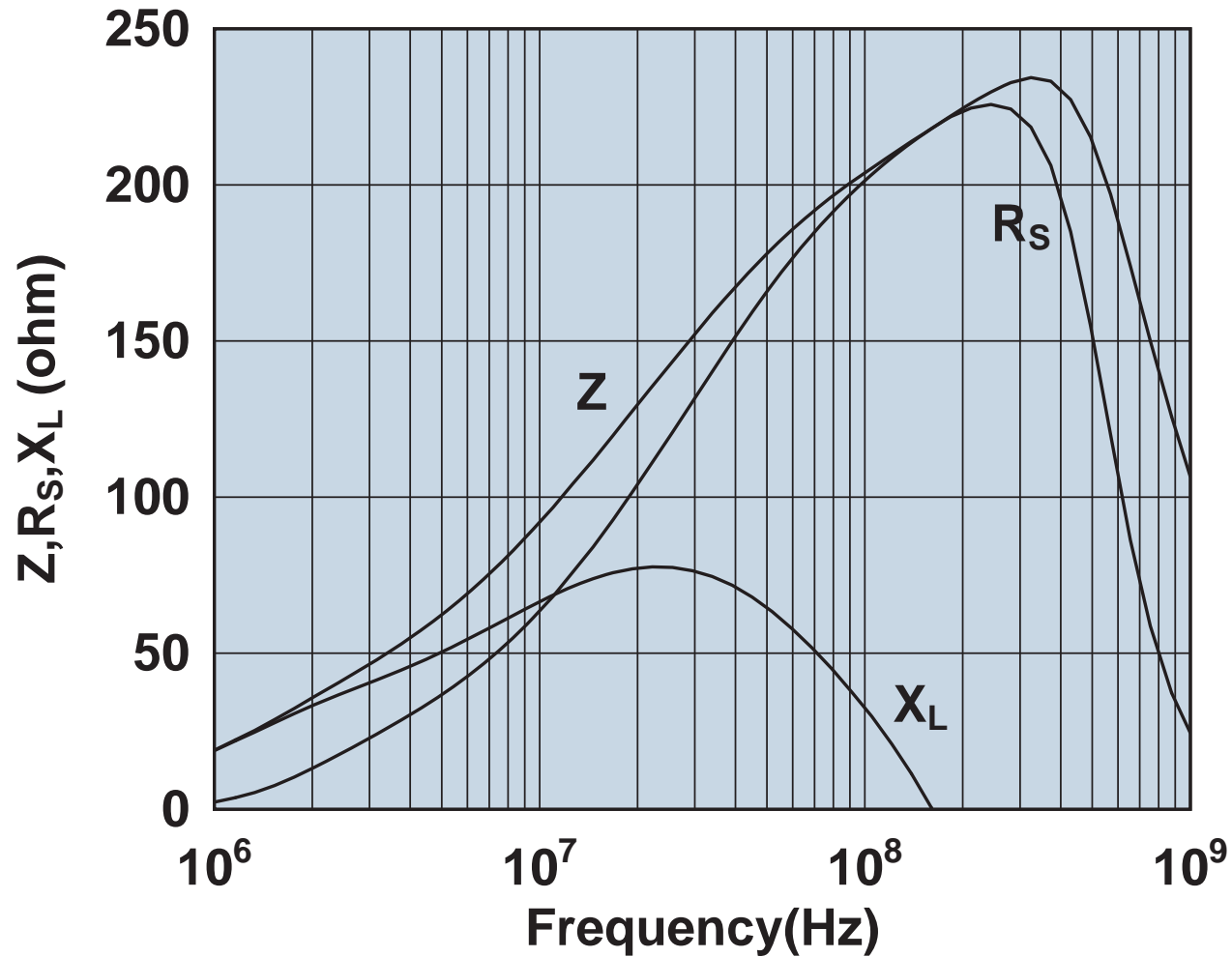

Impedance, reactance, and resistance vs. frequency.

2643626502

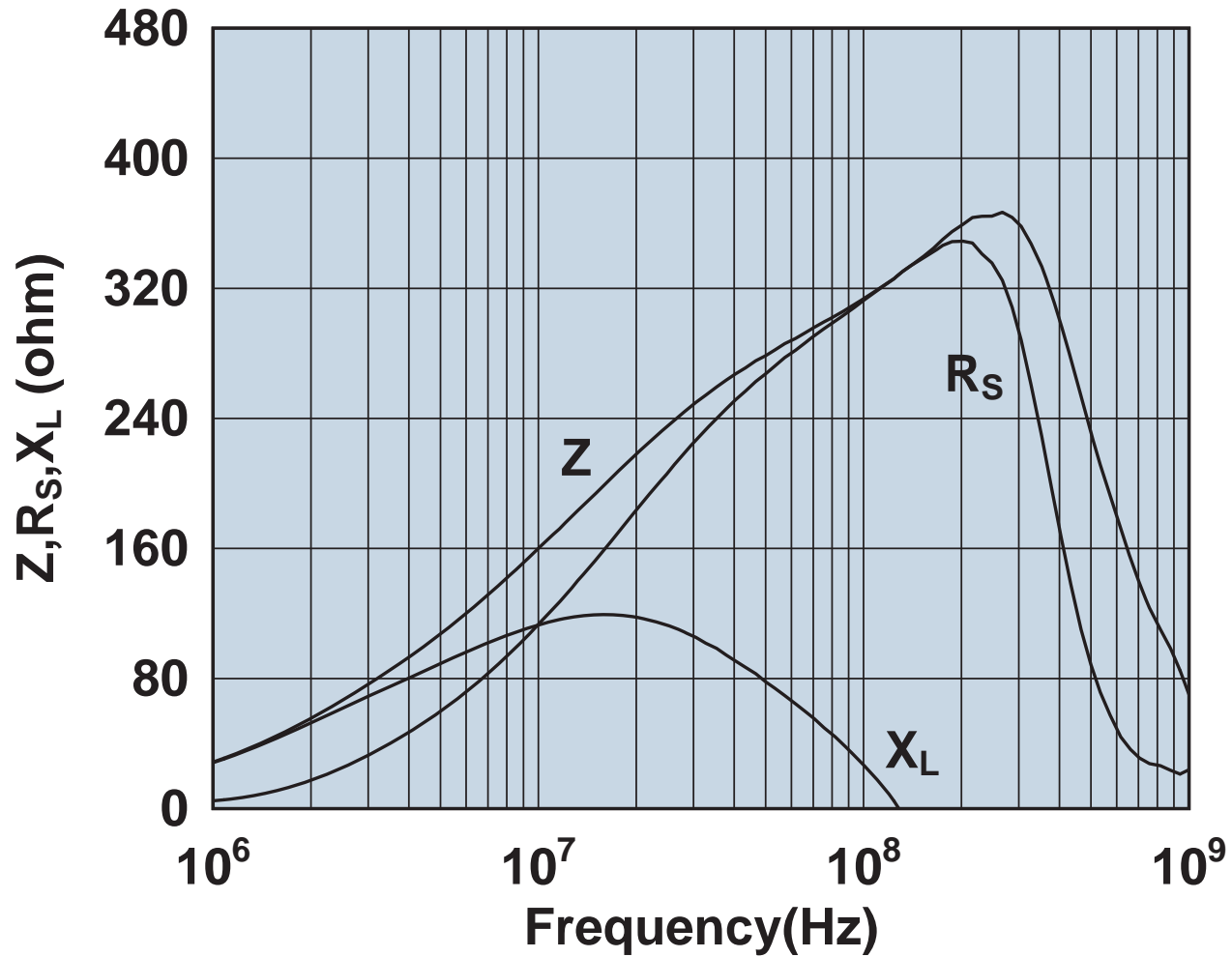

Impedance, reactance, and resistance vs. frequency.

2643665702

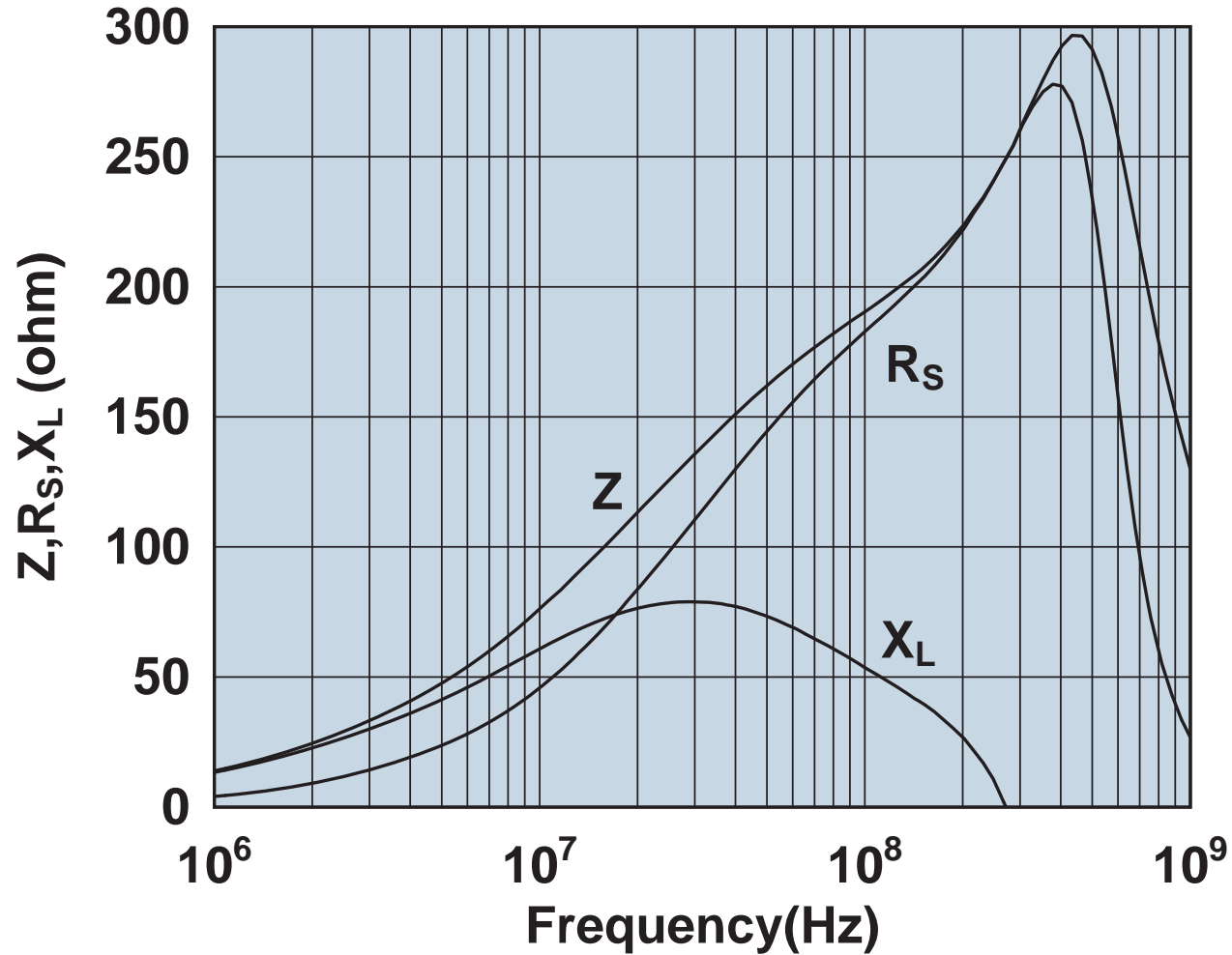

Impedance, reactance, and resistance vs. frequency.

2643665802

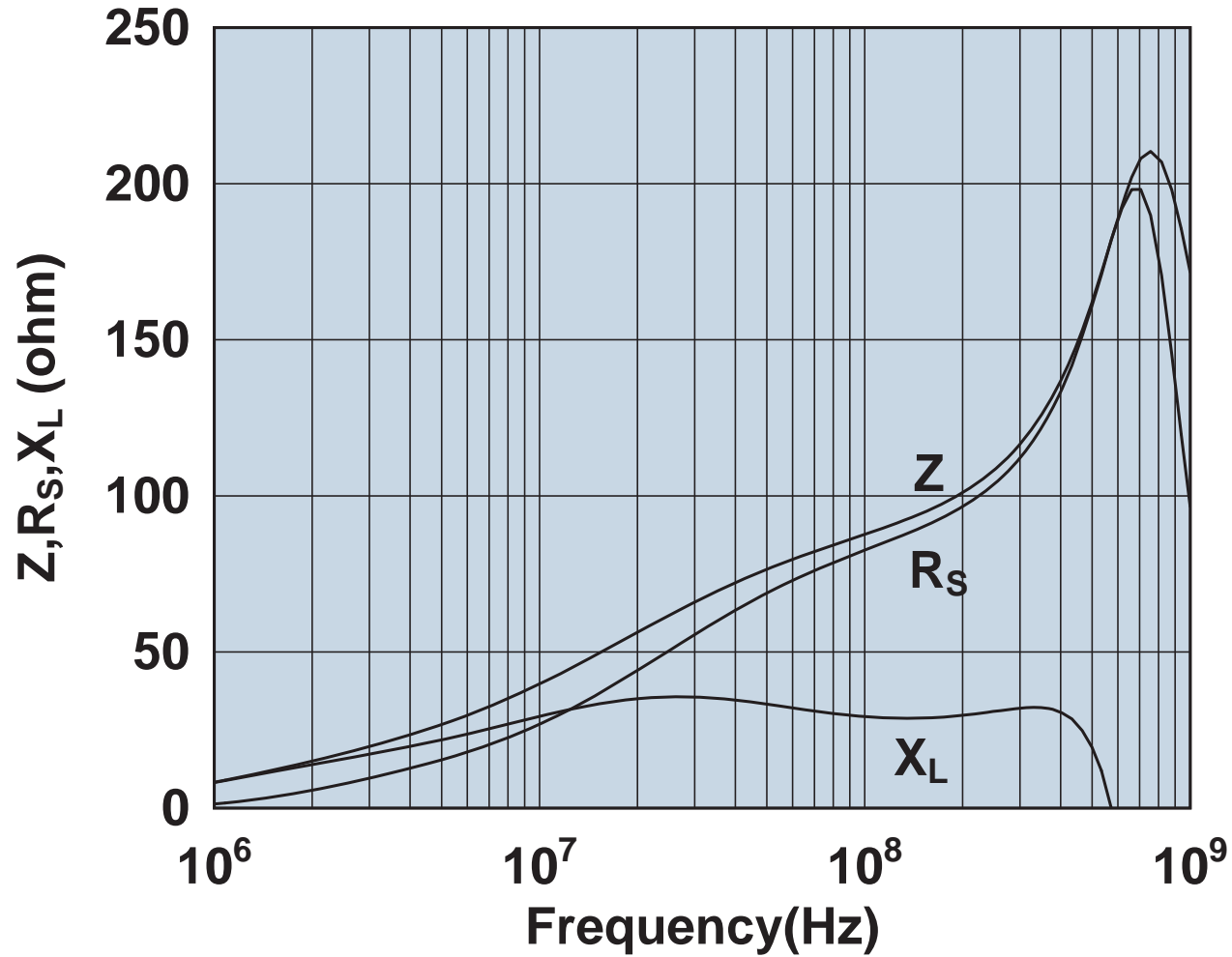

Impedance, reactance, and resistance vs. frequency.

2643665806

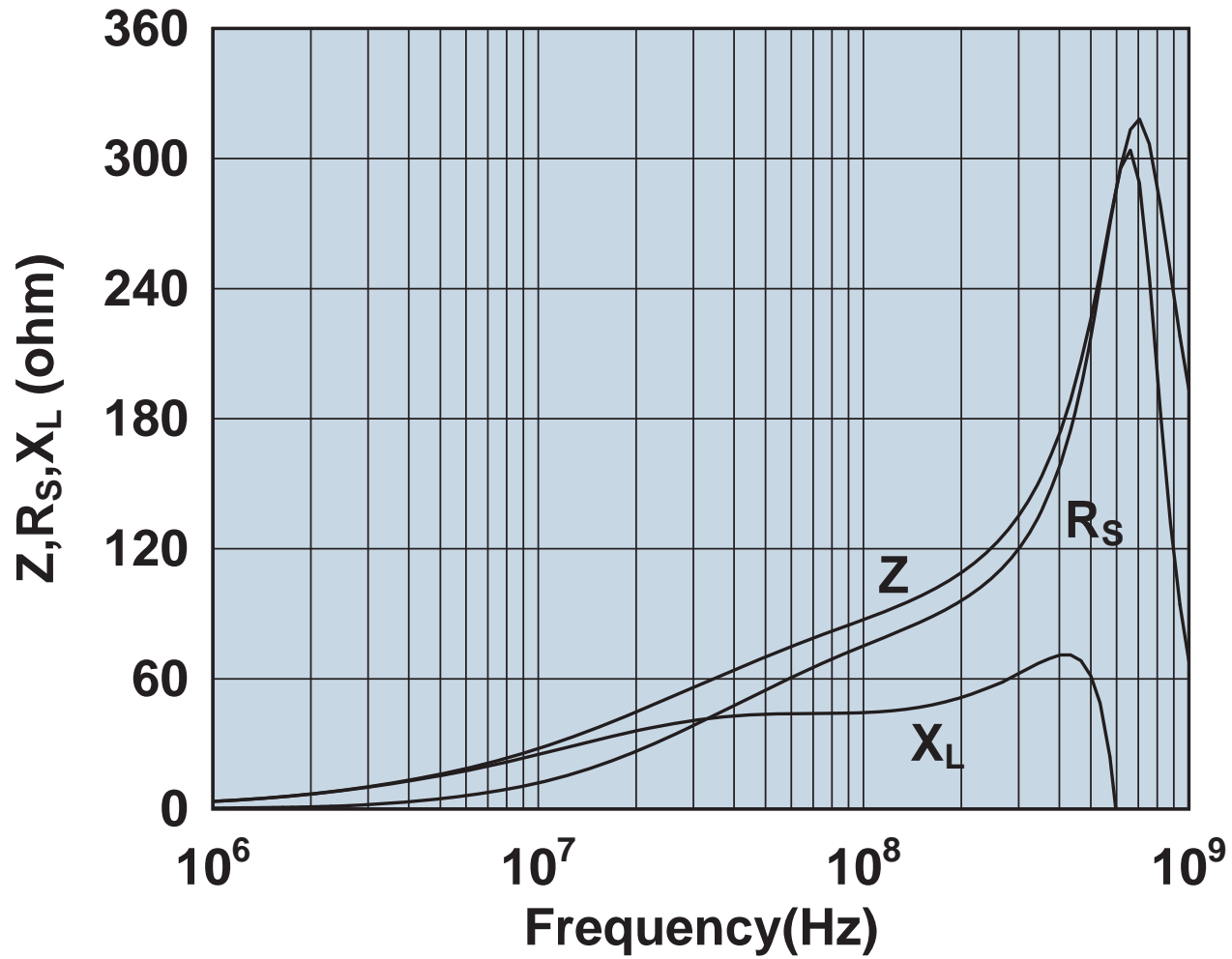

Impedance, reactance, and resistance vs. frequency.



2643665902

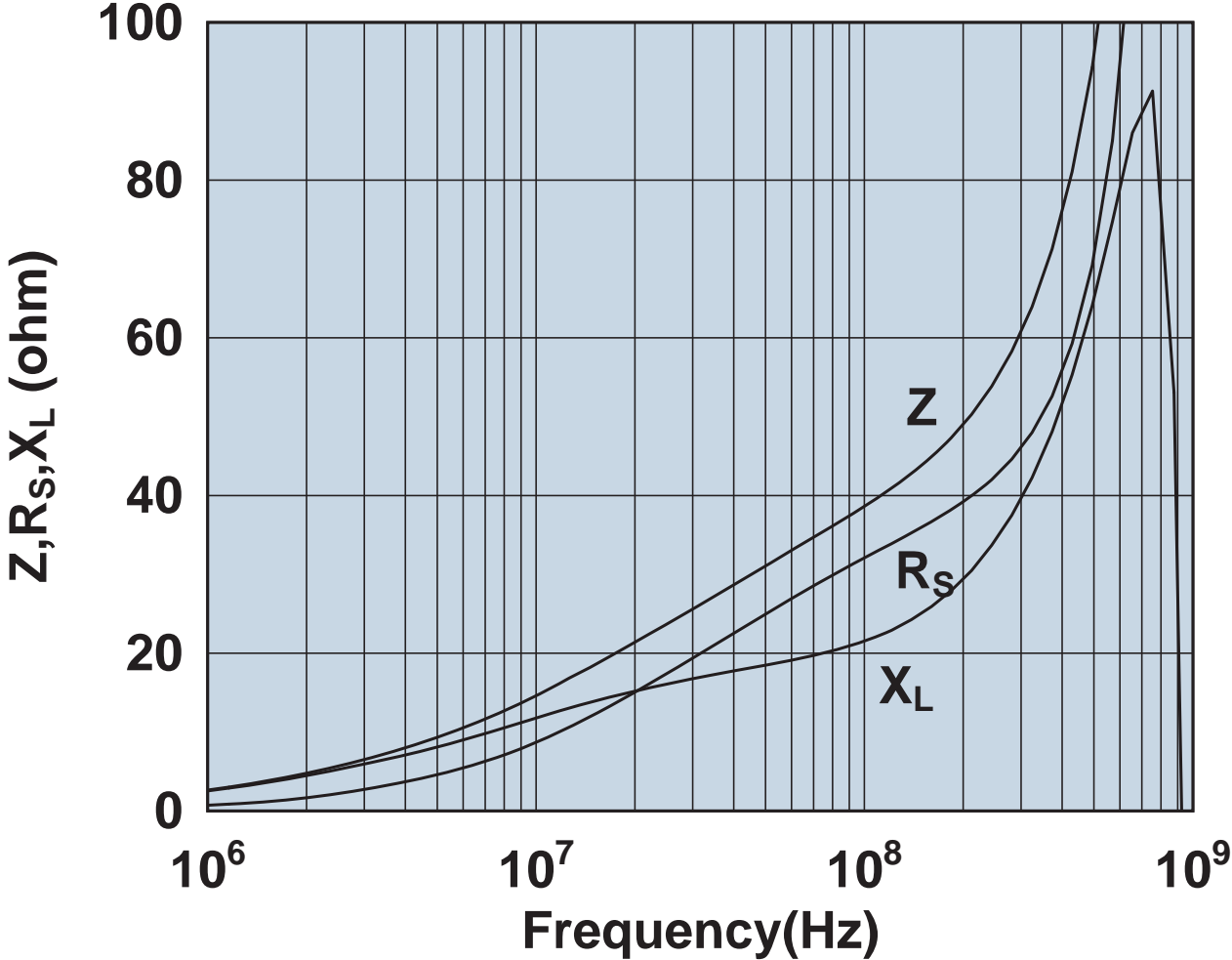

Impedance, reactance, and resistance vs. frequency.

2643800302

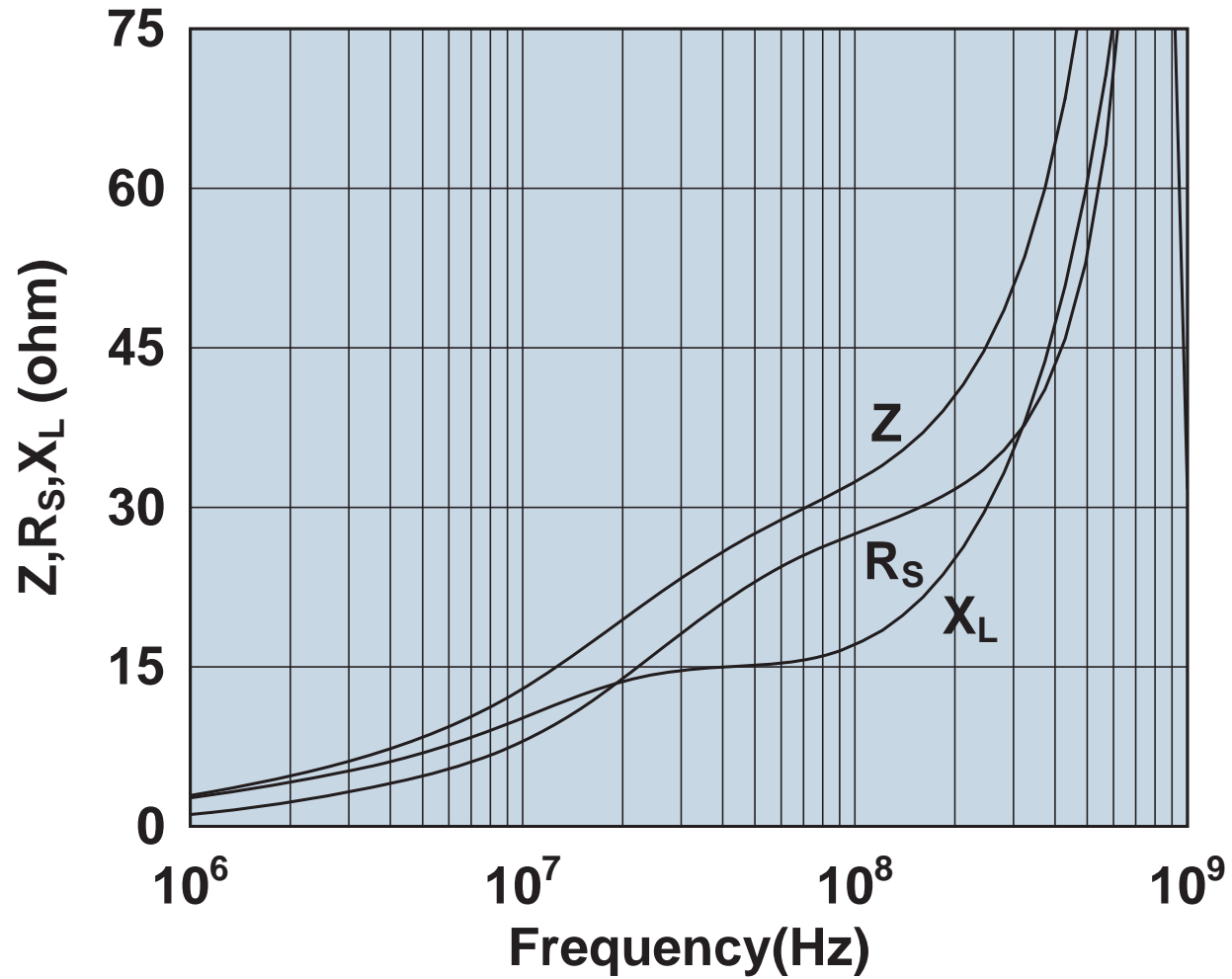

Impedance, reactance, and resistance vs. frequency.

2643800502

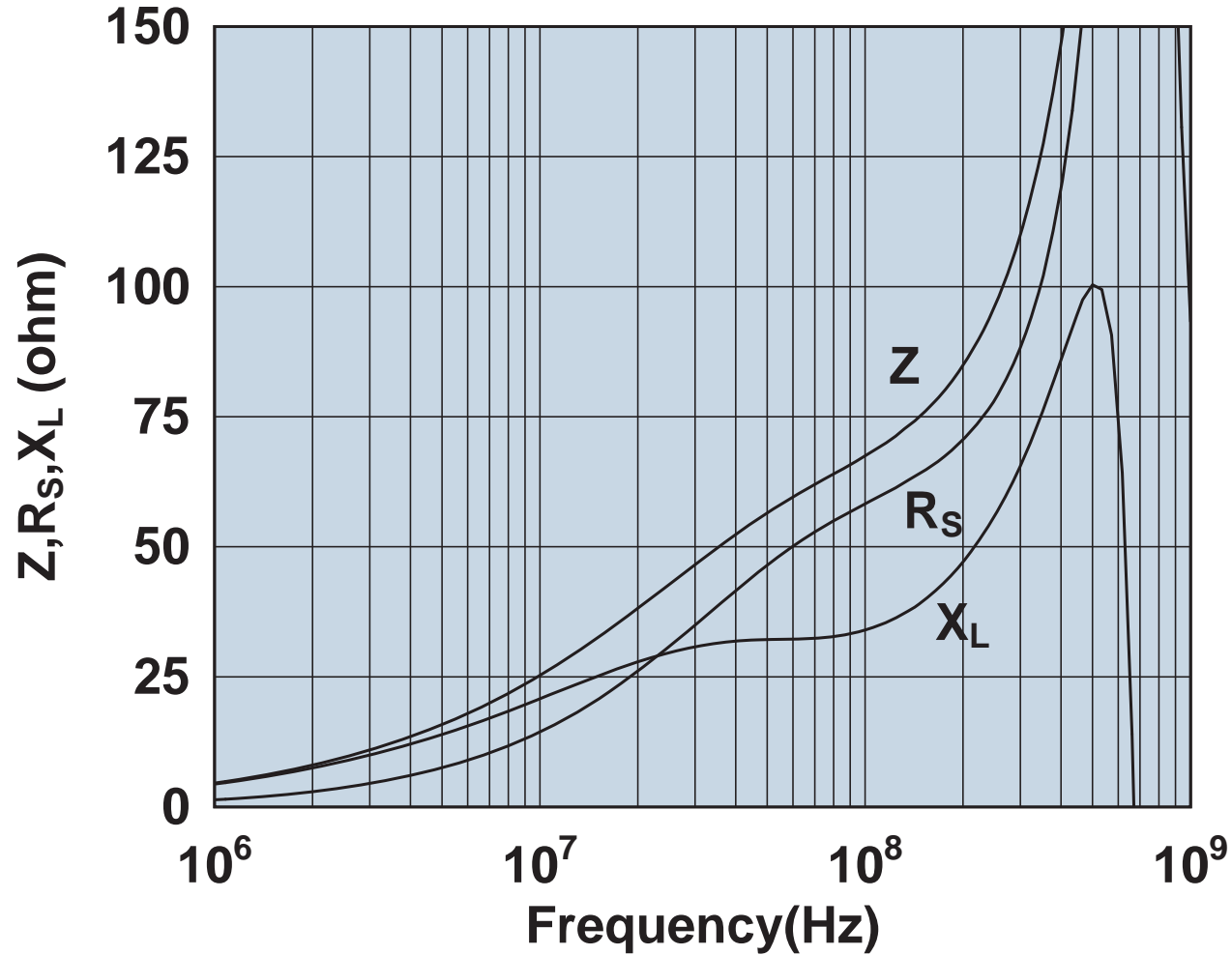

Impedance, reactance, and resistance vs. frequency.

2643800506

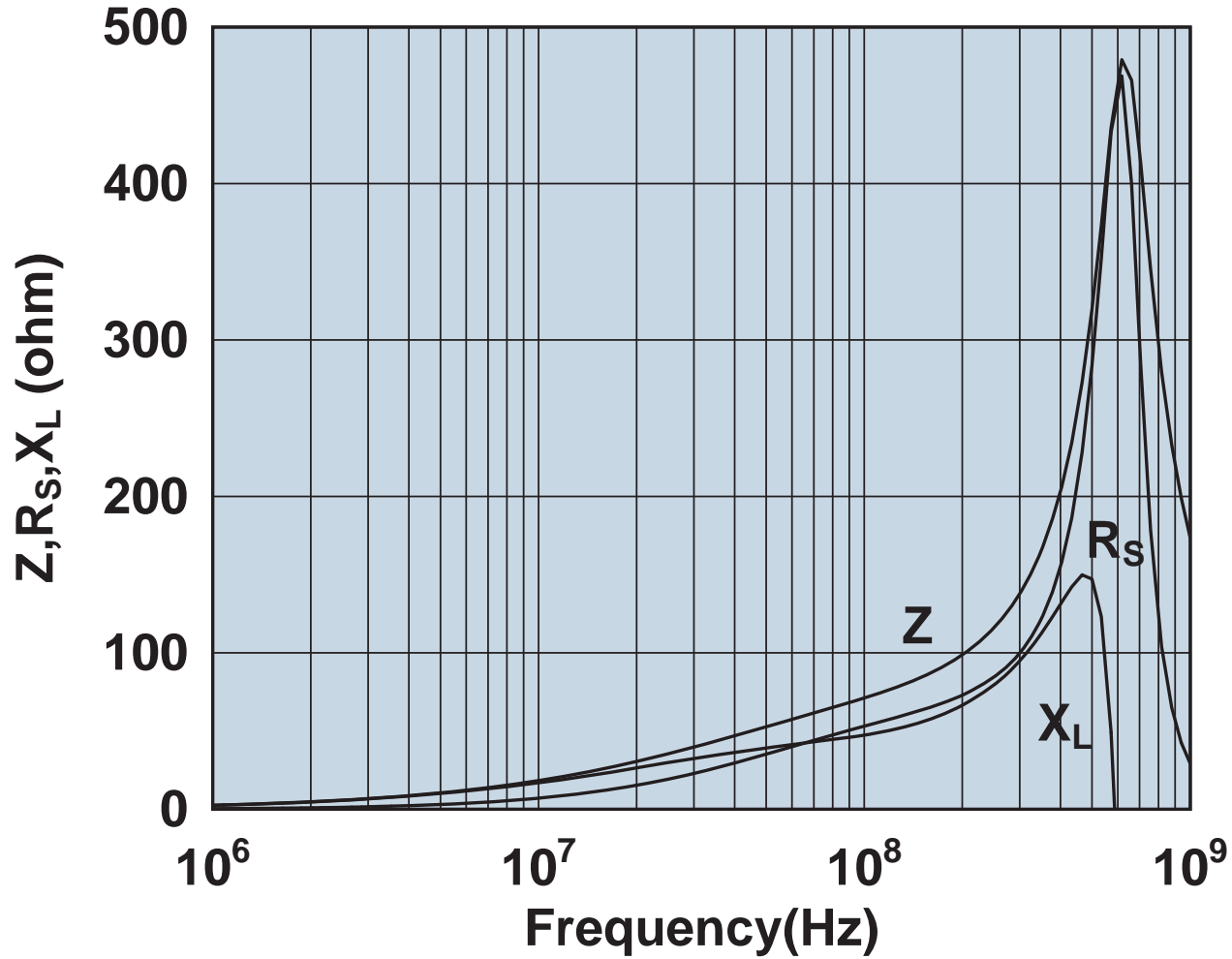

Impedance, reactance, and resistance vs. frequency.

2643800602

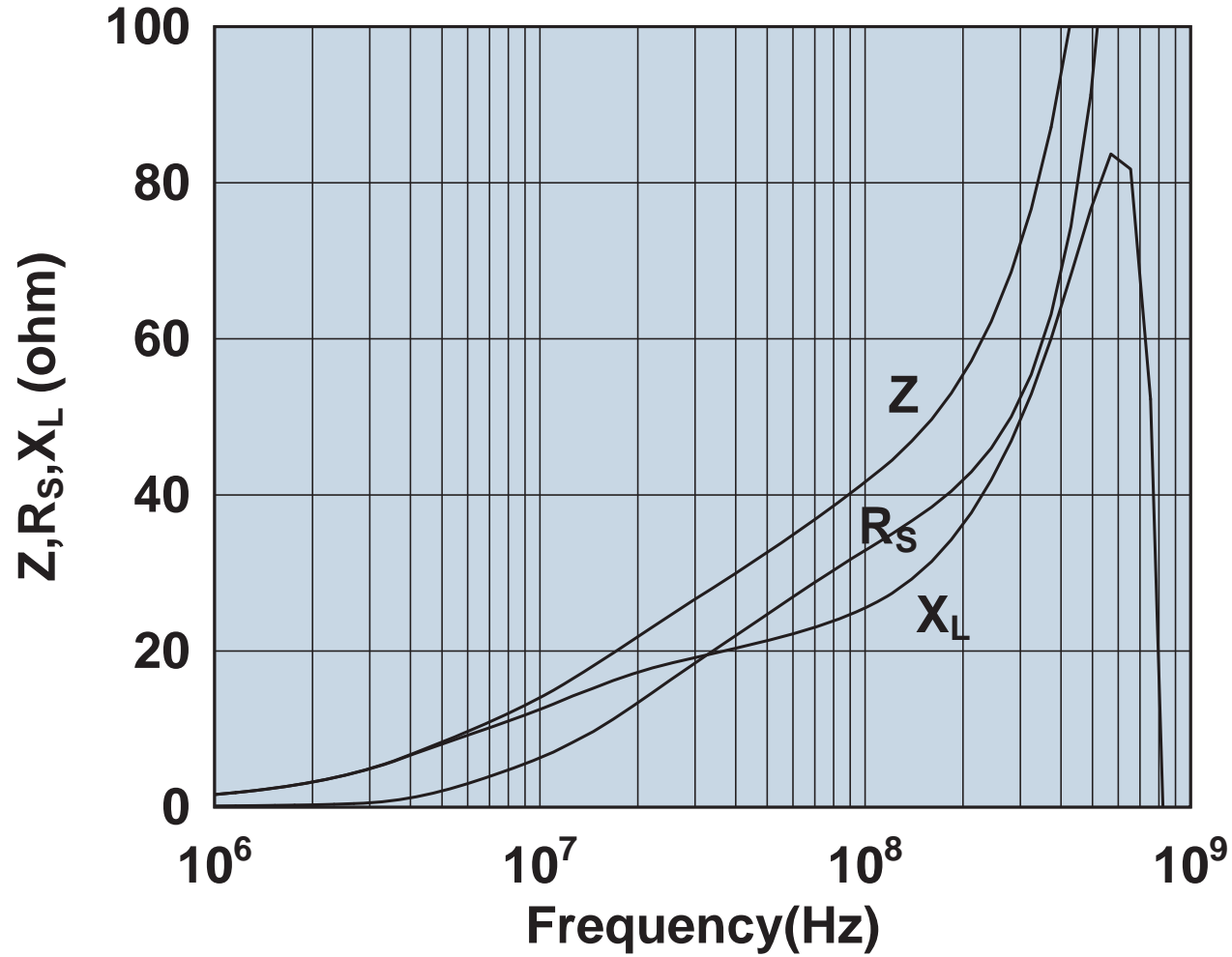

Impedance, reactance, and resistance vs. frequency.

2643801002

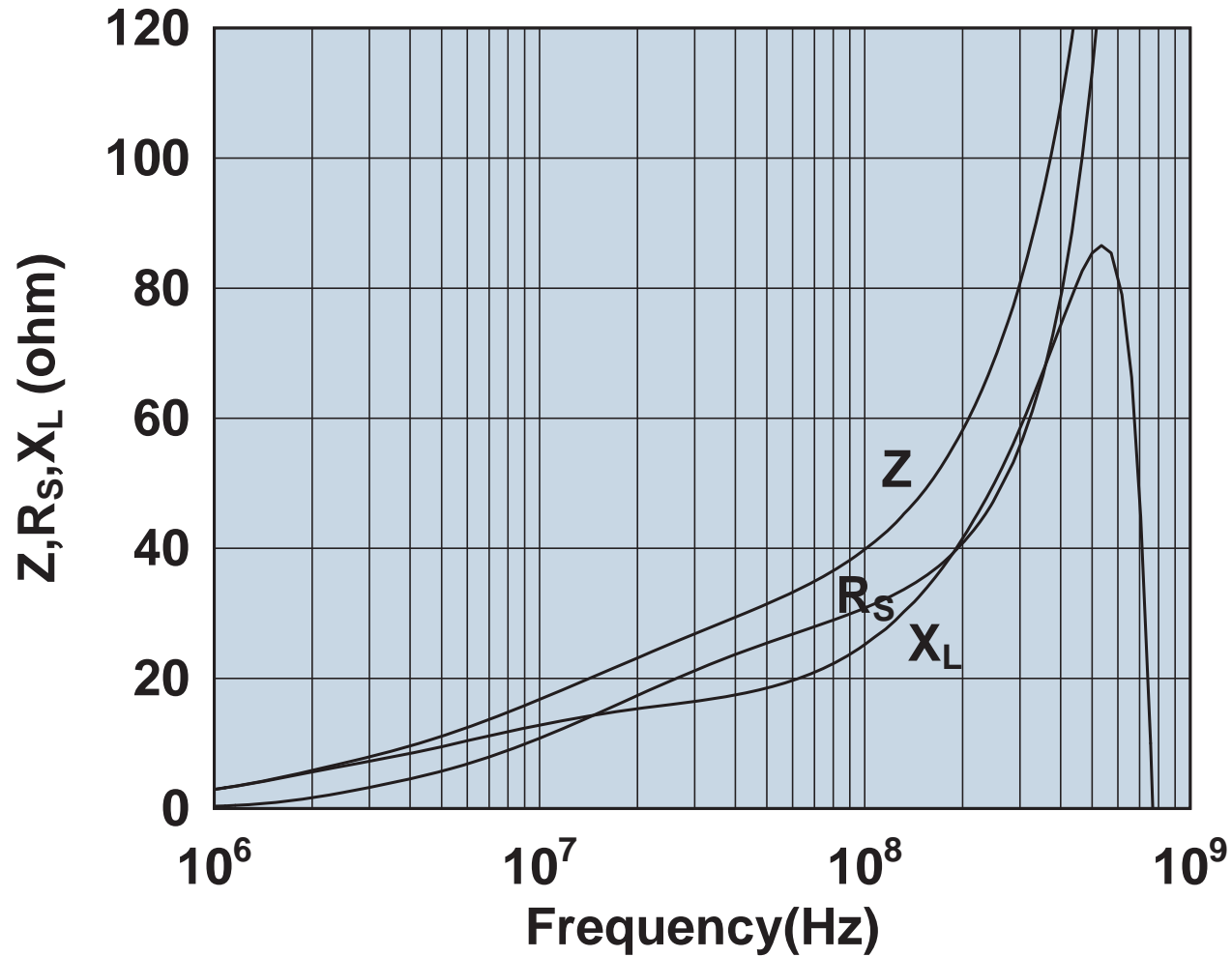

Impedance, reactance, and resistance vs. frequency.

2643801102

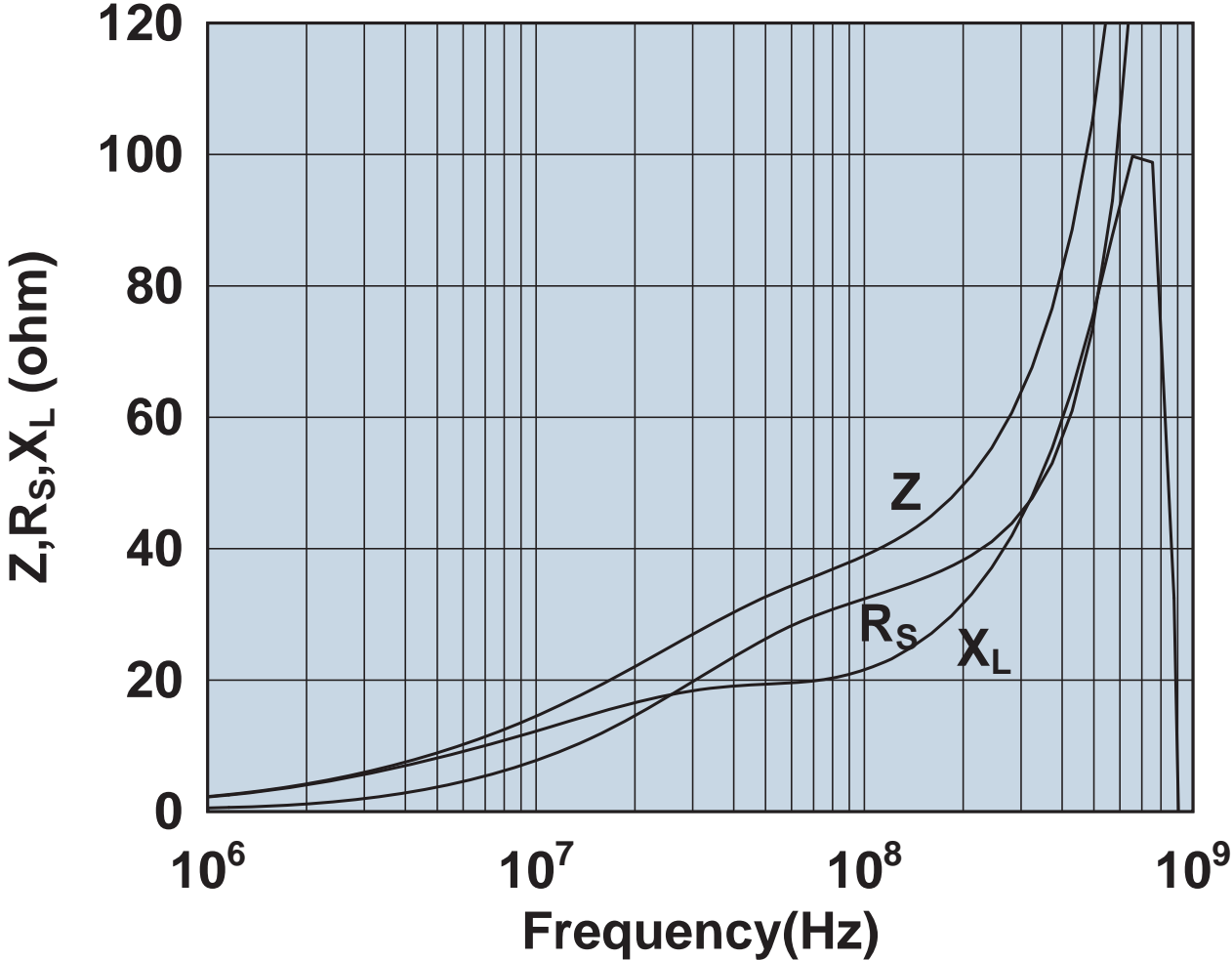

Impedance, reactance, and resistance vs. frequency.

2643801202

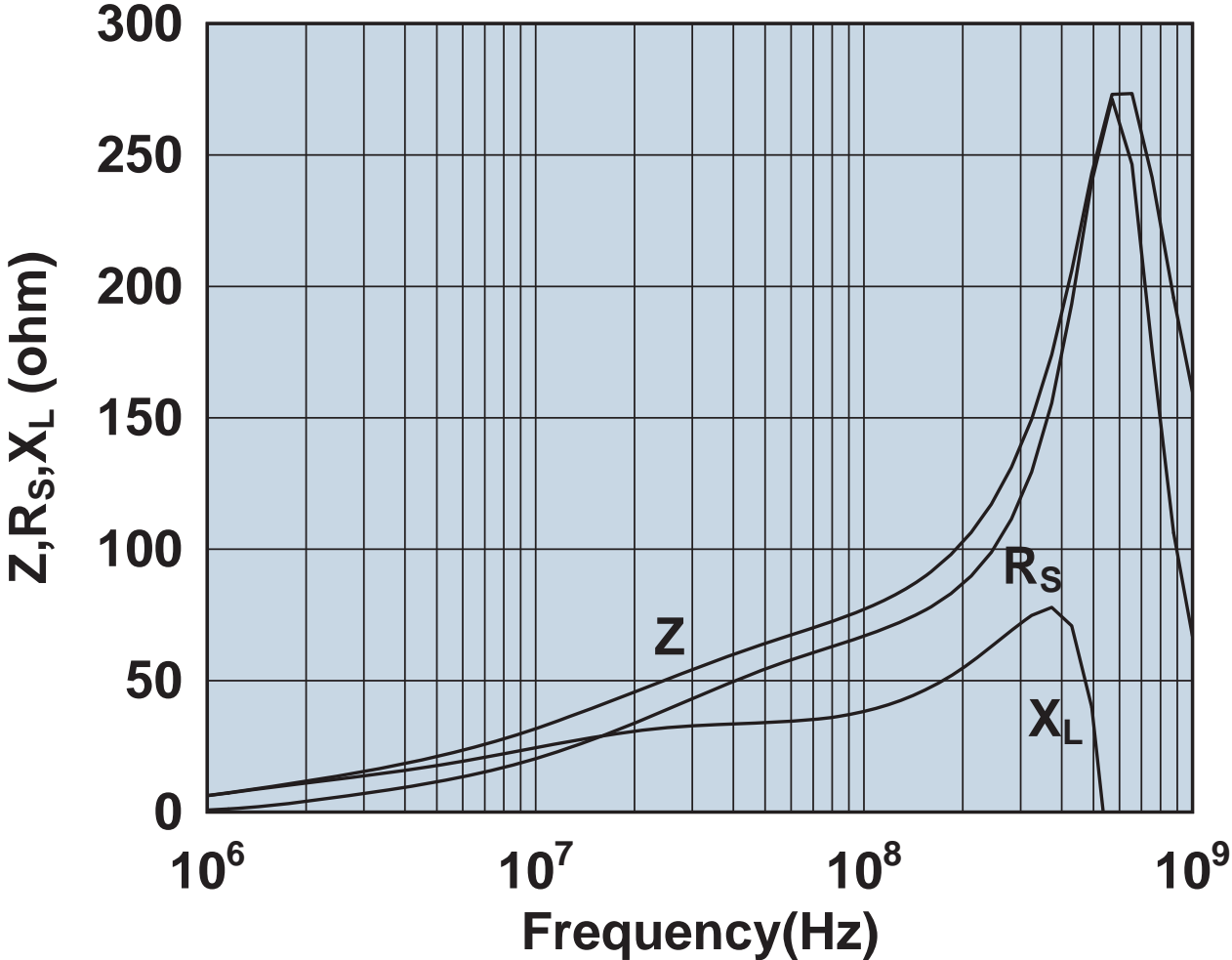

Impedance, reactance, and resistance vs. frequency.



2643801402

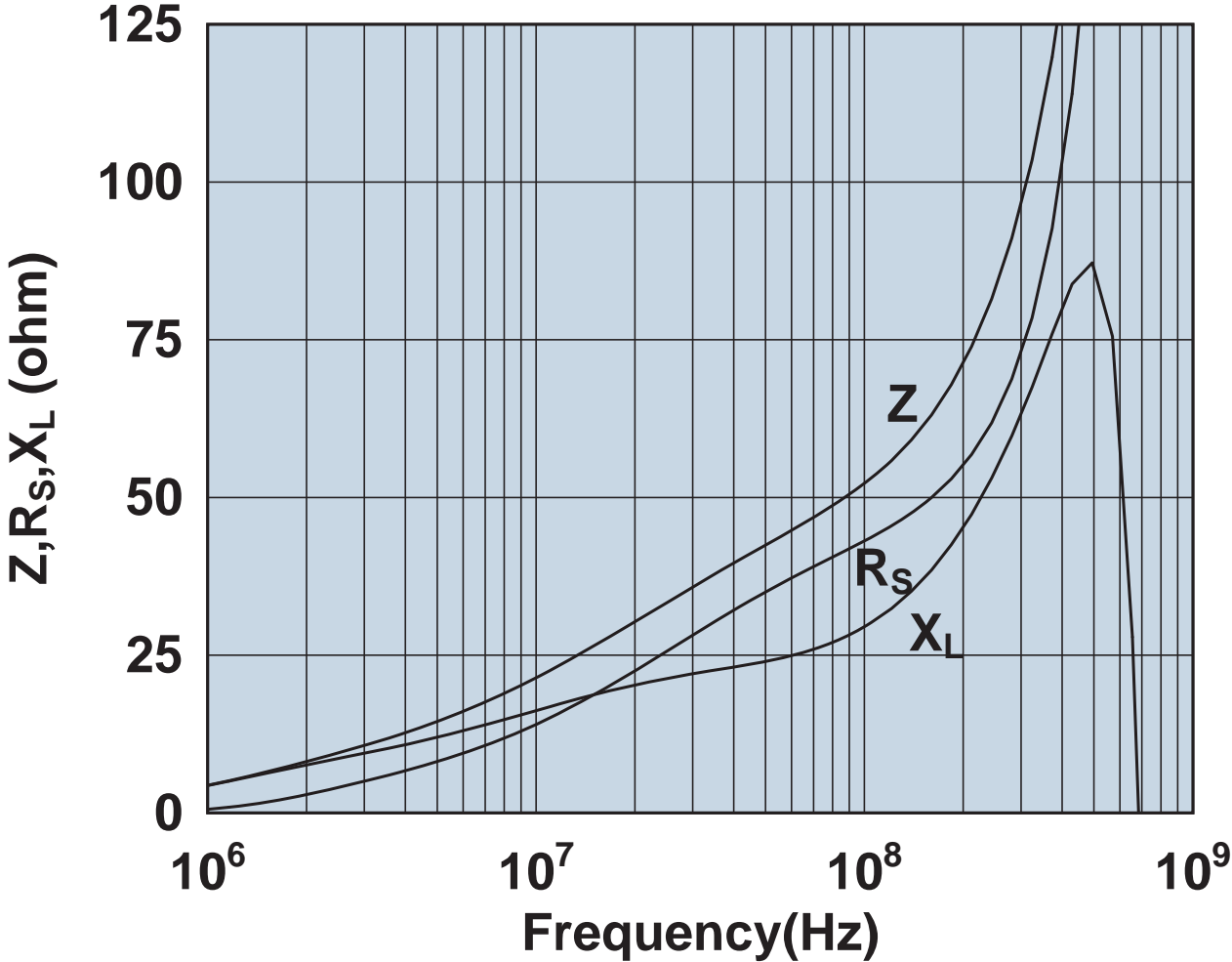

Impedance, reactance, and resistance vs. frequency.

2643801502

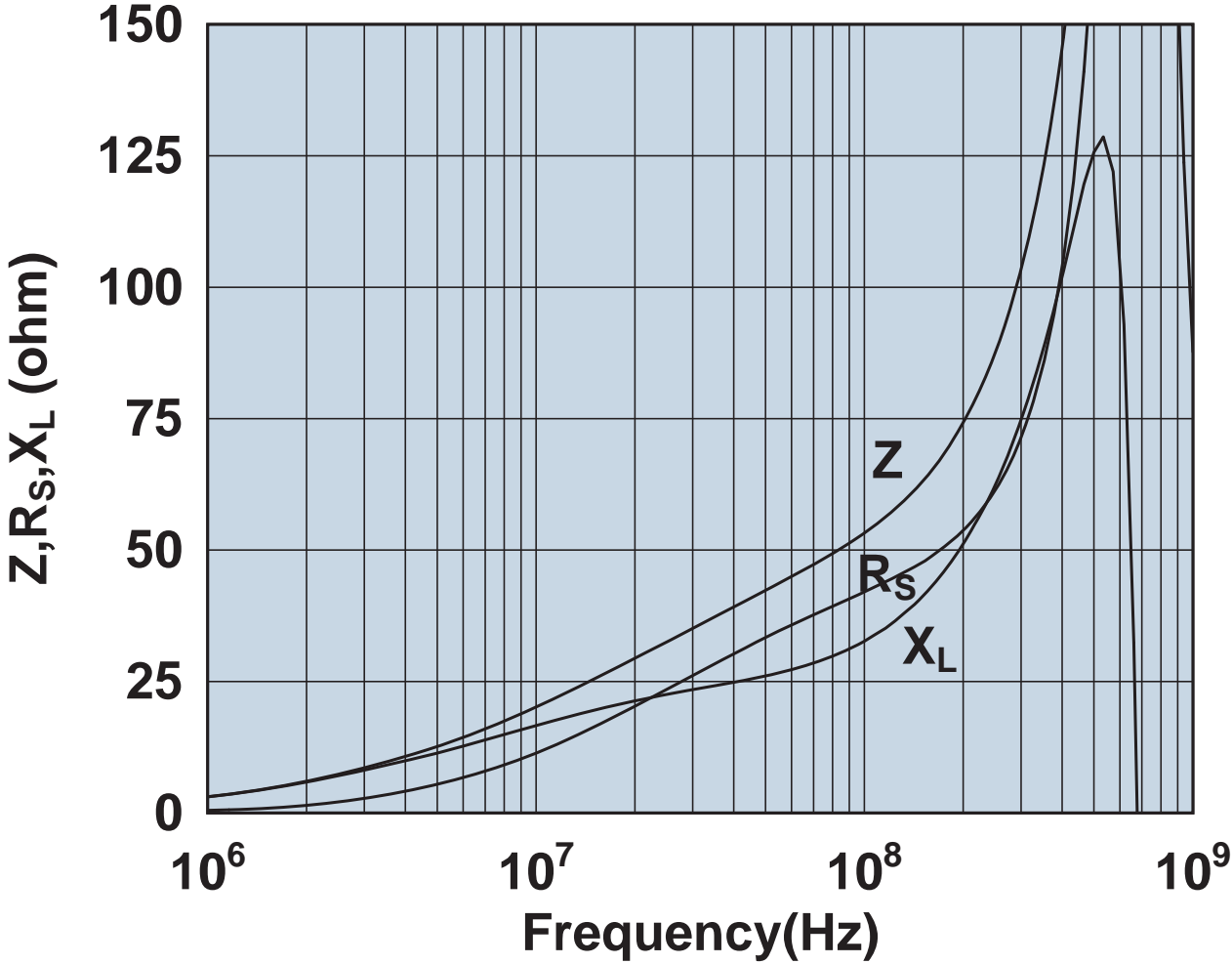

Impedance, reactance, and resistance vs. frequency.

2643801802

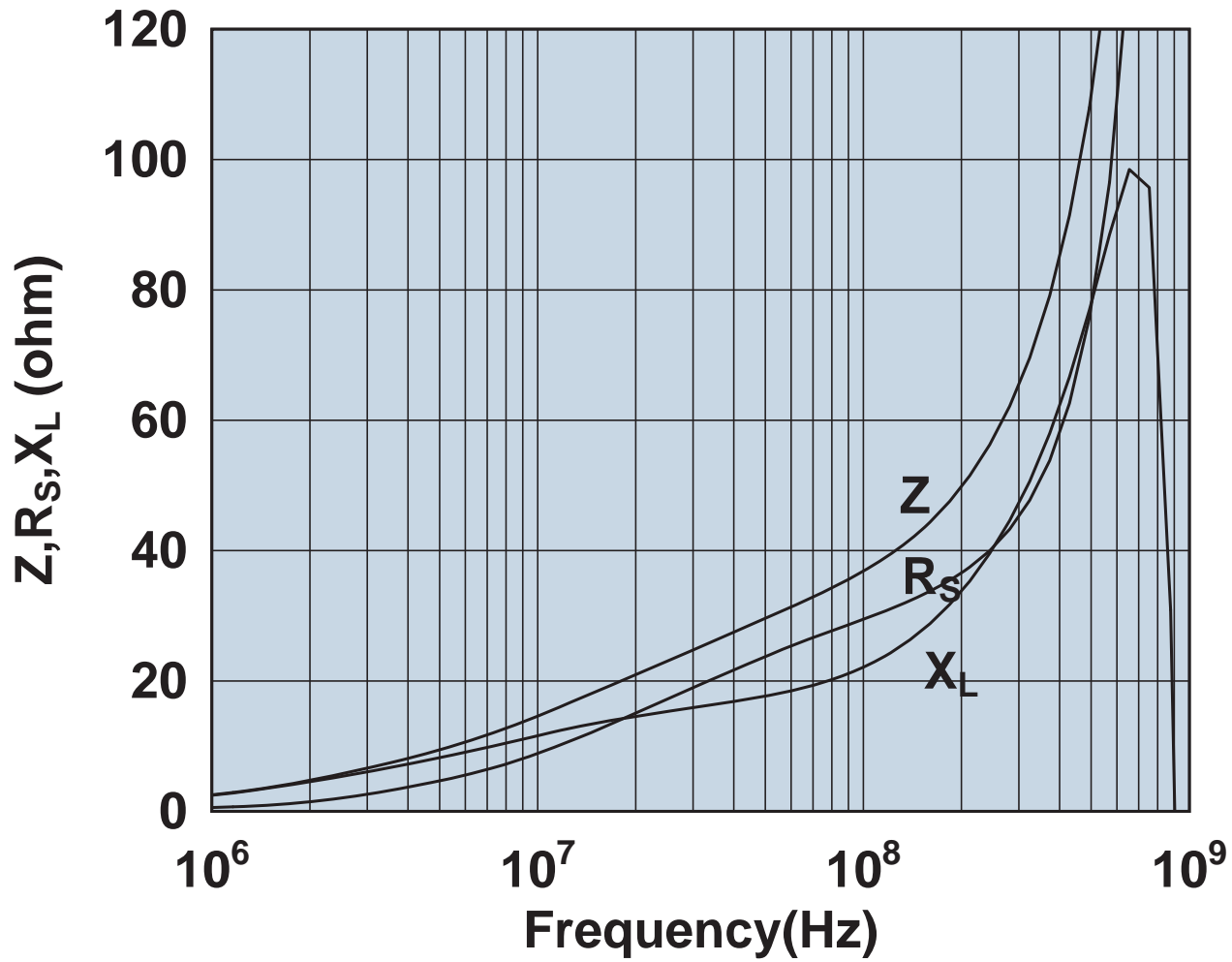

Impedance, reactance, and resistance vs. frequency.

2643801902

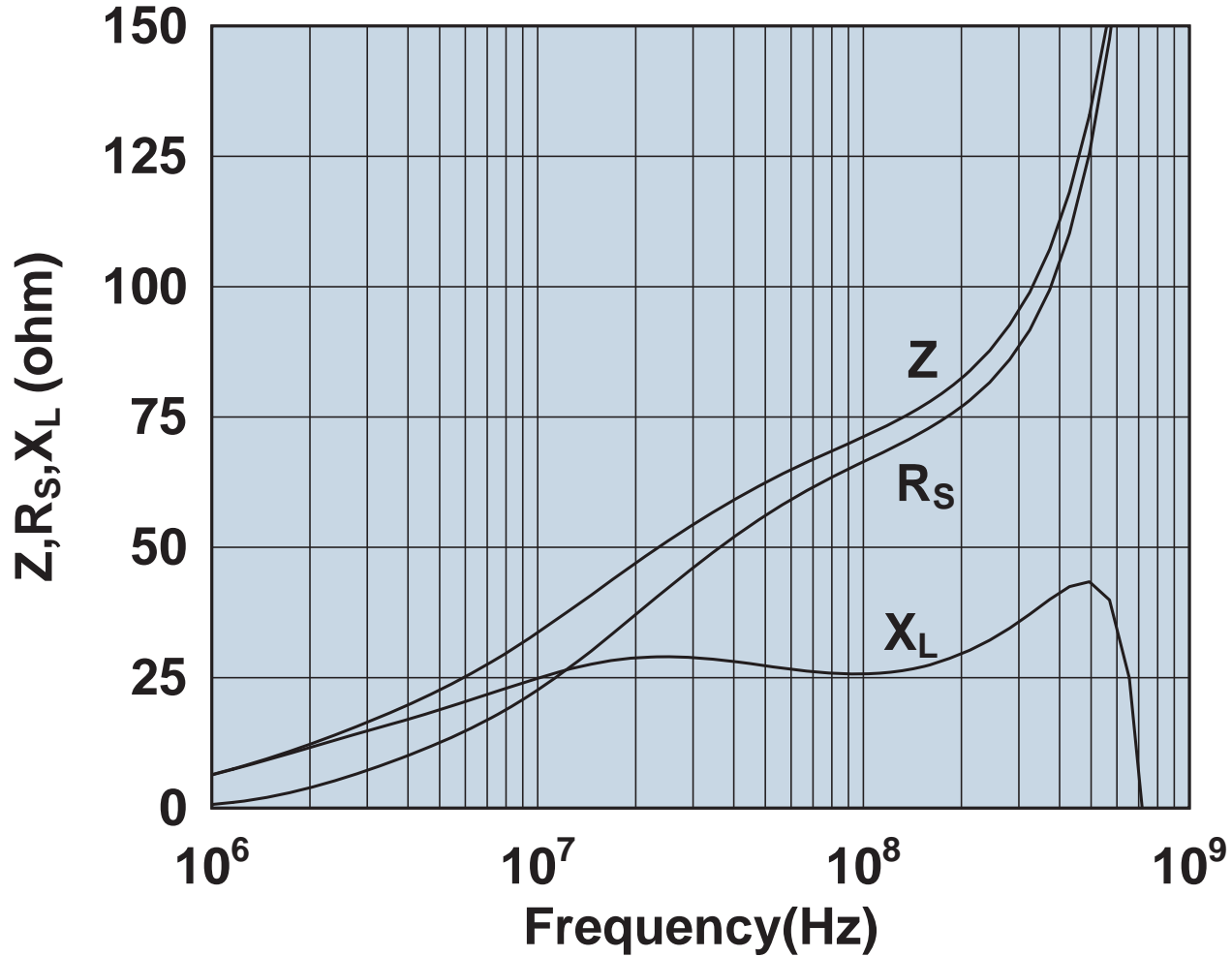

Impedance, reactance, and resistance vs. frequency.

2643802702

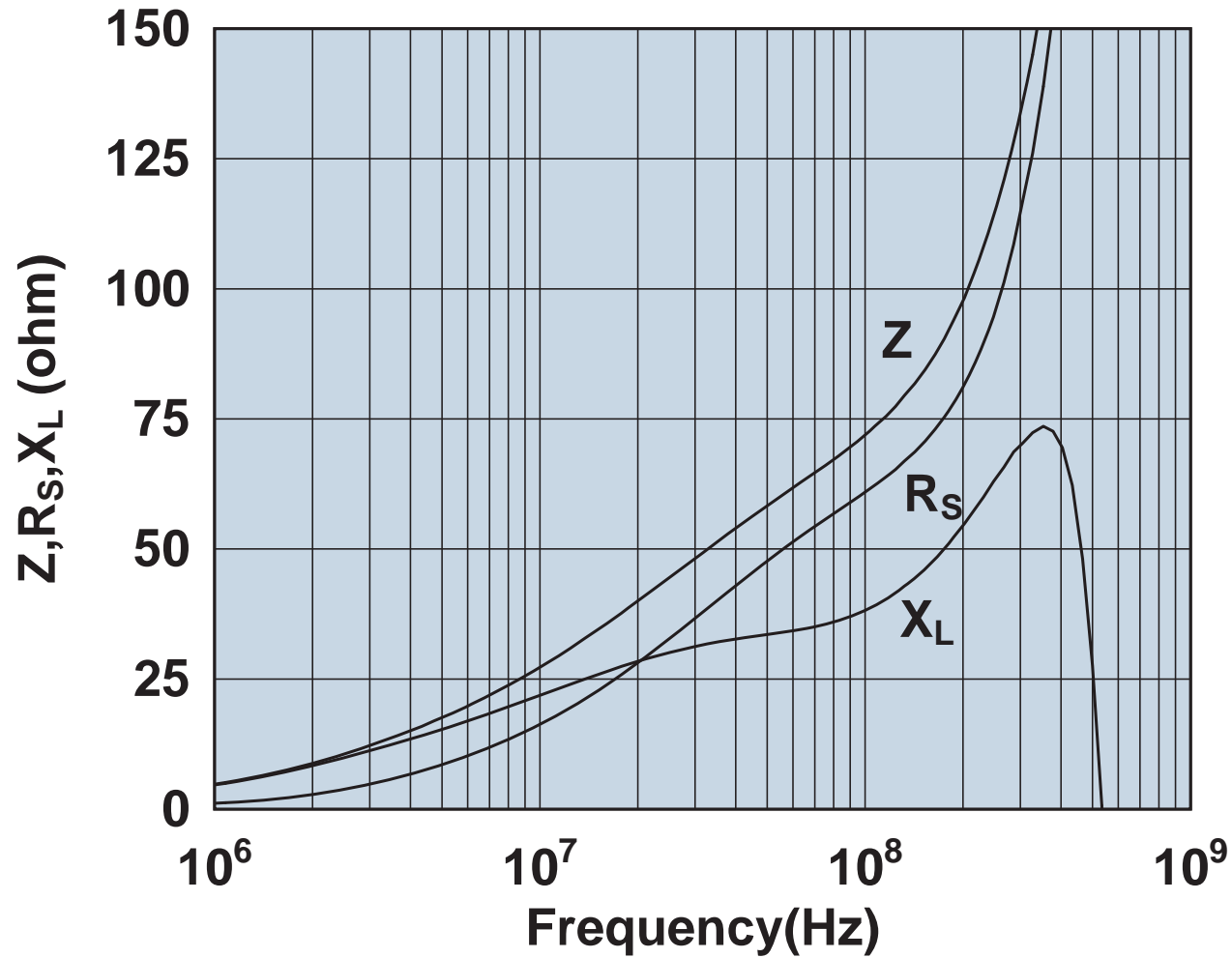

Impedance, reactance, and resistance vs. frequency.

2643803802

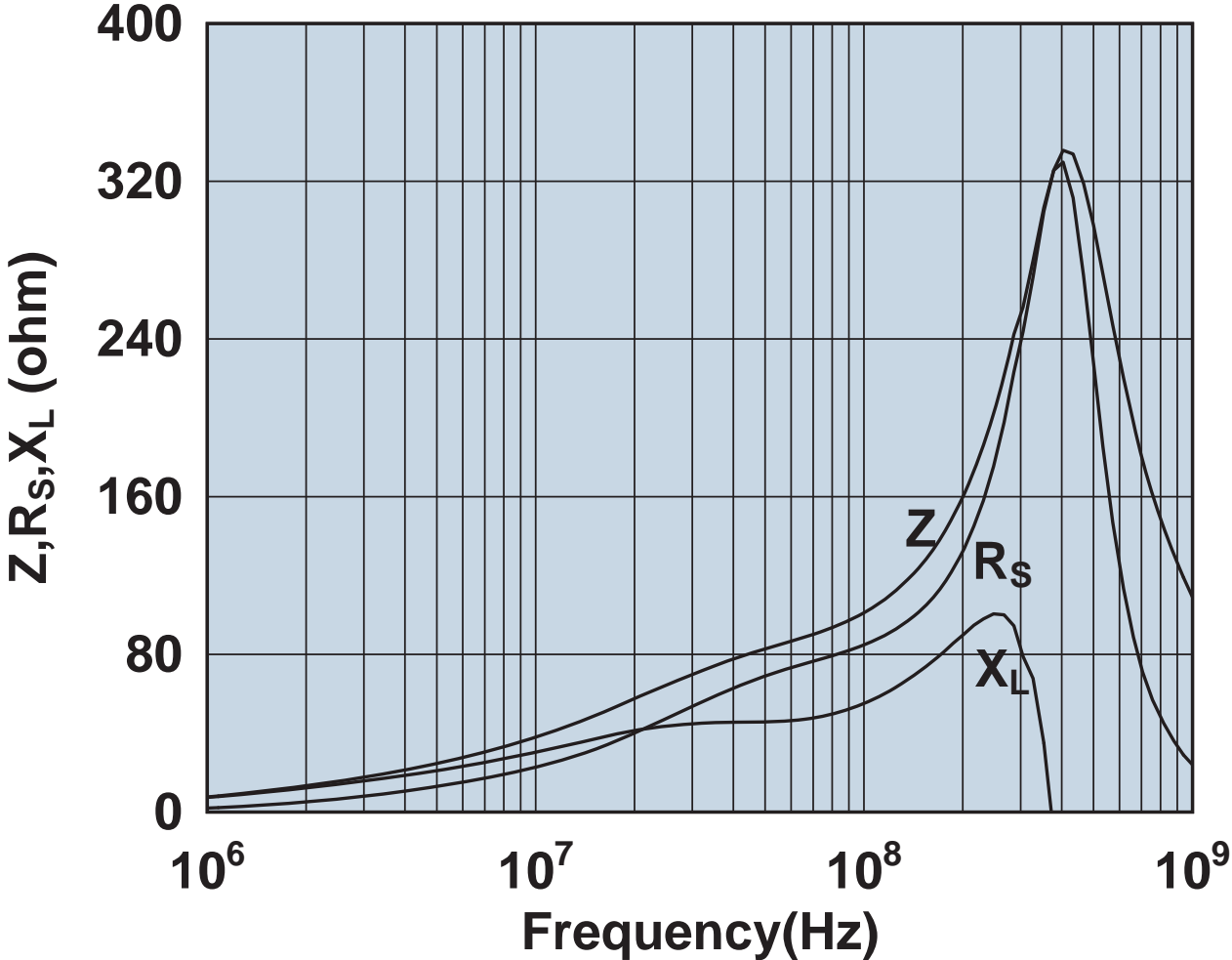

Impedance, reactance, and resistance vs. frequency.

2643804502

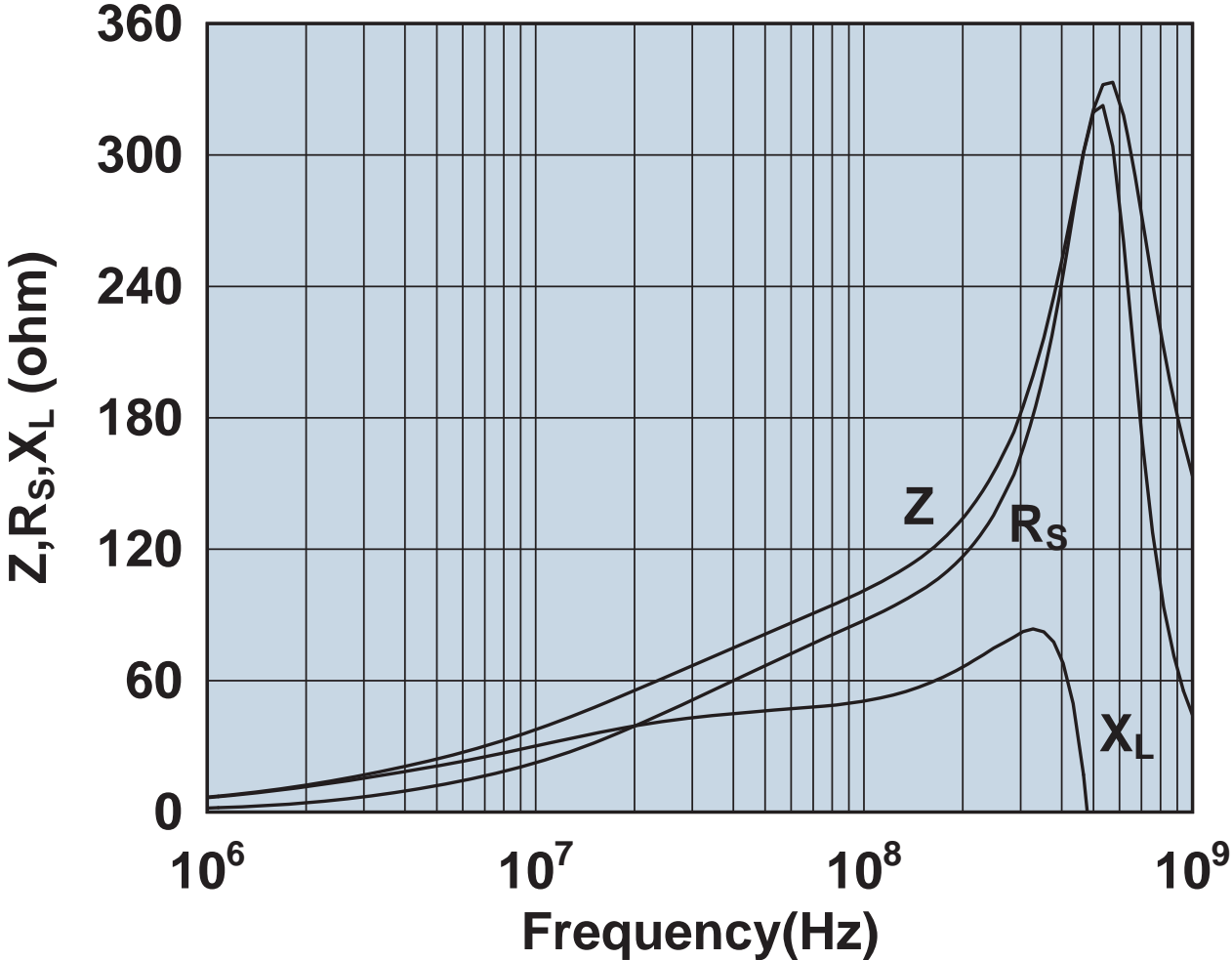

Impedance, reactance, and resistance vs. frequency.

2643806402

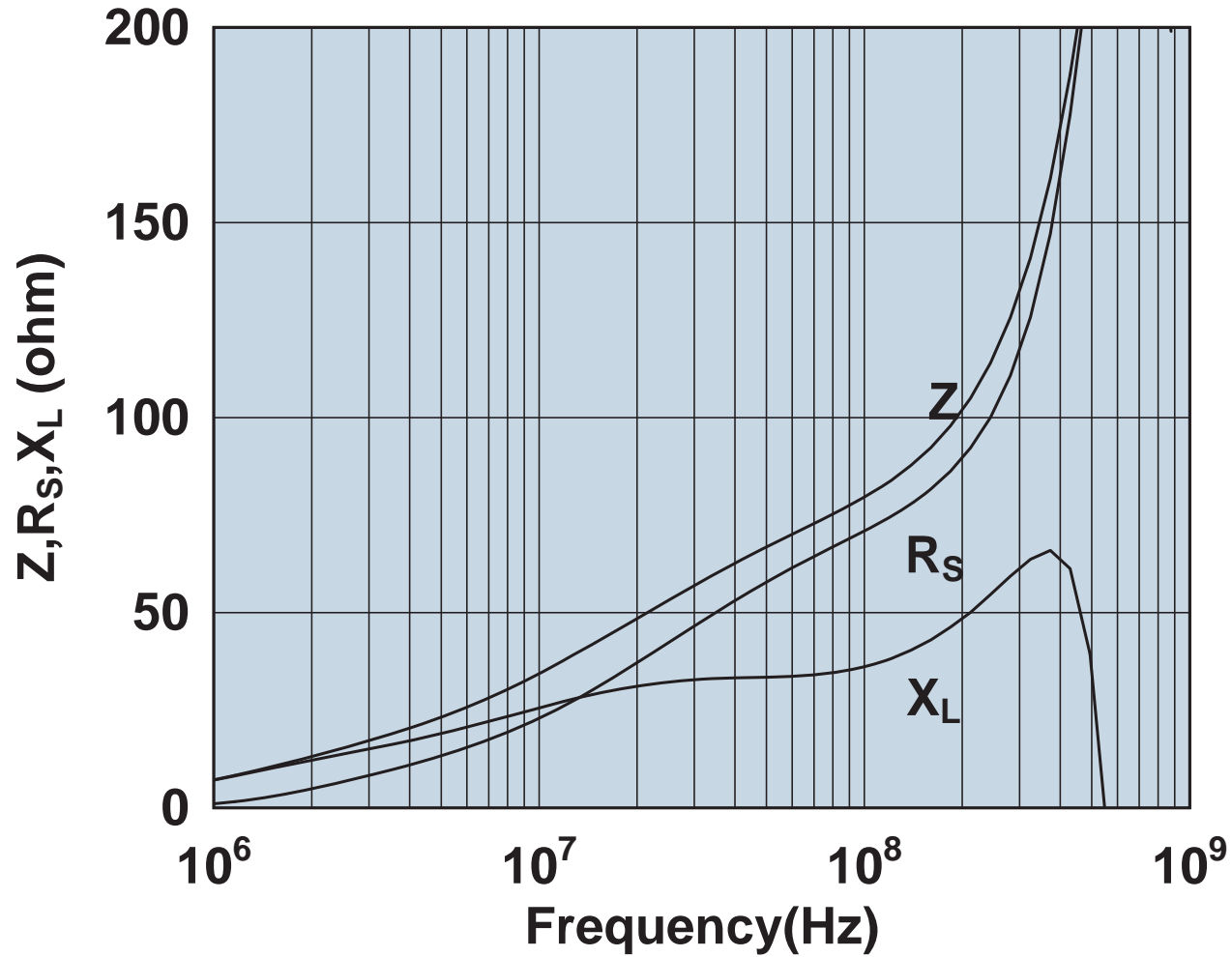

Impedance, reactance, and resistance vs. frequency.



2643806406

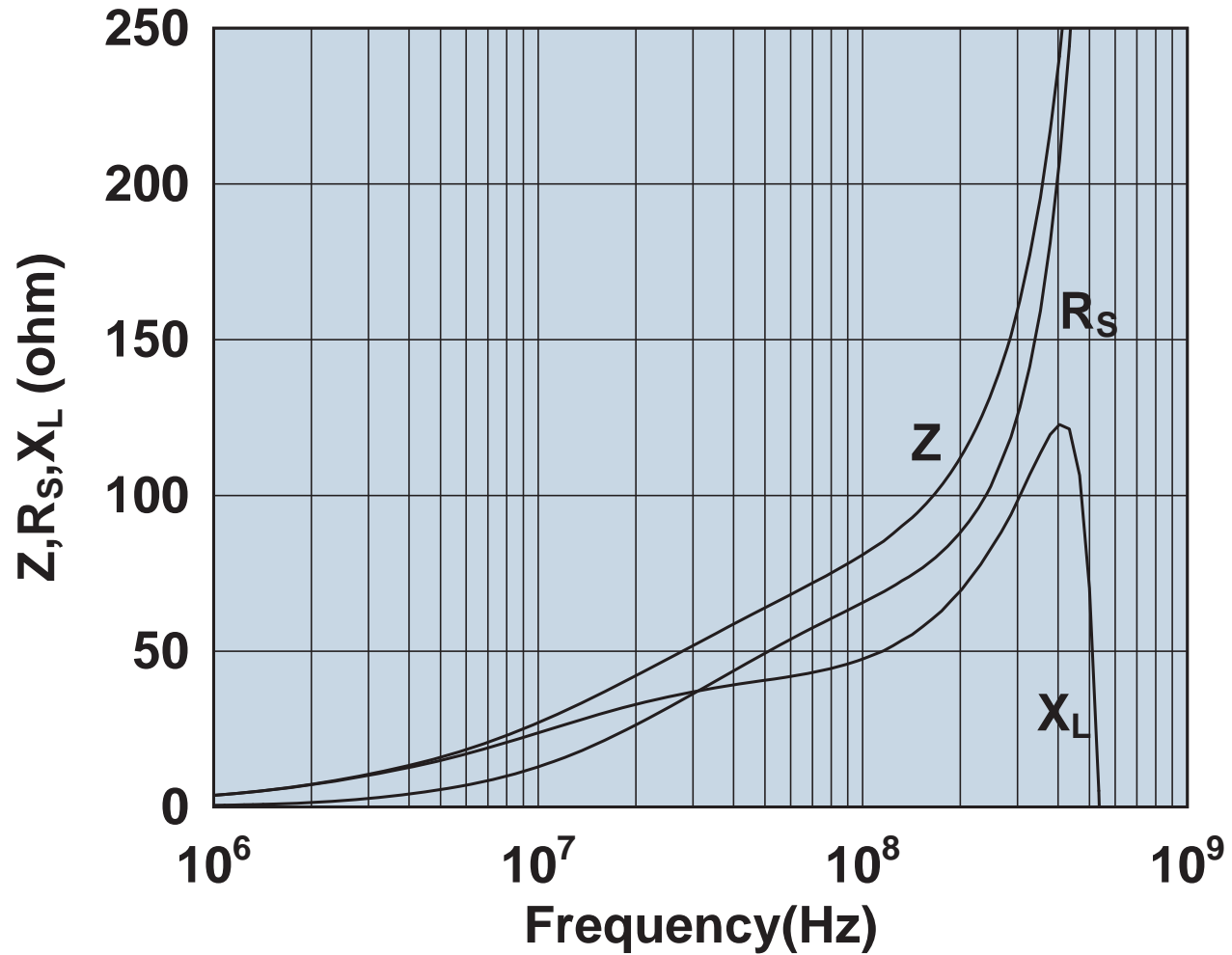

Impedance, reactance, and resistance vs. frequency.

2644164181

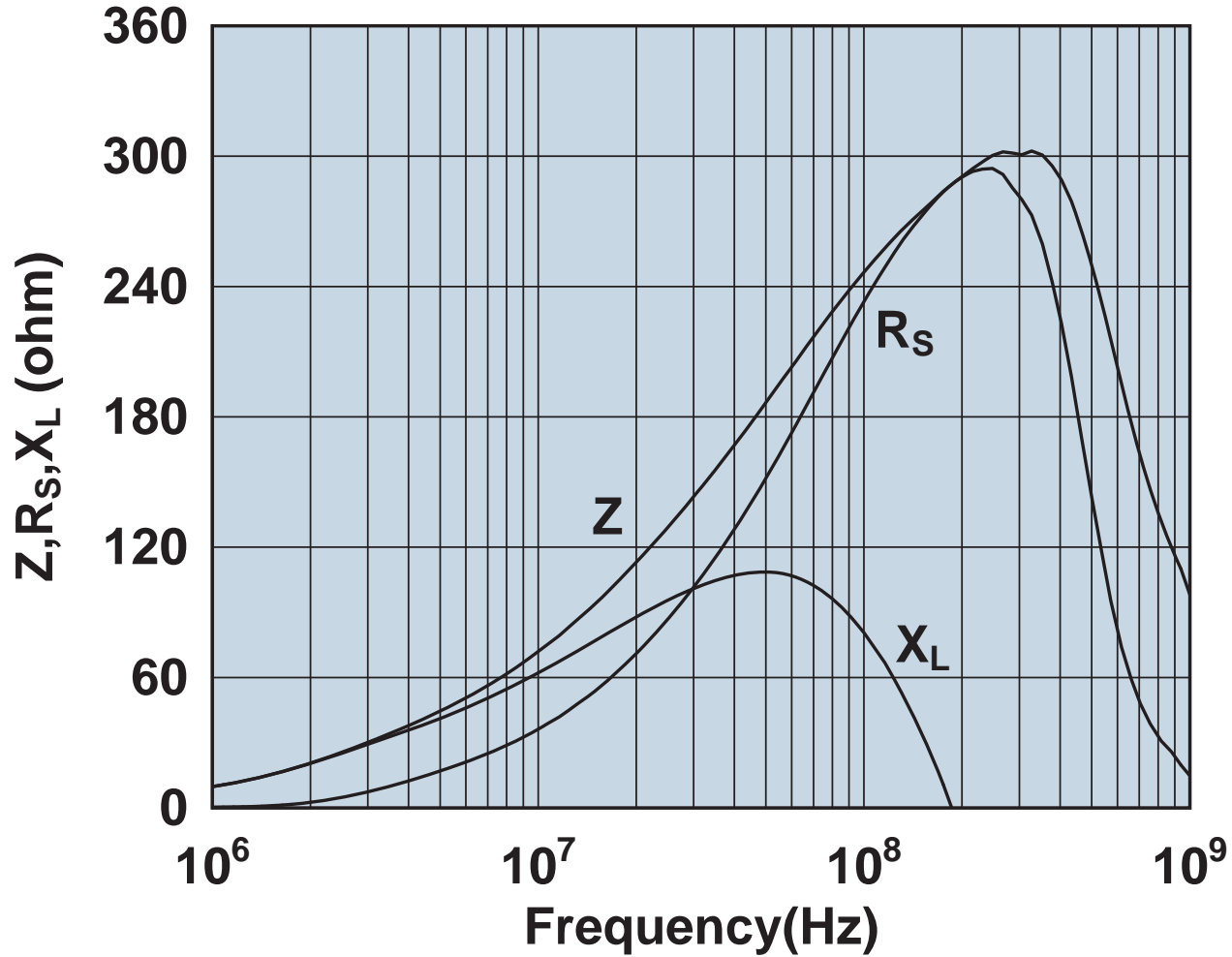

Impedance, reactance, and resistance vs. frequency.

2644164281

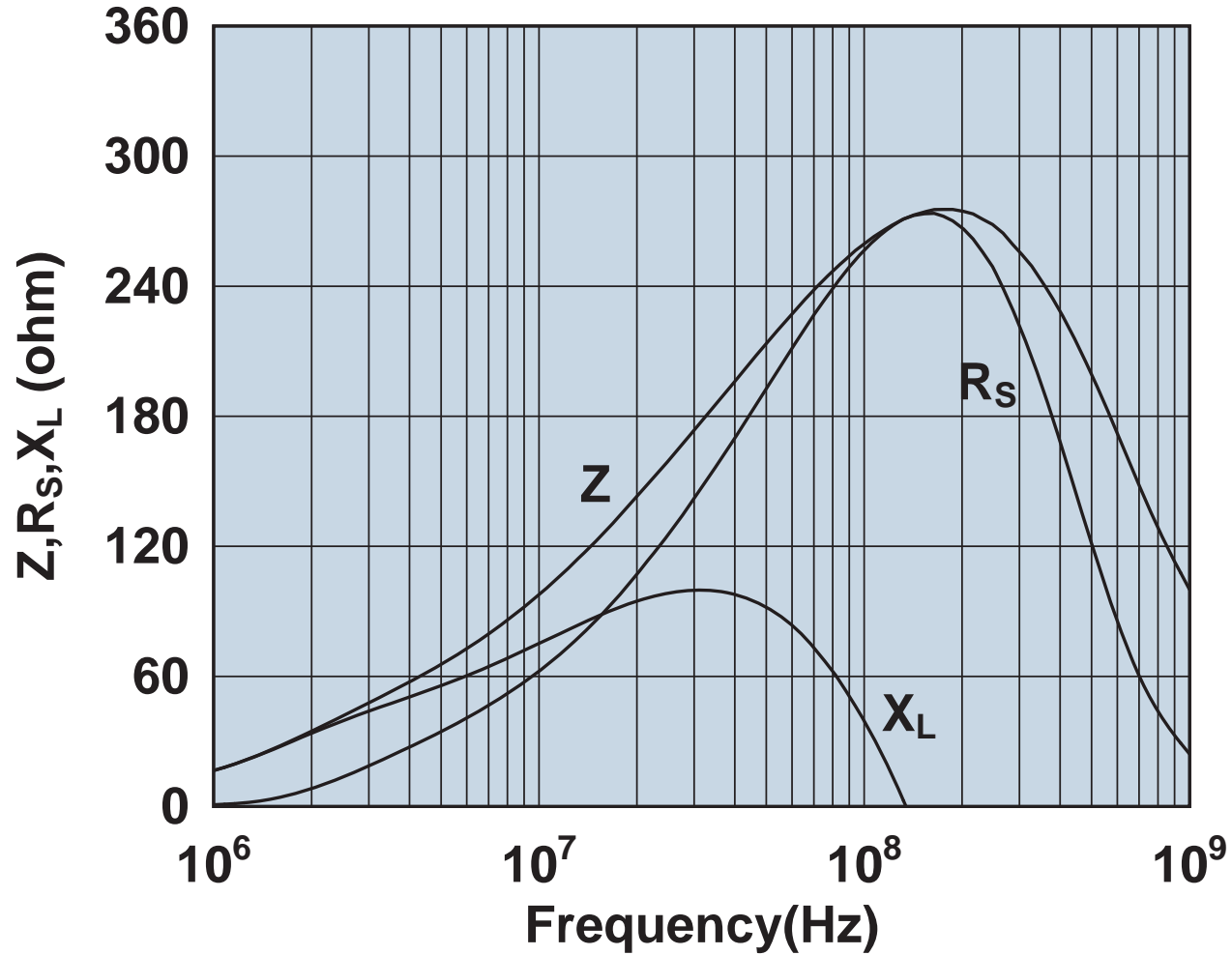

Impedance, reactance, and resistance vs. frequency.

2644164951

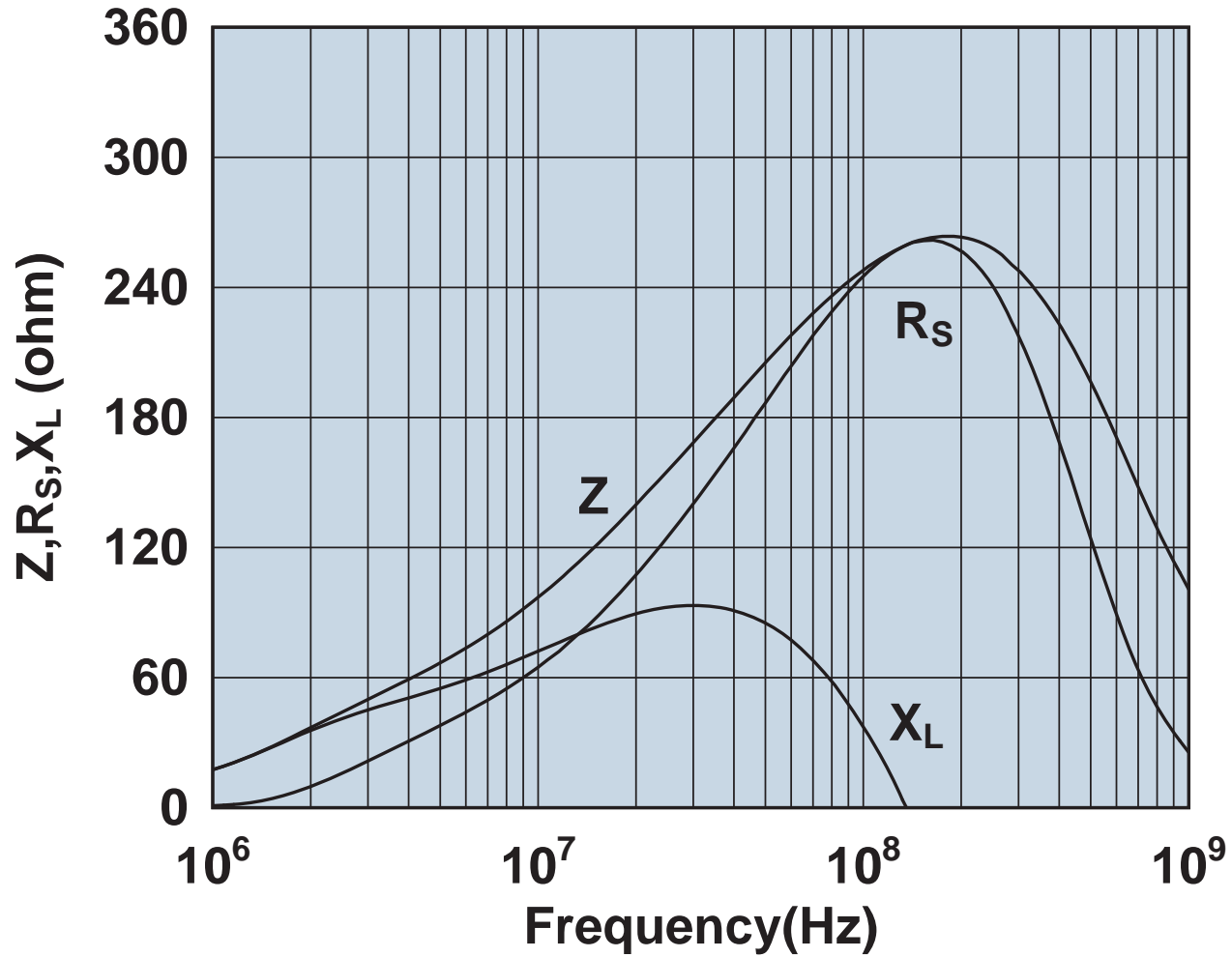

Impedance, reactance, and resistance vs. frequency.

2644167281

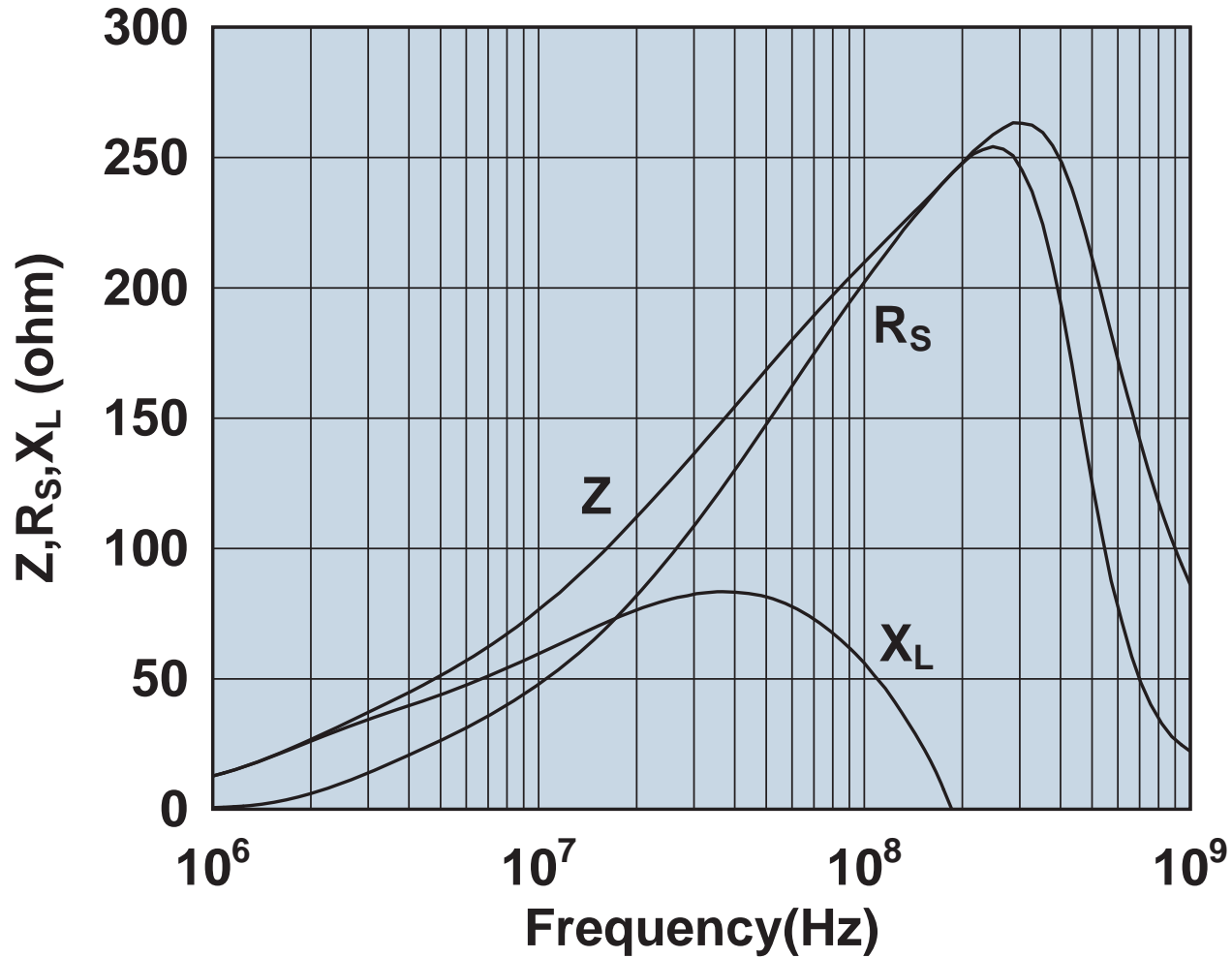

Impedance, reactance, and resistance vs. frequency.

2644173551

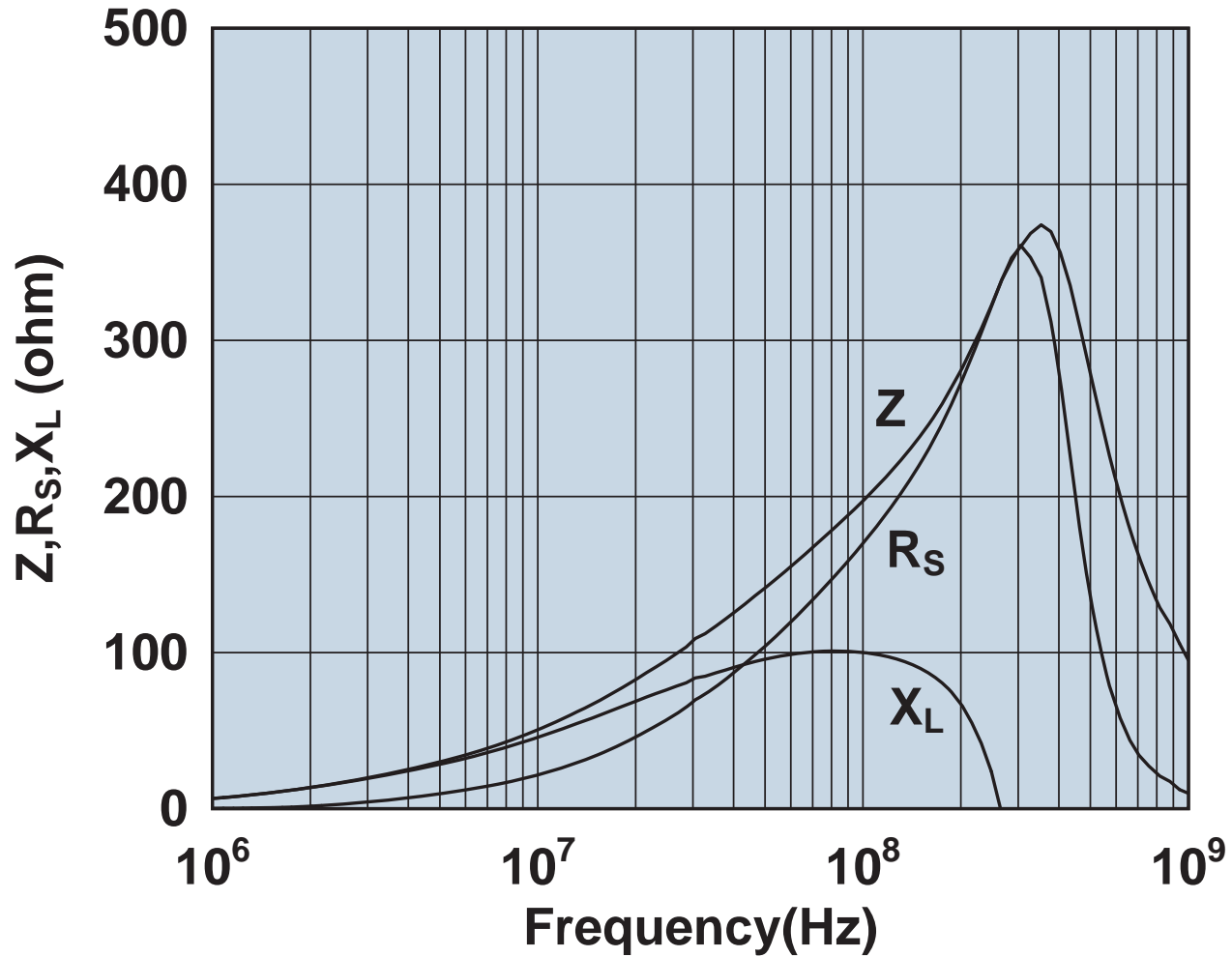

Impedance, reactance, and resistance vs. frequency.

2644173951

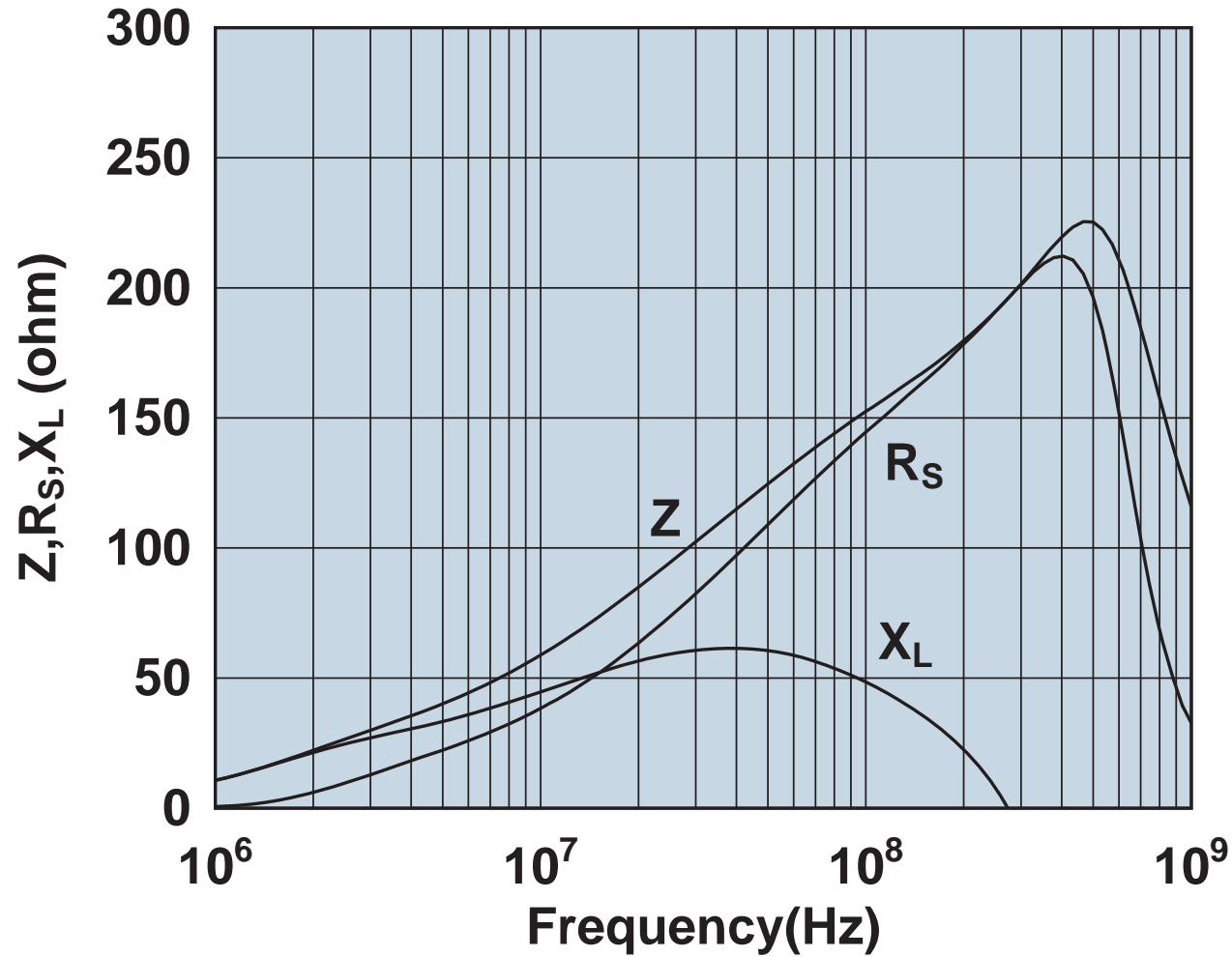

Impedance, reactance, and resistance vs. frequency.

2644176451

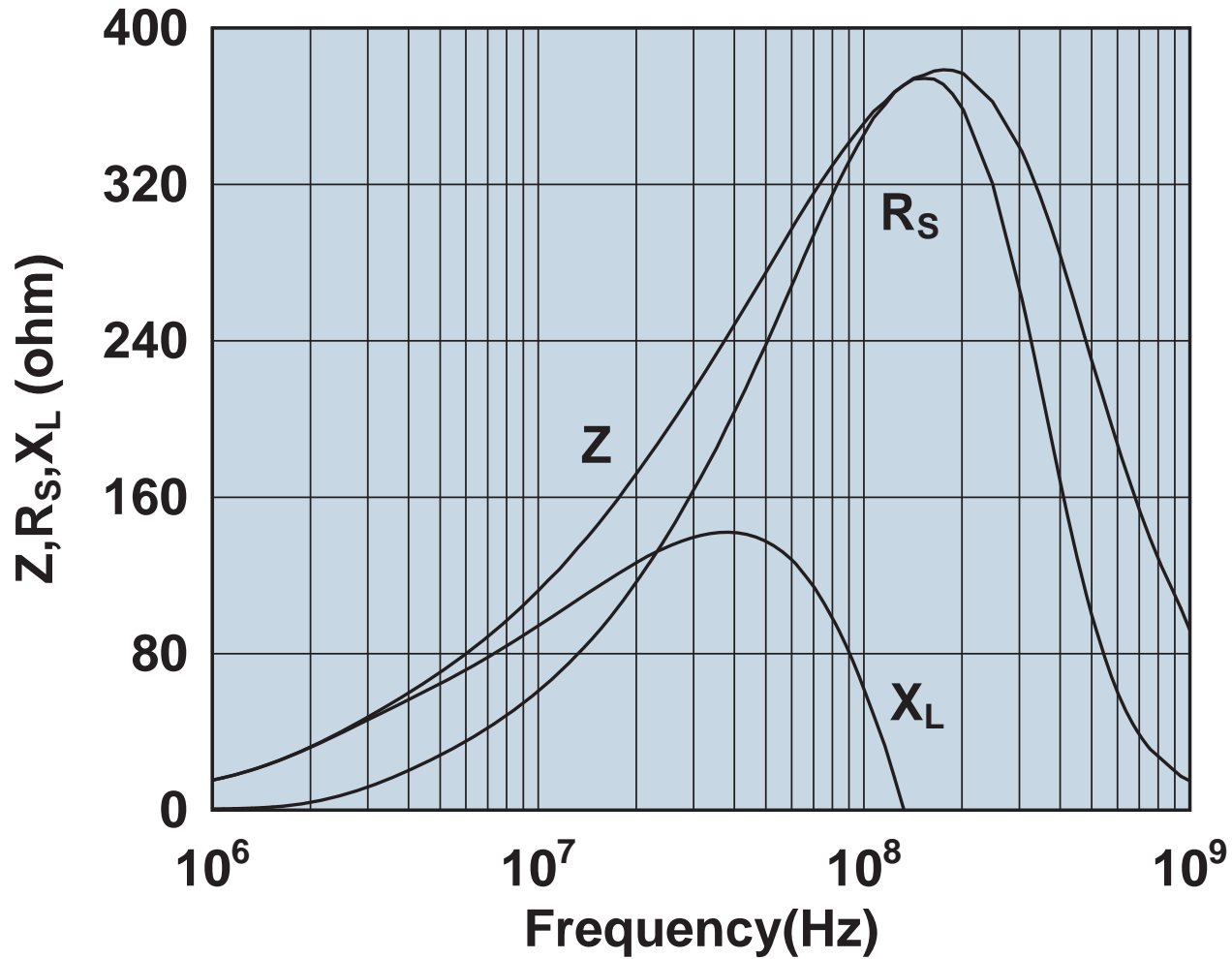

Impedance, reactance, and resistance vs. frequency.



2644177081

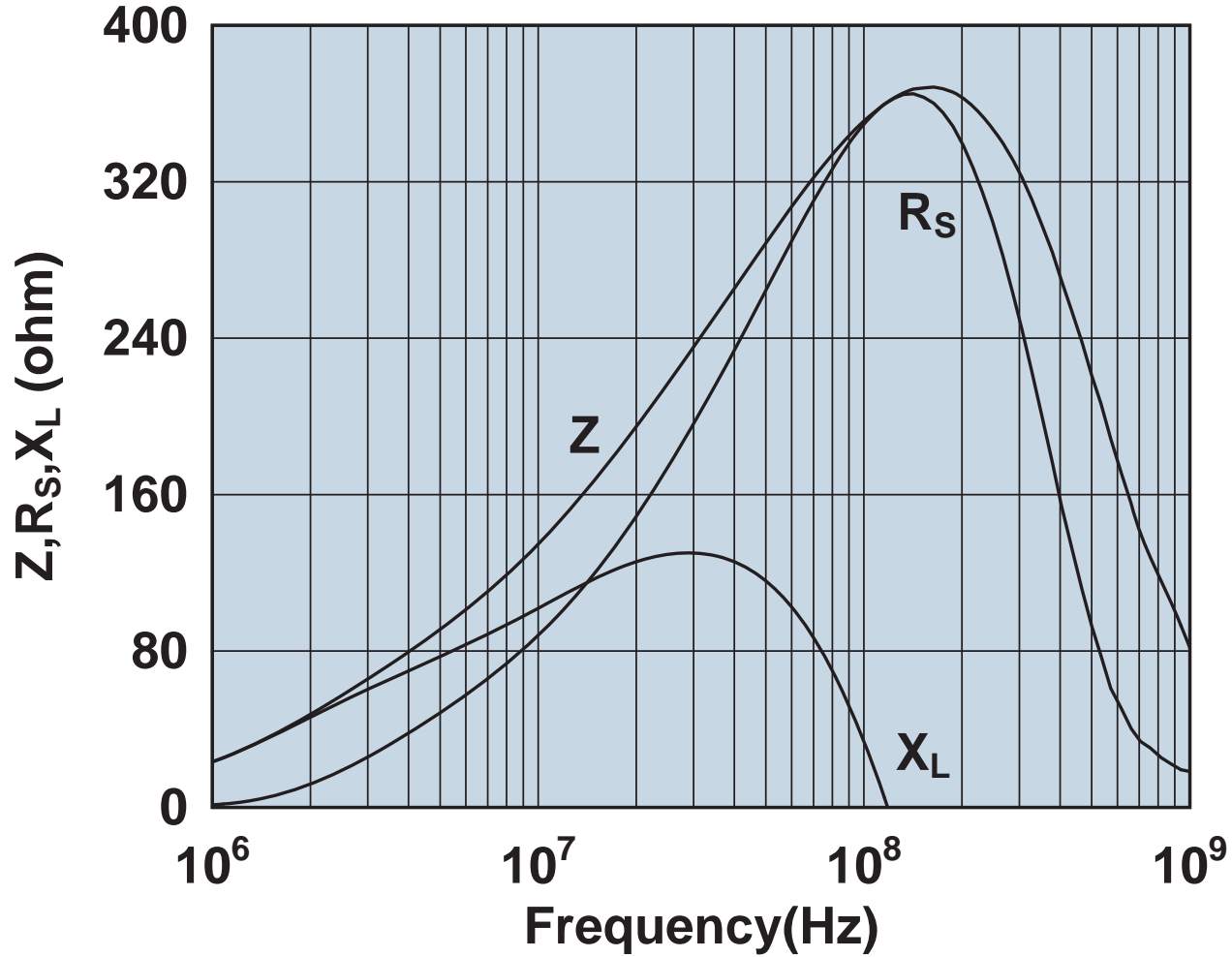

Impedance, reactance, and resistance vs. frequency.

2644236001

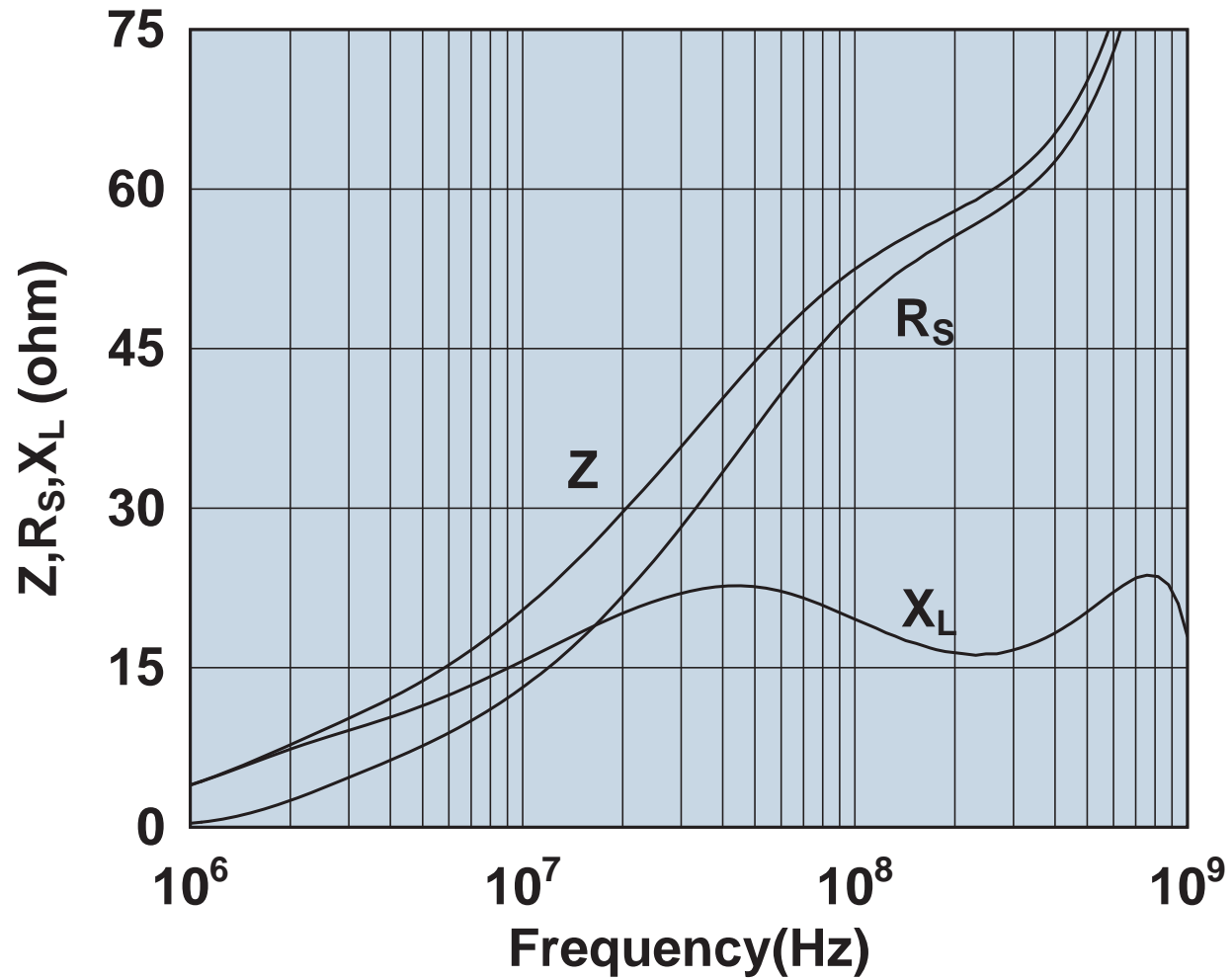

Impedance, reactance, and resistance vs. frequency.

2644236101

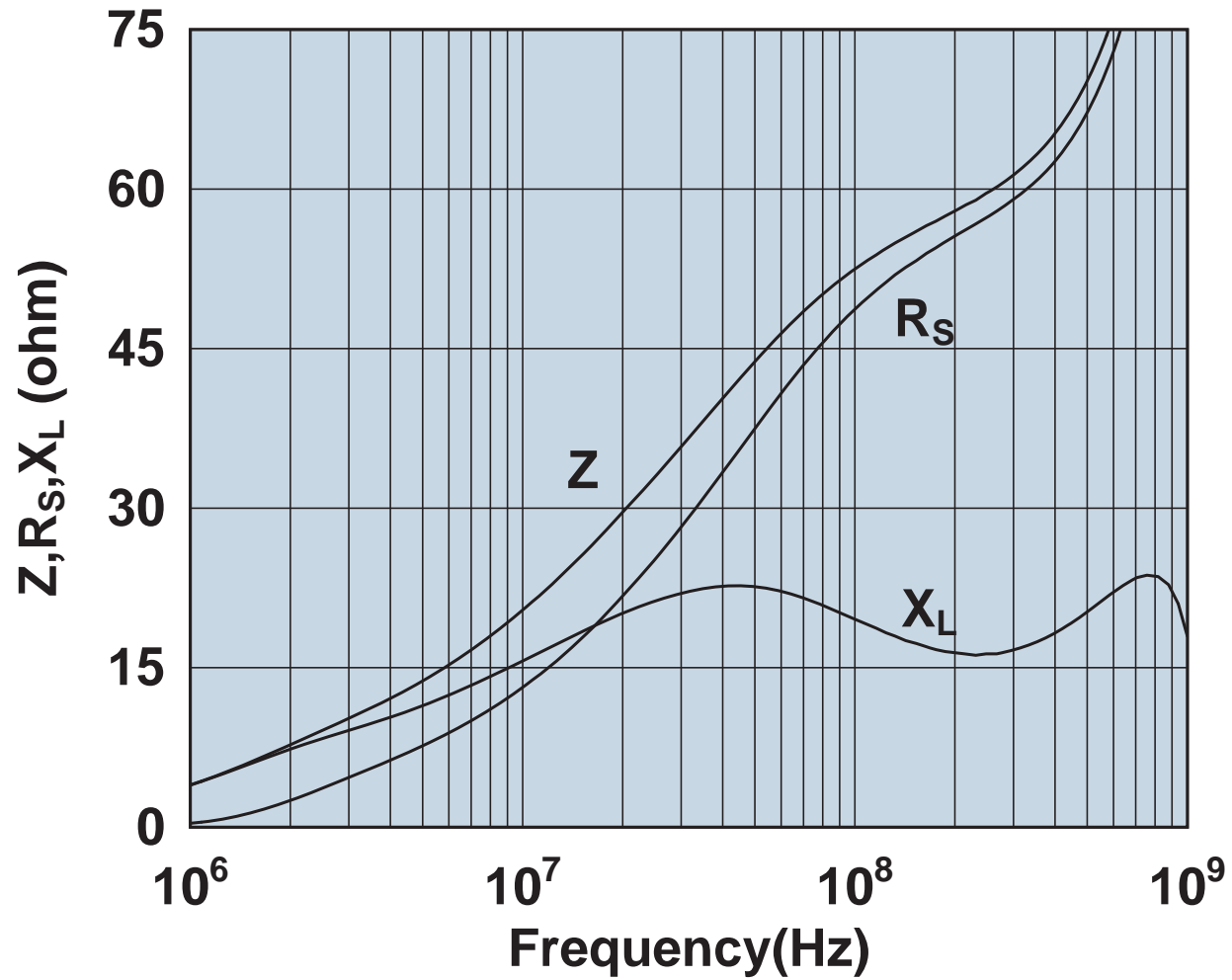

Impedance, reactance, and resistance vs. frequency.

2644236301

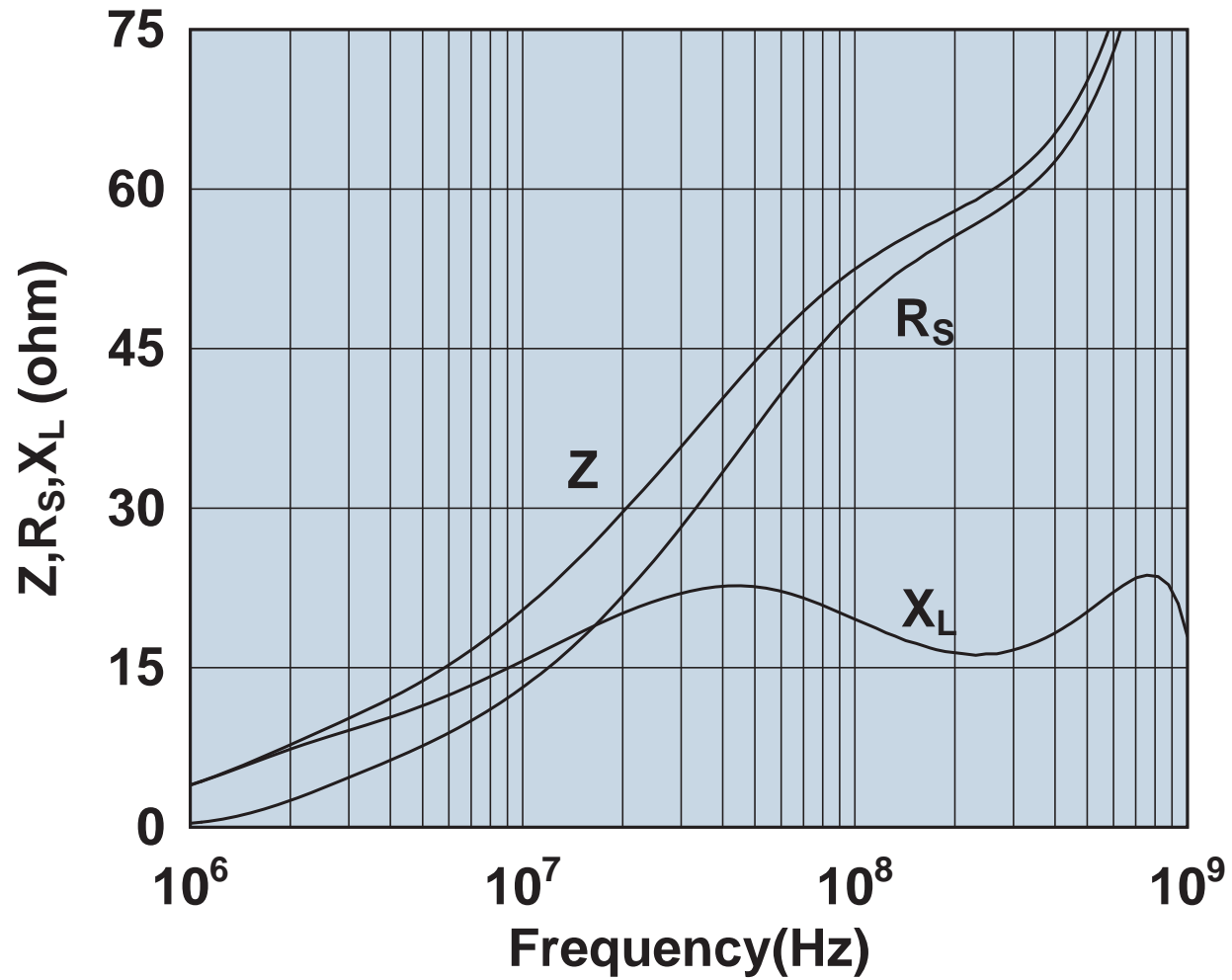

Impedance, reactance, and resistance vs. frequency.

2644236401

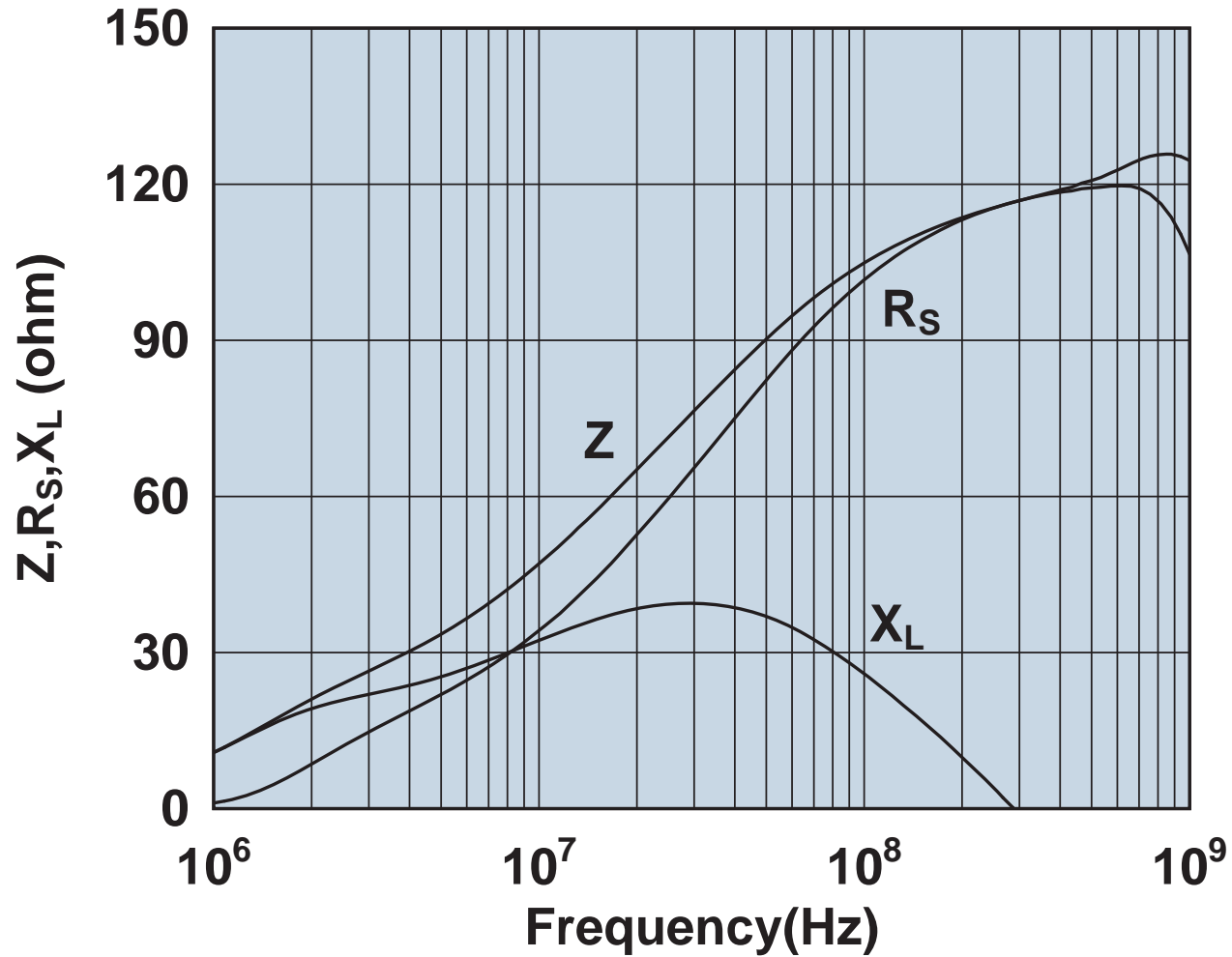

Impedance, reactance, and resistance vs. frequency.

2644236501

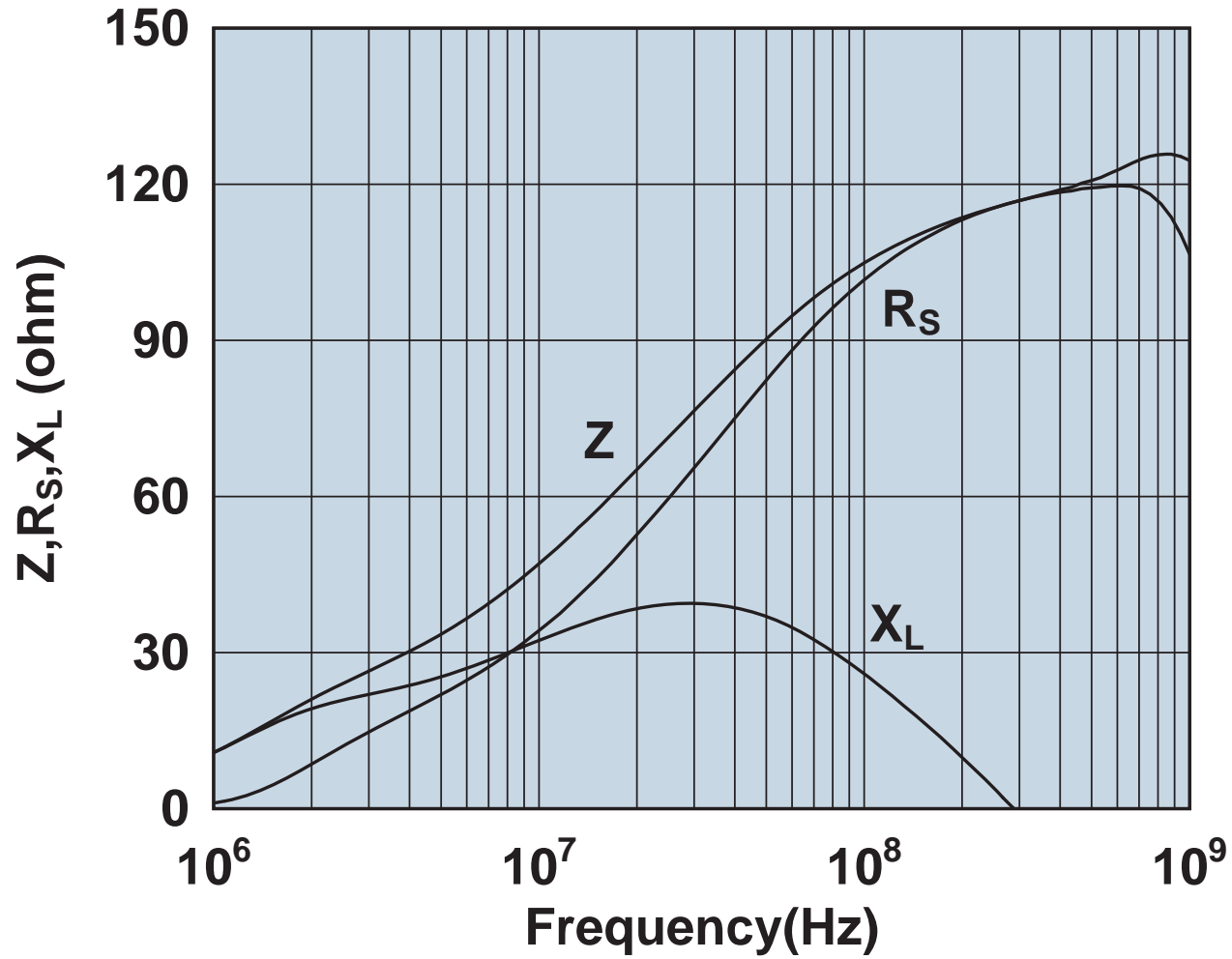

Impedance, reactance, and resistance vs. frequency.

2644236601

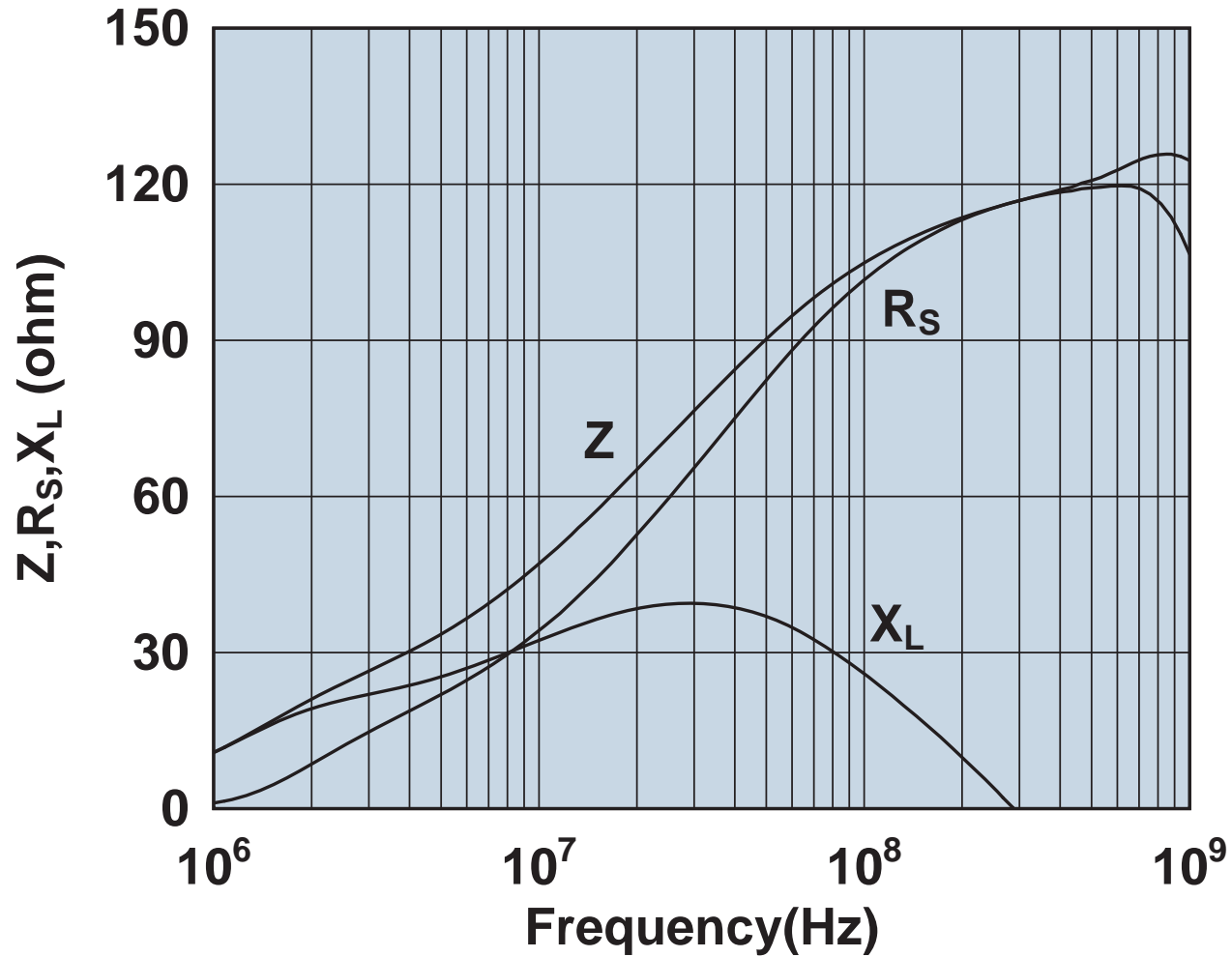

Impedance, reactance, and resistance vs. frequency.

2644245601

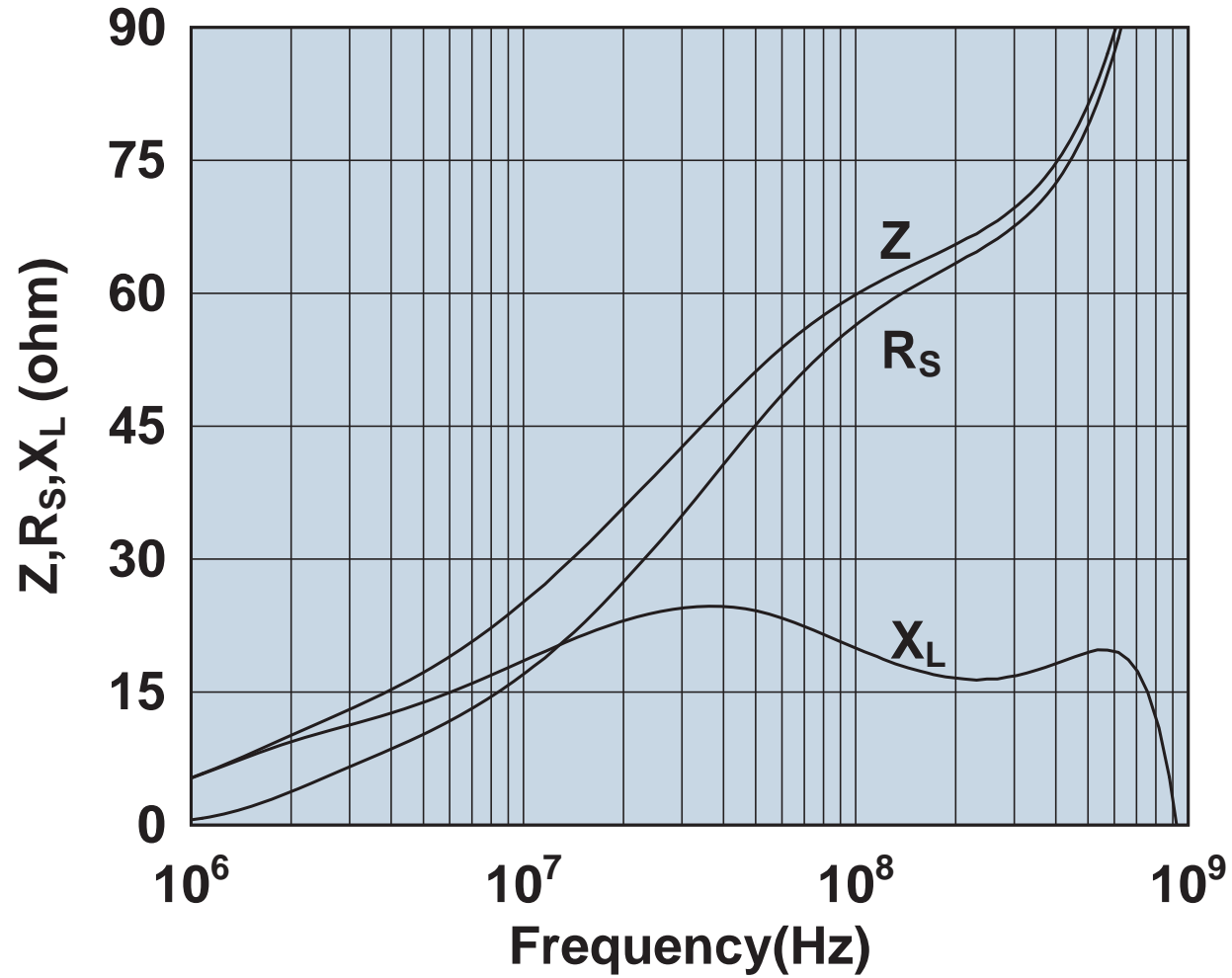

Impedance, reactance, and resistance vs. frequency.



2644245701

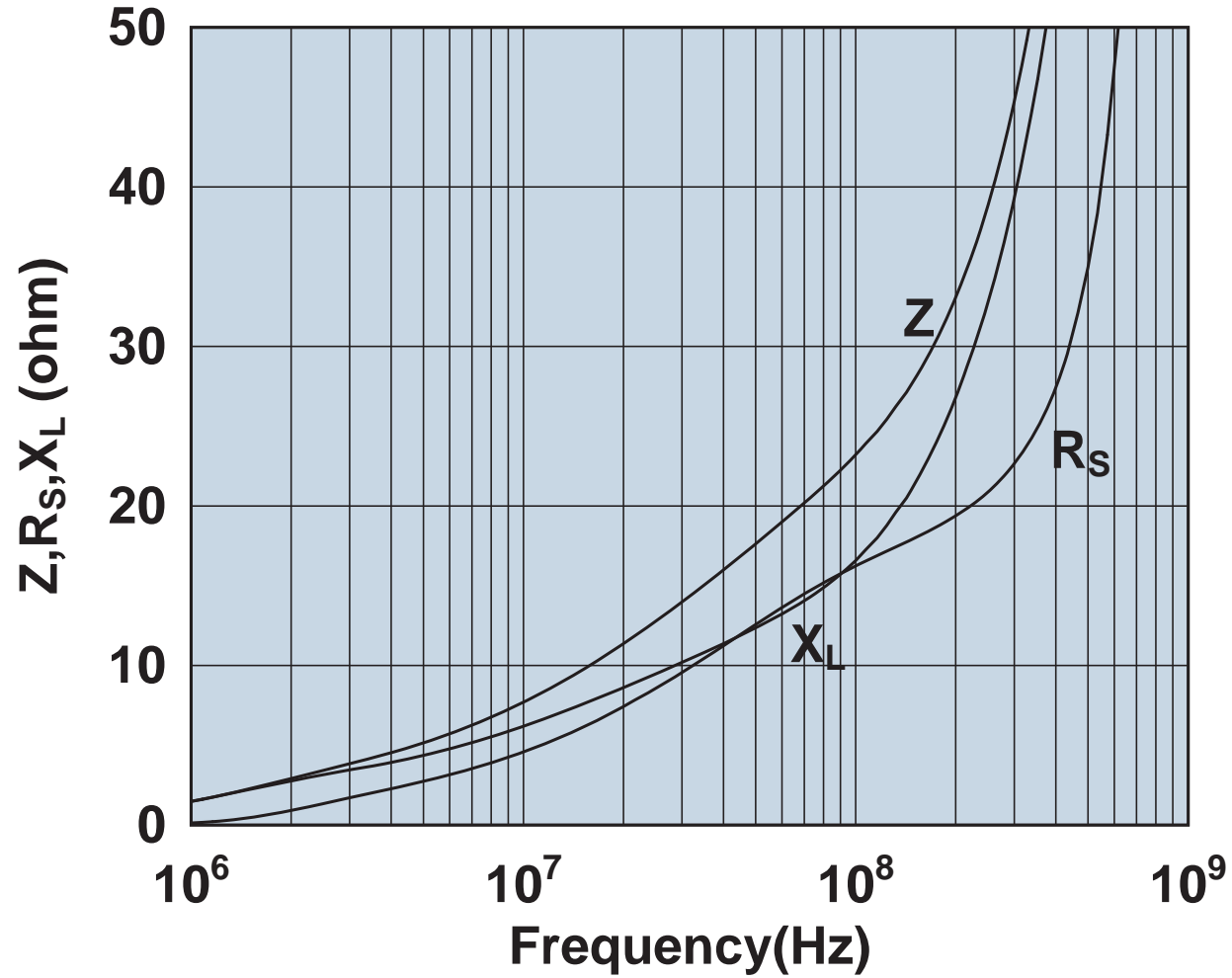

Impedance, reactance, and resistance vs. frequency.

2644245801

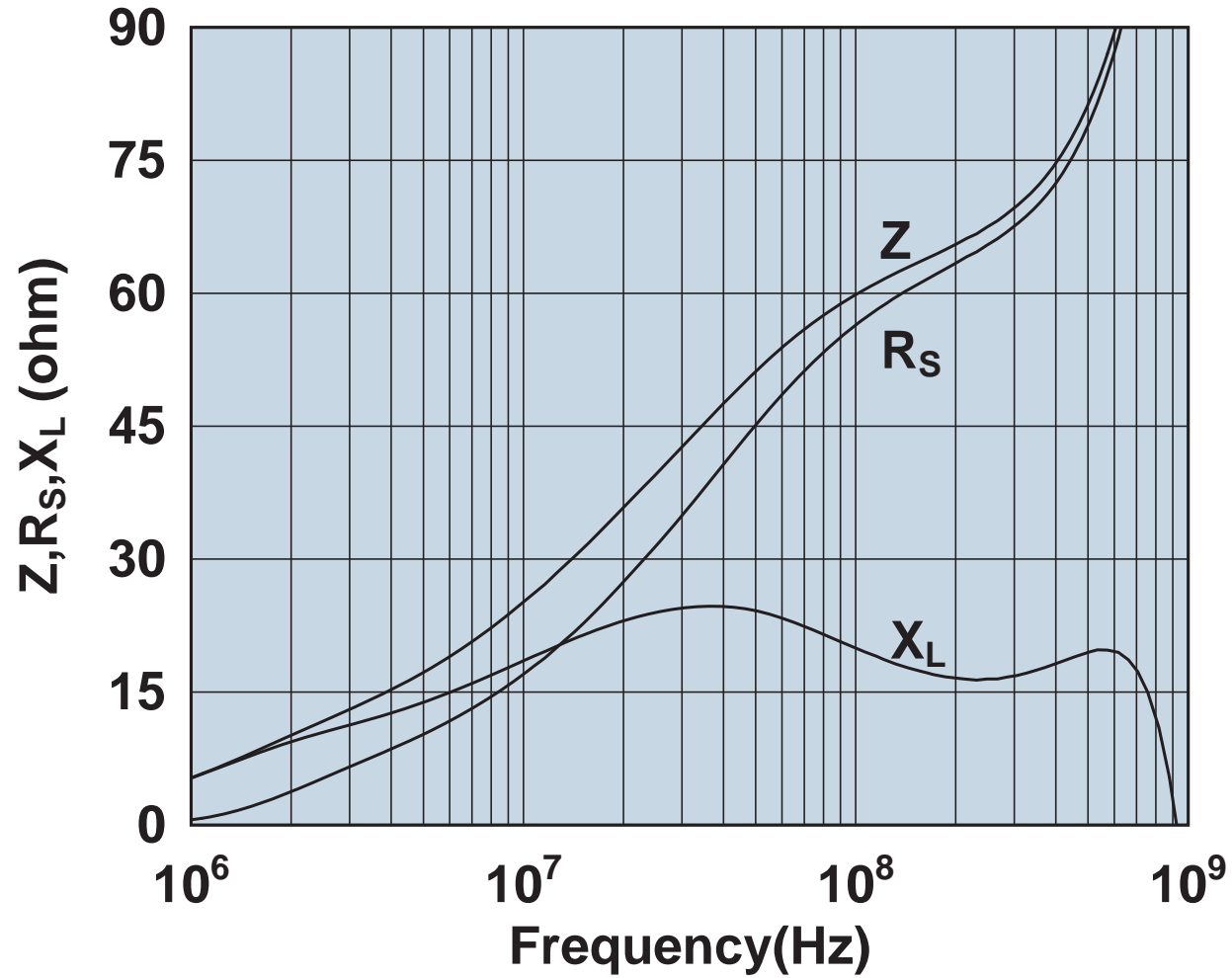

Impedance, reactance, and resistance vs. frequency.

2644245901

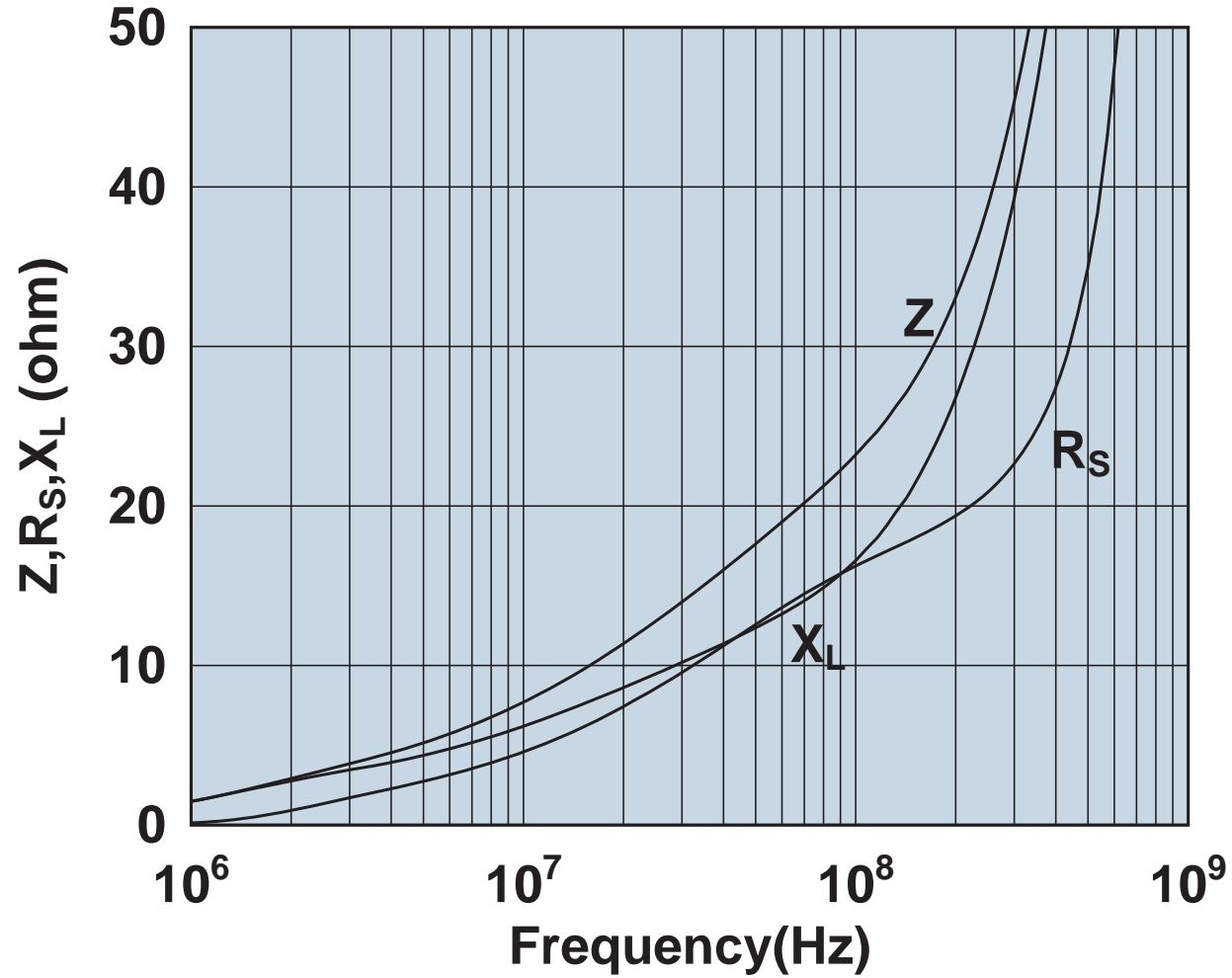

Impedance, reactance, and resistance vs. frequency.

2644246001

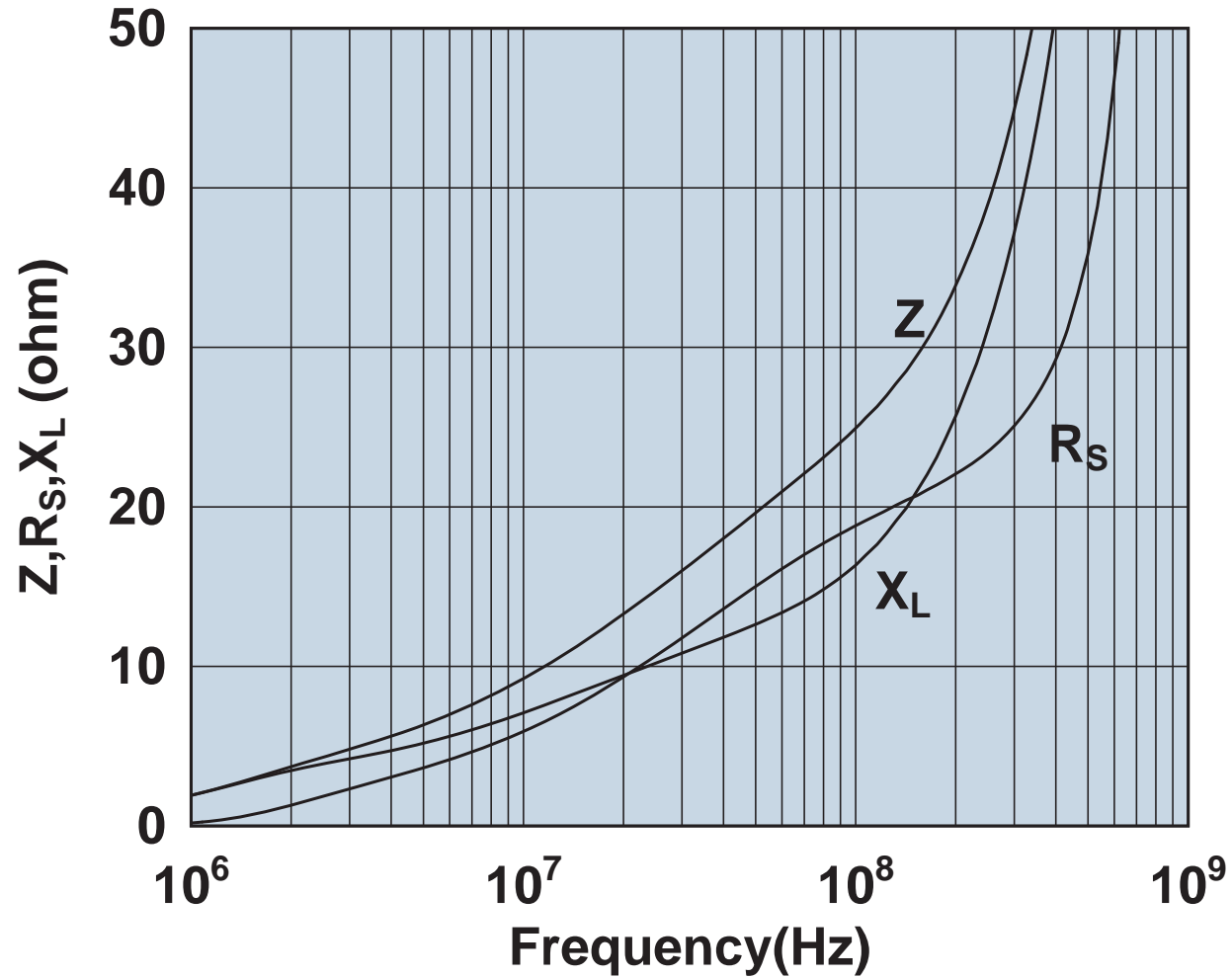

Impedance, reactance, and resistance vs. frequency.

2644246101

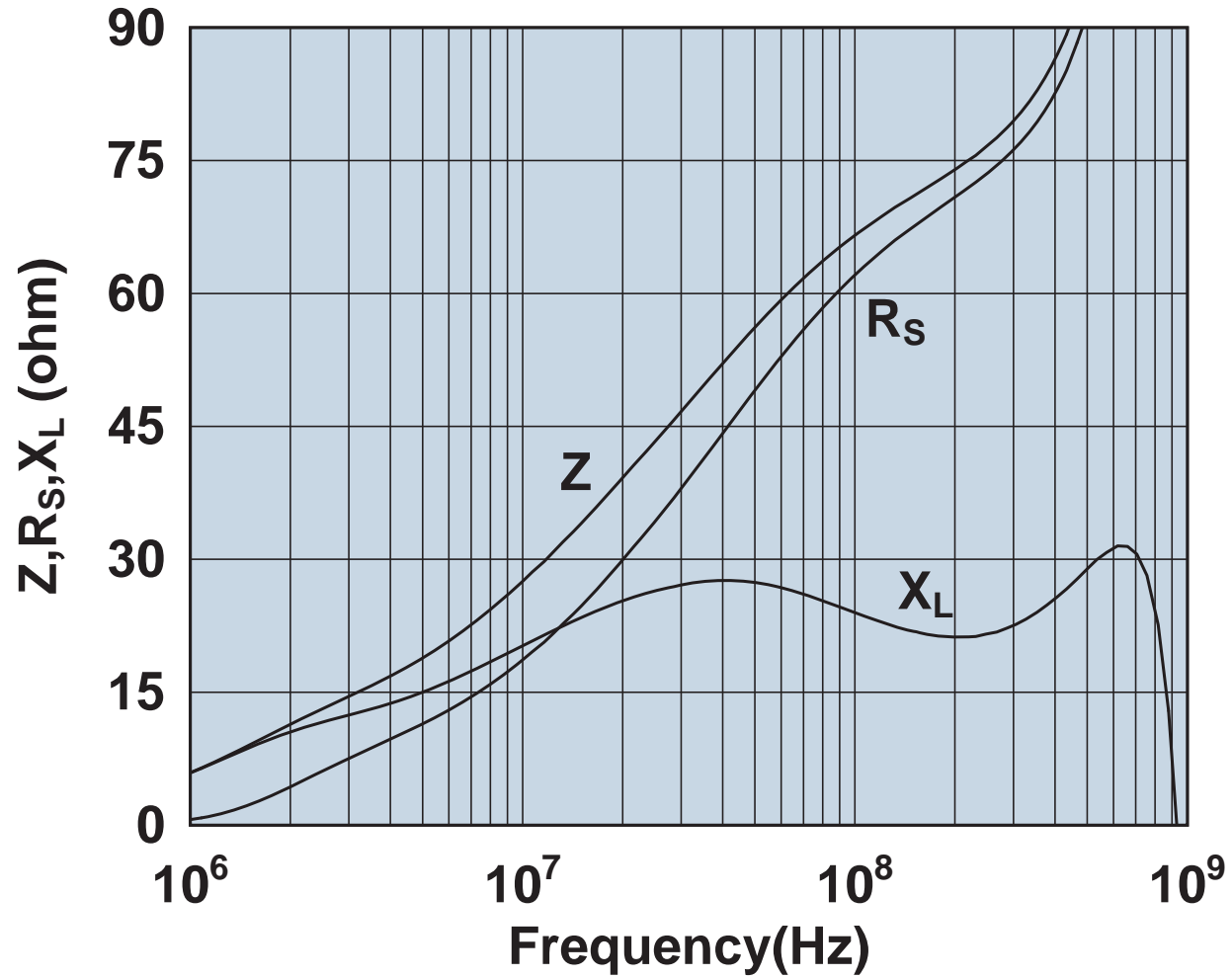

Impedance, reactance, and resistance vs. frequency.

2644246201

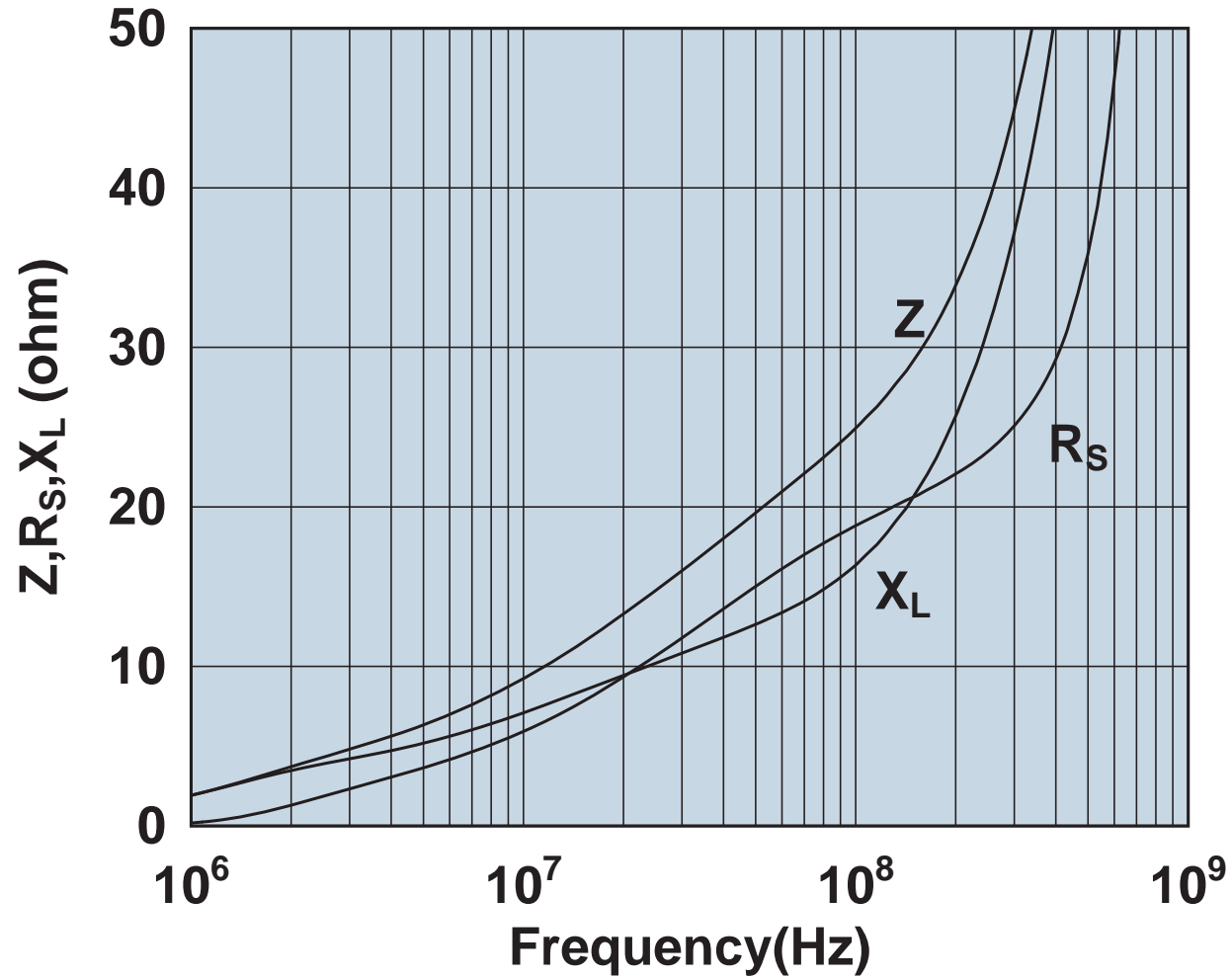

Impedance, reactance, and resistance vs. frequency.

2644246301

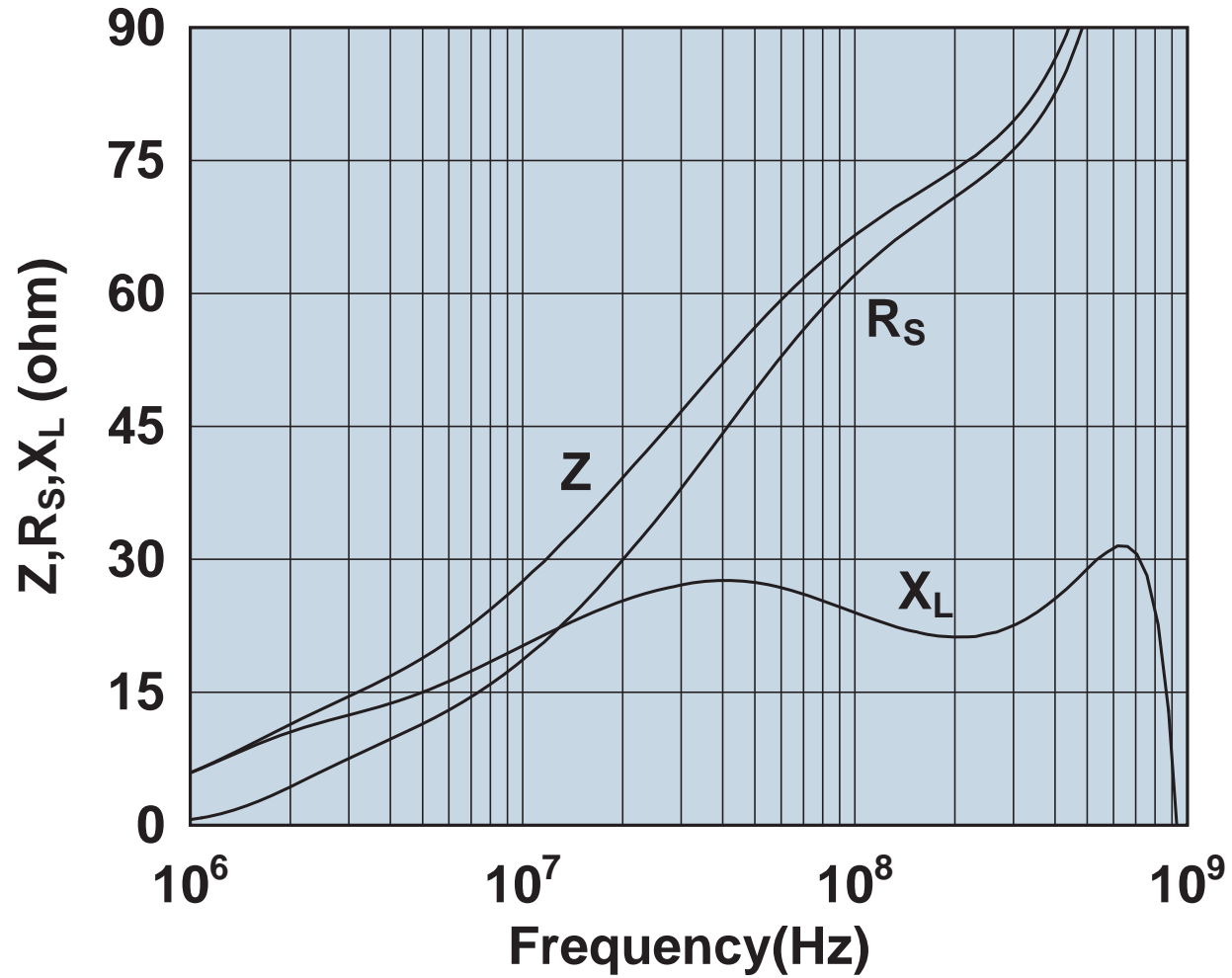

Impedance, reactance, and resistance vs. frequency.

2644246701

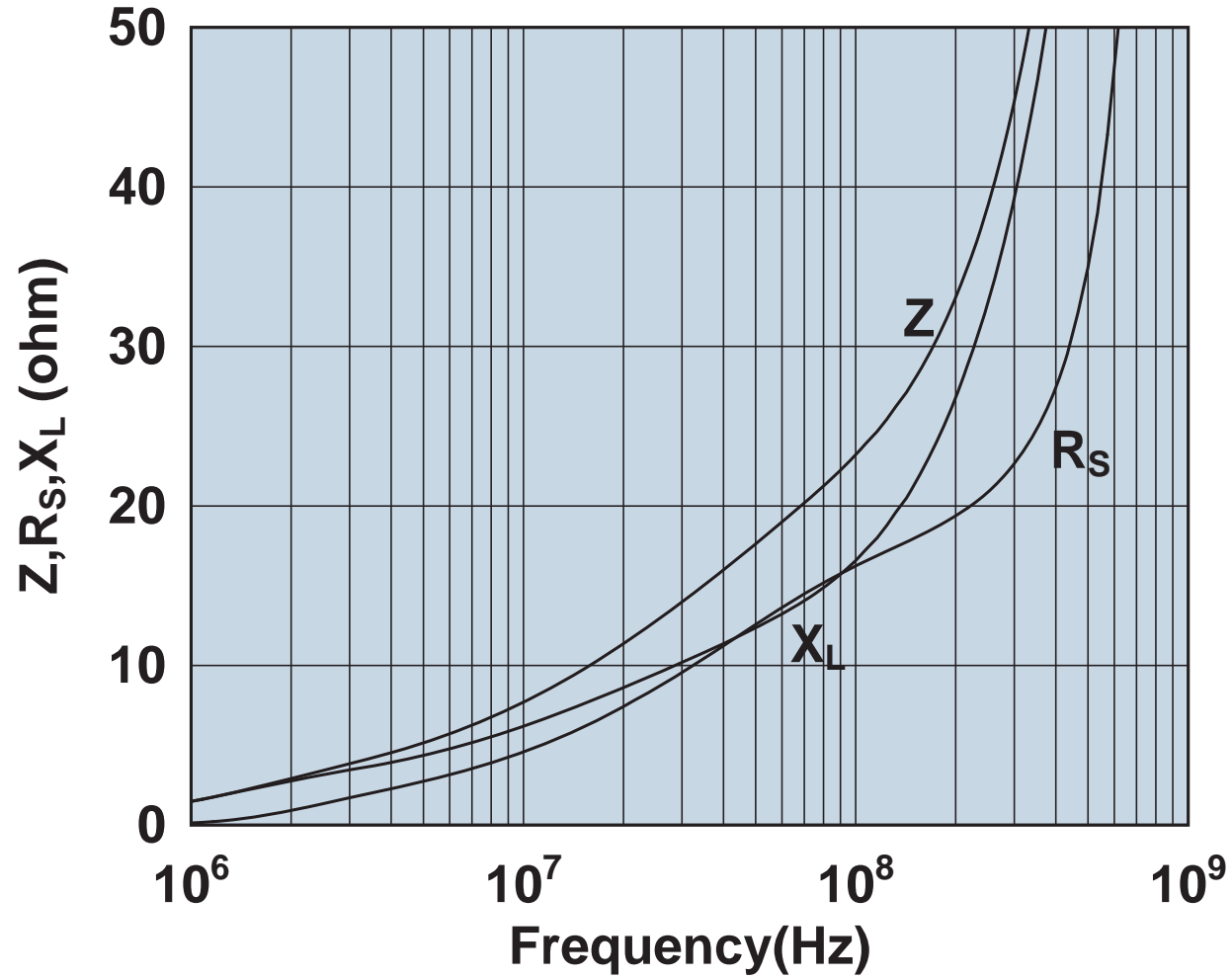

Impedance, reactance, and resistance vs. frequency.



2644246801

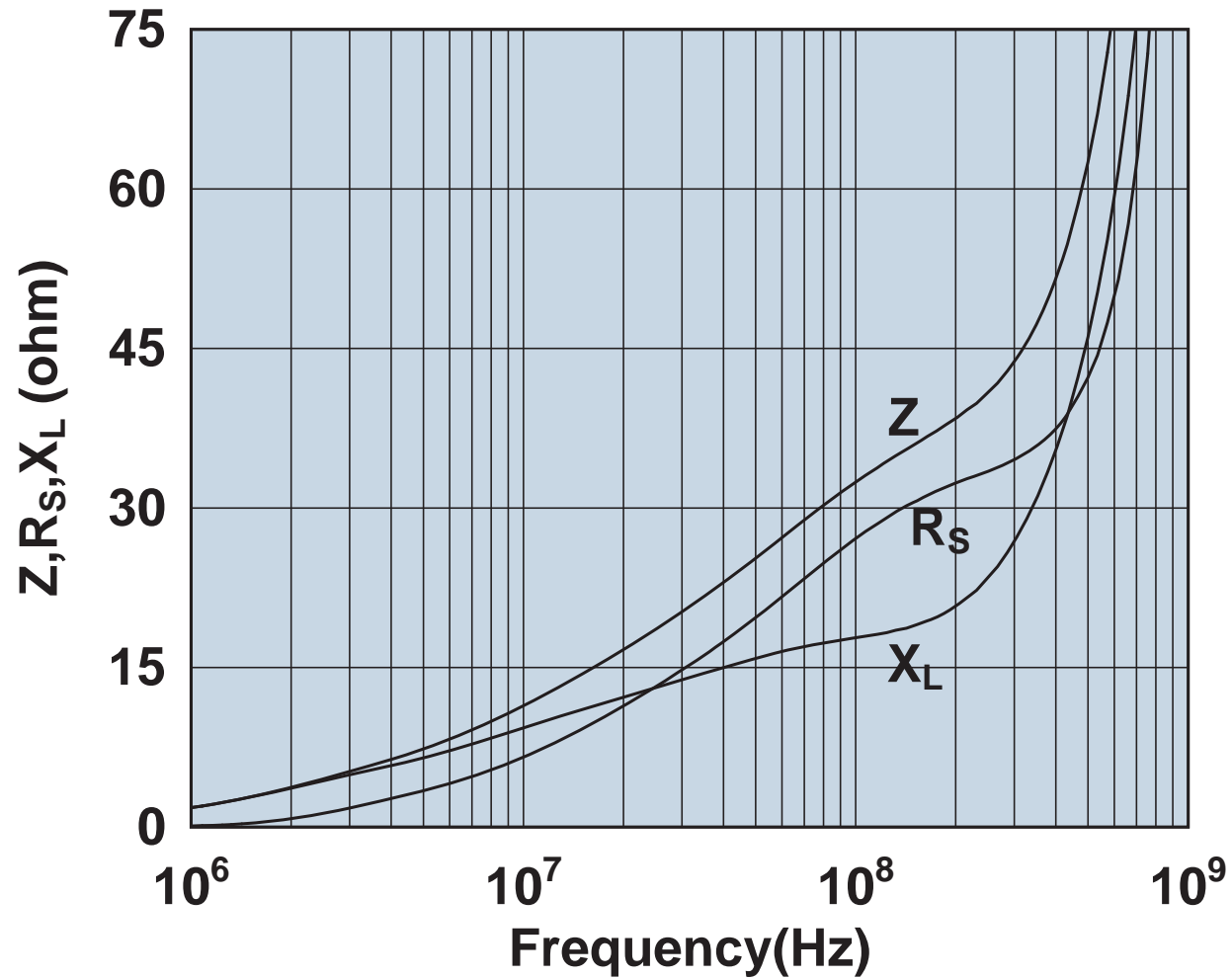

Impedance, reactance, and resistance vs. frequency.

2644246901

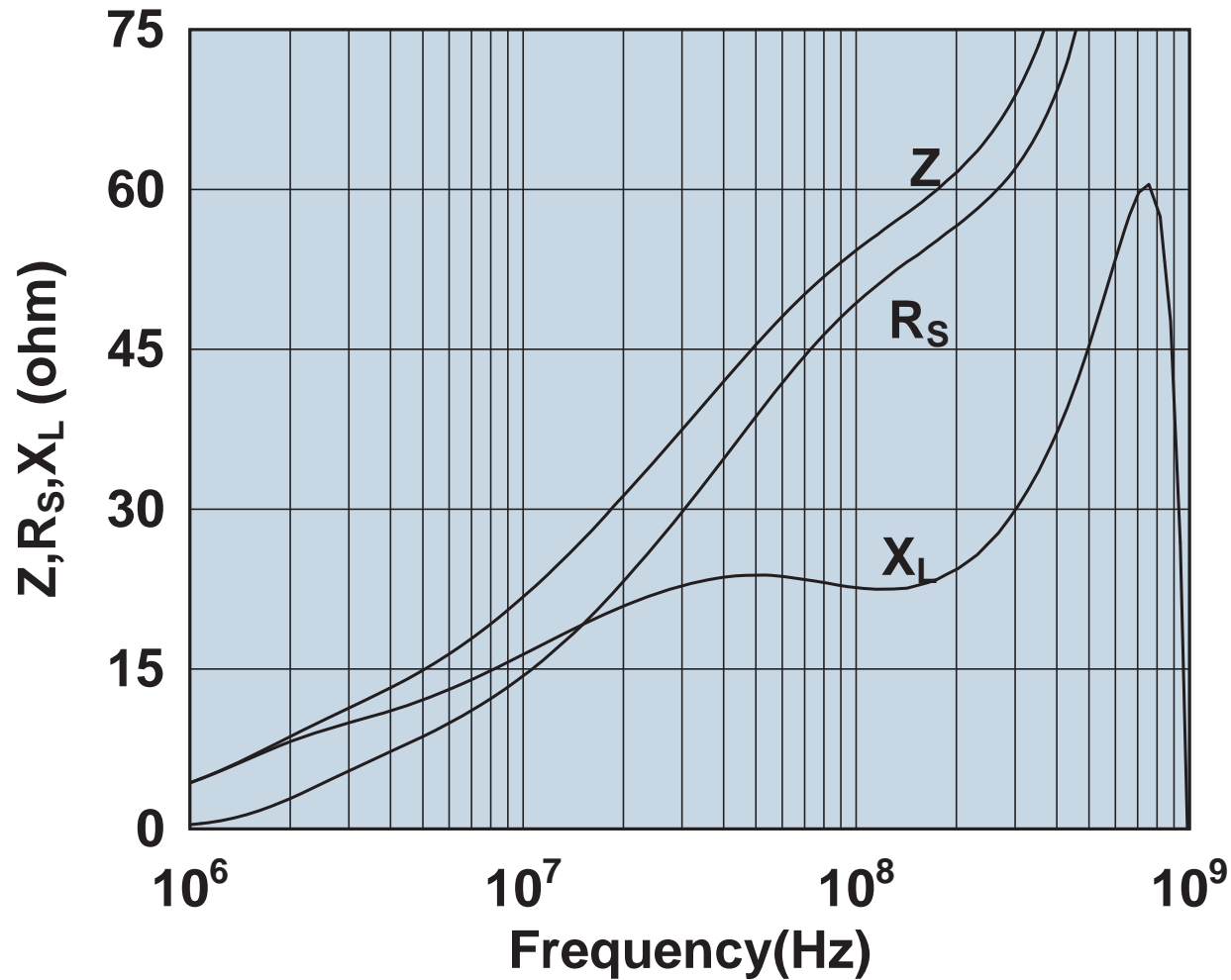

Impedance, reactance, and resistance vs. frequency.

2644247001

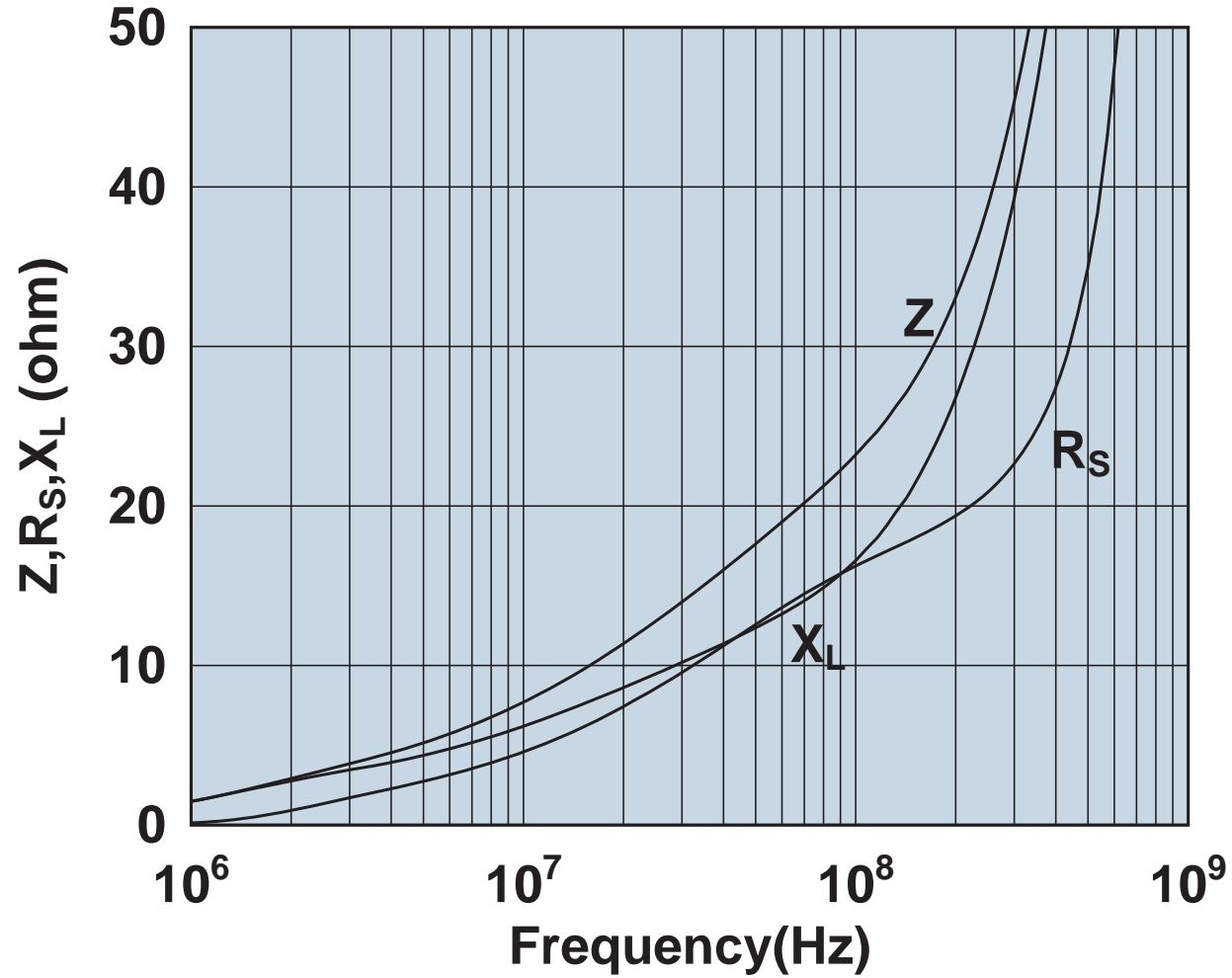

Impedance, reactance, and resistance vs. frequency.

2644247101

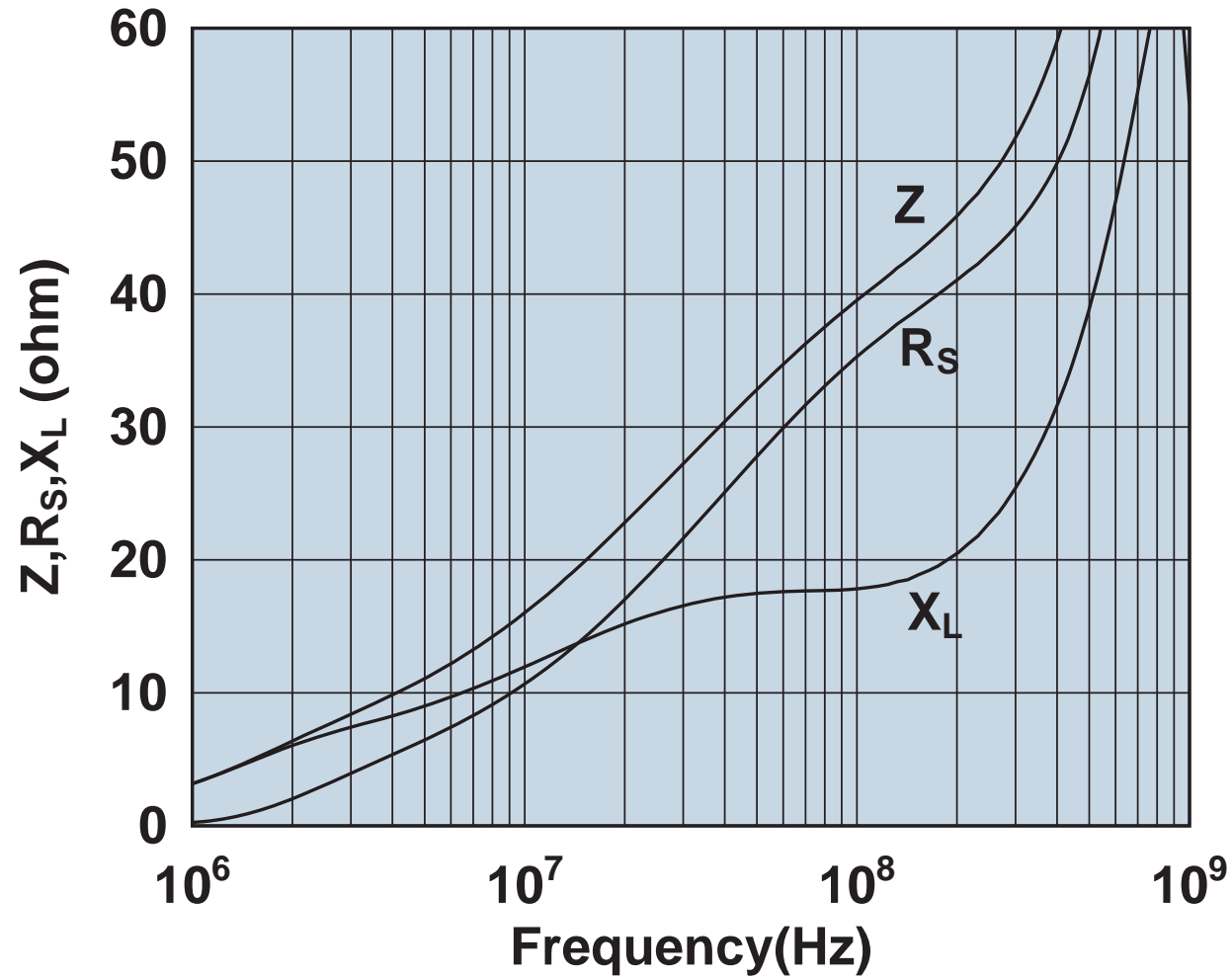

Impedance, reactance, and resistance vs. frequency.

2644247201

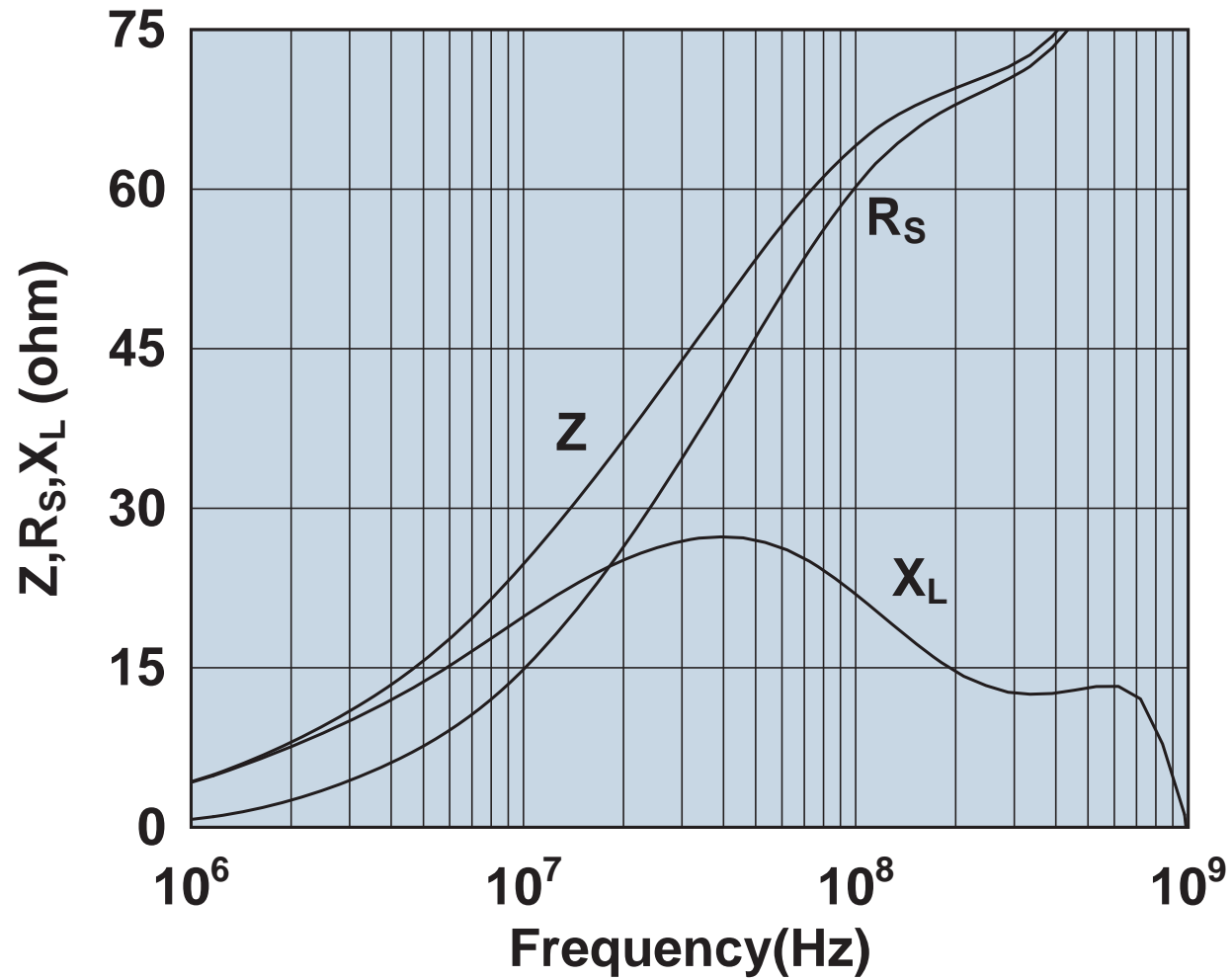

Impedance, reactance, and resistance vs. frequency.

2644247301

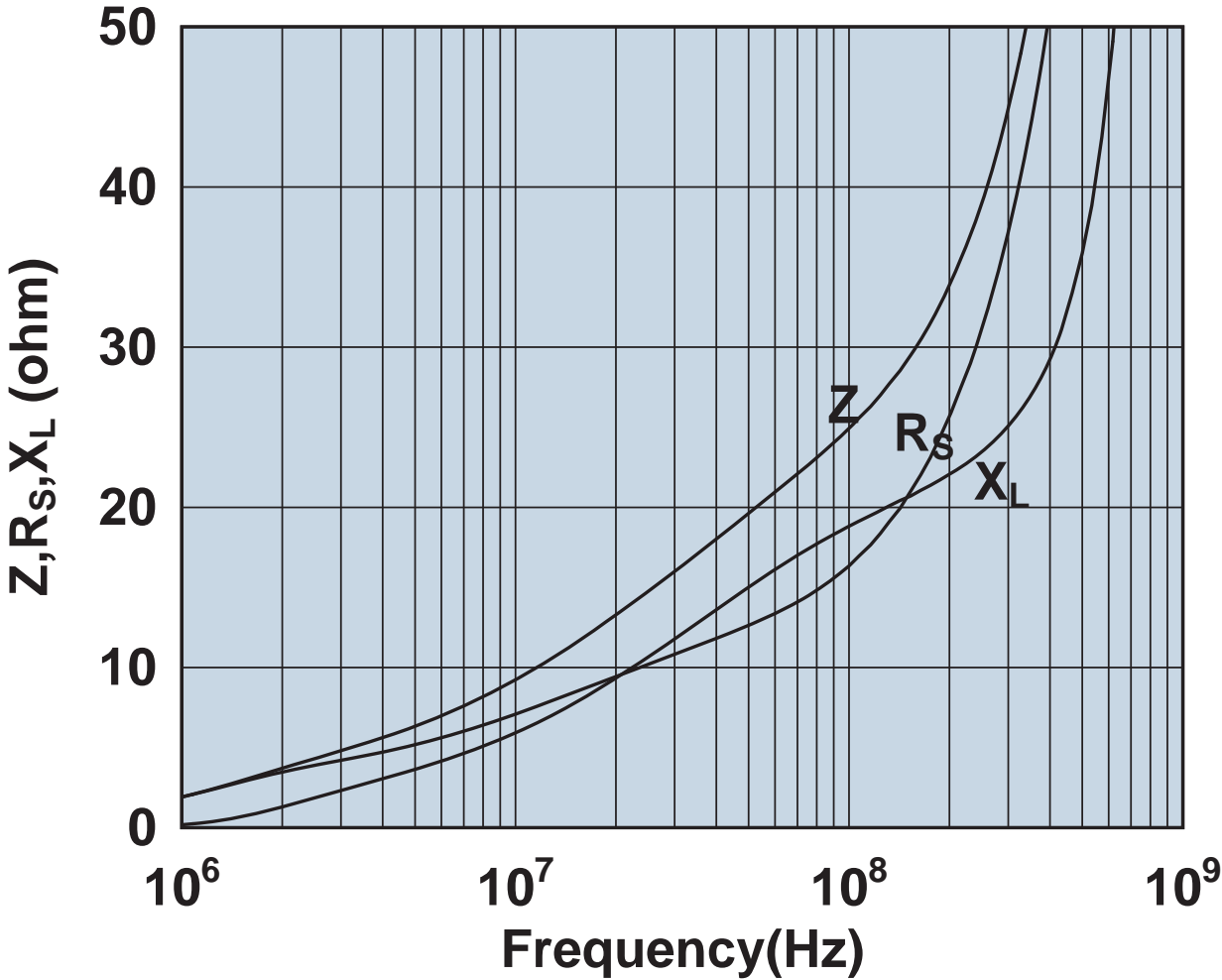

Impedance, reactance, and resistance vs. frequency.

2644247401

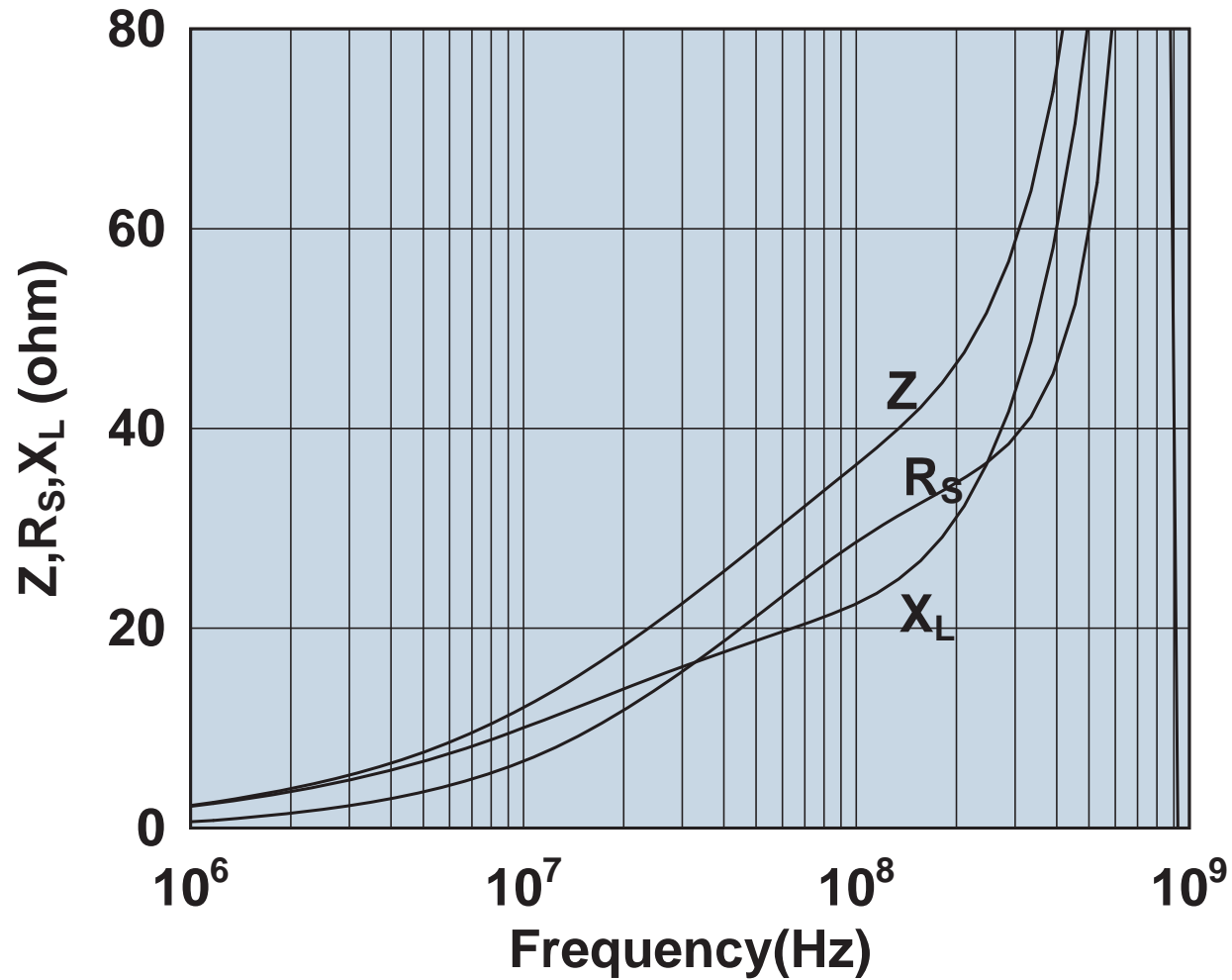

Impedance, reactance, and resistance vs. frequency.

2644247501

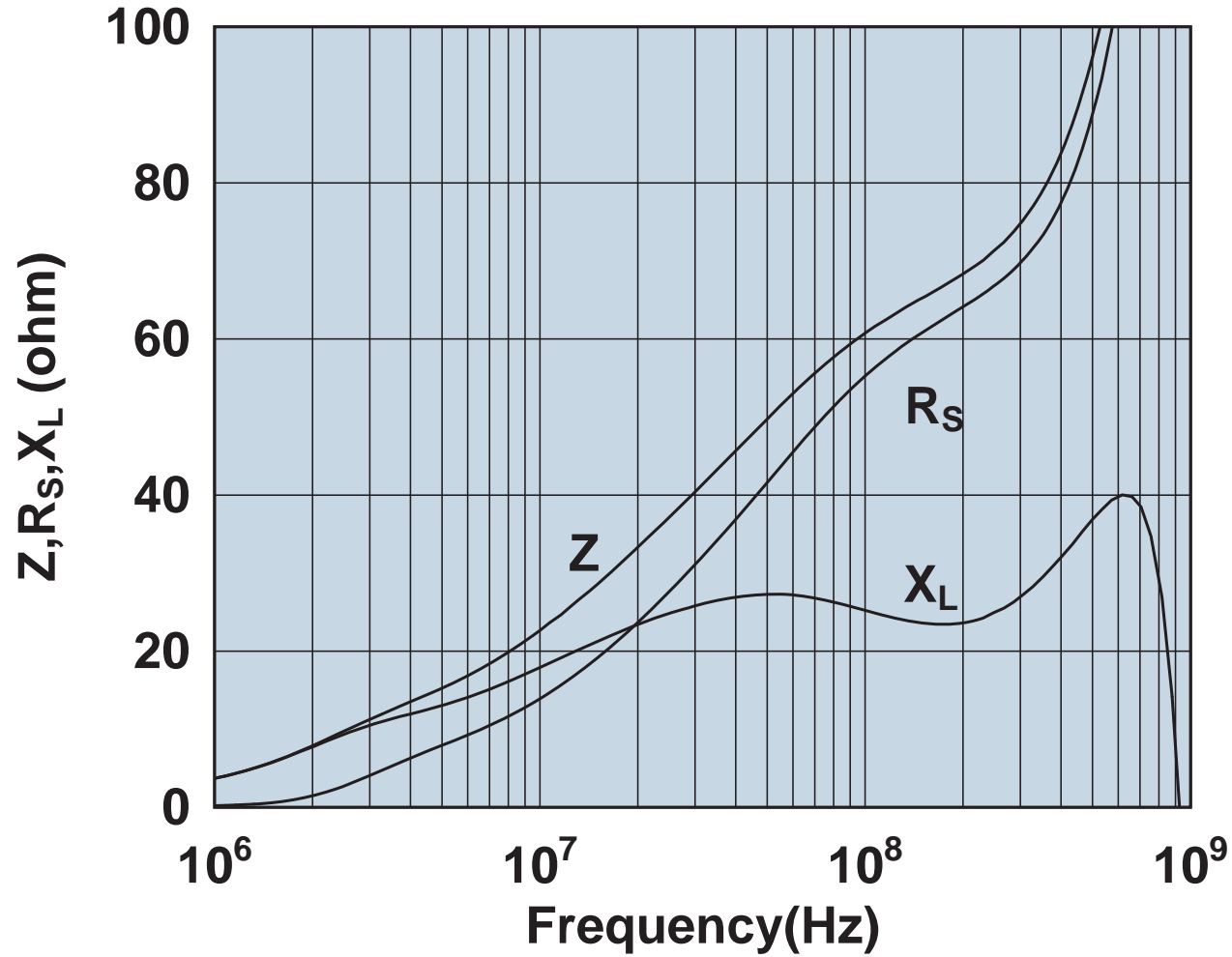

Impedance, reactance, and resistance vs. frequency.



2644251801

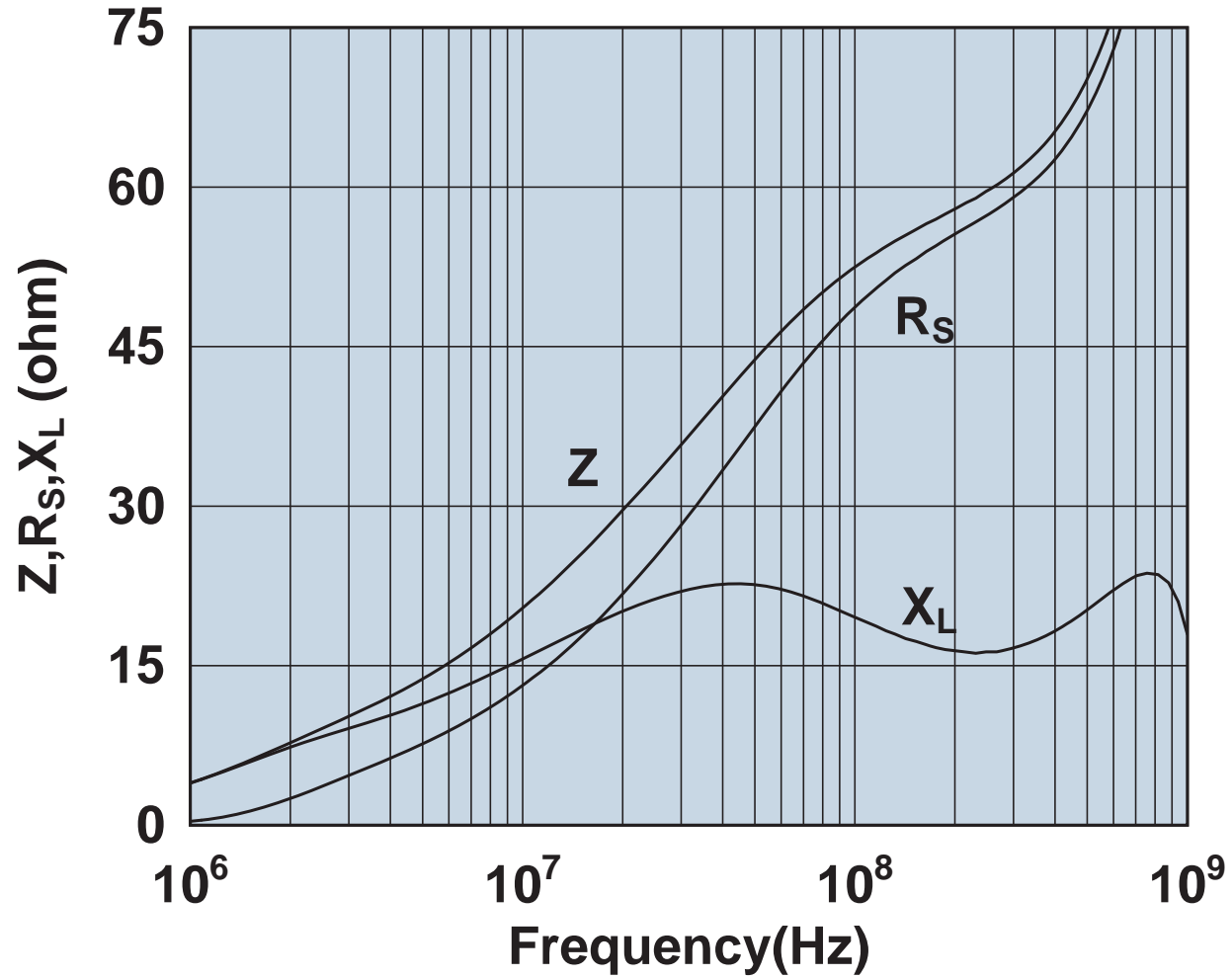

Impedance, reactance, and resistance vs. frequency.

2644251901

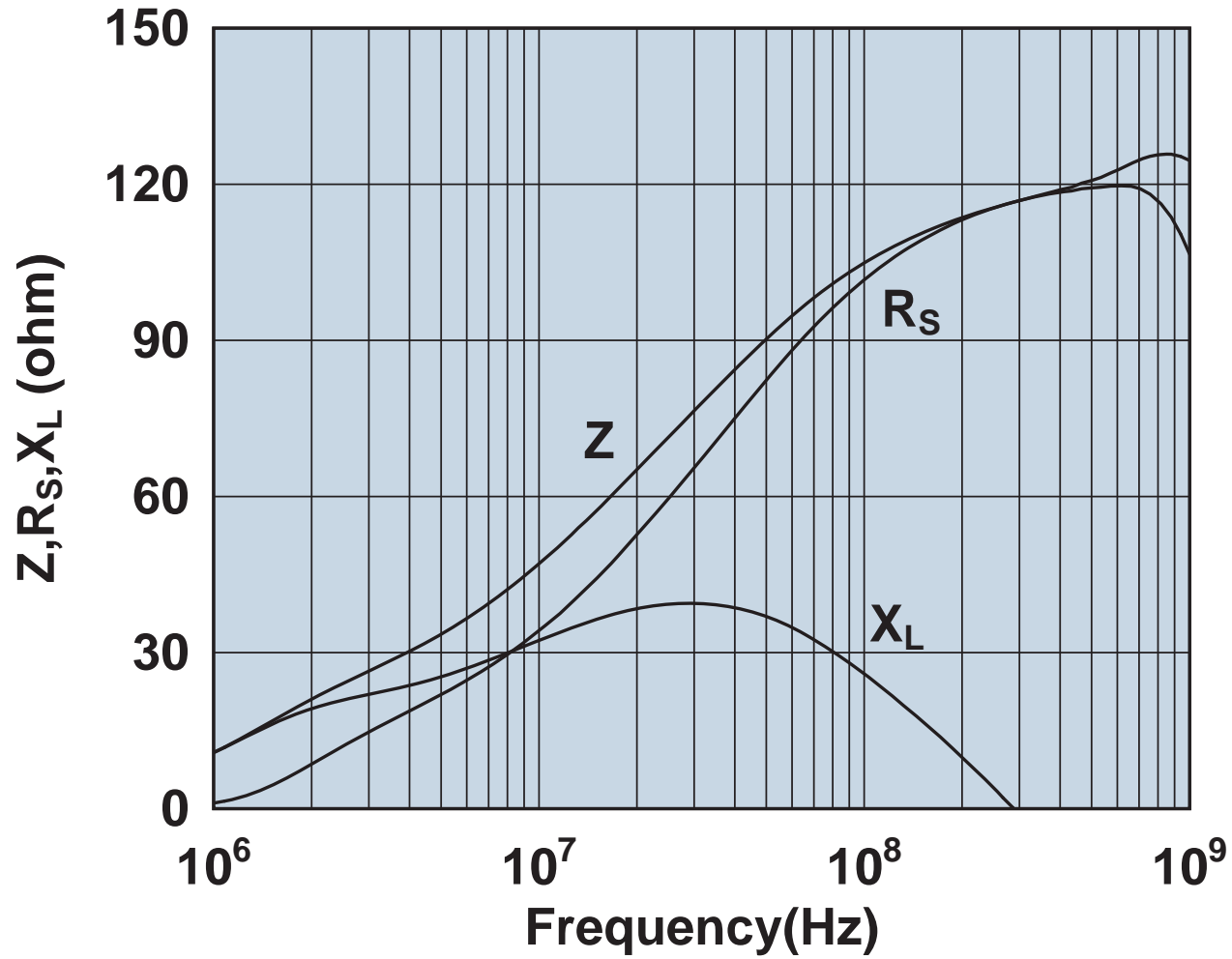

Impedance, reactance, and resistance vs. frequency.

2644373841

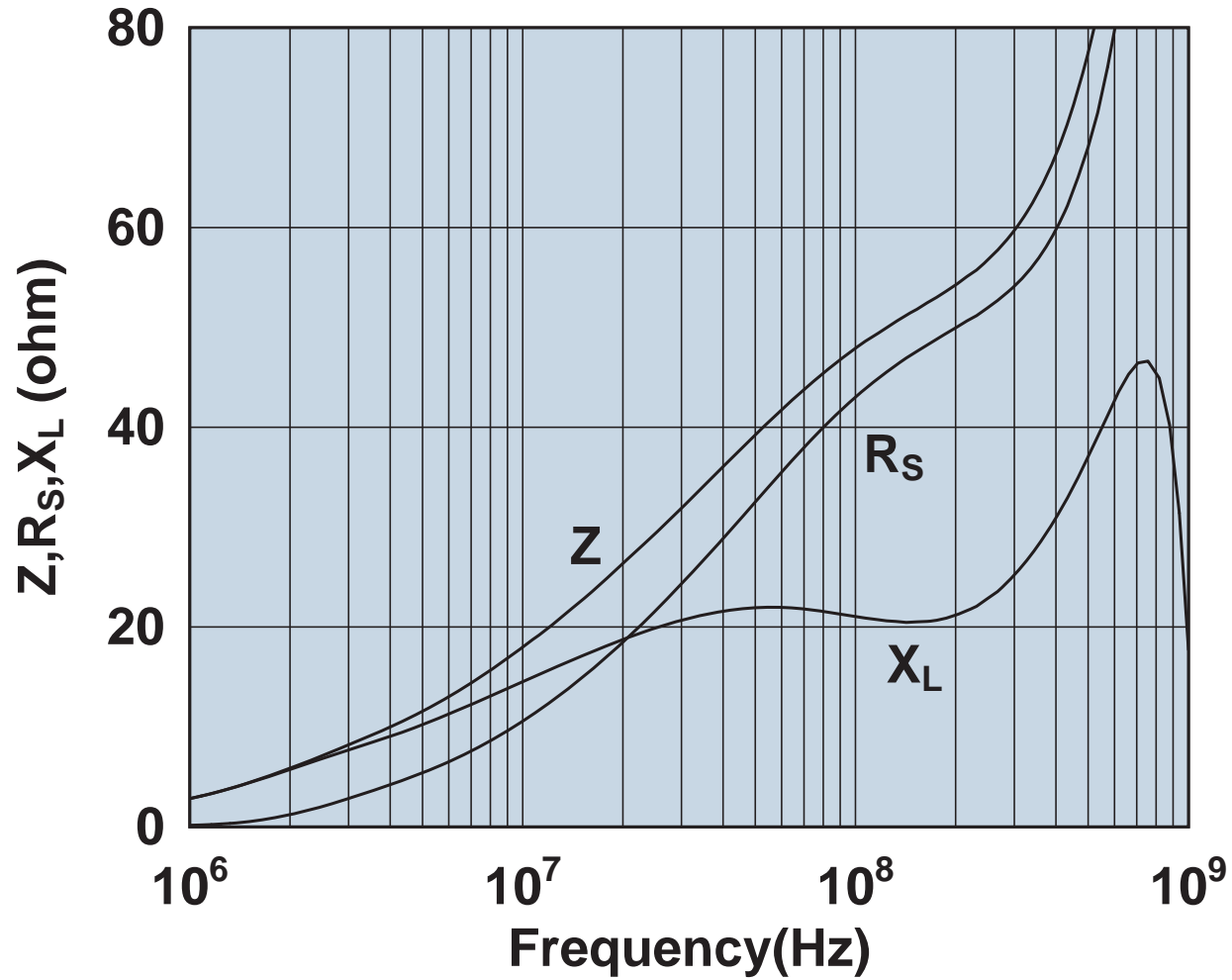

Impedance, reactance, and resistance vs. frequency.

2644373941

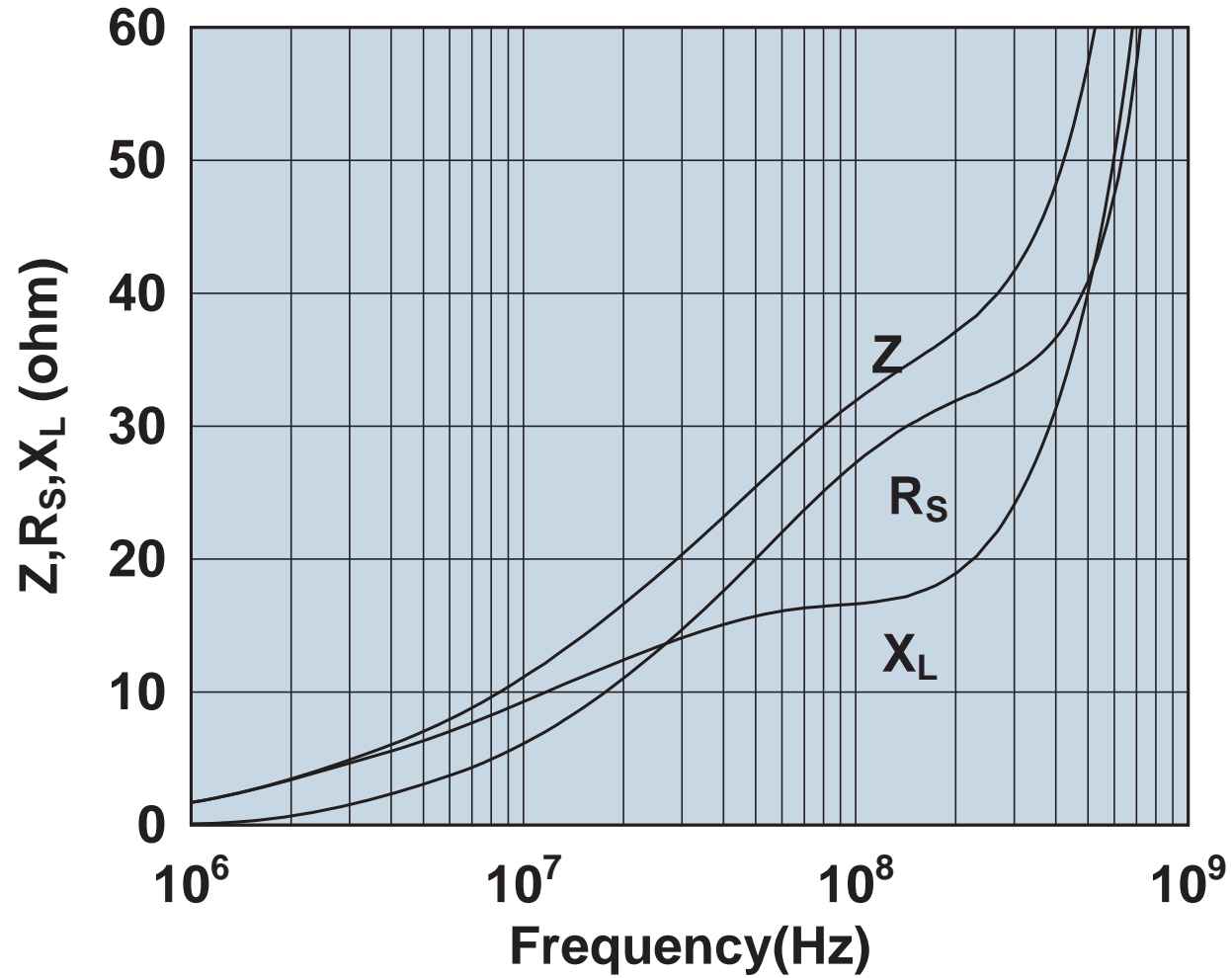

Impedance, reactance, and resistance vs. frequency.

2646101902

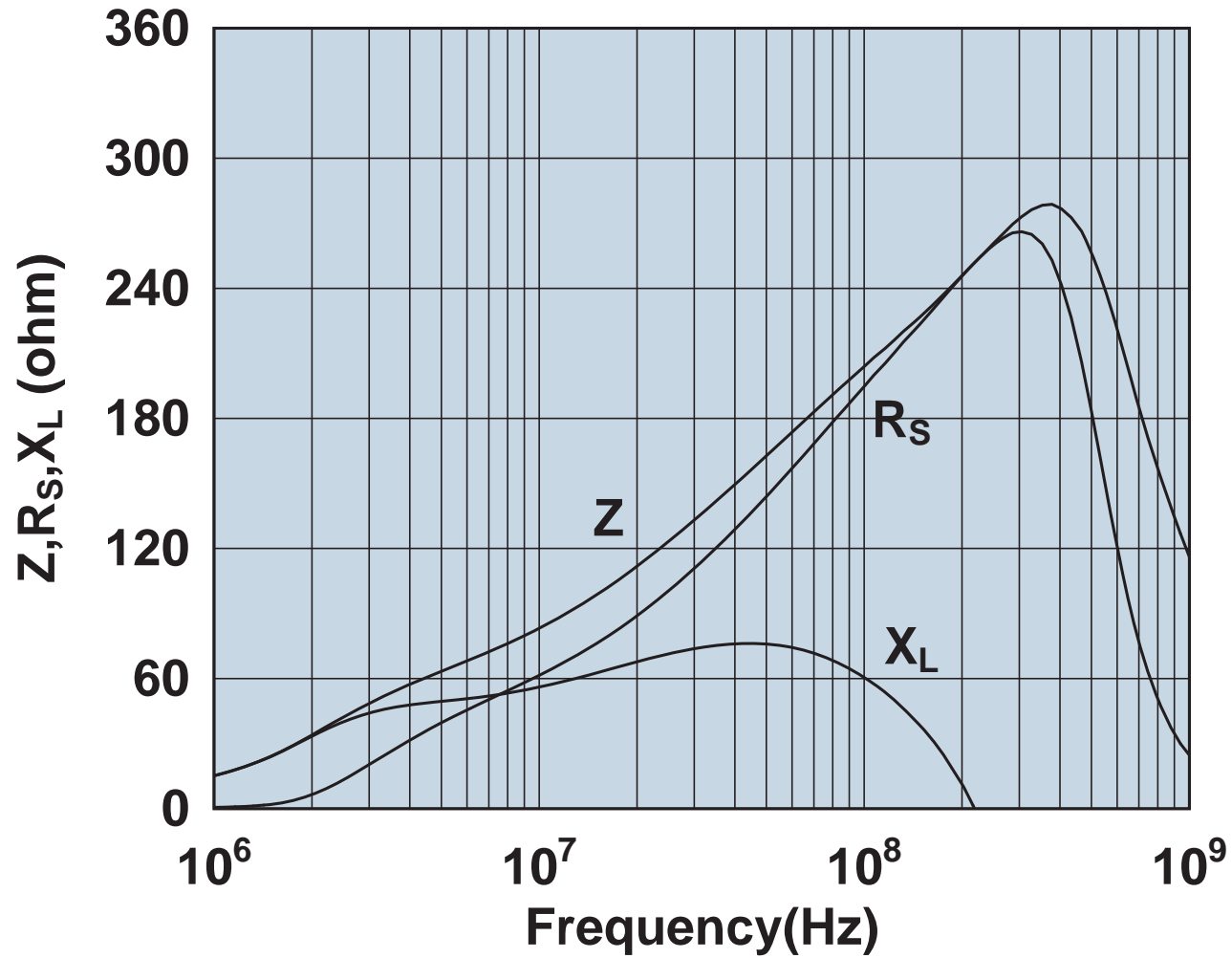

Impedance, reactance, and resistance vs. frequency.

2646102002

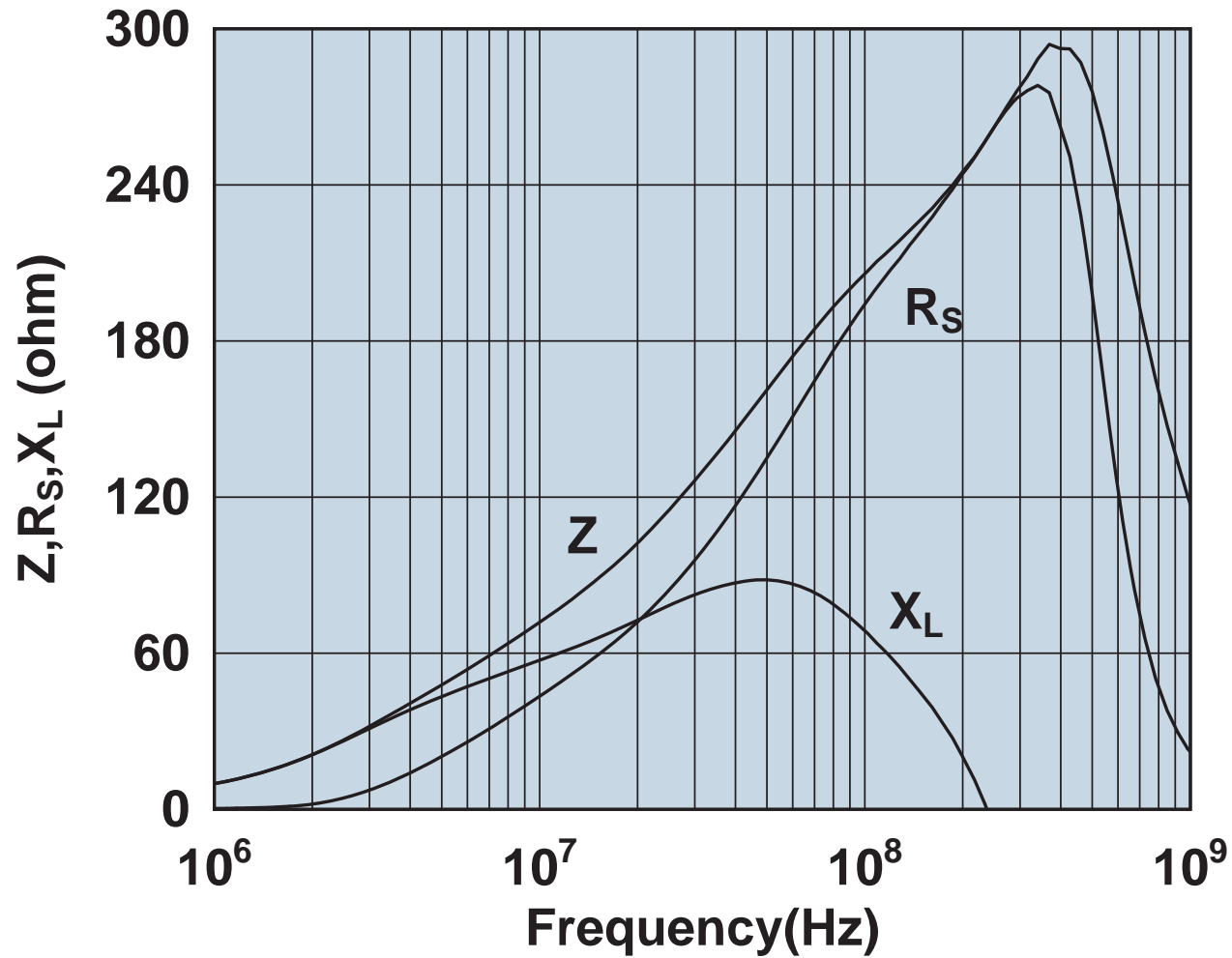

Impedance, reactance, and resistance vs. frequency.

2646102402

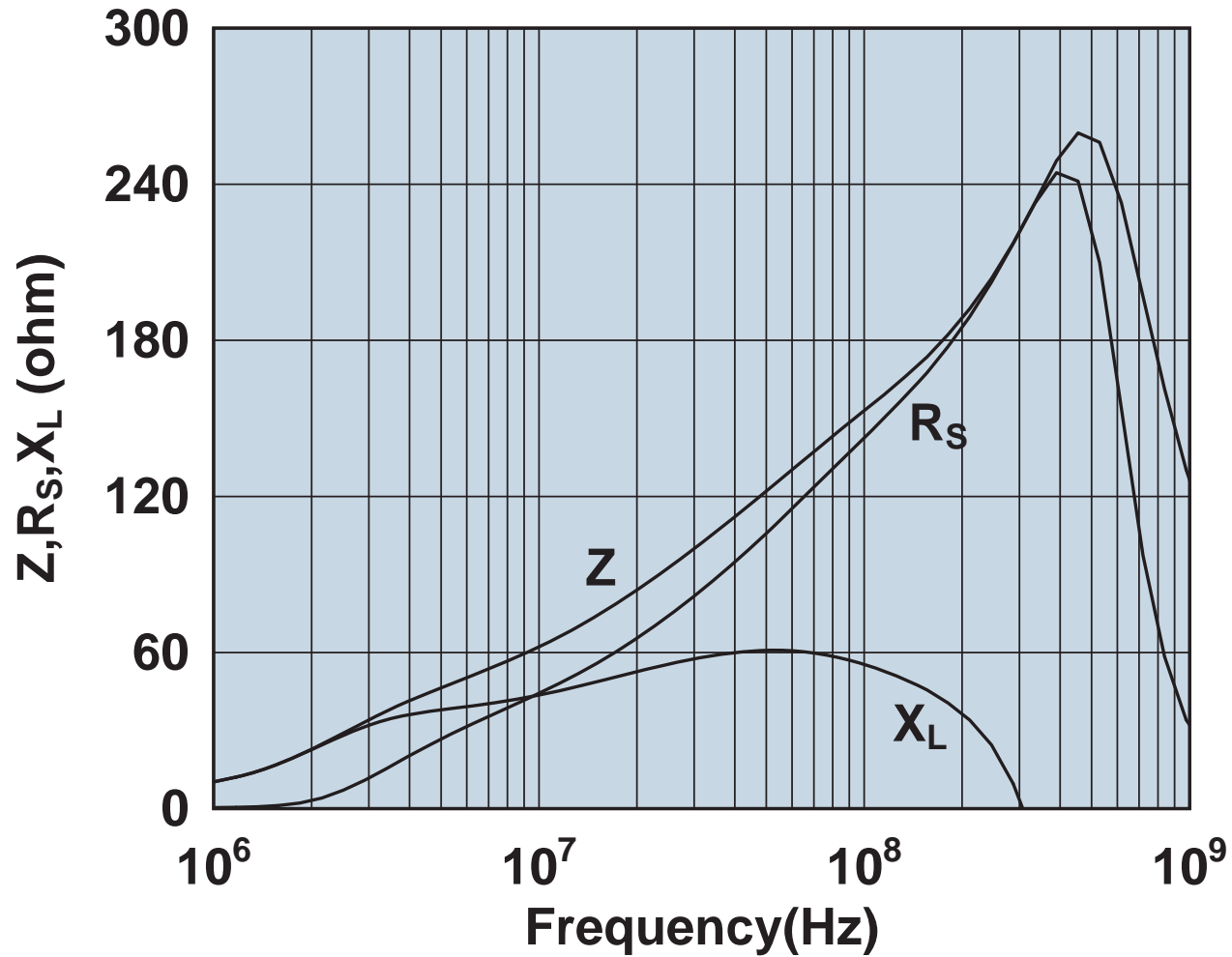

Impedance, reactance, and resistance vs. frequency.

2646103002

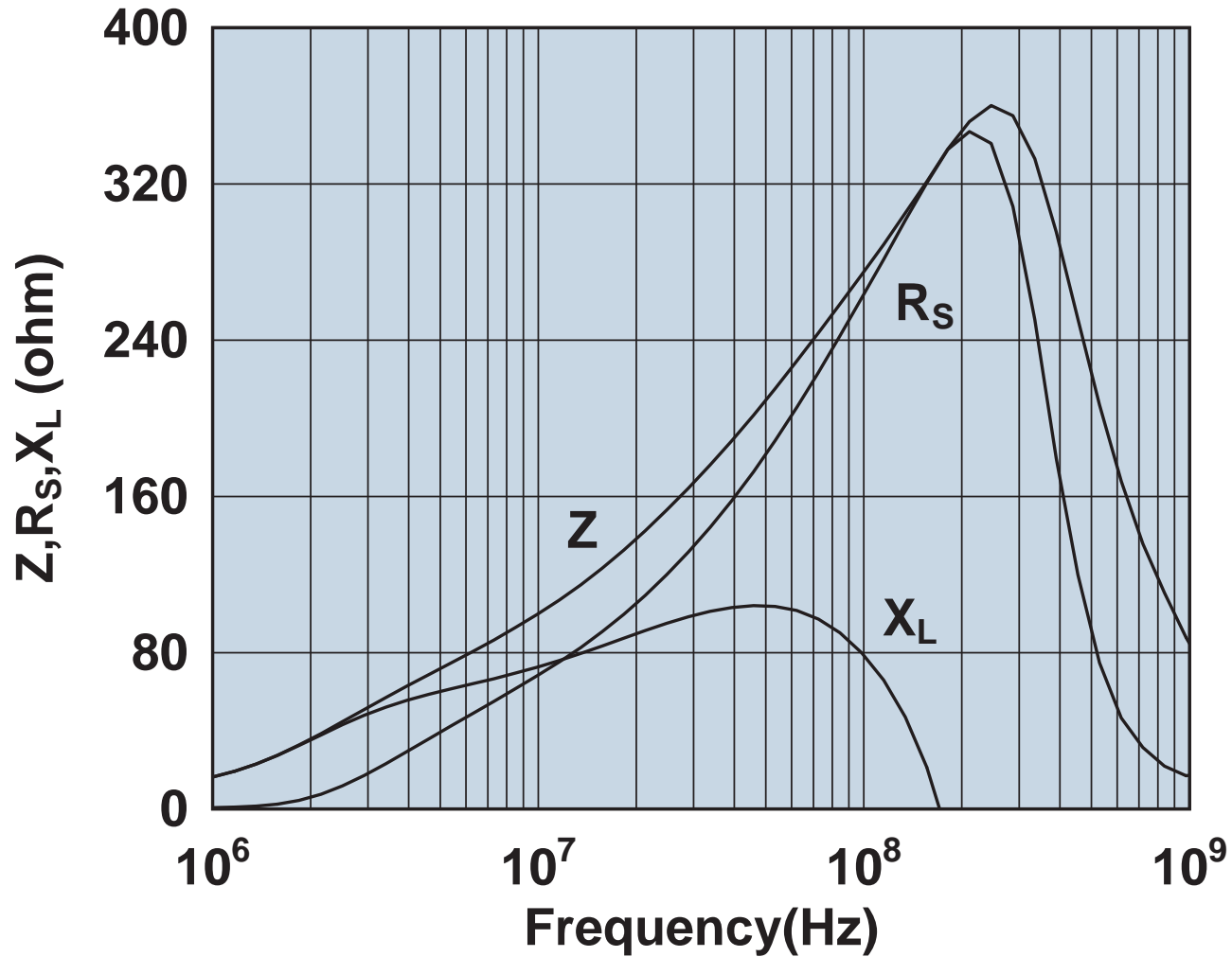

Impedance, reactance, and resistance vs. frequency.



2646164151

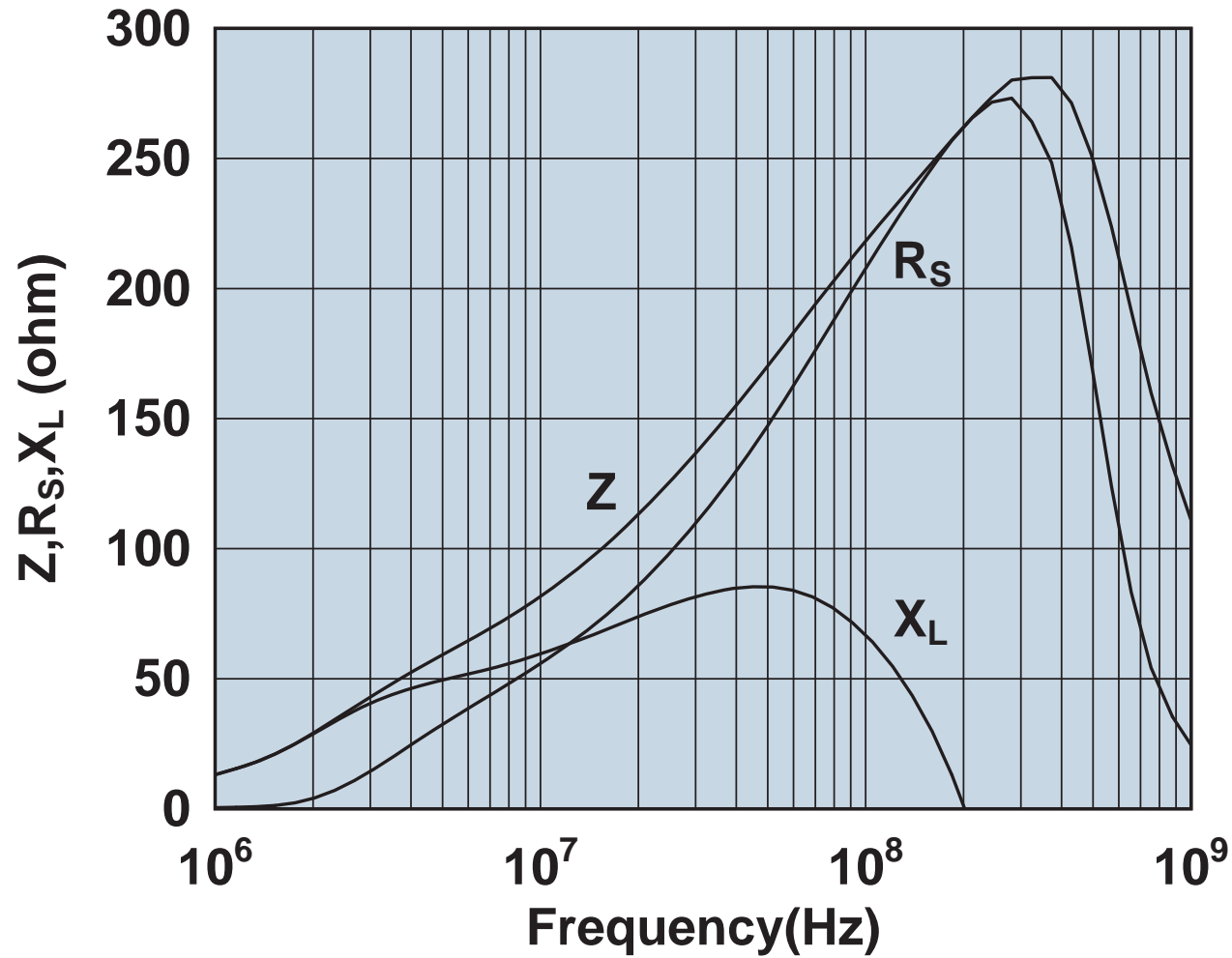

Impedance, reactance, and resistance vs. frequency.

2646164181

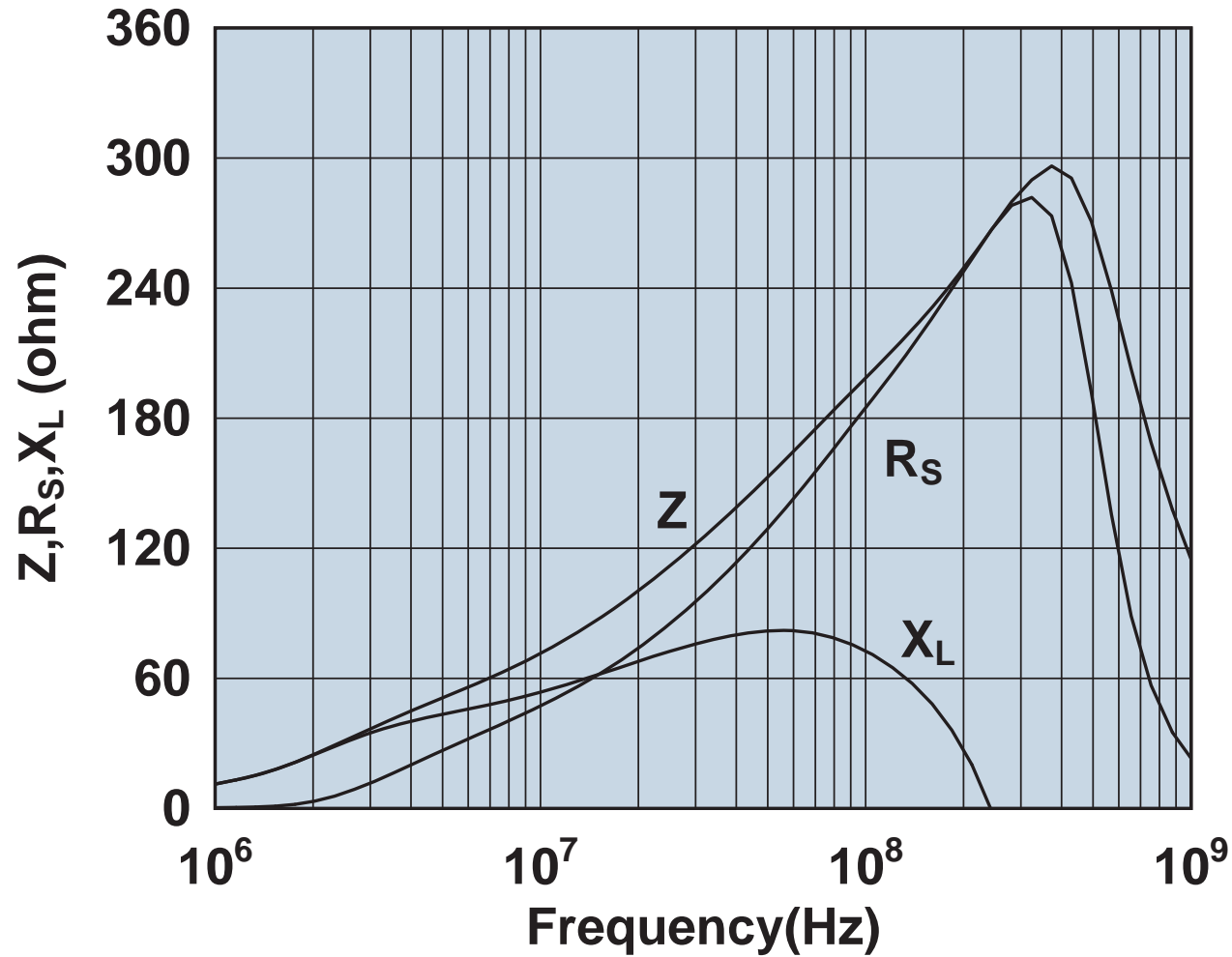

Impedance, reactance, and resistance vs. frequency.

2646164251

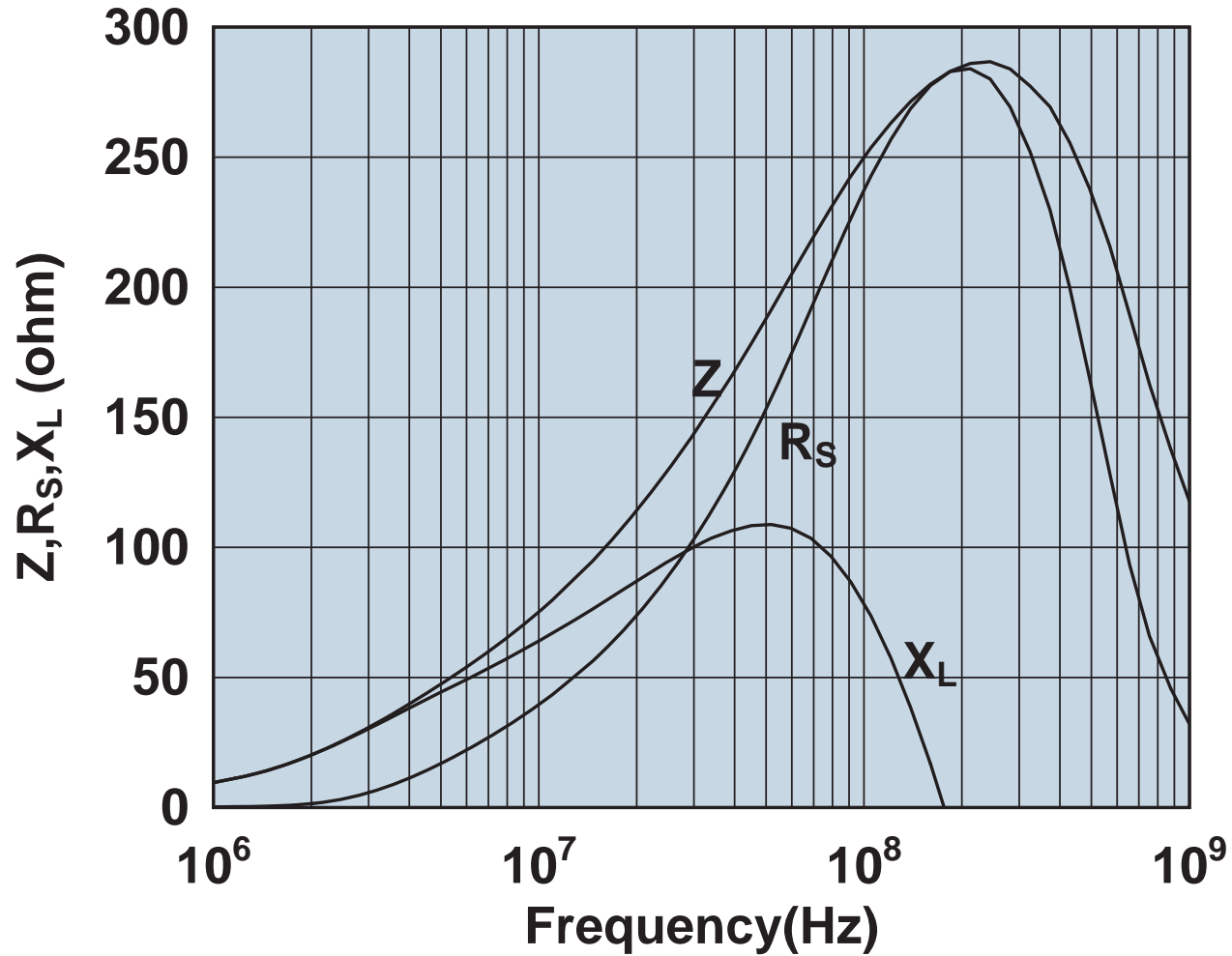

Impedance, reactance, and resistance vs. frequency.

2646164281

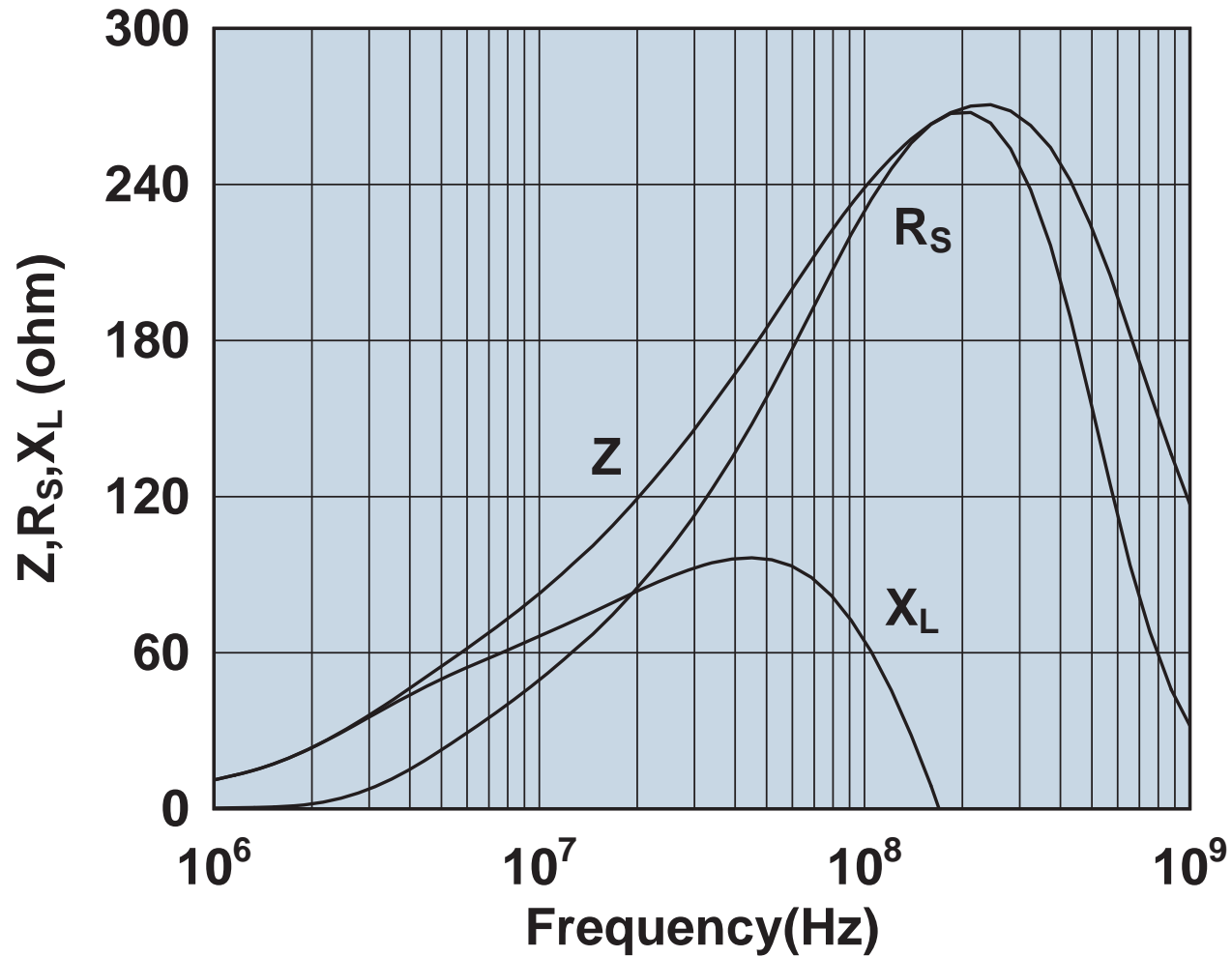

Impedance, reactance, and resistance vs. frequency.

2646164951

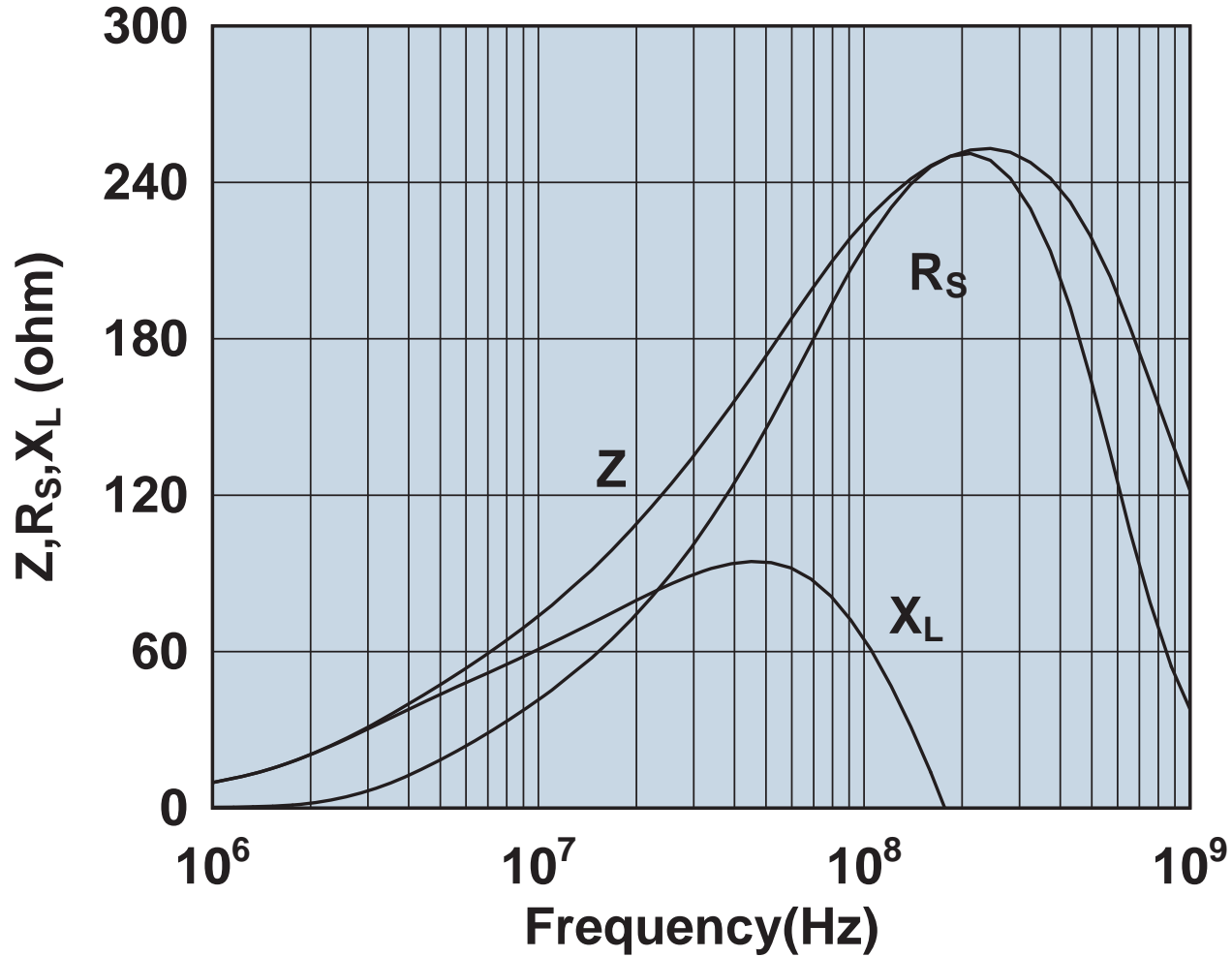

Impedance, reactance, and resistance vs. frequency.

2646167251

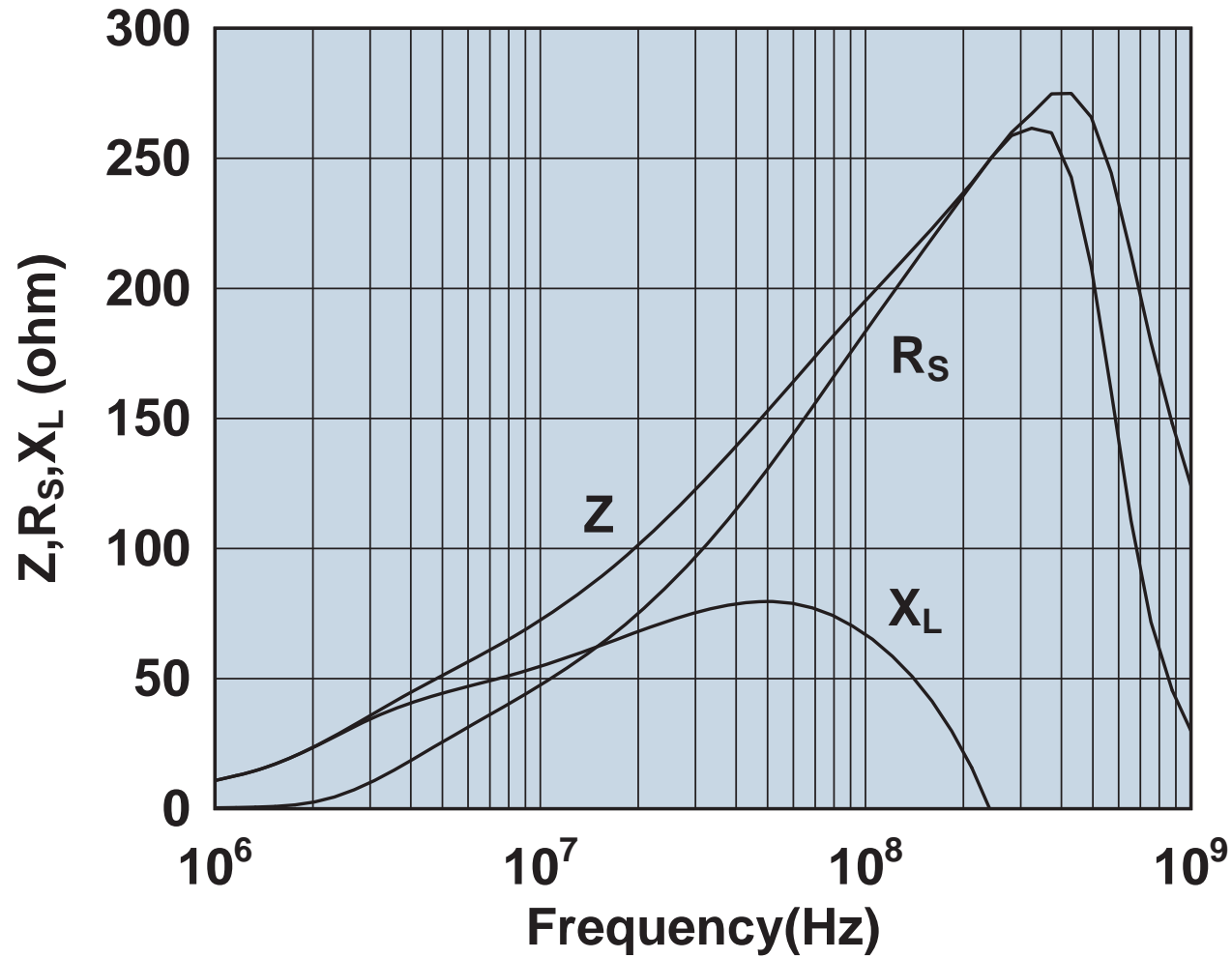

Impedance, reactance, and resistance vs. frequency.

2646167281

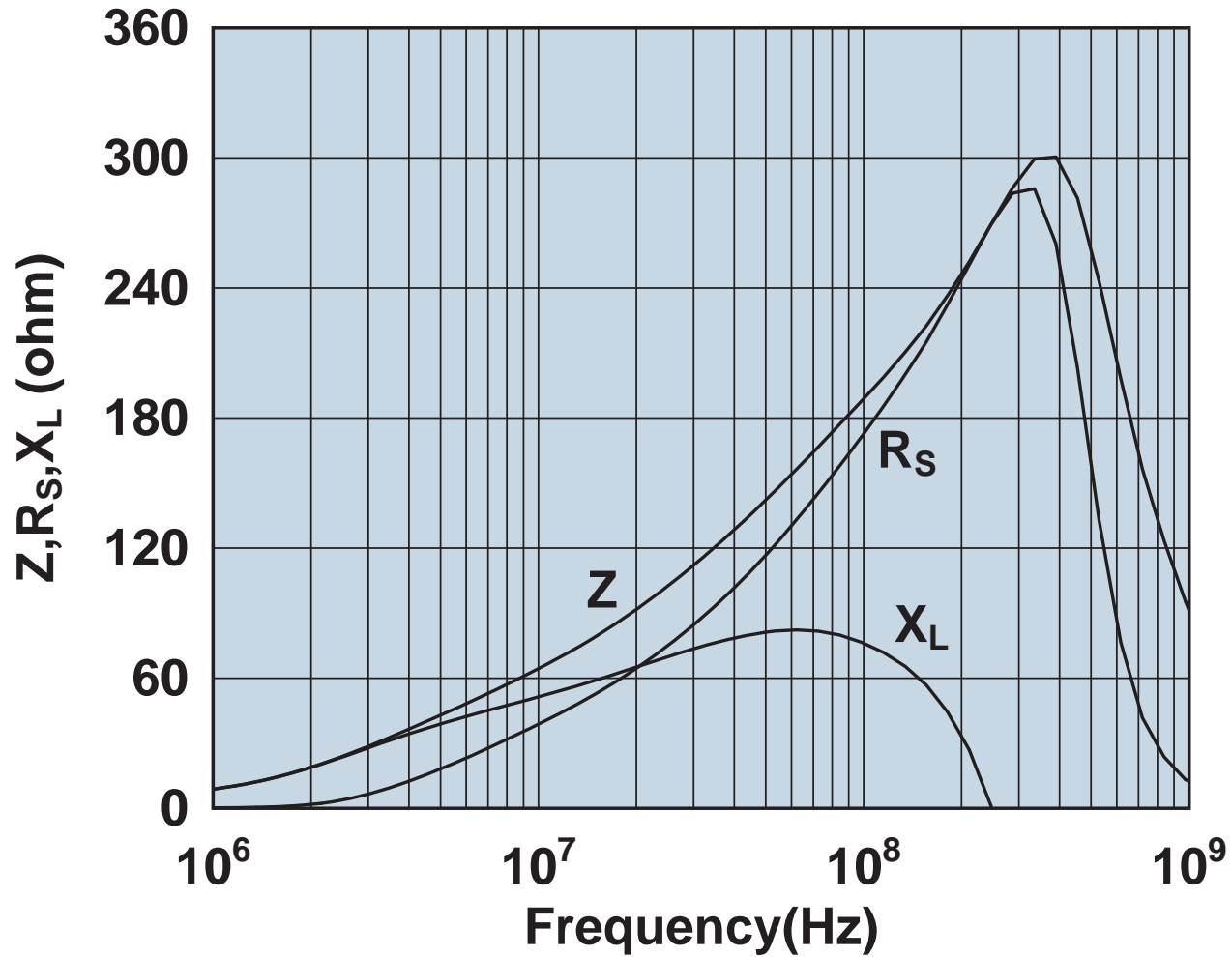

Impedance, reactance, and resistance vs. frequency.

2646173551

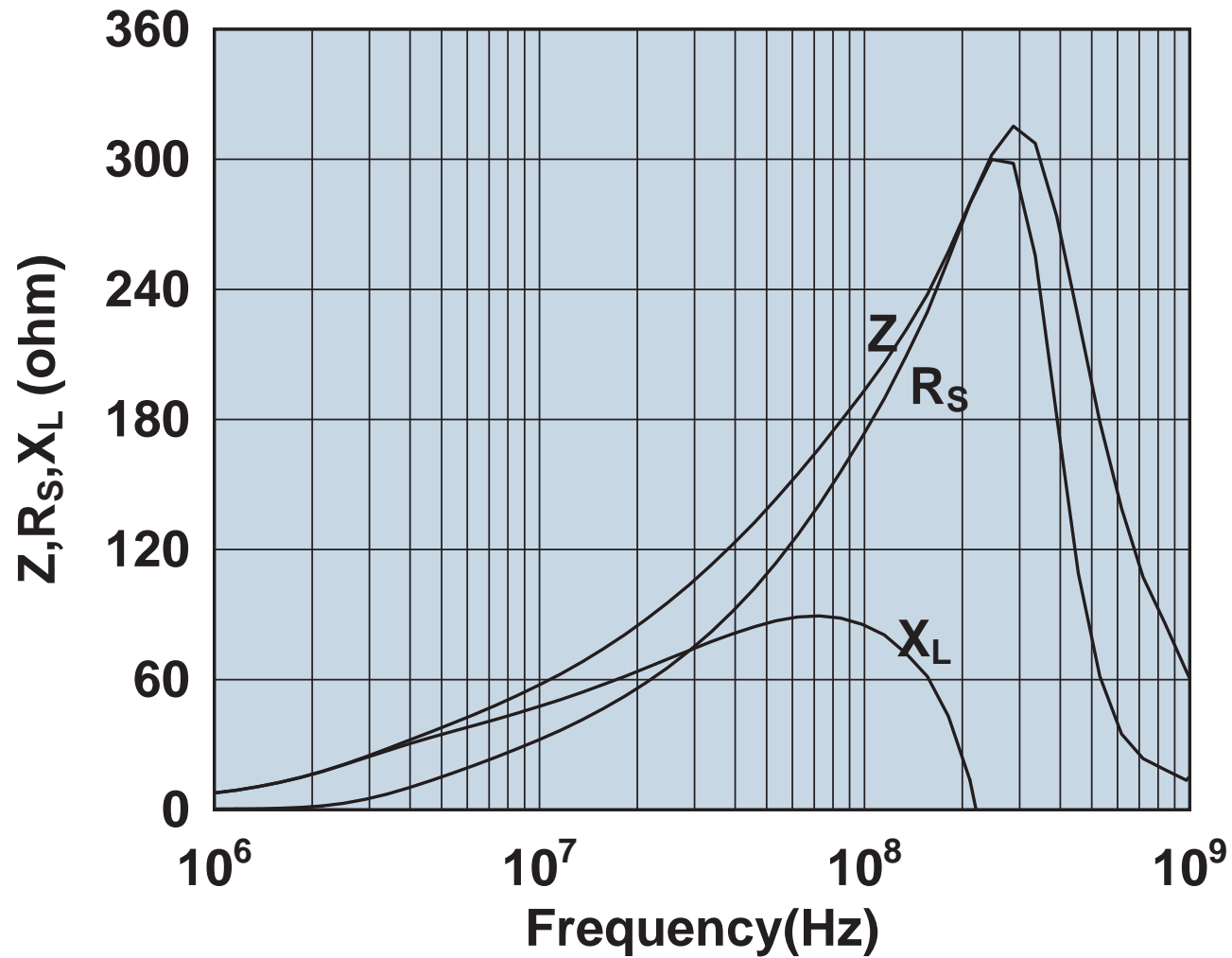

Impedance, reactance, and resistance vs. frequency.



2646173951

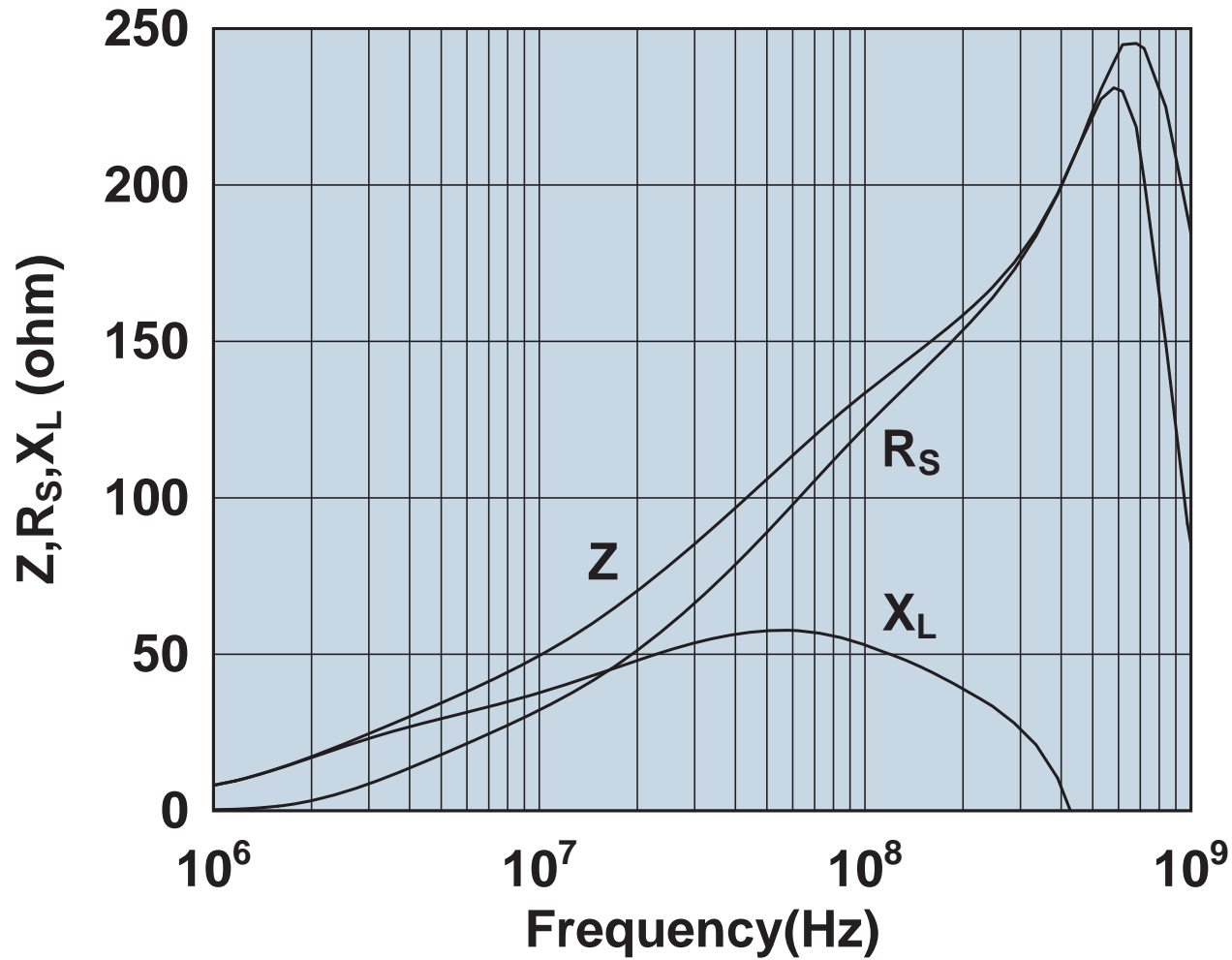

Impedance, reactance, and resistance vs. frequency.

2646176451

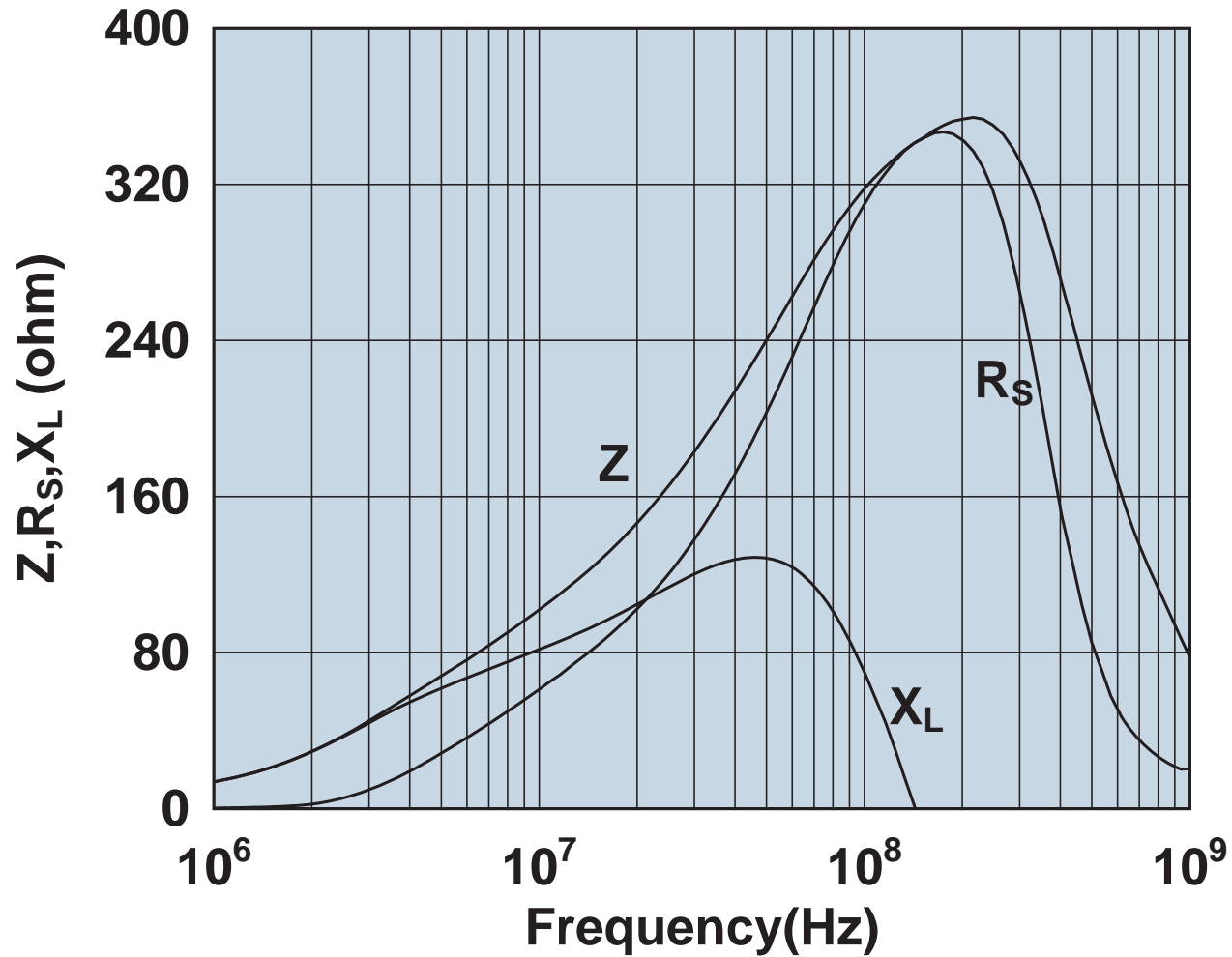

Impedance, reactance, and resistance vs. frequency.

2646177081

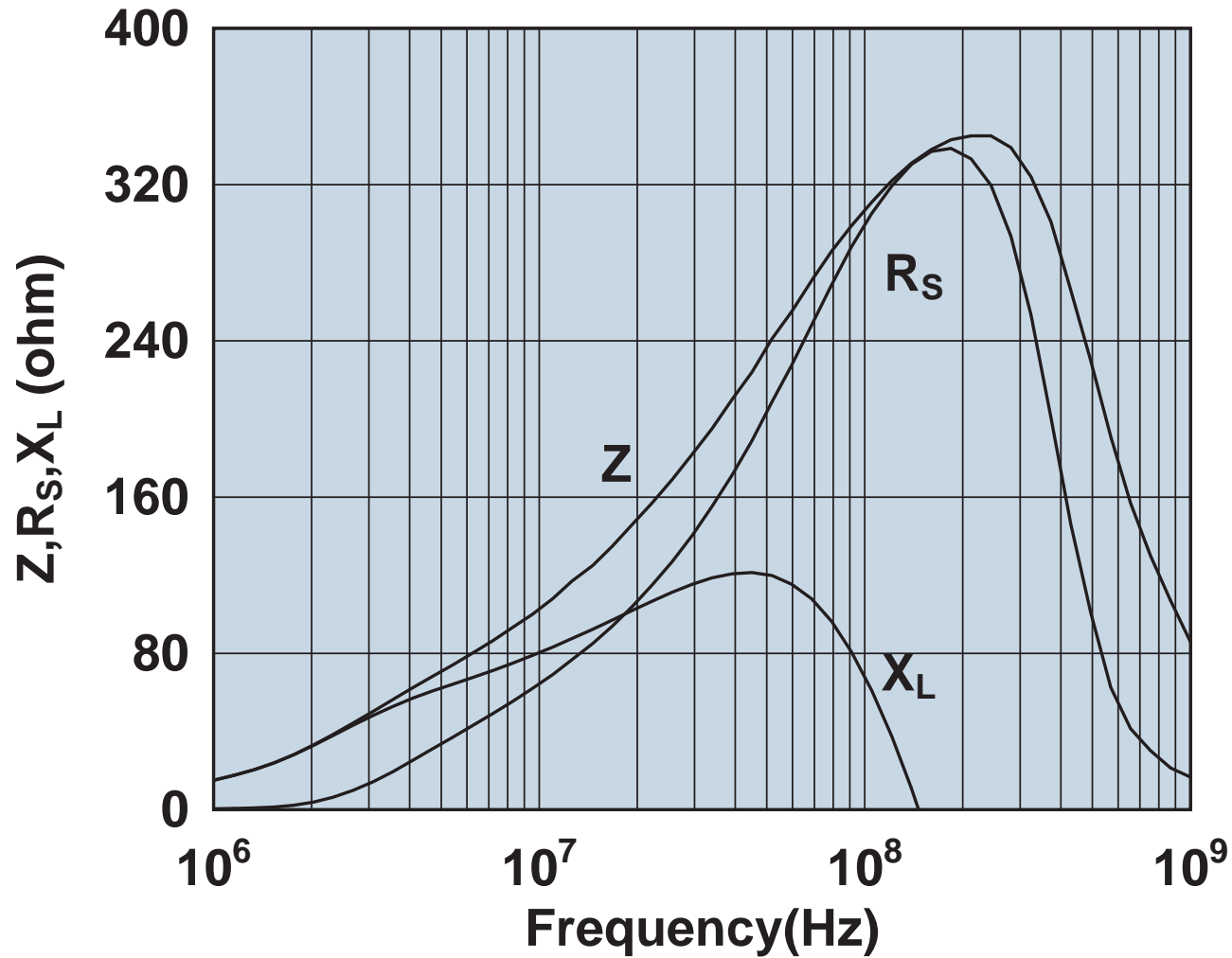

Impedance, reactance, and resistance vs. frequency.

2646480002

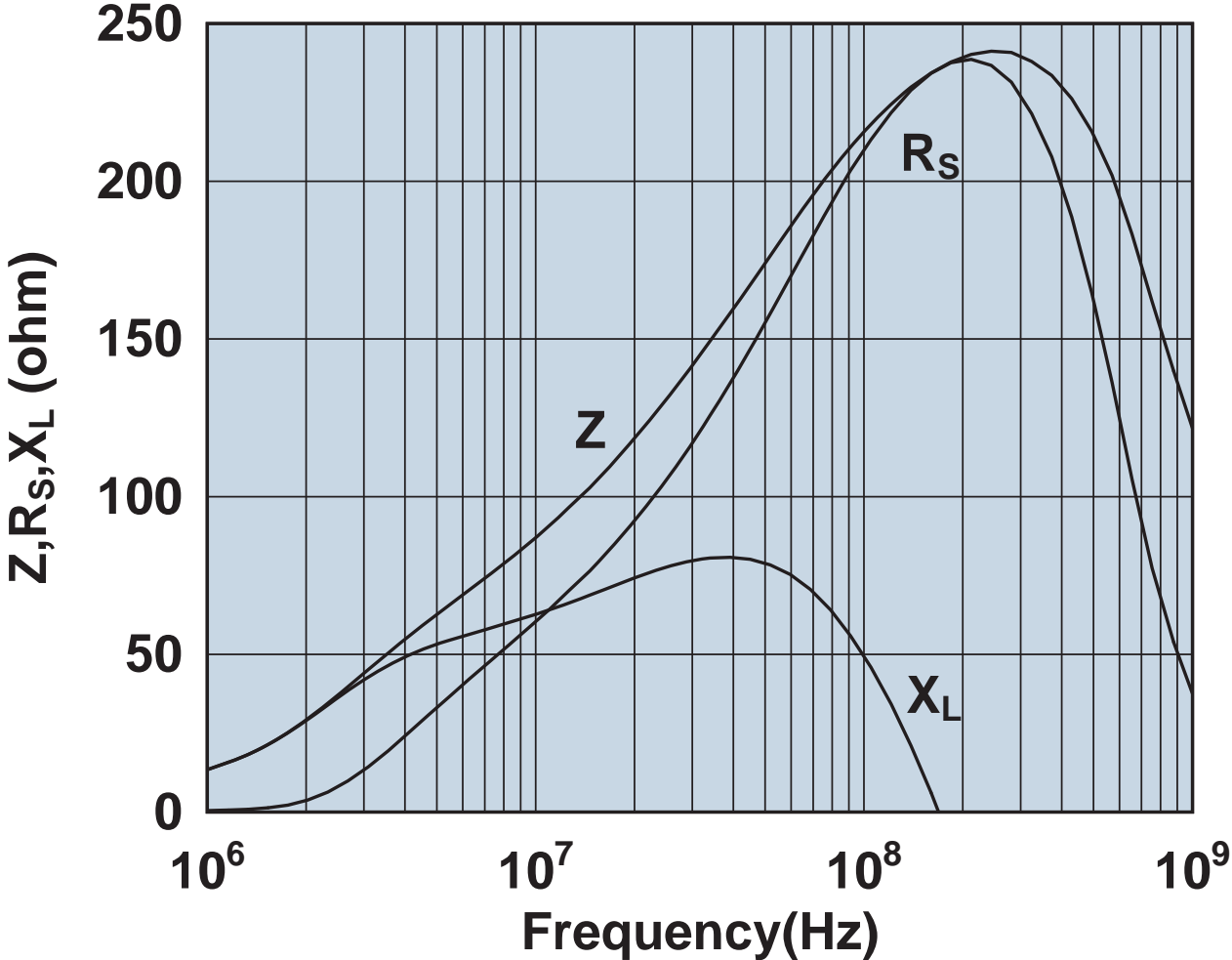

Impedance, reactance, and resistance vs. frequency.

2646480102

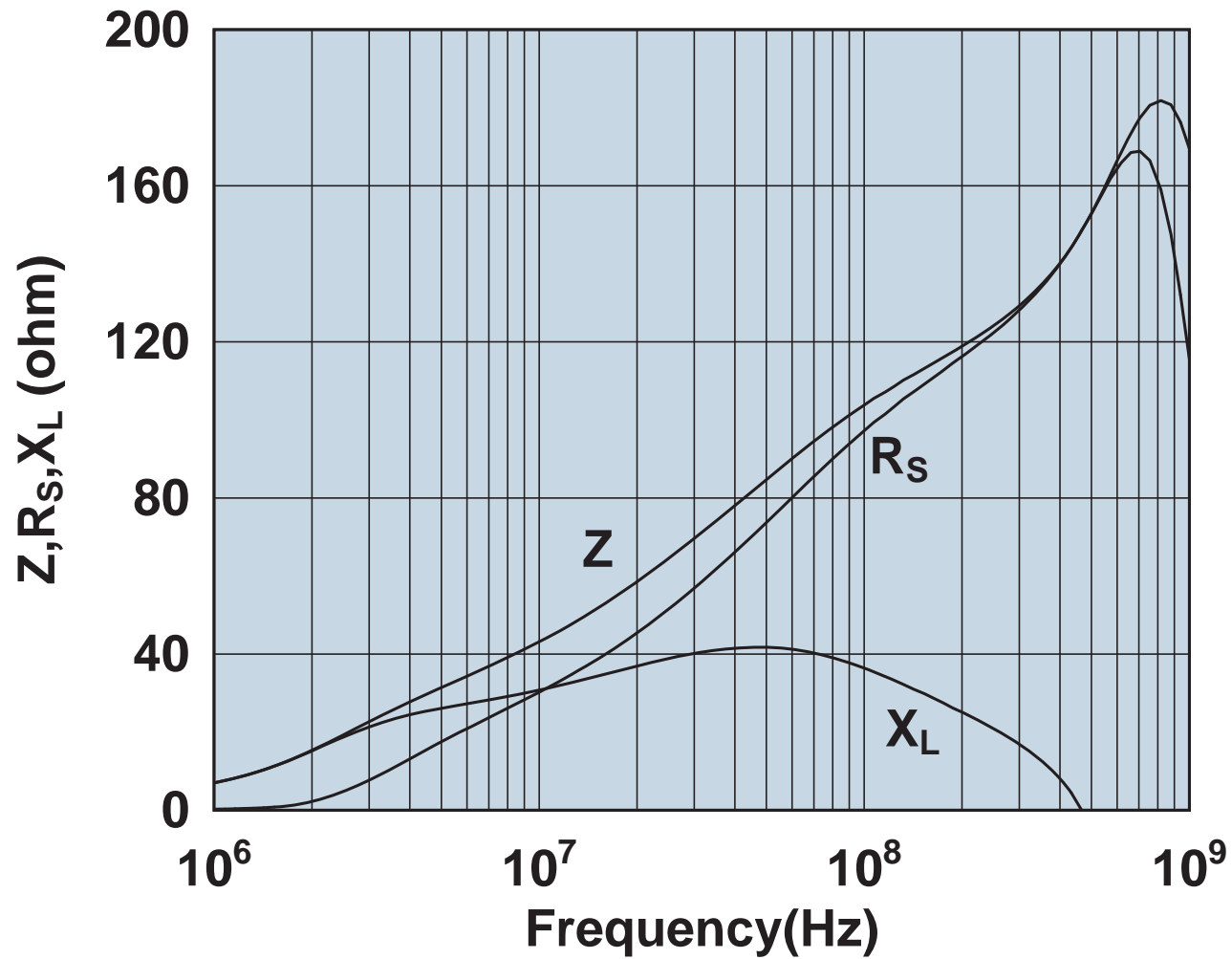

Impedance, reactance, and resistance vs. frequency.

2646540002

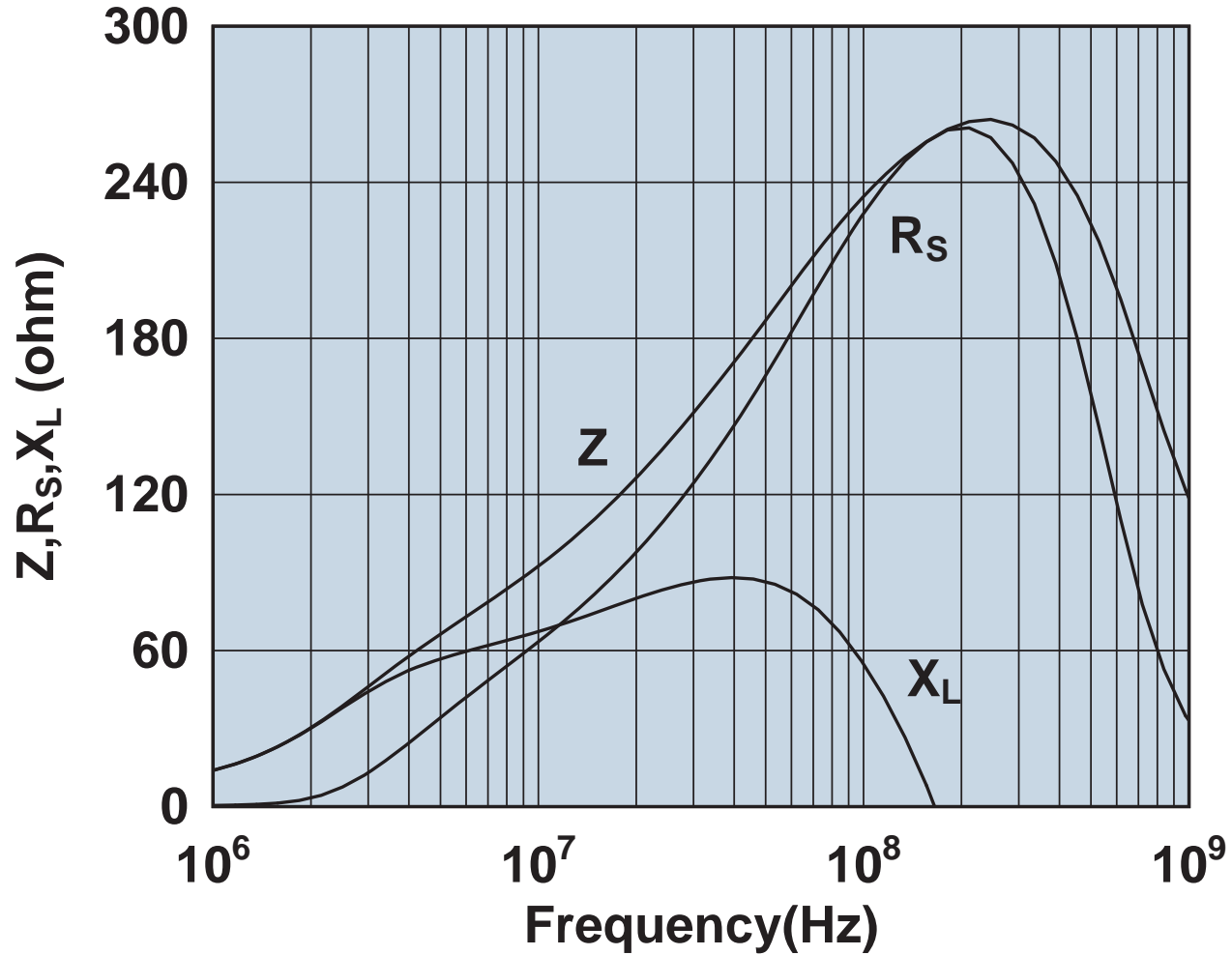

Impedance, reactance, and resistance vs. frequency.

2646540202

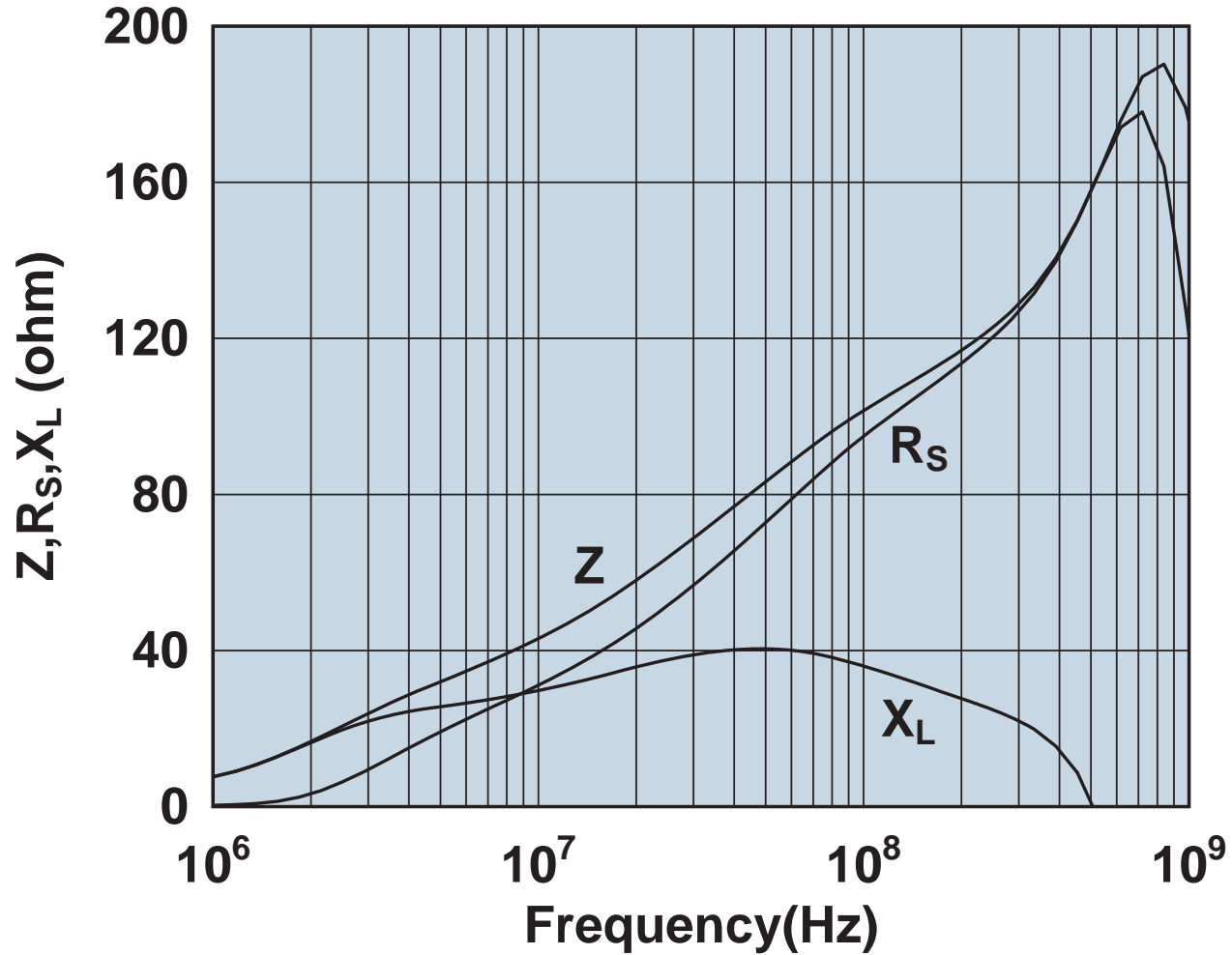

Impedance, reactance, and resistance vs. frequency.

2646625002

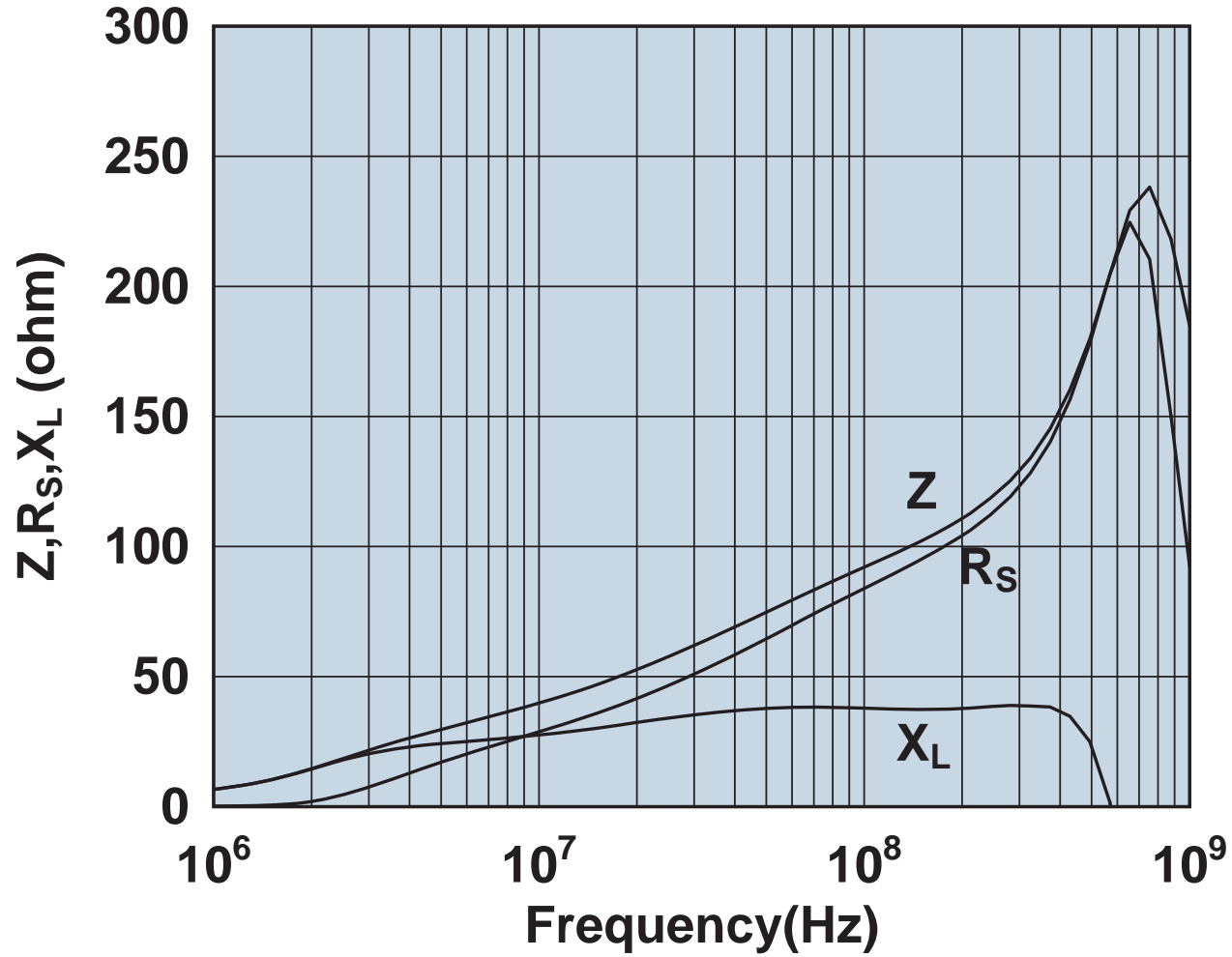

Impedance, reactance, and resistance vs. frequency.



2646625102

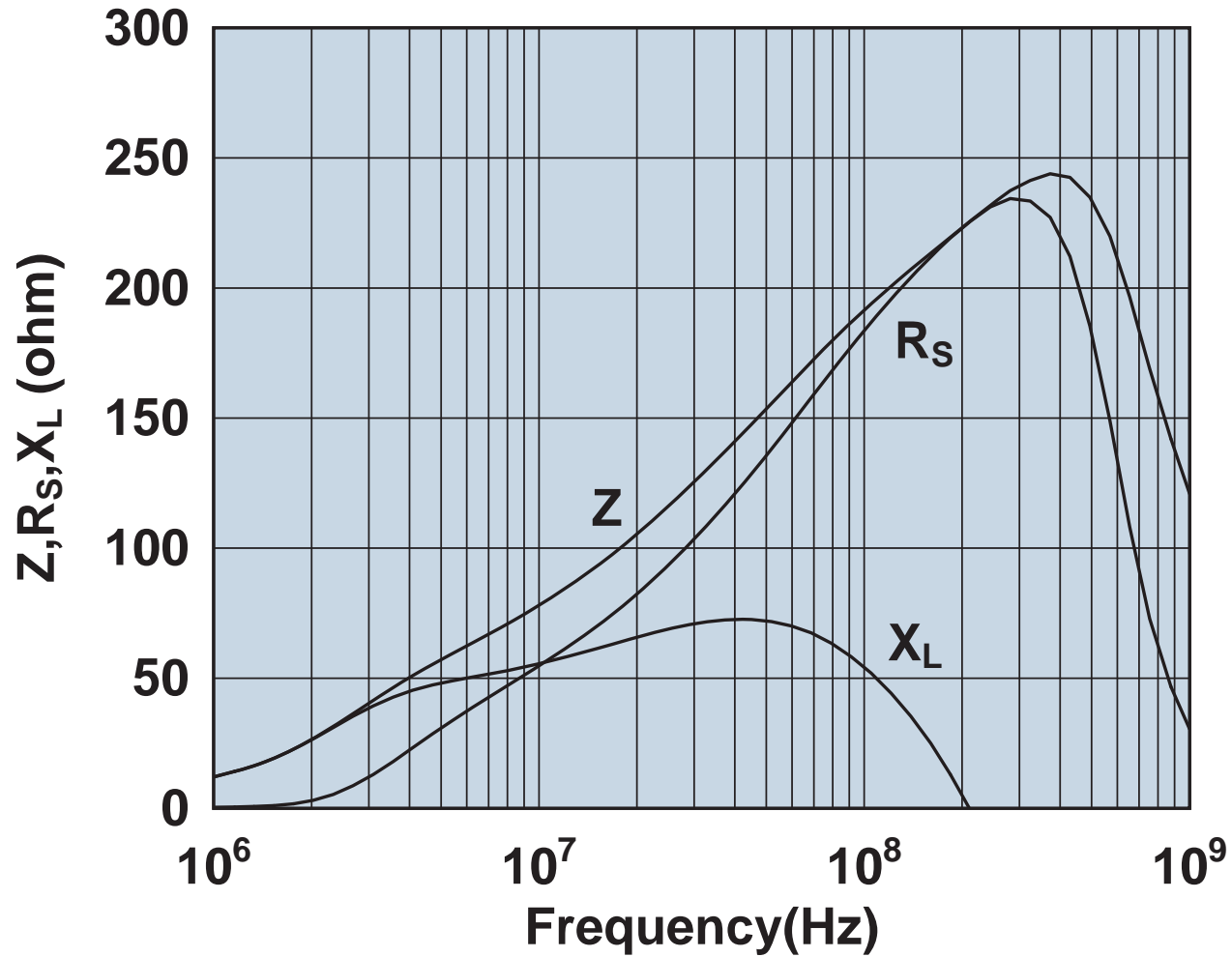

Impedance, reactance, and resistance vs. frequency.

2646625202

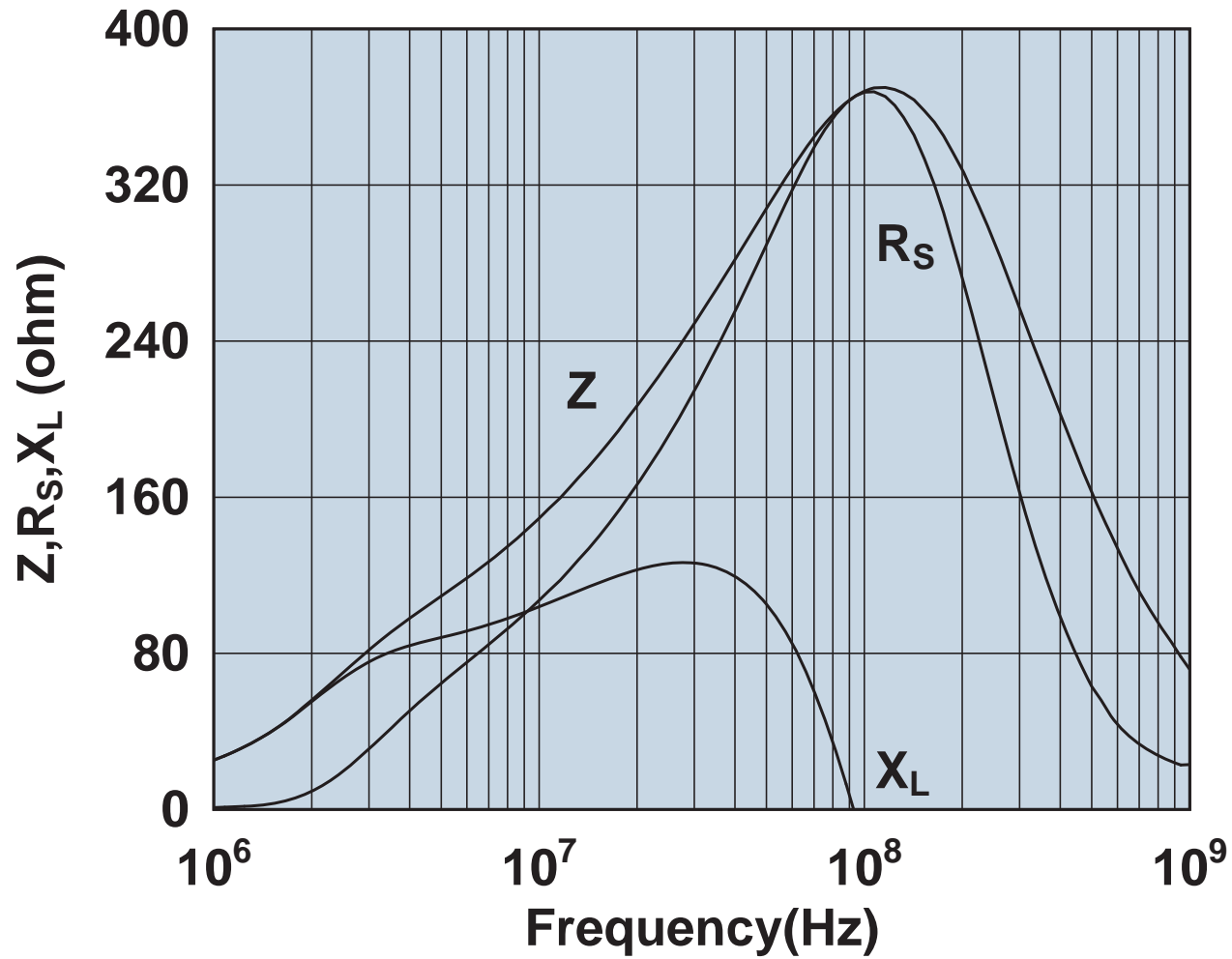

Impedance, reactance, and resistance vs. frequency.

2646626202

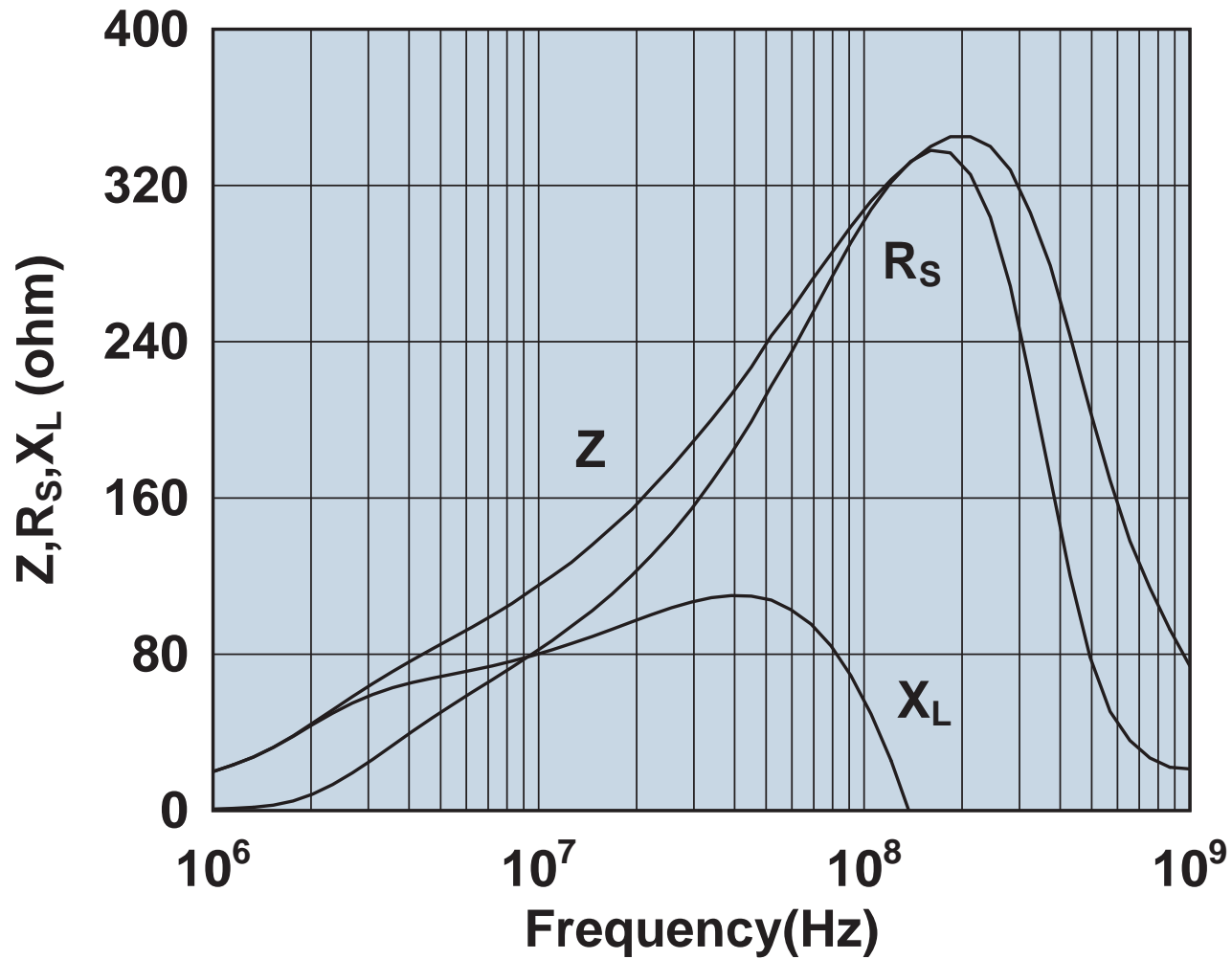

Impedance, reactance, and resistance vs. frequency.

2646665702

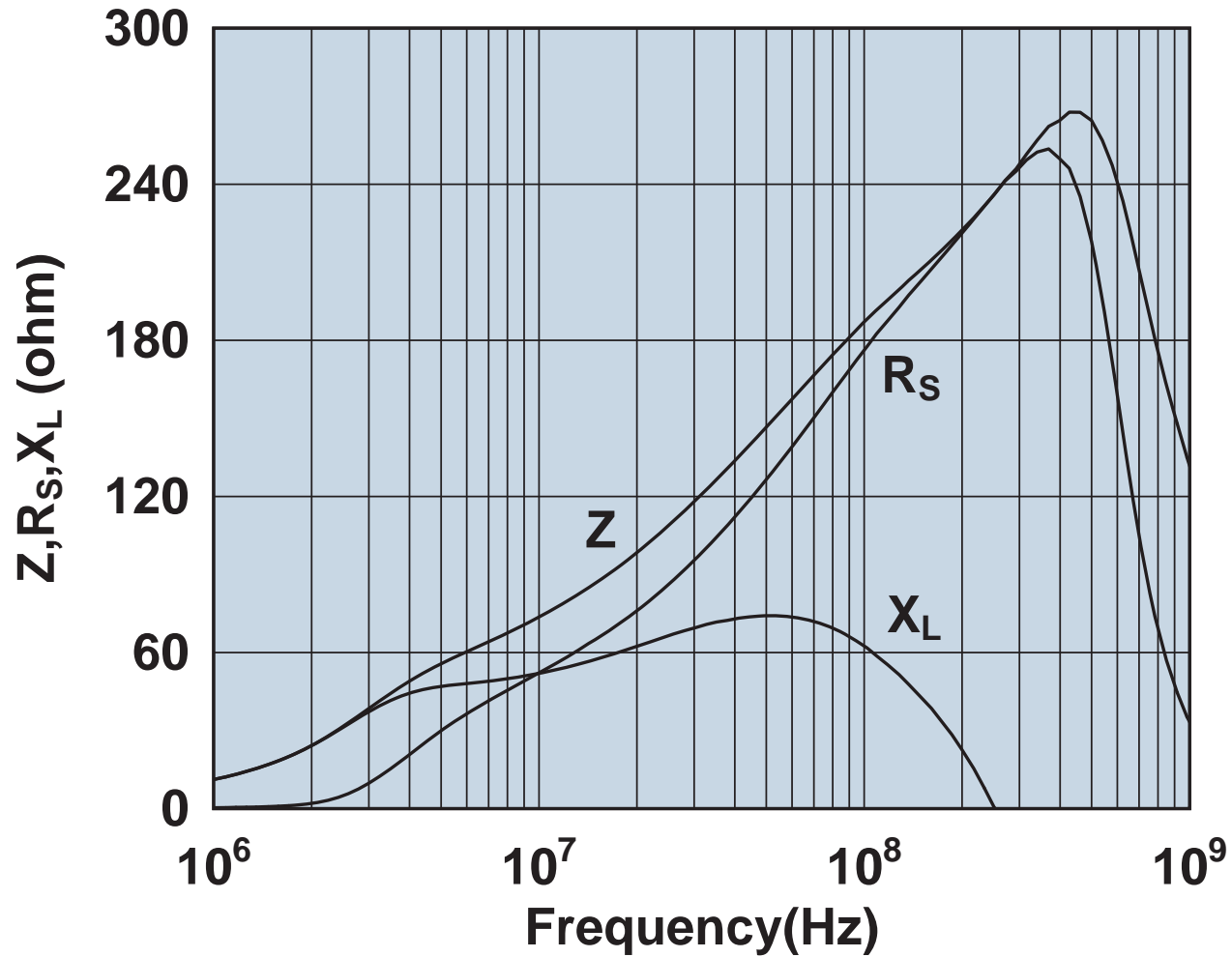

Impedance, reactance, and resistance vs. frequency.

2646665802

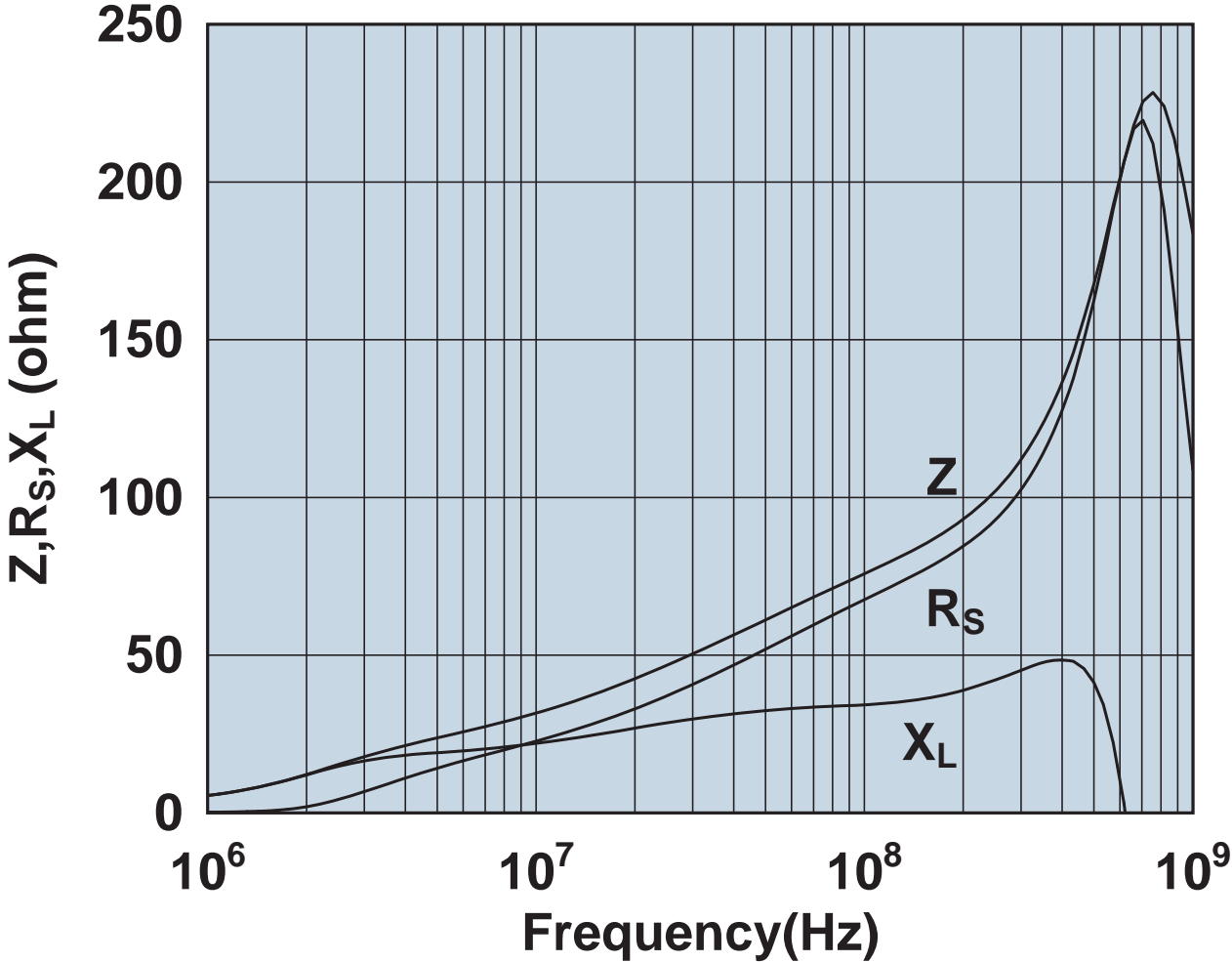

Impedance, reactance, and resistance vs. frequency.

2646803802

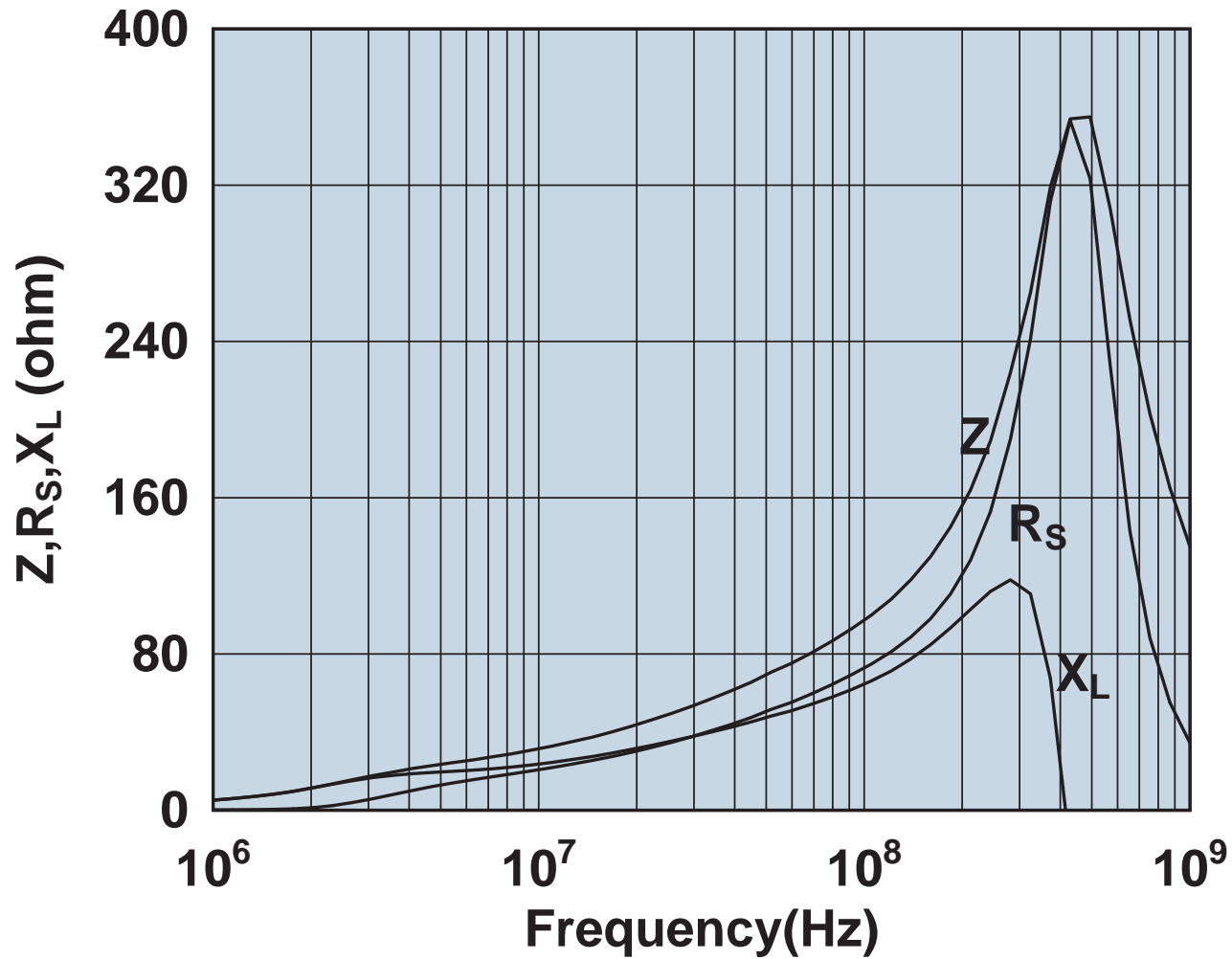

Impedance, reactance, and resistance vs. frequency.

2646804502

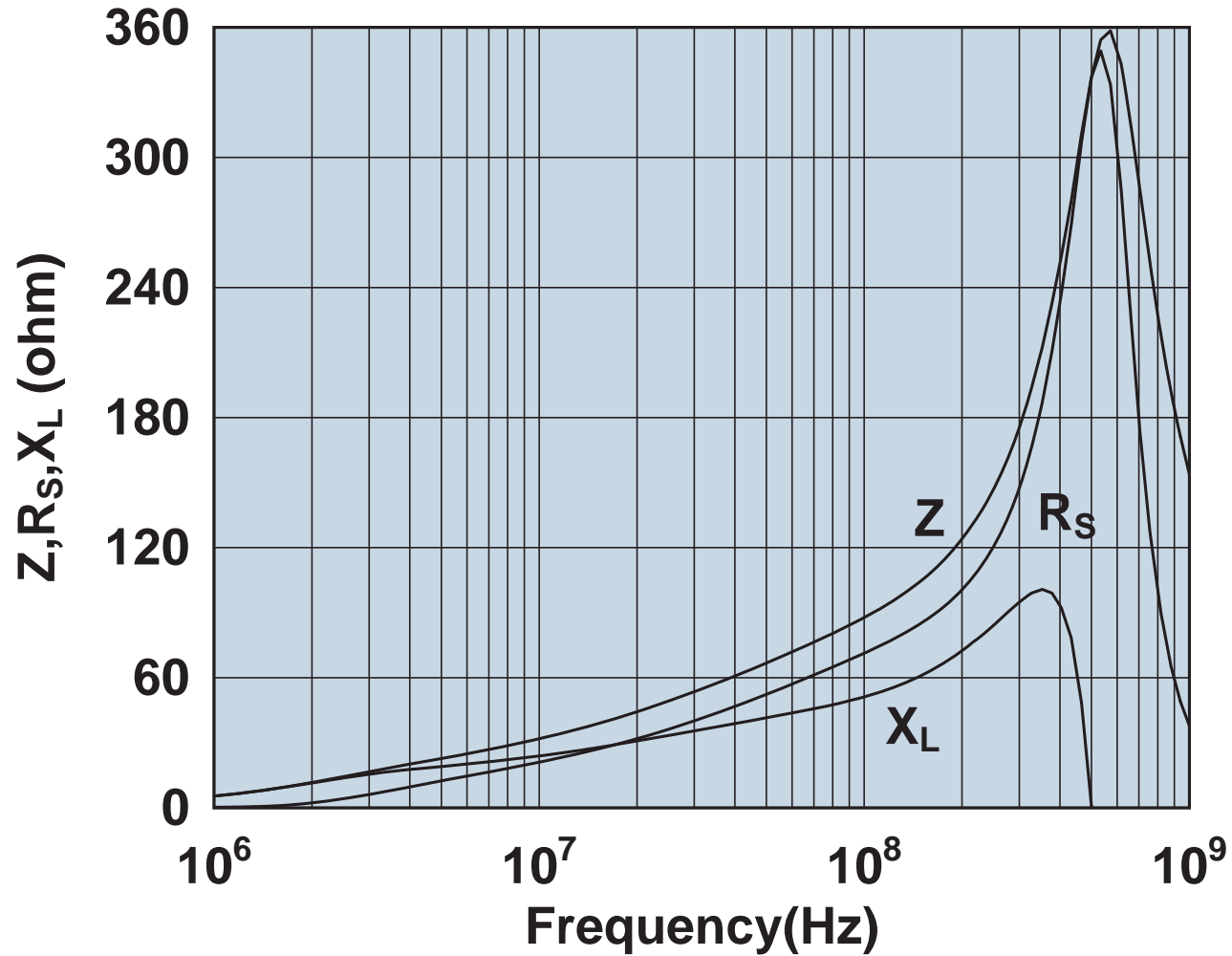

Impedance, reactance, and resistance vs. frequency.

2661102002

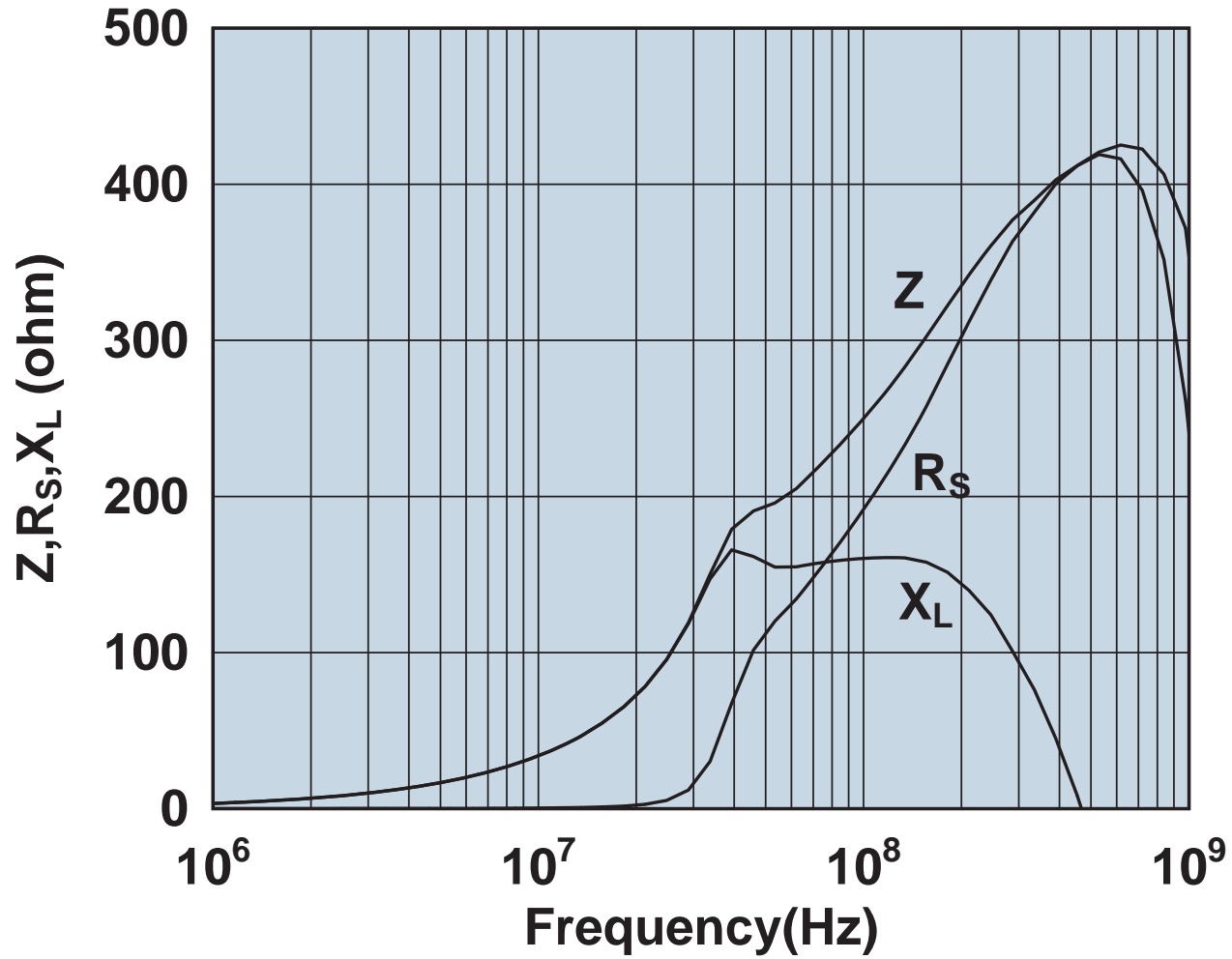

Impedance, reactance, and resistance vs. frequency.



2661102402

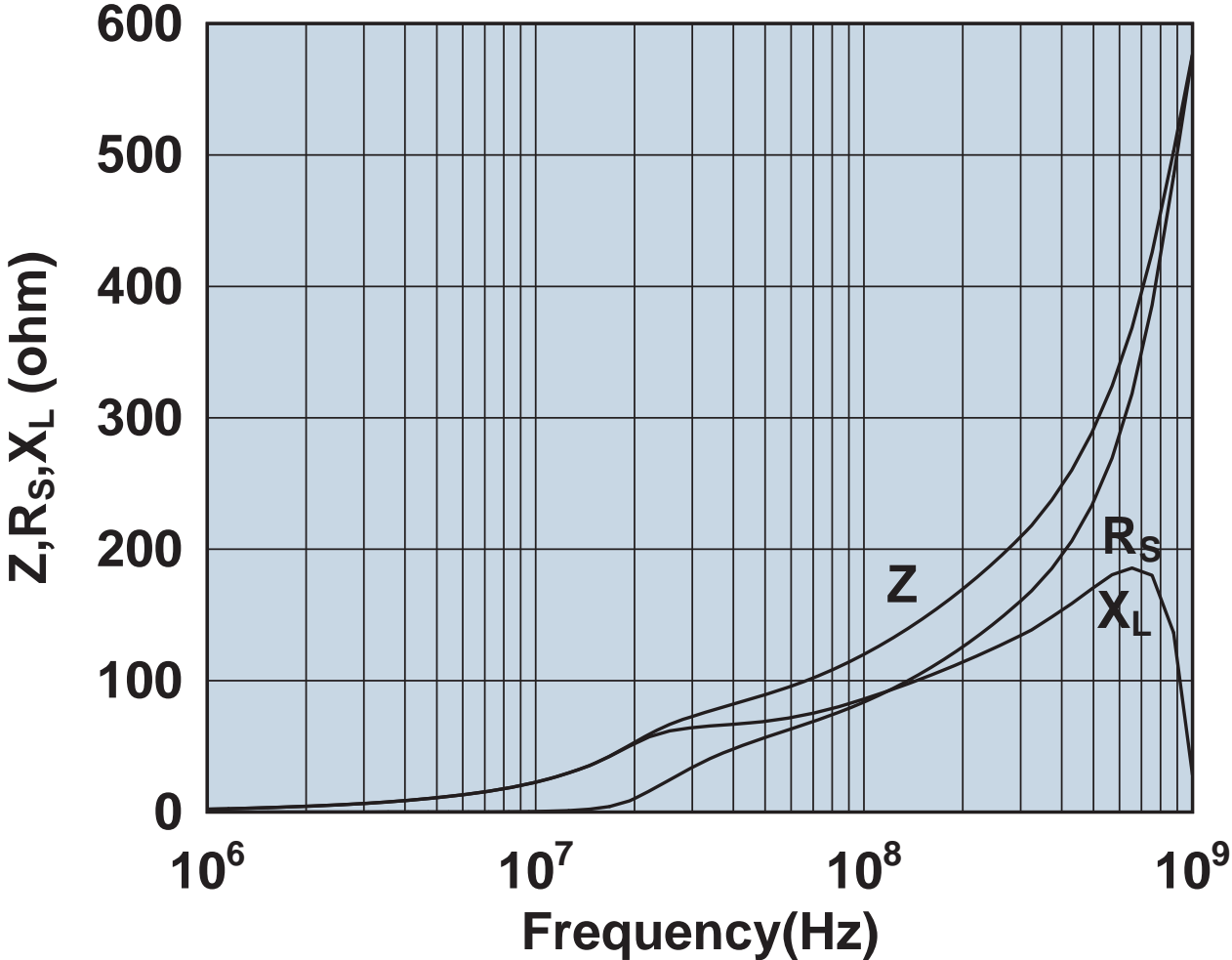

Impedance, reactance, and resistance vs. frequency.

2661164181

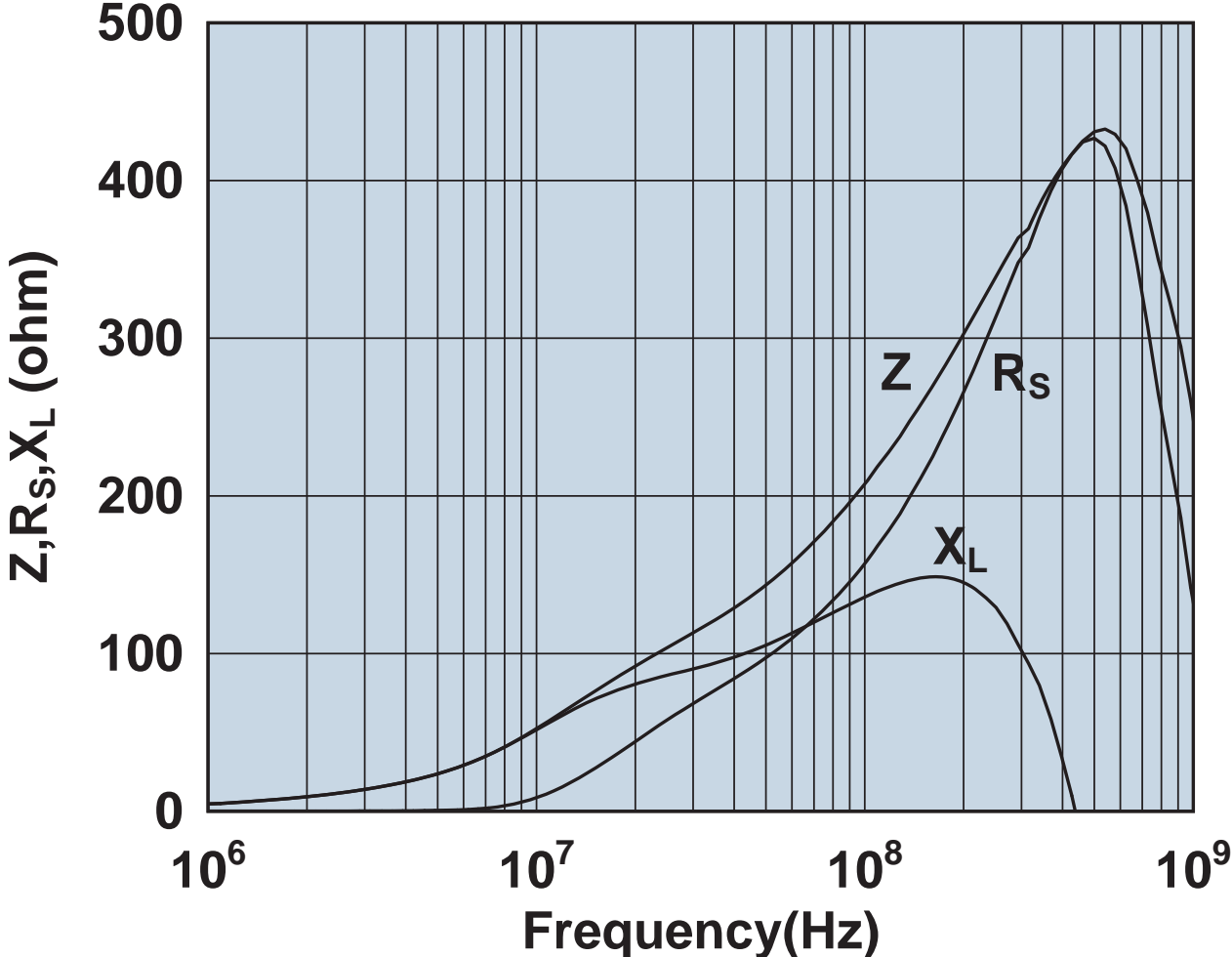

Impedance, reactance, and resistance vs. frequency.

2661164281

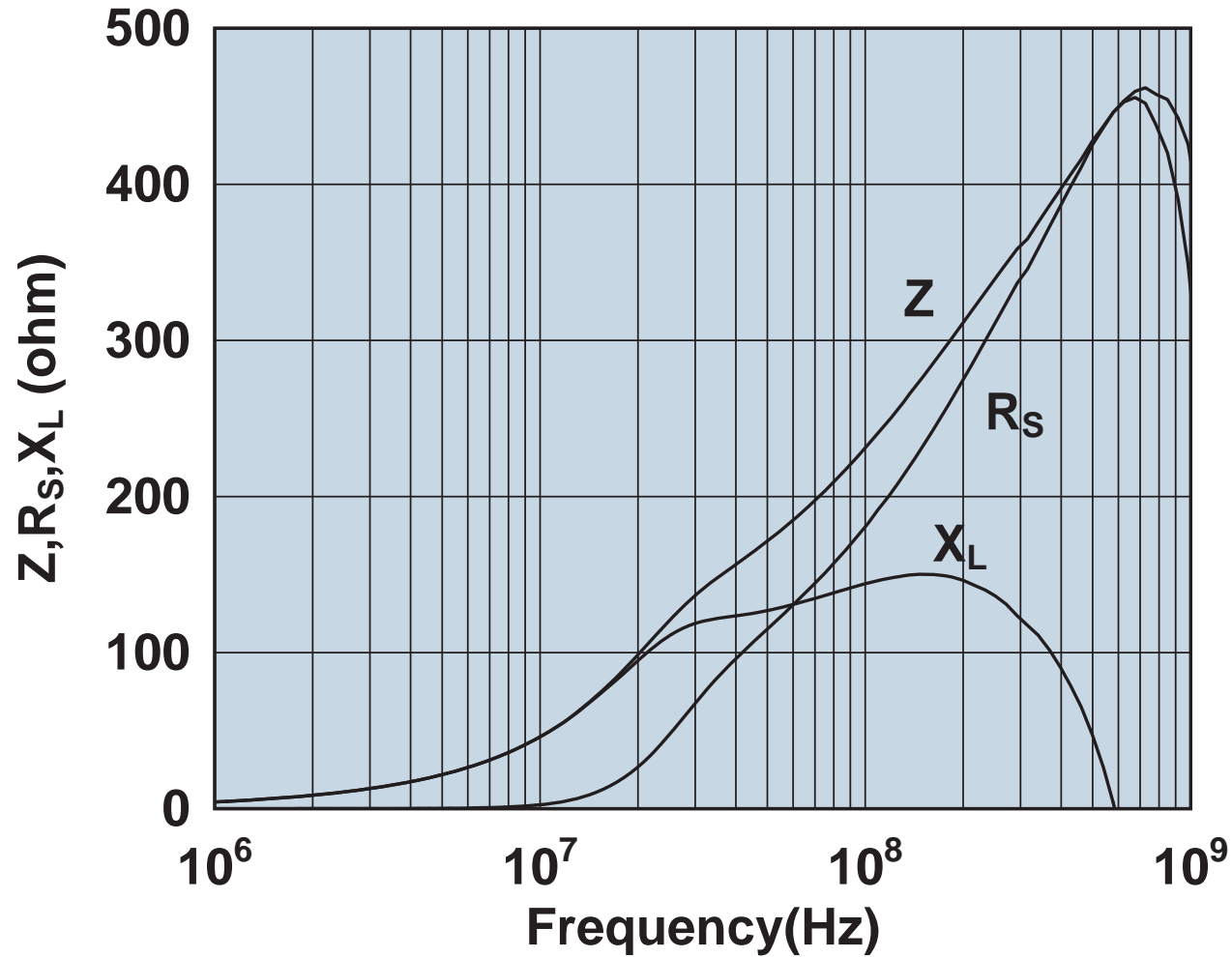

Impedance, reactance, and resistance vs. frequency.

2661164951

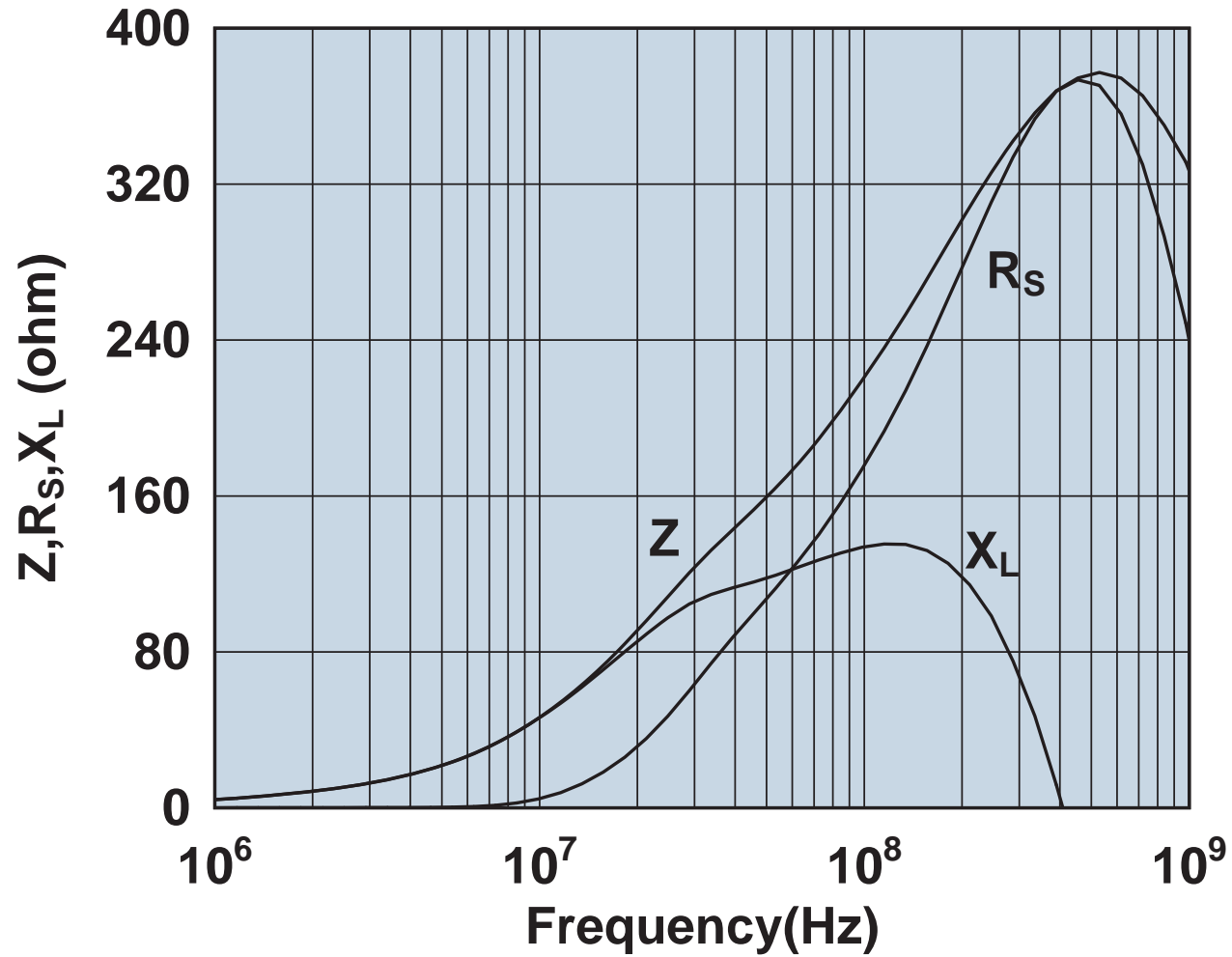

Impedance, reactance, and resistance vs. frequency.

2661167281

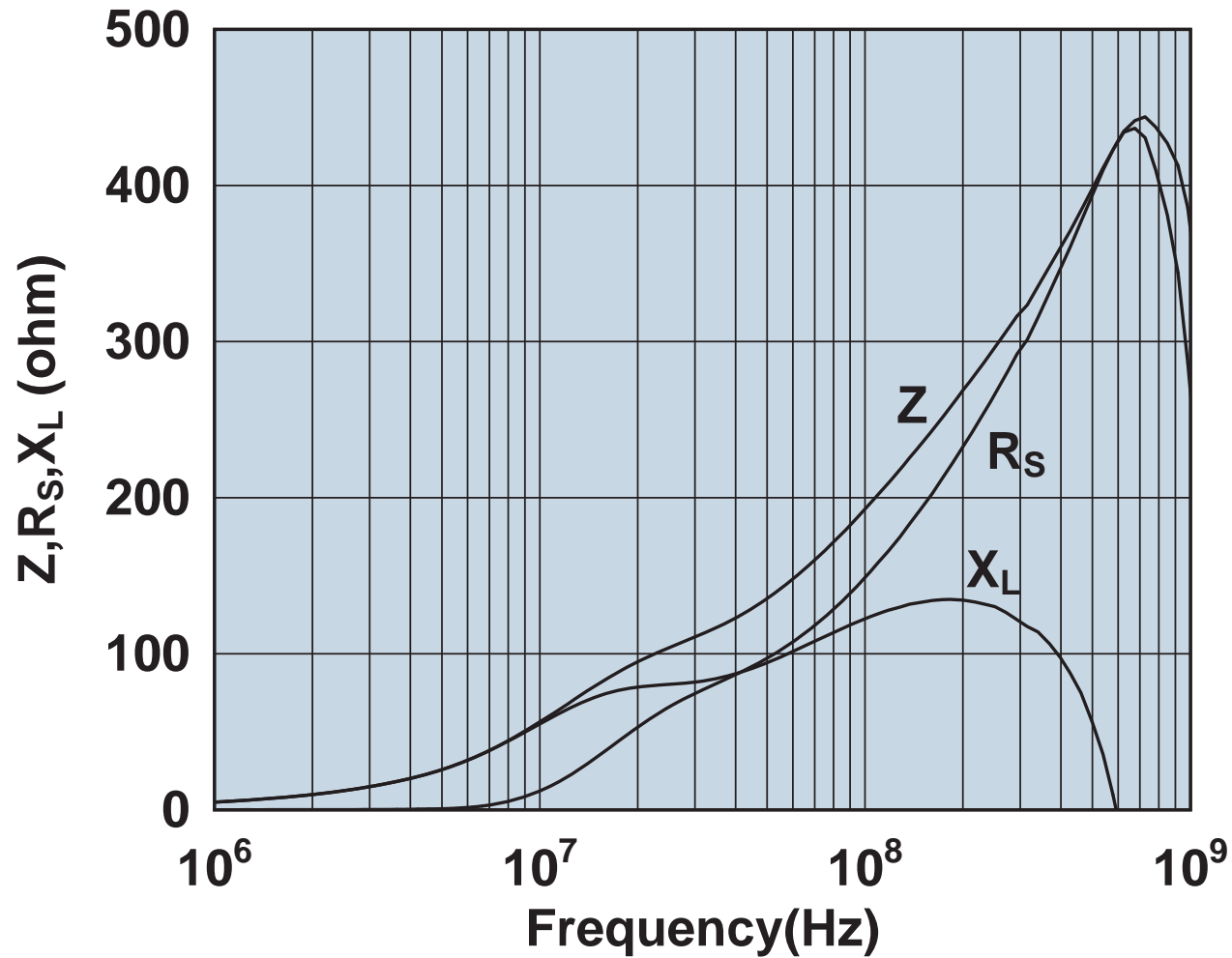

Impedance, reactance, and resistance vs. frequency.

2661176451

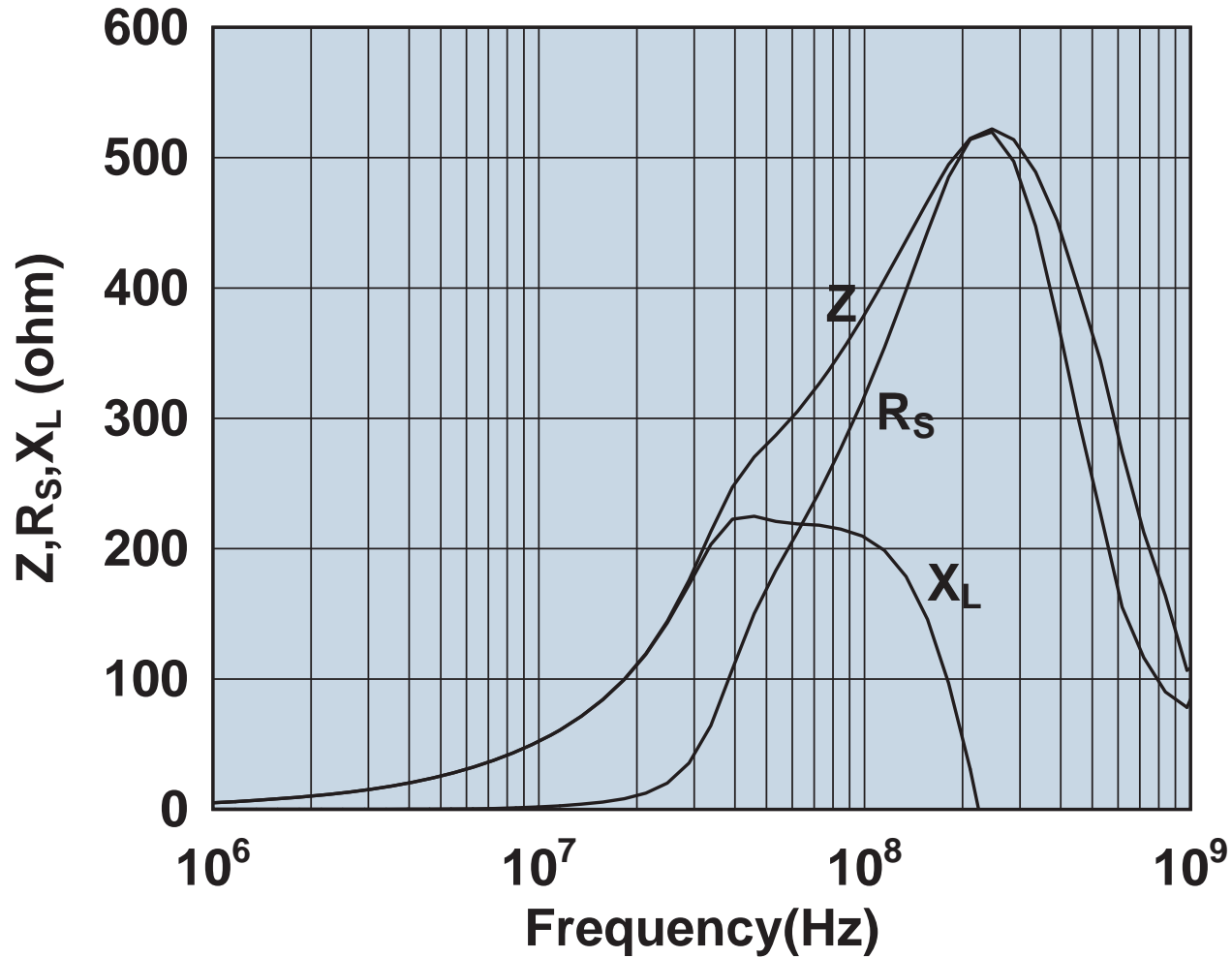

Impedance, reactance, and resistance vs. frequency.

2661178181

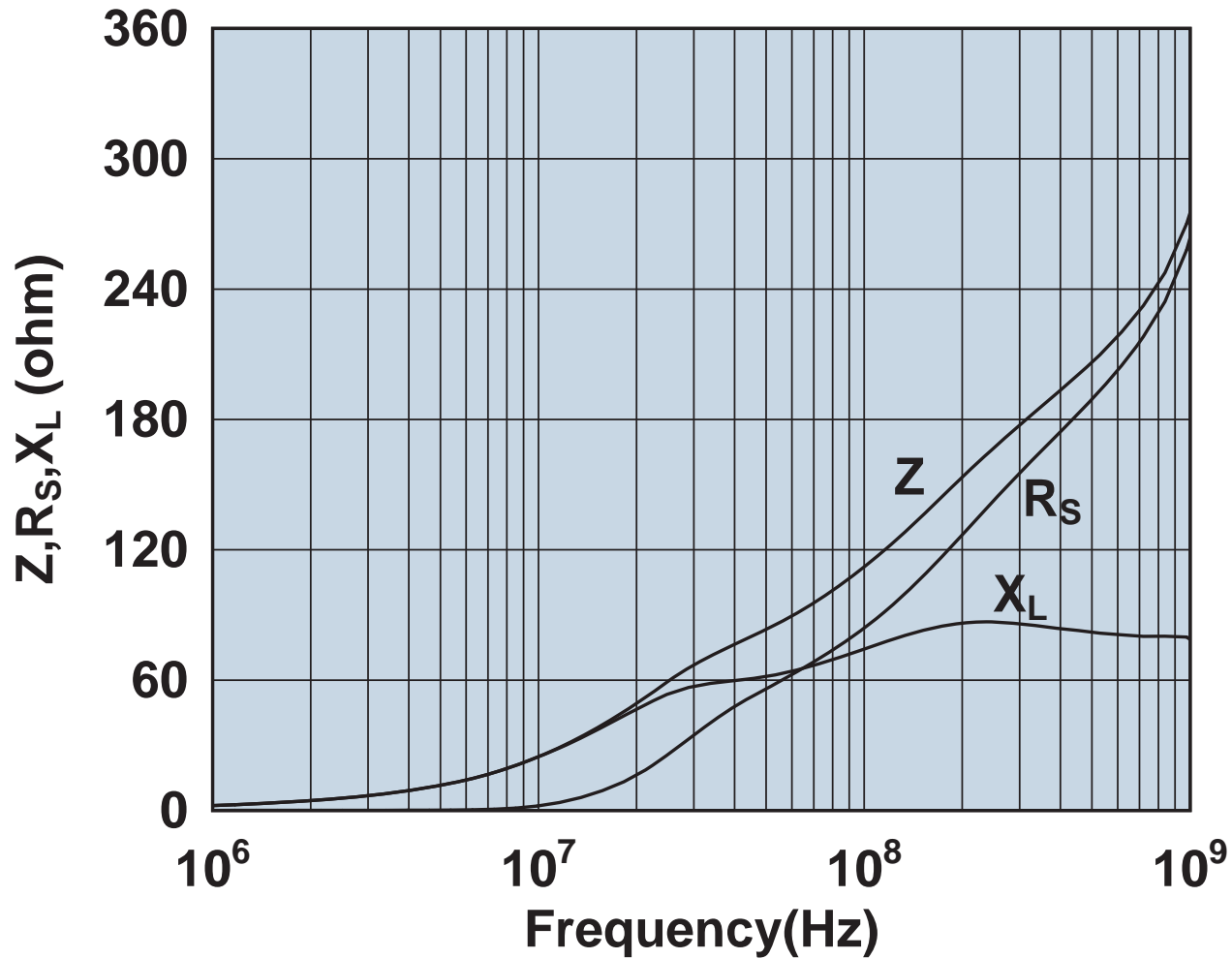

Impedance, reactance, and resistance vs. frequency.

2661178281

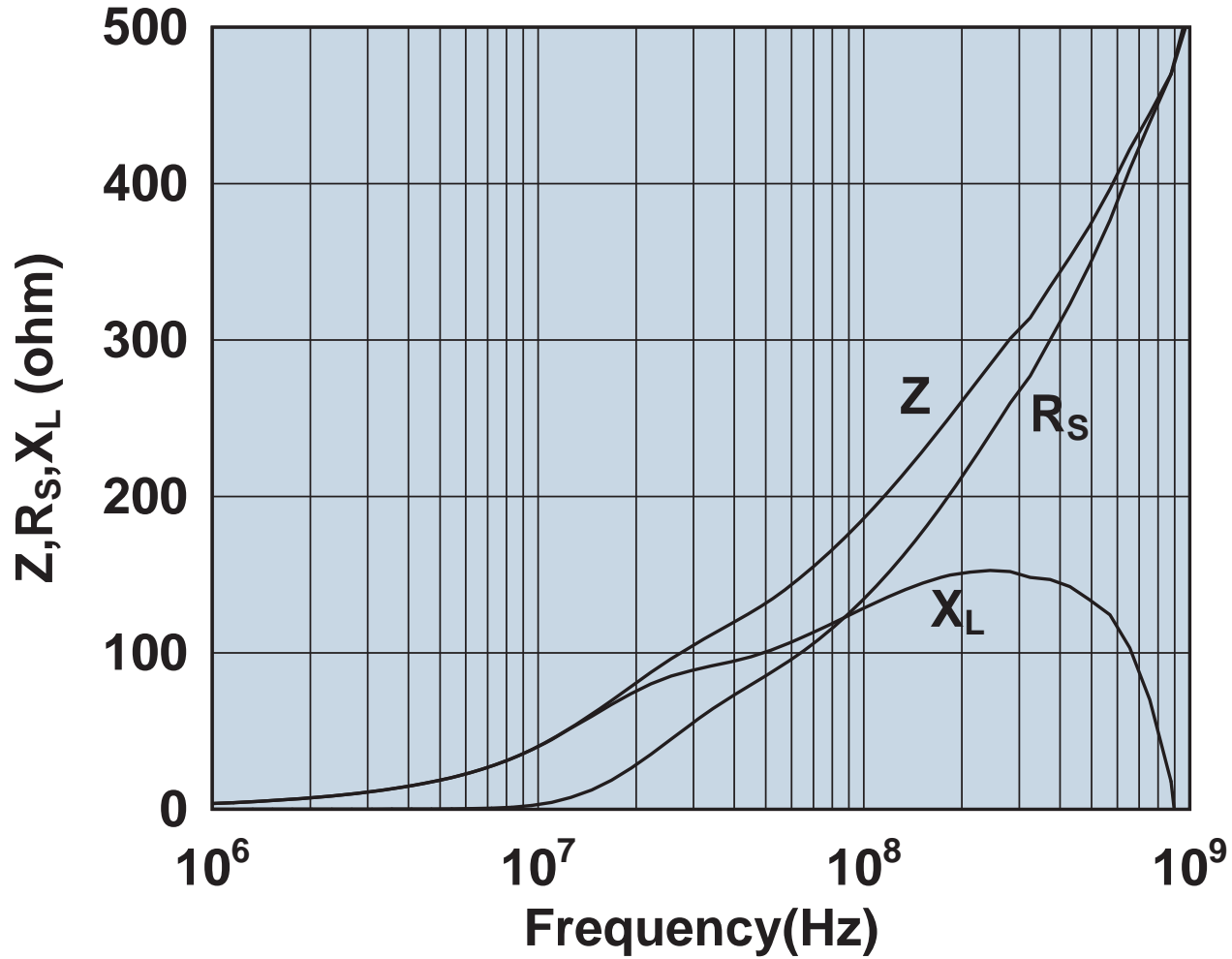

Impedance, reactance, and resistance vs. frequency.



2661540002

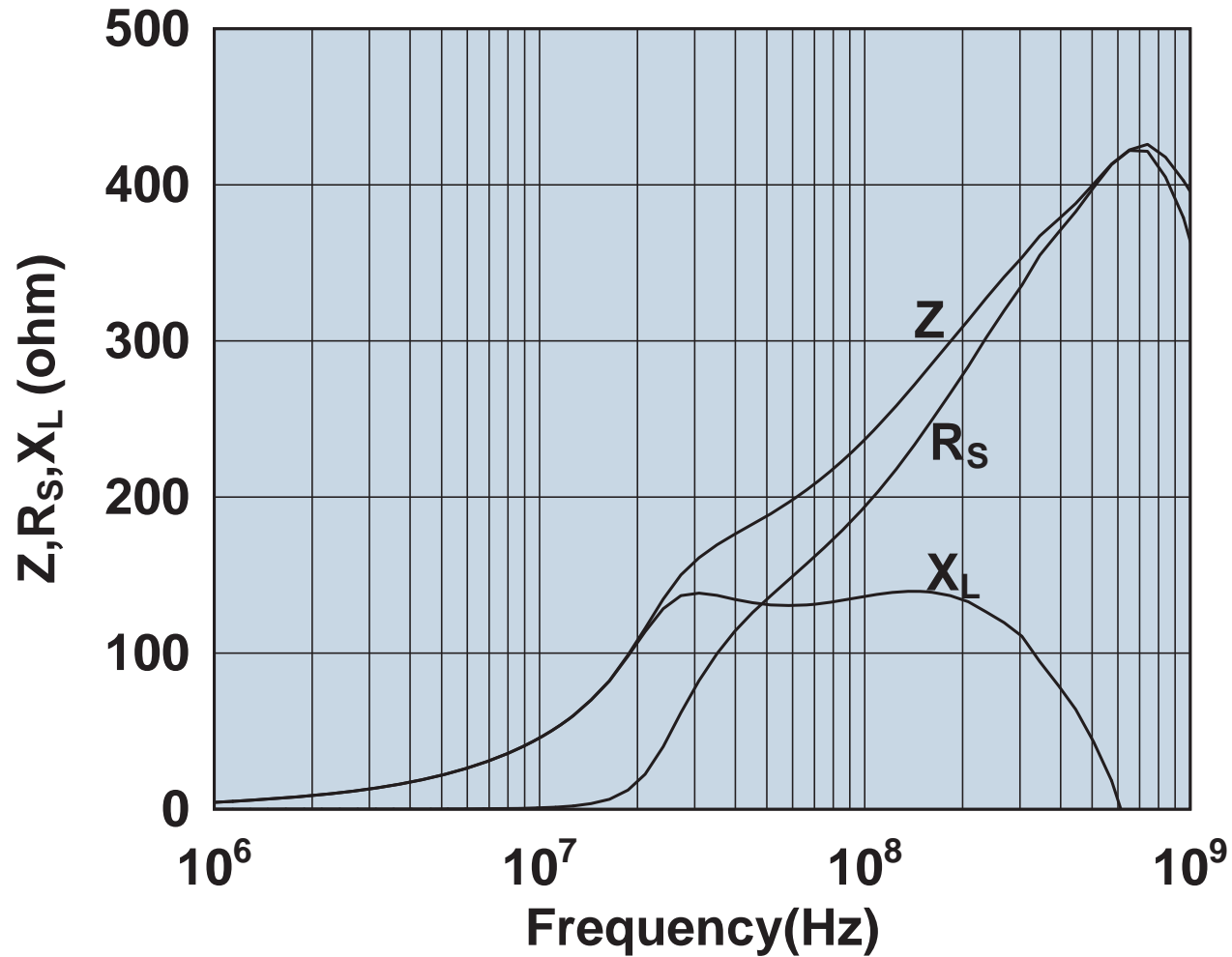

Impedance, reactance, and resistance vs. frequency.

2661540202

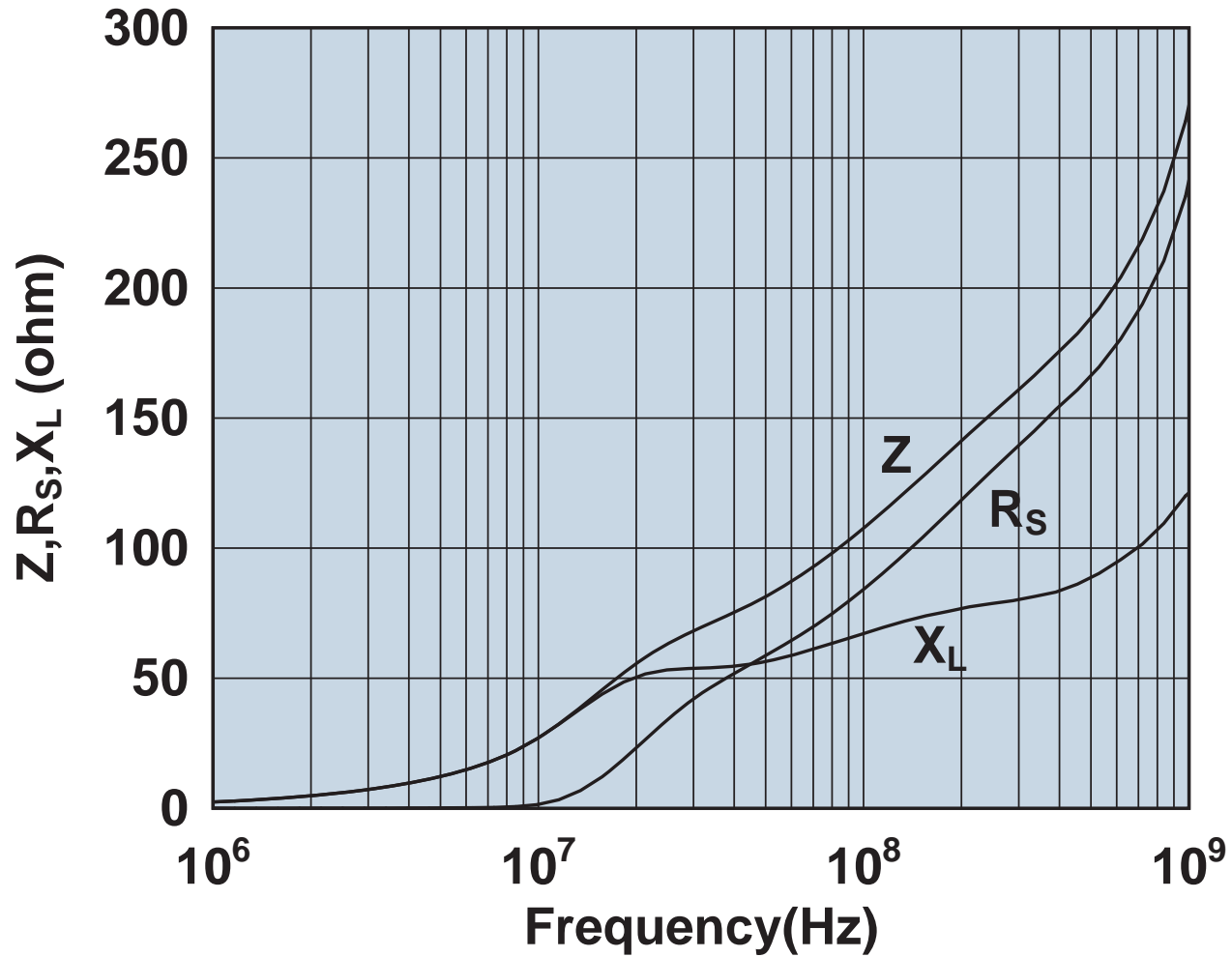

Impedance, reactance, and resistance vs. frequency.

2661626302

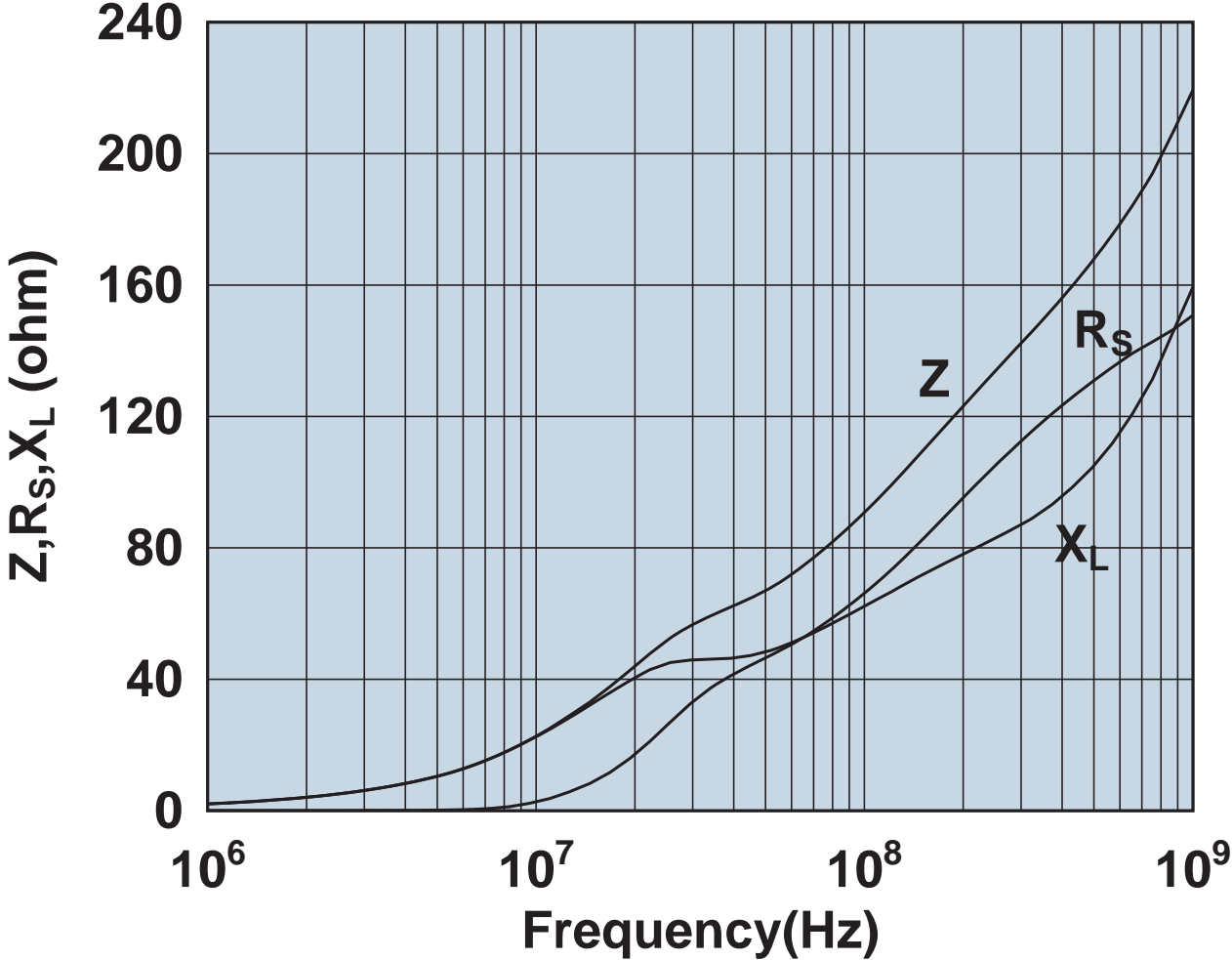

Impedance, reactance, and resistance vs. frequency.

2661626402

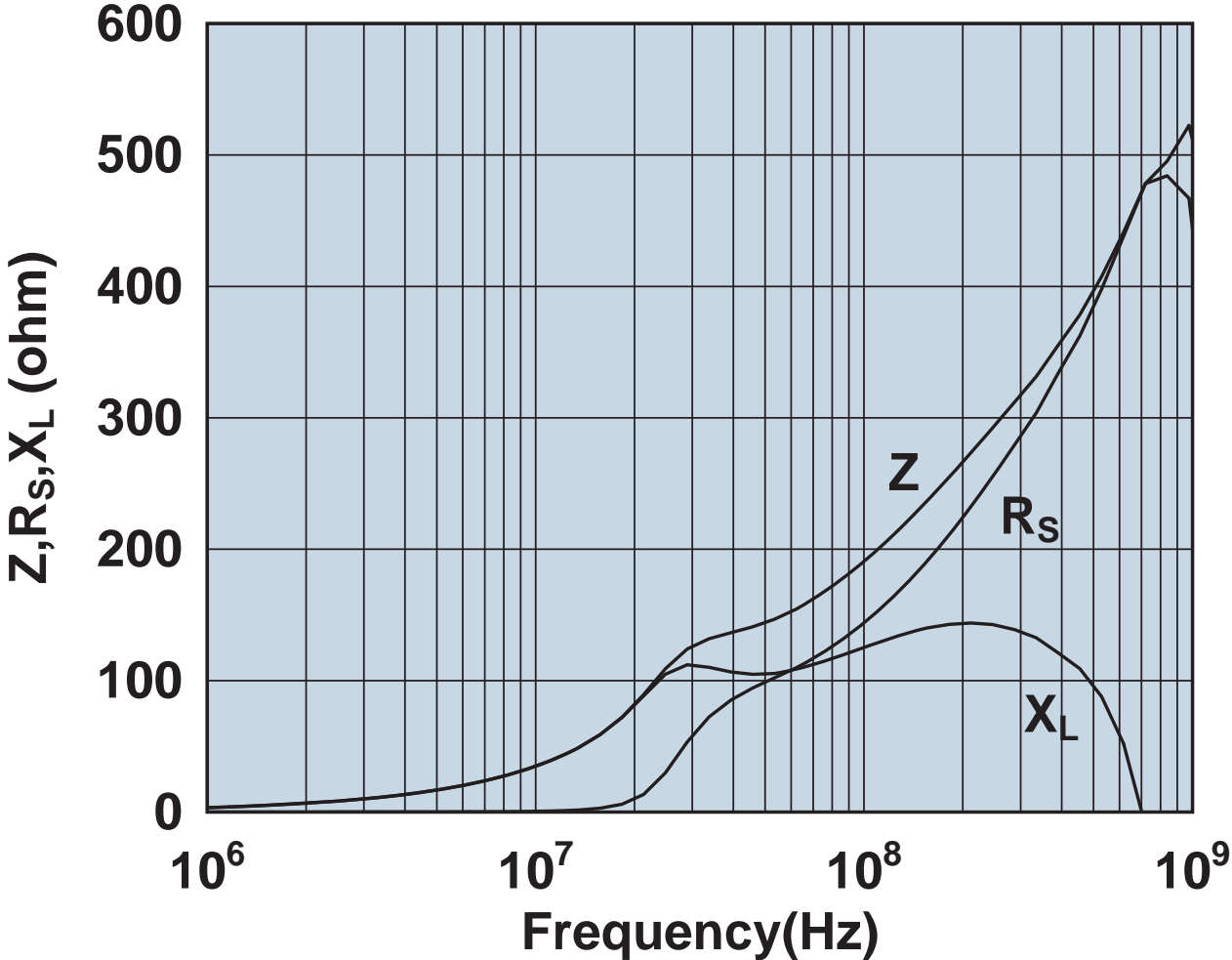

Impedance, reactance, and resistance vs. frequency.

2661665702

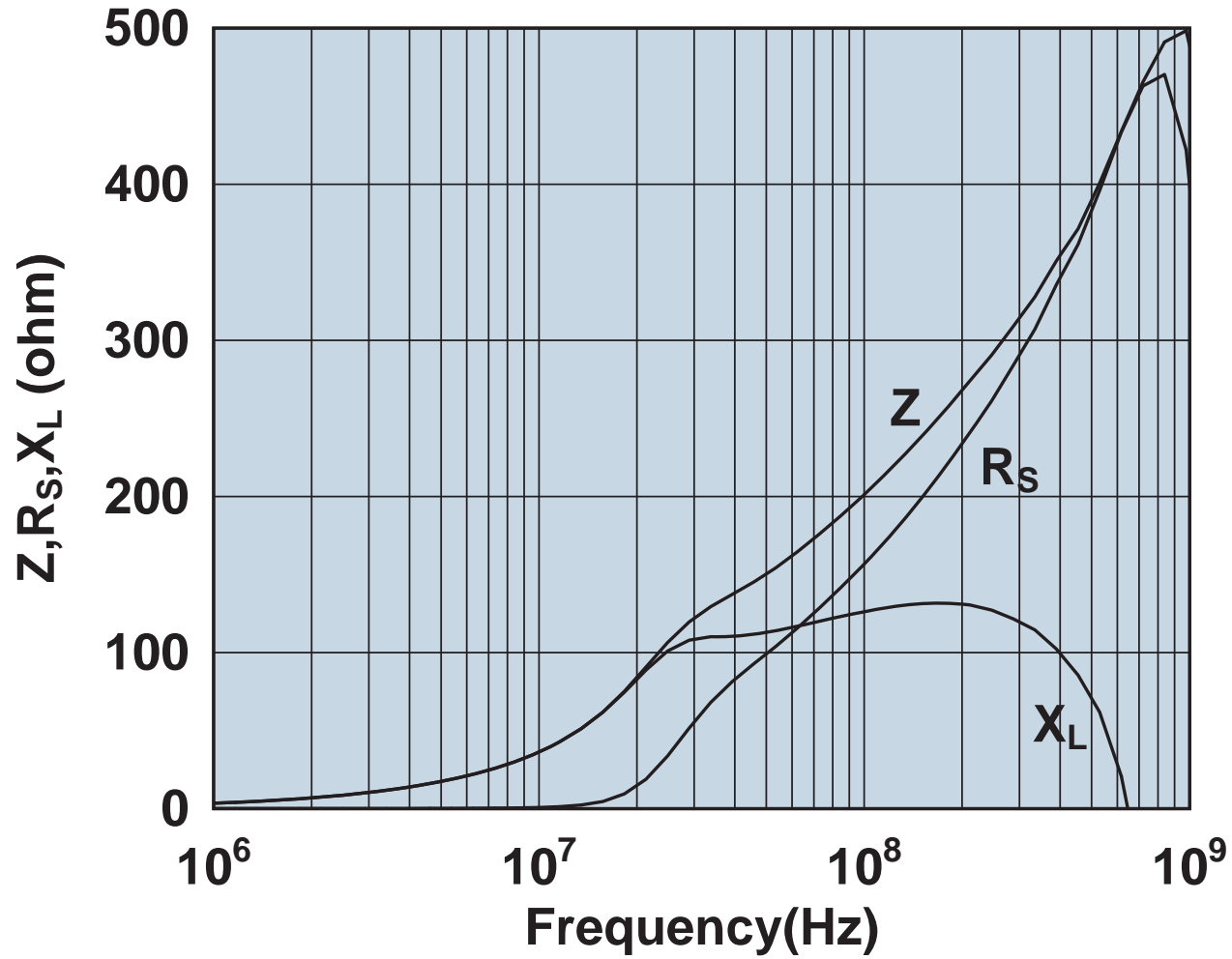

Impedance, reactance, and resistance vs. frequency.

2661665 802

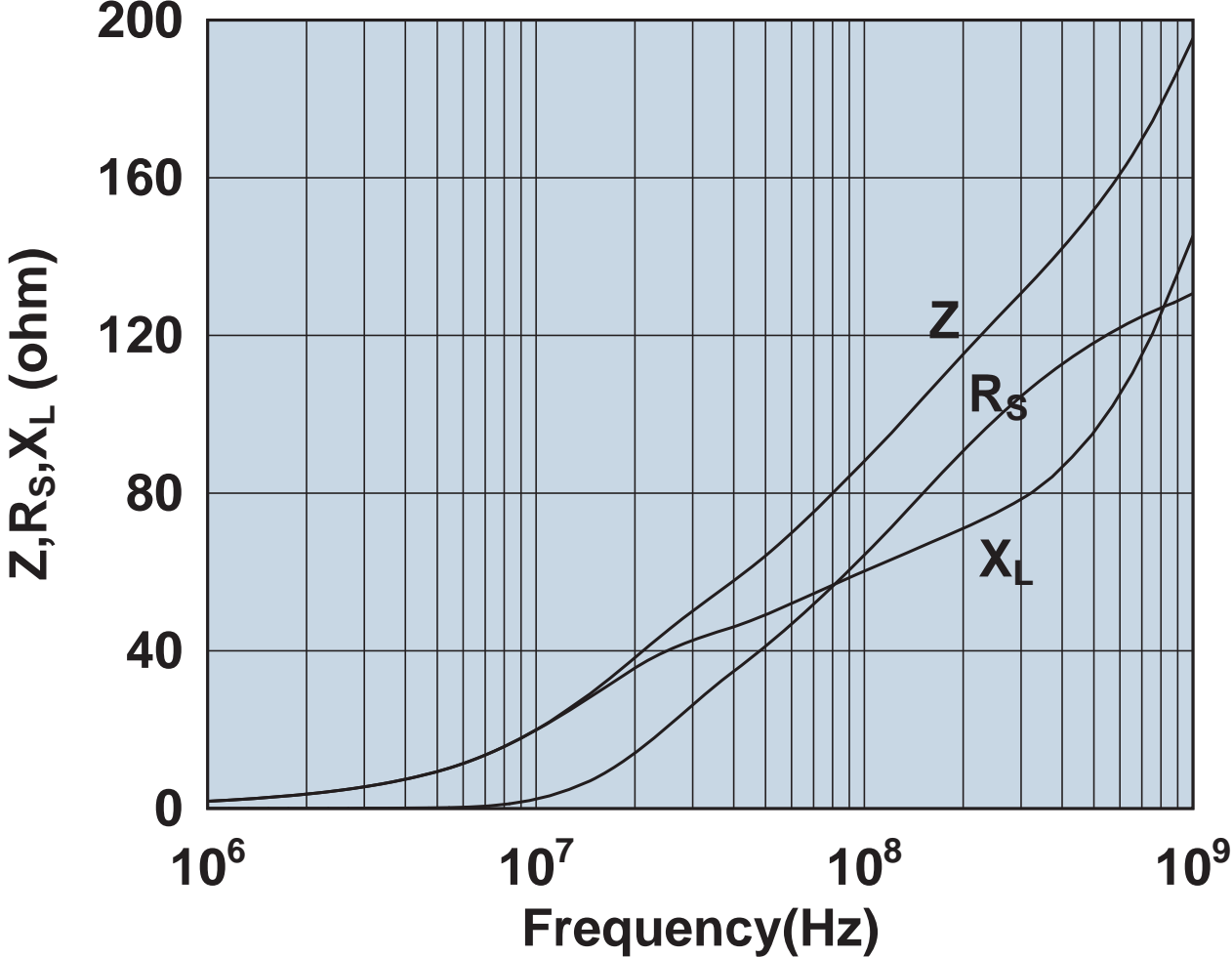

Impedance, reactance, and resistance vs. frequency.

2661801902

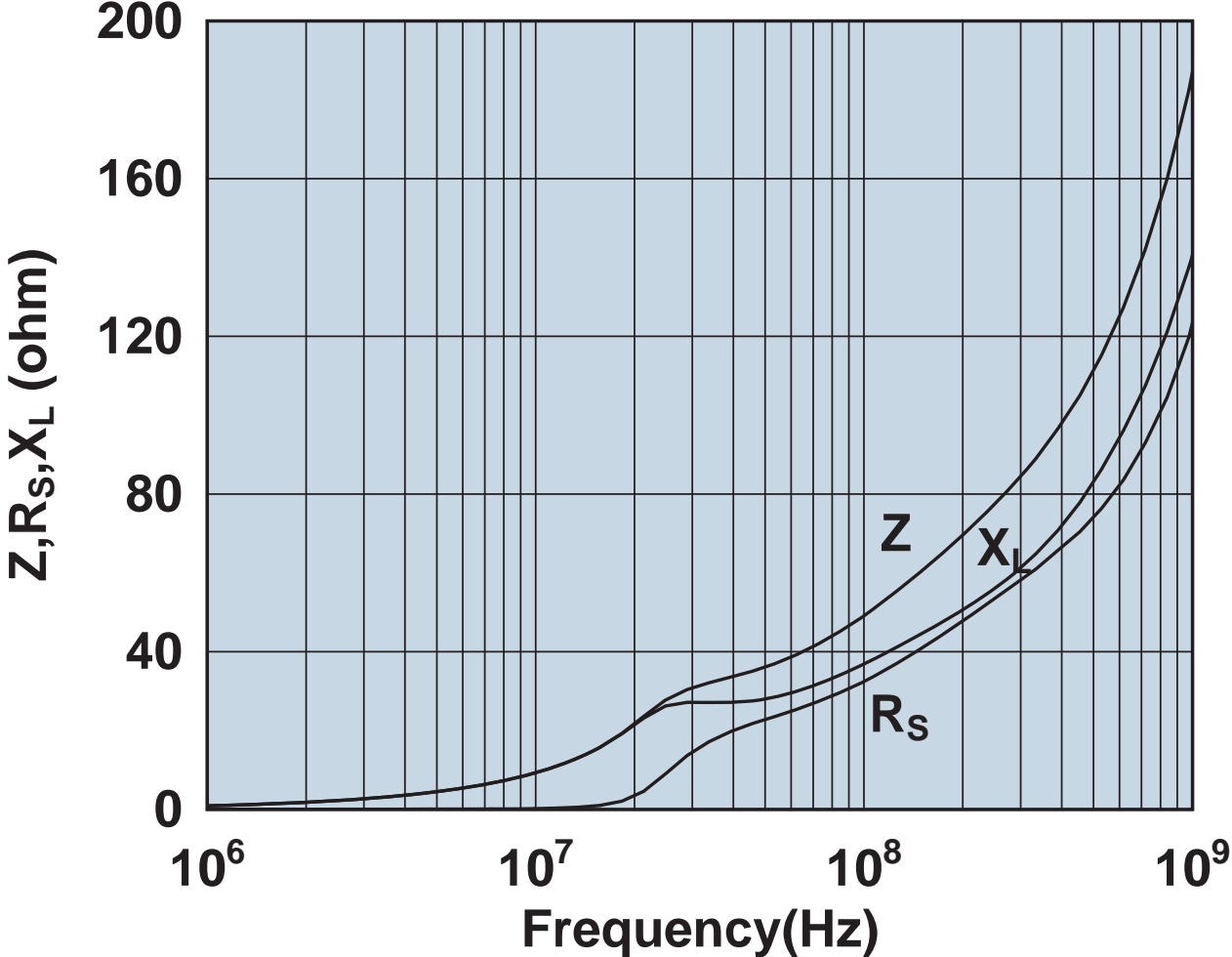

Impedance, reactance, and resistance vs. frequency.

2643101902

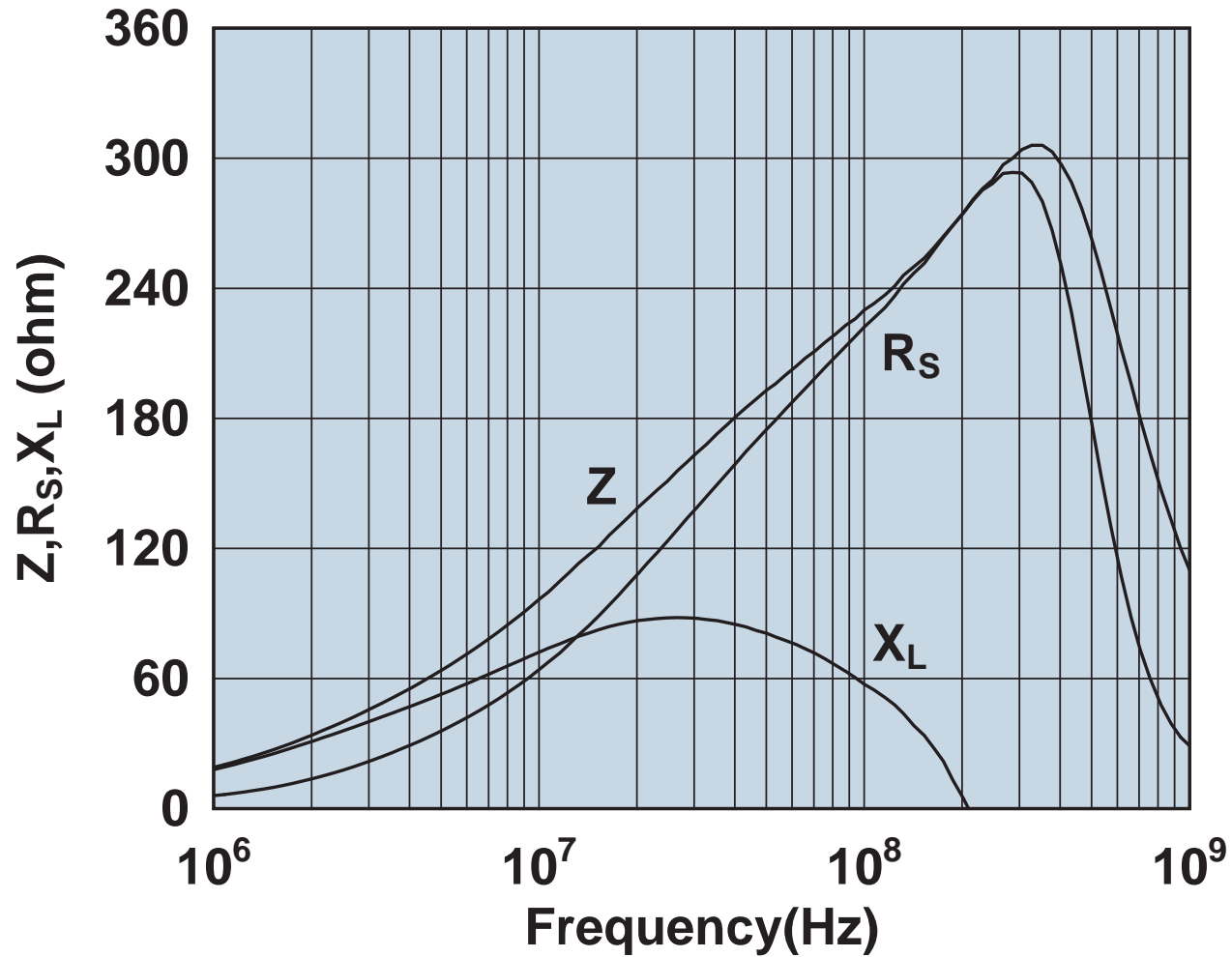

Impedance, reactance, and resistance vs. frequency.



2643023002

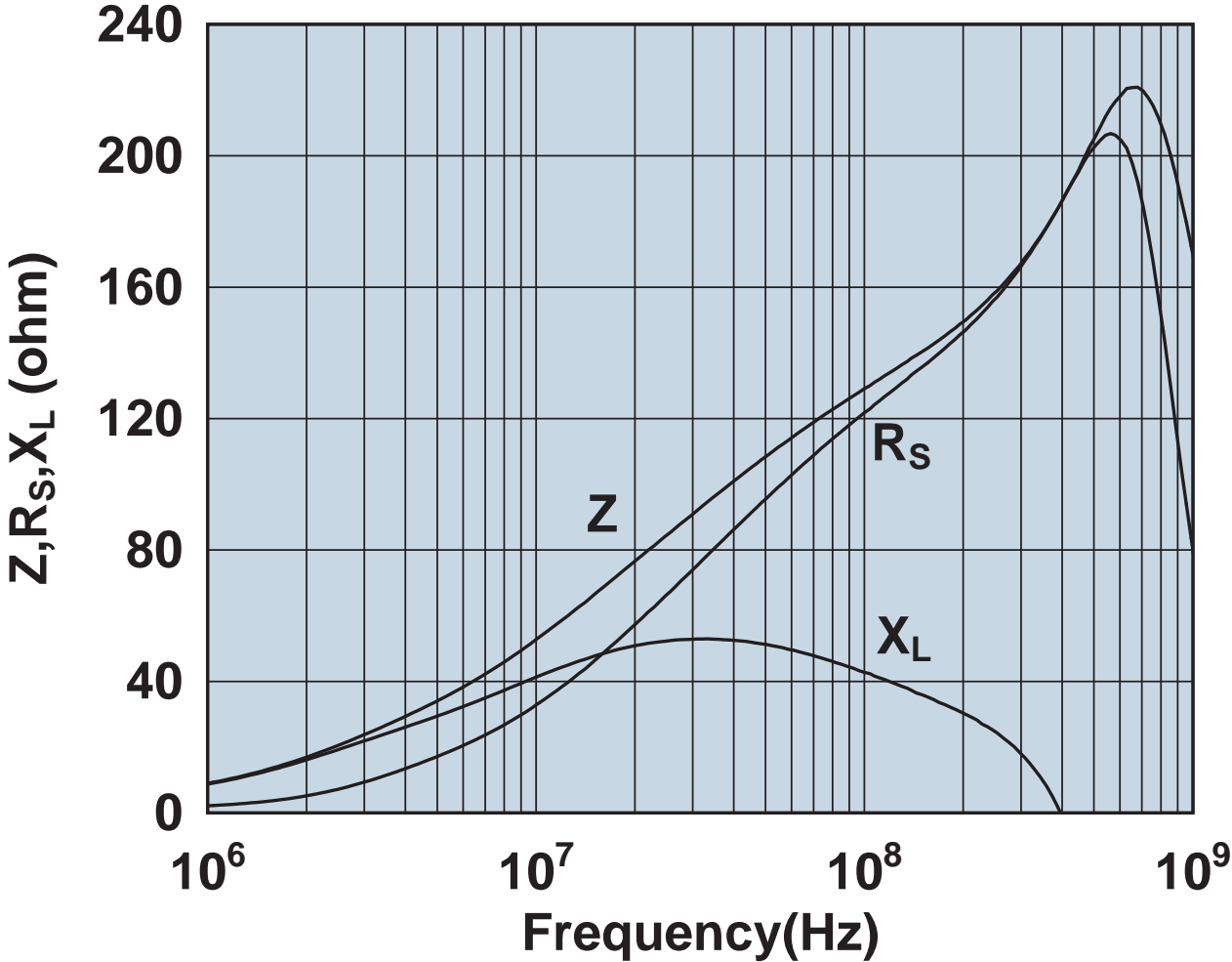

Impedance, reactance, and resistance vs. frequency.

2643000801

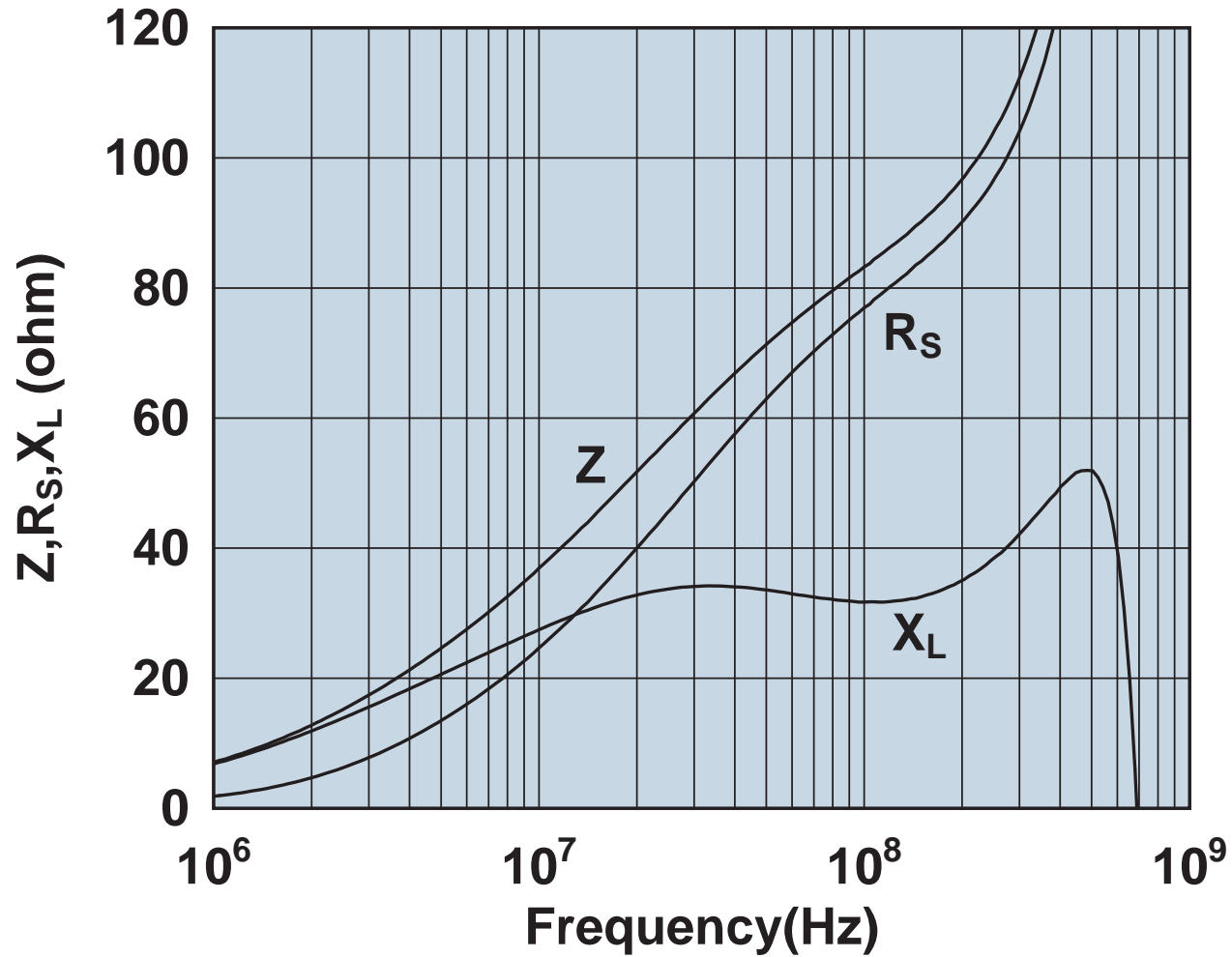

Impedance, reactance, and resistance vs. frequency.

2661480002

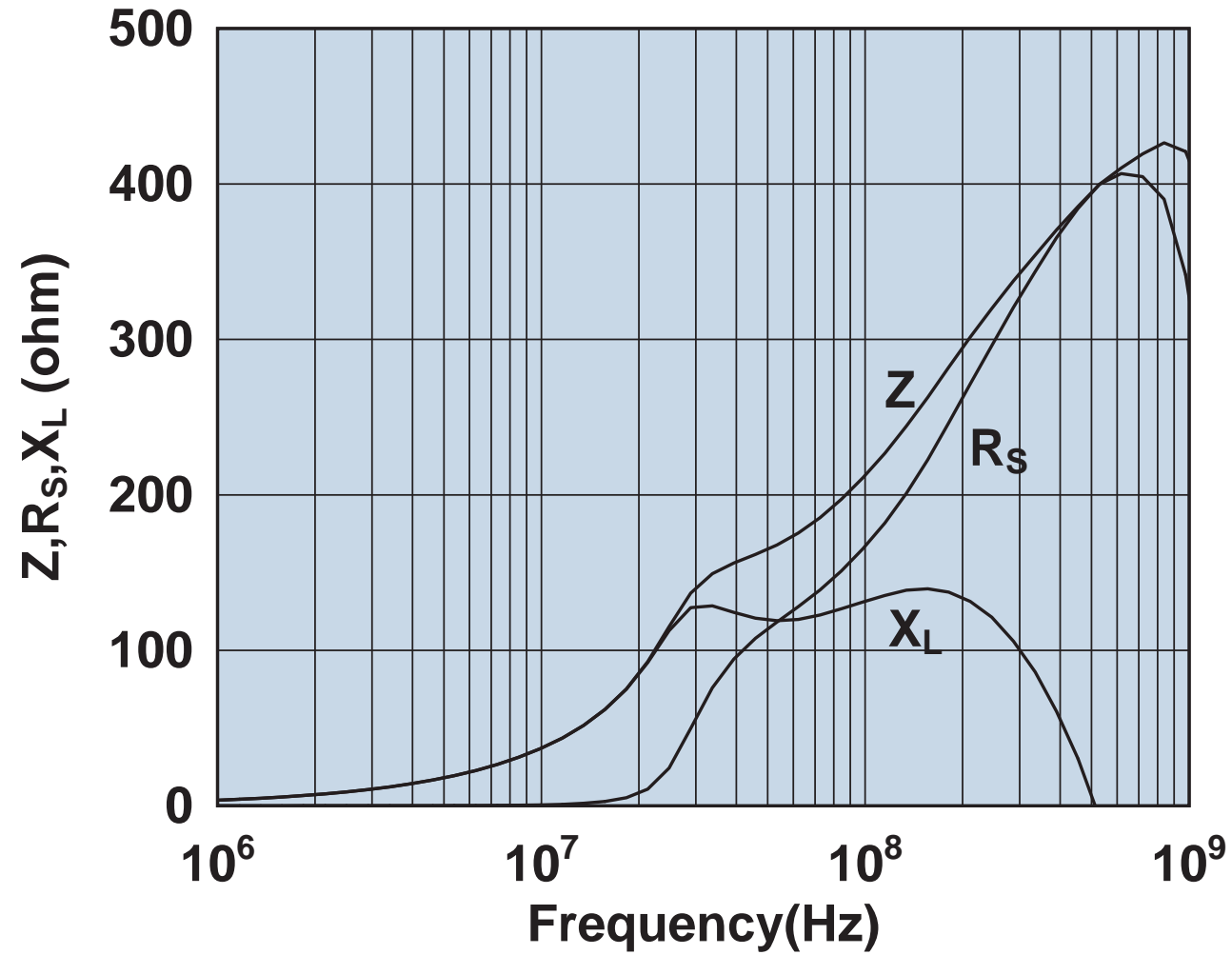

Impedance, reactance, and resistance vs. frequency.

2677006302

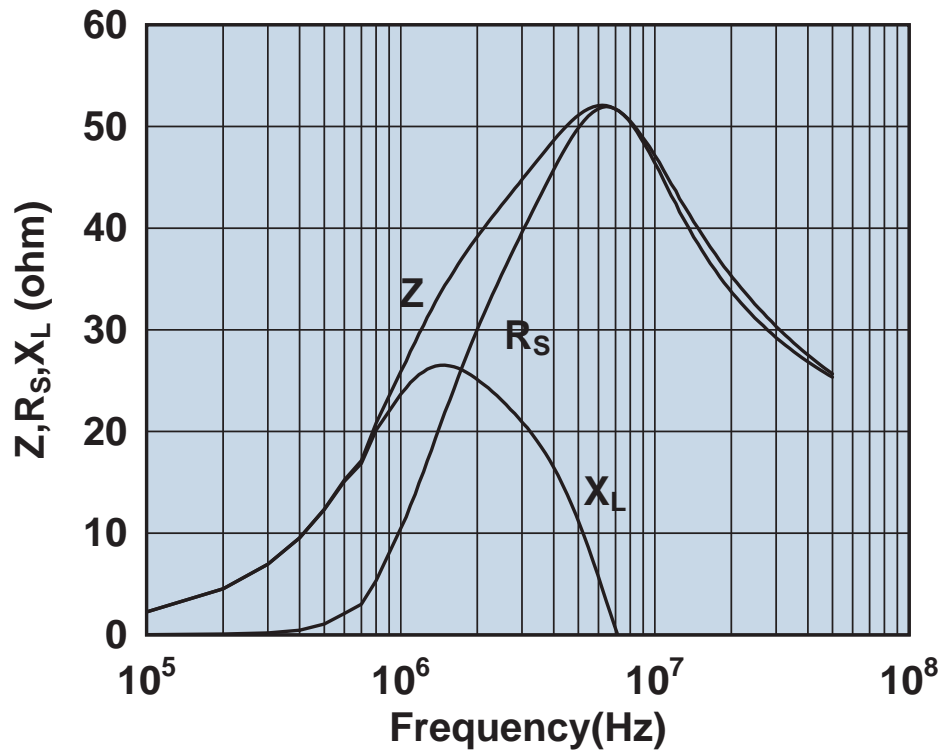

Impedance, reactance, and resistance vs. frequency.

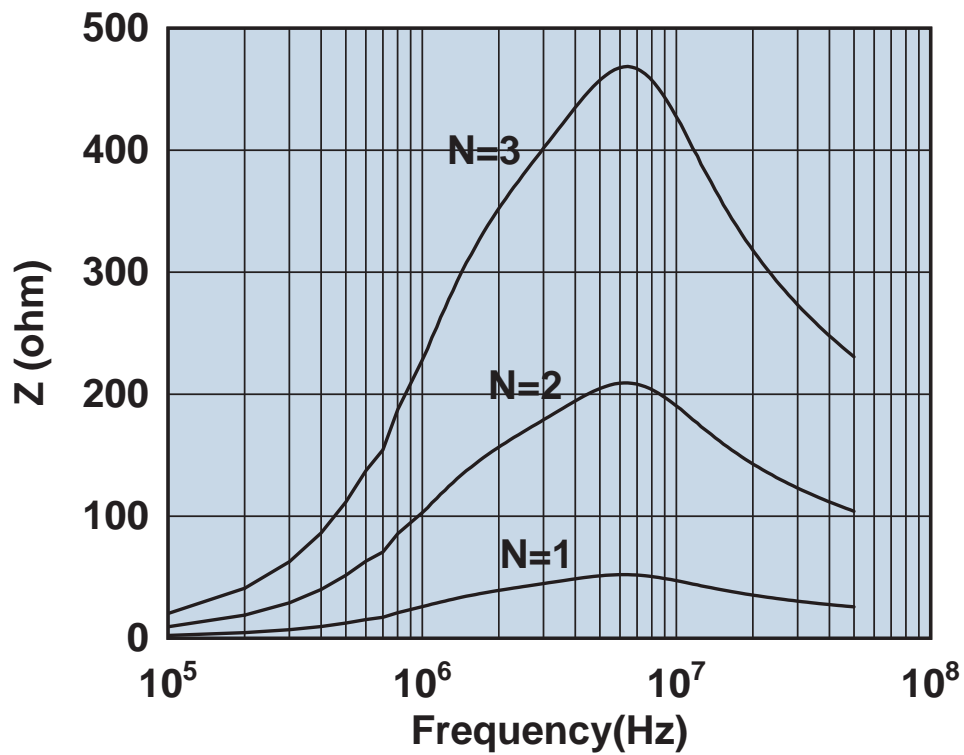

Impedance vs. frequency with one, two, and three turns.

2677102402

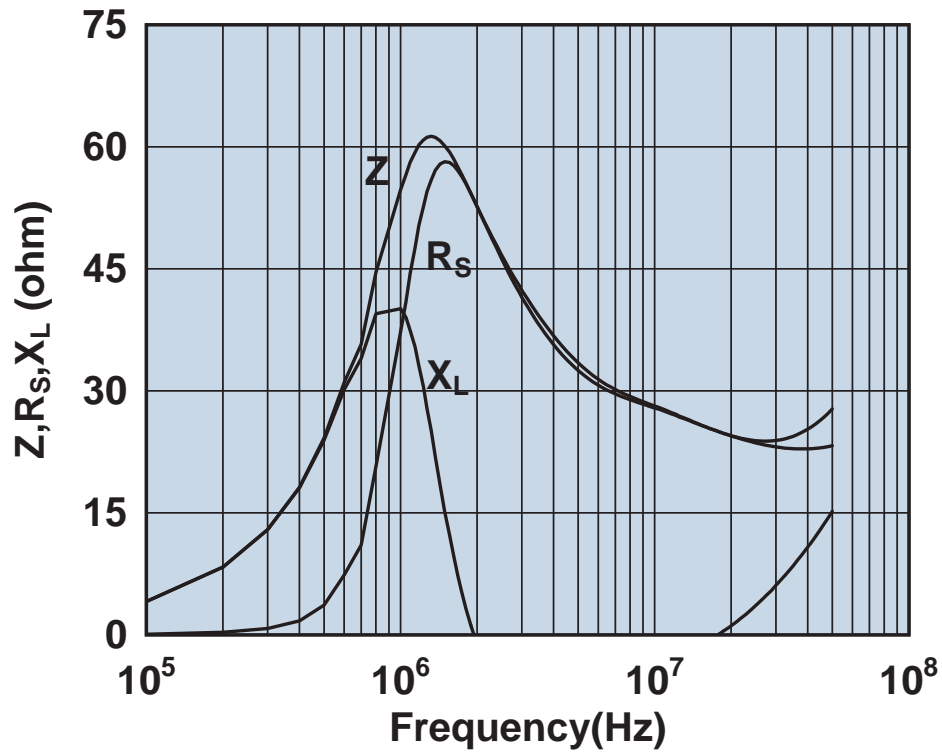

Impedance, reactance, and resistance vs. frequency.

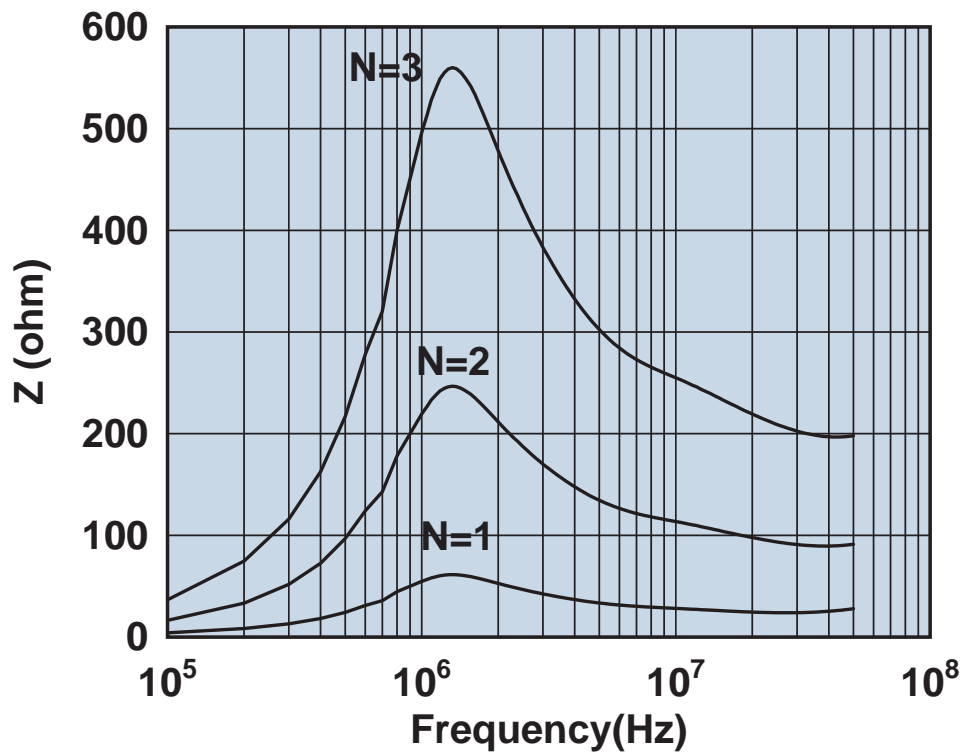

Impedance vs. frequency with one, two, and three turns.

## Данный компонент на территории Российской Федерации

### Вы можете приобрести в компании MosChip.

Для оперативного оформления запроса Вам необходимо перейти по данной ссылке:

<http://moschip.ru/get-element>

Вы можете разместить у нас заказ для любого Вашего проекта, будь то серийное производство или разработка единичного прибора.

В нашем ассортименте представлены ведущие мировые производители активных и пассивных электронных компонентов.

Нашей специализацией является поставка электронной компонентной базы двойного назначения, продукции таких производителей как XILINX, Intel (ex.ALTERA), Vicor, Microchip, Texas Instruments, Analog Devices, Mini-Circuits, Amphenol, Glenair.

Сотрудничество с глобальными дистрибьюторами электронных компонентов, предоставляет возможность заказывать и получать с международных складов практически любой перечень компонентов в оптимальные для Вас сроки.

На всех этапах разработки и производства наши партнеры могут получить квалифицированную поддержку опытных инженеров.

Система менеджмента качества компании отвечает требованиям в соответствии с ГОСТ Р ИСО 9001, ГОСТ РВ 0015-002 и ЭС РД 009

### Офис по работе с юридическими лицами:

105318, г.Москва, ул.Щербаковская д.3, офис 1107, 1118, ДЦ «Щербаковский»

Телефон: +7 495 668-12-70 (многоканальный)

Факс: +7 495 668-12-70 (доб.304)

E-mail: [info@moschip.ru](mailto:info@moschip.ru)

Skype отдела продаж:

moschip.ru

moschip.ru\_4

moschip.ru\_6

moschip.ru\_9