

Ultrabright 0402 ChipLED

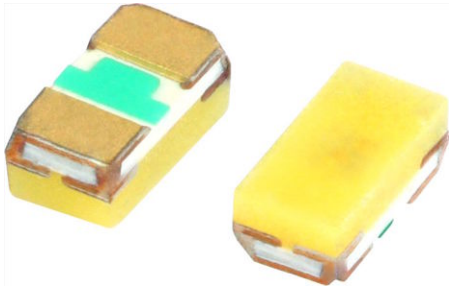

DESCRIPTION

The new 0402 ChipLED series have been designed in the smallest SMD package. This innovative 0402 ChipLED technology opens the way to

- smaller products of higher performance
- more design in flexibility
- enhanced applications

The 0402 LED is an obvious solution for small-scale products that are expected to work reliably in an arduous environment.

This package is filled with a mixture of epoxy and yellow converter.

This yellow converter converts the blue emission partially to yellow, which mixes the remaining blue to give white.

PRODUCT GROUP AND PACKAGE DATA

- Product group: LED
- Package: SMD 0402 ChipLED
- Product series: standard
- Angle of half intensity: $\pm 65^\circ$

FEATURES

- High efficient InGaN technology
- Super thin ChipLED with exceptional brightness 1.0 mm x 0.5 mm x 0.35 mm (L x W x H)
- High reliability PCB based
- Temperature range - 30 °C to + 80 °C
- Chromaticity coordinate categorized according to CIE 1931 per packing unit
- Typical color temperature 7000 K
- EIA standard package
- Compatible to IR reflow soldering
- Available on 7" diameter reel
- Preconditioning: according to JEDEC level 2a
- ESD-sensitive device
- Material categorization: For definitions of compliance please see www.vishay.com/doc?99912



APPLICATIONS

- Telecommunication: Indicator and backlighting in telephone and fax
- Backlighting for audio and video equipment
- Backlighting in office equipment
- Indoor and outdoor message boards
- Flat backlight for LCDs, switches and symbols

PARTS TABLE

PART	COLOR	LUMINOUS INTENSITY (mcd)			at I _F (mA)	COORDINATE (x, y)			FORWARD VOLTAGE (V)			TECHNOLOGY
		MIN.	TYP.	MAX.		MIN.	TYP.	MAX.	MIN.	TYP.	MAX.	
VLMW1500-GS08	White	45	-	180	5	-	0.294, 0.286	-	2.55	-	3.15	InGaN/ yellow converter

ABSOLUTE MAXIMUM RATINGS (T_{amb} = 25 °C, unless otherwise specified) VLMW1500

PARAMETER	TEST CONDITION	SYMBOL	VALUE	UNIT
DC forward current	T _{amb} ≤ 25 °C	I _F	20	mA
Surge forward current	t _p ≤ 10 μs	I _{FSM}	0.1	A
Power dissipation		P _V	70	mW
Operating temperature range		T _{amb}	- 30 to + 80	°C
Storage temperature range		T _{stg}	- 55 to + 105	°C
Thermal resistance junction/ambient		R _{thJA}	550	K/W

**OPTICAL AND ELECTRICAL CHARACTERISTICS** ($T_{amb} = 25\text{ }^{\circ}\text{C}$, unless otherwise specified)
VLMW1500, WHITE

PARAMETER	TEST CONDITION	SYMBOL	MIN.	TYP.	MAX.	UNIT
Luminous intensity	$I_F = 5\text{ mA}$	I_V	45	-	180	mcd
Chromatically coordinate x acc. to CIE 1931	$I_F = 5\text{ mA}$	x	-	0.294	-	
Chromatically coordinate y acc. to CIE 1931	$I_F = 5\text{ mA}$	y	-	0.286	-	
Angle of half intensity	$I_F = 5\text{ mA}$	ϕ	-	± 65	-	deg
Forward voltage	$I_F = 5\text{ mA}$	V_F	2.55	-	3.15	V
Reverse current ⁽¹⁾	$V_R = 5\text{ V}$	I_R	-	10	-	μA

Note

(1) Driving the LED in reverse direction is suitable for short term application

LUMINOUS INTENSITY CLASSIFICATION

GROUP	LUMINOUS INTENSITY (mcd) at 5 mA	
	MIN.	MAX.
P	45	71
Q	71	112
R	112	180

Note

- Luminous intensity is tested at a current pulse duration of 25 ms and an accuracy of $\pm 15\%$.
The above type numbers represent the order groups which include only a few brightness groups. Only one group will be shipped on each reel (there will be no mixing of two groups on each reel). In order to ensure availability, single brightness groups will not be orderable.
In a similar manner for colors where wavelength groups are measured and binned, single wavelength groups will be shipped in any one reel.
In order to ensure availability, single wavelength groups will not be orderable.

FORWARD VOLTAGE CLASSIFICATION

GROUP	FORWARD VOLTAGE (V)	
	MIN.	MAX.
V1	2.55	2.65
V2	2.65	2.75
V3	2.75	2.85
V4	2.85	2.95
V5	2.95	3.05
V6	3.05	3.15

Note

- Forward voltage is measured with a tolerance of $\pm 0.1\text{ V}$.

CHROMATICITY COORDINATED GROUPS FOR WHITE SMD LED

	X	Y		X	Y
S1	0.274	0.226	S4	0.294	0.286
	0.274	0.258		0.294	0.319
	0.294	0.286		0.314	0.347
	0.294	0.254		0.314	0.315
S2	0.274	0.258	S5	0.314	0.282
	0.274	0.291		0.314	0.315
	0.294	0.319		0.334	0.343
	0.294	0.286		0.334	0.311
S3	0.294	0.254	S6	0.314	0.315
	0.294	0.286		0.314	0.347
	0.314	0.315		0.334	0.376
	0.314	0.282		0.334	0.343

Note

- Chromaticity coordinate groups are tested at a current pulse duration of 25 ms and a tolerance of ± 0.01 .

TYPICAL CHARACTERISTICS ($T_{amb} = 25\text{ }^{\circ}\text{C}$, unless otherwise specified)

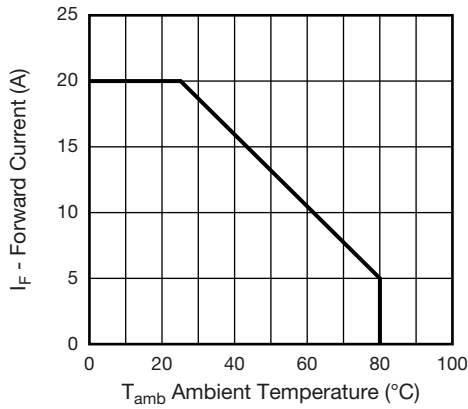

Fig. 1 - Forward Current vs. Ambient Temperature

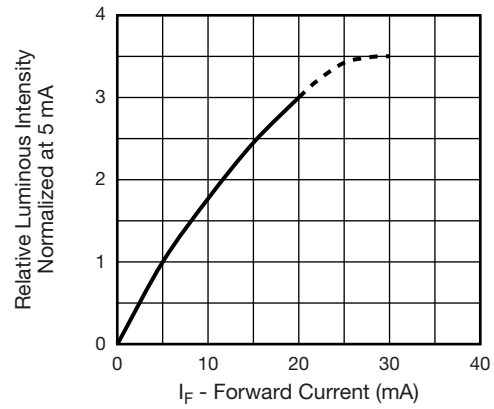

Fig. 4 - Relative Luminous Intensity vs. Forward Current

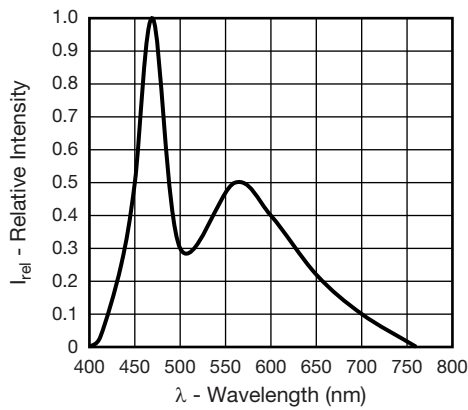

Fig. 2 - Relative Intensity vs. Wavelength

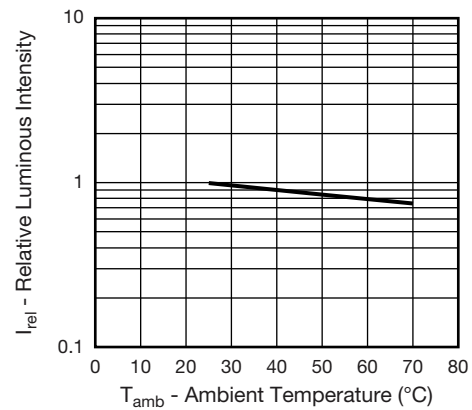

Fig. 5 - Relative Luminous Intensity vs. Ambient Temperature

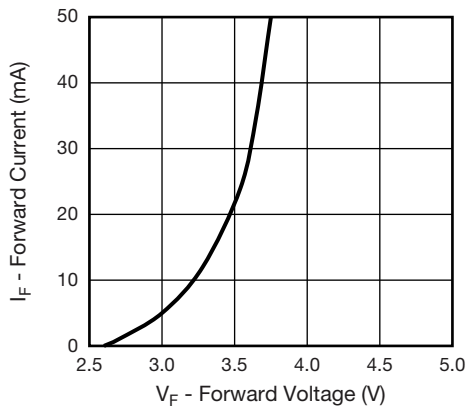

Fig. 3 - Forward Current vs. Forward Voltage

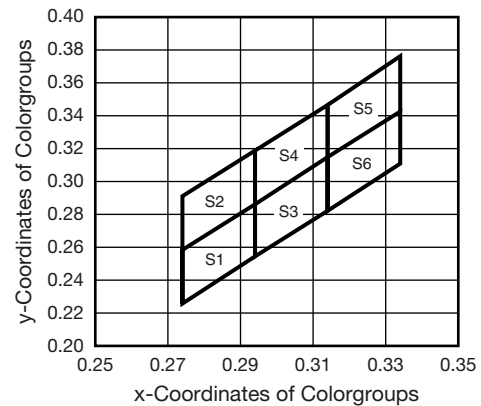

Fig. 6 - Coordinates of Colorgroups

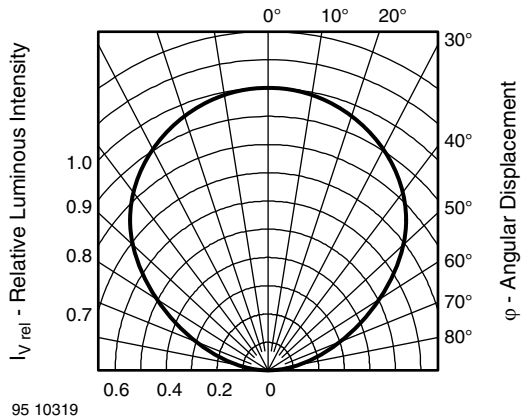
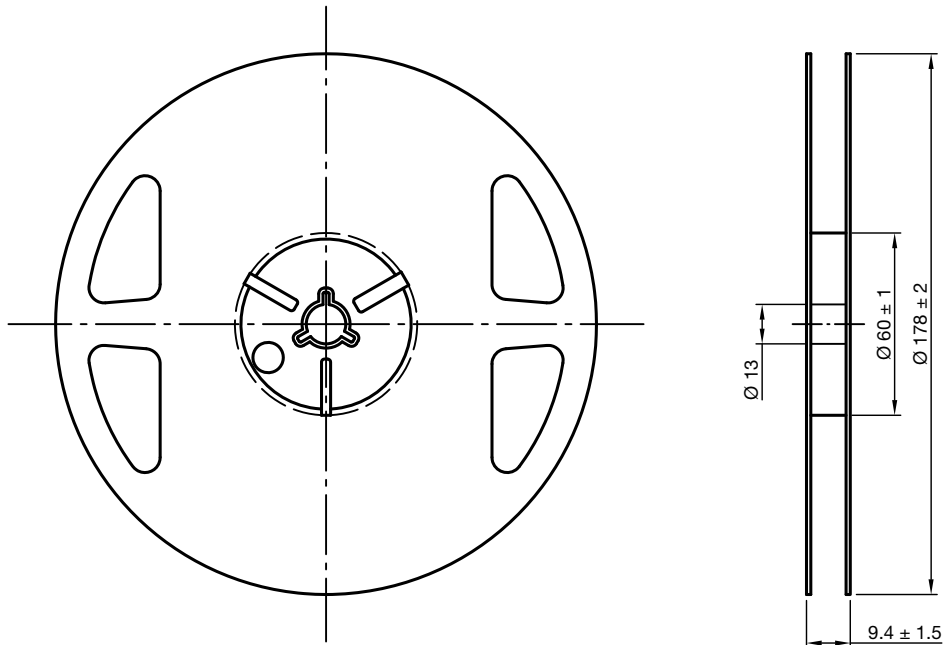
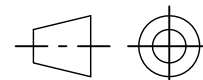

Fig. 7 - Relative Luminous Intensity vs. Angular Displacement

REEL DIMENSIONS in millimeters



Drawing-No.: 9.800-5122.01-4
 Issue: 2; 03.11.11
 22611



technical drawings
 according to DIN
 specifications

TAPE DIMENSIONS in millimeters

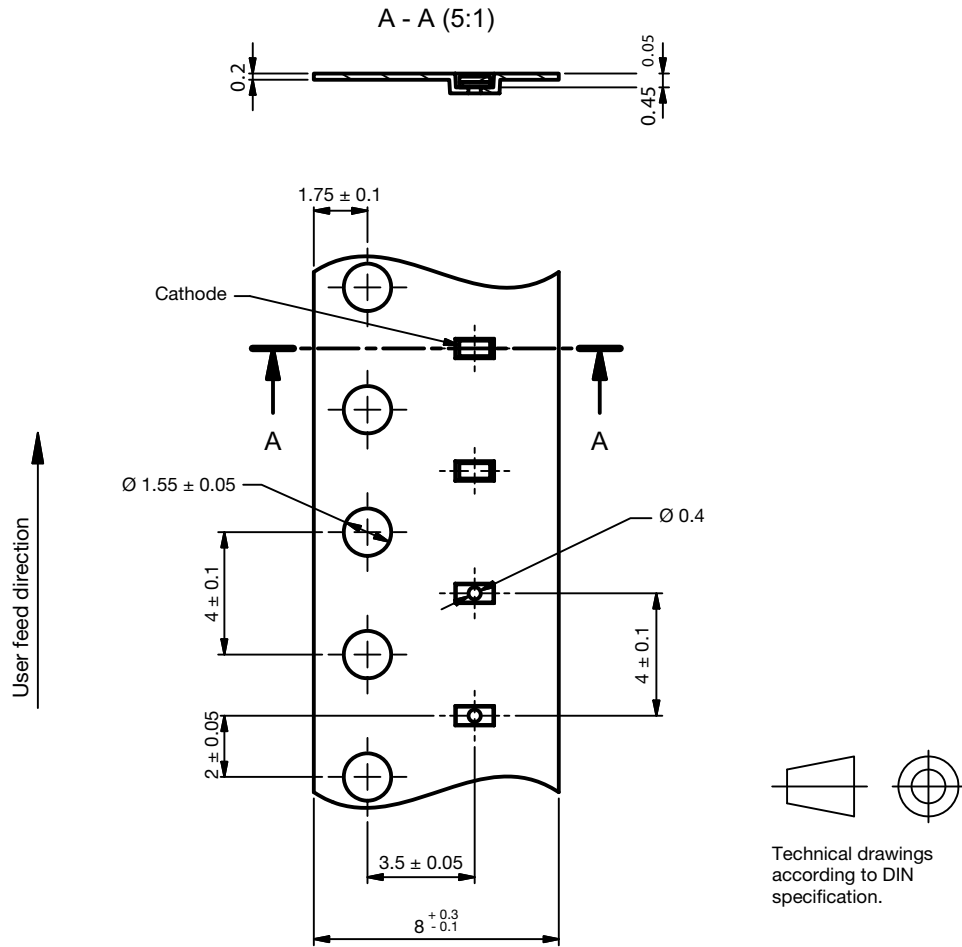

Drawing-No.: 9.700-5388.01-4
 Issue: 1; 20.03.12

PACKAGE DIMENSIONS in millimeters

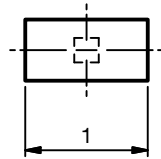
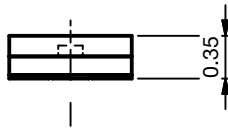
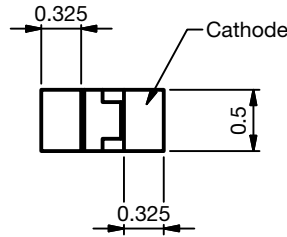

Recommended solder pad footprint

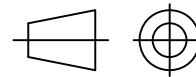
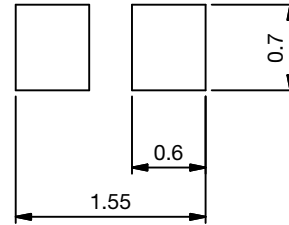

Technical drawings according to DIN specification

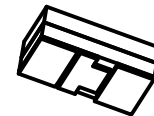

Not indicated tolerances ± 0.2

Drawing-No.: 6.541-5096.01-4
Issue: 1; 20.03.12

SOLDERING PROFILE

IR Reflow Soldering Profile for lead (Pb)-free Soldering
Preconditioning acc. to JEDEC Level 2

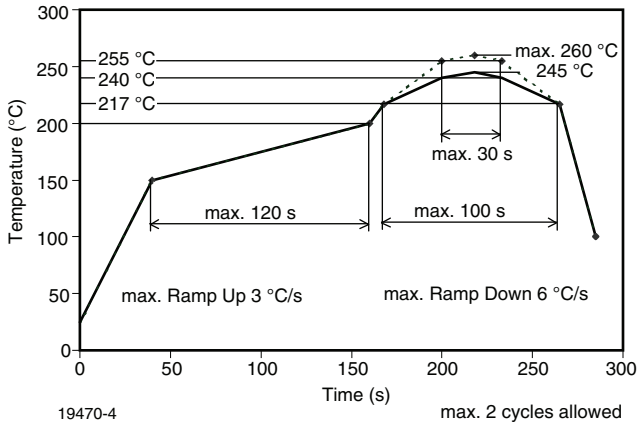
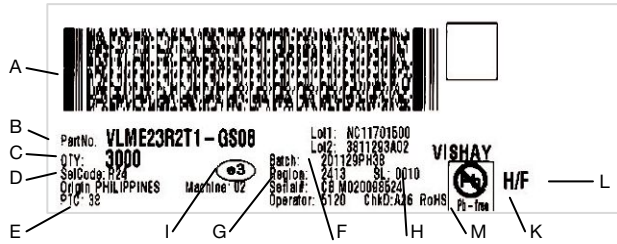

Fig. 8 - Vishay Lead (Pb)-free Reflow Soldering Profile (according to J-STD-020C)

BAR CODE PRODUCT LABEL (example)



- A) 2D barcode
- B) PartNo = Vishay part number
- C) QTY = quantity
- D) SelCode = selection code (binning)
- E) PTC = code of manufacturing plant
- F) Batch = date code: year/week/plant code
- G) Region code
- H) SL = sales location
- I) Terminations finishing
- J) Lead (Pb)-free symbol
- K) Halogen-free symbol
- L) RoHS symbol

DRY PACKING

The reel is packed in an anti-humidity bag to protect the devices from absorbing moisture during transportation and storage.

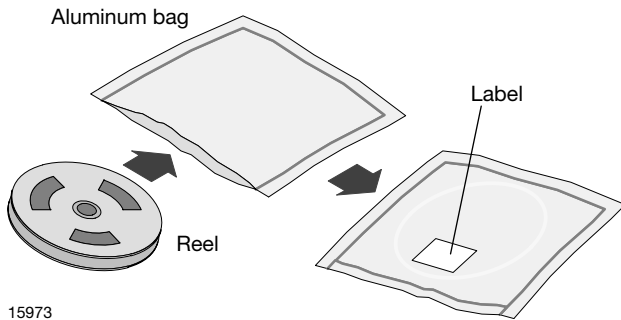

FINAL PACKING

The sealed reel is packed into a cardboard box. A secondary cardboard box is used for shipping purposes.

RECOMMENDED METHOD OF STORAGE

Dry box storage is recommended as soon as the aluminum bag has been opened to prevent moisture absorption. The following conditions should be observed, if dry boxes are not available:

- Storage temperature 10 °C to 30 °C
- Storage humidity ≤ 60 % RH max.

After more than 672 h under these conditions moisture content will be too high for reflow soldering.

In case of moisture absorption, the devices will recover to the former condition by drying under the following condition:
 192 h at 40 °C + 5 °C/- 0 °C and < 5 % RH (dry air/nitrogen) or
 96 h at 60 °C + 5 °C and < 5 % RH for all device containers or
 24 h at 100 °C + 5 °C not suitable for reel or tubes.

An EIA JEDEC Standard JESD22-A112 Level 2a label is included on all dry bags.

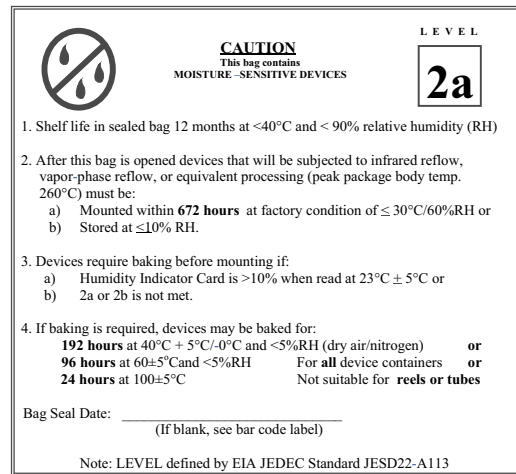

Example of JESD22-A112 Level 2a Label

ESD PRECAUTION

Proper storage and handling procedures should be followed to prevent ESD damage to the devices especially when they are removed from the antistatic shielding bag. Electro-static sensitive devices warning labels are on the packaging.

VISHAY SEMICONDUCTORS STANDARD BAR CODE LABELS

The Vishay Semiconductors standard bar code labels are printed at final packing areas. The labels are on each packing unit and contain Vishay Semiconductors specific data.



Disclaimer

ALL PRODUCT, PRODUCT SPECIFICATIONS AND DATA ARE SUBJECT TO CHANGE WITHOUT NOTICE TO IMPROVE RELIABILITY, FUNCTION OR DESIGN OR OTHERWISE.

Vishay Intertechnology, Inc., its affiliates, agents, and employees, and all persons acting on its or their behalf (collectively, "Vishay"), disclaim any and all liability for any errors, inaccuracies or incompleteness contained in any datasheet or in any other disclosure relating to any product.

Vishay makes no warranty, representation or guarantee regarding the suitability of the products for any particular purpose or the continuing production of any product. To the maximum extent permitted by applicable law, Vishay disclaims (i) any and all liability arising out of the application or use of any product, (ii) any and all liability, including without limitation special, consequential or incidental damages, and (iii) any and all implied warranties, including warranties of fitness for particular purpose, non-infringement and merchantability.

Statements regarding the suitability of products for certain types of applications are based on Vishay's knowledge of typical requirements that are often placed on Vishay products in generic applications. Such statements are not binding statements about the suitability of products for a particular application. It is the customer's responsibility to validate that a particular product with the properties described in the product specification is suitable for use in a particular application. Parameters provided in datasheets and/or specifications may vary in different applications and performance may vary over time. All operating parameters, including typical parameters, must be validated for each customer application by the customer's technical experts. Product specifications do not expand or otherwise modify Vishay's terms and conditions of purchase, including but not limited to the warranty expressed therein.

Except as expressly indicated in writing, Vishay products are not designed for use in medical, life-saving, or life-sustaining applications or for any other application in which the failure of the Vishay product could result in personal injury or death. Customers using or selling Vishay products not expressly indicated for use in such applications do so at their own risk. Please contact authorized Vishay personnel to obtain written terms and conditions regarding products designed for such applications.

No license, express or implied, by estoppel or otherwise, to any intellectual property rights is granted by this document or by any conduct of Vishay. Product names and markings noted herein may be trademarks of their respective owners.

Material Category Policy

Vishay Intertechnology, Inc. hereby certifies that all its products that are identified as RoHS-Compliant fulfill the definitions and restrictions defined under Directive 2011/65/EU of The European Parliament and of the Council of June 8, 2011 on the restriction of the use of certain hazardous substances in electrical and electronic equipment (EEE) - recast, unless otherwise specified as non-compliant.

Please note that some Vishay documentation may still make reference to RoHS Directive 2002/95/EC. We confirm that all the products identified as being compliant to Directive 2002/95/EC conform to Directive 2011/65/EU.

Vishay Intertechnology, Inc. hereby certifies that all its products that are identified as Halogen-Free follow Halogen-Free requirements as per JEDEC JS709A standards. Please note that some Vishay documentation may still make reference to the IEC 61249-2-21 definition. We confirm that all the products identified as being compliant to IEC 61249-2-21 conform to JEDEC JS709A standards.

Данный компонент на территории Российской Федерации

Вы можете приобрести в компании MosChip.

Для оперативного оформления запроса Вам необходимо перейти по данной ссылке:

<http://moschip.ru/get-element>

Вы можете разместить у нас заказ для любого Вашего проекта, будь то серийное производство или разработка единичного прибора.

В нашем ассортименте представлены ведущие мировые производители активных и пассивных электронных компонентов.

Нашей специализацией является поставка электронной компонентной базы двойного назначения, продукции таких производителей как XILINX, Intel (ex.ALTERA), Vicor, Microchip, Texas Instruments, Analog Devices, Mini-Circuits, Amphenol, Glenair.

Сотрудничество с глобальными дистрибьюторами электронных компонентов, предоставляет возможность заказывать и получать с международных складов практически любой перечень компонентов в оптимальные для Вас сроки.

На всех этапах разработки и производства наши партнеры могут получить квалифицированную поддержку опытных инженеров.

Система менеджмента качества компании отвечает требованиям в соответствии с ГОСТ Р ИСО 9001, ГОСТ РВ 0015-002 и ЭС РД 009

Офис по работе с юридическими лицами:

105318, г.Москва, ул.Щербаковская д.3, офис 1107, 1118, ДЦ «Щербаковский»

Телефон: +7 495 668-12-70 (многоканальный)

Факс: +7 495 668-12-70 (доб.304)

E-mail: info@moschip.ru

Skype отдела продаж:

moschip.ru

moschip.ru_4

moschip.ru_6

moschip.ru_9