



SERIES 500 SWITCHES

SLIDE SWITCHES

TACT SWITCHES

NAVIGATION SWITCHES

PUSHBUTTON SWITCHES

TOGGLE SWITCHES

ROCKER SWITCHES

SLIDE SWITCHES

SNAP-ACTION SWITCHES

DIP SWITCHES

KEYLOCK SWITCHES

ROTARY SWITCHES

DETECTOR SWITCHES

CAP OPTIONS

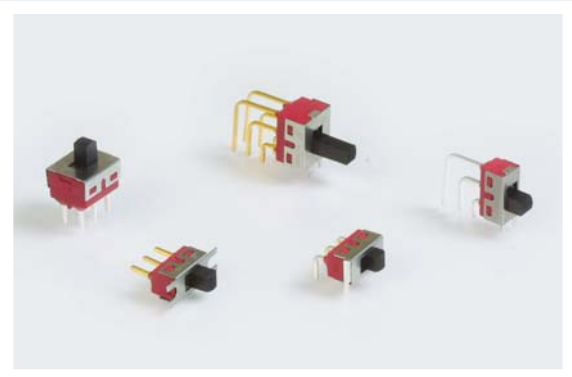

SPECIFICATIONS

Contact Rating:	Gold, 0.4 VA @ 20 VAC or DC Silver, 5A @ 120 VAC, 2A @ 250 VAC
Life Expectancy:	50,000 make-and-break cycles at full load
Contact Resistance:	10 mΩ max. typical @ 2-4 VDC 100mA for both silver and gold plated contacts
Insulation Resistance:	1,000 MΩ min.
Dielectric Strength:	1,000 V rms at sea level
Operating Temperature:	-30°C to 85°C

FEATURES & BENEFITS

- ▶ Single & double pole options
- ▶ Multiple actuator height options
- ▶ Panel & PC board mountable

APPLICATIONS/MARKETS

- ▶ Computer servers/peripherals
- ▶ Consumer electronics
- ▶ Instrumentation
- ▶ Test & measurement

MATERIALS

Case:	Diallyl phthalate (DAP), UL 94V0
Housing:	Stainless steel
Slide Handle:	Nylon UL 94HB
Contacts:	Silver or gold plated copper alloy

HOW TO ORDER

SERIES	MODEL NO.	ACTUATOR	TERMINATION	CONTACT MATERIAL	SEAL	MOUNTING TAB
500	SSP1 SSP2 SSP3	S1 S2 S3 S4	M1 M2 M3 M5-1 M5-2 M5-3 M5-4 M6 M7 VS2	Q = Silver R = Gold	E = Epoxy Sealed	A = Without Tabs B = With Tabs

▶ ▶ ▶ **Example Ordering Number**
500-SSP2-S4-M1-Q-E-B

SDP1 SDP3	S1 S2 S3 S4 S5	M1 M2 M3 M5-1 M5-2 M5-3 M5-4 M6 M7 VS2	Q = Silver R = Gold	E = Epoxy Sealed	A = Without Tabs B = With Tabs
--------------	----------------------------	---	------------------------	------------------	-----------------------------------

▶ ▶ ▶ **Example Ordering Number**
500-SDP1-S1-M6-R-E-A

Specifications subject to change without notice.



SPDT



2 Comm.
1 3

SCHEMATIC

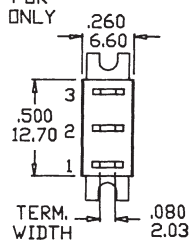
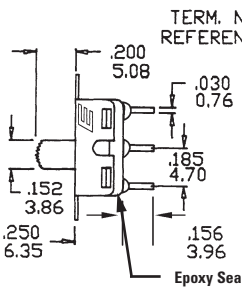
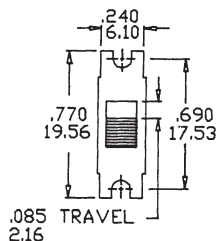

TERM. NOS. FOR REFERENCE ONLY

Model No.	POS 1	POS 2	POS 3
SSP-1	ON	NONE	ON
SSP-2	ON	NONE	(ON)
SSP-3	ON	OFF	ON
Term. Comm.	2-1	OPEN	2-3

() = Momentary

DPDT



2 Comm. 5 Comm.
1 3 4 6

SCHEMATIC

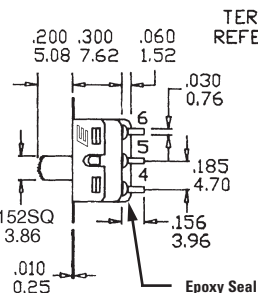
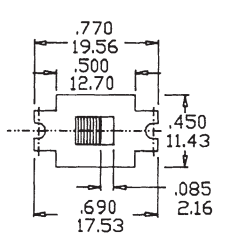

TERM. NOS. FOR REFERENCE ONLY

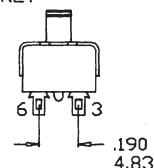

Model No.	POS 1	POS 2	POS 3
SDP-1	ON	NONE	ON
SDP-3	ON	OFF	ON
Term. Comm.	2-1, 5-4	OPEN	2-3, 5-6

ACTUATOR OPTIONS

S1 STD†

† Standard for all DPDT versions.

S2

S3

S4

S5

* Subtract 0.012 (0.301) from actuator height for M6, M7 PC mounting options.

TERMINATION OPTIONS

M1 SOLDER LUG

0.030 (0.76) THK

M2 P.C. MOUNT

0.030 (0.76) THK

M3 QUICK CONNECT

0.030 (0.76) THK
MATING QUICK CONNECTOR
AMP P/N 60900-1

M5 WIRE WRAP

Option Code	Dim. 'A'
M51	.736 (18.70)
M52	.953 (24.20)
M53	.415 (10.55)
M54	1.062 (26.97)



SERIES 500 SWITCHES

SLIDE SWITCHES

TACT SWITCHES

NAVIGATION SWITCHES

PUSHBUTTON SWITCHES

TOGGLE SWITCHES

ROCKER SWITCHES

SLIDE SWITCHES

SNAP-ACTION SWITCHES

DIP SWITCHES

KEYLOCK SWITCHES

ROTARY SWITCHES

DETECTOR SWITCHES

CAP OPTIONS

M6

SPDT

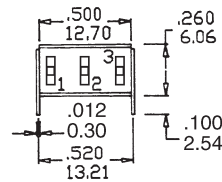
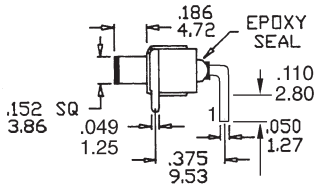
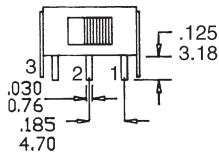

TERM. NOS. FOR REFERENCE ONLY

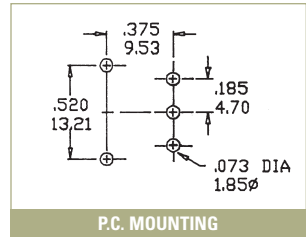

P.C. MOUNTING

M6

DPDT

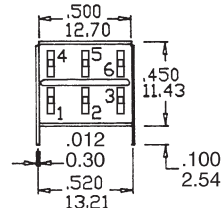
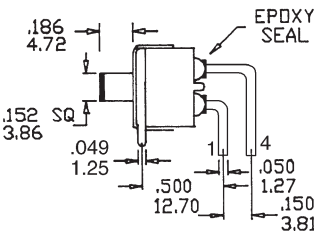
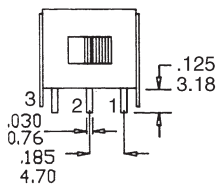

TERM. NOS. FOR REFERENCE ONLY

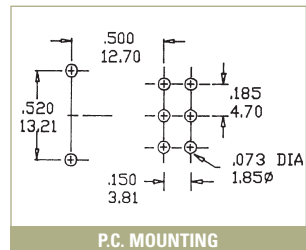

P.C. MOUNTING

M7

SPDT

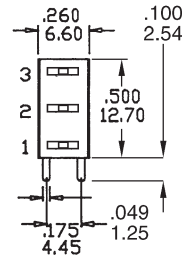
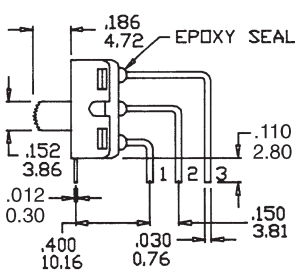
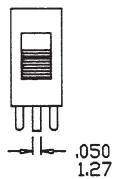

TERM. NOS. FOR REFERENCE ONLY

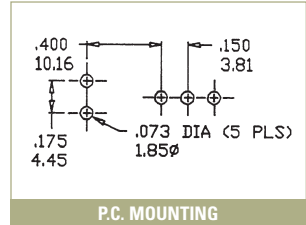

P.C. MOUNTING

M7

DPDT

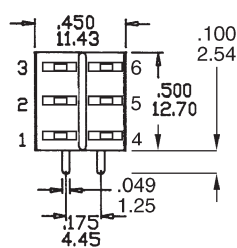
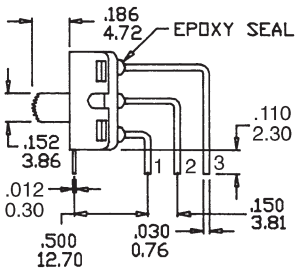
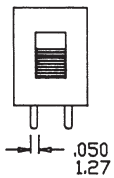

TERM. NOS. FOR REFERENCE ONLY

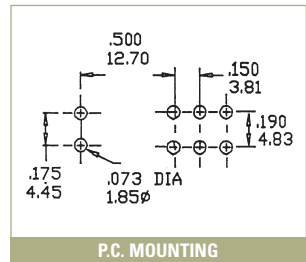

P.C. MOUNTING

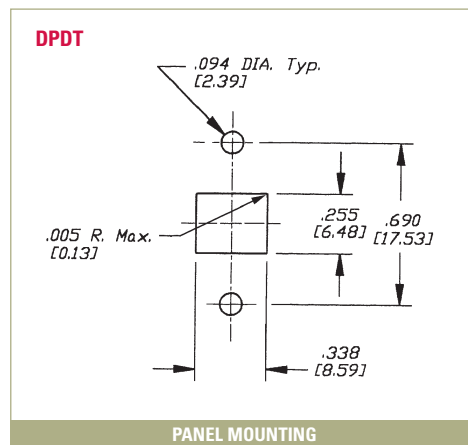
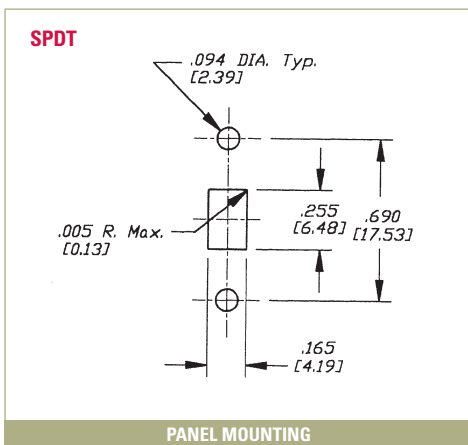

MOUNTING TABS

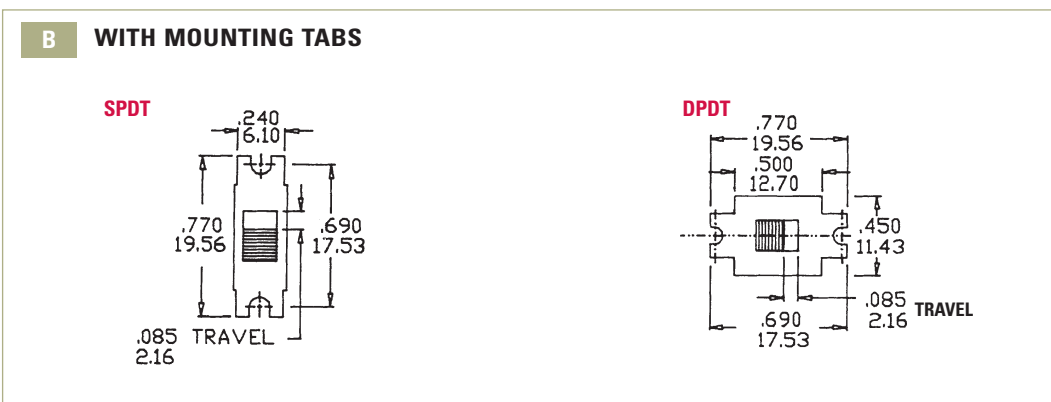
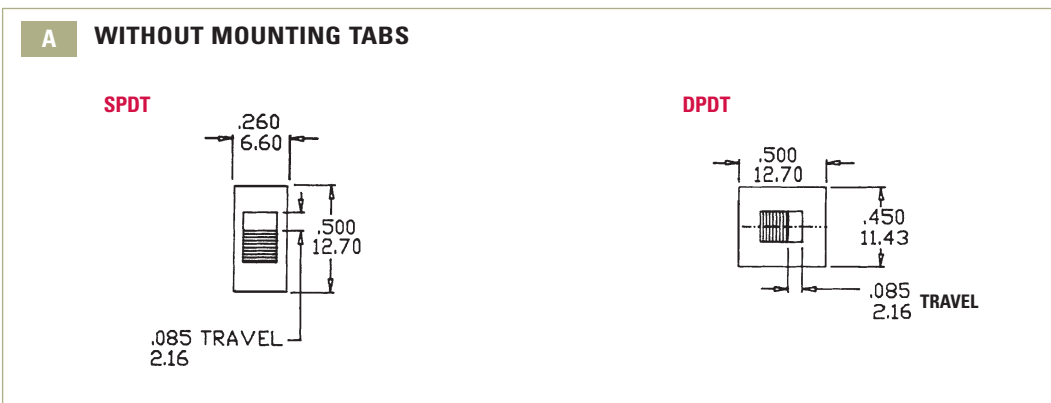

CONTACT MATERIAL OPTIONS

Q	
Fixed Terminal:	Silver plated copper alloy
Moving Contact:	Silver plated copper alloy
Rating:	5 Amps with resistive load @ 120VAC or 28VDC 2 Amps with resistive load @ 250VAC

R	
Fixed Terminal:	Copper alloy with gold plate over nickel plate
Moving Contact:	Copper alloy with gold plate over nickel plate
Rating:	0.4 Volt-Amps (VA) max. @ 20V max. (AC or DC)

Данный компонент на территории Российской Федерации

Вы можете приобрести в компании MosChip.

Для оперативного оформления запроса Вам необходимо перейти по данной ссылке:

<http://moschip.ru/get-element>

Вы можете разместить у нас заказ для любого Вашего проекта, будь то серийное производство или разработка единичного прибора.

В нашем ассортименте представлены ведущие мировые производители активных и пассивных электронных компонентов.

Распределительные склады, находящиеся в России, Европе и в Китае, позволяют нам оперативно поставить необходимые компоненты в оптимальные для Вас сроки.

На всех этапах разработки и производства наши партнеры могут получить квалифицированную поддержку опытных инженеров.

Система менеджмента качества компании отвечает требованиям ISO 9001:2011

Офис по работе с юридическими лицами:

107023, г.Москва, Семеновский переулок, д.6, Бизнес-центр «ABC»

Телефон: +7 495 668-12-70 (многоканальный)

Факс: +7 495 668-12-70 (доб.304)

E-mail: info@moschip.ru

Skype отдела продаж:

moschip.ru_3	moschip.ru_6
moschip.ru_4	moschip.ru_7
moschip.ru_11	moschip.ru_8
moschip.ru_12	moschip.ru_9