

## High Efficiency LED in $\varnothing$ 3 mm Clear Package

### Description

The TLH.4900 series was developed for applications where high light output is required.

It is housed in a 3 mm clear plastic package. The small viewing angle of these devices provides a high brightness.

All LEDs are categorized in luminous intensity groups. The green and yellow LEDs are categorized additionally in wavelength groups.

That allows users to assemble LEDs with uniform appearance.

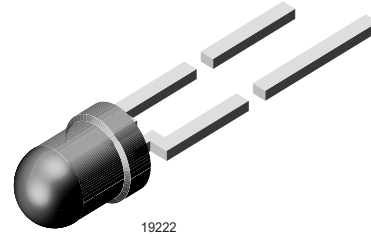

19222



### Features

- Choice of five bright colors
- Standard  $\varnothing$  3 mm (T-1) package
- Small mechanical tolerances
- Suitable for DC and high peak current
- Very small viewing angle
- Luminous intensity categorized
- Yellow and green color categorized
- Lead-free device

### Applications

- Status lights
- OFF / ON indicator
- Background illumination
- Readout lights
- Maintenance lights
- Legend light

### Parts Table

Part	Color, Luminous Intensity	Angle of Half Intensity ( $\pm\phi$ )	Technology
TLHR4900	Red, $I_V > 6.3$ mcd	16 °	GaAsP on GaP
TLHO4900	Soft orange, $I_V > 10$ mcd	16 °	GaAsP on GaP
TLHY4900	Yellow, $I_V > 10$ mcd	16 °	GaAsP on GaP
TLHG4900	Green, $I_V > 16$ mcd	16 °	GaP on GaP
TLHP4900	Pure green, $I_V > 4$ mcd	16 °	GaP on GaP

### Absolute Maximum Ratings

$T_{amb} = 25$  °C, unless otherwise specified

**TLHR4900 , TLHO4900 , TLHY4900 , TLHP4900**

Parameter	Test condition	Symbol	Value	Unit
Reverse voltage		$V_R$	6	V
DC Forward current	$T_{amb} \leq 60$ °C	$I_F$	30	mA
Surge forward current	$t_p \leq 10$ $\mu$ s	$I_{FSM}$	1	A
Power dissipation	$T_{amb} \leq 60$ °C	$P_V$	100	mW
Junction temperature		$T_j$	100	°C
Operating temperature range		$T_{amb}$	- 40 to + 100	°C

Parameter	Test condition	Symbol	Value	Unit
Storage temperature range		$T_{stg}$	- 55 to + 100	°C
Soldering temperature	$t \leq 5$ s, 2 mm from body	$T_{sd}$	260	°C
Thermal resistance junction/ambient		$R_{thJA}$	400	K/W

## Optical and Electrical Characteristics

$T_{amb} = 25$  °C, unless otherwise specified

### Red

#### TLHR4900

Parameter	Test condition	Symbol	Min	Typ.	Max	Unit
Luminous intensity <sup>1)</sup>	$I_F = 10$ mA	$I_V$	6.3	13		mcd
Dominant wavelength	$I_F = 10$ mA	$\lambda_d$	612		625	nm
Peak wavelength	$I_F = 10$ mA	$\lambda_p$		635		nm
Angle of half intensity	$I_F = 10$ mA	$\phi$		$\pm 16$		deg
Forward voltage	$I_F = 20$ mA	$V_F$		2	3	V
Reverse voltage	$I_R = 10$ $\mu$ A	$V_R$	6	15		V
Junction capacitance	$V_R = 0$ , $f = 1$ MHz	$C_j$		50		pF

<sup>1)</sup> in one Packing Unit  $I_{Vmin}/I_{Vmax} \leq 0.5$

### Soft Orange

#### TLHO4900

Parameter	Test condition	Symbol	Min	Typ.	Max	Unit
Luminous intensity <sup>1)</sup>	$I_F = 10$ mA	$I_V$	10	26		mcd
Dominant wavelength	$I_F = 10$ mA	$\lambda_d$	598		611	nm
Peak wavelength	$I_F = 10$ mA	$\lambda_p$		605		nm
Angle of half intensity	$I_F = 10$ mA	$\phi$		$\pm 16$		deg
Forward voltage	$I_F = 20$ mA	$V_F$		2.4	3	V
Reverse voltage	$I_R = 10$ $\mu$ A	$V_R$	6	15		V
Junction capacitance	$V_R = 0$ , $f = 1$ MHz	$C_j$		50		pF

<sup>1)</sup> in one Packing Unit  $I_{Vmin}/I_{Vmax} \leq 0.5$

### Yellow

#### TLHY4900

Parameter	Test condition	Symbol	Min	Typ.	Max	Unit
Luminous intensity <sup>1)</sup>	$I_F = 10$ mA	$I_V$	10	26		mcd
Dominant wavelength	$I_F = 10$ mA	$\lambda_d$	581		594	nm
Peak wavelength	$I_F = 10$ mA	$\lambda_p$		585		nm
Angle of half intensity	$I_F = 10$ mA	$\phi$		$\pm 16$		deg
Forward voltage	$I_F = 20$ mA	$V_F$		2.4	3	V
Reverse voltage	$I_R = 10$ $\mu$ A	$V_R$	6	15		V
Junction capacitance	$V_R = 0$ , $f = 1$ MHz	$C_j$		50		pF

<sup>1)</sup> in one Packing Unit  $I_{Vmin}/I_{Vmax} \leq 0.5$

## Green

TLHG4900

Parameter	Test condition	Symbol	Min	Typ.	Max	Unit
Luminous intensity <sup>1)</sup>	$I_F = 10 \text{ mA}$	$I_V$	16	37		mcd
Dominant wavelength	$I_F = 10 \text{ mA}$	$\lambda_d$	562		575	nm
Peak wavelength	$I_F = 10 \text{ mA}$	$\lambda_p$		565		nm
Angle of half intensity	$I_F = 10 \text{ mA}$	$\phi$		$\pm 16$		deg
Forward voltage	$I_F = 20 \text{ mA}$	$V_F$		2.4	3	V
Reverse voltage	$I_R = 10 \mu\text{A}$	$V_R$	6	15		V
Junction capacitance	$V_R = 0, f = 1 \text{ MHz}$	$C_j$		50		pF

<sup>1)</sup> in one Packing Unit  $I_{Vmin}/I_{Vmax} \leq 0.5$

## Pure green

TLHP4900

Parameter	Test condition	Symbol	Min	Typ.	Max	Unit
Luminous intensity <sup>1)</sup>	$I_F = 10 \text{ mA}$	$I_V$	4	13		mcd
Dominant wavelength	$I_F = 10 \text{ mA}$	$\lambda_d$	555		565	nm
Peak wavelength	$I_F = 10 \text{ mA}$	$\lambda_p$		555		nm
Angle of half intensity	$I_F = 10 \text{ mA}$	$\phi$		$\pm 16$		deg
Forward voltage	$I_F = 20 \text{ mA}$	$V_F$		2.4	3	V
Reverse voltage	$I_R = 10 \mu\text{A}$	$V_R$	6	15		V
Junction capacitance	$V_R = 0, f = 1 \text{ MHz}$	$C_j$		50		pF

<sup>1)</sup> in one Packing Unit  $I_{Vmin}/I_{Vmax} \leq 0.5$

## Typical Characteristics ( $T_{amb} = 25 \text{ }^\circ\text{C}$ unless otherwise specified)

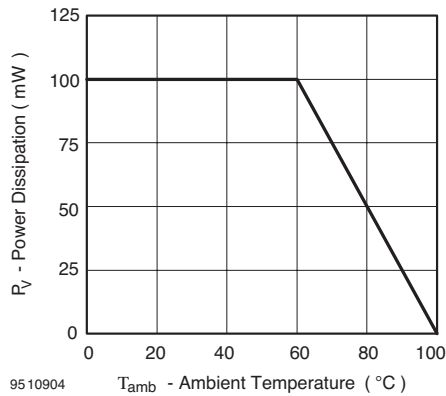

Figure 1. Power Dissipation vs. Ambient Temperature

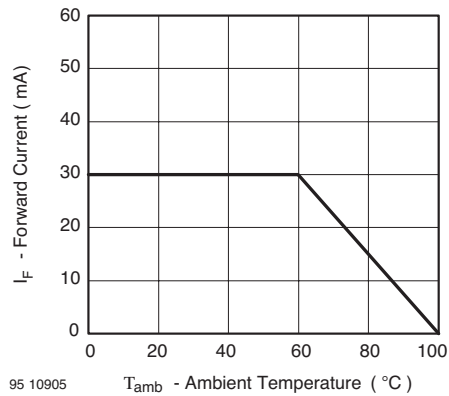

Figure 2. Forward Current vs. Ambient Temperature for InGaN

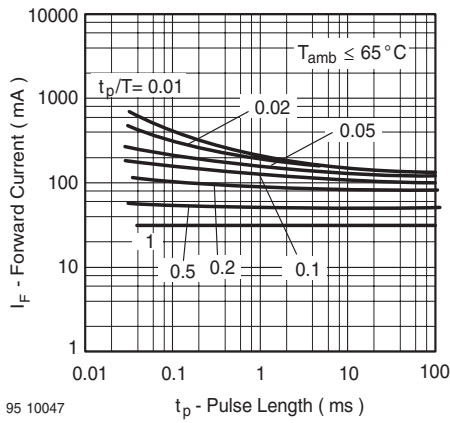

Figure 3. Forward Current vs. Pulse Length

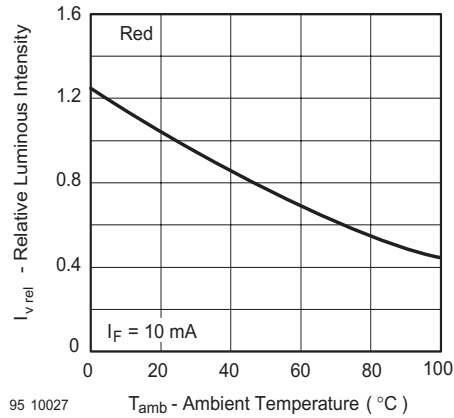

Figure 6. Rel. Luminous Intensity vs. Ambient Temperature

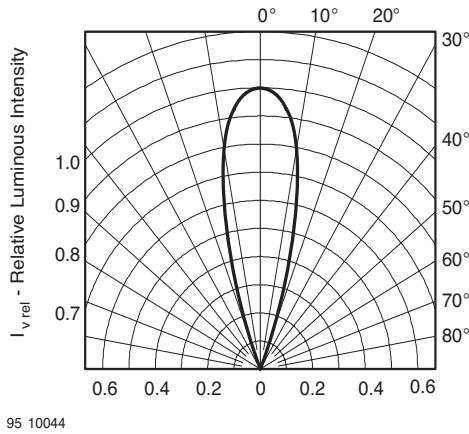

Figure 4. Rel. Luminous Intensity vs. Angular Displacement

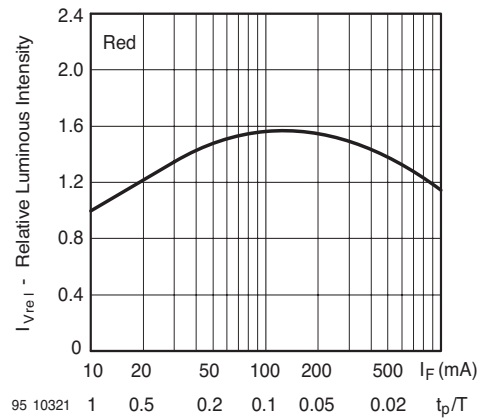

Figure 7. Rel. Luminous Intensity vs. Forw. Current/Duty Cycle

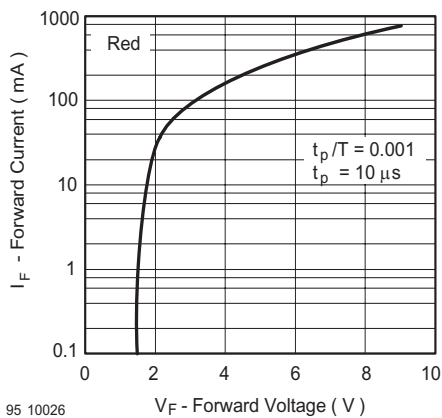

Figure 5. Forward Current vs. Forward Voltage

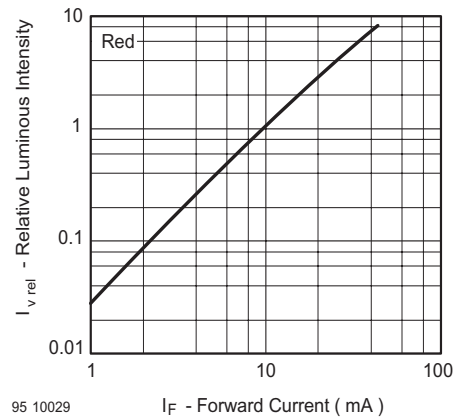

Figure 8. Relative Luminous Intensity vs. Forward Current

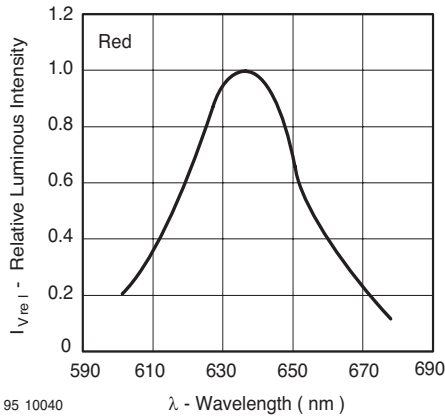

Figure 9. Relative Intensity vs. Wavelength

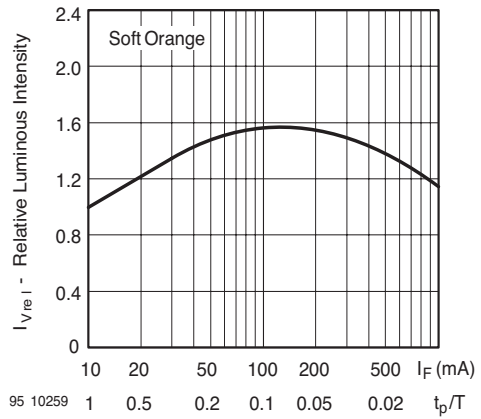

Figure 12. Rel. Lumin. Intensity vs. Forw. Current/Duty Cycle

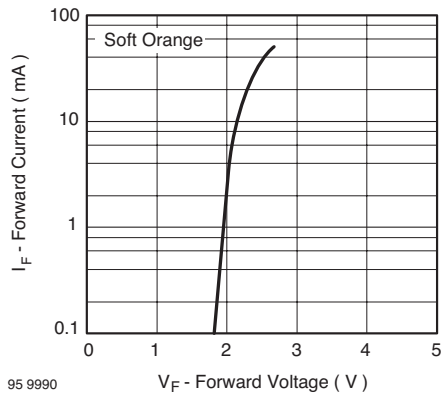

Figure 10. Forward Current vs. Forward Voltage

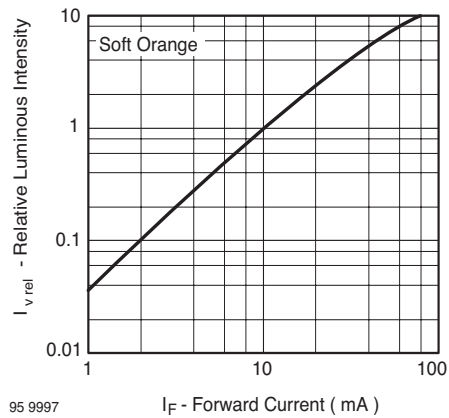

Figure 13. Relative Luminous Intensity vs. Forward Current

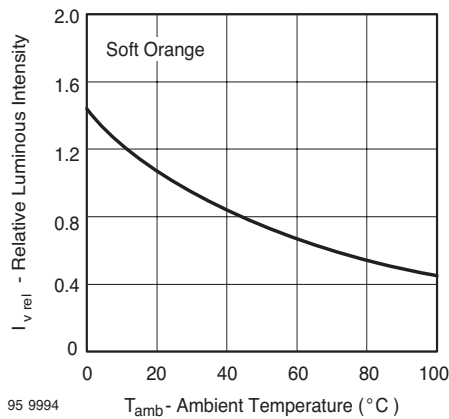

Figure 11. Rel. Luminous Intensity vs. Ambient Temperature

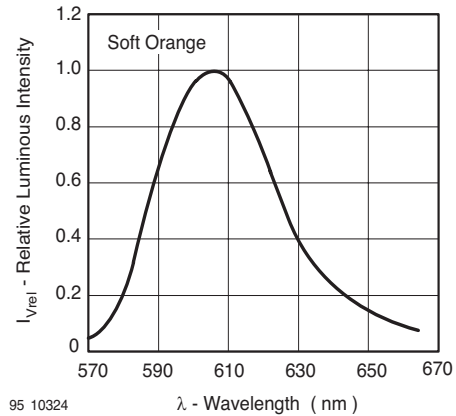

Figure 14. Relative Intensity vs. Wavelength

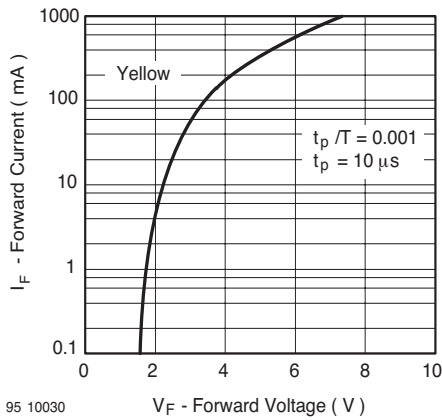

Figure 15. Forward Current vs. Forward Voltage

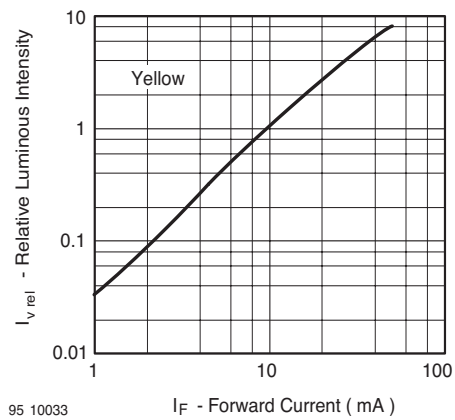

Figure 18. Relative Luminous Intensity vs. Forward Current

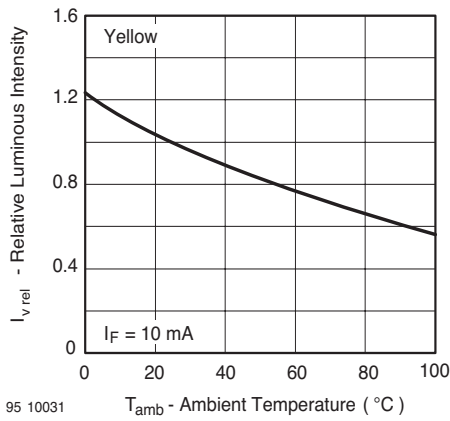

Figure 16. Rel. Luminous Intensity vs. Ambient Temperature

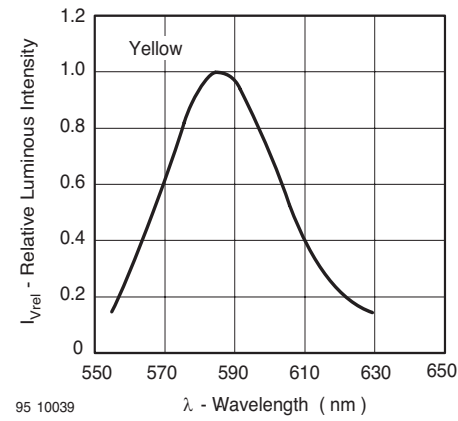

Figure 19. Relative Intensity vs. Wavelength

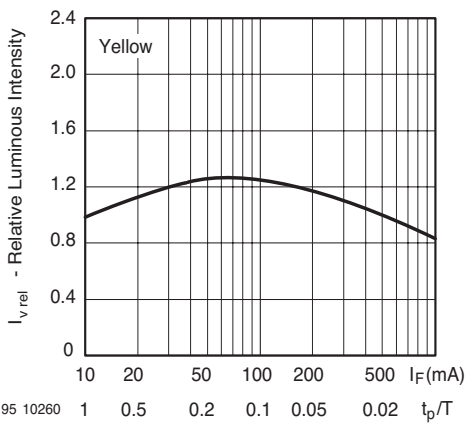

Figure 17. Rel. Lumin. Intensity vs. Forw. Current/Duty Cycle

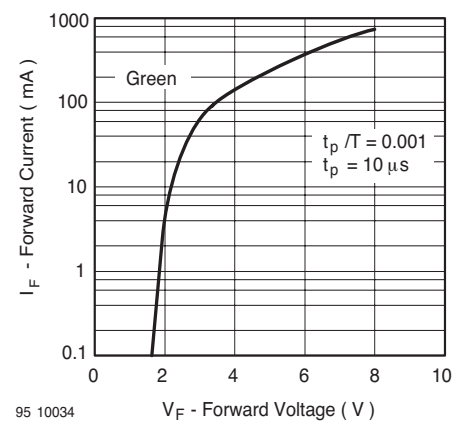

Figure 20. Forward Current vs. Forward Voltage

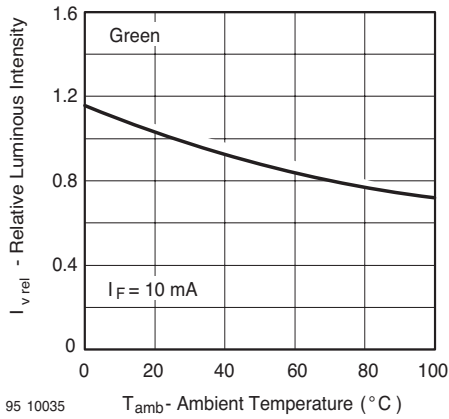

Figure 21. Rel. Luminous Intensity vs. Ambient Temperature

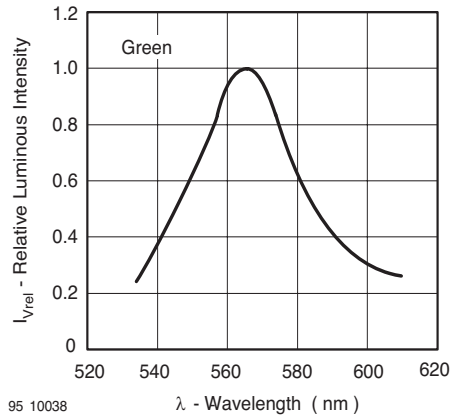

Figure 24. Relative Intensity vs. Wavelength

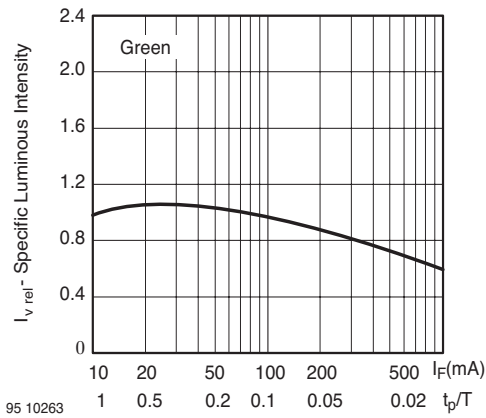

Figure 22. Specific Luminous Intensity vs. Forward Current

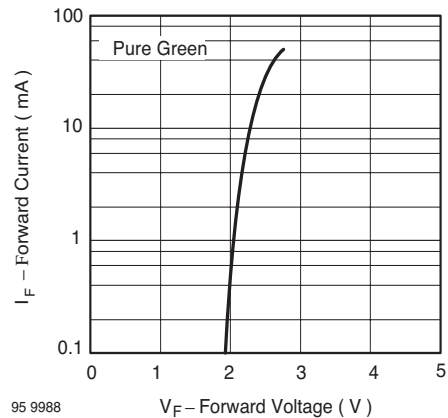

Figure 25. Forward Current vs. Forward Voltage

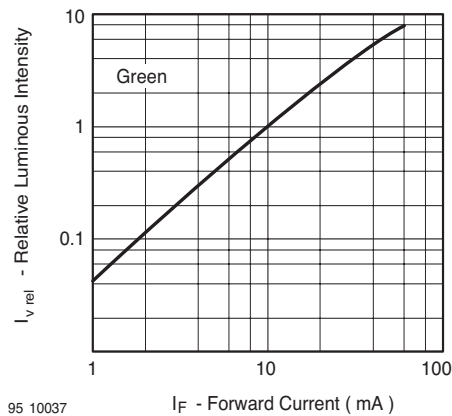

Figure 23. Relative Luminous Intensity vs. Forward Current

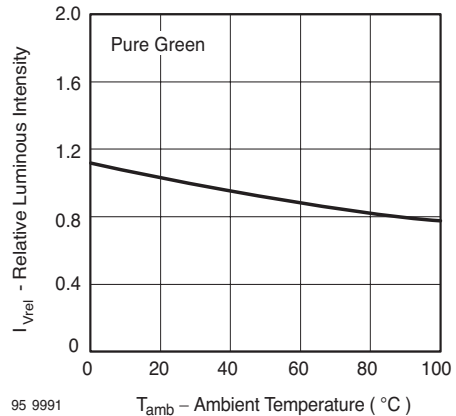

Figure 26. Rel. Luminous Intensity vs. Ambient Temperature

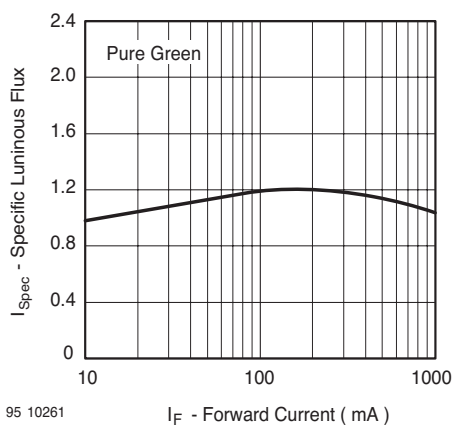

Figure 27. Specific Luminous Intensity vs. Forward Current

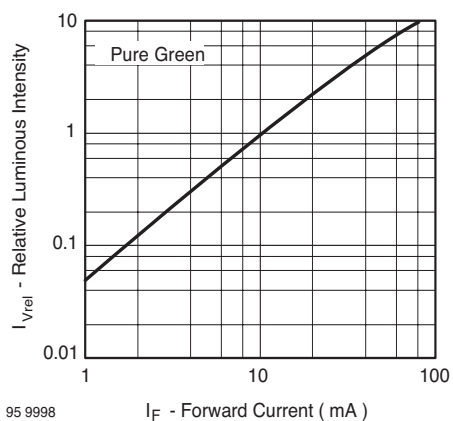

Figure 28. Relative Luminous Intensity vs. Forward Current

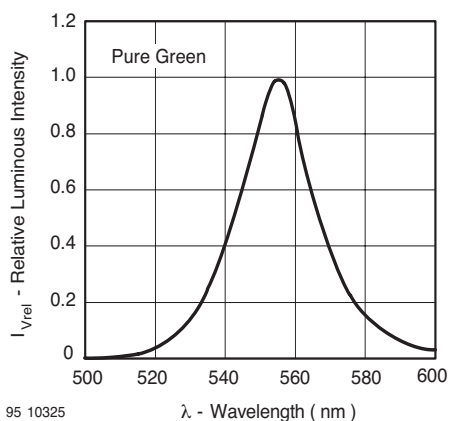
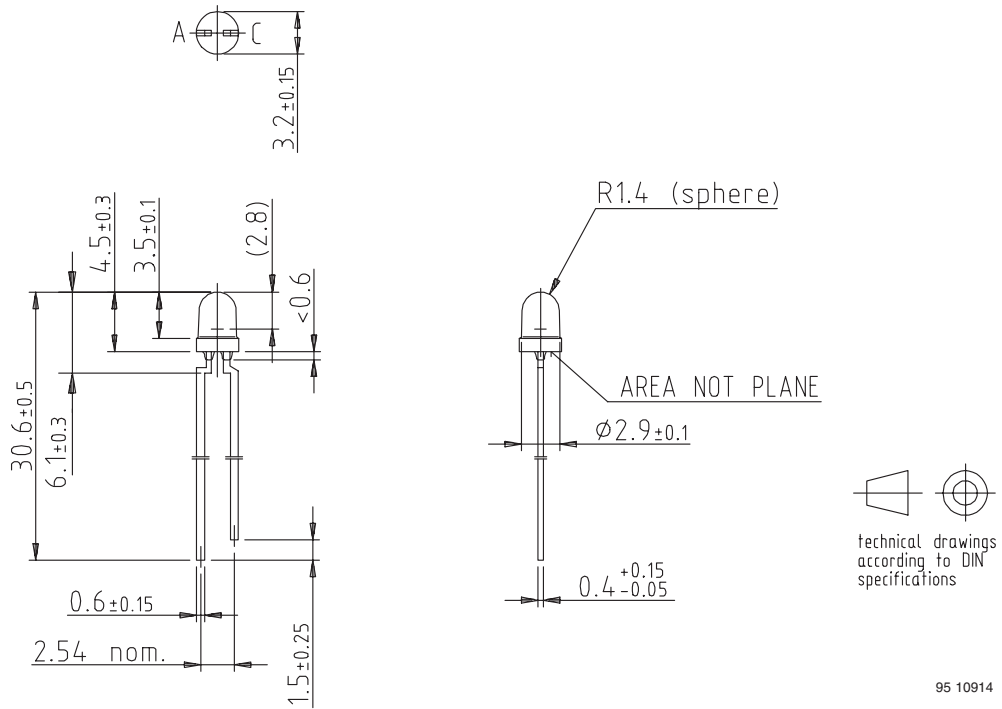

Figure 29. Relative Intensity vs. Wavelength



## Package Dimensions in mm



### Ozone Depleting Substances Policy Statement

It is the policy of **Vishay Semiconductor GmbH** to

1. Meet all present and future national and international statutory requirements.
2. Regularly and continuously improve the performance of our products, processes, distribution and operating systems with respect to their impact on the health and safety of our employees and the public, as well as their impact on the environment.

It is particular concern to control or eliminate releases of those substances into the atmosphere which are known as ozone depleting substances (ODSs).

The Montreal Protocol (1987) and its London Amendments (1990) intend to severely restrict the use of ODSs and forbid their use within the next ten years. Various national and international initiatives are pressing for an earlier ban on these substances.

**Vishay Semiconductor GmbH** has been able to use its policy of continuous improvements to eliminate the use of ODSs listed in the following documents.

1. Annex A, B and list of transitional substances of the Montreal Protocol and the London Amendments respectively
2. Class I and II ozone depleting substances in the Clean Air Act Amendments of 1990 by the Environmental Protection Agency (EPA) in the USA
3. Council Decision 88/540/EEC and 91/690/EEC Annex A, B and C (transitional substances) respectively.

**Vishay Semiconductor GmbH** can certify that our semiconductors are not manufactured with ozone depleting substances and do not contain such substances.

**We reserve the right to make changes to improve technical design  
and may do so without further notice.**

Parameters can vary in different applications. All operating parameters must be validated for each customer application by the customer. Should the buyer use Vishay Semiconductors products for any unintended or unauthorized application, the buyer shall indemnify Vishay Semiconductors against all claims, costs, damages, and expenses, arising out of, directly or indirectly, any claim of personal damage, injury or death associated with such unintended or unauthorized use.

Vishay Semiconductor GmbH, P.O.B. 3535, D-74025 Heilbronn, Germany  
Telephone: 49 (0)7131 67 2831, Fax number: 49 (0)7131 67 2423



### Notice

Specifications of the products displayed herein are subject to change without notice. Vishay Intertechnology, Inc., or anyone on its behalf, assumes no responsibility or liability for any errors or inaccuracies.

Information contained herein is intended to provide a product description only. No license, express or implied, by estoppel or otherwise, to any intellectual property rights is granted by this document. Except as provided in Vishay's terms and conditions of sale for such products, Vishay assumes no liability whatsoever, and disclaims any express or implied warranty, relating to sale and/or use of Vishay products including liability or warranties relating to fitness for a particular purpose, merchantability, or infringement of any patent, copyright, or other intellectual property right.

The products shown herein are not designed for use in medical, life-saving, or life-sustaining applications. Customers using or selling these products for use in such applications do so at their own risk and agree to fully indemnify Vishay for any damages resulting from such improper use or sale.

## Данный компонент на территории Российской Федерации

### Вы можете приобрести в компании MosChip.

Для оперативного оформления запроса Вам необходимо перейти по данной ссылке:

<http://moschip.ru/get-element>

Вы можете разместить у нас заказ для любого Вашего проекта, будь то серийное производство или разработка единичного прибора.

В нашем ассортименте представлены ведущие мировые производители активных и пассивных электронных компонентов.

Нашей специализацией является поставка электронной компонентной базы двойного назначения, продукции таких производителей как XILINX, Intel (ex.ALTERA), Vicor, Microchip, Texas Instruments, Analog Devices, Mini-Circuits, Amphenol, Glenair.

Сотрудничество с глобальными дистрибьюторами электронных компонентов, предоставляет возможность заказывать и получать с международных складов практически любой перечень компонентов в оптимальные для Вас сроки.

На всех этапах разработки и производства наши партнеры могут получить квалифицированную поддержку опытных инженеров.

Система менеджмента качества компании отвечает требованиям в соответствии с ГОСТ Р ИСО 9001, ГОСТ РВ 0015-002 и ЭС РД 009

### Офис по работе с юридическими лицами:

105318, г.Москва, ул.Щербаковская д.3, офис 1107, 1118, ДЦ «Щербаковский»

Телефон: +7 495 668-12-70 (многоканальный)

Факс: +7 495 668-12-70 (доб.304)

E-mail: [info@moschip.ru](mailto:info@moschip.ru)

Skype отдела продаж:

moschip.ru

moschip.ru\_4

moschip.ru\_6

moschip.ru\_9