

AXL E ETH DIO16 M12 6M

**Axioline E Ethernet device, metal housing,
16 freely configurable inputs or outputs,
24 V DC, M12 fast connection technology**



Data sheet
8547_en_03

© PHOENIX CONTACT 2016-02-08

1 Description

The Axioline E device is designed for use within an Ethernet network (Modbus/TCP).

It is used to acquire and output digital signals.

The device is designed for use in systems manufacturing.

It is suitable for use without a control cabinet under harsh industrial conditions.

The Axioline E device can be used on tool platforms, directly on welding robots or in conveying technology, for example.

Ethernet features

- 2 Ethernet ports (with integrated switch)
- Supported protocols: SNMP v1, HTTP, TFTP, FTP, BootP, DHCP
- Specification: Modbus application protocol V1.1b
- Firmware can be updated
- Integrated web server for web-based management

Axioline E features

- Connection to Ethernet network (Modbus/TCP) using M12 connectors (D-coded)
- Transmission speed of 10 Mbps and 100 Mbps
- Connection of digital sensors and actuators to M12 connectors (A-coded)
- Diagnostic and status indicators
- Short-circuit and overload protection of the sensor supply
- IP65/67 degree of protection



This data sheet is only valid in association with the associated user manual.



Make sure you always use the latest documentation.
It can be downloaded from the product at phoenixcontact.net/products.



By default upon delivery, the process data watchdog is deactivated.

2	Table of contents	
1	Description	1
2	Table of contents	2
3	Ordering data	3
4	Technical data	4
5	Internal circuit diagram	7
6	Pin assignment	8
7	Connection example.....	10
8	Connection notes	10
9	Configuration via rotary encoding switch	11
10	Local status and diagnostic indicators	13
11	Monitoring.....	15
12	Substitute value behavior	16
13	Modbus protocols and registers	16
14	Startup.....	21
15	SNMP - Simple Network Management Protocol	22
16	WBM - Web-based management	22
17	Firmware update.....	22
18	Quick Connect.....	22
19	Endianness.....	22

3 Ordering data

Description	Type	Order No.	Pcs./Pkt.
Axioline E-Ethernet device in a metal housing with 16 freely configurable inputs or outputs, 24 V DC, M12 fast connection technology	AXL E ETH DIO16 M12 6M	2701539	1

Accessories	Type	Order No.	Pcs./Pkt.
An M12 screw plug for the unoccupied M12 sockets of the sensor/actuator cable, boxes and flush-type connectors (Protection and sealing elements)	PROT-M12	1680539	5
Mounting plate for Axioline E metal devices (Assembly)	AXL E MP 60	2701761	1
Snap-in markers, Sheet, white, unlabeled, can be labeled with: THERMOMARK CARD, BLUEMARK CLED, BLUEMARK LED, TOPMARK LASER, Mounting type: snapped into marker carrier, Lettering field: 7 x 10 mm (Marking)	UCT-EM (7X10)	0830765	10

Documentation	Type	Order No.	Pcs. / Pkt.
User manual, English, Axioline E: system and installation	UM EN AXL E SYS INST	-	-
Application note, English: Updating the firmware of AXL E devices using the Windows Explorer	AH EN FIRMWARE UPDATE AXL E	-	-
Application note, English: Startup of Axioline E Ethernet devices (Modbus/TCP) using the ModScan32 Modbus master tool	AH EN AXL E ETH MODSCAN32	-	-

Additional ordering data

For additional accessories, visit phoenixcontact.net/products.

4 Technical data

Dimensions (nominal sizes in mm)

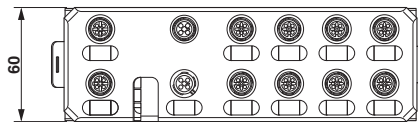

Width	60 mm
Height	185 mm
Depth	38 mm
Note on dimensions	The height is 194.5 mm including the mounting plate. With fixing clips pulled out, the height is 212 mm. The depth is 38 mm including the mounting plate (30.5 mm without the mounting plate).

General data

Housing material	Zinc die-cast
Weight	750 g
Ambient temperature (operation)	-25 °C ... 60 °C



CAUTION: Risk of burns

If the device is used at an ambient temperature above 50°C, the contact temperature of metal surfaces may exceed 70°C.

Ambient temperature (storage/transport)	-25 °C ... 85 °C
Permissible humidity (operation)	5 % ... 95 %
Permissible humidity (storage/transport)	5 % ... 95 %
Air pressure (operation)	70 kPa ... 106 kPa (up to 3000 m above sea level)
Air pressure (storage/transport)	70 kPa ... 106 kPa (up to 3000 m above sea level)
Degree of protection	IP65/IP67
Protection class	III, IEC 61140, EN 61140, VDE 0140-1

Connection data

Connection method	M12 connector
-------------------	---------------

Interface Ethernet

Number	2
Connection method	M12 connectors, D-coded
Designation connection point	Copper cable
Number of positions	4
Transmission speed	10/100 MBit/s (with auto negotiation)
Cycle Time	min. 1 ms

Modbus/TCP

Equipment type	Modbus slave (server)
Modbus protocols	Modbus/TCP
Additional protocols	SNMP v1, HTTP, TFTP, FTP, BootP, DHCP
Specification	Modbus application protocol V1.1b

Supply: Module electronics, sensors and actuators (U_S)

Connection method	M12 connector (T-coded)
Number of positions	4
Supply voltage	24 V DC
Nominal supply voltage range	18 V DC ... 31.2 V DC (including all tolerances, including ripple)
Typical current consumption	190 mA ±15 % (at 24 V DC)
Current consumption	max. 12 A

Supply: Actuators (U_A) for additional devices

Connection method	M12 connector (T-coded)
Number of positions	4
Supply voltage	24 V DC
Nominal supply voltage range	18 V DC ... 31.2 V DC (including all tolerances, including ripple)
Typical current consumption	3 mA ±15 % (at 24 V DC)
Current consumption	max. 12 A

Digital inputs

Number of inputs	16 (EN 61131-2 types 1 and 3)
Connection method	M12 connector, double occupancy
Connection method	2, 3, 4-wire
Nominal input voltage	24 V DC
Nominal input current	typ. 3 mA
Sensor current per channel	typ. 0.75 mA (from U _S)
Total sensor current	max. 1.2 A (per device)
Input voltage range "0" signal	-30 V DC ... 5 V DC
Input voltage range "1" signal	11 V DC ... 30 V DC
Input filter time	< 1000 µs
Permissible conductor length to the sensor	30 m
Overload protection, short-circuit protection of sensor supply	Yes

Digital outputs

Number of outputs	16
Connection method	M12 connector, double occupancy
Connection method	2, 3-wire
Nominal output voltage	24 V DC (from voltage U _S)
Output voltage range	18 V DC ... 31.2 V DC
Maximum output current per channel	0.5 A
Nominal load, ohmic	12 W (48 Ω; with nominal voltage)
Nominal load, inductive	12 VA (1.2 H; 48 Ω; with nominal voltage)
Signal delay	max. 150 µs (when switched on) max. 200 µs (when switched off)
Switching frequency	max. 5500 per second (with at least 50 mA load current)
Switching frequency	max. 1 per second (with inductive load)

Digital outputs

Limitation of the voltage induced on circuit interruption	-28 V ... -17 V
Output voltage when switched off	max. 1 V
Output current when switched off	max. 20 µA
Behavior with overload	Auto restart
Reverse voltage resistance to short pulses	Reverse voltage proof
Overcurrent shut-down	min. 0.7 A
Overload protection, short-circuit protection of outputs	Electronic

Electrical isolation/isolation of the voltage areas

Test section	Test voltage
24 V supply (communications power/sensor supply, digital inputs/outputs)/ bus connection (Ethernet 1)	500 V AC, 50 Hz, 1 min
24 V supply (communications power/sensor supply, digital inputs/outputs)/ bus connection (Ethernet 2)	500 V AC, 50 Hz, 1 min
24 V supply (communications power/sensor supply, digital inputs/outputs)/ FE	500 V AC, 50 Hz, 1 min
Bus connection (Ethernet 1)/FE	500 V AC, 50 Hz, 1 min
Bus connection (Ethernet 2)/FE	500 V AC, 50 Hz, 1 min
Bus connection (Ethernet 1)/bus connection (Ethernet 2)	500 V AC, 50 Hz, 1 min
24 V supply (actuator supply)/24 V supply (communications power and sensor supply, digital inputs/outputs)	500 V AC, 50 Hz, 1 min
24 V supply (actuator supply)/bus connection (Ethernet 1)	500 V AC, 50 Hz, 1 min
24 V supply (actuator supply)/bus connection (Ethernet 2)	500 V AC, 50 Hz, 1 min
24 V supply (actuator supply)/FE	500 V AC, 50 Hz, 1 min

Mechanical tests

Vibration resistance in acc. with EN 60068-2-6/IEC 60068-2-6	5g
Shock in acc. with EN 60068-2-27/IEC 60068-2-27	30g, 11 ms period, half-sine shock pulse
Continuous shock according to EN 60068-2-27/IEC 60068-2-27	10g

Conformance with EMC Directive 2004/108/EC

Noise immunity test in accordance with EN 61000-6-2

Electrostatic discharge (ESD) EN 61000-4-2/IEC 61000-4-2	Criterion B; 6 kV contact discharge, 8 kV air discharge
Electromagnetic fields EN 61000-4-3/IEC 61000-4-3	Criterion A; Field intensity: 10 V/m
Fast transients (burst) EN 61000-4-4/IEC 61000-4-4	Criterion B, 2 kV
Transient surge voltage (surge) EN 61000-4-5/IEC 61000-4-5	Criterion B; DC supply lines: ±0.5 kV/±0.5 kV (symmetrical/asymmetrical)
Conducted interference EN 61000-4-6/IEC 61000-4-6	Criterion A; Test voltage 10 V

Noise emission test as per EN 61000-6-4

Radio interference properties EN 55022	Class A
--	---------





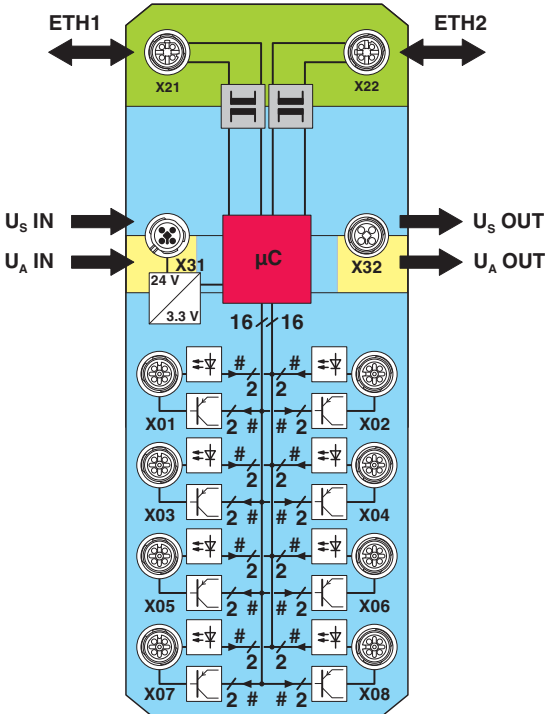

Approvals

For the latest approvals, please visit phoenixcontact.net/products.

5 Internal circuit diagram



Key:

-  Transmitter with electrical isolation
-  Power supply unit with electrical isolation
-  Microcontroller
-  Digital input
-  Digital output
-  LED
-  Transistor

 The U_S voltage supplies the freely configurable inputs and outputs.

Figure 1 Internal wiring of connections

Key:

- Green area: Network
- Blue area: U_S
- Yellow area: U_A

6 Pin assignment

6.1 Ethernet and power supply connection

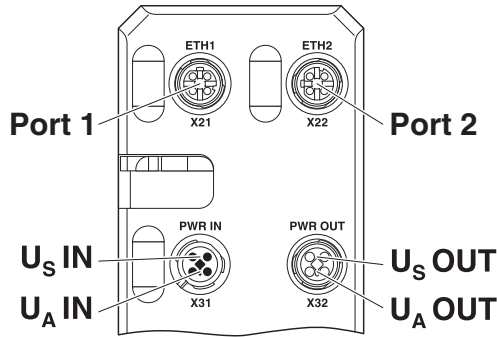

Figure 2 Connections for Ethernet and voltage supply

Designation	Meaning
Port 1 (X21)	Ethernet port 1
Port 2 (X22)	Ethernet port 2
U _S IN (X31)	Power supply IN (logic, sensors and actuators)
U _A IN (X31)	Power Supply IN (actuators) for additional devices
U _S OUT (X32)	Power supply OUT for additional devices
U _A OUT (X32)	Power supply OUT for additional devices



Ground the device by means of the mounting screws of the fixing clips or the mounting plate or the DIN rail.

6.2 Ethernet pin assignment

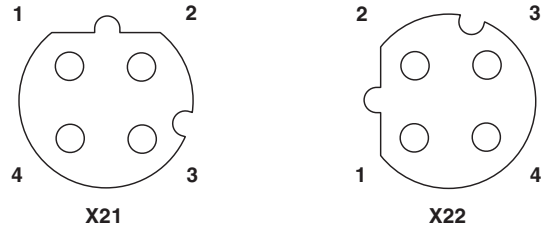

Figure 3 Ethernet pin assignment, D-coded

Pin	Ethernet port 1 (X21)	Ethernet port 2 (X22)
1	TX+	TX+
2	RX+	RX+
3	TX-	TX-
4	RX-	RX-



The shield is connected to FE in the device.



The thread is used for additional shielding.

6.3 Pin assignment of the power supply U_S/U_A

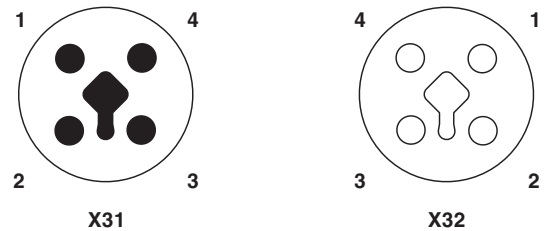

Figure 4 Pin assignment of the power supply, T-coded

Pin	IN	OUT	Conductor colors
1	+24 V DC (U _S)	+24 V DC (U _S)	Brown
2	GND (U _A)	GND (U _A)	White
3	GND (U _S)	GND (U _S)	Blue
4	+24 V DC (U _A)	+24 V DC (U _A)	Black

6.4 Connecting inputs and outputs

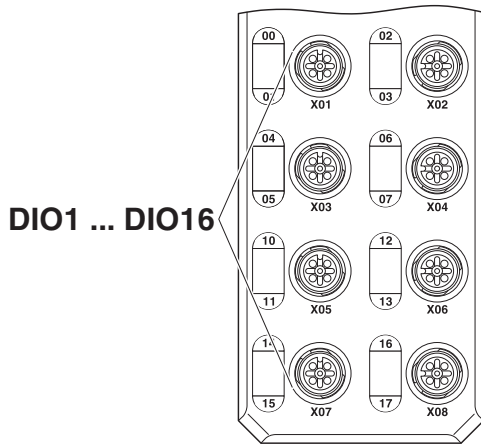

Figure 5 Input and output connections

Designation	Meaning
DIO1 ... DIO16 (X01 ... X08)	Inputs/outputs 1 ... 16

6.5 Pin assignment of the inputs and outputs



Figure 6 Pin assignment of the inputs and outputs, A-coded

Pin	Input/output socket
1	+24 V DC (U_S)
2	Input/output 2, 4, 6, ... 16
3	GND
4	Input/output 1, 3, 5, ... 15
5	FE

7 Connection example

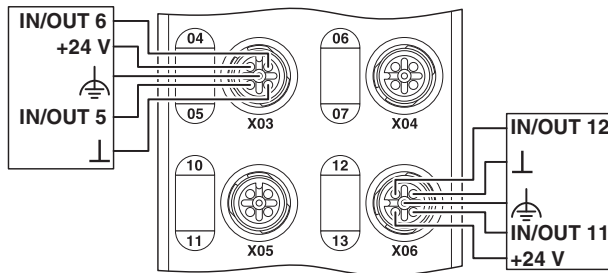

Figure 7 Example of connection of sensors and actuators

8 Connection notes



Note: data corruption or loss

Implement the FE connection using mounting screws, in order to ensure immunity to interference.



NOTE: device damage

To ensure IP65/IP67 protection, cover unused sockets with protective caps.



NOTE: Damage to the electronics

Only supply the sensors with the voltage U_S provided at the terminal points.



NOTE: Damage to the electronics

Observe the correct polarity of the supply voltages U_S and U_A in order to prevent damage to the device.



NOTE: Malfunction

When connecting the sensors and actuators, observe the assignment of the connections to the Ethernet input and output data.



Secure the device to a level surface or to a profile. Do not use this device to bridge gaps, in order to prevent forces being transmitted via the device.



Use standard M5 screws with toothed lock washer and self-locking nuts. Observe the maximum torque of the screws.

9 Configuration via rotary encoding switch

You can configure the address assignment and other functions using rotary encoding switches.

After modifying the switch position, restart the device, as the modification to the switch position does not take effect during operation.



Figure 8 Rotary encoding switch

The code results from the sum of S1 x 10 plus S2 x 1. The image shows code 77 (7 x 10 + 7).

S1	S2	Code	Function
0	0	00	Remote access (default)
0 ... 5	1 ... 0	01 ... 50	Manual address assignment
5 ... 15	0 ... 9	51 ... 159	DHCP name assignment
0	A	0A	Static address
0	E	0E	Resetting IP parameters
0	F	0F	Resetting to the default settings
Other			Reserved

9.1 Remote access

Switch position 00

At this switch position, it is possible to remotely configure the device using corresponding tools (e.g., Startup+, web-based management (WBM)).

Behavior during initial startup, after resetting the IP parameters or after resetting to default settings

Default: BootP aktiviert, DHCP deaktiviert

A valid IP address is not assigned (0.0.0.0) and communication is therefore not possible.

The device transmits continuous BootP requests, until a valid IP address has been received.

Valid IP parameters are then automatically saved as configuration data on the device.

Each additional startup

BootP activated

BootP requests are transmitted even in the case of a valid configuration. If the device receives a BootP reply, the new IP parameters are applied. Otherwise the device starts with the last valid configuration.

DHCP activated

For behavior, see switch position 51 ... 159. The station name can be selected in WBM, the default station name is the MAC address with "-" used as the separator.

Static (BootP and DHCP deactivated)

The device starts with the last valid assigned IP configuration.

9.2 Manual address assignment

Switch position 01 ... 50

Default: BootP deactivated, DHCP activated

The first three octets in the IP address are preset as 192.168.0.x.

The subnet mask is 255.255.255.0.

Specify the last byte with the switch position.

As such, you can select IP addresses between 192.168.0.1 and 192.168.0.50.

Prior to transferring the IP address, a test is performed to check for any potential IP address conflicts. If a conflict is detected, the device temporarily switches the IP address to 0.0.0.0 (no IP communication). In this case, the NET LED flashes red. Eliminate the conflict and restart the device.

9.3 DHCP name assignment

Switch position 51 ... 159

This switch position is used to easily specify the DHCP host name for the device.

The host name is provided to the DHCP server via DHCP options. This is therefore able to send a DNS update to the DNS server.

The DNS name consists of one set part, which is based on the order designation, and a variable part, which is determined by the switch position.

The first part of the station name is AXL-E-ETH-.

The set number is added.

This results in the following station names:
AXL-E-ETH-051 ... AXL-E-ETH-159.

Behavior during initial startup, after resetting the IP parameters or after resetting to default settings

A valid IP address is not assigned (0.0.0.0) and communication is therefore not possible.

The device transmits continuous DHCP discover messages until a valid IP address has been received.

Each additional startup

The device transmits continuous DHCP requests.

There are two possible scenarios:

1. The DHCP server assigns a new IP address.
⇒ The device applies the new IP parameters.
2. The DHCP server does not respond.
⇒ The device transmits continuous DHCP Discover messages until new IP parameters have been received.

9.4 Static address

Switch position 0A

Behavior during initial startup, after resetting the IP parameters or after resetting to default settings

A valid IP address is not assigned (0.0.0.0) and communication is therefore not possible.

Assign an address initially with another switch position.

Each additional startup

After a voltage reset, the device maintains the IP address which was assigned last.



With this switch position, modifying the IP address via tools or web-based management is not possible.

9.5 Resetting IP parameters

Switch position 0E

The IP parameters stored on the device are reset.

All other settings made on the device are retained.

- BootP is activated for switch position 00.
- IP address, subnet mask: 0.0.0.0

As long as the switch position 0E remains selected, no connection to the device can be established.

IP communication is deactivated (LED NET static yellow).

9.6 Resetting to the default settings

Switch position 0F

All settings are reset to default settings, including IP parameters.



The device is ready for operation after powering up, as soon as the RDY LED lights up green.
A connection to the device however cannot be established in this switch position.
As soon as the RDY LED lights up green, a new switch position can be selected on the rotary encoding switch and the device can be restarted.

9.7 Reserved/invalid switch position

The device starts with the previous settings, e.g., with the settings that were valid before the device was restarted.

An invalid switch position is indicated by the RDY LED (red on).

10 Local status and diagnostic indicators

10.1 Indicators for Ethernet ports and power supply



Figure 9 Indicators for Ethernet ports and power supply

Designation	Color	Meaning	State	Description
LNK 1/2	Green	Link	Green ON	Connection present at port 1/2.
			OFF	Connection not present at port 1/2.
ACT 1/2	Yellow	Activity	Yellow ON	Data transmission present at port 1/2.
			OFF	Data transmission not present at port 1/2.
RDY	Green/ yellow/ red	Ready	Green ON	Device is ready for operation.
			Green flashing	Firmware update is being performed.
			Flashing green/ yellow	Over- or undervoltage at U_S Temperature of the device is in the critical area. And red US LED: sensor supply overload
			Red ON	Rotary encoding switches are set to an invalid/reserved position.
			OFF	Device is not ready for operation.
NET	Green/ yellow/ red	Network status	Green flashing	A connection can be established to the device.
			Green ON	At least one connection has been established to the device.
			Yellow flashing	BootP request or DHCP requests/discover messages are being transmitted.
			Yellow ON	The IP configuration/IP address (0.0.0.0) is invalid.
			Red flashing	An IP address conflict has occurred during static configuration via rotary coding switches (IP address assigned twice).
			Red ON	A network error has occurred. The monitoring function detected an error or the process data watchdog was activated.
US	Green/ red	U_{Sensorik}	Green ON	Communications power/sensor voltage present
			OFF	Communications power/sensor voltage not present or too low.
			Red ON	Sensor voltage overload
UA	Green	U_{Aktorik}	ON	Actuator voltage present.
			OFF	Actuator voltage not present.

10.2 Input and output indicators

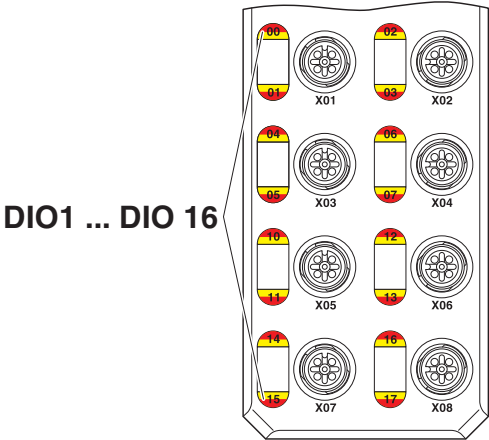

Figure 10 Input and output indicators

Designation	Color	Meaning	State	Description
00 ... 07, 10 ... 17	Yellow	Status of the inputs and outputs when used as an input	ON	Input is set.
			OFF	Input is not set.
00 ... 07, 10 ... 17	Yellow/red	Status of the inputs and outputs when used as an output	Yellow ON	Output is set.
			Red ON	Output is short circuited or overloaded.
			OFF	Output is not set.



The numbering of the LEDs is as follows: the first number specifies the byte, the second number specifies the bit.

11 Monitoring

Monitoring functions with different features are available for monitoring Ethernet communication.

- Modbus connection monitoring
- Process data watchdog

By default upon delivery, the process data watchdog is deactivated.

Mechanism	Monitoring
Modbus connection monitoring	Client application
	Modbus channels
	Ethernet connection
Process data watchdog	Client application
	Ethernet connection
	Process data exchange

By default upon delivery, the process data watchdog is deactivated.

If the timeout period expires for one or both mechanisms, the OUT process data is blocked. The parameterized substitute value behavior of the outputs is performed.

The error is indicated by the NET LED (red on). During the Net Fail state, the OUT process data can continue to be updated by the application.

Following a Net Fail reset, substitute values are then replaced by the latest process data.

11.1 Function of the process data watchdog

A process data watchdog is integrated into the device to avoid uncontrolled setting/resetting of outputs in the event of an error.

If outputs are set, the controlling process must be able to access the device.

In the event of an error, e.g., network cable interrupted or function error in the controlling process, the device can respond appropriately via the process data watchdog.



By default upon delivery, the process data watchdog is deactivated; timeout period = 0 ms.

When activating the process data watchdog, it is started by the first write process and the next write process is expected within the timeout period. During error-free operation, the write process is performed during the timeout period and the watchdog is restarted (triggered).



Reading calls do not trigger the process data watchdog.

11.2 Net fail

If there is no triggering during the timeout period, an error occurred. Two responses follow:

- All outputs are set to the configured substitute value.
- The Net Fail signal is set (NET LED is red and bit 1 in status register 7996 is set).

For safety reasons, the user cannot stop the watchdog once it has been activated.

If the user terminates the controlling application, the watchdog is not triggered. When the timeout period elapses, the Net Fail signal is set, and the parameterized substitute value behavior is performed. After the watchdog has performed its task, the outputs are only enabled again after acknowledgment.



When the error is acknowledged, the watchdog is restarted. This means that it must be triggered during the timeout period, otherwise an error is detected again.

11.3 Configuring the process data watchdog

To activate the watchdog, specify the desired timeout period in the range of 200 ms and 65,000 ms.

In order to deactivate the watchdog, specify the 0 ms timeout period.

You have the following options for changing the timeout period:

- Web-based management
- Modbus register 2000

11.4 Acknowledge error message

To reset the error, it must be acknowledged.

The following options are available:

- Auto (default)
- Manual

This confirmation mode can be configured in the WBM only.

Auto (default)

The error is acknowledged “automatically” with the next valid write access to the output process data. (Net Fail in register 7996 is deleted and the NET LED changes to green).

Manual

In “manual” mode the error must be acknowledged via register 2006 or the web-based management.

12 Substitute value behavior

If Ethernet communication fails, all device outputs are set to the previous parameterized substitute values.

Set the desired substitute value behavior

To set the desired substitute value behavior, the following options are available:

- Web-based management
- Modbus register 2002

For further information, please refer to the “Fault response mode” section.

13 Modbus protocols and registers

The device supports a Modbus/TCP server.

As such, the Modbus protocol can be used in a connection-related (TCP) manner.

13.1 Modbus connections

The device supports up to eight Modbus/TCP connections at the same time.

The connection can access different addresses simultaneously.

Since eight connections are supported, a connection can quickly be restored. This means that the client can successfully restore an interrupted Modbus connection.

13.2 Modbus conformity classes

The device supports Modbus conformity classes 0 and 1 as well as parts of class 2.

13.3 Modbus function codes

The following function codes are supported:

Function code	Function	Description
FC1	Read coils	Read output and input bits
FC2	Read input discretes	Read multiple input bits
FC3	Read holding registers	Read words from outputs and inputs
FC4	Read input registers	Read words from inputs
FC5	Write coil	Write an output bit
FC6	Write single registers	Write word for output data
FC15	Write multiple coils	Write multiple output bits
FC16	Write multiple registers	Write several output words
FC23	Read/write multiple registers	Read and write several process data for inputs and outputs

13.4 Modbus register

Modbus register table (16-bit word)	Access	Function	Access with function code
Special register			
1280	R/W	Modbus timeout monitoring	FC3, FC4, FC6, FC16, FC23
2000	R/W	Timeout for process data watchdog	FC3, FC4, FC6, FC16, FC23
2002	R/W	Substitute value behavior (fault response mode)	FC3, FC4, FC6, FC16, FC23
2004	R	Net Fail reason	FC3, FC4, FC23
2006	W	Command register	FC6, FC16, FC23
Diagnostics			
7996	R	Status register	FC3, FC4, FC23
7997	R	Diagnostic status register	FC3, FC4, FC23
7998	R	Diagnostic parameter register	FC3, FC4, FC23
Process data			
8000	R	Input process data	FC1, FC2, FC3, FC4, FC23
9000	R/W	Output process data	FC1, FC2, FC3, FC4, FC5, FC6, FC15, FC16, FC23

R Read
W Write



In write access to the Modbus/TCP clients on the "Read only" register, the data is not transferred and is answered with exception code 02.

13.5 Modbus timeout monitoring (1280)

Modbus monitoring means setting or reading the timeout value for the Modbus connection monitoring.

A timeout value of 0 ms deactivates monitoring.

Enter the time in milliseconds in the range from 200 ms to 65000 ms, converted to hexadecimal.



Connection monitoring with the new timeout values is only activated after a Modbus/TCP function has been executed on the relevant TCP connection.

13.6 Timeout OUT process data monitoring (process data watchdog) (2000)

Timeout OUT process data monitoring means setting or reading the timeout value for the process data watchdog.

Enter the time in milliseconds in the range from 200 ms to 65000 ms, converted to hexadecimal.

A timeout value of 0 ms deactivates the watchdog.

13.7 Fault response mode (2002)

The required fault response mode can be set via web-based management or by writing to Modbus register 2002.

Code (bin)	Code (hex)	Meaning
00	0000	All outputs are set to "0".
01	0001	All outputs are set to "1".
10	0002	All outputs keep their last value.

13.8 Net Fail reason (2002)

The reasons for a Fault Response and a set Net Fail signal can be accessed via web-based management or via the Modbus register 2004.

Code (hex)	Meaning
0001 ... 0006	Reserved
0007	DTI timeout occurred
0008	Host timeout occurred
0009	Set by user.
000A	Connection aborted
000B	Initialization error
000C	Process data watchdog triggered
000D	Modbus timeout occurred

13.9 Command register (2006)

Only set one bit for the command register, otherwise an error message is output. Only write access is enabled for the register.

Bit	Code (hex)	Meaning
0	0001	Reserved
1	0002	Reserved
2	0004	Reserved
3	0008	Reserved
4	0010	Set Net Fail
5	0020	Acknowledge Net Fail
6	0040	Reserved
7	0080	Delete a detected I/O warning/malfunction
8	0100	Reserved
9	0200	Reserved
10	0400	Reserved
11	0800	Reserved
12	1000	Reserved
13	2000	Reserved
14	4000	Reserved
15	8000	Reserved

13.10 Status register (7996)

Bit	Code (hex)	Meaning	
0	0001	1	An error occurred (e.g., a bit in the diagnostic register is set). For additional information, please refer to register 2004.
		0	No error
1	0002	1	A Net Fail occurred, active substitute values. For additional information, please refer to register 2004.
		0	No error
2	0004	Reserved	
3	0008	Reserved	
4	0010	Reserved	
5	0020	Reserved	
6	0040	Reserved	
7	0080	Reserved	
8	0100	Reserved	
9	0200	Reserved	
10	0400	Reserved	
11	0800	Reserved	
12	1000	Reserved	
13	2000	Reserved	
14	4000	Reserved	
15	8000	Reserved	

13.11 Diagnostic status register (7997)

Bit	Code (hex)	Meaning
0	0001	Short circuit or overload of outputs, for additional information please refer to register 7998.
1	0002	Reserved
2	0004	Undervoltage of sensor supply
3	0008	Surge voltage of sensor supply
4	0010	Short circuit or overload of the sensor supply
5	0020	Reserved
6	0040	Reserved
7	0080	Reserved
8	0100	Reserved
9	0200	Reserved
10	0400	Overtemperature of the device
11	0800	Reserved
12	1000	Reserved
13	2000	Reserved
14	4000	Reserved
15	8000	Reserved

13.12 Diagnostic parameter register (7998)

This register sends the fault location (channel number) to where the fault has occurred. The fault location is sent in group format.

Code (hex)	Meaning
0000	A short circuit has not occurred.
0001	Short circuit at one output or several outputs 1 ... 4
0002	Short circuit at one output or several outputs 5 ... 8
0003	Short circuit at one output or several outputs 9 ... 12
0004	Short circuit at one output or several outputs 13 ... 16

13.13 Figure of process data on Modbus registers 8000 and 9000

Process data input word 8000																
Byte	Byte 0								Byte 1							
Bit	7	6	5	4	3	2	1	0	7	6	5	4	3	2	1	0
IN	07	06	05	04	03	02	01	00	17	16	15	14	13	12	11	10
Connection	X04		X03		X02		X01		X08		X07		X06		X05	
Pin	2	4	2	4	2	4	2	4	2	4	2	4	2	4	2	4
DI	8	7	6	5	4	3	2	1	16	15	14	13	12	11	10	9

Key:

- Bit: Process data assignment
- IN: LED marking
- DI: Device input

Process data output word 9000																
Byte	Byte 0								Byte 1							
Bit	7	6	5	4	3	2	1	0	7	6	5	4	3	2	1	0
OUT	07	06	05	04	03	02	01	00	17	16	15	14	13	12	11	10
Connection	X04		X03		X02		X01		X08		X07		X06		X05	
Pin	2	4	2	4	2	4	2	4	2	4	2	4	2	4	2	4
DO	8	7	6	5	4	3	2	1	16	15	14	13	12	11	10	9

Key:

- Bit: Process data assignment
- OUT: LED marking
- DO: Device input

Key:

- Bit: Process data assignment
- OUT: LED marking
- DO: Device input

13.14 Configuration of digital inputs and outputs

A channel, whether an input or an output, is configured by using the IN or OUT process data according to the channel function. Parameterization is not necessary.



If the channel is used as an output, the status of the channel is also mapped to the IN process data. This can be useful, e.g., for diagnostic purposes.
 If the channel is used as an input, the channel cannot simultaneously be used as an output.

14 Startup

14.1 Delivery state/default settings

By default upon delivery, the following functions and features are available:

IP settings

IP parameters:	0.0.0.0
Subnet mask:	0.0.0.0
Default Gateway:	0.0.0.0
BootP:	activated

Process data watchdog

Fault response mode:	Reset fault mode:
Process data watchdog timeout:	0 (deactivated)
Confirmation mode:	Auto

Firmware update

Firmware update on next restart:	deactivated
TFTP server IP address:	192.168.210.211
Firmware file name:	FIRMWARE.NXF

System identification

Device name:	No name assigned
Description:	No description assigned
Device location:	No location assigned
Contact:	No contact assigned

Web-based Management (WBM)

User name:	admin
Password:	private

14.2 Restoring the default settings

There are two options for resetting the default settings:

- Via web-based management, go to the Administration web page > default settings and follow the instructions.
- Via the rotary coding switch, switch position 0F

14.3 Starting the firmware

Once you have connected the power, the firmware is started.

After completion of the firmware boot process, the NET LED either lights up or flashes green.

15 SNMP - Simple Network Management Protocol

The device supports SNMP v1.

Management Information Base - MIB



The corresponding latest MIBs are available on the Internet at phoenixcontact.net/products.

For the object descriptions, please refer to the ASN1 descriptions for this product.

The password for read access is “public” and cannot be changed.

By default upon delivery, the password for write/read access is “private” and can be modified at any time.

16 WBM - Web-based management

The device has a web server, which generates the required pages for web-based management and, depending on the requirements of the user, sends them to a standard web browser. Web-based management can be used to access static information (e.g., technical data, MAC address) or dynamic information (e.g., IP address, status information).

Calling web-based management

The device web server can be addressed using the IP address if configured accordingly. The home page (web page) of the device is accessed by entering the URL “http://ip-address”.

Example: http://172.16.113.38

The default user name is “admin”, the default password is “private”.



If you cannot access the WBM pages, check the connection settings in your browser and deactivate the proxy, if set.

17 Firmware update

In order to update the firmware of the device, the device must be provided with a firmware container via a TFTP server or it must be loaded onto the device via FTP. Any FTP client or TFTP server can be used for this. The update must always be initiated by the web-based management. When carrying out the firmware update, the RDY LED flashes yellow.

18 Quick Connect

The device supports Quick Connect Class A.

After switching on the mains voltage, it is ready to operate in under 350 ms in order to process a connection request.

A cyclic process data connection can be established in under 500 ms.

19 Endianness

The Modbus specification stipulates Big Endian format; words (16-bit) are mapped 1:1.

Individual bytes (modules with a process data width of 1 byte) are mapped to the lower byte (low byte) of a register. In the read direction, the upper byte (high byte) contains 00_{hex} and is ignored in the write direction.

Данный компонент на территории Российской Федерации

Вы можете приобрести в компании MosChip.

Для оперативного оформления запроса Вам необходимо перейти по данной ссылке:

<http://moschip.ru/get-element>

Вы можете разместить у нас заказ для любого Вашего проекта, будь то серийное производство или разработка единичного прибора.

В нашем ассортименте представлены ведущие мировые производители активных и пассивных электронных компонентов.

Нашей специализацией является поставка электронной компонентной базы двойного назначения, продукции таких производителей как XILINX, Intel (ex.ALTERA), Vicor, Microchip, Texas Instruments, Analog Devices, Mini-Circuits, Amphenol, Glenair.

Сотрудничество с глобальными дистрибьюторами электронных компонентов, предоставляет возможность заказывать и получать с международных складов практически любой перечень компонентов в оптимальные для Вас сроки.

На всех этапах разработки и производства наши партнеры могут получить квалифицированную поддержку опытных инженеров.

Система менеджмента качества компании отвечает требованиям в соответствии с ГОСТ Р ИСО 9001, ГОСТ РВ 0015-002 и ЭС РД 009

Офис по работе с юридическими лицами:

105318, г.Москва, ул.Щербаковская д.3, офис 1107, 1118, ДЦ «Щербаковский»

Телефон: +7 495 668-12-70 (многоканальный)

Факс: +7 495 668-12-70 (доб.304)

E-mail: info@moschip.ru

Skype отдела продаж:

moschip.ru

moschip.ru_4

moschip.ru_6

moschip.ru_9