

### Cree® Screen Master® 5-mm Oval LED

**C5SMF-RJF/GJF/BJF**  
**C5SMF-RJE/GJE/BJE**  
**C5SME-RJF/RJE**

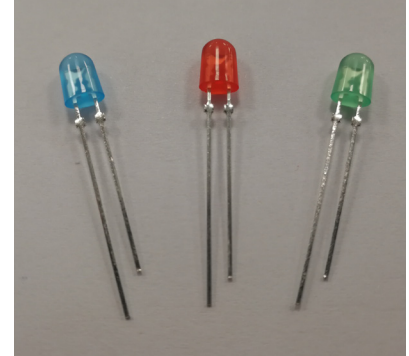

#### PRODUCT DESCRIPTION

The oval LED is specifically designed for variable-message signs and passenger-information signs. The oval-shaped radiation pattern and high luminous intensity ensure that these devices are excellent for wide-field-of-view outdoor applications where a wide viewing angle and readability in sunlight are essential.

These lamps are made with an advanced optical-grade epoxy that offers superior high-temperature and high-moisture-resistance performance in outdoor signal and sign applications. The encapsulation resin contains anti-UV material in order to reduce the effects of long-term exposure to direct sunlight.

#### FEATURES

- Size (mm): 5
- Color and Typical Dominant Wavelength:  
 Red (621nm)  
 Green(527nm)  
 Blue(470nm)
- Luminous Intensity (mcd)  
 C5SMF-RJF/RJE: (1100-4180)  
 C5SMF-GJF/GJE: (2130-8200)  
 C5SMF-BJF/BJE: (550-2130)  
 C5SME-RJF/RJE: (770-2130)
- Lead - Free
- RoHS Compliant

#### APPLICATIONS

- Electronic Signs & Signals (ESS)
- Full Color video screen
- Motorway Signs
- Variable Message Sign (VMS)
- Advertising signs
- Petrol Signs

## ABSOLUTE MAXIMUM RATINGS ( $T_A = 25^\circ\text{C}$ )

| Items   | Symbol    | Absolute Maximum Rating   |                | Unit             |
|---|-----------|---|----------------|------------------|
|   |           | Red   | Blue and Green |                  |
| Forward Current                                       | $I_F$     | 50 <sup>Note1</sup>   | 35             | mA               |
| Peak Forward Current <sup>Note2</sup>                 | $I_{FP}$  | 200   | 100            | mA               |
| Reverse Voltage                                       | $V_R$     | 5   | 5              | V                |
| Power Dissipation                                     | $P_D$     | 130   | 140            | mW               |
| Operation Temperature                                 | $T_{opr}$ | -40 ~ +95   |                | $^\circ\text{C}$ |
| Storage Temperature                                   | $T_{stg}$ | -40 ~ +100  |                | $^\circ\text{C}$ |
| Lead Soldering Temperature                            | $T_{sol}$ | Max. 260 $^\circ\text{C}$ for 3 sec. max.<br>(3 mm from the base of the epoxy bulb) |                |                  |
| Electrostatic Discharge Classification (MIL-STD-883E) | ESD       | Class 2   |                |                  |

### Note:

1. For long term performance the drive currents between 10mA and 30mA are recommended. Please contact CREE sales representative for more information on recommended drive conditions.
2. Pulse width  $\leq 0.1$  msec, duty  $\leq 1/10$ .

## TYPICAL ELECTRICAL & OPTICAL CHARACTERISTICS ( $T_A = 25^\circ\text{C}$ )

| Characteristics     | Color       | Symbol      | Condition     | Unit          | Minimum | Typical | Maximum |
|---------------------|-------------|-------------|---------------|---------------|---------|---------|---------|
| Forward Voltage     | Red         | $V_F$       | $I_F = 20$ mA | V             |         | 2.1     | 2.6     |
|                     | Blue/Green  | $V_F$       | $I_F = 20$ mA | V             |         | 3.4     | 4.0     |
| Reverse Current     | Red         | $I_R$       | $V_R = 5$ V   | $\mu\text{A}$ |         |         | 100     |
|                     | Blue/Green  | $I_R$       | $V_R = 5$ V   | $\mu\text{A}$ |         |         | 100     |
| Dominant Wavelength | Red         | $\lambda_D$ | $I_F = 20$ mA | nm            | 619     | 621     | 624     |
|                     | Green       | $\lambda_D$ | $I_F = 20$ mA | nm            | 520     | 527     | 535     |
|                     | Blue        | $\lambda_D$ | $I_F = 20$ mA | nm            | 460     | 470     | 475     |
| Luminous Intensity  | C5SMF - Red | $I_V$       | $I_F = 20$ mA | mcd           | 1100    | 2200    |         |
|                     | C5SME - Red | $I_V$       | $I_F = 20$ mA | mcd           | 770     | 1100    |         |
|                     | Green       | $I_V$       | $I_F = 20$ mA | mcd           | 2130    | 4400    |         |
|                     | Blue        | $I_V$       | $I_F = 20$ mA | mcd           | 550     | 1100    |         |

**Note:** Continuous reverse voltage can cause LED damage.

## INTENSITY BIN LIMIT ( $I_F = 20 \text{ mA}$ )

Red: C5SMF

| Bin Code | Sub-bin | Min. (mcd) | Max. (mcd) |
|----------|---------|------------|------------|
| T0       | T1      | 1100       | 1205       |
|          | T2      | 1205       | 1310       |
|          | T3      | 1310       | 1415       |
|          | T4      | 1415       | 1520       |
| U0       | U1      | 1520       | 1672       |
|          | U2      | 1672       | 1824       |
|          | U3      | 1824       | 1976       |
|          | U4      | 1976       | 2130       |
| V0       | V1      | 2130       | 2347       |
|          | V2      | 2347       | 2564       |
|          | V3      | 2564       | 2781       |
|          | V4      | 2781       | 3000       |
| W0       | W1      | 3000       | 3295       |
|          | W2      | 3295       | 3590       |
|          | W3      | 3590       | 3885       |
|          | W4      | 3885       | 4180       |

Green: C5SMF

| Bin Code | Sub-bin | Min. (mcd) | Max. (mcd) |
|----------|---------|------------|------------|
| V0       | V1      | 2130       | 2347       |
|          | V2      | 2347       | 2564       |
|          | V3      | 2564       | 2781       |
|          | V4      | 2781       | 3000       |
| W0       | W1      | 3000       | 3295       |
|          | W2      | 3295       | 3590       |
|          | W3      | 3590       | 3885       |
|          | W4      | 3885       | 4180       |
| X0       | X1      | 4180       | 4600       |
|          | X2      | 4600       | 5020       |
|          | X3      | 5020       | 5440       |
|          | X4      | 5440       | 5860       |
| Y0       | Y1      | 5860       | 6445       |
|          | Y2      | 6445       | 7030       |
|          | Y3      | 7030       | 7615       |
|          | Y4      | 7615       | 8200       |

Blue: C5SMF

| Bin Code | Sub-bin | Min. (mcd) | Max. (mcd) |
|----------|---------|------------|------------|
| R0       | R1      | 550        | 605        |
|          | R2      | 605        | 660        |
|          | R3      | 660        | 715        |
|          | R4      | 715        | 770        |
| S0       | S1      | 770        | 852        |
|          | S2      | 852        | 934        |
|          | S3      | 934        | 1017       |
|          | S4      | 1017       | 1100       |
| T0       | T1      | 1100       | 1205       |
|          | T2      | 1205       | 1310       |
|          | T3      | 1310       | 1415       |
|          | T4      | 1415       | 1520       |
| U0       | U1      | 1520       | 1672       |
|          | U2      | 1672       | 1824       |
|          | U3      | 1824       | 1976       |
|          | U4      | 1976       | 2130       |

Red: C5SME

| Bin Code | Sub-bin | Min. (mcd) | Max. (mcd) |
|----------|---------|------------|------------|
| S0       | S1      | 770        | 852        |
|          | S2      | 852        | 934        |
|          | S3      | 934        | 1017       |
|          | S4      | 1017       | 1100       |
| T0       | T1      | 1100       | 1205       |
|          | T2      | 1205       | 1310       |
|          | T3      | 1310       | 1415       |
|          | T4      | 1415       | 1520       |
| U0       | U1      | 1520       | 1672       |
|          | U2      | 1672       | 1824       |
|          | U3      | 1824       | 1976       |
|          | U4      | 1976       | 2130       |

- Tolerance of measurement of luminous intensity is  $\pm 15\%$

## COLOR BIN LIMIT ( $I_F = 20 \text{ mA}$ )

Red

| Bin Code | Min.(nm) | Max.(nm) |
|----------|----------|----------|
| RB       | 619      | 624      |

Green

| Bin Code | Min.(nm) | Max.(nm) |
|----------|----------|----------|
| G7       | 520      | 525      |
| G8       | 525      | 530      |
| G9       | 530      | 535      |

Blue

| Bin Code | Min.(nm) | Max.(nm) |
|----------|----------|----------|
| B3       | 460      | 465      |
| B4       | 465      | 470      |
| B5       | 470      | 475      |

- Tolerance of measurement of dominant wavelength is  $\pm 1 \text{ nm}$

## ORDER CODE TABLE\*

### C5SMF

| Color | Kit Number         | Luminous Intensity (mcd)                          |      | Dominant Wavelength |           |           |           | Package | Standoff |
|-------|--------------------|---|------|---------------------|-----------|-----------|-----------|---------|----------|
|       |                    | Min.  | Max. | Color Bin           | Min. (nm) | Color Bin | Max. (nm) |         |          |
| Red   | C5SMF-RJF-CT0W0BB1 | 1100  | 4180 | RB                  | 619       | RB        | 624       | Bulk    | Yes      |
| Red   | C5SMF-RJF-CT14QBB1 | Any 4 consecutive sub-bins: T1 (1100) - U2 (1824) |      | RB                  | 619       | RB        | 624       | Bulk    | Yes      |
| Red   | C5SMF-RJF-CT34QBB1 | Any 4 consecutive sub-bins: T3 (1310) - U4 (2130) |      | RB                  | 619       | RB        | 624       | Bulk    | Yes      |
| Red   | C5SMF-RJF-CU14QBB1 | Any 4 consecutive sub-bins: U1 (1520) - V2 (2564) |      | RB                  | 619       | RB        | 624       | Bulk    | Yes      |
| Red   | C5SMF-RJE-CT0W0BB1 | 1100  | 4180 | RB                  | 619       | RB        | 624       | Bulk    | No       |
| Red   | C5SMF-RJE-CT14QBB1 | Any 4 consecutive sub-bins: T1 (1100) - U2 (1824) |      | RB                  | 619       | RB        | 624       | Bulk    | No       |
| Red   | C5SMF-RJE-CT34QBB1 | Any 4 consecutive sub-bins: T3 (1310) - U4 (2130) |      | RB                  | 619       | RB        | 624       | Bulk    | No       |
| Red   | C5SMF-RJE-CU14QBB1 | Any 4 consecutive sub-bins: U1 (1520) - V2 (2564) |      | RB                  | 619       | RB        | 624       | Bulk    | No       |
| Red   | C5SMF-RJF-CT0W0BB2 | 1100  | 4180 | RB                  | 619       | RB        | 624       | Ammo    | Yes      |
| Red   | C5SMF-RJF-CT14QBB2 | Any 4 consecutive sub-bins: T1 (1100) - U2 (1824) |      | RB                  | 619       | RB        | 624       | Ammo    | Yes      |
| Red   | C5SMF-RJF-CT34QBB2 | Any 4 consecutive sub-bins: T3 (1310) - U4 (2130) |      | RB                  | 619       | RB        | 624       | Ammo    | Yes      |
| Red   | C5SMF-RJF-CU14QBB2 | Any 4 consecutive sub-bins: U1 (1520) - V2 (2564) |      | RB                  | 619       | RB        | 624       | Ammo    | Yes      |
| Red   | C5SMF-RJE-CT0W0BB2 | 1100  | 4180 | RB                  | 619       | RB        | 624       | Ammo    | No       |
| Red   | C5SMF-RJE-CT14QBB2 | Any 4 consecutive sub-bins: T1 (1100) - U2 (1824) |      | RB                  | 619       | RB        | 624       | Ammo    | No       |
| Red   | C5SMF-RJE-CT34QBB2 | Any 4 consecutive sub-bins: T3 (1310) - U4 (2130) |      | RB                  | 619       | RB        | 624       | Ammo    | No       |
| Red   | C5SMF-RJE-CU14QBB2 | Any 4 consecutive sub-bins: U1 (1520) - V2 (2564) |      | RB                  | 619       | RB        | 624       | Ammo    | No       |

## ORDER CODE TABLE\*

### C5SMF

| Color | Kit Number         | Luminous Intensity (mcd)                          |      | Dominant Wavelength                             |           |           |           | Package | Standoff |
|-------|--------------------|---|------|---|-----------|-----------|-----------|---------|----------|
|       |                    | Min.  | Max. | Color Bin                                       | Min. (nm) | Color Bin | Max. (nm) |         |          |
| Green | C5SMF-GJF-CV0Y0791 | 2130  | 8200 | G7  | 520       | G9        | 535       | Bulk    | Yes      |
| Green | C5SMF-GJF-CW34Q7T1 | Any 4 consecutive sub-bins: W3 (3590) - X4 (5860) |      | Any 1 color bin from G7 (520 nm) to G8 (530 nm) |           |           |           | Bulk    | Yes      |
| Green | C5SMF-GJF-CX14Q7T1 | Any 4 consecutive sub-bins: X1 (4180) - Y2 (7030) |      | Any 1 color bin from G7 (520 nm) to G8 (530 nm) |           |           |           | Bulk    | Yes      |
| Green | C5SMF-GJE-CV0Y0791 | 2130  | 8200 | G7  | 520       | G9        | 535       | Bulk    | No       |
| Green | C5SMF-GJE-CW34Q7T1 | Any 4 consecutive sub-bins: W3 (3590) - X4 (5860) |      | Any 1 color bin from G7 (520 nm) to G8 (530 nm) |           |           |           | Bulk    | No       |
| Green | C5SMF-GJE-CX14Q7T1 | Any 4 consecutive sub-bins: X1 (4180) - Y2 (7030) |      | Any 1 color bin from G7 (520 nm) to G8 (530 nm) |           |           |           | Bulk    | No       |
| Green | C5SMF-GJF-CV0Y0792 | 2130  | 8200 | G7  | 520       | G9        | 535       | Ammo    | Yes      |
| Green | C5SMF-GJF-CW34Q7T2 | Any 4 consecutive sub-bins: W3 (3590) - X4 (5860) |      | Any 1 color bin from G7 (520 nm) to G8 (530 nm) |           |           |           | Ammo    | Yes      |
| Green | C5SMF-GJF-CX14Q7T2 | Any 4 consecutive sub-bins: X1 (4180) - Y2 (7030) |      | Any 1 color bin from G7 (520 nm) to G8 (530 nm) |           |           |           | Ammo    | Yes      |
| Green | C5SMF-GJE-CV0Y0792 | 2130  | 8200 | G7  | 520       | G9        | 535       | Ammo    | No       |
| Green | C5SMF-GJE-CW34Q7T2 | Any 4 consecutive sub-bins: W3 (3590) - X4 (5860) |      | Any 1 color bin from G7 (520 nm) to G8 (530 nm) |           |           |           | Ammo    | No       |
| Green | C5SMF-GJE-CX14Q7T2 | Any 4 consecutive sub-bins: X1 (4180) - Y2 (7030) |      | Any 1 color bin from G7 (520 nm) to G8 (530 nm) |           |           |           | Ammo    | No       |

## ORDER CODE TABLE\*

### C5SMF

| Color | Kit Number         | Luminous Intensity (mcd)                             |      | Dominant Wavelength                             |          |           |           | Package | Standoff |
|-------|--------------------|--|------|---|----------|-----------|-----------|---------|----------|
|       |                    | Min.   | Max. | Color Bin                                       | Min.(nm) | Color Bin | Max. (nm) |         |          |
| Blue  | C5SMF-BJF-CR0U0351 | 550  | 2130 | B3  | 460      | B5        | 475       | Bulk    | Yes      |
| Blue  | C5SMF-BJF-CR0U0451 | 550  | 2130 | B4  | 465      | B5        | 475       | Bulk    | Yes      |
| Blue  | C5SMF-BJF-CT14Q3T1 | Any 4 consecutive sub-bins:<br>T1 (1100) - U2 (1824) |      | Any 1 color bin from B3 (460 nm) to B4 (470 nm) |          |           |           | Bulk    | Yes      |
| Blue  | C5SMF-BJF-CT14Q4T1 | Any 4 consecutive sub-bins:<br>T1 (1100) - U2 (1824) |      | Any 1 color bin from B4 (465 nm) to B5 (475 nm) |          |           |           | Bulk    | Yes      |
| Blue  | C5SMF-BJF-CT34Q3T1 | Any 4 consecutive sub-bins:<br>T3 (1310) - U4 (2130) |      | Any 1 color bin from B3 (460 nm) to B4 (470 nm) |          |           |           | Bulk    | Yes      |
| Blue  | C5SMF-BJF-CT34Q4T1 | Any 4 consecutive sub-bins:<br>T3 (1310) - U4 (2130) |      | Any 1 color bin from B4 (465 nm) to B5 (475 nm) |          |           |           | Bulk    | Yes      |
| Blue  | C5SMF-BJE-CR0U0351 | 550  | 2130 | B3  | 460      | B5        | 475       | Bulk    | No       |
| Blue  | C5SMF-BJE-CR0U0451 | 550  | 2130 | B4  | 465      | B5        | 475       | Bulk    | No       |
| Blue  | C5SMF-BJE-CT14Q3T1 | Any 4 consecutive sub-bins:<br>T1 (1100) - U2 (1824) |      | Any 1 color bin from B3 (460 nm) to B4 (470 nm) |          |           |           | Bulk    | No       |
| Blue  | C5SMF-BJE-CT14Q4T1 | Any 4 consecutive sub-bins:<br>T1 (1100) - U2 (1824) |      | Any 1 color bin from B4 (465 nm) to B5 (475 nm) |          |           |           | Bulk    | No       |
| Blue  | C5SMF-BJE-CT34Q3T1 | Any 4 consecutive sub-bins:<br>T3 (1310) - U4 (2130) |      | Any 1 color bin from B3 (460 nm) to B4 (470 nm) |          |           |           | Bulk    | No       |
| Blue  | C5SMF-BJE-CT34Q4T1 | Any 4 consecutive sub-bins:<br>T3 (1310) - U4 (2130) |      | Any 1 color bin from B4 (465 nm) to B5 (475 nm) |          |           |           | Bulk    | No       |
| Blue  | C5SMF-BJF-CR0U0352 | 550  | 2130 | B3  | 460      | B5        | 475       | Ammo    | Yes      |
| Blue  | C5SMF-BJF-CR0U0452 | 550  | 2130 | B4  | 465      | B5        | 475       | Ammo    | Yes      |
| Blue  | C5SMF-BJF-CT14Q3T2 | Any 4 consecutive sub-bins:<br>T1 (1100) - U2 (1824) |      | Any 1 color bin from B3 (460 nm) to B4 (470 nm) |          |           |           | Ammo    | Yes      |
| Blue  | C5SMF-BJF-CT14Q4T2 | Any 4 consecutive sub-bins:<br>T1 (1100) - U2 (1824) |      | Any 1 color bin from B4 (465 nm) to B5 (475 nm) |          |           |           | Ammo    | Yes      |
| Blue  | C5SMF-BJF-CT34Q3T2 | Any 4 consecutive sub-bins:<br>T3 (1310) - U4 (2130) |      | Any 1 color bin from B3 (460 nm) to B4 (470 nm) |          |           |           | Ammo    | Yes      |
| Blue  | C5SMF-BJF-CT34Q4T2 | Any 4 consecutive sub-bins:<br>T3 (1310) - U4 (2130) |      | Any 1 color bin from B4 (465 nm) to B5 (475 nm) |          |           |           | Ammo    | Yes      |
| Blue  | C5SMF-BJE-CR0U0352 | 550  | 2130 | B3  | 460      | B5        | 475       | Ammo    | No       |
| Blue  | C5SMF-BJE-CR0U0452 | 550  | 2130 | B4  | 465      | B5        | 475       | Ammo    | No       |
| Blue  | C5SMF-BJE-CT14Q3T2 | Any 4 consecutive sub-bins:<br>T1 (1100) - U2 (1824) |      | Any 1 color bin from B3 (460 nm) to B4 (470 nm) |          |           |           | Ammo    | No       |
| Blue  | C5SMF-BJE-CT14Q4T2 | Any 4 consecutive sub-bins:<br>T1 (1100) - U2 (1824) |      | Any 1 color bin from B4 (465 nm) to B5 (475 nm) |          |           |           | Ammo    | No       |
| Blue  | C5SMF-BJE-CT34Q3T2 | Any 4 consecutive sub-bins:<br>T3 (1310) - U4 (2130) |      | Any 1 color bin from B3 (460 nm) to B4 (470 nm) |          |           |           | Ammo    | No       |
| Blue  | C5SMF-BJE-CT34Q4T2 | Any 4 consecutive sub-bins:<br>T3 (1310) - U4 (2130) |      | Any 1 color bin from B4 (465 nm) to B5 (475 nm) |          |           |           | Ammo    | No       |

## ORDER CODE TABLE\*

### C5SME

| Color | Kit Number         | Luminous Intensity (mcd)                             |      | Dominant Wavelength |          |           |          | Package | Standoff |
|-------|--------------------|--|------|---------------------|----------|-----------|----------|---------|----------|
|       |                    | Min.   | Max. | Color Bin           | Min.(nm) | Color Bin | Max.(nm) |         |          |
| Red   | C5SME-RJF-CS0U0BB1 | 770  | 2130 | RB                  | 619      | RB        | 624      | Bulk    | Yes      |
| Red   | C5SME-RJF-CS34QBB1 | Any 4 consecutive sub-bins:<br>S3 (934) - T4 (1520)  |      | RB                  | 619      | RB        | 624      | Bulk    | Yes      |
| Red   | C5SME-RJF-CT14QBB1 | Any 4 consecutive sub-bins:<br>T1 (1100) - U2 (1824) |      | RB                  | 619      | RB        | 624      | Bulk    | Yes      |
| Red   | C5SME-RJE-CS0U0BB1 | 770  | 2130 | RB                  | 619      | RB        | 624      | Bulk    | No       |
| Red   | C5SME-RJE-CS34QBB1 | Any 4 consecutive sub-bins:<br>S3 (934) - T4 (1520)  |      | RB                  | 619      | RB        | 624      | Bulk    | No       |
| Red   | C5SME-RJE-CT14QBB1 | Any 4 consecutive sub-bins:<br>T1 (1100) - U2 (1824) |      | RB                  | 619      | RB        | 624      | Bulk    | No       |
| Red   | C5SME-RJF-CS0U0BB2 | 770  | 2130 | RB                  | 619      | RB        | 624      | Ammo    | Yes      |
| Red   | C5SME-RJF-CS34QBB2 | Any 4 consecutive sub-bins:<br>S3 (934) - T4 (1520)  |      | RB                  | 619      | RB        | 624      | Ammo    | Yes      |
| Red   | C5SME-RJF-CT14QBB2 | Any 4 consecutive sub-bins:<br>T1 (1100) - U2 (1824) |      | RB                  | 619      | RB        | 624      | Ammo    | Yes      |
| Red   | C5SME-RJE-CS0U0BB2 | 770  | 2130 | RB                  | 619      | RB        | 624      | Ammo    | No       |
| Red   | C5SME-RJE-CS34QBB2 | Any 4 consecutive sub-bins:<br>S3 (934) - T4 (1520)  |      | RB                  | 619      | RB        | 624      | Ammo    | No       |
| Red   | C5SME-RJE-CT14QBB2 | Any 4 consecutive sub-bins:<br>T1 (1100) - U2 (1824) |      | RB                  | 619      | RB        | 624      | Ammo    | No       |

#### Notes:

1. The above kit numbers represent order codes that include multiple intensity-bin and color-bin codes. Only one intensity-sub-bin code and one color-bin code will be shipped on each reel. Selected single intensity-bin, single color-bin codes will be orderable in certain quantities. For example, any four consecutive sub-bins from V1 to W2 mean only one intensity bin with four sub-bins of the following brightness ranges (V1-V4, V2-W1, V3-W2) will be shipped by Cree. For example, any one-color bin from G7 to G9 means only one color bin (G7 or G8 or G9) will be shipped by Cree.
2. Please refer to the "Cree LED Lamp Reliability Test Standards" document #1 for reliability test conditions.
3. Please refer to the "Cree LED Lamp Soldering & Handling" document #2 for information about how to use this LED product safely.

#1: Refer to [http://www.cree.com/led-components/media/documents/LED\\_Lamp\\_Reliability\\_Test\\_Standard.pdf](http://www.cree.com/led-components/media/documents/LED_Lamp_Reliability_Test_Standard.pdf)

#2: Refer to <http://www.cree.com/led-components/media/documents/sh-HB.pdf>

## GRAPHS

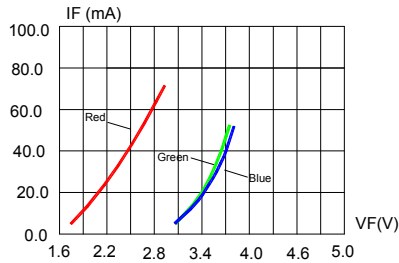

FIG.1 FORWARD CURRENT VS. FORWARD VOLTAGE.

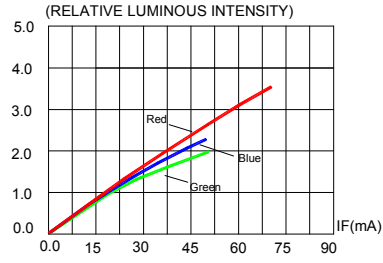

FIG.2 RELATIVE LUMINOUS INTENSITY VS. FORWARD CURRENT

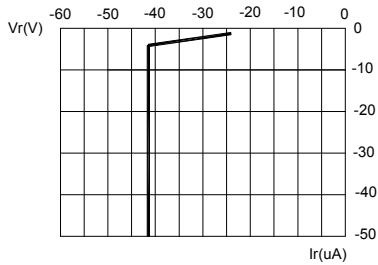

FIG.3a RED REVERSE CURRENT VS. REVERSE VOLTAGE.

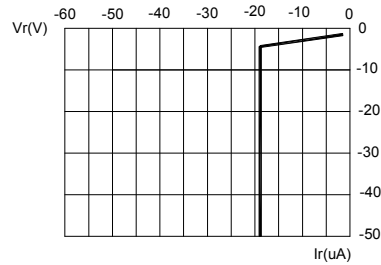

FIG.3b BLUE & GREEN REVERSE CURRENT VS. REVERSE VOLTAGE.

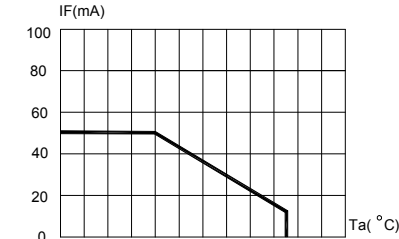

FIG.4a RED MAXIMUM FORWARD DC CURRENT VS AMBIENT TEMPERATURE ( $T_{jmax}=105^{\circ}C$ )

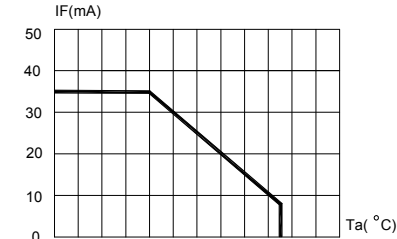

FIG.4b BLUE & GREEN MAXIMUM FORWARD DC CURRENT VS AMBIENT TEMPERATURE ( $T_{jmax}=105^{\circ}C$ )

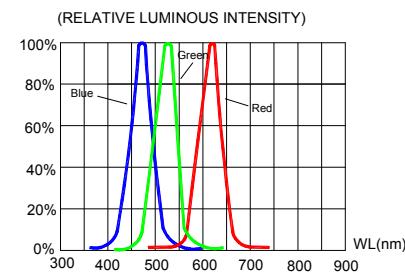

FIG.5 RELATIVE LUMINOUS INTENSITY VS. WAVELENGTH.

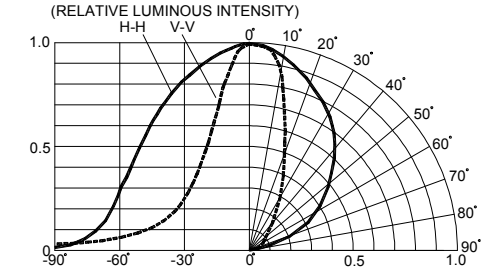

FIG.6 RED & BLUE&GREEN FAR FIELD PATTERN

The above data are collected from statistical figures that do not necessarily correspond to the actual parameters of each single LED. Hence, these data will be changed without further notice.



## MECHANICAL DIMENSIONS

All dimensions are in mm. Tolerance is  $\pm 0.25$  mm unless otherwise noted.

An epoxy meniscus may extend about 1.5 mm down the leads.

Burr around bottom of epoxy may be 0.5 mm max.

C5SMF-RJF/GJF/BJF&C5SME-RJF:

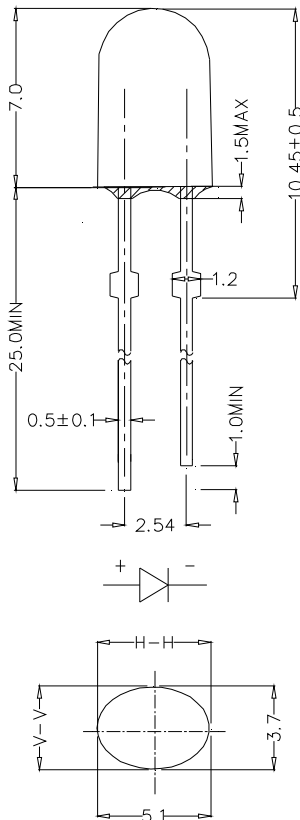

C5SMF-RJE/GJE/BJE&C5SME-RJE:

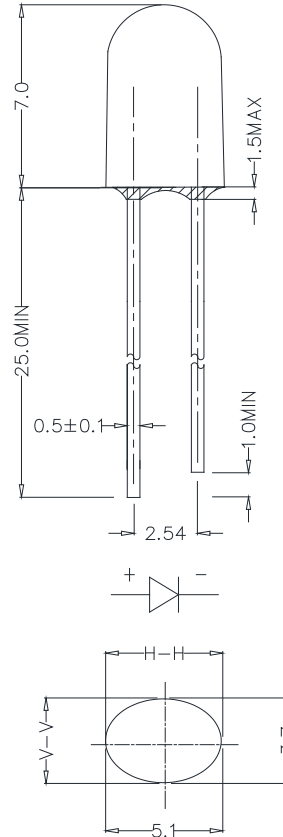

## NOTES

### Lead Frame Materials

Ag-plated and Lead-free Solder-plated iron.

### RoHS Compliance

The levels of RoHS-restricted materials in this product are below the maximum concentration values (also referred to as the threshold limits) permitted for such substances, or are used in an exempted application in accordance with EU Directive 2011/65/EC (RoHS2), as implemented by EU member states on January 2, 2013 and amended on March 31, 2015 by EU Directive 2015/863/EU.

RoHS Declarations for this product can be obtained from your Cree representative or from the Product Ecology section of the Cree website.

### Vision Advisory Claim

Users should be cautioned not to stare at the light of this LED product. The bright light can damage the eye.

## KIT NUMBER SYSTEM

All dimensions in mm. Cree LED lamps are tested and sorted into performance bins. A bin is specified by ranges of color, forward voltage, and brightness. Sorted LEDs are packaged for shipping in various convenient options. Please refer to the "Cree LED Lamp Packaging Standard" document for more information about shipping and packaging options.

Cree LEDs are sold by order codes in combinations of bins called kits. Order codes are configured in the following manner:

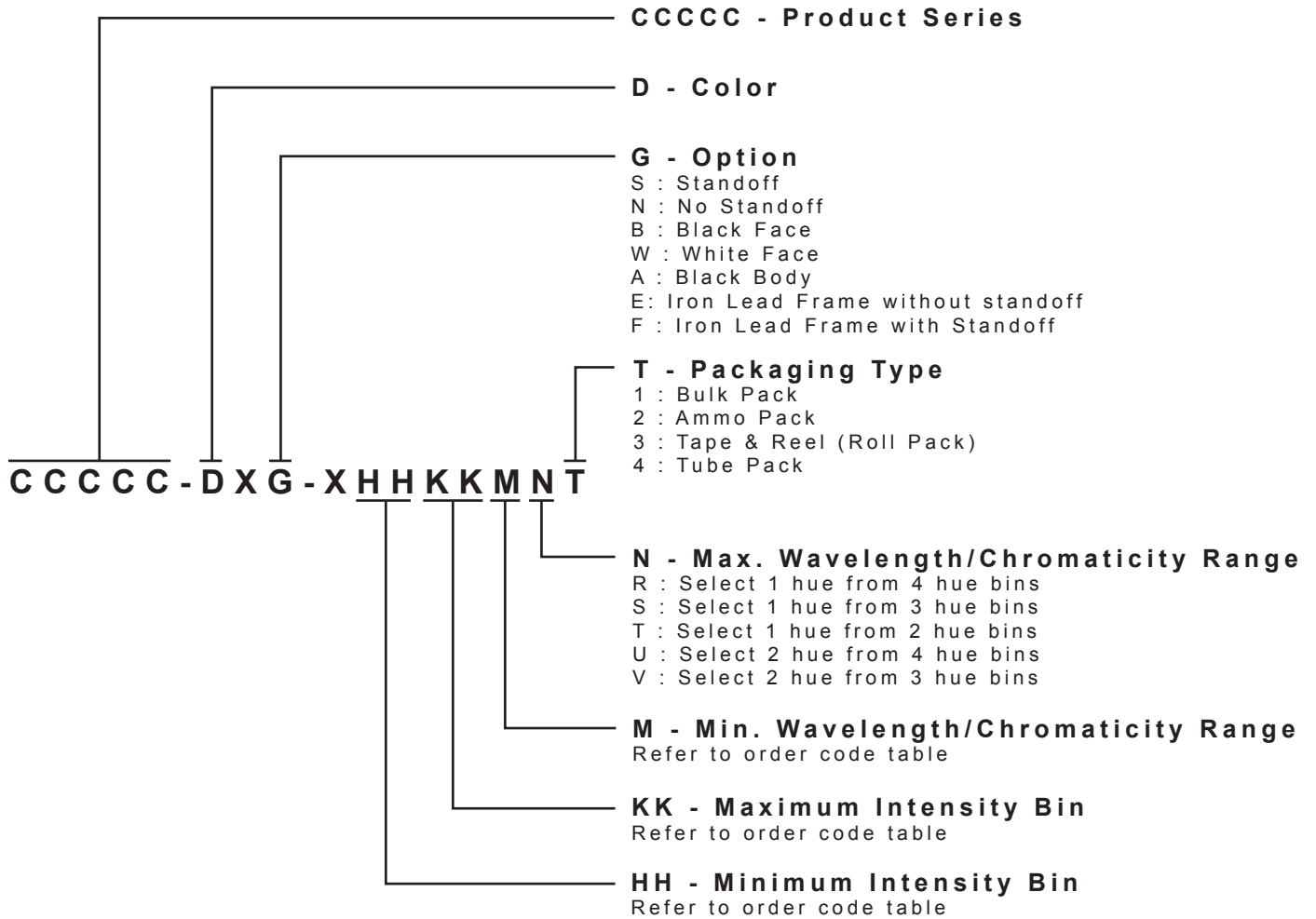

\* Please contact our sales representative for ordering information.

## REFLOW SOLDERING

The LED soldering specification is shown below (suitable for both leaded solder & lead-free solder):

| Manual Soldering |  | Solder Dipping          |  |
|------------------|--|-------------------------|--|
| Soldering iron   | 35 W max   | Preheat                 | 110 °C max                                       |
| Temperature      | 300 °C max                                       | Preheat time            | 60 seconds max                                   |
|                  |  | Solder-bath temperature | 260 °C Max                                       |
| Soldering time   | 3 seconds max                                    | Dipping time            | 5 seconds max                                    |
| Position         | Not less than 3 mm from the base of the package. | Position                | Not less than 3 mm from the base of the package. |

- Manual soldering onto the PCB is not recommended because soldering time is uncontrollable.
- The recommended wave soldering is as below:

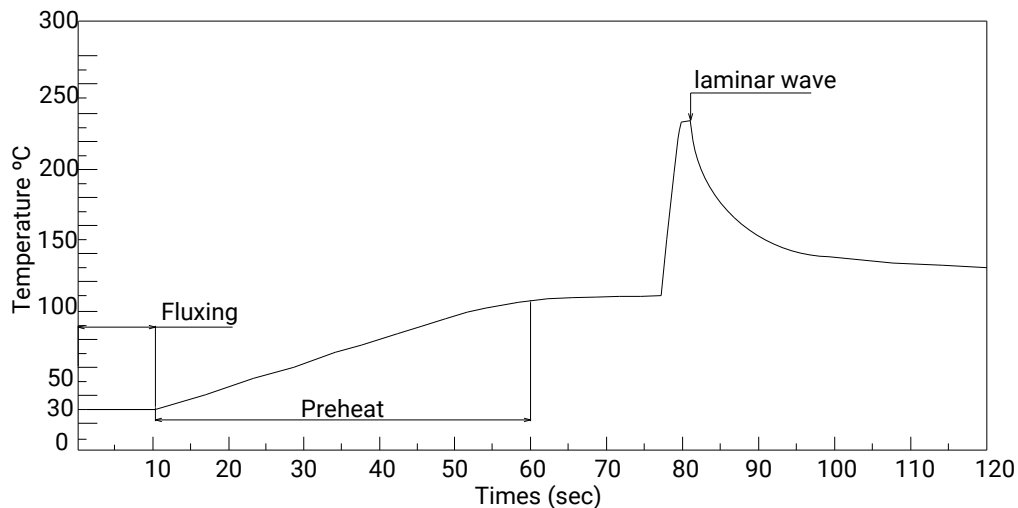

- Do not apply any stress to the LED package, particularly when heated.
- Only bottom preheat is suggested & should not preheat on top in order to reduce thermal stress experienced by the LEDs.
- The LEDs must not be re used once they have been extracted from PCB.
- After soldering the LEDs, the package should be protected from mechanical shock or vibration until the LEDs have reached 40 °C or below.
- Precautions must be taken as mechanical stress on the LEDs may be caused by PCB warpage or from the clinching and cutting of the LED leads.
- When it is necessary to clamp the LEDs during soldering, it is important to ensure no mechanical stress is exerted on the LEDs.
- Cut the LED lead at normal room temperature. Lead cutting at high temperature may cause failure of the LEDs.

Refer to "<http://www.cree.com/led-components/media/documents/sh-HB.pdf>" for soldering & handling details.

## PACKAGING

### Features:

- The LEDs are packed in cardboard boxes after packaging in normal or anti-electrostatic bags.
- Cardboard boxes will be used to protect the LEDs from mechanical shock during transportation.
- The boxes are not water resistant, and they must be kept away from water and moisture.
- The Bulk Pack types of packaging.
- Max 500 pcs per bulk and Max 2500 pcs per ammo.

### Bulk Pack Packaging Type:

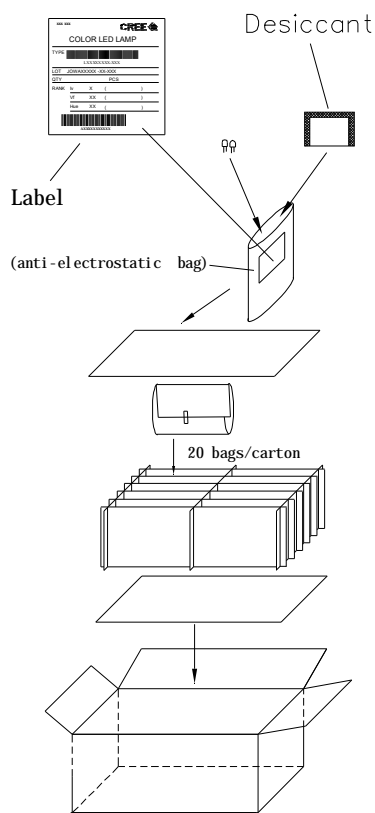

### Ammo Pack Packaging Type:

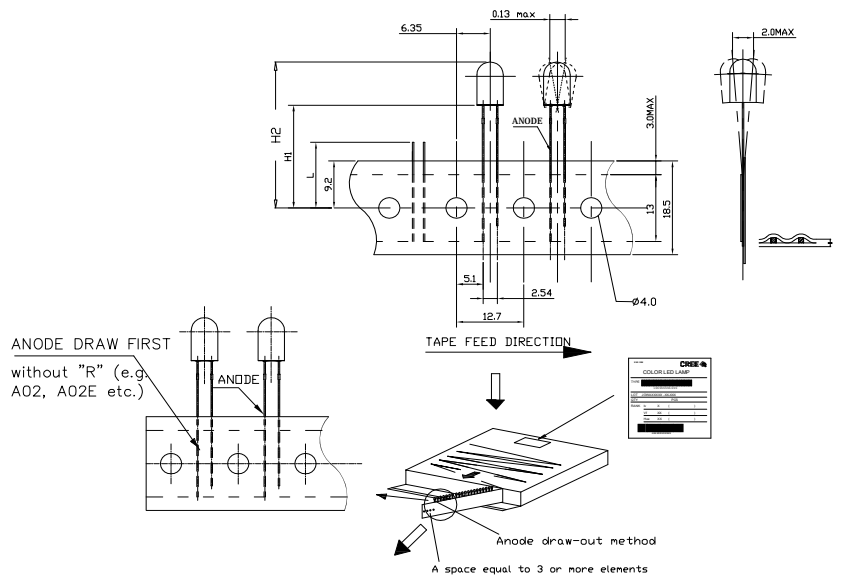

## Данный компонент на территории Российской Федерации

### Вы можете приобрести в компании MosChip.

Для оперативного оформления запроса Вам необходимо перейти по данной ссылке:

<http://moschip.ru/get-element>

Вы можете разместить у нас заказ для любого Вашего проекта, будь то серийное производство или разработка единичного прибора.

В нашем ассортименте представлены ведущие мировые производители активных и пассивных электронных компонентов.

Нашей специализацией является поставка электронной компонентной базы двойного назначения, продукции таких производителей как XILINX, Intel (ex.ALTERA), Vicor, Microchip, Texas Instruments, Analog Devices, Mini-Circuits, Amphenol, Glenair.

Сотрудничество с глобальными дистрибьюторами электронных компонентов, предоставляет возможность заказывать и получать с международных складов практически любой перечень компонентов в оптимальные для Вас сроки.

На всех этапах разработки и производства наши партнеры могут получить квалифицированную поддержку опытных инженеров.

Система менеджмента качества компании отвечает требованиям в соответствии с ГОСТ Р ИСО 9001, ГОСТ РВ 0015-002 и ЭС РД 009

### Офис по работе с юридическими лицами:

105318, г.Москва, ул.Щербаковская д.3, офис 1107, 1118, ДЦ «Щербаковский»

Телефон: +7 495 668-12-70 (многоканальный)

Факс: +7 495 668-12-70 (доб.304)

E-mail: [info@moschip.ru](mailto:info@moschip.ru)

Skype отдела продаж:

moschip.ru

moschip.ru\_4

moschip.ru\_6

moschip.ru\_9